

# GOLF/JETTA 85-92

This page is just a sample of our complete  
Golf®/Jetta® '85-92 Parts  
on Pages  
P-108 to P-129

Front Cover Section



So you want to get to know your A-2 Golf® or Jetta® better? Are you sick of paying hundreds of dollars in labor for repairs? Well, throw away your Chilton manual and BUY A BENTLEY MANUAL. In the Bentley manual you are treated like you are the mechanic. Repairs and procedures are explained to you in easy-to-understand language. Some manuals refer you to the dealer when the going gets tough, and the procedure is difficult--NOT THE BENTLEY! They cost a little more, but will pay you back time and time again in saved labor costs. They are a great addition to every VW® owner's toolbox.

'85-92

#SN01084 (928 pgs./1000 illus./388 elec. illus. 42.<sup>95</sup>

## GOLFS® AND JETTAS® ARE OUR SPECIALTY!

We sell EVERY! part needed  
to keep them looking  
and running their best!



## Driveshafts

We have made a special purchase of *Brand New Driveshafts!* (left only) made in Germany by LOBRO! These driveshafts have 90mm CVs and fit '85-'87 Golf®, Jetta® gas (not GTI®, GLI®) also '85-'92 Golf® and Jetta® Diesels.

#SN09239..... exchange \$ ~~149.<sup>95</sup>~~ Now only **119.<sup>95</sup>**

Also C.V. Joints from 39.<sup>95</sup>

**PRICE REDUCED!**  
**\$160.00**

The Golf® and Jetta® from 1985-92 (or A-2 chassis if you prefer) were the most popular non-Beetle® Volkswagen's® ever! These years include GTI®, GLI®, GT, 16V, and also Standard and GL, gas or diesel-powered vehicles. Golfs® and Jettas® were available in two and four door versions. As cars have become more well equipped so have Volkswagens®. Sunroofs, air-conditioning, automatic transmissions and power accessories were factory installed on many of these vehicles!



## ARMOR Door Plates

We are now carrying ARMOR door plates. not only offering theft protection, these plates provide a durable, aesthetically pleasing finish. The plates follow the curvature of the door and have a neoprene gasket to provide a watertight fit. Available only in black, sold in pairs.

Golf®, Jetta® and Scirocco® '77-92

#SN14477 pair ..... \$69.<sup>95</sup>

Golf®, Jetta® '93-99.5

#SN14478 pair ..... 69.<sup>95</sup>

HIDES RUST, TOO!!!

# GOLF/JETTA III '93-99.5



## Golf®/Jetta III® Service Manual

Bentley is by far the best service manual you can buy to become a successful and thrifty "do-it-yourself" mechanic. See description above under Golf®/Jetta® Service manual. An essential addition to your VW® toolbox!

#SN13567 ..... \$59.<sup>95</sup>

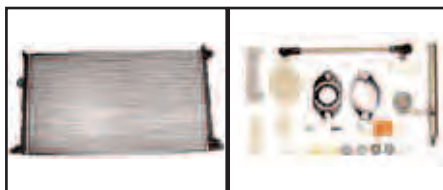

## Golf®/Jetta III® Parts

DEALER US

Brake Cable: Golf®/Jetta III® w/rear drum brake '93-94  
#SN13610 ..... \$17.<sup>10</sup> \$14.<sup>95</sup>

Radiator, Golf®/Jetta 4 cyl '94-99.5  
#SN13099 ..... 227.<sup>77</sup> 119.<sup>95</sup>

Door handle, Front, all '93-99.5  
#SN16507 ..... 43.<sup>85</sup> 29.<sup>95</sup>

Door Latches ..... CALL

Rear Wiper Arm, Golf '93-99.5  
#SN15549 ..... 39.<sup>48</sup> 24.<sup>95</sup>

Complete Shifter Repair Kit, all Golf®/Jetta/Cabrio 2.0, 5 speed  
#SN18745 ..... 69.<sup>95</sup>

You didn't think we'd leave you A-3 Golf®/Jetta® owners hangin', did ya? We've got all kinds of parts, new and used, for these cars. So when your warranty runs out and stuff starts breakin', remember that we're here for you to solve your car repair problems and save you money.

**New at  
PartsPlace!!**



VW® uses special stuff and the stuff they use today is better than what was available in '65, '75 or '85. VW® also

recomends GL-4 singles grade *NOT* GL 3-4-5. WARNING!! The leading VW® trasmission rebuildler says you void your warrantee if you use GL 3-4-5. ?? Is he trying to clue you in on something????

#SN15349 '60-84 (man. trans.) .. \$11.<sup>95</sup>  
#SN15350 '85-04 (man. trans.) .. 11.<sup>95</sup>



Filter Kit (includes Air, Oil and Fuel filters, plus Cabrio filters)

All Golf®/Jetta/Cabrio 2.0 '93-99.5

#SN20024 ..... 39.<sup>95</sup>

'93-96 Golf®/Jetta VR6

#SN20025 ..... 49.<sup>95</sup>

'97-99.5 Golf®/Jetta VR6

#SN20026 ..... 49.<sup>95</sup>

'97-99.5 Jetta TDI

#SN20034 ..... 59.<sup>95</sup>



Tie rod assy. (left) Golf®/Jetta III® w/power steering '93-99.5

#SN13608 ..... 104.<sup>65</sup> 59.<sup>95</sup>

Tie rod assy. (right) Golf®/Jetta III® w/power steering '93-99.5

#SN13609 ..... 104.<sup>65</sup> 59.<sup>95</sup>

Emblem grille Golf®/Jetta® '93-99.5 includes black trim gasket

#SN15379 ..... 24.<sup>95</sup> 19.<sup>95</sup>

Grille Golf® '93-99.5

#SN13601 ..... 77.<sup>97</sup> 59.<sup>95</sup>

Grille Jetta '93-99.5

#SN15016 ..... 119.<sup>97</sup> 64.<sup>95</sup>

Headlight (pass. side) Golf® '93-99.5 (not for GTI®)

#SN12196 ..... 129.<sup>95</sup> 109.<sup>95</sup>

Headlamp (left) Golf® '93-99.5 (not for GTI®)

#SN13561 ..... 129.<sup>95</sup> 109.<sup>95</sup>

Headlamp (right) Jetta® '93-99.5

#SN12772 ..... 130.<sup>30</sup> 119.<sup>95</sup>

Headlamp (left) Jetta® '93-99.5

#SN13604 ..... 129.<sup>95</sup> 119.<sup>95</sup>



**PartsPlace inc.**  
FOR ALL VOLKSWAGENS



# Afternoon At Central Spark

## Give Your VW a **BOSCH TUNE-UP!**

Our tune-up kits contain genuine Bosch® parts. Kits include Bosch® super plugs, plug wires, distributor cap and rotor (except where noted). Earlier cars have points and condenser and very recent model cars have no distributor at all. Our kit contains what is appropriate for your car. We have you covered.

Don't worry, call us and we'll send exactly what you need!

**Tune-up Kit 1**

- Rabbit® (including pick-up, GTI® & Conv.) Scirocco®, Jetta® '81-84
- Quantum® 4 cyl. '82-84

Contains:

- Distributor Cap . . . . . #SN3458
- Rotor . . . . . #SN3463
- Plug Wire Set . . . . . #SN12697
- 4 Super Plugs . . . . . #SN3386

#SN14280 **39<sup>95</sup>** Special Kit Price

**Tune-up Kit 2**

- Golf®/Jetta® '85-87 (Std. or GL®, not GTI®/GLI®)•Cabriolet® '85-89 •Scirocco® '85-88 (exc. 16 valve) •Fox®'87-90
- Quantum® 4 cyl. '85 only

Contains:

- Distributor Cap . . . . . #SN3459
- Rotor . . . . . #SN3463
- Plug Wire Set . . . . . #SN50012
- 4 Super Plugs . . . . . #SN3386

#SN5653 **58<sup>95</sup>** Special Kit Price

**Tune-up Kit 3**

- Golf®/Jetta® '88-92 (all exc. 16 valve)
- GTI®/GLI® 8V '85-87, Cabriolet® '90-93
- Fox® '91-93

Contains:

- Distributor Cap . . . . . #SN3459
- Rotor . . . . . #SN3465
- Plug Wire Set . . . . . #SN50012
- 4 Super Plugs . . . . . #SN3386

#SN14292 **54<sup>95</sup>** Special Kit Price

**Tune-up Kit 4**

- Golf®/Jetta III® 4 cylinder '93-99 1/2
- Cabriolet® '95-02
- Passat® GLS® 4 cylinder '95-97

Contains:

- Distributor Cap . . . . . #SN3458
- Rotor . . . . . #SN3463
- Plug Wire Set . . . . . #SN12697
- 4 Super Plugs . . . . . #SN3386

#SN14295 **109<sup>95</sup>** Special Kit Price

**Tune-up Kit 5**

- Scirocco® 16V '86-88
- GTI®/GLI® 16V '87-92
- Passat® 4 cylinder '90-93

Contains:

- Distributor Cap . . . . . #SN3459
- Rotor . . . . . #SN3465
- Plug Wire Set\*\* . . . . . #SN9049
- 4 Super Plugs . . . . . #SN3391

#SN20484 **109<sup>95</sup>** Special Kit Price \*\*NOT Bosch

**Tune-up Kit 6**

- Golf®/Jetta® VR6® '94-99 1/2
- Passat® VR6® '94-97
- Corrado® VR6® '93 1/2 - 95

Contains:

- Plug Wire Set . . . . . #SN13648
- 6 Super Plugs . . . . . #SN11462

#SN14324 **139<sup>95</sup>** Special Kit Price

**Tune-up Kit 7**

- Rabbit® '75-80 •Scirocco® '74-80
- Jetta®/Rabbit® Conv./Pick-up '80 only •Dasher® '73-80

Contains:

- Distributor Cap . . . . . #SN3458
- Rotor . . . . . #SN3462
- Plug Wire Set . . . . . #SN12697
- 4 Super Plugs . . . . . #SN3386
- Points . . . . . #SN3449
- Condenser . . . . . #SN3455

#SN18665 **48<sup>90</sup>** Special Kit Price

**Tune-up Kit 8**

“VR6® with Distributor”

- Passat® VR6® '92-93 •Corrado® VR6® '92-93 1/2

Contains:

- Distributor Cap . . . . . #SN11445
- Rotor . . . . . #SN11491
- Plug Wire Set . . . . . #SN13648
- 6 Super Plugs . . . . . #SN11462

#SN14325 **219<sup>95</sup>** Special Kit Price

**Tune-up Kit 9**

- Quantum® 5 cylinder '83-84
- Audi® 5 cylinder '79-84

Contains:

- Distributor Cap. . . #SN3457
- Rotor. . . . . #SN3464
- Plug Wire Set. . . #SN3443
- 4 Super Plugs. . . #SN3386

#SN13837 **84<sup>95</sup>** Special Kit Price

**Tune-up Kit 10**

- Quantum® 5 cylinder '85-88
- Audi® 5 cylinder '85-88

Contains:

- Distributor Cap. . . #SN5773
- Rotor. . . . . #SN3464
- Plug Wire Set. . . #SN11494
- 4 Super Plugs. . . #SN3386

#SN14332 **119<sup>95</sup>** Special Kit Price

**Tune-up Kit 11**

- Type I® '70-7 •Type II® '70-71

Contains:

- Distributor Cap. . . #SN3458
- Rotor. . . . . #SN3462
- Plug Wire Set. . . #SN50011
- 4 Super Plugs. . . #SN3388
- Points. . . . . #SN3449

#SN14235 **49<sup>95</sup>** Special Kit Price

**Tune-up Kit 12**

- Type II® '74-79, Vanagon® (air-cooled) '80-83

Contains:

- Distributor Cap . . #SN3458
- Rotor . . . . . #SN3462
- Plug Wire Set. . . #SN3445
- 4 Super Plugs. . . #SN3388
- Points. . . . . #SN3449
- Condenser. . . . . #SN3453

#SN14247 **58<sup>95</sup>** Special Kit Price

**Tune-up Kit 13**

- Vanagon® 1.9 Wasserboxer® '83-85

Contains:

- Distributor Cap. . . #SN3458
- Rotor . . . . . #SN3463
- Plug Wire Set. . . #SN3446
- 4 Super Plugs. . . #SN3385

#SN14256 **69<sup>95</sup>** Special Kit Price

**Tune-up Kit 14**

- Vanagon® 2.1 Wasserboxer® '86-92 (including Syncro®)

Contains:

- Distributor Cap. . . #SN3459
- Rotor. . . . . #SN3465
- Plug Wire Set. . . #SN3446
- 4 Super Plugs. . . #SN3385

#SN14261 **79<sup>95</sup>** Special Kit Price

**Tune-up Kit 15**

- Golf® /Jetta 4,® '99-05
- 4 Cylinder 8 valve Engine

Contains:

- Plugs. . . . . #SN19575
- Plug Wires. . . #SN19685

#SN19986 **94<sup>95</sup>** Special Kit

**Tune-up Kit 16**

- Golf/Jetta® •Passat® '98-04
- 1.8 Turbo Gas

Contains:

- Plugs. . . . . #SN18964

#SN19984 **20<sup>95</sup>** Special Kit



## Oxygen Sensor

We sell both "universal" and OE long wire type O2 sensors. The universal sensors are BOSCH and come with about 3" of wire and a crimp connector. You reuse the long wire off your old sensor. The OE sensor is virtually the same, but 5 minutes less work because you don't have to splice. The OE style are BOSCH and come with the long original equipment wire, no splicing. Both are 100% excellent. The long wire type is more expensive.

Application	Part#	Our Price
Rabbit® '80-84		
Pick-up '80-84		
Scirocco® '80-87 (exc. 16 valve)		
Quantum® '82-87		
Golf® '85-87 (exc. GTI®)		
Jetta® '85-87 (exc. GLI®)		
Fox® '87 only		
Cabriolet® '80-87		
<b>OE w/long wire</b>	<b>#SN3394</b>	<b>49.95</b>

GTI® '85-92 (inc. 16 valve)		
GLI® '85-92 (inc. 16 valve)		
Fox® '88-90		
Cabriolet® '88-89		
Scirocco® 16V '86-88		
Quantum® '88 only		
<b>OE w/long wire</b>	<b>#SN3403</b>	<b>149.95</b>
<b>Universal</b>	<b>#SN3404</b>	<b>79.95</b>

Golf® '88-92 (exc. GTI®)		
Jetta® '88-92 (exc. GLI®)		
Corrado® '89 only		
<b>OE w/long wire</b>	<b>#SN4455</b>	<b>159.95</b>
<b>Universal</b>	<b>#SN3404</b>	<b>79.95</b>

Passat® 4 cyl. '90-93		
Fox® 91-93		
Cabriolet® '90-93		
<b>OE w/long wire</b>	<b>#SN11480</b>	<b>149.95</b>
<b>Universal</b>	<b>#SN3404</b>	<b>79.95</b>

Golf® '93-95		
Jetta® '93-95		
Cabriolet® '95		
Corrado® VR6® '92-95		
<b>OE w/long wire</b>	<b>#SN11472</b>	<b>159.95</b>
<b>Universal</b>	<b>#SN18019</b>	<b>99.95</b>

Golf®/Jetta® 4 cyl. '96-99.5		
Cabriolet® '96-99		
<b>OE w/long wire (front)</b>	<b>#SN15257</b>	<b>139.95</b>
<b>OE w/long wire (rear)</b>	<b>#SN15256</b>	<b>CALL</b>
<b>Universal</b>	<b>#SN18019</b>	<b>99.95</b>

Golf®/Jetta® VR6® '96-99.5		
<b>OE Style (front)</b>	<b>#SN17064</b>	<b>129.95</b>
<b>OE Style (rear)</b>	<b>#SN17063</b>	<b>139.95</b>
<b>Universal</b>	<b>#SN18019</b>	<b>99.95</b>

## Oxygen Sensor Wrench

with instructions



**#SN3510** ..... **26.95**

## Ignition Coils



VW Coils were bulletproof until they "improved" it in about '93. After then there are many problems in all of them. If it doesn't run right; yes it could be the coil, check it.



Application	Part#	Our Price
Type 1® '67-79		
Type 2® '67-79		
Vanagon® '80-83 (exc. Wasserboxer®)		
Type 3® '67-73		
Type 4® '71-74		
Dasher® '74-80		
Rabbit®, Scirocco® '75-80		
Jetta®, Pick-up, Conv. '80 only		
<b>New</b>	<b>#SN3026</b>	<b>26.95</b>
<b>Recycled</b>	<b>#SN32368</b>	<b>15.00</b>

All models '81-94 (except air-cooled Vanagons®)		
<b>New</b>	<b>#SN3028</b>	<b>59.95</b>
<b>Recycled</b>	<b>#SN32702</b>	<b>25.00</b>

All models '85-92 (except VR6®) Fox® '87-93		
Cabriolet® '85-93		
<b>New</b>	<b>#SN4443</b>	<b>69.95</b>
<b>Recycled</b>	<b>#SN33375</b>	<b>25.00</b>

Golf®/Jetta® 4 cyl. '93-99.5		
Cabriolet® '95-02		
Eurovan® '93-95		
Passat® 4 cyl. '95-96		
<b>New</b>	<b>#SN16083</b>	<b>99.95</b>
<b>Recycled</b>	<b>#SN35750</b>	<b>75.00</b>

Golf®/Jetta® VR6® '94-99.5		
Passat® VR6® '93.5-97		
Corrado® VR6® '93-95		
<b>New</b>	<b>#SN16796</b>	<b>CALL</b>
<b>Recycled</b>	<b>#SN38690</b>	<b>195.00</b>

Golf®/Jetta® 2.0L '99.5-04		
New Beetle® 2.0L '98-04		
<b>New</b>	<b>#SN18670</b>	<b>114.95</b>
<b>Recycled</b>	<b>#SN37522</b>	<b>60.00</b>

Golf®/Jetta® VR6® '99.5-02		
<b>New</b>	<b>#SN16740</b>	<b>299.95</b>



**NEW & USED**

## Distributors

If your distributor is just plain worn out - the shaft wobbles or the oil seal leaks (this is common on 16 valve models), you need a new distributor. We have recycled distributors available for most cars, or new distributors for many as well. Get the part# (it is stamped on the body of the distributor) before you call us so we can match it up exactly from \$50.00.



## Spark Plug Wires

We sell genuine Bosch® plug wires for every VW®, but in many cases, we have alternate wires available which are just as good and are the same wires VW® uses in the plant when they build your car. These wires are an excellent value!

Application	Part#	Our Price
Bug	<b>#SN50011</b>	<b>19.95</b>
Rabbit®/Jetta® '75-84	<b>#SN12697</b>	<b>22.95</b>
Quantum® '83-84, 5 cyl	<b>#SN3443</b>	<b>48.95</b>
Quantum® '85-88, 5 cyl	<b>#SN11494</b>	<b>69.95</b>
Bus® '72-79	<b>#SN3445</b>	<b>29.95</b>
Vanagon® '83-92	<b>#SN3446</b>	<b>49.95</b>

Golf®/Jetta® '85-92 (exc. 16V)		
Scirocco® '85-88 (exc. 16 valve)		
Cabriolet® '85-93		
Fox® '87-93		
Corrado® 4 cyl. '89-92		
<b>Dealer Price</b>	<b>59.40</b>	
(Bosch)	<b>#SN50012</b>	<b>39.95</b>
(Brazilian)	<b>#SN15244</b>	<b>29.95</b>

Golf®/Jetta III® 4 cyl. '93-99.5		
Cabriolet® '95-02		
Passat® 4 cyl. '95-96		
<b>Dealer Price</b>	<b>119.95</b>	
(European OE)	<b>#SN18249</b>	<b>Only 79.95</b>
(South American OE)	<b>#SN15243</b>	<b>59.95</b>

Golf®/Jetta® 16 valve '87-92		
Scirocco® 16 valve '86-88		
Passat® 4 cyl. '90-93		
Bosch	<b>#SN9049</b>	<b>149.95</b>
Just as good, and cheaper!		
(Brazilian OEM)	<b>#SN15245</b>	<b>79.95</b>

Golf®/Jetta III® VR6® '94-99.5		
Passat® VR6® '92-97		
Corrado® VR6® '92-95		
<b>Dealer Price</b>	<b>135.57</b>	
Bosch	<b>#SN13648</b>	<b>Only 119.95</b>
(German aftermarket)	<b>#SN16628</b>	<b>99.95</b>

Golf®/Jetta®/Beetle® '99.5-05 2.0L 4 cyl		
Bosch	<b>#SN19992</b>	<b>129.95</b>
Brazil	<b>#SN19685</b>	<b>79.95</b>
(The Brazil are very good)		



# Wheel & Deal



**Save \$176<sup>00</sup>**  
 ....with just a phone call.

## How To Identify Wheels?

Try to locate the style wheel you have on your car by using the pictures on this page.

If you're looking for a complete set of wheels, or wheels and tires, refer to the style by the letter under the picture and ask your salesperson about your particular application.

Volkswagens® have steel or light alloy wheels from the factory. They come in 13", 14", 15" or 16" diameters and in widths of 4 1/2" to 6". All 4 cylinder Volkswagen® cars from 1980 - 1998 have the same 4 x 100mm bolt pattern. Most front wheels can be used on any model providing tire size and brake caliper clearance have been considered. Generally, cars with rear disc brakes require a 14" wheel as a minimum diameter.

If you are unsure of which wheel is yours, look under the center cap or hub cap and you will find the size (14" x 6") and the part number stamped into the wheel. A part number would look like: (191-601-025-B) and is a sure fire way to get the wheel you need in a hurry!

## STEEL WHEELS

We have probably more steel wheels for VWs® than anyone else! Whether you're looking for a wheel that matched the other three on your car or a set of four to mount show tires on or just something round and true that will get you car safely down the road, we know what fits, what doesn't and what will work for your particular needs. CALL US! We have a solution!!

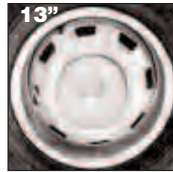

Wheel: #SN31266  
 Hubcap: #SN31275  
 Trim Ring:

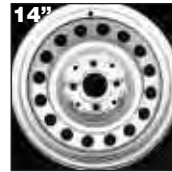

Wheel: #SN2185 (New)  
 #SN35937 (Rec)  
 Hubcap: #SN16311 (New)  
 #SN34617 (Rec)  
 Trim Ring: #SN10991 (New)  
 #SN10620 (Rec)

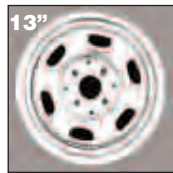

Wheel: #SN31314  
 Hubcap: #SN31334



Wheel: #SN9146 (New)  
 #SN10113 (Rec)  
 Hubcap: #SN16311 (New)  
 #SN34617 (Rec)  
 Trim Ring: #SN10991 (New)  
 #SN10620 (Rec)

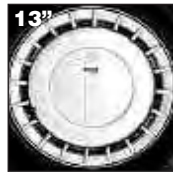

Wheel: #SN2184 (New)  
 #SN31278 (Rec)  
 Hubcap: #SN11558 (New)  
 #SN33669 (Rec)  
 Trim Ring: #SN4105 (New)  
 #SN33679 (Rec)

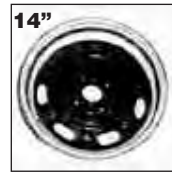

Wheel: #SN9144 (New)  
 Hubcap: #SN34499 (Rec)  
 Note: Passat® 4 cyl.  
 '90-97

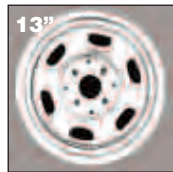

Wheel: #SN31313  
 Hubcap: #SN31275



Wheel: #SN13179 (New)  
 Hubcap: #SN35598 (Rec)  
 Note: Golf®/Jetta® '93-99.5  
 Cabriolet® '95-02  
 Wheel Covers: See below



Wheel: #SN16033  
 Note: 5 lug fits  
 Beetle®/Golf®/Jetta®  
 '99.5-03. Fits any  
 VR6® '92-99.5  
 Wheel Covers: See below



Wheel: #SN16034  
 Note: 5 lug fits  
 Beetle®/Golf®/Jetta®  
 '99.5-03.  
 Fits any VR6® '92-99.5  
 Wheel Covers: See below

## WHEEL COVERS

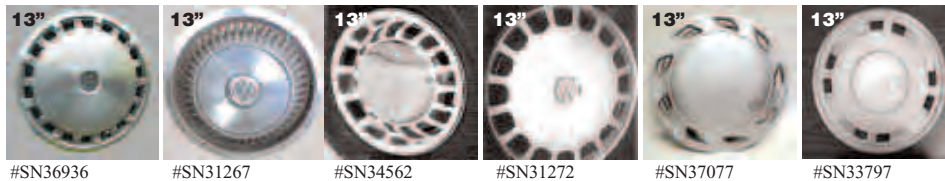

**Buy 4 and Save More!**  
 Get a set of wheels or hubcaps and save \$\$\$ over the regular individual price. Ask your salesperson for details!

### NEED ONE OR TWO TIRES TO MATCH WHAT YOU HAVE?

Used tires with excellent (more than 60% of the tread left). Occasionally we have sets of four. State size. Sorry we can not guarantee a matching brand, but you can ask. Limited 6 month one time only replacement warrantee, no freight, no cash refund.

**#SN35945** 175-70-13 \$15.<sup>00</sup>  
**#SN35946** 185-60-14 **20.<sup>00</sup>**  
**#SN35947** 195-60-14 **25.<sup>00</sup>**

Whether you're looking for a set to dress up your car, or just one to replace the one you bent after hitting a crater-sized pothole, we've got what you need! Just pick your wheel below or call with the part number off your wheel.



Wheel:  
#SN31311  
Center Cap:  
#SN2201



Wheel:  
#SN2191 (New)  
#SN36606 (Reman)  
#SN  
Center Cap:  
#SN2202



Wheel:  
#SN36597  
Hubcap:  
#SN36892



Wheel:  
#SN13638  
Center Cap:  
#SN16692  
#SN37667  
Note: 5 lug

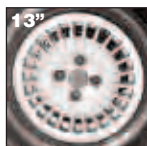

Wheel:  
#SN36481 (Reman)  
#SN31312 (Rec)  
Center Cap:  
#SN2202



Wheel:  
#SN11143 (Reman)  
#SN10163 (Rec)  
Center Cap:  
#SN18052 (New)  
#SN38410 (Rec)

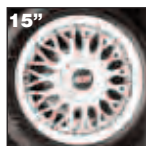

Wheel:  
#SN11077  
Center Cap:  
#SN14276 (New)  
#SN37664 (Rec)  
Note: 4 lug



Wheel:  
#SN38947  
Center Cap:  
#SN18325



Wheel:  
#SN4102  
Center Cap:  
#SN2202



Wheel:  
#SN289 (New)  
#SN31316 (Reman)  
#SN31317 (Rec)  
Center Cap:  
#SN12485 (New)  
#SN31328



Wheel:  
#SN33706  
Center Cap:  
#SN14276 (New)  
#SN37664 (Rec)  
Note: 4 Lug



Wheel:  
#SN38713  
Center Cap:  
#SN38714  
Note: VR6® '92-99 only



Wheel:  
#SN34653 (Reman)  
#SN4103 (Rec)  
Center Cap:  
#SN15810 (New)  
#SN36607 (Rec)



Wheel:  
#SN15591 (New)  
#SN10840 (Reman)  
#SN31276 (Rec)  
Center Cap:  
#SN16581 (New)  
#SN14190 (Rec)



Wheel:  
#SN13486 (New)  
#SN15815  
#SN15816  
Center Cap:  
#SN15818



Wheel:  
#SN38948  
Center Cap:  
#SN38949  
Note: Passat® '98-01.5 only

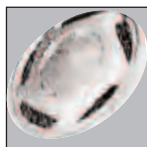

Wheel:  
#SN15357  
Center Cap:  
#SN11153



Wheel:  
#SN34614 (Reman)  
#SN36608 (Rec)  
Center Cap:  
#SN38938



Wheel:  
#SN33522 (Reman)  
#SN37152 (Rec)  
Center Cap:  
#SN34524



Wheel:  
#SN38950  
Center Cap:  
#SN38951



Wheel:  
#SN17808 (New)  
#SN38352 (Rec)  
Center Cap:  
#SN2202



Wheel:  
#SN35759  
Center Cap:  
#SN16590



Wheel:  
#SN16120  
Center Cap:  
N/A

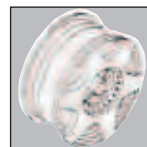

Wheel:  
#SN15965  
Center Cap:  
#SN38952



Wheel:  
#SN39092 (Reman)  
Center Cap:  
#SN2202



Wheel:  
#SN16705 (new)  
#SN35761 (reman)  
#SN38069 (rec)  
Center Cap:  
#SN13840



Wheel:  
#SN16117  
Hubcap:  
#SN14826

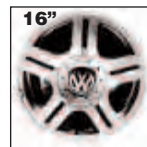

Wheel:  
#SN38953  
Center Cap:  
#SN38954  
Note: Golf®/ Jetta® '99.5-02



Wheel:  
#SN36691  
Center Cap:  
#SN2202

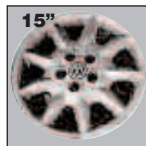

Wheel:  
#SN14122  
Center Cap:  
#SN14826

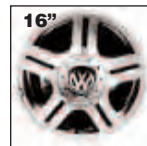

Wheel:  
#SN38955  
Center Cap:  
#SN38956  
Note: Passat® '98-03



Wheel:  
#SN14831  
Center Cap:  
#SN14826

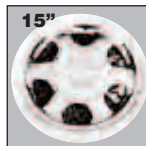

Wheel:  
#SN15959 (Reman)  
#SN38505 (Rec)  
Center Cap:  
#SN14565 (New)  
#SN38506 (Rec)



**Complete Jack & Tool Sets**  
Jack & tool set G/J/Conv/Scirocco® '85-92 complete with tools, holder and strap.  
#SN39102 ..... 39.<sup>95</sup>  
Jack & tool set G/J/Conv. '93-99  
#SN39103 ..... 49.<sup>95</sup>  
Jack & tool set G/J/Conv. '99.5-03  
#SN39104 ..... 59.<sup>95</sup>  
Jack & tool set Passat® '90-97  
#SN39105 ..... 49.<sup>95</sup>  
Jack & tool set Passat® '98-03  
#SN39106 ..... 59.<sup>95</sup>

## LUG WRENCH

Lose yours? Did the previous owner forget to sell it to you with the car? Original factory wrench in 17mm or 19mm.



- 17mm (most watercooled)
- #SN30003 ..... 5.<sup>00</sup>
- 19mm (most aircooled)
- #SN30002 ..... 5.<sup>00</sup>

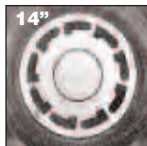

Wheel:  
#SN36609 (Reman)  
#SN33943 (Rec)  
Center Cap:  
#SN15278  
#SN33944 (Rec)

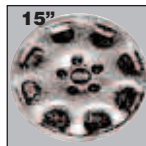

Wheel:  
#SN16122  
Hubcap:  
#SN15818



Wheel:  
#SN11216 (Reman)  
#SN37403 (Rec)  
Center Cap:  
#SN14159 (New)  
#SN36908 (Rec)  
Note: Vanagon® only



Wheel:  
#SN14848

Be the first on your block with a '72 Beetle® with '98 hubcaps!!

**OEM Volkswagen®**  
*NEW* Hubcaps  
Genuine VW®



for  
**14"**  
wheels

**14" Hubcaps - Set of 4**

Passat® '95-97 #SN15524 ..... \$39.95 ea.  
Will also fit most Golf®/Jetta®/Passat® '85-97



for  
**16"**  
wheels

**16" Hubcaps - Set of 4**

New Beetle® '98 & up #SN15523 \$34.95 ea. \$100 set  
Should fit any 16" wheel



for  
**14"**  
wheels

**14" Hubcaps - Set of 4**

Jetta III® '93-99 #SN15522 ..... \$39.95 ea.  
Will also fit most Golf®/Jetta®/Passat® '85-97



for  
**14"**  
wheels

**Hubcaps - Set of 4**

Golf III® '98-99 #SN15521 ..... \$39.95 ea.



for  
**15"**  
wheels

**Hubcaps - Set of 4**

Passat® '98-02 #SN15520 \$29.95 ea. . . \$100 set



**14"**

**Hella Hub Caps**

All Golf®/Jetta® '88-98 1/2 and Passat® '90-97 original Hella Hub Caps. These have 14" wheels. These Hella Hubcaps fit excellent and hold on tight in all but foot deep pot holes.

#SN14454 ..... \$34.95 ea.  
#SN35675 ..... Set of 4 \$129.95



**15" x 6.5"**

**OEM BBS VR6® Wheels**

(All with 5 lug bolts) originally found on Golf®/Jetta® & Passat® '93-97 with VR6® engines. We have some different classes: **New, Refurbished, New w' minor cosmetic blemishes (which cannot be seen from 30") and Recycled.**

New #SN13486 ..... \$299.95 ea.  
Refurbished #SN36596 ..... \$269.95 ea.  
Very Minor Scratches #SN35760 ..... \$200.95 ea.  
Almost Perfect #SN15815 ..... \$235.95 ea.  
Minor Scratches #SN15816 ..... \$199.95 ea.  
not visible from 30'

**SPECIAL Set of 4 \$499.95**



**Bottlecap Design 14" x 6"**

will fit any Rabbit®, Jetta®, Golf® '75-95  
#SN15591 ..... \$159.95 ea. .... set of 4 \$450.00  
**Set of 4 \$299.95**

Center caps sold separately

**Center Cap**

Rabbit® 7" hubcaps.  
- CALL



**Diesel  
Pistons  
Oversized  
too!!**





# STOP GETTING HIT IN THE HEAD!

If your hatch won't stay up anymore, don't resort to a broomstick to hold it up!

## Replace the HATCH SHOCKS NOW!

	PART NUMBER	SALE PRICE	RBI PRICE
VANAGON® '82-92 NEW	#SN2819	67. <sup>43</sup>	39. <sup>95</sup>
EUROVAN®	#SN13813		59. <sup>95</sup>
GOLF® '85-92 NEW	#SN9180	53. <sup>00</sup>	29. <sup>95</sup>
Recycled	#SN31918	-	15. <sup>00</sup>
GOLF III® '93-99.5 NEW	#SN16760	66. <sup>88</sup>	39. <sup>95</sup>
GOLF IV® '99-02	#SN18683		34. <sup>95</sup>
RABBIT® '75-84 NEW	#SN2808	44. <sup>93</sup>	29. <sup>95</sup>
Recycled	#SN31723	-	15. <sup>00</sup>
SCIROCCO® 1975-81 NEW	#SN2812	59. <sup>93</sup>	49. <sup>95</sup>
1982-88 NEW	#SN32201	82. <sup>60</sup>	49. <sup>95</sup>
CORRADO®	#SN13327		49. <sup>95</sup>
CABRIOLET® '80-93 Rear Trunk Lid NEW	#SN13812	72. <sup>56</sup>	59. <sup>99</sup>
Recycled	#SN38767	-	29. <sup>95</sup>
CABRIOLET®/JETTA III® '93-99.5 NEW	#SN16520		29. <sup>95</sup>
Jetta IV® '99.5-03	#SN18684		49. <sup>95</sup>
FOX® WAGON	#SN15947		59. <sup>95</sup>



QUANTUM® WAGON '82-88 NEW	#SN14091	82. <sup>98</sup>	49. <sup>95</sup>
PASSAT® WAGON '90-97 NEW	#SN35471	85. <sup>60</sup>	39. <sup>95</sup>
PASSAT® SEDAN '98-03	#SN18687		49. <sup>95</sup>
PASSAT® WAGON '98-03	#SN18683		49. <sup>95</sup>
NEW BEETLE® '98-03	#SN18685		39. <sup>95</sup>

## TRAILER HITCHES



These are 100% first class! These trailer hitches are designed specifically for the particular car. They fit perfectly. Look good, work! Follow all instructions from the hitch manufacturer. Trailer hitches can generally be installed by the shade tree mechanic. Warning: do not install a trailer hitch unless you're totally familiar with how to do it! They bolt on with bolts and big washers which usually come with the hitch. Don't bolt to rusted metal. You'll need a 3/8" electric drill, safety glasses and hand tools. (We have a good selection of used trailer hitches which may or may not include bolts; don't install with incorrect bolts.) Trailer hitches are new, zinc or black coated. Don't exceed the hitch or the vehicle's towing capacity. You can't tow a 30' boat with any VW®. Read the hitch manufacturers instructions.

Bus® '73-79	#SN3755	139. <sup>95</sup>
Bus® '73-79 Recycled	#SN35180	70. <sup>00</sup>
Cabriolet® '85-87	#SN3763	59. <sup>95</sup>
Cabriolet® '88-90	#SN10365	109. <sup>95</sup>
Eurovan® '93-03	#SN14448	199. <sup>95</sup>
Fox® '87-93	#SN5375	109. <sup>95</sup>
Golf® '85-90	#SN3762	59. <sup>95</sup>
Golf® '91-92, '90 Wolf	#SN5663	169. <sup>95</sup>
Golf® 4 cyl. '93-99.5	#SN14444	149. <sup>95</sup>
Golf® '99.5-05	#SN17884	169. <sup>95</sup>
Jetta® '85-90	#SN3765	59. <sup>95</sup>
Jetta® '91-92, '90 Wolf	#SN5374	129. <sup>95</sup>
Jetta® '93-99.5 (RT)	#SN14445	149. <sup>95</sup>
Jetta® '99.5-05 Sedan	#SN19160	159. <sup>95</sup>
New Beetle® '98-05	#SN15221	129. <sup>95</sup>
Rabbit® '75-84	#SN3763	59. <sup>95</sup>
Quantum® '82-84 Recycled	#SN38075	60. <sup>00</sup>
Passat® Sedan All (RT) '90-97	#SN10434	169. <sup>95</sup>
Wagon All (RT) '90-97	#SN14447	199. <sup>95</sup>
Passat® Sedan '98-05	#SN16866	219. <sup>95</sup>
4 motion Sedan '98-05	#SN16868	189. <sup>95</sup>
Wagon '98-02	#SN16865	199. <sup>95</sup>
4 Motion	Call	
Scirocco® to '84	#SN3763	59. <sup>95</sup>
Vanagon® '80-92	#SN3764	79. <sup>95</sup>

Recycled hitches are available at approximately 50% savings.

Do not forget to order a ball and safety chain for your trailer hitch. Safety chain is 4' long using heavy plated chain with a S-hook on each end.

W) Safety Chain	#SN3259	7. <sup>95</sup>
Z) Ball 1 7/8"	#SN3760	7. <sup>95</sup>

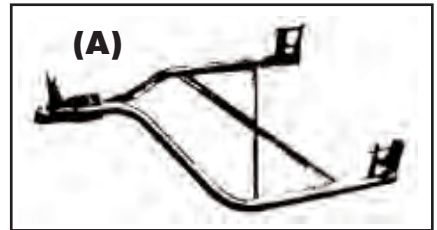

### Tow Bars

A tow bar is what you attach to the front of a car if you want to tow it. A trailer hitch is what you bolt on to the back of the car to tow a trailer with. **Never** use a tow bar without safety chains, an extra cost option.

A) A tow bar attaches to the lower front axle beam with easily installed and removable pins, on all Beetle® (not Super), Ghia®, Thing®, Dune Buggy®, Rails, etc.

#SN3767 1 7/8" Ball	97. <sup>43</sup>	64. <sup>95</sup>
#SN10753 2" Ball		74. <sup>95</sup>

On the Super Beetle® the tow bar bolts under the car and can be permanently attached. The tow bar mounts to the plate with easily installed and removable pins. (Not shown)

#SN3768	134. <sup>93</sup>	89. <sup>95</sup>
---------	--------------------	-------------------



B) This "semi-universal" tow bar will bolt through the front bumper cover into the metal bumper and tow any Rabbit® '75-84, Jetta® '80-98, Golf® '85-98, VW Fox® '87-93. It can also be used on other things "it is "Universal"! It requires drilling through the bumper and cover. The four L shaped brackets remain on the bumper and the tow bar can be removed or tilted up when not in use. The Mounting holes are apx. 36" apart. It's apx. 36" long and has a 2" Ball. Follow manufacturer's directions and Limitations!!

#SN9663	119. <sup>95</sup>
---------	--------------------



MANY OTHERS  
CALL!



# HEADLIGHTS

NEW & USED

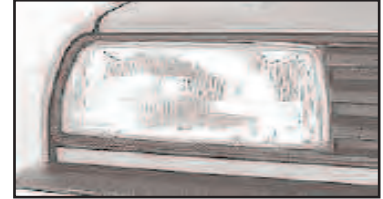

## Headlight Assemblies

The 85-92 Jetta®, and most 86-92 Golfs® have large "Euro Style" headlights. This assembly consists of a Lens/Reflector (the glass and the attached plastic backing) a mounting plate with screw adjusters and a separate halogen bulb. Look closely if you've just had one go out. It could be just the bulb. If there is more damage don't worry we sell all of the pieces you might need.

Main Headlight Bulb our . . . SN#3476 . . . \$8.<sup>95</sup>

Golf/Jetta® '85-92

Golf Base Model(these have singular reflector), 93-99.5 does NOT fit Golfs with dual reflector lights in GTI & some Cabrios.

Passat® '90-97

Fox '91-93

Quantum '87-88

A broken lens isn't the only reason to think about replacing your headlights. Over time, the reflectors and lenses can deteriorate, causing a dimmer and more diffuse light pattern. If you find that you're often "overdriving" the reach of you low beams (and your alternator checks our OK), it may be time for new headlight assemblies.



Which would you rather have?

## DOOR SPEAKER GRILLES

Rabbit®, Golf®, 88 up and Passats® have door speaker grills. These are real conveniently located so when you prop the door open with your foot, you break your speaker grill. We heard from the grapevine (which is totally unsubstantiated and is probably false) that the guy that invented these grills and located them right where you kick them out all the time got a \$25,000 bonus from the parts department for being so dumb plus increasing sales (Dear lawyers . . . this is a joke.) We sell OEM replacement grills. Buy two—you're going to kick it out again.

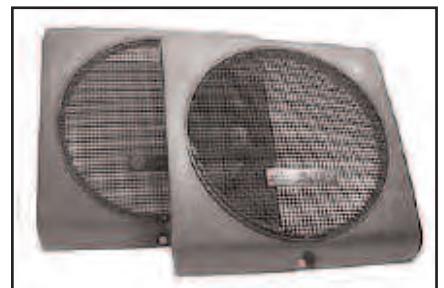

Golf/Jetta® '88-92

L=R #SN11037 Black . . . \$19.<sup>95</sup>

L=R #SN15026 Gray . . . \$22.<sup>95</sup>

Passat® '95-97

L=R #SN14540 Black . . . \$24.<sup>95</sup>

Passat® '90-94

L=R #SN14539 Red Clay . . . \$29.<sup>95</sup>



## Headlight Assembly

Golf® or Jetta® '85-92 including lens reflector mounting plate and adjusters, complete, ready to bolt in. We have these in Hella German in fancy yellow boxes. These are OEM and are perfect; we also have ones made in Asia which are D.O.T. approved and work fine. The Asian are cheaper, \$99.95. The Hella are \$129.95. Both work; the Hella are a tiny bit better quality.

Specify **Driver** or **Passenger**. Price is for NEW—We have some used—ASK.

Golf®, Jetta® '85-92, incl. lens, reflector, mounting plate & adjusters.

	Dealer	Our Price	Our Recycled Price
D #SN5229 Hella German	188. <sup>00</sup>	129. <sup>95</sup>	75. <sup>00</sup>
P #SN5230 Hella German	188. <sup>00</sup>	129. <sup>95</sup>	75. <sup>00</sup>
<b>LOOK!!!</b> Same as above, NEW D.O.T. approved. Made in Asia. They fit & look the same, & work." <b>BEST BUY!!</b>			
D #SN14220	188. <sup>00</sup>	99. <sup>95</sup>	
P #SN14219	188. <sup>00</sup>	99. <sup>95</sup>	
Golf® '93-99.5 - (single bulb) (GTIs® are different - ask)			
D #SN15387	149. <sup>95</sup>	109. <sup>95</sup>	80. <sup>00</sup>
P #SN12196	149. <sup>95</sup>	109. <sup>95</sup>	80. <sup>00</sup>
Jetta® '93-99.5			
D #SN13604	149. <sup>95</sup>	119. <sup>95</sup>	80. <sup>00</sup>
P #SN12772	149. <sup>95</sup>	119. <sup>95</sup>	80. <sup>00</sup>
VW Fox® '91-93			
D #SN10715	149. <sup>95</sup>	129. <sup>95</sup>	70. <sup>00</sup>
P #SN10720	149. <sup>95</sup>	129. <sup>95</sup>	70. <sup>00</sup>
Passat® '90-94			
D #SN10702	CALL	159. <sup>95</sup>	
P #SN10708		139. <sup>95</sup>	75. <sup>00</sup>
Vanagon	CALL	139. <sup>95</sup>	75. <sup>00</sup>

## Headlight Adjusters/Mounts

Passenger Side Headlight 1

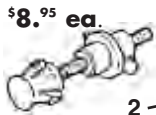

Headlight Adjusters/Mounts, Jetta®, Golf® '85-92 There are 3 different units -  
1. Mount Only it is the outboard top mount when you look at the light.

- #SN4447 . . . \$14.<sup>95</sup>
- 2. Up and Down Adjuster/Mount is outboard lower. #SN4449 . . . \$11.<sup>95</sup>
- 3. Side-to-Side Adjuster inboard top location. #SN4448 . . . \$11.<sup>95</sup>
- Vanagon® head light adjuster '86-92 Horizontal adjuster (2 required) Van #SN14034 . . . \$6.<sup>99</sup>
- Vertical adjuster Vanagon® #SN14035 . . . \$11.<sup>99</sup>

## HEADLAMP

### 3 HALOGEN BULBS

This is the special Halogen Bulb that gives the "Euro Style" or "Aero Style" large headlights their exceptional lighting ability.

If you have an '85-up with these headlights and it goes out - it might be just the bulb. If you have a crack in the lens, and the bulb is still good, replace the lens before moisture gets at the bulb and ruins it.

The main headlight bulb for all Volkswagens® & Audi® '85-98 that have a single head lamps. This is all Golf® & Jetta® '85-98 models. All Passat® '89-97, all Corrado®, all '85-88 Quantum®. Not Scirocco®. All Vanagon® '86-92.



DEALER US

Halogen Bulb - All Models '85-92 and most '93-98

#SN3476 . . . \$27.<sup>19</sup> . . . \$8.<sup>95</sup>

9004 Style, but BLUE! High Performance #SN14997 . . . \$27.<sup>19</sup> . . . \$12.<sup>95</sup>

Inner Bulbs 90-92 GTI® and others, the H3 bulb. #SN11853 . . . \$6.<sup>95</sup>

Rectangular Halogen Bulbs 5"x7" for '81-84 Rabbit® #SN9609 . . . \$12.<sup>95</sup>

Bulb - most VW® '99-03. Bulb # H-7 #SN18022 . . . \$9.<sup>99</sup>

Bulb - New Beetle '98-04. #SN15859 . . . \$6.<sup>95</sup>

A customer called last week and said the dealer would change the fog light bulb in their Jetta for a mere \$ 90.00, but they would have to wait until the next service bay was open. They called us and that day we shipped an OEM Halogen bulb for their car. You can change the bulb in about 15 minutes. Simply remove the lens cover, twist housing and remove bulb and connector, replace bulb, twist cover to lock and replace lens...DONE!!

OSRAM FOG LIGHT BULB #SN 11853

Dealer US \$24.<sup>20</sup> 6.<sup>95</sup>





# "Anybody Can Change A Taillight"

**SAVE \$50.00**  
**Taillight assemblies** are generally held in with about six 8 mm nuts, changing a taillight takes about 10 minutes, as all you have to do is loosen the 6 nuts and then unsnap the electrical connector. It's a job anybody can do. Parts Place has new and recycled taillight assemblies.

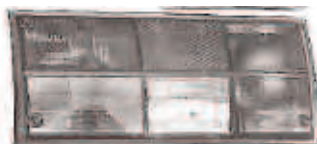

- Vanagon® '80-92  
**D** #SN3113 (New) ..... **99.95**  
 #SN5238 (Rec) ..... **39.95**  
**P** #SN3125 (New) ..... **99.95**  
 #SN5239 (Rec) ..... **39.95**



- Rabbit Pick-up® '80-84  
**D** #SN9107 (New) ... **79.95**  
 #SN4679 (Rec) ... **40.00**  
**P** #SN9108 (New) ... **79.95**  
 #SN34908 (Rec) ... **40.00**



- Fox Sedan® '87-90 (not pictured)  
**D** #SN34146 (Rec) ..... **60.00**  
**P** #SN10197 (Rec) ..... **60.00**  
 Fox Sedan® '91-93 (pictured above)  
**D** #SN10772 (New) ..... **79.95**  
**P** #SN10771 (New) ..... **79.95**

"Outer" "Inner"



- Passat® Sedan '90-94 (pictured)  
**D** Inner #SN10759 (New) ..... **89.95**  
 Outer #SN9430 (New) ..... **119.95**  
**P** Inner #SN10758 (New) ..... **89.95**  
 Outer #SN9429 (New) ..... **119.95**  
 Passat® Sedan '95-97 (not pictured)  
**D** Inner #SN16531 (New) ..... **79.95**  
 Outer #SN16529 (New) ..... **99.95**  
**P** Inner #SN16532 (New) ..... **79.95**  
 Outer #SN16530 (New) ..... **99.95**  
 Passat® Wagon '90-94 (not pictured)  
**D** Inner #SN35556 (Rec) ..... **50.00**  
 Outer #SN14789 (Rec) ..... **99.95**  
**P** Inner #SN35557 (Rec) ..... **50.00**  
 Outer #SN14791 (Rec) ..... **99.95**  
 Passat® Wagon '95-97 (not pictured)  
**D** Inner #SN18036 (New) ..... **89.95**  
 Outer #SN18038 (New) ..... **89.95**  
**P** Inner #SN18037 (New) ..... **89.95**  
 Outer #SN18039 (New) ..... **89.95**  
 Passat® Sedan '98-01.5 (not pictured)  
**D** #SN16993 (New) ..... **109.95**  
**P** #SN16994 (New) ..... **109.95**  
 Passat® Wagon '98-01.5 (not pictured)  
**D** #SN16995 (New) ..... **109.95**  
**P** #SN16996 (New) ..... **109.95**  
 New Beetle® '98-up (not pictured)  
**D** #SN18634 (New) ..... **69.95**  
**P** #SN18636 (New) ..... **69.95**

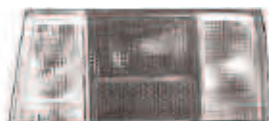

- Rabbit® '75-80, Cabriolet® '80-93  
**D** #SN37119 (Rec) ..... **35.00**  
**P** #SN32597 (Rec) ..... **35.00**



- Rabbit® '81-84  
**D** #SN3100 (New) ..... **78.95**  
 #SN32632 (Rec) ..... **35.00**  
**P** #SN3104 (New) ..... **78.95**  
 #SN32634 (Rec) ..... **35.00**

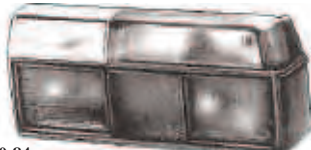

- Jetta® '80-84  
**D** #SN3110 (New) ..... **75.95**  
 #SN34019 (Rec) ..... **45.00**  
**P** #SN3122 (New) ..... **75.95**  
 #SN32549 (Rec) ..... **45.00**



- Scirocco® '82-88  
**D** #SN33227 (Rec) ..... **70.00**  
**P** #SN32897 (Rec) ..... **70.00**  
 Scirocco® 16 valve '86-88  
**D** #SN35884 (New) ..... **90.00**  
**P** #SN35885 (New) ..... **90.00**



- Golf® '93-99.5, Cabriolet® '95-99.5  
**D** #SN13617 (New) ..... **49.95**  
**P** #SN13616 (New) ..... **49.95**



"Inner"



"Outer"

- Jetta® '93-99.5  
**D** Inner #SN17287 (New) ..... **49.95**  
 Outer #SN13613 (New) ..... **44.95**  
**P** Inner #SN13614 (New) ..... **49.95**  
 Outer #SN13571 (New) ..... **44.95**

**WHEN ORDERING TAILLIGHTS, ALWAYS SPECIFY YEAR and SIDE.**

The taillight assemblies that we sell are usually Hella which is the German company. They are an original equipment supplier to VW®, Mercedes, BMW etc. The taillights we sell are identical to what the dealer sells only at a lower price. Taillight assembly are usually the complete lens and housing glued together as one unit, generally, you cannot replace the lens alone.

**"D"- DRIVERS SIDE / "P"- PASSENGERS SIDE**



- Jetta® '85-92  
**D** #SN3111 (New) ..... **69.95**  
 #SN34174 (Rec) ..... **40.00**  
**P** #SN3123 (New) ..... **69.95**  
 #SN33045 (Rec) ..... **40.00**



- Jetta® '99.5-05  
**D** #SN16408 (New) ..... **79.95**  
**P** #SN16409 (New) ..... **79.95**



- Golf®, GTI® '85-92  
**D** #SN3102 (New) ..... **47.95**  
 #SN33232 (Rec) ..... **30.00**  
**P** #SN3106 (New) ..... **47.95**  
 #SN33233 (Rec) ..... **30.00**



- Golf® '99.5-05  
**D** #SN16412 (New) ..... **89.95**  
**P** #SN16413 (New) ..... **89.95**  
 GTI® '99.5-05  
**D** #SN16410 (New) ..... **99.95**  
**P** #SN16411 (New) ..... **99.95**

**Tech Tip** Handle Halogen Bulbs Carefully!  
 Do not touch the glass portion. If you ever touch the bulb, wash it with alcohol before using, as the grease from your fingers will cause the bulb to overheat and burn out very fast.

**WE STOCK MANY TAILLIGHTS FOR OTHER VW MODELS AS WELL AS FOR MOST Audis® - CALL!**



# Shift Into Gear

## SHIFTER ROD BUSHING

This is the bushing that supports the main shift rod as it comes through its support bracket (the dealer sells the whole bracket assembly only, not just the bushing). If this bushing is worn out (most 10 year old plus cars), your shifter will not operate properly or feel right. Replace it above with the other small bushings in our shifter bushing kit.

Golf/Jetta 4 cyl. Gas '93-'99.5, Cab 80-'93  
**Main Shifter Rod Bushing #SN12787 ..... \$6.<sup>95</sup>**  
**Shifter Bushing Kit w/ above bushing #SN10664 ..... \$14.<sup>95</sup>**

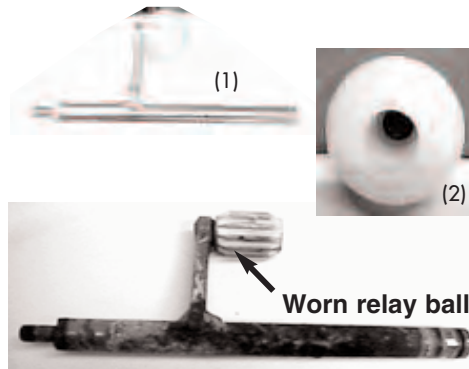
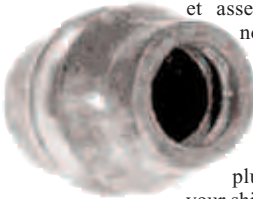

We couldn't believe the car could actually shift with this ball. The owner said he could do it, but no one else!!

## RELAY SHAFT

Golf®/Jetta® '85-99.5

The relay shaft is what is used to get the transmission into gear. If the ball either sticks or wears down, shifting is either a battle to get it into first or reverse or it's just not smooth. Our solution is either replace the ball or replace the entire relay shaft.

We had the balls manufactured out of nylon and they should last forever. They just click on. NOT AVAILABLE FROM ANYONE ELSE. Or you can replace the entire shaft and ball.

	DEALER	US
Relay Shaft with Ball (OEM) '85-92		
(1) #SN11615 .....	\$58. <sup>97</sup>	\$29. <sup>95</sup>
Relay Shaft Ball only (fits '85-99.5)		
(2) #SN14535 .....	\$32. <sup>27</sup>	\$19. <sup>95</sup>
Relay Shaft w/ Ball (fits '93-99.5)		
(1) #SN18881 .....	\$63. <sup>40</sup>	\$29. <sup>95</sup>

**Order 7 Days, 24 Hours a Day, from Anywhere in the World!**

Fax us your order stating model, year, engine, gas or diesel, and our parts required.. Our world-wide fax is always on at (248) 373-5950.

## SHIFT LEVER

Rabbit®, Jetta®, Scirocco® '75-84

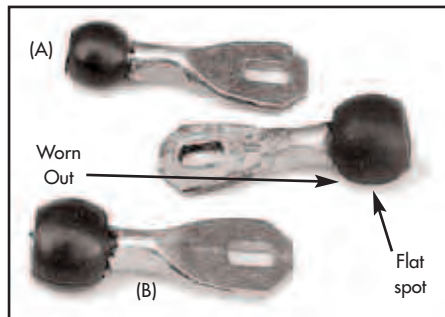

These short rods with a hard plastic ball help you get into gear. The sides wear out and get flat making it not as wide and unable to push the shifter into its correct place. You can then only get the car into first.

	DEALER	US
All 4-Speed		
(A) #SN02402 .....	\$22. <sup>43</sup>	\$14. <sup>95</sup>
All 5-Speed		
(B) #SN02403 .....	\$22. <sup>43</sup>	\$14. <sup>95</sup>



## COMPLETE SHIFTER KITS

Make your car shift the way it did when it was new. Includes bushings, selector rods, shifter ball and more! Order one today and enjoy shifting your car again.

(A) Rabbit®, Scirocco®, Jetta® '75-84 4-speed (includes large rubber under boot)		
#SN16088 .....	\$89. <sup>95</sup>	
(A) Rabbit®, Jetta® thru '84, Scirocco® thru '88, Cabriolet® thru '93 5-speed		
#SN16089 .....	\$99. <sup>95</sup>	
(B) Golf®, Jetta® '85-92 5-speed including the alignment tool		
#SN16090 .....	\$69. <sup>95</sup>	
(B) Golf®, Jetta® '93-99.5-speed including the alignment tool		
#SN18745 .....	\$69. <sup>95</sup>	
Shifter bushing kit VW®, Fox® all		
#SN15295 .....	\$19. <sup>95</sup>	

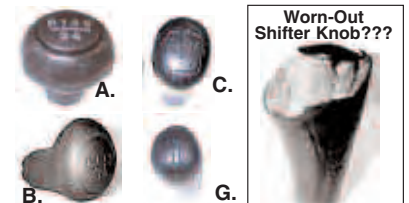

## SHIFTER KNOBS

Just the thing to "cap" your rejuvenated shift linkage! Original equipment style and feel. We stock new and have many used shift knobs on hand.

A. Rabbit®, Scirocco®, Jetta®, Golf®, Cabriolet® leatherette '75-82		
#SN15297 4 Speed .....	\$11. <sup>95</sup>	
#SN14605 5 Speed .....	\$14. <sup>90</sup>	
B. Golf®/Jetta® 5-speed '93-95, Textured Vinyl		
#SN14887 .....	\$20. <sup>20</sup>	\$14. <sup>90</sup>
C. Golf®/Jetta® 5-speed '85-92 leatherette		
#SN14605 .....	\$17. <sup>30</sup>	\$12. <sup>90</sup>
D. Golf®/Jetta®/Rabbit® 5-speed '77-92, Real Leather		
These leather knobs have a real nice feel. They have a wood core and glue on to your shaft with a super glue like stuff which is included.		
#SN11274 .....	\$29. <sup>90</sup>	
G. Fox®, (will fit all Fox® '87-93)		
#SN15137 4-speed .....	\$17. <sup>30</sup>	\$12. <sup>95</sup>
#SN16229 5-speed .....	\$17. <sup>30</sup>	\$12. <sup>95</sup>
Bug® '68-77 Plastic Shift Knob (not shown)		
#SN19183 4-speed .....	\$16. <sup>95</sup>	

## SHIFTER ALIGNMENT TOOL

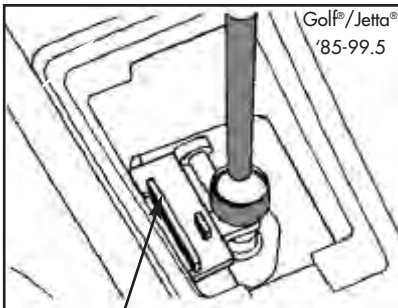

Alignment gauge being used to align shift lever and selector lever.



Golf®/Jetta® all '85-92, 2.0 L 4 cylinder '93-99.5. This shifter tool is required to line the shifting mechanism to prevent grinding of gears. It works only for this application, but is required to get proper alignment. This tool will save you days of adjusting and readjusting.

*-I tried it before I bought the tool-- it was impossible.*

*Recycled Jack*

	Dealer	US
#SN14520 .....	\$34. <sup>10</sup>	\$19. <sup>95</sup>



## Clutch Alignment Tool



### VW RABBIT® - SCIROCCO® - GOLF® - JETTA® Transmission Tools

[A] All Rabbits®, Sciroccos®, Jettas®, and Golfs® have a "backwards" clutch set-up. The clutch is bolted to the engine and the flywheel is bolted to the clutch. This is backward to what you might expect. It's impossible to align with the old "broom stick" method. Made of 30% glass filled nylon for strength to last a lifetime. Easy to use. Impossible without it.  
**Price reduced, Save \$4.00!**

- G/J/S 16v '86-92, G/J 2.0 '93-99.5  
#SN19684 ..... \$7.95
- #SN03500 ..... \$7.95
- [B] The VW Fox® type car with inline engine used the Beetle® style clutch alignment tool.  
#SN03519 ..... \$4.95
- [C] When removing the C.V. Joint Bolts, clean them out with a straightened paper clip, then put the tool in the bolt and give it a few good raps with a hammer to loosen it. Allen Star C.V. Joint Tool 8mm, 12-point allen #SN03481 ..... \$6.95
- [D] If you have already damaged your bolts, we sell them in lots of 6 new ones for \$4.75. CV Joint bolts. #SN12355 ..... \$5.25
- [E] Socket for transmission 17mm Drain Plug all VW® #SN13677 ..... \$8.95
- [F] 30 mm Socket for big axle nut #SN3478 ..... \$5.95  
30 mm Axle Nut  
VW says replace this everytime!  
#SN1971 ..... \$2.25
- [G] 9 mm 12 pt Socket for removing clutch bolts all Water cooled #SN14546 ..... \$9.99



**Attention Automatic Transmission owners** avoid costly repairs - Keep your trans fluid clean! Here's the pan gasket and strainer you'll need to change the fluid. Automatics - All VW® and Audi® up to '92.

Trans Gasket Kit w/strainer  
#SN18408 ..... \$19.95

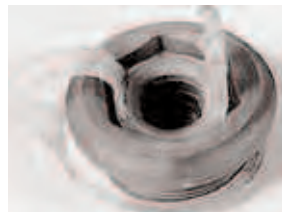

Rabbit®  
Golf®  
Jetta®  
Scirocco®  
Cabriolet®

Timing Hole Plug and Socket, keeps the small flywheel timing access hole plugged! Don't let water and dirt get in around your clutch.

All Manual Transmissions  
#SN11191 ..... \$9.95

## BEST SAVER

### A REBUILT TRANSMISSION for \$11.95 - \$17.95

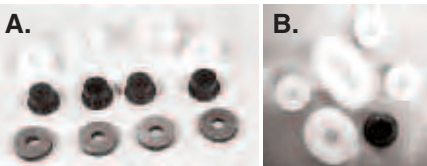

## ATTENTION ALL

JETTA®, GOLF®, RABBIT®, FOX®,  
SCIROCCO®, CABRIOLET® OWNERS

Many times people think they need a new transmission but actually they only need new linkage bushings.

### NEW SHIFTER BUSHING KITS!

Does it take two hands and all your effort to get your car into first or reverse? Does it grind? Can no one but you get it in gear? You don't need a new transmission, you need new shifter linkage bushings. If you have 75,000 miles on your car the bushings are wearing egg shaped, the shifter doesn't go where it's supposed to, and it grinds.

- (A.) R/J/Cab. thru '84, Scir. thru '88  
#SN2475 ..... \$11.95
- G/J '85-92, G/JIII 4 cyl '93-99.5  
#SN10664\* ..... \$14.95
- (B.) Fox®/Dasher® #SN15295 ..... \$19.95

\*Includes main shift rod bushing.



## OIL SEALS

If your going to have your transmission out don't forget those oil spots in your garage and driveway! Now's the time to work on the seals in the trans and at the back of the engine. We also have the clutch push rod seals and the output flange seals (where the driveshaft bolts up) a few examples -

- |   | DEALER | US     |
|---|--------|--------|
| <b>Transmission Main Shaft Seal</b>                             |        |        |
| Most Rabbit®, Scirocco®, Jetta®, Golf® '77-92                   |        |        |
| #SN1851   | \$8.65 | \$5.75 |
| 16V Models '87-92, G/JIII 4 cyl. '93-99.5                       |        |        |
| #SN11142  | 11.85  | 5.95   |
| <b>Clutch Push Rod Seals, Rabbit®, Jetta®, Golf®</b>            |        |        |
| #SN1850   | 11.15  | 7.95   |
| <b>Output Flange Seals, Rabbit®, Jetta®, Scirocco® thru '83</b> |        |        |
| #SN11581  | 26.90  | 14.95  |
| Rabbit GTI® and Diesel thru trans. #31073                       |        |        |
| #SN11582  | 24.20  | 14.95  |
| Jetta®, Golf®, Cabriolet®, Scirocco® '84-99.5 (exc. VR6)        |        |        |
| #SN4525   | 28.95  | 14.95  |
| <b>Engine Rear Main Crank Shaft Seal</b>                        |        |        |
| #SN1141   | 48.60  | 14.95  |

## Hard Shifting?



Call Us!

## SELECTOR RODS

The plastic-ended rods break often, and they're important - they operate the gear selector levers on the transmission.

All Rabbit®, Jetta® '75-84, Scirocco® thru '88, Cabriolet® thru '93

- |  |         | DEALER | US    |
|--|---------|--------|-------|
| <b>4-Speed</b>                                       |         |        |       |
| #SN2412  | Short   | 7.43   | 4.95  |
| #SN2415  | Long    | 7.43   | 4.95  |
| <b>5-Speed</b>                                       |         |        |       |
| #SN2413  | Short   | 7.43   | 4.95  |
| #SN2416  | Long    | 7.43   | 4.95  |
| All Golf®, Jetta®, '85-92                            |         |        |       |
| #SN2418  | Short   | 7.98   | 4.95  |
| #SN10785   | Long    | 7.98   | 4.95  |
| <b>Relay Lever (Short Rod With Black Ball)</b>       |         |        |       |
| #SN2402  | 4-Speed | 22.43  | 14.95 |
| #SN2403  | 5-Speed | 22.43  | 14.95 |
| All Golf®, Jetta® 4 cyl. '93-99.5, Cabriolet® '95-02 |         |        |       |
| #SN15695   | Short   | 8.18   | 4.95  |
| #SN15694   | Long    | 8.53   | 4.95  |



This is the **Boot and Cap** for Rabbits®, Jetta® 77-84 and Scirocco® and Cabriolet® 77-93 etc., with manual transmissions, (it installs under the car) it's **not** the boot you see around your shift lever in the car.

- |                           | DEALER  | US      |
|---------------------------|---------|---------|
| <b>Boot</b> ..... #SN2407 | \$34.30 | \$39.95 |
| <b>Cap</b> ..... #SN2408  | 5.13    | 3.99    |

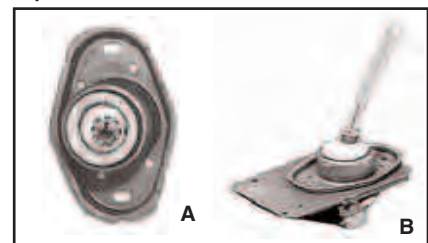

We have the shifter ball assemblies [A] if yours breaks or we have the entire assembly used. They're plastic in the ball joint and they crack often.

Rabbit®, Jetta®, 77-84 Scirocco®, Cabriolet® thru '92.

- |                              | DEALER  | US    |
|------------------------------|---------|-------|
| [A] <b>NEW</b> #SN2410       | \$72.42 | 46.95 |
| [B] <b>Recycled</b> #SN14684 | \$72.42 | 25.00 |

## REAR WIPER ARMS

PART SN#	APPLICATION	DLR \$	OUR \$
13459	RABBIT® '75-84, SCIROCCO® '75-8	24.26	call
16564	GOLF® '85-92 New		19.95
15549	GOLF® '93-99.5 New	29.48	24.95
35211	VANAGON® Recycled		10.00
35473	ALL PASSAT WAGONS '90-97	22.75	call
32902	SCIROCCO® '82-88 Recycled	36.36	18.50

## MISC. WIPER PARTS

PART SN#	PART DESC.	APPLICATION	DLR \$	OUR \$
11409	WINDSHIELD WIPER ROUND PLASTIC CAP	ALL RABBIT®, JETTA®, DASHER®, BU <sup>G</sup> ®, ETC. FROM APPROX. '73-84	3.50	1.75
15670	REAR WIPER ARM CAP	GOLF®/GTI® '93-98	8.67	3.99
14659	WIPER CAP ON ARM	G/J/F MOST '85-92		1.95

# BOSCH

## MICRO EDGE II

**Wiper blades** are an item anyone can replace. The PartsPlace carries Bosch, micro Edge II blades which are the best we've found and original equipment on many European cars. Until recently, Bosch blades were available only as complete assemblies (ie., no refills were available) but the Micro Edge II is refillable at approximately 60% of the price of a new blade. The Bosch blade is clearly superior in fighting smearing, streaking, chatter, lift off and rubber fatigue. It's a great blade. The blade assemblies are sold individually while the refills are sold by the pair. Order by number below.

### MOST BOSCH WIPER BLADES ARE \$5.95

Specific prices are listed below, sold each.

Wiper Blades

Size	Our Part Number	Our Price
40710	SN#3370	7.99
40711	SN#3373	11.95
40713	SN#3374	5.95
40715	SN#3376	5.99
40716	SN#18989	9.99
40718	SN#16333 (Pair)	9.99
40719A	SN#5590	6.99
40720	SN#5589	7.99
40721 NR	SN#13087	9.99



Application	Blade Assembly Our Part No.	Application	Blade Assembly Our Part No.	Application	Blade Assembly Our Part No.
<b>SUPER BEETLE®</b>		<b>SCIROCCO®</b>		<b>DASHER®</b>	
1973-79	.....#SN3376	1982-88 Front	.....#SN5590	1974-81 Front & Rear	.....#SN18989
1970-71	.....#SN3373	1975-88 Rear	.....#SN18989	<b>CABRIOLET®</b>	
<b>REGULAR BUG®</b>		<b>JETTA®</b>		1985-93	.....#SN18989
1965-67	.....#SN3370	1980-92 (except GLI®)	.....#SN18989	<b>QUANTUM®</b>	
1969-79	.....#SN3373	1985-92 GLI®	.....#SN16333 (pair)	1982-88 Front	.....#SN16333 (pair)
<b>THING® 12"</b>		<b>JETTA, GOLF®</b>		Rear	.....#SN3374
Straight blade black with screw	.....#SN3372	1993-2003		<b>VANAGON®</b>	
<b>EARLY BUG®</b>		Driver's side	.....#SN13087	1982-88 Front	.....#SN16333 (pair)
10" straight blade with screw connection	.....#SN3371	Passenger's side	.....#SN5590	Rear	.....#SN18989
<b>KARMANN GHIA®</b>		Rear (Golf®)	.....#SN3374	1968-79 - BUS®	.....#SN18989
1968-74	.....#SN3374	<b>GT® &amp; GLI®</b>		1969-75 - BUS®	.....#SN40716
<b>RABBIT® &amp; PICK-UP</b>		85-87, 91-92 Front	.....#SN16333 (pair)	<b>VW FOX®</b> '87-93	.....#SN18989
1975-84 Front & Rear	.....#SN18989	Rear	.....#SN18989	<b>CORRADO®</b>	
		<b>GOLF® &amp; GT</b>		1990-97 Front	.....#SN13807
		1988-90 Front	.....#SN18989	1990-97 Rear	.....#SN18989
		<b>GOLF® &amp; GT</b>		1998-03 Rear	.....#SN3376
		1985-92 Front & Rear	.....#SN18989		

**REFILLS FOR BLADES** All the cars listed except those with NR after the number can be "REFILLED" with new rubber blades. They just slip in. Refills are sold by the pair and are 20" long which you cut with a knife or razor to length. SN 10228 pair 20" refills \$5.99 (These refills do not fit 21" blades). Order part number, SN10228. It's two refills and instructions. 21" Refills now available! #SN18093 \$7.95/pair.



## All used wiper motors have a 2-year limited warranty

### Windshield Wiper Motors

We have excellent recycled wiper motors for all VWs®

VW® wiper motors usually last forever, but occasionally they jam from ice or worn linkages and burn out. Our recycled ones should last for years! They are a good value. Easy to install.



## WINDSHIELD WIPER TRANSMISSION ASSEMBLIES

Windshield wiper transmission assemblies can jam up unless they're lubricated regularly. If they jam, you can try to lubricate them to get them running. However, if you lubricate them to keep them moving after a jam-up, they can also ruin the brass wiper bushings. If the bushings go bad there's nothing you can do but get another assembly. We sell a complete line of wiper transmission assemblies with mounting plate and pivots, recycled without motors.

WIPER ARMS					
CLR= COLOR B=BLACK/S=SILVER					
SIDE= (D) DRIVER/(P) PASSENGER					
PART SN#	APPLICATION	SIDE	CLR	DLR \$	OUR \$
3208	TYP. 1 '68-69	D=P	b	25.00	20.95
3209	TYP. 1 '70-72	D=P	s	22.43	16.95
13724	TYP. 1 '70-72	D=P	b	22.43	16.95
4668	TYP. 1 SUP. '73-79	D	s	23.63	15.75
11796	GOLF®/JETTA® '85-89	D		29.95	18.95
32688(U)	GOLF®/JETTA® '85-89	D		22.06	15.00
11797	GOLF®/JETTA® '85-89	P		29.95	18.95
34297(U)	GOLF®/JETTA® '85-89	P		25.00	15.00
4667	SUPER BEETLE® '73-79	P		23.63	15.75
14484	GOLF®/JETTA® '90-92	D		32.97	14.95
34298(U)	GOLF®/JETTA® '90-92	D		25.00	10.00
15596	GOLF®/JETTA® '90-92	P		29.95	14.95
34738(U)	GOLF®/JETTA® '90-92	P		22.06	10.00
15167	FOX® '87-93	D		12.38	11.95
34156(U)	FOX® '87-93	D		13.99	10.00
15168	VW Fox® '87-93	P		12.38	11.95
34155(U)	VW Fox® '87-93	P		12.39	10.00
16699	GOLF®/JETTA III® '93-98	D		28.80	19.55
16700	GOLF®/JETTA II® '93-98	P		28.80	19.95
15020	PASSAT® '90-94	P			24.95
16291(U)	PASSAT® '90-94	D			18.00
15021	PASSAT® '90-94	D			24.95
36292	PASSAT® '90-94	D			18.00
16698	PASSAT® '98-00	D=P		24.10	18.00

	DEALER	US
Golf®/Jetta® 1985-92, completely new Motor & Assembly, OEM VW®		
#SN15209	.....250.00	149.95
Passat® 1989-95		
#SN34105 REC	.....250.00	60.00
Scirocco® 1985-88		
#SN32899 REC	.....250.00	75.00
Scirocco® 1975-81		
#SN32885 REC	.....250.00	75.00
Rabbit® 1975-84		
#SN3204 REC	.....153.70	50.00
Golf®/Jetta® 1985-92		
#SN34105 REC	.....193.77	60.00
VW Fox® 1987-93		
#SN34105 REC	.....166.00	60.00
Super Beetle® 1973-79		
#SN32521 REC	.....174.00	60.00
Bus® 1973-79		
#SN32730 REC	.....213.65	75.00
Vanagon®		
#SN34105	.....60.00	
Golf®/Jetta III® 1993-99.5		
#SN37829	.....95.00	
Golf/Jetta IV 99.5(New Motor!)		
#SN20127	.....79.95	

	Our part No.	Your Cost
Type III®	#SN32489	40.00
Type I®, Any 6-volt	#SN32501	40.00
Type I®, '67-69	#SN32500	40.00
Type I®, '70-77, SB '71-72	#SN32498	40.00
Super Beetle® '73-79	#SN33043	40.00
Bus® '68-79	#SN32957	60.00
Vanagon® '80-92	#SN34852	60.00
Scirocco® '77-81	#SN35104	80.00
Scirocco® '82-88	#SN33200	60.00
Quantum® '82-87	#SN33502	40.00
Rabbit®/Jetta® '75-84	#SN32608	40.00
Golf®/Jetta® '85-92	#SN32693	40.00
VW Fox® '82-88	#SN34106	40.00
Passat® '90-97	#SN38957	70.00
Golf®/Jetta® '99.5-04	#SN19994	80.00

We have wiper transmissions for many other applications. Call with your needs!