

NEW★STAR

PARTS COMPONENT GROUP

AIR & HYDRAULIC CATALOG

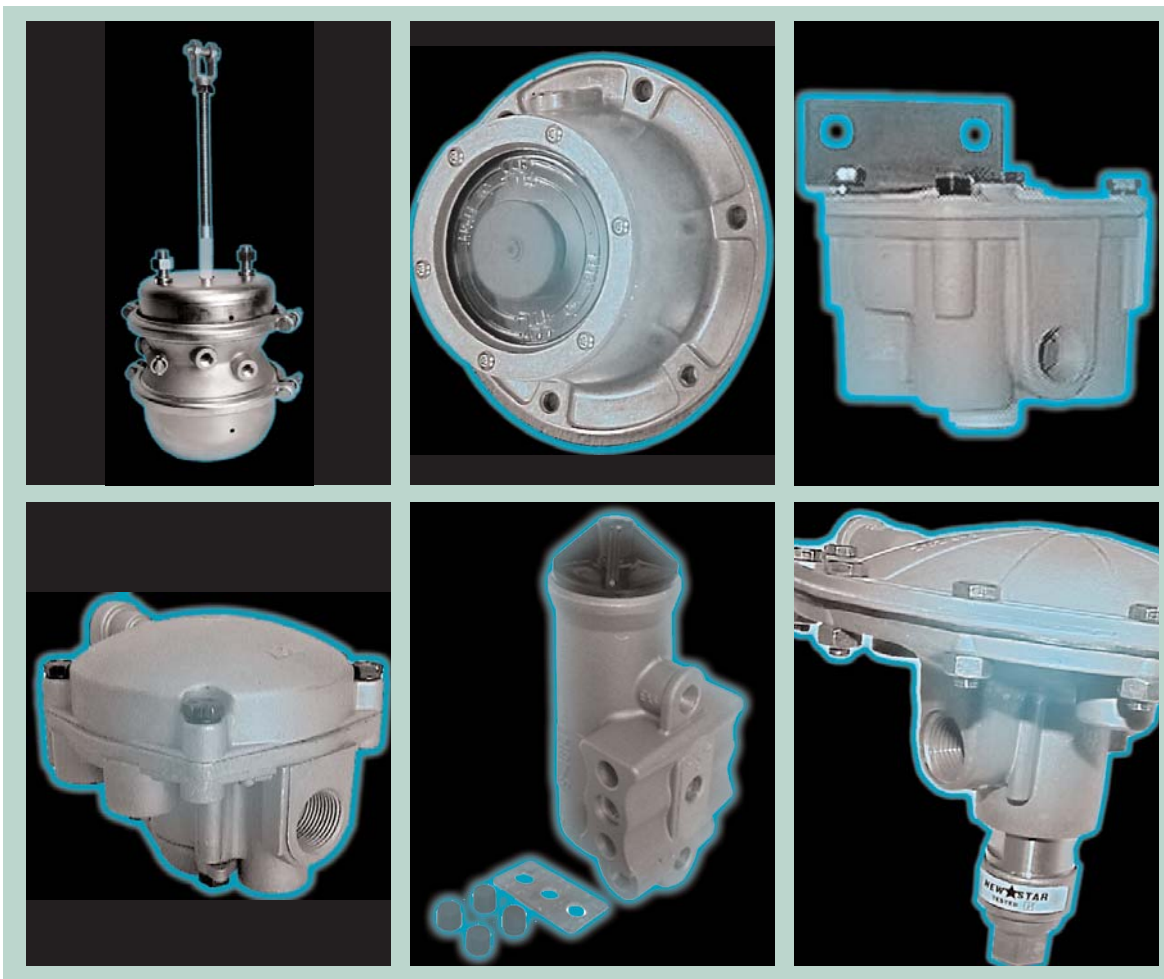

600 W. IRVING PARK ROAD, SCHAUMBURG, ILLINOIS 60193

Local Phone: 847-584-2000

Toll Free Phone: 1-800-621-1553 ORDER DESK

Local Fax: 847-584-3000

Toll Free Fax: 1-800-621-1558

Mexico Toll Free: 001-800-727-8373

E-Mail: INFO@SANDSTRUCK.COM

VISIT OUR WEBSITE AT WWW.SANDSTRUCK.COM

DISCLAIMER

This **NEW★STAR** Air & Hydraulic Catalog provides information on various replacement components offered by S&S Truck Parts, Inc. / **NEW★STAR** Parts Component Group. We have extensively examined the material provided to assure accuracy and reliability. However, this information should only be used to assist the user in identifying the product we are offering as a replacement.

Trademark Acknowledgements

S & S Truck Parts, Inc. / **NEW★STAR** Parts Component Group use of the names of original manufacturers, their models, types, part numbers and other descriptive product information is only for the purpose of aiding customers in cross-referencing to the appropriate S&S/ **NEW★STAR** part. The following is a listing, compiled to the best of our knowledge, of Trademarks used in this catalog for the aforementioned purpose.

ALLISON is a trademark of General Motors Corp.
BARKSDALE is a subsidiary of Crane Co.
BATCO is a brand of Dayton Parts, LLC
BENDIX is a trademark of Bendix Commercial Vehicle Systems, LLC
BERG, MIDLAND, WAGNER, NEWAY are brands of Haldex Brake Systems
BOSCH is a trademark of Robert Bosch Corp.
BOSTROM is a trademark of Bostrom Seating, Inc.
BWP is a brand of Brake & Wheel Parts Industries, Inc.
C/R is a brand of SKF
CHELSEA is a trademark of Parker Hannifin Corp.
CLARK is a brand of Eaton Corp.
CREWSON BRUNNER is a brand of Crewson Industries
CUMMINS is a trademark of Cummins, Inc.
DAF is a trademark of DAF Trucks N.V.
DANA is a trademark of Dana Corp.
DAYTON is a brand of Dayton Parts, LLC
DAYTON WALTHER is a brand of ArvinMeritor Corp.
DELCO is a trademark of General Motors Corp.
DEXTER is a trademark of Dexter Axle Co., Inc.
DIVCO is a trademark of The Divco Club of America, Inc.
DODGE is a trademark of DaimlerChrysler Corp.
EATON is a trademark of Eaton Corp.
EUCLID is a brand of ArvinMeritor Corp.
FMSI is a service mark of Friction Materials Standards Inst., Inc.
FORD is a trademark of Ford Motor Co.
FREIGHTLINER is a trademark of Freightliner Corp.
FRUEHAUF is a trademark of Aurora Trailer Holdings, LLC
FULLER is a brand of Eaton Corp.

GMC is a trademark of General Motors Corp.
GROVER is a trademark of Grover Products, Inc.
GT is a trademark of GT Development Corp.
GUNITE is a trademark of Gunite Corp.
HADLEY is a trademark of Hadley Products Corp.
HENDRICKSON is a trademark of the Boler Company
IKARUS is a trademark of Mogurt KereskedelmiReszvenytarsasag Co.
INTERNATIONAL TRUCK is a trademark of Navistar International Corp.
IVECO is a trademark of Iveco S.P.A.
KENWORTH is a trademark of Paccar, Inc.
KNORR is a trademark of Knorr-Bremse AG
LELAND is a trademark of The Triangle Auto Spring Co.
MACK is a trademark of Mack Trucks, Inc.
MAN is a brand of Man Nutzfahrzeuge
MERCEDES BENZ is a trademark of DaimlerChrysler Corp.
MERITOR is a trademark of ArvinMeritor Corp.
NATIONAL is a brand of Federal Mogul Corp.
NAVISTAR is a trademark of Navistar International Corp.
NEW PROCESS is a trademark of Magna International Inc.
NEWSTAR is a brand of S&S Truck Parts, Inc.
PETERBILT is a trademark of Paccar, Inc.
RVI is a trademark of Renault Vehicules Industriels
SCANIA is a trademark of Scania CV Aktiebolag
SEALCO is a trademark of Sealco Air Controls, Inc.
SPRAGUE is a trademark of Sprague Devices, Inc.
STEMCO is a trademark of Stemco LP
WABCO is a trademark of Wabco GMBH & Co.

TABLE OF CONTENTS - LISTED ALPHABETICALLY

AIR BRAKE DIAPHRAGMS	58	LINKAGE KIT	36
AIR DRYER CARTRIDGES	29	LOW PRESSURE SWITCHES	27-28
AIR DRYER COMPONENTS	29-31	MASTER AND WHEEL CYLINDERS	71
AIR FLIPPER VALVES	44	MISCELLANEOUS VALVES	39
AIR GOVERNORS	1	ON-OFF AIR CONTROL VALVES	25
AIR POSTER	80-81	P.T.O. AIR CONTROL COMPONENTS	40-41
AIR TOGGLE VALVES	43	P.T.O. AIR SHIFT KIT	42
AIR VALVE REPAIR KITS	46-47	PILOT VALVE - 3 WAY	37
AUXILIARY LIFT AXLE VALVE	37	PRESSURE REDUCING VALVES	6
BRAKE CALIPERS	72-73	PRESSURE PROTECTION VALVES	7
BRAKE LIGHT SWITCHES	27	PRESSURE REGULATOR VALVE	8
BRAKE ROTORS	74	QUICK RELEASE VALVES	3
BRAKE SHOE HARDWARE KITS	69	QUICK RELEASE VALVES, IN-LINE	45
BRAKE SHOES, LINED	65-68	RELAY VALVES	9-12
BRAKE VALVES	17-19	RELAY-EMERGENCY VALVES	13-14
CAMSHAFT REPAIR KITS	70	REPLACEMENT EMERGENCY BRAKE SPRING KITS	64
DASH CONTROL VALVES	20-23	SAFETY VALVES	2
DASH SWITCHES	42	SERVICE BRAKE CHAMBERS	57
DOUBLE CHECK VALVES	5	SINGLE CHECK VALVES	4
DOUBLE CHECK VALVES / STOPLITE SWITCH	28	SLACK ADJUSTERS, AUTOMATIC	60
DRAIN VALVES	6	SLACK ADJUSTERS, MANUAL	61
EMERGENCY BRAKE BAND	63	SOLENOID SHIFT VALVES	37-38
EMERGENCY BRAKE SHOES	62	SPRINGBRAKES	56
EMERGENCY BRAKE STRUT	63	SPRINGBRAKE CONTROL VALVES	15-16
EUROPEAN BRAKE VALVES	48-49	TAILGATE LOCK KITS AND PARTS	78
FLIPPER VALVES	44	TOGGLE VALVES	43
FRONT AXLE RATIO VALVES	3	TRACTOR PROTECTION VALVES	26
GLADHANDS	59	TRAILER CONTROL VALVES	19
HEIGHT CONTROL VALVES	32-36	TRANSMISSION AIR VALVES	50-55
HORN VALVES	25	WHEEL BEARINGS	75
HUB CAPS	77	WHEEL SEALS	76
INVERSION VALVES	8		
KNOB AND PIN KITS	24		

QUALITY ASSURANCE

WE MEAN QUALITY.

OUR QUALITY ASSURANCE DEPARTMENT TESTS VALVES EXTENSIVELY ON STATE OF THE ART EQUIPMENT.

OUR CUSTOM ENGINEERED FIXTURES AND TEST FACILITY ENABLE TESTING TO ORIGINAL SPECS FOR POP-OFF, PRESSURE DIFFERENTIAL, AND CRACK PRESSURES AS REQUIRED BY PART NUMBER.

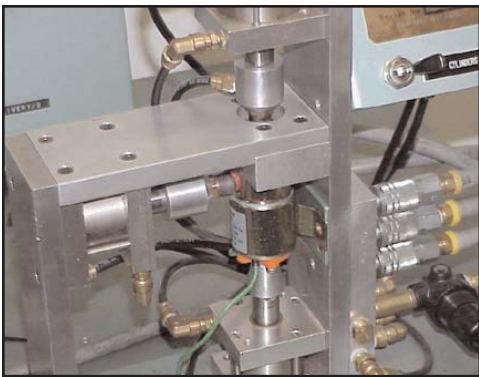
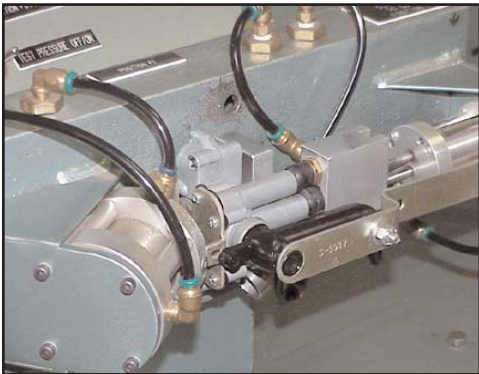

AIR GOVERNORS

REPLACEMENT FOR

BENDIX NUMBER: 275491 D-2

MIDLAND NUMBER: KN-18530

NEWSTAR NO.

S-6106

ALL PORTS 1/8" NPT. INCLUDES
4 PLUGS, MTG. GASKET



AIR GOVERNOR - HIGH TEMP

REPLACEMENT FOR

BENDIX NUMBER: 284358 D-2

MIDLAND NUMBER: KN-18534

NEWSTAR NO.

S-A535

ALL PORTS 1/8" NPT. INCLUDES
4 PLUGS, MTG. GASKET



AIR GOVERNOR - 12 PACK

12 PACK OF S-6106

REPLACEMENT FOR

BENDIX NUMBER: 275491-12 D2

NEWSTAR NO.

S-F496



BOTH **NEWSTAR** GOVERNORS, S-6106 AND S-A535 HAVE PASSED THE
SAE STANDARDS ENDURANCE TEST.

THE SPECIFICATIONS INCLUDE 130 P.S.I. INPUT PRESSURE AND DELIVERY,
EXHAUSTED IN A 4 SECOND CYCLE, 200,000 PLUS TIMES.

LATEST ADDITIONS TO OUR CATALOG

ALL PARTS SUPPLIED ARE S & S/NEWSTAR. USE OF OTHER MANUFACTURERS' NAMES, PART NUMBERS, OR TRADEMARKS ARE FOR INFORMATIONAL AND IDENTIFICATION PURPOSES ONLY. PRICES ARE SUBJECT TO CHANGE OR WITHDRAWAL WITHOUT NOTICE.

SAFETY VALVES



NEW STAR NO.

S-C291

ADJUSTABLE TYPE

REPLACEMENT FOR

BENDIX NUMBER: 205105 ST-1
150 PSI PRESET PRESSURE, 1/4" NPT
ADJUSTABLE

NEW STAR NO.

S-B924

REPLACEMENT FOR

BENDIX NUMBER: 276472 ST-1
125 PSI PRESET PRESSURE, 1/4" NPT
ADJUSTABLE

NEW STAR NO.

S-11607

REPLACEMENT FOR

BENDIX NUMBER: 221154 ST-1
175 PSI PRESET PRESSURE, 1/4" NPT
ADJUSTABLE



NEW STAR NO.

S-7656

REPLACEMENT FOR

BENDIX NUMBER: 284142 ST-3
MIDLAND NUMBERS: KN-31200
KN-31400
1/4" NPT THREAD

S-E023

REPLACEMENT FOR

BENDIX NUMBER: 284143 ST-3
3/8" NPT THREAD
PRESET @ 150 PSI
NON ADJUSTABLE



NEW STAR NO.

S-E859

REPLACEMENT FOR

BENDIX NUMBER: 800350 ST-4
LOW PROFILE FOR AIR DRYERS
PRESET AT 175 PSI
1/4" NPT
NON ADJUSTABLE



NEW STAR NO.

S-C645

ADJUSTABLE TYPE

REPLACEMENT FOR

BENDIX NUMBER: 131081 ST-4
800154 ST-4

PRESET @ 250 PSI
NON ADJUSTABLE
USED FOR AIR COMPRESSORS
1/2" NPT



QUICK RELEASE VALVES

REPLACEMENT FOR BENDIX AND MIDLAND NUMBERS:

229859 QR-1 3/8" NPT SUPPLY- 3/8" NPT DEL.
 288251 QR-1 3/8" NPT SUPPLY- 3/8" NPT DEL.
 KN-32005 3/8" NPT SUPPLY- 3/8" NPT DEL.

BENDIX AND MIDLAND NUMBERS:

229860 QR-1 1/2" NPT SUPPLY- 3/8" NPT DEL.
 KN-32011 1/2" NPT SUPPLY- 3/8" NPT DEL.

BENDIX NUMBER:

229813 QR-1 3/8" NPT SUPPLY- 1/4" NPT DEL.

BENDIX NUMBER:

229844 QR-1 1/2" NPT SUPPLY- 1/4" NPT DEL.

NEWSTAR NO.

S-4922

S-8328

S-A270

S-B073



QUICK RELEASE/DOUBLE CHECK VALVE

REPLACEMENT FOR

BENDIX NUMBER: 289714 QR-1C
 MIDLAND NUMBER: KN-32041

1/4" NPT SUPPLY
 3/8" NPT DELIVERY (2)
 1/4" NPT BALANCE

NEWSTAR NO.

S-9749



LIMITING AND QUICK RELEASE VALVE

FOR FRONT AXLE PRESSURE LIMITING

REPLACEMENT FOR

BENDIX NUMBER: 229505 LQ-2
 MIDLAND NUMBER: KN-32030

3/8" NPT DELIVERY PORTS (2)
 3/8" NPT SUPPLY PORT
 1/4" NPT CONTROL PORT

NEWSTAR NO.

S-C403



FRONT AXLE RATIO VALVES

FOR FRONT AXLE PRESSURE LIMITING

REPLACEMENT FOR

BENDIX NUMBER: 289144 LQ-4
 NOMINAL HOLDOFF PRES. 4 PSI

NEWSTAR NO.

S-9625

REPLACEMENT FOR

BENDIX NUMBER: **289148 LQ-4**
 NOMINAL HOLDOFF PRES. 10 PSI

S-E463



LATEST ADDITIONS TO OUR CATALOG

ALL PARTS SUPPLIED ARE S & S/NEWSTAR. USE OF OTHER MANUFACTURERS' NAMES, PART NUMBERS, OR TRADEMARKS ARE FOR INFORMATIONAL AND IDENTIFICATION PURPOSES ONLY. PRICES ARE SUBJECT TO CHANGE OR WITHDRAWAL WITHOUT NOTICE.

SINGLE CHECK VALVES



NEW STAR NO.	REPLACEMENT FOR BENDIX AND MIDLAND NUMBERS:
S-8444	<ul style="list-style-type: none"> → 227788 SC-2 1/2" NPT X 1/2" NPT → 227871 SC-2 1/2" NPT X 1/2" NPT → 227717 SC-2 1/2" NPT X 1/2" NPT → KN-23000 1/2" NPT X 1/2" NPT
S-8445	<p>BENDIX AND MIDLAND NUMBERS:</p> <ul style="list-style-type: none"> → 227870 SC-2 3/8" NPT X 3/8" NPT → KN-23010 3/8" NPT X 3/8" NPT
S-A275	<p>BENDIX NUMBER:</p> <ul style="list-style-type: none"> → 229603 SC-2 1/4" NPT X 1/4" NPT



NEW STAR NO.	REPLACEMENT FOR MIDLAND NUMBER:
S-A558	KN-23040 3/4" NPT X 3/4" NPT



NEW STAR NO.	REPLACEMENT FOR BENDIX NUMBER:
S-A480	800370 SC-3 1/2" NPT(F) X 1/2" NPT(F) BRASS BODY W/TEFLON INTERNAL VALVE



NEW STAR NO.	REPLACEMENT FOR BENDIX NUMBER:
S-E424	800372 SC-3 1/2" NPTF X 1/2" NPT
S-E598	800373 SC-3 3/8" NPTF X 3/8" NPT
BRASS BODY W/TEFLON INTERNAL VALVE REPLACES ALL SC-1 & SC-2 VALVES	



NEW STAR NO.	REPLACEMENT FOR BENDIX NUMBER:
S-C573	800376 SC-3
MIDLAND NUMBER: KN-23060	
1/2" NPTF INLET	
1/2" NPTM OUTLET	
BRASS BODY W/TEFLON INTERNAL VALVE	
90° ELBOW	



DOUBLE CHECK VALVES

REPLACEMENT FOR

BENDIX NUMBER: 280479 DC-1

217698 DC-1

NEWAY NUMBER: 90054138

INLET PORTS: 2-3/8" NPTF

OUTLET PORTS: 1-3/8" NPTF

NEWSTAR NO.

S-C617



REPLACEMENT FOR

BENDIX NUMBER: 289296 DC-4

MIDLAND NUMBER: KN-25080

INLET PORTS: 1-3/8" NPTF 1-3/8" NPTM

OUTLET PORTS: 1-3/8" NPTF 1-1/4" NPTF

NEWSTAR NO.

S-C572



REPLACEMENT FOR

BENDIX NUMBER: 278614 DC-4

MIDLAND NUMBER: KN-25060

ALL PORTS 3/8" NPT

MAY BE MOUNTED IN ANY POSITION

NEWSTAR NO.

S-A269



LATEST ADDITIONS TO OUR CATALOG

ALL PARTS SUPPLIED ARE S & S/NEWSTAR. USE OF OTHER MANUFACTURERS' NAMES, PART NUMBERS, OR TRADEMARKS ARE FOR INFORMATIONAL AND IDENTIFICATION PURPOSES ONLY. PRICES ARE SUBJECT TO CHANGE OR WITHDRAWAL WITHOUT NOTICE.

DRAIN VALVES



NEW STAR NO.
S-A271

AUTOMATIC
REPLACEMENT FOR

BENDIX NUMBER: 281923 DV-2
MIDLAND NUMBER: KN-24000

ALL PORTS 3/8" NPT
NON-HEATED



NEW STAR NO.
S-D970

AUTOMATIC
REPLACEMENT FOR

BENDIX NUMBER: 284412 DV-2
284795 DV-2
MIDLAND NUMBER: KN-24005
KN-21021

ALL PORTS 3/8" NPT
12 VOLT HEATED



NEW STAR NO.
S-8884

MANUAL
REPLACEMENT FOR

MIDLAND NUMBER: 12105

INCLUDES 5 FOOT (60 INCH) CABLE
1/4" NPT MALE THREAD

PRESSURE REDUCING VALVES



NEW STAR NO.

REPLACEMENT FOR BENDIX NUMBERS:

S-C568	—	283590 RV-1	DEL. PRESSURE 70 PSI
S-D813	—	101135 RV-1	DEL. PRESSURE 85 PSI
S-D871	—	278427 RV-1	DEL. PRESSURE 50 PSI
S-D872	—	288084 RV-1	DEL. PRESSURE 47 PSI
S-D809	—	279015 RV-1	DEL. PRESSURE 42 PSI
S-D696	—	279926 RV-1	DEL. PRESSURE 40 PSI
S-D958	—	281857 RV-1	DEL. PRESSURE 20 PSI

USED WHERE A CONSTANT SET PRESSURE LOWER THAN
A SUPPLY PRESSURE IS REQUIRED.
ADJUSTABLE

PRESSURE PROTECTION VALVES

REPLACEMENT FOR BENDIX NUMBERS:

277147 PR-2 NOM. CLOSING PRES. 65 PSI

277148 PR-2 NOM. CLOSING PRES. 85 PSI

277227 PR-2 NOM. CLOSING PRES. 75 PSI

NEWSTAR NO.

S-D817

S-D822

S-D668



REPLACEMENT FOR BENDIX NUMBER:

286500 PR-4 NOM. CLOSING PRES. 85 PSI

NEWSTAR NO.

S-A273

REPLACEMENT FOR BENDIX NUMBER:

288323 PR-4 NOM. CLOSING PRES. 70 PSI

NEWSTAR NO.

S-B898



REPLACEMENT FOR

MIDLAND NUMBERS: KN-31000

KN-31001

NEWSTAR NO.

S-C089

OPERATING PRESSURES -

OPEN AT 65 PSI

CLOSED AT 45 PSI

1/4" NPT INLET & OUTLET PORTS

ACCY. OUTLET PORTS 1/4" NPT (1) 1/8" NPT (1)



REPLACEMENT FOR

NEWAY NUMBER: 90554107

CHELSEA NUMBER: 378414

NEWSTAR NO.

S-C088

MINIMUM HOLDBACK PRESSURE

65-75 PSI



LATEST ADDITIONS TO OUR CATALOG

ALL PARTS SUPPLIED ARE S & S/NEWSTAR. USE OF OTHER MANUFACTURERS' NAMES, PART NUMBERS, OR TRADEMARKS ARE FOR INFORMATIONAL AND IDENTIFICATION PURPOSES ONLY. PRICES ARE SUBJECT TO CHANGE OR WITHDRAWAL WITHOUT NOTICE.

INVERSION VALVES**NEWSTAR NO.****S-11504****REPLACEMENT FOR**BENDIX NUMBER: **277340 TR-2****NEWSTAR NO.****REPLACEMENT FOR BENDIX NUMBERS:****S-C567** ——— 281459 TR-3 "A" = 25 "B" = 40**S-D816** ——— 281318 TR-3 "A" = 35 "B" = 70**S-D877** ——— 101781 TR-3 "A" = 14 "B" = 16**S-D821** ——— 280758 TR-3 "A" = 45 "B" = 60

WITH COMMON CONTROL AND
SUPPLY PRESSURE INLET OPENS AT "A"
PSI DESCENDING PRES., AND EXHAUST
OPENS AT "B" PSI
ASCENDING PRESSURE

PRESSURE REGULATOR VALVE**NEWSTAR NO.****S-E279****REPLACEMENT FOR**

BENDIX NUMBER: 217380

MIDLAND NUMBERS: KN-31070

ADJUSTABLE FROM 10 PSI TO 125 PSI
ALL PORTS 3/8" NPT

RELAY VALVES

REPLACEMENT FOR

BENDIX NUMBER: 279180 R-6
280375 R-6

1/4" NPT SERVICE PORT
1/2" NPT SUPPLY PORT
3/8" NPT DELIVERY PORTS (4)
CRACK PRESSURE 2 PSI

NEWSTAR NO.

S-5865



REPLACEMENT FOR

BENDIX NUMBER: 279952 R-6

HAS 3/4" NPT SUPPLY PORT
IN MTG. FLANGE
CRACK PRESSURE 2 PSI

NEWSTAR NO.

S-A147



MODULATING

REPLACEMENT FOR

BENDIX NUMBER: 103081 R-7
283932 R-7

SPRINGBRAKE RELEASE PRES. 95 PSI

NEWSTAR NO.

S-A143



REPLACEMENT FOR

BENDIX NUMBER: 286370 R-8
286371 R-8

1/4" NPT SERVICE PORT
3/4" NPT SUPPLY PORTS (2)
1/2" NPT DELIVERY PORTS (2)
CRACK PRESSURE 3 PSI

NEWSTAR NO.

S-9174



LATEST ADDITIONS TO OUR CATALOG

ALL PARTS SUPPLIED ARE S & S/NEWSTAR. USE OF OTHER MANUFACTURERS' NAMES, PART NUMBERS, OR TRADEMARKS ARE FOR INFORMATIONAL AND IDENTIFICATION PURPOSES ONLY. PRICES ARE SUBJECT TO CHANGE OR WITHDRAWAL WITHOUT NOTICE.

RELAY VALVES CONTINUED



NEWSTAR NO.

S-A584

REPLACEMENT FOR

BENDIX NUMBER: 101930 R-8

WILL REPLACE

WABCO NUMBER: 934-702-250-0

ALL PORTS METRIC

CRACK PRESSURE 3 PSI



NEWSTAR NO.

S-6006

VERTICAL PORTS

S-D879

S-D878

REPLACEMENT FOR

BENDIX NUMBER: 102626 R-12
(BASIC VALVE) CRACK PRES. 4 PSI

BENDIX NUMBER: 104561 R-12
CRACK PRES. 5.5 PSI

BENDIX NUMBER: 103912 R-12
CRACK PRES. 7.5 PSI



NEWSTAR NO.

S-6006A

HORIZONTAL PORTS

S-D880

S-D812

REPLACEMENT FOR

BENDIX NUMBER: 103009 R-12
(BASIC VALVE) CRACK PRES. 4 PSI

BENDIX NUMBER: 065125 R-12
CRACK PRES. 5.5 PSI

BENDIX NUMBER: 104165 R-12
CRACK PRES. 7.5 PSI



RELAY VALVES CONTINUED

REPLACEMENT FOR

BENDIX NUMBER: 103028 R-14
(BASIC VALVE) CRACK PRES. 4 PSI

BENDIX NUMBER: 106313 R-14
CRACK PRES. 5.5 PSI

BENDIX NUMBER: 103833 R-14
CRACK PRES. 7.5 PSI

NEW STAR NO.

S-8255A

VERTICAL PORTS

S-D882

S-D881

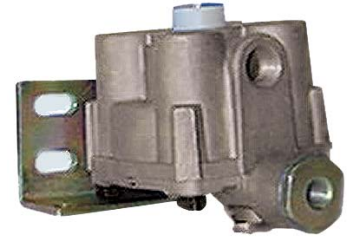

REPLACEMENT FOR

BENDIX NUMBER: 103010 R-14
(BASIC VALVE) CRACK PRES. 4 PSI

BENDIX NUMBER: 103294 R-14
CRACK PRES. 5.5 PSI

BENDIX NUMBER: 103835 R-14
CRACK PRES. 7.5 PSI

NEW STAR NO.

S-8255

HORIZONTAL PORTS

S-A561

S-D883

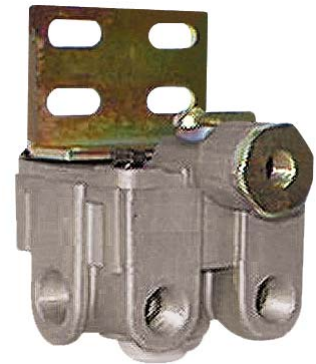

BOBTAIL PROPORTIONING

REPLACEMENT FOR

BENDIX NUMBER: 065145 BP-R1
CRACK PRES. 4 PSI

BENDIX NUMBER: 065146 BP-R1
CRACK PRES. 5.5 PSI

NEW STAR NO.

S-C517

S-C518



LATEST ADDITIONS TO OUR CATALOG

ALL PARTS SUPPLIED ARE S & S/NEWSTAR. USE OF OTHER MANUFACTURERS' NAMES, PART NUMBERS, OR TRADEMARKS ARE FOR INFORMATIONAL AND IDENTIFICATION PURPOSES ONLY. PRICES ARE SUBJECT TO CHANGE OR WITHDRAWAL WITHOUT NOTICE.

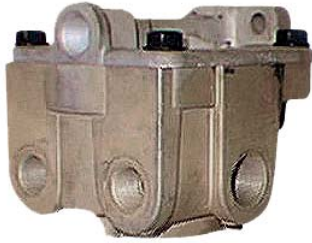
RELAY VALVES CONTINUED**NEWSTAR NO.****S-4898****REPLACEMENT FOR**

MIDLAND NUMBER: KN-28060

1/4" NPT CONTROL PORT
 1/2" NPT SUPPLY (RES.) PORTS(2)
 3/8" DELIVERY PORTS(2)
 CRACK PRES. 4 PSI

**NEWSTAR NO.****S-6085****S-6086****S-6029****REPLACEMENT FOR MIDLAND NUMBERS:**

PORTS	→	RESERVOIR	DELIVERY
S-6085	—	KN-28500 RG-2 3/8"(2)	3/8"(2)
S-6086	—	KN-28510 RG-2 3/8"(1)1/2"(1)	3/8"(2)
S-6029	—	KN-28520 RG-2 1/2"(2)	1/2"(2)

1/4" NPT CONTROL PORT
 CRACK PRES. 5.5 PSI

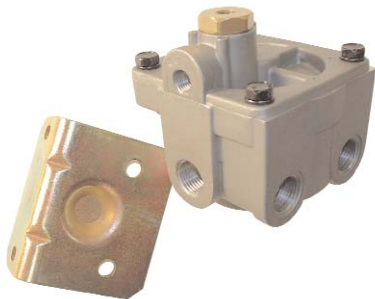
**NEWSTAR NO.****S-6670**

W/ ANTI-COMPOUNDING

REPLACEMENT FORMIDLAND NUMBER: **KN-28071**

1/2" NPT SUPPLY PORTS (2)
 1/2" NPT DELIVERY PORTS (2)
 1/4" NPT CONTROL PORT
 1/8" NPT CONTROL PORT
 INCLUDES MOUNTING BRACKET

RELAY-EMERGENCY VALVES

REPLACEMENT FOR

BENDIX NUMBER: 281865 RE-6
281860 RE-6

1/4" NPT SERVICE PORT
1/4" NPT EMERGENCY PORT
3/4" NPT SUPPLY PORT
3/8" NPT DELIVERY PORTS(2)
1/4" NPT DELIVERY PORTS(2)
CRACK PRES. 4.5 PSI

NEWSTAR NO.

S-7558



SERVICE EMERGENCY RELAY VALVE (SERV)
FOR USE ON PRE-121 TRAILERS
(BEFORE 1974)

REPLACEMENT FOR

MIDLAND NUMBER: 12352

CRACK PRES. 4.5 PSI

NEWSTAR NO.

S-9160



REPLACEMENT FOR

MIDLAND NUMBER: KN-30400

CRACK PRES. 4.5 PSI

NEWSTAR NO.

S-9322



LATEST ADDITIONS TO OUR CATALOG

ALL PARTS SUPPLIED ARE S & S/NEWSTAR. USE OF OTHER MANUFACTURERS' NAMES, PART NUMBERS, OR TRADEMARKS ARE FOR INFORMATIONAL AND IDENTIFICATION PURPOSES ONLY. PRICES ARE SUBJECT TO CHANGE OR WITHDRAWAL WITHOUT NOTICE.

RELAY-EMERGENCY VALVES CONTINUED**NEWSTAR NO.****S-A956****REPLACEMENT FOR**

SEALCO NUMBER: A-1000S

CRACK PRES. 1.5 PSI

**NEWSTAR NO.****S-B284**

EMERGENCY CARTRIDGE

REPLACEMENT FOR

SEALCO NUMBER: 1000-5A

FITS A-1000S VALVE

**NEWSTAR NO.****S-B239****REPLACEMENT FOR**

SEALCO NUMBER: 110200

W/ RATIO FEATURE

CRACK PRES. 4.5 PSI

SPRINGBRAKE CONTROL VALVES

REPLACEMENT FOR
BENDIX NUMBER: 286364 SR-1

BRACKET MOUNTED

NEWSTAR NO.
S-A272



TRAILER SPRINGBRAKE VALVE

REPLACEMENT FOR BENDIX NUMBER:
103061 SR-2 1/2" NPT S.B. RES. PORT

REPLACEMENT FOR BENDIX NUMBER:
287376 SR-2 3/4" NPT S.B. RES. PORT

NEWSTAR NO.
S-A149

S-A150



TRAILER SPRINGBRAKE VALVE

REPLACEMENT FOR BENDIX NUMBER:
101112 SR-4 3/4" NPT S.B. RES. PORT

REPLACEMENT FOR BENDIX NUMBER:
101622 SR-4 1/2" NPT S.B. RES. PORT

NEWSTAR NO.
S-A151

S-A152



LATEST ADDITIONS TO OUR CATALOG

ALL PARTS SUPPLIED ARE S & S/NEWSTAR. USE OF OTHER MANUFACTURERS' NAMES, PART NUMBERS, OR TRADEMARKS ARE FOR INFORMATIONAL AND IDENTIFICATION PURPOSES ONLY. PRICES ARE SUBJECT TO CHANGE OR WITHDRAWAL WITHOUT NOTICE.

SPRINGBRAKE CONTROL VALVES CONTINUED



NEWSTAR NO.

S-A142

TRAILER SPRINGBRAKE VALVE

REPLACEMENT FOR

BENDIX NUMBER: 065437 SR-5

3/4" NPT S.B. RES. PORT



NEWSTAR NO.

S-A530

MULTI-FUNCTION TRAILER VALVE

REPLACEMENT FOR

MIDLAND NUMBER: KN-26000

PPV CLOSING PRES. 70 PSI

CRACK PRES. 4 PSI

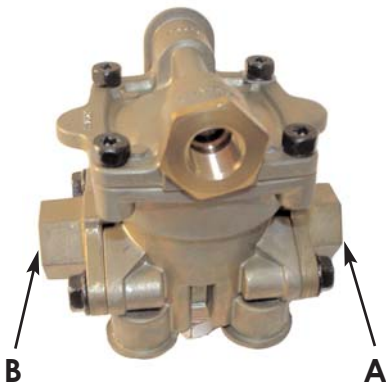

NEWSTAR NO.

S-11417

S-11418

S-11419

S-11420

S-11421

REPLACEMENT FOR SEALCO NUMBER:

110170 PORT 'A' 1/2" NPT PORT 'B' 1/2" NPT - COVER AS SHOWN

110171 PORT 'A' 1/2" NPT PORT 'B' 3/8" NPT - COVER 90° CW

110191 PORT 'A' 3/8" NPT PORT 'B' 1/2" NPT - COVER 90° CW

110310 PORT 'A' 3/8" NPT PORT 'B' 1/2" NPT - COVER AS SHOWN

110315 PORT 'A' 1/2" NPT PORT 'B' 3/8" NPT - COVER AS SHOWN

PPV CLOSING PRES. 70 PSI

CRACK PRESSURE 4 PSI

BRAKE VALVES

REPLACEMENT FOR

BENDIX NUMBER: 277863 E-3
MIDLAND NUMBER: KN-22100

1/2" NPT SUPPLY PORTS(2)
1/4" NPT AUXILIARY PORTS(2)
1/2" NPT DELIVERY PORTS(4)
SINGLE CIRCUIT VALVE

NEWSTAR NO.

S-8361



REPLACEMENT FOR

BENDIX NUMBER: 279950 E-5

SINGLE CIRCUIT VALVE
SUSPENDED PEDAL ACTIVATION

NEWSTAR NO.

S-E692



REPLACEMENT FOR

BENDIX NUMBER: 286171 E-6
MIDLAND NUMBER: KN-22140
MIDLAND NUMBER: KN-22150

3/8" NPT SUPPLY PORTS(4)
3/8" NPT DELIVERY PORTS(4)
DUAL CIRCUIT VALVE

NEWSTAR NO.

S-4771



BRAKE VALVE TREADLE ASSY

REPLACEMENT FOR

BENDIX NUMBER: 275747
MIDLAND NUMBER: SN-4017A

INCLUDES MOUNTING BRACKET &
TREADLE ASSY.
PEDAL ANGLE 45 DEGREES

NEWSTAR NO.

S-11201



LATEST ADDITIONS TO OUR CATALOG

ALL PARTS SUPPLIED ARE S & S/NEWSTAR. USE OF OTHER MANUFACTURERS' NAMES, PART NUMBERS, OR TRADEMARKS ARE FOR INFORMATIONAL AND IDENTIFICATION PURPOSES ONLY. PRICES ARE SUBJECT TO CHANGE OR WITHDRAWAL WITHOUT NOTICE.

BRAKE VALVES CONTINUED**NEWSTAR NO.****S-A146****REPLACEMENT FOR**

BENDIX NUMBER: 284760 E-7

FIREWALL MTD. (FORD)
DUAL CIRCUIT VALVE**NEWSTAR NO.****S-C571****S-E576****REPLACEMENT FOR BENDIX NUMBER:**

288383 E-7 SIDE DEL.PORTS 1/4" NPT

101818 E-7 SIDE DEL.PORTS 3/8" NPT

FIREWALL MTD. (INTERNATIONAL TRUCK)
DUAL CIRCUIT VALVE**NEWSTAR NO.****S-E694****REPLACEMENT FOR**

BENDIX NUMBER: 800629 E-8P

065313 E-8P

800583 E-8P

PARALLEL PORTS
DUAL CIRCUIT VALVE**NEWSTAR NO.****S-11505****REPLACEMENT FOR**

BENDIX NUMBER: 110100 E-10

MAINLY USED ON BUS APPLICATIONS
DUAL CIRCUIT VALVE

BRAKE VALVES CONTINUED

REPLACEMENT FOR

BENDIX NUMBER: 800632 E-10P
065315 E-10P
800318 E-10P

PARALLEL PORTS PRIMARILY
USED ON BUSES
DUAL CIRCUIT VALVE

NEWSTAR NO.

S-E630



TRAILER CONTROL VALVES

REPLACEMENT FOR

MIDLAND NUMBER: KN-20541
INTERNATIONAL TRUCK NUMBER:
476356C92

INTERNATIONAL TRUCK
"IN-COLUMN" MOUNT
ALL PORTS 1/4" NPT

NEWSTAR NO.

S-A140



REPLACEMENT FOR

BENDIX NUMBER: 276270 TC-2
275107 TC-2
275509 TC-2

INCLUDES CLAMP & BOLTS

NEWSTAR NO.

S-10277



LATEST ADDITIONS TO OUR CATALOG

ALL PARTS SUPPLIED ARE S & S/NEWSTAR. USE OF OTHER MANUFACTURERS' NAMES, PART NUMBERS, OR TRADEMARKS ARE FOR INFORMATIONAL AND IDENTIFICATION PURPOSES ONLY. PRICES ARE SUBJECT TO CHANGE OR WITHDRAWAL WITHOUT NOTICE.

DASH CONTROL VALVES



NEW STAR NO.

S-5675

REPLACEMENT FOR

BENDIX NUMBERS: 276567 PP-1
275175 PP-1
276566 PP-1

MIDLAND NUMBER: KN-20021
ALL PORTS 1/8" NPT

NEW STAR NO.

S-8898

BENDIX NUMBERS: 287600 PP-1
287417 PP-1

SAME AS ABOVE EXCEPT
DEL. PORTS 1/4" NPT DEL. PORTS

NEW STAR NO.

S-A560

BENDIX NUMBER: 278450 PP-1
0 PSI 'POP' PRESSURE

"POPS" AT 40 PSI



NEW STAR NO.

S-A267

REPLACEMENT FOR

BENDIX NUMBERS: 281587 PP-1
279786 PP-1

"POPS" AT 40 PSI
1/4"-20 FEMALE THREAD FOR
KNOB OR CABLE



NEW STAR NO.

S-A268

REPLACEMENT FOR

BENDIX NUMBERS: 276462 PP-2
275250 PP-2

"POPS" AT 40 PSI
ALL PORTS 1/8" NPT



NEW STAR NO.

S-A144

REPLACEMENT FOR

BENDIX NUMBERS: 279787 PP-3
"POPS" AT 40 PSI

1/4"-20 FEMALE THREAD FOR
KNOB OR CABLE



DASH CONTROL VALVES CONTINUED

REPLACEMENT FOR

BENDIX NUMBER: 288746 PP-3
 "POPS" AT 40 PSI

NEWSTAR NO.

S-A145



REPLACEMENT FOR

BENDIX NUMBERS: 288239 PP-7
 288721 PP-7
 MIDLAND NUMBER: KN-20025

NEWSTAR NO.

S-5677

3/8" DIA. SHAFT
 "POPS" AT 40 PSI
 NON-OVERRIDE 25 PSI



REPLACEMENT FOR

BENDIX NUMBERS: 287049 PP-7
 INCLUDES KNOB KIT & MTG. NUT

NEWSTAR NO.

S-B499

REPLACEMENT FOR

BENDIX NUMBER: 288241 PP-7
 106113 PP-7

NEWSTAR NO.

S-B285

5/16" DIA. SHAFT
 "POPS" AT 40 PSI-NON OVERRIDE 25 PSI



REPLACEMENT FOR

COMPLETE ASSY. NUMBERS
 BENDIX NUMBER: 288242 PP-7

NEWSTAR NO.

S-B286

1/2" DIA. SHAFT
 W/1/4"-20 FEMALE THREAD
 FOR KNOB OR CABLE
 "POPS" AT 40 PSI-NON-OVERRIDE 25 PSI



LATEST ADDITIONS TO OUR CATALOG

ALL PARTS SUPPLIED ARE S & S/NEWSTAR. USE OF OTHER MANUFACTURERS' NAMES, PART NUMBERS, OR TRADEMARKS ARE FOR INFORMATIONAL AND IDENTIFICATION PURPOSES ONLY. PRICES ARE SUBJECT TO CHANGE OR WITHDRAWAL WITHOUT NOTICE.



DASH CONTROL VALVES CONTINUED



NEWSTAR NO.

S-9169

REPLACEMENT FOR

BENDIX NUMBER: 287238 PP-8

MIDLAND NUMBER: KN-20035

“POPS” AT 20 PSI ALL PORTS 1/8” NPT



NEWSTAR NO.

S-10129

REPLACEMENT FOR

BENDIX NUMBER: 281946 PP-5

“POPS” AT 40 PSI
WITH PILOT AIR PRESSURE RELEASE
AT 18 PSI
INCLUDES MTG. NUT AND BOOT



NEWSTAR NO.

S-9795

BENDIX NUMBER: 065157 MV-3

800516 MV-3

COMBINATION PP-1 & PP-7 CLUSTER
OFFERED AS GENUINE ONLY



NEWSTAR NO.

S-11529

REPLACEMENT FOR

MIDLAND NUMBER: KN-20615

1/4” MOUNTING HOLES (4) W/ NO THREADS

DASH CONTROL VALVES CONTINUED

REPLACEMENT FOR
MIDLAND NUMBER: **KN-20611**

1/4" - 20 THREADS (4)
IN MOUNTING HOLES

NEWSTAR NO.

S-11528



REPLACEMENT FOR PUSH-PULL

MIDLAND NUMBER: KN-20031
KN-20030

"POPS" AT 25-35 PSI

MIDLAND NUMBER: KN-20033
"POPS" AT 7-17 PSI

ALL PORTS 1/4" NPT

NEWSTAR NO.

S-A276

S-C734



REPLACEMENT FOR

BENDIX NUMBER: 229635 TW-1
229617 TW-1

MIDLAND NUMBER: KN-20001

ALL PORTS 1/8" NPT
INCLUDES CHROME PLATED FLIP HANDLE

NEWSTAR NO.

S-5676



LATEST ADDITIONS TO OUR CATALOG

ALL PARTS SUPPLIED ARE S & S/NEWSTAR. USE OF OTHER MANUFACTURERS' NAMES, PART NUMBERS, OR TRADEMARKS ARE FOR INFORMATIONAL AND IDENTIFICATION PURPOSES ONLY. PRICES ARE SUBJECT TO CHANGE OR WITHDRAWAL WITHOUT NOTICE.

KNOB AND PIN KITS



NEW STAR NO.

S-9623

REPLACEMENT FOR

BENDIX NUMBER: 290655
MIDLAND NUMBER: KN-20900
FITS 3/8" SHAFT



NEW STAR NO.

S-9256

REPLACEMENT FOR

BENDIX NUMBER: 291054
FITS 5/16" SHAFT



NEW STAR NO.

S-9624

REPLACEMENT FOR

BENDIX NUMBER: 248433
MIDLAND NUMBER: KN-20901
FITS 3/8" SHAFT



NEW STAR NO.

S-A522
SAME AS S-9624 ONLY
1 1/4" SQUARE

REPLACEMENT FOR

BENDIX NUMBER: 248502
MIDLAND NUMBER: KN-20903
FITS 3/8" SHAFT



NEW STAR NO.

S-A591

REPLACEMENT FOR

BENDIX NUMBER: 241866
FITS 3/8" SHAFT



NEW STAR NO.

S-A888

REPLACEMENT FOR

BENDIX NUMBER: 240302
FITS 3/8" SHAFT



NEW STAR NO.

S-9195

MOUNTING NUT FOR BENDIX AND MIDLAND PP VALVES

REPLACEMENT FOR

BENDIX NUMBER: 239357



NEW STAR NO.

S-C562

REPLACEMENT FOR

MIDLAND NUMBER: A-25079
SEALCO NUMBER: 0190
1/4 - 28 THREAD (METAL)

HORN VALVES

REPLACEMENT FOR
BENDIX NUMBER: 228928 HV-3

NEWSTAR NO.
S-C566



REPLACEMENT FOR
GROVER NUMBER: 1630

NEWSTAR NO.
S-C459



ON - OFF AIR CONTROL VALVES

REPLACEMENT FOR
MACK NUMBER: 20-QE-39311

NEWSTAR NO.
S-C563



REPLACEMENT FOR
NEWAY/ HALDEX NUMBER:
90054088

NEWSTAR NO.
S-F174

SUPPLIES PILOT PRESSURE TO
DUMP VALVES, PILOT VALVES OR OTHER
BASIC ACCESSORIES



LATEST ADDITIONS TO OUR CATALOG

ALL PARTS SUPPLIED ARE S & S/NEWSTAR. USE OF OTHER MANUFACTURERS' NAMES, PART NUMBERS, OR TRADEMARKS ARE FOR INFORMATIONAL AND IDENTIFICATION PURPOSES ONLY. PRICES ARE SUBJECT TO CHANGE OR WITHDRAWAL WITHOUT NOTICE.

TRACTOR PROTECTION VALVES**NEW★STAR NO.****S-8887****REPLACEMENT FOR**

BENDIX NUMBER: 279000 TP-3
1/4" NPT TRACTOR EMER.
3/8" NPT TRACTOR SERVICE
1/2" NPT TRAILER EMER.
1/2" NPT TRAILER SERVICE

**NEW★STAR NO.****S-A274****REPLACEMENT FOR**

BENDIX NUMBER: 288605 TP-5
FORMERLY VM-2 CONTROL VALVE
MANIFOLD

**NEW★STAR NO.****S-11452****REPLACEMENT FOR**

MIDLAND NUMBER: **KN-34110**
3/8" NPT TRACTOR EMER. PORT
3/8" NPT FOOT VALVE #1 PORT
3/8" NPT FOOT VALVE #2 PORT
3/8" NPT HAND CONTROL PORT
1/4" NPT STOP LITE SWITCH #1 PORT
1/2" NPT TRAILER SERVICE PORT
1/2" NPT TRAILER EMER. PORT
EXHAUST TUBE INCLUDED

BRAKE LIGHT SWITCHES

REPLACEMENT FOR
 BENDIX AND MIDLAND
 BRAKE LIGHT SWITCHES
 1/4" NPT SUPPLY
 ACTUATES AT 3-5 PSI
 SEALED NON-REBUILDABLE STYLE

NEW STAR NO.
S-4719



REPLACEMENT FOR
 INTERNATIONAL TRUCK NUMBER:
598860C1
 1/4" NPT SUPPLY PORT
 BLADE TYPE TERMINALS (2)
 ACTIVATES AT 3-5 PSI
 SEALED NON REBUILDABLE
 STYLE

NEW STAR NO.
S-9093



REPLACEMENT FOR
 BENDIX NUMBER: 228600 SL-4
 1/4" NPT SUPPLY
 ACTUATES AT 3-5 PSI
 BENDIX STYLE

NEW STAR NO.
S-A264



LOW PRESSURE SWITCHES

REPLACEMENT FOR
 BENDIX AND MIDLAND
 LOW PRESSURE SWITCHES
 1/4" NPT SUPPLY PORT
 ACTUATES AT 60 PSI
 SINGLE TERMINAL
 SEALED NON-REBUILDABLE STYLE

NEW STAR NO.
S-4817



REPLACEMENT FOR
 INTERNATIONAL TRUCK NUMBER:
1658820C1
 1/8" NPT SUPPLY PORT
 ACTUATES AT 65-75 PSI
 SINGLE TERMINAL
 SEALED NON REBUILDABLE STYLE

NEW STAR NO.
S-9127



LATEST ADDITIONS TO OUR CATALOG

ALL PARTS SUPPLIED ARE S & S/NEWSTAR. USE OF OTHER MANUFACTURERS' NAMES, PART NUMBERS, OR TRADEMARKS ARE FOR INFORMATIONAL AND IDENTIFICATION PURPOSES ONLY. PRICES ARE SUBJECT TO CHANGE OR WITHDRAWAL WITHOUT NOTICE.

LOW PRESSURE SWITCHES**NEWSTAR NO.****S-A266****REPLACEMENT FOR**

BENDIX NUMBER: 279416 LP-3

1/4" NPT SUPPLY

ACTUATES AT 60 PSI

SINGLE TERMINAL BENDIX STYLE

**NEWSTAR NO.****S-A265****S-D482****S-D973****S-D814****S-D815****REPLACEMENT FOR**

BENDIX NUMBERS:

228750 LP-3 - ACTUATES AT 60 PSI

101670 LP-3 - ACTUATES AT 70 PSI

276599 LP-3 - ACTUATES AT 30 PSI

277155 LP-3 - ACTUATES AT 50 PSI

284793 LP-3 - ACTUATES AT 80 PSI

DOUBLE TERMINAL BENDIX STYLE

DOUBLE CHECK VALVES AND STOPLITE SWITCH**NEWSTAR NO.****S-C565****REPLACEMENT FOR**

BENDIX NUMBER: 228165 DS-1

INLETS : 1-3/8" NPTM 1-3/8" NPTF

OUTLET: 3/8" NPTF

**NEWSTAR NO.****S-C570****REPLACEMENT FOR**

BENDIX NUMBER: 286453 DS-2

INLETS : 1-3/8" NPTM 1-3/8" NPTF

OUTLET: 3/8" NPTF

AIR DRYER CARTRIDGES

REPLACEMENT FOR

BENDIX NUMBER: 109994
5008414
(FITS AD-SP TYPE)

ARVIN MERITOR NM: R950011
(FITS SYSTEM SAVER 1200)

WABCO NUMBER: 432-420-220-2
432-410-020-2

KNORR NUMBER: I-85127-004

BOSCH NUMBER: I-487-434-901

INCLUDES SEAL RINGS
NEW CARTRIDGE-SOLD OUTRITE
NO CORE CHARGES

NEWSTAR NO.

S-A323
REPL. CARTRIDGE
S-11611
O.E. CARTRIDGE
WABCO/KNORR



REPLACEMENT FOR

BENDIX NUMBER: 103981
104358

INCLUDES SEAL RING KIT
NEW CARTRIDGE-SOLD OUTRITE
NO CORE CHARGES
FITS MODEL AD-4

NEWSTAR NO.

S-A473



REPLACEMENT FOR

BENDIX NUMBER: 107794
107796

INCLUDES SEAL RING RING KIT
NEW CARTRIDGE-SOLD OUTRITE
NO CORE CHARGES
FITS MODEL AD-9

NEWSTAR NO.

S-A474



AIR DRYER COMPONENTS

CHECK VALVE

REPLACEMENT FOR

BENDIX NUMBER: 107799

3/4" NPT
FITS AD-9 AIR DRYERS

NEWSTAR NO.

S-E856



CHECK VALVE

REPLACEMENT FOR

BENDIX NUMBER: 107800

1/2" NPT
FITS AD-9 AIR DRYERS

NEWSTAR NO.

S-E857



LATEST ADDITIONS TO OUR CATALOG

ALL PARTS SUPPLIED ARE S & S/NEWSTAR. USE OF OTHER MANUFACTURERS' NAMES, PART NUMBERS, OR TRADEMARKS ARE FOR INFORMATIONAL AND IDENTIFICATION PURPOSES ONLY. PRICES ARE SUBJECT TO CHANGE OR WITHDRAWAL WITHOUT NOTICE.

AIR DRYER COMPONENTS CONTINUED**NEWSTAR NO.****S-A568****PURGE VALVE KIT**
REPLACEMENT FORBENDIX NUMBER: 5005037
5004336
5004337
107798INCLUDES PURGE PISTON ASSY.
FITS MODEL AD-9**NEWSTAR NO.****S-D810****S-E278****PURGE VALVE ASSY. KIT**
REPLACEMENT FORBENDIX NUMBERS:
800405 - 12 VOLT (W/WHITE COVER)
5004338 - 24 VOLT (W/GREY COVER)INCLUDES PURGE VALVE KIT
HEATER/THERMOSTAT KIT &
PURGE HOUSING
FITS MODEL AD-9**NEWSTAR NO.****S-E859****SAFETY VALVE**
REPLACEMENT FORBENDIX NUMBER: 800350 ST-4
LOW PROFILE FOR AIR DRYERS
PRESET AT 175 PSI
1/4" NPT**NEWSTAR NO.****S-E859****WIRING HARNESS FOR AIR DRYERS**
REPLACEMENT FORBENDIX NUMBERS: 109869
109871
298948FITS AD-9, ADSP, ADIP, R955205
AIR DRYERS

AIR DRYER COMPONENTS CONTINUED

HEATER / THERMOSTAT KIT REPLACEMENT FOR

BENDIX NUMBER: 109578 - 12 VOLT
109579 - 24 VOLT

FITS MODEL AD-9

WHITE COVER DENOTES 12 VOLT
GREY COVER DENOTES 24 VOLT

NEWSTAR NO.
S-C680
S-E277



HEATER / THERMOSTAT KIT REPLACEMENT FOR

BENDIX NUMBER: 109495
INCLUDES SEAL RINGS
HEATER / THERMOSTAT ASSY.
HDWR.
12 VOLT
FITS MODEL ADSP & ADIP

NEWSTAR NO.
S-E854



HEATER / THERMOSTAT KIT REPLACEMENT FOR

BENDIX NUMBER: 109496
INCLUDES SEAL RINGS
HEATER / THERMOSTAT ASSY.
HDWR.
24 VOLT
FITS MODEL ADSP & ADIP

NEWSTAR NO.
S-E855



LATEST ADDITIONS TO OUR CATALOG

ALL PARTS SUPPLIED ARE S & S/NEWSTAR. USE OF OTHER MANUFACTURERS' NAMES, PART NUMBERS, OR TRADEMARKS ARE FOR INFORMATIONAL AND IDENTIFICATION PURPOSES ONLY. PRICES ARE SUBJECT TO CHANGE OR WITHDRAWAL WITHOUT NOTICE.

HEIGHT CONTROL VALVES



NEW STAR NO.

S-9978

REPLACEMENT FOR

MIDLAND NUMBER: KN-27000

ALL PORTS 1/4" NPT

INCLUDES LINKAGE KIT

IMMEDIATE RESPONSE

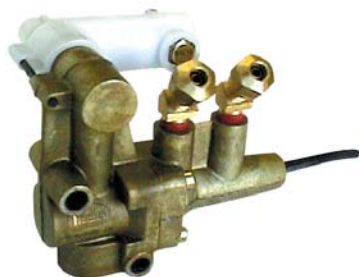

NEW STAR NO.

S-8481

REPLACEMENT FOR

MACK NUMBER:

20-QE-3126-P2

HADLEY NUMBER:

H-00450-AJ

ALL PORTS 1/8" NPT

INCLUDES FITTINGS



NEW STAR NO.

S-8692

REPLACEMENT FOR

MACK NUMBER:

20-QE-3191

HADLEY NUMBER:

H-00450-AM

ALL PORTS 1/8" NPT

INCLUDES FITTINGS



NEW STAR NO.

S-E878

REPLACEMENT FOR

DELCO NUMBER:

5549706

22063228

12C-6-2

DELCO STYLE 7/16" - 24 THREADS



NEW STAR NO.

S-E883

REPLACEMENT FOR

DELCO NUMBER:

22069066

22069147

DELCO STYLE 1/4" NPT THREADS

HEIGHT CONTROL VALVES CONTINUED

REPLACEMENT FOR

DELCO NUMBER: 4992908
22062525
DELCO STYLE 1/4" NPT THREADS

NEWSTAR NO.

S-E880



REPLACEMENT FOR

DELCO NUMBER: 5549705
22062524
12C-6-1
DELCO STYLE 7/16" - 24 THREADS

NEWSTAR NO.

S-E884

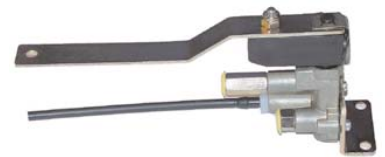

REPLACEMENT FOR

DELCO NUMBER: 5549703
22063226
DELCO STYLE 1/4" NPT THREADS

NEWSTAR NO.

S-E882

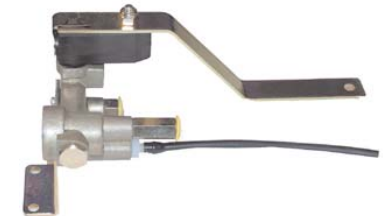

REPLACEMENT FOR

DELCO NUMBER: 5549704
22063227
DELCO STYLE 7/16" - 24 THREADS

NEWSTAR NO.

S-E881



REPLACEMENT FOR

DELCO NUMBER: 4992909
22062523
DELCO STYLE 1/4" NPT THREADS

NEWSTAR NO.

S-E879



LATEST ADDITIONS TO OUR CATALOG

ALL PARTS SUPPLIED ARE S & S/NEWSTAR. USE OF OTHER MANUFACTURERS' NAMES, PART NUMBERS, OR TRADEMARKS ARE FOR INFORMATIONAL AND IDENTIFICATION PURPOSES ONLY. PRICES ARE SUBJECT TO CHANGE OR WITHDRAWAL WITHOUT NOTICE.

HEIGHT CONTROL VALVES CONTINUED

NEWSTAR NO.
S-E844

REPLACEMENT FOR

HADLEY NUMBER: H500CB
PETERBILT APPLICATIONS
INCLUDES BRACKETS & FITTINGS

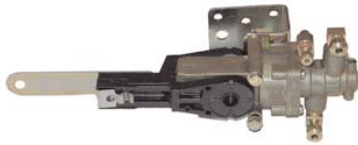

NEWSTAR NO.
S-E847

REPLACEMENT FOR

HADLEY NUMBER: H500CG
KENWORTH APPLICATIONS
INCLUDES BRACKETS & FITTINGS

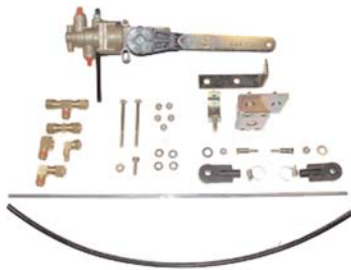

NEWSTAR NO.
S-E846

REPLACEMENT FOR

HADLEY NUMBER: H500FS
FREIGHTLINER APPLICATIONS
INCLUDES BRACKETS & FITTINGS



NEWSTAR NO.
S-E845

REPLACEMENT FOR

HADLEY NUMBER: H500CF
MACK APPLICATIONS
INCLUDES BRACKETS & FITTINGS



NEWSTAR NO.
S-F316

REPLACEMENT FOR

HADLEY NUMBER: H600
INCLUDES BRACKETS & FITTINGS

HEIGHT CONTROL VALVES CONTINUED

REPLACEMENT FOR

MIDLAND / HALDEX / NEWAY NUMBER:
90554241

IMMEDIATE RESPONSE
ALL PORTS 1/4" NPT

NEWSTAR NO.
S-9434



REPLACEMENT FOR

MIDLAND / HALDEX / NEWAY NUMBER:
90554271

IMMEDIATE RESPONSE INCLUDES
BUILT-IN DUMP VALVE
ALL PORTS 1/4" NPT
DUMP FEATURE: NORMALLY OPEN-NEEDS AIR
PRESSURE TO DUMP AIR
FROM AIRSPRINGS

NEWSTAR NO.
S-E693



REPLACEMENT FOR

INTERNATIONAL TRUCK NUMBERS:
574696C91
1670556C91

HADLEY NUMBERS: H-00450-CE
H-00450-CR

ALL PORTS 1/8" NPT
INCLUDES BRACKETS, ARM & FITTINGS

NEWSTAR NO.
S-5965



REPLACEMENT FOR

HADLEY NUMBER: H500HCV
WITH INTEGRAL DUMP SYSTEM
INCLUDES STANDARD ARM

NEWSTAR NO.
S-A194



LATEST ADDITIONS TO OUR CATALOG

ALL PARTS SUPPLIED ARE S & S/NEWSTAR. USE OF OTHER MANUFACTURERS' NAMES, PART NUMBERS, OR TRADEMARKS ARE FOR INFORMATIONAL AND IDENTIFICATION PURPOSES ONLY. PRICES ARE SUBJECT TO CHANGE OR WITHDRAWAL WITHOUT NOTICE.

HEIGHT CONTROL VALVES CONTINUED



NEWSTAR NO.

S-8718

REPLACEMENT FOR

NEWAY LEVELING VALVE NUMBER:
90054007

ALL PORTS 1/8" NPT
INCLUDES FITTING PACKAGE



NEWSTAR NO.

S-E978

REPLACEMENT FOR

HENDRICKSON / BARKSDALE:
57977-000
60826-000

LINKAGE KIT



NEWSTAR NO.

S-C322

REPLACEMENT FOR

NEWAY NUMBER: SRK168
FITS NEWAY 90054007 SERIES VALVE

PILOT VALVE - 3 WAY

REPLACEMENT FOR
NEWAY NUMBER: 90054079

NEWSTAR NO.
S-C292



REPLACEMENT FOR
NEWAY NUMBER: 90554615

NEWSTAR NO.
S-10350



AUXILIARY LIFT AXLE VALVE

REPLACEMENT FOR
NEWAY NUMBER: K910058
MANUAL 2 POSITION

NEWSTAR NO.
S-11200



SOLENOID SHIFT VALVES

12 VOLT
REPLACEMENT FOR
NEWAY NUMBER: 90554662
K910014
OPERATES AUX. LIFT AXLE

NEWSTAR NO.
S-E464



12 VOLT
REPLACEMENT FOR
NEWAY NUMBER: 90054075
NORMALLY OPEN

NEWSTAR NO.
S-C293



LATEST ADDITIONS TO OUR CATALOG

ALL PARTS SUPPLIED ARE S & S/NEWSTAR. USE OF OTHER MANUFACTURERS' NAMES, PART NUMBERS, OR TRADEMARKS ARE FOR INFORMATIONAL AND IDENTIFICATION PURPOSES ONLY. PRICES ARE SUBJECT TO CHANGE OR WITHDRAWAL WITHOUT NOTICE.

SOLENOID SHIFT VALVES CONTINUED



NEWSTAR NO.

S-8931

12 VOLT

REPLACEMENT FOR

MIDLAND NUMBER: KN-68230

EATON NUMBER: 46805

NORMALLY CLOSED

NEWSTAR NO.

S-9367

24 VOLT

REPLACEMENT FOR

MIDLAND NUMBER: KN-68237

NORMALLY CLOSED



NEWSTAR NO.

S-8288

FUEL SOLENOID VALVE

REPLACEMENT FOR

CUMMINS NUMBER: 3035342

BM-69973

12 VOLT

NEWSTAR NO.

S-9366

FUEL SOLENOID VALVE

REPLACEMENT FOR

CUMMINS NUMBER: 3035344

BM-69973-24

24 VOLT

MISCELLANEOUS VALVES

WIPER CONTROL VALVE

REPLACEMENT FOR

SPRAGUE GK-4 AND
INTERNATIONAL TRUCK NUMBER:
1653421C91

ALL PORTS 1/8" NPT
KNOB NOT INCLUDED

NEW STAR NO.

S-7873



AIR SEAT CONTROL VALVE

REPLACEMENT FOR

BOSTROM AND NATIONAL
SEAT NUMBER: GT134-3
STANDARD 3-WAY
PUSH / PULL CONTROL
INCLUDES KNOB

NEW STAR NO.

S-8797



ALCOHOL EVAPORATOR

REPLACEMENT FOR

MIDLAND / HALDEX NUMBER:
A-72420

AN AUTOMATIC VAPORIZING
DEVICE TO KEEP AIR LINES AND
AIR TANKS FREE OF ICE

NEW STAR NO.

S-F466



AIR HORN KIT

REPLACEMENT FOR

GROVER NUMBER: 1650
INTERNATIONAL TRUCK NUMBER:
244283R91

NEW STAR NO.

S-5116



P.T.O. AIR CONTROL COMPONENTS



NEWSTAR NO.

S-C085

P.T.O. SHIFT VALVE ASSY.

REPLACEMENT FOR

CHELSEA NUMBER: 328863X
INCLUDES MTG. BRACKET AND KNOBS



NEWSTAR NO.

S-C086

INDICATOR LIGHT

FITS ABOVE MOUNTING BRACKET FOR
NEWSTAR PTO SHIFT VALVE ASSY.

REPLACEMENT FOR

CHELSEA NUMBER: 378978



NEWSTAR NO.

S-C456

FUSE HOLDER

REPLACEMENT FOR

CHELSEA NUMBER: 378884
FITS MODEL NS442 AND NS489 PTO'S



NEWSTAR NO.

S-C455

P.T.O. CABLE

REPLACEMENT FOR

CHELSEA NUMBER: 379640
FITS MODEL NS442 AND NS489 PTO'S



NEWSTAR NO.

S-D522

P.T.O. & DUMP PUMP CONTROL VALVE

REPLACEMENT FOR

CHELSEA NUMBER: 329358X
"COMBO" CONTROL VALVE
CONTROLS AIR SHIFT ON PTO AND
AIR SHIFT ON DUMP PUMP

P.T.O. AIR CONTROL COMPONENTS

P.T.O. COMBO VALVE W/ TOWER - CONSOLE

REPLACEMENT FOR

CHELSEA NUMBER: S-E067
INCLUDES 329358X VALVE &
329219X TOWER

NEWSTAR NO.

S-E067



P.T.O. & DUMP PUMP CONTROL VALVE REPLACEMENT FOR

CHELSEA NUMBER: 328388-79X
"COMBO" VALVE W/INSTALLATION KIT

NEWSTAR NO.

S-E205

P.T.O. CONTROL VALVE REPLACEMENT FOR

CHELSEA NUMBER: 328865X
4 WAY / 3 POSITION

NEWSTAR NO.

S-E900



P.T.O. CONTROL VALVE TOWER / CONSOLE REPLACEMENT FOR

CHELSEA NUMBER: 329219X
FITS ALL PTO CONTROL VALVES
UNIVERSAL 8" HIGH

NEWSTAR NO.

S-D523



LATEST ADDITIONS TO OUR CATALOG

ALL PARTS SUPPLIED ARE S & S/NEWSTAR. USE OF OTHER MANUFACTURERS' NAMES, PART NUMBERS, OR TRADEMARKS ARE FOR INFORMATIONAL AND IDENTIFICATION PURPOSES ONLY. PRICES ARE SUBJECT TO CHANGE OR WITHDRAWAL WITHOUT NOTICE.

P.T.O. AIR SHIFT KIT



REPLACEMENT FOR

CHELSEA NUMBER: 328388-37X

NEW STAR NO.

S-C581

INCLUDES 328863X CONTROL VALVE
 378978 INDICATOR LIGHT
 TUBING AND
 FITTING PACKAGE
 379640 WIRE & BALL
 SWITCH
 CONNECTOR
 379130 BRACKET
 378414 PRES. PROT. VALVE

DASH SWITCHES



NEW STAR NO.

S-C056

INTER-AXLE DIFF LOCK

REPLACEMENT FOR

GT NUMBER: 3244-1



NEW STAR NO.

S-C057

AIR SUSPENSION DUMP

REPLACEMENT FOR

GT NUMBER: 3244-3

TOGGLE VALVES

AIR-ELECTRIC PADDLE STYLE

REPLACEMENT FOR

GT NUMBER: 3200-1A

KENWORTH/VOLVO APPL.

NEWSTAR NO.

S-C058



AIR-ELECTRIC 'BAT' TYPE

REPLACEMENT FOR

GT NUMBER: 3200-3A

PETERBILT APPL.

NEWSTAR NO.

S-C059



AIR TOGGLE VALVES

AIR PADDLE STYLE

REPLACEMENT FOR

GT NUMBER: 3202-1A

KENWORTH/VOLVO APPL.

NEWSTAR NO.

S-C060



AIR 'BLADE' TYPE

REPLACEMENT FOR

GT NUMBER: 3202-2E

PETERBILT APPL.

NEWSTAR NO.

S-C061



LATEST ADDITIONS TO OUR CATALOG

ALL PARTS SUPPLIED ARE S & S/NEWSTAR. USE OF OTHER MANUFACTURERS' NAMES, PART NUMBERS, OR TRADEMARKS ARE FOR INFORMATIONAL AND IDENTIFICATION PURPOSES ONLY. PRICES ARE SUBJECT TO CHANGE OR WITHDRAWAL WITHOUT NOTICE.

FLIPPER VALVES



NEW STAR NO.
S-C062

AIR-ELECTRIC
LEVER POSITION 'RIGHT OFF'
REPLACEMENT FOR
GT NUMBER: 3220-1
FREIGHTLINER APPL.



NEW STAR NO.
S-C063

AIR-ELECTRIC
LEVER POSITION 'RIGHT OFF'
REPLACEMENT FOR
GT NUMBER: 3223-1
INTERNATIONAL TRUCK APPL.



NEW STAR NO.
S-C064

AIR-ELECTRIC
LEVER POSITION 'RIGHT ON'
REPLACEMENT FOR
GT NUMBER: 3223-2
INTERNATIONAL TRUCK APPL.

AIR FLIPPER VALVES



NEW STAR NO.
S-C065

LEVER POSITION 'RIGHT OFF'
REPLACEMENT FOR
GT NUMBER: 3222-1
FREIGHTLINER APPL.



NEW STAR NO.
S-C066

LEVER POSITION 'RIGHT ON'
REPLACEMENT FOR
GT NUMBER: 3224-1
INTERNATIONAL TRUCK APPL.

IN-LINE QUICK RELEASE VALVES

MOUNTS TO TRACTOR
PROTECTION VALVE
REPLACEMENT FOR
GT NUMBER: 4000-8

NEWSTAR NO.

S-C068



MOUNTS TO TRACTOR GLADHAND
REPLACEMENT FOR
GT NUMBER: 4000-6

NEWSTAR NO.

S-C069



**THE PICTURE OF THE ENTIRE NEWSTAR AIR PROGRAM
APPEARING ON PAGES 80-81 IS AVAILABLE IN A
33" X 45" POSTER.**

**ASK YOUR SALES REPRESENTATIVE FOR MORE
DETAILS**

REPAIR KITS TO REPLACE BENDIX AND MIDLAND BRAKE VALVES

NEW STAR NUMBER	REPLACEMENT FOR	DESCRIPTION
S-9352	101805	TW-1 REPAIR KIT
S-C334	102048	SR-4 REPAIR KIT
S-C335	102100	E-10 REPAIR KIT
S-9356	102511	R-12 REPAIR KIT
S-9357	102802	R-14 REPAIR KIT
S-C336	106932	BP-R1 REPAIR KIT
S-C428	107216	MV-3 REPAIR KIT
S-D824	107516	TF750 MAINT. KIT
S-A568	107798	AD-9 PURGE VALVE KIT
S-C352	108123	SR-1 REPAIR KIT
S-C337	108367	E-12 REPAIR KIT
S-C338	109015	SR-5 REPAIR KIT
S-C680	109578	AD-9 HEATER/THERMOKIT - 12 VOLT
S-E277	109579	AD-9 HEATER/THERMOKIT - 24 VOLT
S-8721	245835	QR-1 REPAIR KIT
S-9359	276119	E-3 MINOR REPAIR KIT
S-C339	276120	R-5 REPAIR KIT
S-9349	276121	D-2 GOV. REPAIR KIT
S-B267	276122	TC-2 REPAIR KIT
S-C340	278614K	DC-4 REPAIR KIT
S-C341	280758K	TR-3 REPAIR KIT
S-9354	280856	R-6 REPAIR KIT
S-C342	280857	PP-3 REPAIR KIT
S-C343	280858	TP-3 REPAIR KIT
S-C344	280915	D-2 (HIGH TEMP.) REPAIR KIT
S-C345	281084	E-5 REPAIR KIT
S-9350	281126	PP-1 REPAIR KIT
S-C346	281127	PP-2 REPAIR KIT
S-C347	282098	LQ-2 REPAIR KIT
S-C348	282134	DV-2 REPAIR KIT
S-9358	282812	RE-6 REPAIR KIT
S-C429	282813	RE-6 MINOR REPAIR KIT
S-C349	283861	R-7 REPAIR KIT
S-C350	283863	TP-4 REPAIR KIT
S-C351	286500K	PR-4 REPAIR KIT
S-9351	287367	PP-7 REPAIR KIT
S-9360	287368	E-6 MINOR REPAIR KIT
S-9355	287370	R-8 REPAIR KIT
S-C353	287691	SR-2 REPAIR KIT
S-C354	289061	TP-5 REPAIR KIT
S-C355	289352	E-7 REPAIR KIT
S-C356	289500	LQ-4 REPAIR KIT



REPAIR KITS TO REPLACE BENDIX AND MIDLAND BRAKE VALVES

NEW STAR NUMBER	REPLACEMENT FOR	DESCRIPTION
S-C357	289714K	QR-1C REPAIR KIT
S-D810	800405	AD-9 PURGE ASSY KIT - 12 VOLT
S-A568	5004336	AD-9 PURGE VALVE KIT
S-A568	5004337	AD-9 PURGE VALVE KIT
S-E278	5004381	AD-9 PURGE ASSY KIT - 24 VOLT
S-A568	5005037	AD-9 PURGE VALVE KIT
S-C361	KN28600K	FF-2 REPAIR KIT
S-C358	RN10BX	KN22100 REPAIR KIT
S-9361	RN10HK	KN28060 REPAIR KIT
S-9364	RN10HL	KN30400 REPAIR KIT W / COVER
S-9362	RN10HM	RG-2 REPAIR KIT
S-C359	RN10HR	RT-4 REPAIR KIT
S-C360	RN10HV	KN22150 REPAIR KIT

REPAIR KITS TO REPLACE EATON / FULLER AIR SYSTEM VALVES

NEW STAR NUMBER	REPLACEMENT FOR	DESCRIPTION
S-5696	K-1486	AIR FILTER KIT
S-5743	K-1550	SELECTOR VALVE KIT
S-4405	K-1566	RANGE VALVE KIT
S-9043	K-1698	AIR FILTER / REGULATOR KIT
S-3307	K-1699	SLAVE VALVE KIT
S-9404	K-1826	RANGE VALVE KIT
S-9405	K-1921	RANGE VALVE KIT
S-9406	K-1922	RANGE VALVE KIT
S-9407	K-1935	SLAVE VALVE KIT

REPAIR KITS TO REPLACE MISCELLANEOUS VALVES

NEW STAR NUMBER	REPLACEMENT FOR	DESCRIPTION
S-C362	10-5	1000-5A REPAIR KIT
S-C363	10-5 WD	A1000 REPAIR KIT
S-C364	110185	110171 REPAIR KIT
S-C365	110201	110200 REPAIR KIT
S-C366	118400	328863X P.T.O. CONTROL REPAIR KIT
S-9353	S-9353	PP-8 REPAIR KIT

LATEST ADDITIONS TO OUR CATALOG

ALL PARTS SUPPLIED ARE S & S/NEWSTAR. USE OF OTHER MANUFACTURERS' NAMES, PART NUMBERS, OR TRADEMARKS ARE FOR INFORMATIONAL AND IDENTIFICATION PURPOSES ONLY. PRICES ARE SUBJECT TO CHANGE OR WITHDRAWAL WITHOUT NOTICE.

EUROPEAN BRAKE VALVES

NEW★STAR NO.
S-9976

UNLOADER/REGULATOR VALVE
REPLACEMENT FOR

WABCO NUMBER: 975-303-473-0

KNORR NUMBER: DR-3500

MERCEDES BENZ NUMBERS:

002-431-60-06

002-431-49-06

002-431-63-06

002-431-52-06

002-431-00-06

MAN NUMBER: 81-52101-6146

WITH TIRE INFLATOR VALVE



NEW★STAR NO.
S-9977

AIR GOVERNOR-TYPE D-2
REPLACEMENT FOR

BENDIX NUMBERS: 267100

267098

267051

VOLVO NUMBERS: 1193532

1055047

SCANIA NUMBERS: 293546

333851

1107082

ALL PORTS: M10



NEW★STAR NO.
S-9639

FOUR CIRCUIT PROTECTION VALVE
REPLACEMENT FOR

KNORR NUMBER: AE-4170

WABCO NUMBER: 934-102-250-0

MERCEDES BENZ NUMBERS:

001-431-87-06

001-431-89-06

001-431-93-06

RVI NUMBER: 5000-788-503

EUROPEAN BRAKE VALVES CONTINUED

HEIGHT CONTROL VALVE

REPLACEMENT FOR

WABCO NUMBER: 464-002-443-0

NEWAY NUMBER: 90554241

KNORR WITH NPT PORTS

ALL PORTS 1/4" NPT

DIE CAST HOUSING

NEWSTAR NO.

S-9434



AIR DRYER CARTRIDGE

REPLACEMENT FOR

WABCO NUMBERS: 432-420-220-2

432-410-020-2

KNORR NUMBER: I-85127-004

BOSCH NUMBER: I-487-434-901

APPL: SCANIA, VOLVO, MERCEDES
MAN, IVECO, IKARUS, DAF, RVI

NEWSTAR NO.

S-11611



LATEST ADDITIONS TO OUR CATALOG

ALL PARTS SUPPLIED ARE S & S/NEWSTAR. USE OF OTHER MANUFACTURERS' NAMES, PART NUMBERS, OR TRADEMARKS ARE FOR INFORMATIONAL AND IDENTIFICATION PURPOSES ONLY. PRICES ARE SUBJECT TO CHANGE OR WITHDRAWAL WITHOUT NOTICE.

TRANSMISSION AIR VALVES: SLAVE VALVES



NEWSTAR NO.

S-3291

REPLACEMENT FOR

FULLER NUMBERS: A-4688
A-3991

ALL PORTS 1/8" NPT
INCLUDES MTG. GASKET



NEWSTAR NO.

S-8030

REPLACEMENT FOR

FULLER NUMBER: A-5000
ALL PORTS 1/8" NPT



NEWSTAR NO.

S-8336

REPLACEMENT FOR

FULLER NUMBER: K-2424
W/ GASKET AND 4 BOLTS



NEWSTAR NO.

S-C454

REPLACEMENT FOR

DANA® NUMBER: 313630X



NEWSTAR NO.

S-E904

REPLACEMENT FOR

MERITOR NUMBERS: KIT-5385
A-3280-Q-9455

INCLUDES SHIFT PIN, SPRING, SLEEVE,
PLUG AND GASKET

TRANSMISSION AIR VALVES

AIR REGULATOR

REPLACEMENT FOR

FULLER NUMBER: 16743
 1/4" NPT INLET 1/8" NPT OUTLET
 NON-ADJUSTABLE PRESET AT 57-65 PSI

NEWSTAR NO.

S-2022



AIR LINE FILTER ASSY.

REPLACEMENT FOR

FULLER NUMBER: A-4041
 ALL PORTS 1/8" NPT

NEWSTAR NO.

S-6529



FILTER REGULATOR ASSEMBLY

REPLACEMENT FOR

FULLER NUMBER: A-4740
 ALL PORTS 1/8" NPT
 NON-ADJUSTABLE-PRESET AT 57-65 PSI

NEWSTAR NO.

S-9146



FILTER REGULATOR KIT

REPLACEMENT FOR

FULLER NUMBER: K-2170
 ALL PORTS 1/8" NPT
 NON-ADJUSTABLE-PRESET AT 57-65 PSI

NEWSTAR NO.

S-A210



FILTER REGULATOR ASSEMBLY

REPLACEMENT FOR

DANA® NUMBER: 313042

NEWSTAR NO.

S-C453



FILTER REGULATOR ASSEMBLY

REPLACEMENT FOR

MERITOR NUMBER: A-3280-X-9072
 MERITOR 9, 10, & 13
 SPEED TRANSMISSIONS

NEWSTAR NO.

S-D971



LATEST ADDITIONS TO OUR CATALOG

ALL PARTS SUPPLIED ARE S & S/NEWSTAR. USE OF OTHER MANUFACTURERS' NAMES, PART NUMBERS, OR TRADEMARKS ARE FOR INFORMATIONAL AND IDENTIFICATION PURPOSES ONLY. PRICES ARE SUBJECT TO CHANGE OR WITHDRAWAL WITHOUT NOTICE.

FULLER TRANSMISSION AIR VALVES: RANGE VALVES



NEWSTAR NO.
S-3103

REPLACEMENT FOR

FULLER NUMBER: A-3546
ALL PORTS 1/8" NPT INCLUDES KNOB



NEWSTAR NO.
S-C462

LATE ERGONOMIC DESIGN

REPLACEMENT FOR

FULLER NUMBER: A-6909
ALL PORTS 1/16" NPT
INCLUDES UPPER & LOWER COVERS
SUPERCEDES A-5010



NEWSTAR NO.
S-E467

REPLACEMENT FOR

FULLER NUMBER: A-6910
A-5510
10 SPEED TRANSMISSIONS
GRAY SELECTOR SLIDE BUTTON ONLY
SUPERCEDES A-5510



NEWSTAR NO.
S-C461

LATE ERGONOMIC DESIGN

REPLACEMENT FOR

FULLER NUMBER: A-6913
ALL PORTS 1/16" NPT
INCLUDES UPPER & LOWER COVERS
SUPERCEDES A-4900

FULLER TRANSMISSION AIR VALVES: RANGE VALVES

LATE ERGONOMIC DESIGN

REPLACEMENT FOR

FULLER NUMBER: A-6915

ALL PORTS 1/16" NPT

INCLUDES UPPER & LOWER COVERS

SUPERCEDES A-5015

NEW STAR NO.

S-C460



REPLACEMENT FOR

FULLER NUMBER: A-6918

A-5013

18 SPEED TRANSMISSIONS

GRAY SELECTOR SLIDE BUTTON

& RANGE FLIPPER

NEW STAR NO.

S-E648



REPLACEMENT FOR

FULLER NUMBER: A-7313

13 SPEED TRANSMISSIONS

RHD VEHICLES

NEW STAR NO.

S-E649



REPLACEMENT FOR

FULLER NUMBER: A-7315

15 SPEED TRANSMISSIONS

RHD VEHICLES

NEW STAR NO.

S-E650



REPLACEMENT FOR

FULLER NUMBER: A-7318

18 SPEED TRANSMISSIONS

RHD VEHICLES

NEW STAR NO.

S-E651



LATEST ADDITIONS TO OUR CATALOG

ALL PARTS SUPPLIED ARE S & S/NEWSTAR. USE OF OTHER MANUFACTURERS' NAMES, PART NUMBERS, OR TRADEMARKS ARE FOR INFORMATIONAL AND IDENTIFICATION PURPOSES ONLY. PRICES ARE SUBJECT TO CHANGE OR WITHDRAWAL WITHOUT NOTICE.

FULLER TRANSMISSION AIR VALVE : SELECTOR VALVES



NEW STAR NO.

S-8011

CHROME PLATED COVER

REPLACEMENT FOR

FULLER NUMBER: A-4487

ALL PORTS 1/16" NPT

3 - POSITION SELECTOR



NEW STAR NO.

S-5494

CHROME PLATED COVER

REPLACEMENT FOR

FULLER NUMBER: A-4491

ALL PORTS 1/16" NPT

2 - POSITION SELECTOR



NEW STAR NO.

S-8800

CHROME PLATED COVER

REPLACEMENT FOR

FULLER NUMBER: A-4490

ALL PORTS 1/16" NPT

3 - POSITION SELECTOR

FULLER TRANSMISSION AIR VALVE : MISC. VALVES



NEW STAR NO.

S-4397

TRANSMISSION COUNTERSHAFT

BRAKE ACTUATOR

REPLACEMENT FOR

FULLER NUMBER: 16859

ALL PORTS 1/8" NPT

INCLUDES KNOB

FULLER TRANSMISSION AIR VALVE : MISC. VALVES

TRANSMISSION DEEP-REDUCTION VALVE REPLACEMENT FOR

FULLER NUMBER: 14651
ALL PORTS 1/8" NPT
INCLUDES DASH PLATE & SCREWS

NEWSTAR NO.

S-8904



TRANSMISSION SPLITTER VALVE REPLACEMENT FOR

FULLER NUMBER: 19974
15512

NEWSTAR NO.

S-3774



TRANSMISSION INSERT VALVE REPLACEMENT FOR

FULLER NUMBER: 4300810

NEWSTAR NO.

S-A937



TRANSMISSION RANGE AIR CONVERSION KIT REPLACEMENT FOR

FULLER NUMBER: K-3121
LATE DESIGNS FOR
SUPER 10 TRANSMISSIONS
INCLUDES RANGE VALVE, BOLTS,
FITTINGS & CONNECTORS

NEWSTAR NO.

S-E336



TRANSMISSION SPLITTER VALVE KIT REPLACEMENT FOR

FULLER NUMBER: K-3331
FITS FULLER SUPER 10
TRANSMISSIONS

NEWSTAR NO.

S-10291



LATEST ADDITIONS TO OUR CATALOG

ALL PARTS SUPPLIED ARE S & S/NEWSTAR. USE OF OTHER MANUFACTURERS' NAMES, PART NUMBERS, OR TRADEMARKS ARE FOR INFORMATIONAL AND IDENTIFICATION PURPOSES ONLY. PRICES ARE SUBJECT TO CHANGE OR WITHDRAWAL WITHOUT NOTICE.

CLAMPED SPRINGBRAKES

POSITIVE ALIGNMENT STEEL POWER SPRING RETAINER
 REINFORCED 11 GAUGE STEEL NON-PRESSURE HOUSING
 HIGH STRENGTH STEEL CLAMP BANDS
 11 GAUGE STEEL POWER SPRING HOUSING
 PLATED STEEL HOUSINGS
 LIGHTWEIGHT ALUMINUM ADAPTER HOUSING
 EPOXY COATED POWER SPRING
 DOUBLE O-RING CENTER SEAL
 UNIVERSAL PUSH ROD
 TAMPER RESISTANT / PREFERRED FOR EXPORT

**NEW★STAR NO.****S-D603
3030-TI****NEW★STAR NO.****S-B297
2430-TI****NEW★STAR NO.****S-E713
2424-TI****NEW★STAR NO.****S-7930
3030-SI**

DIRECT REPLACEMENT FOR ALL
 TYPE 30 "PIGGYBACK"
 SPRINGBRAKES ON THE MARKET TODAY.
 INCLUDES CAGING BOLT
 3030-SI (SINGLE)

SERVICE BRAKE CHAMBERS

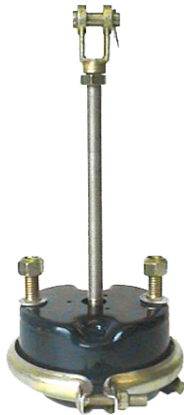

20SC



24SC



30SC

DIRECT REPLACEMENT FOR ALL SERVICE BRAKE CHAMBERS ON THE MARKET TODAY.
INCLUDES MOUNTING HARDWARE AND CLEVIS ASSY.

NEWSTAR NO.

S-9812	12SC
S-9813	16SC
S-9814	20SC
S-9815	24SC
S-5630	30SC

CLEVIS ASSEMBLY

FITS TYPE 20, 24, 30 BRAKE CHAMBERS
COMPLETE WITH 1/2" PIN
AND COTTER PIN

NEWSTAR NO.

S-9137



CLAMP BAND KIT - TYPE 30 REPLACEMENT FOR

ALL TYPE 30 CHAMBER CLAMPS
FITS BOTH SERVICE BRAKE & SPRING
BRAKE CHAMBERS

NEWSTAR NO.

S-B451



LATEST ADDITIONS TO OUR CATALOG

ALL PARTS SUPPLIED ARE S & S/NEWSTAR. USE OF OTHER MANUFACTURERS' NAMES, PART NUMBERS, OR TRADEMARKS ARE FOR INFORMATIONAL AND IDENTIFICATION PURPOSES ONLY. PRICES ARE SUBJECT TO CHANGE OR WITHDRAWAL WITHOUT NOTICE.

AIR BRAKE DIAPHRAGMS

OUR DIAPHRAGMS ARE SPECIALLY FORMULATED FOR LONG LIFE AND HARD SERVICE. A COMBINATION OF MATERIALS INSURES SUPERIOR STRENGTH, FLEXIBILITY AND RESISTANCE TO DETERIORATION. OPERATING TEMPERATURES RANGE FROM -40° F TO 212° F. DIRECTLY INTERCHANGEABLE WITH ALL COMPETITIVE RUBBER AND NEOPRENE DIAPHRAGMS.

NEWSTAR NUMBER	TYPE	NOMINAL SIZE	INDUSTRY NUMBER	REFERENCE NUMBER	REFERENCE NUMBER
S-5022	9	5"	D9	234433	18090
S-5023	12	5 1/2"	D12	234226	18120
S-5024	16	6"	D16	234189	18160
S-5025	20	6 1/2"	D20	234099	18200
S-1797	24	7"	D24	234100	18240
S-1798	30	8"	D30	234101	18300
S-5028	36	9"	D36	234362	18360
S-C381	24LS	7"	D24LS	897-120-536-4	
S-C382	30LS	8"	D30LS	897-120-546-4	

GLADHANDS

1/2" GLADHAND-ANGLED EMERGENCY REPLACEMENT FOR

MIDLAND / HALDEX NUMBER:
11445
 40 DEGREE BRACKET MOUNT
 INCLUDES 1/2" PIPE PLUG

NEW STAR NO.

S-10047



1/2" GLADHAND-ANGLED SERVICE REPLACEMENT FOR

MIDLAND / HALDEX NUMBER:
11444
 40 DEGREE BRACKET MOUNT
 INCLUDES 1/2" PIPE PLUG

NEW STAR NO.

S-10046



1/2" GLADHAND EMERGENCY REPLACEMENT FOR

MIDLAND / HALDEX NUMBER:
11451
 COLOR CODED RED
 FOR EMERGENCY

NEW STAR NO.

S-10043



1/2" GLADHAND-SERVICE REPLACEMENT FOR

MIDLAND / HALDEX NUMBER:
11452
 COLOR CODED BLUE
 FOR SERVICE

NEW STAR NO.

S-10044



1/2" GLADHAND-UNIVERSAL REPLACEMENT FOR

MIDLAND / HALDEX NUMBER:
11450
 COLOR CODED GOLD
 FOR UNIVERSAL USAGE

NEW STAR NO.

S-10045



LATEST ADDITIONS TO OUR CATALOG

ALL PARTS SUPPLIED ARE S & S/NEWSTAR. USE OF OTHER MANUFACTURERS' NAMES, PART NUMBERS, OR TRADEMARKS ARE FOR INFORMATIONAL AND IDENTIFICATION PURPOSES ONLY. PRICES ARE SUBJECT TO CHANGE OR WITHDRAWAL WITHOUT NOTICE.

AUTOMATIC SLACK ADJUSTERS



- MOST POPULAR 5.5", 6" ARMS
- COMPLETE WITH STRAIGHT CLEVIS (QUICK-CONNECT)
- UNHANDED DESIGN FITS MOST BRAKES
- DRILLED WORM WHEEL FOR LUBRICATION
- FACTORY LUBRICATED AND SEALED
- HEAVY DUTY INTERNALS
- NO EXTERNAL BRACKETS REQ'D
- CLEARANCE SENSING DESIGN
- AUTOMATIC ADJUSTMENT ON BRAKE APPLICATION
- FINEST QUALITY DUCTILE NODULAR IRON

NEWSTAR NUMBER	Spline	Drilling	Bendix Number	REPLACEMENT FOR		
				Gunite Number	Arvin Meritor Number	Crewson Brunner Number
S-B888	1 1/2" - 10	5 1/2"	065170	AS1132	R801041	CB21102
			065700	AS1119	R801043	
S-A669	1 1/2" - 10	6"	065172	AS1133	R801042	CB21103
			065344	AS1100	R801040	
					R801044	
S-C299	1 1/4" - 10	5 1/2"	065164	AS1136	R801004	CB24100
				AS1105		
S-C300	1 1/4" - 24	5 1/2"	065167	AS1138	R801003	CB25100
			065403	AS1107		
S-A670	1 1/2" - 28	5 1/2"	065174	AS1140	R801073	CB22102
			065247	AS1120	R801079	
					R801072	
S-B889	1 1/2" - 28	6"	065175	AS1141	R801074	CB22103
			065176	AS1101	R801071	CB22104
					R801075	



MANUAL STRAIGHT ARM SLACK ADJUSTERS

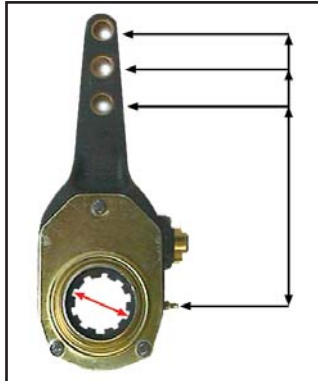

STRAIGHT ARM STANDARD DUTY SLACK ADJUSTER WITH BRONZE BUSHINGS AND 22,000 INCH-LBS. RATING IN ACCORDANCE WITH SAE TEST J1461 DRAFT 4; 26,000 INCH-LBS. MAXIMUM TORQUE RATING

Spline	Drilling	NEWSTAR NUMBER	Replaces						
			Midland No.	Bendix No.	Euclid No.	BWP No.	Arvin Meritor No.	Leland No.	Batco No.
1.60 -37	6	S-9861	KN44041	283411	E1574HD	M474	R822007 R824007	L841	5-240
1.60 -37	5- 6- 7	S-9644	KN44042	—	—	—	—	—	—
1.50 -28	5- 6	S-9643	KN44051	286965	E2458	M638	—	L1308	5-238
1.50 -28	5 1/2- 6 1/2	S-9862	KN44061	288753	E2459HD	M2577	R822004 R824004	L1648	5-237
1.50 -28	5- 6- 7	S-9863	KN44071	288282	E2458HD	—	R822003 R824003	—	—
1.50 -10	5- 6- 7	S-9642	KN47001	278323	E612HD	M435	R822000 R824000	L196	5-203
1.50 -10	4 1/2- 5 1/2- 6 1/2	S-9874	—	278326	—	—	—	—	—
1.50 -10	4 1/2- 5 1/2	S-9864	KN47002	279316	—	—	—	—	—
1.50 -10	5 1/2- 6 1/2	S-9523	KN47011	278321	E940HD	M457	R822001 R824001	L845	5-201
1.50 -10	5- 6	S-9865	KN47081	278312	E1063HD	M452	—	L562	5-202
1.25 -10	5- 6	S-9866	KN48001	278303	E939	M2582	R822010 R824010	—	5-215
1.25 -10	5- 6- 7	S-9867	KN48002	278305	—	—	R822008 R824008	—	—
1.25 -10	4 1/2- 5 1/2	S-9868	KN48031	278302	E4904	—	R822009 R824009	L2494	5-214
1.25 -10	4 1/2- 5 1/2 RH	S-9869	KN49000	278294	E2762RH	M2580	R824013	L1379	5-232
1.25 -10	4 1/2- 5 1/2 LH	S-9999	KN49010	278295	E2763LH	M2581	R824014	L1380	5-233

QUANTITY PRICING AVAILABLE



NEWSTAR NO.

S-A943

PAWL ASSEMBLY

FITS ALL MERITOR AUTOMATIC SLACK ADJUSTERS

REPLACEMENT FOR

MERITOR NUMBERS:

A1-2297-M-6461
R801700

LATEST ADDITIONS TO OUR CATALOG

ALL PARTS SUPPLIED ARE S & S/NEWSTAR. USE OF OTHER MANUFACTURERS' NAMES, PART NUMBERS, OR TRADEMARKS ARE FOR INFORMATIONAL AND IDENTIFICATION PURPOSES ONLY. PRICES ARE SUBJECT TO CHANGE OR WITHDRAWAL WITHOUT NOTICE.

EMERGENCY BRAKE SHOES**NEW STAR NO.****S-3502**

INTERNAL TYPE, DRUM DIAMETER 12"
 SIZE 4" X 1/4" X 14

REPLACEMENT FOR

FMSI NUMBER: 2085
 MERITOR NUMBER: A3-3722-E-421
 APPL.: CLARK 282 / 285, CL551 / 557
 DANA®: CM50-59, CM50-60
 IH T698, IH T699
 ALLISON AT540, MT640, 650
 LINED

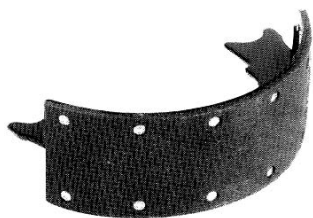
**NEW STAR NO.****S-5828****S-5829**

INTERNAL TYPE, DRUM DIAMETER 9"
 SIZE 3" X 3/16" X 10 9/16"

REPLACEMENT FOR FMSI NUMBERS:

2086-DD FORD S-5828
 2086 GMC, DODGE S-5829
 APPL.: CLARK 282/285
 LINED

**NEW STAR NO.****S-6003**

INTERNAL TYPE, DRUM DIAMETER 9"
 SIZE 2" X 3 1/6" X 10 1/2"

REPLACEMENT FOR

FMSI NUMBER: 2095
 APPL.: UPS, DIVCO MODELS
 LINED

**NEW STAR NO.****S-A173**

INTERNAL TYPE, DRUM DIAMETER 10"
 SIZE 3" X 3/16" X 11 1/4"

REPLACEMENT FOR

FMSI NUMBER: 1303
 APPL.: INTERNATIONAL TRUCKS & BUSES
 A2-3722-G-501
 388912C91
 LINED

**NEW STAR NO.****S-A755**

FITS 1999 FORD MODEL F350 SD
 WITH REAR DISC BRAKES.
 CONSISTS OF FOUR RIVETED SHOES.

REPLACEMENT FOR

FORD SET NUMBER: F8IZ-2200-CA
 LINED

EMERGENCY BRAKE STRUT

APPLICATION : FITS FMSI 1303
EMER. BRAKE SHOES
REPLACEMENT FOR
INTERNATIONAL TRUCK NUMBER:
388914C1
MERITOR NUMBER: A-3787-Q-17

NEW STAR NO.

S-C120



APPLICATION : FITS FMSI 2085
EMER. BRAKE SHOES
REPLACEMENT FOR
INTERNATIONAL TRUCK NUMBER:
233010R1
MERITOR NUMBER: A-3787-N-14
FORD NUMBER: CITZ-2A642-A

NEW STAR NO.

S-3886



EMERGENCY BRAKE BAND

EXTERNAL TYPE, DRUM DIAMETER 9 1/2"
SIZE 2 1/2" X 3/16" X 27"
REPLACEMENT FOR
FMSI NUMBER: 6056
APPL.: NEW PROCESS 435,540
IH T495,496,698,699
LINED

NEW STAR NO.

S-4641



REPLACEMENT EMERGENCY BRAKE SPRING KITS**NEW★STAR NO.****S-8941**

APPLICATION : FITS BOTH 2086
AND 2086DD EMERGENCY
BRAKE SHOES

REPLACEMENT FOR

BENDIX NUMBER: 108687

**NEW★STAR NO.****S-7927**

APPLICATION : FITS BOTH 2086
AND 2086DD EMERGENCY
BRAKE SHOES

REPLACEMENT FOR

BENDIX NUMBER: 308664 (RED)
FORD NUMBER: B9T-2634-B
GM NUMBER: 2473916

**NEW★STAR NO.****S-7928****BRAKE SPRING**

APPLICATION : FITS BOTH 2086
AND 2086DD EMERGENCY
BRAKE SHOES

REPLACEMENT FOR

BENDIX NUMBER: 308665 (GREEN)
FORD NUMBER: B9T-2749-A
GM NUMBER: 2473917

**NEW★STAR NO.****S-3145**

APPLICATION : FITS FMSI NUMBERS 2085
AND 1303 EMERGENCY BRAKE SHOES

REPLACEMENT FOR

INTERNATIONAL TRUCK NUMBER:
233009R1
MERITOR NUMBER: 2758-A-53
FORD NUMBER: C1TZ-2634-A

POPULAR BRAKE SHOES

NEW ... NOT REBUILT

ALL *NEW★STAR* BRAKE SHOES ARE COMPLETELY NEW. NEW STEEL INSURES CORRECT TOLERANCES AND FIT EVERY TIME. NO STRETCHED, TWISTED, OR WARPED SHOES TO BE CONCERNED WITH. NO CORES TO BE RETURNED!

OUR NS20 STANDARD 20K LINING IS A PREMIUM GRADE ORGANIC PRODUCT THAT IS CERTIFIED TO A 20,000 LB. AXLE RATING, AND WILL DELIVER EXCELLENT STOPPING PERFORMANCE.

OUR NS23 PREMIUM 23K LINING IS SPECIALLY FORMULATED FOR USE IN EXTREME TRACTOR-TRAILER OR TRUCK APPLICATIONS. FRICTION OUTPUT REMAINS STABLE THROUGHOUT HIGH TEMPERATURE RANGES, MULTI STOP AND / OR HEAVIER THAN NORMAL LOADS.

DRUM AND LINING LIFE CHARACTERISTICS ARE EXCELLENT IN BOTH LINING GRADES, WHICH PASS ALL FMVSS121 CERTIFICATIONS.



LATEST ADDITIONS TO OUR CATALOG

ALL PARTS SUPPLIED ARE S & S/NEWSTAR. USE OF OTHER MANUFACTURERS' NAMES, PART NUMBERS, OR TRADEMARKS ARE FOR INFORMATIONAL AND IDENTIFICATION PURPOSES ONLY. PRICES ARE SUBJECT TO CHANGE OR WITHDRAWAL WITHOUT NOTICE.

POPULAR BRAKE SHOES**NEWSTAR NO.****16 1/2" X 7" MERITOR 'Q'**

S-11705	— 20K STD. LINING	4515QNS20
S-11706	— 23K PREM. LINING	4515QNS23
	USES HDWR KIT S-E061	
S-11707	— 20K STD.	4515QNS20 KIT
S-11708	— 23K PREM.	4515QNS23 KIT
	KITS CONTAIN 2 SHOES & HDWR KIT	

**NEWSTAR NO.****16 1/2" X 7" MERITOR 'Q' PLUS**

S-11709	— 20K STD. LINING	4707Q+NS20
S-11710	— 23K PREM. LINING	4707Q+NS23
	USES HDWR KIT S-E061	
S-11711	— 20K STD.	4707Q+NS20 KIT
S-11712	— 23K PREM.	4707Q+NS23 KIT
	KITS CONTAIN 2 SHOES & HDWR KIT	

**NEWSTAR NO.****16 1/2" X 7" EATON**

S-11713	— 20K STD. LINING	4311ENS20
S-11714	— 23K PREM. LINING	4311ENS23
	USES HDWR KIT S-E057	
S-11715	— 20K STD.	4311ENS20 KIT
S-11716	— 23K PREM.	4311ENS23 KIT
	KITS CONTAIN 2 SHOES & HDWR KIT	

POPULAR BRAKE SHOES

16 1/2" X 7" EATON 'ES2'

		NEWSTAR NO.
20K STD. LINING	4709ES2NS20	S-11717
23K PREM. LINING	4709ES2NS23	S-11718
USES HDWR KIT S-E054		
20K STD.	4709ES2NS20 KIT	S-11719
23K PREM.	4709ES2NS23 KIT	S-11720
KITS CONTAIN 2 SHOES & HDWR KIT		



16 1/2" X 7" FRUEHAUF 'XEM3'

		NEWSTAR NO.
20K STD. LINING	4515X3NS20	S-11721
23K PREM. LINING	4515X3NS23	S-11722
USES HDWR KIT S-E062		
20K STD.	4515X3NS20 KIT	S-11723
23K PREM.	4515X3NS23 KIT	S-11724
KITS CONTAIN 2 SHOES & HDWR KIT		



15" X 4" MERITOR 'Q'

		NEWSTAR NO.
20K STD. LINING	1308QNS20	S-11725
USES HDWR KIT S-E045		
20K STD.	1308QNS20 KIT	S-11727
KITS CONTAIN 2 SHOES & HDWR KIT		



LATEST ADDITIONS TO OUR CATALOG

ALL PARTS SUPPLIED ARE S & S/NEWSTAR. USE OF OTHER MANUFACTURERS' NAMES, PART NUMBERS, OR TRADEMARKS ARE FOR INFORMATIONAL AND IDENTIFICATION PURPOSES ONLY. PRICES ARE SUBJECT TO CHANGE OR WITHDRAWAL WITHOUT NOTICE.

POPULAR BRAKE SHOES**NEW★STAR NO.****S-11729****15" X 4" MERITOR 'Q PLUS'**

20K STD. LINING

4702Q+NS20

USES HDWR KIT S-E052

S-11731

20K STD.

4702Q+NS20 KIT

KITS CONTAIN 2 SHOES & HDWR KIT

**NEW★STAR NO.****S-11733****15" X 4" EATON**

20K STD. LINING

1308ENS20

USES HDWR KIT S-E047

S-11735

20K STD.

1308ENS20 KIT

KITS CONTAIN 2 SHOES & HDWR KIT

**NEW★STAR NO.****S-11737****15" X 4" EATON 'ES'**

20K STD. LINING

1443ESNS20

USES HDWR KIT S-E047

S-11739

20K STD.

1443ESNS20 KIT

KITS CONTAIN 2 SHOES & HDWR KIT

BRAKE SHOE HARDWARE KITS

 NUMBER	EUCLID REFERENCE NUMBER	BWP REFERENCE NUMBER	MERITOR REFERENCE NUMBER	DESCRIPTION	APPL.
S-E039	E2126	MK46	R507000	EATON 12 1/4" W/ FAB. SHOES	TLR
S-E040	E2286	MK47	R507005	FRUEHAUF 12 1/4" W/ FAB. SHOES	TLR
S-E041	E2821	MK58	R507072	EATON 18" W/ CAST SHOES	DRIVE
S-E042	E3484	MK45	KIT-8004	MERITOR 12 1/4" Q BRAKES	TLR
S-E043	E3782	MK83	R507076	DANA® 12 1/4" 'U' BRAKES	TLR
S-E044	E3801	MK6	R507077	EATON 16 1/2" HIGH MOUNT FORD	DRIVE
S-E045	E3869	MK79	KIT-8029	MERITOR 15" Q BRAKES	FRONT
S-E046	E4691	MK52	KIT-9094	MERITOR 15" T BRAKES	FRONT
S-E047	E5139	MK77	R507004	EATON 15" X 4" STANDARD	FRONT
S-E048	E5515	MK91	R507063	DANA® 16 1/2" X 7" 'XL' BRAKES	DRIVE
S-E049	E6879	MK52A	KIT-1125	MERITOR 15" 'T' BRAKE W/O PINS	FRONT
S-E050	E7231	MK94	R507080	BENDIX BRAZILIAN 15" X 4"	FRONT
S-E051	E7237	MK95	R507081	BENDIX BRAZILIAN 16 1/2" X 7"	DRIVE
S-E052	E9064	MK98	KIT-8824HD	MERITOR 15" Q PLUS BRAKE	FRONT
S-E053	E9644	—	KIT-8081	MERITOR 16 1/2' Q BRAKE	FRONT
S-E054	E10244	MK105	R507064	EATON 16 1/2' ES2 BRAKES	DRIVE
S-E055	E10760	—	R507094	EATON 16 1/2' ES2 BRAKES	FRONT
S-E056	E10875	MK112	R507095	DEXTER 12.-1/4" PQ BRAKES	TLR
S-E057	E1887AHD	MK99	R507002	EATON 16 1/2" W/ FAB. SHOES	DR/TLR
S-E058	E2030HD	MK11	R507014	STD.FORGE / DANA® 12 1/4" WITH CAST SHOES	TLR
S-E059	E2402HD	MK12	R507015	STD.FORGE / DANA® 12 1/4" W / FAB. SHOES	TLR
S-E060	E2403HD	MK43	R507068	STD.FORGE / DANA® 12 1/4" CONVERSION KIT	TLR
S-A701	E2769	—	KIT-8000	MERITOR 16 1/2" Q	DRIVE
S-E061	E2769SHDR	MK39HD	KIT-8000HD	MERITOR 16 1/2" Q & Q PLUS	DRIVE
S-E062	E3710HD	MK42	R507010	FRUEHAUF 16 1/2" 'XEM' 3-GEN.	TLR
S-E063	E3710S	—	R507008	FRUEHAUF 16 1/2" 'XEM' 2-GEN.	TLR
S-E064	E5481A	MK84	R507057	EATON 16 1/2" ES BRAKES	DRIVE
S-E065	E-KIT-4S	MK3	R509002	MERITOR 16 1/2" P BRAKES	TLR

LATEST ADDITIONS TO OUR CATALOG

ALL PARTS SUPPLIED ARE S & S/NEWSTAR. USE OF OTHER MANUFACTURERS' NAMES, PART NUMBERS, OR TRADEMARKS ARE FOR INFORMATIONAL AND IDENTIFICATION PURPOSES ONLY. PRICES ARE SUBJECT TO CHANGE OR WITHDRAWAL WITHOUT NOTICE.



CAMSHAFT REPAIR KITS



NEW STAR NUMBER	EUCLID REFERENCE NUMBER	BWP REFERENCE NUMBER	MERITOR REFERENCE NUMBER	DESCRIPTION
S-E804	E-2469	MK26	R615010	FOR LATE MODEL DANA® AND STANDARD FORGE AXLES, 12.25" BRAKES
S-E805	E-2125	MK19	R615002	EATON DRIVE AXLE BRAKES 15" AND 16 1/4"
S-E806	E-2696A	MK63	R615004	EATON TRAILER AXLES '501' AND 'ES' BRAKES
S-E807	E-2090	MK20	R615005	FRUFHAUF PROPAP AXLES WITH 16 1/2" BRAKES
S-E808	E-2086B	MK17	KIT-9078	MERITOR DRIVE AXLE 16 1/2" & 18" 'P' SERIES
S-E809	E-3993B	MK81	KIT-8042	MERITOR DRIVE AXLE 15" & 16 1/2 " 'Q' & 'Q PLUS' BRAKES
S-E810	E-9080	—	—	MERITOR DRIVE AXLE 'P' & 'Q' W/ 2-1/2" SPIDER OFFSET
S-E811	E-3520-AHD	MK61	KIT-8048	MERITOR TRAILER AXLES 4000-6000 16.5" BRAKES 'P' & 'Q' BRAKES W/12 1/2" BRAKES
S-E812	E-9079HD	—	KIT-8078A	MERITOR TRAILER AXLES 'Q' & 'Q PLUS' W/ BOLT ON POWDER METAL SPIDER BUSHINGS
S-E813	E-6078	MK90	KIT-8289	MERITOR TRAILER AXLES W/ FAB SPIDERS 16.50" 'Q' BRAKES
S-E814	E-2287	MK24	R615008	LATE MODEL DANA® AND STANDARD FORGE MODELS A175, A195 AND A225 AXLES 16.50" BRAKES



MASTER AND WHEEL CYLINDERS SUITABLE FOR BENDIX AND WAGNER

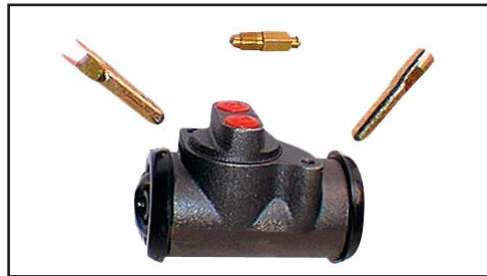

NEW STAR NUMBER	-----REPLACEMENT FOR-----				
WAGNER NUMBER	REFERENCE NUMBER	BENDIX NUMBER	EUCLID NUMBER	INDUSTRY NUMBER	
S-D423	F544	7373718 1269447	---	---	544
S-4929	F661	48175H	11119	E-3883	661
S-E331	F1012	1067016	---	E-2826	1012
S-B139	F1251	7410830	---	---	1251
S-11590	F2061	GPW2061	---	---	2061
S-11591	F2261	GPW2261	---	---	2261
S-B134	F2796	805223	---	---	---
S-4967	F2842	55070R91	11122	E-3884	2842
S-E215	F3527	7539267	---	---	3527
S-D951	F4419	7348976	---	---	4419
S-B300	F6086	A556	---	---	---
S-E296	F6353	---	---	---	6353
S-E350	F6354	---	---	---	6354
S-B067	F6630	1067757 8333648	---	---	6630
S-B293	F7368	A6110	---	---	7368
S-B292	F7379	A1484	---	---	---
S-7194	F8852	2254355	33320	E-5179	8852
S-7193	F8853	2254354	33321	E-5180	8853
S-B006	F9375	924643	---	---	---
S-B007	F9376	924642	---	---	---
S-B290	F16534	807356	---	---	---
S-B291	F16535	807357	---	---	---
S-C419	F17930A	7035410	---	---	17930A
S-5009	F24489	684834R91	33338	E-5148	24489
S-7217	F26159	E0HZ2261A	33580	E-5149	37180
S-5010	F26172	684835R91 C5TZ2261A 260551C91 A3261G319	33400	E-5150	26172
S-7598	F26181	260551C91 A3261G319	33584	E-5151	37222
S-7209	F32349	2404322	33376	E-5153	37091
S-7203	F32350	2404321	33377	E-5154	37092
S-5085	F42082	897757R93 1646988C91	11468	E-7827	36340
S-5046	F43260	965563R91	11466	E-7875	36170
S-5137	F43375	341037C91 C9TZ2062A	33714	E-5163	37033
S-5138	F43376	341038C91 C9TZ2061A	33715	E-5164	37034
S-5135	F43383	341035C91 DOTZ2062C	33581	E-5161	37167
S-3050	F43384	341036C91 DOTZ2061C	33582	E-5162	37168
S-5030	F54699	878977R92	11467	E-7828	36153
S-C417	F59402	943625	---	---	59402
S-C418	F59403	944578	---	---	59403
S-7720	F71238	C8TZ2261-C	33606	E-5168	37152
S-7206	F73500	DOTZ2062-A	33716	E-5173	37252
S-7192	F73501	DOTZ2061-A	33717	E-5174	37253
S-7212	F78743	C8TZ2261-B D1TZ2261-A	33607	E-5167	37149
S-7220	F78744	2620632	33655	E-5169	37240
S-7196	F78745	2620633	33656	E-5170	37241
S-E144	F112398	7411070	---	---	112398

LATEST ADDITIONS TO OUR CATALOG

ALL PARTS SUPPLIED ARE S & S/NEWSTAR. USE OF OTHER MANUFACTURERS' NAMES, PART NUMBERS, OR TRADEMARKS ARE FOR INFORMATIONAL AND IDENTIFICATION PURPOSES ONLY. PRICES ARE SUBJECT TO CHANGE OR WITHDRAWAL WITHOUT NOTICE.



BRAKE CALIPERS

SUITABLE TO FIT MEDIUM - DUTY TRUCKS / SCHOOL BUSES
NEW! NO CORE CHARGES

**NEW★STAR NO.****S-A782****TWIN PISTON CALIPER 2.88"**

BENDIX STYLE

REPLACEMENT FORBENDIX, INTERNATIONAL TRUCK,
& GMC NUMBERS:

55250 , 1658443C91 , 15618891

USED FRONT AND REAR

S-E738DISC PAD SET MKD225
990-953-C**NEW★STAR NO.****S-A916****TWIN PISTON CALIPER 2.50"**

DAYTON STYLE

REPLACEMENT FOR

BENDIX, FORD, & GMC NUMBERS:

55251 , E6HG-2B120-B , 15619099

USED FRONT AND REAR

S-F322

DISC PAD SET MKD224

**NEW★STAR NO.****S-A917****TWIN PISTON CALIPER 2.60"**

BENDIX STYLE

REPLACEMENT FOR

BENDIX, INTERNATIONAL TRUCK NUMBERS:

55245 , 582024C91, 1669311C91

USED FRONT AND REAR

S-4252DISC PAD SET MKD184
582-028-C

BRAKE CALIPERS

SUITABLE TO FIT MEDIUM - DUTY TRUCKS / SCHOOL BUSES
NEW! NO CORE CHARGES

TWIN PISTON CALIPER 2.88"

DAYTON STYLE

REPLACEMENT FOR

BENDIX NUMBER: 55252
USED FRONT AND REAR

NEW STAR NO.

S-C671



DISC PAD SET MKD236

S-F323

TWIN PISTON CALIPER 66MM

REPLACEMENT FOR

BENDIX NUMBER: 55849
INTERNATIONAL TRUCK NUMBER:
2501839C91
2509253C91

NEW STAR NO.

S-10130



BOSCH PIN-SLIDE STYLE

TWIN PISTON CALIPER 73MM

REPLACEMENT FOR

BENDIX NUMBER: 55850
INTERNATIONAL TRUCK NUMBER:
2501838C91
2509254C91

NEW STAR NO.

S-10131



BOSCH PIN-SLIDE STYLE

CALIPER KEY KIT

BENDIX STYLE

REPLACEMENT FOR

BENDIX NUMBER: H5635
INTERNATIONAL TRUCK NUMBER:
990956C91

NEW STAR NO.

S-D418



**CALIPER KEY KIT FOR 55250
TWIN PISTON CALIPER 2.88"**

CALIPER BLEEDER SCREW

REPLACEMENT FOR

BENDIX NUMBER: 94010
INTERNATIONAL TRUCK NUMBER:
254468C

NEW STAR NO.

S-E585



LATEST ADDITIONS TO OUR CATALOG

ALL PARTS SUPPLIED ARE S & S/NEWSTAR. USE OF OTHER MANUFACTURERS' NAMES, PART NUMBERS, OR TRADEMARKS ARE FOR INFORMATIONAL AND IDENTIFICATION PURPOSES ONLY. PRICES ARE SUBJECT TO CHANGE OR WITHDRAWAL WITHOUT NOTICE.

BRAKE ROTORS

SUITABLE TO FIT MEDIUM - DUTY TRUCKS / SCHOOL BUSES

**NEW★STAR NO.****S-C022****REPLACEMENT FOR**

INTERNATIONAL TRUCK NUMBER:

2007173C

GUNITE NUMBER:

D6153

15" MAJOR DIA.

10 STUD

NON 'ABS' TYPE

DAYTON WALTHER STYLE

**NEW★STAR NO.****S-E743****REPLACEMENT FOR**

INTERNATIONAL TRUCK NUMBER:

3531662C2

GUNITE NUMBER:

D6176

15" MAJOR DIA.

10 STUD

W 'ABS' EXCITER TEETH (100) IN CASTING

DAYTON WALTHER STYLE

**NEW★STAR NO.****S-11177****REPLACEMENT FOR**

INTERNATIONAL TRUCK NUMBER:

3531661C2

15" MAJOR DIA.

5 STUD

W 'ABS' EXCITER TEETH (100) IN CASTING

DAYTON WALTHER STYLE

WHEEL BEARINGS



Case hardened steel- allows the bearing to have a better load capacity and is less likely to fracture under shock loads.

Phosphate coated cage- is specially engineered to prevent corrosion of the cage and contains lubricating properties which help prevent friction between the cage and rollers.

Superior microfinish on rollers and runways- reduces heat and provides longer life.

ISO 9001 certified.

OEM approved and quality certified.



NEWSTAR NUMBER

REPLACEMENT FOR PART NUMBER

S-A303	572
S-A304	580
S-A305	592A
S-A306	594A
S-A307	598A
S-A308	653
S-A309	663
S-C525	3720
S-C526	3782
S-D715	28622
S-D714	28682
S-A310	39520
S-A311	39590
S-E038	45220
S-A050	47820
S-A051	47890
S-A074	H715311
S-A075	H715334
S-A076	H715343
S-A312	HM212011
S-A313	HM212047
S-A314	HM212049
S-A315	HM218210
S-A316	HM218248
S-A317	HM518410
S-A318	HM518445

LATEST ADDITIONS TO OUR CATALOG

ALL PARTS SUPPLIED ARE S & S/NEWSTAR. USE OF OTHER MANUFACTURERS' NAMES, PART NUMBERS, OR TRADEMARKS ARE FOR INFORMATIONAL AND IDENTIFICATION PURPOSES ONLY. PRICES ARE SUBJECT TO CHANGE OR WITHDRAWAL WITHOUT NOTICE.

WHEEL SEALS

**INTERCHANGEABLE WITH C/R, NATIONAL, STEMCO AND MERITOR
OEM APPROVED**

- Superior axle shoulder coverage-** with integral axle ring.
- Triple-lip dirt exclusion system.**
- Superior graphite-loaded rubber compound-** on one piece seals.
- Rubber impregnated leather-** on two piece seals.
- Lubricant compatibility-** performs with all TMC recognized hub lubricants.
- Large vent holes-** allow lubricant to flow to and from the seal.
- Reinforced outer seal casing.**
- Built-in end play feature-** helps compensate for bearing end play.
- All popular one-piece and two-piece oil/grease/bath seals available.**
- No Tools Required.**



NEW STAR NUMBER	-----REPLACEMENT FOR-----			
	C/R NUMBER	NATIONAL NUMBER	STEMCO NUMBER	MERITOR NUMBER
S-A225	35066/35059	370001A	308-0836	R65263U
S-A226	47697/47695	370003A	309-0973	R65356U
S-A227	48000/48001	370005A	309-0960	R65165U
S-A228	47699	370006A	309-0970	R65283U
S-A229	45160/45158	370021A	309-0964	R65172U
S-A230	45099/45097	370022A	309-0903	R65270U
S-A231	38780/38779	370023A	309-0912	R65152U
S-A232	46305/46304	370025A	307-0743	R65060U
S-A233	42672/42671	370031A	309-0904	R65071U
S-A234	40136/40133	370036A/370349A	307-0713	R65261U
S-A235	43752/43786	370037A/370338A	307-0744	R65298U
S-A236	43764/43763	370048A/370182A	308-0864	R65092U
S-A237	42623/42622	370065A/376590A	307-0723	R65262U
S-A238	52658	370069A	309-0948	R65030U
S-A239	45103/45102	370131A	308-0855	R65078U
S-A240	38709/39988	370033A	---	R65275U
S-A241	34386/34387	370047A	309-0935	R65111U
S-A242	---	---	---	R70598
S-A243	---	---	---	R70597
S-A245	---	---	---	R70596
S-A246	---	---	---	R69699



HUB CAPS

INTERCHANGE WITH C/R AND STEMCO

NEWSTAR NUMBER	REPLACEMENT FOR STEMCO NUMBER	DESCRIPTION
S-5285	330-3009	UNIVERSAL HUB CAP GASKET
S-B359	340-4975	PLASTIC FRUEHAUF SPIN-OFF
S-B360	343-4009	ALUMINUM HUB CAP 6-HOLE W/PLUG & GASKET
S-B361	343-4013	ALUMINUM HUB CAP 5-HOLE W/PLUG & GASKET
S-B358	343-4024	ALUMINUM HUB CAP 6-HOLE
S-B362	343-4075	ALUM FRUEHAUF SPIN-OFF
S-B363	343-4095	ALUMINUM HUB CAP 6-HOLE W/PLUG & GASKET
S-B364	343-4249	ALUMINUM HUB CAP 6-HOLE W/PLUG & GASKET
S-B365	359-5990	VENT PLUG
S-E781	359-5995	HUBCAP WINDOW KIT

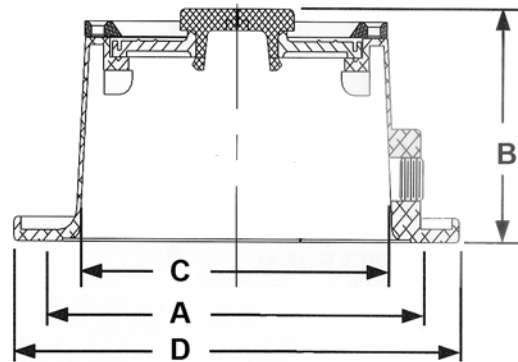

NEWSTAR NUMBER	REPLACEMENT FOR STEMCO NUMBER	BOLT CIRCLE (A)	BOLT SIZE	NUMBER OF BOLTS	OVERALL HEIGHT (B)	FLANGE I.D. (C)	FLANGE O.D. (D)
S-B359	340-4975	PLASTIC FRUEHAUF (PROPAR) SPIN OFF					
S-B360	343-4009	5-1/2"	5/16"	6	2-11/16"	4-3/8"	6-1/4"
S-B361	343-4013	5-1/2"	5/16"	5	2-11/16"	4-3/8"	6-1/4"
S-B358	343-4024	4-1/2"	5/16"	6	2-5/8"	3-1/4"	5-1/4"
S-B362	343-4075	ALUMINUM FRUEHAUF (PROPAR) SPIN OFF					
S-B363	343-4098	5-1/2"	5/16"	6	1-3/4"	4-9/16"	6-9/16"
S-B364	343-4249	5-9/16"	5/16"	6	1-13/16"	4-7/16"	6-3/16"

LATEST ADDITIONS TO OUR CATALOG

ALL PARTS SUPPLIED ARE S & S/NEWSTAR. USE OF OTHER MANUFACTURERS' NAMES, PART NUMBERS, OR TRADEMARKS ARE FOR INFORMATIONAL AND IDENTIFICATION PURPOSES ONLY. PRICES ARE SUBJECT TO CHANGE OR WITHDRAWAL WITHOUT NOTICE.



TAILGATE LOCK KITS AND PARTS**NEW★STAR NO.****S-C686****TAILGATE LOCK KIT FOR DUMP PUMPS**

INCLUDES CYLINDER W/CLEVIS ASSY,
PUSH-PULL VALVE AND D.O.T.
APPROVED TUBING AND FITTINGS.

**NEW★STAR NO.****S-C509****TAILGATE CYLINDER W/CLEVIS
AND COTTER PIN**

DOUBLE-ACTING CYLINDER 2 1/2" X 8"

**NEW★STAR NO.****S-C619****PUSH-PULL VALVE - 4 WAY**

SINGLE SPOOL VALVE (STACKABLE)

1 - 1/8" NPT INLET PORT
2 - 1/8" NPT OUTLET PORTS

33" X 45" POSTERS AVAILABLE
 CONTACT YOUR SALES
 REPRESENTATIVE FOR
 MORE DETAILS.

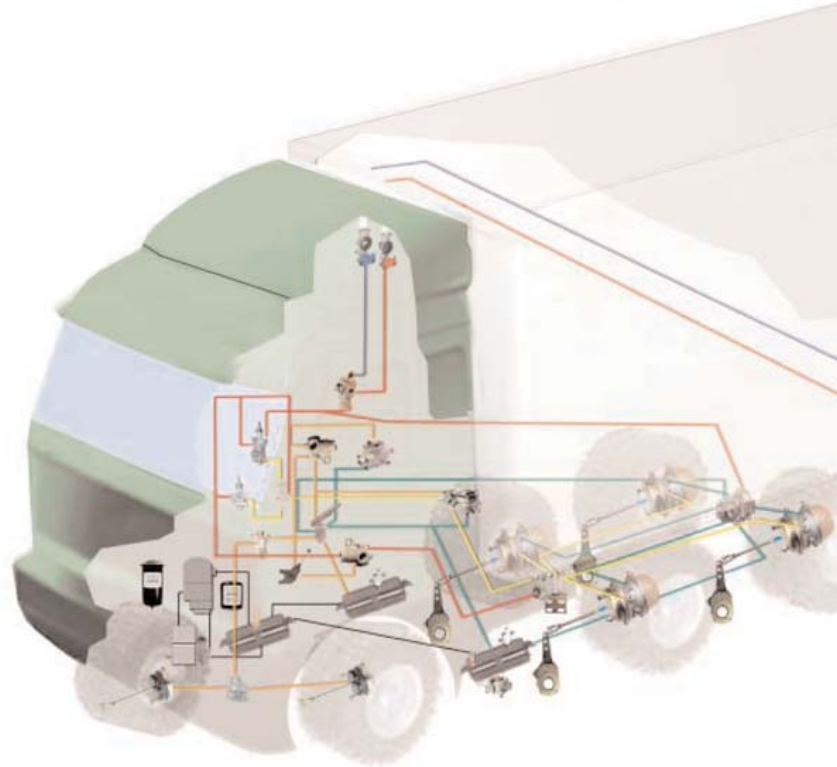

GOVERNORS

NEW STAR NUMBER	REPLACEMENT FOR	TYPE
S-6106	275491	D-2
S-A535	284358	D-2

MOUNTED CONTROL VALVES

NEW STAR NUMBER	REPLACEMENT FOR	TYPE
S-5675	276567	PP-1
S-A560	278450	PP-1
S-A267	281587	PP-1
S-8898	287600	PP-1
S-A268	276462	PP-2
S-A144	279787	PP-3
S-A145	288746	PP-3
S-5677	288239	PP-7
S-B285	288241	PP-7
S-B286	288242	PP-7
S-9169	287238	PP-8
S-A276	KN-20031	
S-C734	KN-20033	
S-5676	229635	TW-1
S-C563		ON-OFF
S-E800	KN-20615	
S-10129	281946	PP-5

SAFETY VALVES

NEW STAR NUMBER	REPLACEMENT FOR	TYPE
S-C291	205105	ST-1
S-7656	284142	ST-3
S-E023	284143	ST-3
S-E859	800350	ST-4
S-C645	131081	ST-4

QUICK RELEASE VALVES

NEW STAR NUMBER	REPLACEMENT FOR	TYPE
S-4922	229859	QR-1
S-8328	229860	QR-1
S-A270	229813	QR-1
S-B073	229844	QR-1
S-9749	289714	QR-1C
S-C403	229505	LQ-2
S-9625	289144	LQ-4
S-E463	289148	LQ-4
S-C068	4000-8	INLINE
S-C069	4000-6	INLINE

CHECK VALVES

NEW STAR NUMBER	REPLACEMENT FOR	TYPE
S-8444	KN-23000	
S-8445	KN-23010	
S-A275	229603	SC-2
S-A558	KN-23040	
S-A480	800370	SC-3
S-E424	800372	SC-3
S-E598	800373	SC-3
S-C573	800376	SC-3
S-C617	280479	DC-1
S-C572	289296	DC-4
S-A269	278614	DC-4

DRAIN VALVES

NEW STAR NUMBER	REPLACEMENT FOR	TYPE
S-8884	12105	MANUAL
S-A271	281923	DV-2
S-D970	284412	DV-2

TRACTOR PROTECTION VALVES

NEW STAR NUMBER	REPLACEMENT FOR	TYPE
S-8887	279000	TP-3
S-A274	288605	TP-5

PRESSURE REDUCING VALVE

NEW STAR NUMBER	REPLACEMENT FOR	TYPE
S-C568	283590	RV-1
S-D813	101135	RV-1
S-D871	278427	RV-1
S-D872	288084	RV-1
S-D809	279015	RV-1
S-D696	279926	RV-1
S-D958	281857	RV-1
S-E279	KN-31070	

PRESSURE PROTECTION VALVES

NEW STAR NUMBER	REPLACEMENT FOR	TYPE
S-D817	277147	PR-2
S-D822	277148	PR-2
S-D668	277227	PR-2
S-A273	286500	PR-4
S-B898	288323	PR-4
S-C089	KN-31000	
S-C088	90554107	

PRESSURE INVERSION VALVES

NEW STAR NUMBER	REPLACEMENT FOR	TYPE
S-C567	281459	TR-3
S-D816	281318	TR-3
S-D877	101781	TR-3
S-D821	280758	TR-3

HORN VALVES

NEW STAR NUMBER	REPLACEMENT FOR	TYPE
S-C566	228928	HV-3
S-C459	1630	PLASTIC

RELAY VALVES

NEW STAR NUMBER	REPLACEMENT FOR	TYPE
S-5865	279180	R-6
S-A147	279952	R-6
S-A143	103081	R-7
S-9174	286370	R-8
S-6006	102626	R-12V
S-D879	104561	R-12V
S-D878	103912	R-12V
S-6006A	103009	R-12H
S-D880	065125	R-12H
S-D812	104165	R-12H
S-8255A	103028	R-14V
S-D882	106313	R-14V
S-D881	103833	R-14V
S-8255	103010	R-14H
S-A561	103294	R-14H
S-D883	103835	R-14H
S-C517	065145	BP-R1
S-C518	065146	BP-R1
S-4898	KN-28060	
S-6085	KN-28500	RG-2
S-6086	KN-28510	RG-2
S-6029	KN-28520	RG-2



AIR SYSTEM COMPONENTS



RELAY-EMER. VALVES

NEWSTAR NUMBER	REPLACEMENT FOR	TYPE
S-7558	281865	RE-6
S-9160	12352	
S-9322	KN-30400	EE
S-A956	A-1000	
S-B239	110200	

SPRINGBRAKE CONTROL VALVES

NEWSTAR NUMBER	REPLACEMENT FOR	TYPE
S-A272	286364	SR-1
S-A149	103061	SR-2
S-A150	287376	SR-2
S-A151	101112	SR-4
S-A152	101622	SR-4
S-A142	65437	SR-5
S-A530	KN-26000	RT-4

BRAKE FOOT VALVES

NEWSTAR NUMBER	REPLACEMENT FOR	TYPE
S-8361	277863	E-3
S-E692	279950	E-5
S-4771	286171	E-6
S-A146	284760	E-7
S-C571	288383	E-7
S-E576	101818	E-7
S-E694	800629	E-8P
S-E630	800632	E-10P

BRAKE HAND VALVES

NEWSTAR NUMBER	REPLACEMENT FOR	TYPE
S-A140	KN-20541	
S-10277	276270	TC-2

SWITCHES

NEWSTAR NUMBER	REPLACEMENT FOR	TYPE
S-4719	13250	
S-A264	228600	SL-4
S-4817	505027C1	
S-A266	279416	LP-3
S-A265	228750	LP-3
S-D482	101670	LP-3
S-D973	276599	LP-3
S-D814	277155	LP-3
S-D815	284793	LP-3
S-C565	228165	DS-1
S-C570	286543	DS-2

SOLENOID VALVES

NEWSTAR NUMBER	REPLACEMENT FOR	TYPE
S-C293	90054075	OPEN
S-8931	KN-68230	CLOSED
S-9367	KN-68237	CLOSED
S-8286	3035342	FUEL
S-9366	3035344	FUEL

AIR DRYER COMPONENTS

NEWSTAR NUMBER	REPLACEMENT FOR	TYPE
S-A323	109994	ADSP CART.
S-A473	103981	AD-4 CART.
S-A474	107796	AD-9 CART.
S-A568	5005037	AD-9 PURGE
S-C680	109578	AD-9 HTR.
S-E277	109579	AD-9 HTR.
S-D810	800405	AD-9 PURGE ASSY.
S-E278	5004338	AD-9 PURGE ASSY.
S-E856	107799	AD-9 CK. VLV.
S-E857	107800	AD-9 CK. VLV.
S-E854	109495	ADSP HTR.
S-E855	109496	ADSP HTR.
S-F466	A-72420	ALCOHOL EVAP.
S-E859	800350	ST-4

HEIGHT CONTROL VALVES SUSPENSION VALVES

NEWSTAR NUMBER	REPLACEMENT FOR	TYPE
S-9978	KN-27000	
S-8481	H450AJ	
S-8692	H450AM	
S-5965	H450CE	
S-A194	H500	
S-E844	H500CB	
S-E845	H500CF	
S-E847	H500CG	
S-E846	H500FS	
S-F316	H600	
S-8718	90054007	
S-9434	90554241	
S-E693	90554271	
S-E878	5549706	
S-E879	4992909	
S-E880	4992908	
S-E881	5549704	
S-E882	5549703	
S-E883	22069066	
S-E884	5549705	
S-E978	60826-000	
S-C322	SRK168	
S-C292	90054079	
S-C293	90054075	
S-F174	90054088	
S-E464	90554662	

LINKAGE PILOT SOLENOID SELECTOR AXLE LIFT

MISC. VALVES

NEWSTAR NUMBER	REPLACEMENT FOR	TYPE
S-7873	1653421C91	GK-4
S-8797	134-3	SEAT
S-8288	FUEL SHUTOFF-12V	
S-9366	FUEL SHUTOFF-24V	

SERVICE BRAKE CHAMBERS

NEWSTAR NUMBER	REPLACEMENT FOR	TYPE
S-9812	TYPE 12	
S-9813	TYPE 16	
S-9814	TYPE 20	
S-9815	TYPE 24	
S-5630	TYPE 30	

SPRINGBRAKES

NEWSTAR NUMBER	REPLACEMENT FOR	TYPE
S-D603	TYPE 30/30	
S-B297	TYPE24/30	
S-E713	TYPE 24/24	

SLACK ADJUSTERS

NEWSTAR NUMBER	REPLACEMENT FOR	TYPE
S-9861	1.60-37 X 6	
S-9644	1.60-37 X 5-6-7	
S-9643	1.50-28 X 5-6	
S-9862	1.50-28 X 5.5-6.5	
S-9863	1.50-28 X 5-6-7	
S-9874	1.50-10 X 4.5-5.5-6.5	
S-9864	1.50-10 X 4.5-5.5	
S-9523	1.50-10 X 5.5-6.5	
S-9865	1.50-10 X 5-6	
S-9866	1.25-10 X 5-6	
S-9867	1.25-10 X 5-6-7	
S-9868	1.25-10 X 4.5-5.5	
S-9869	1.25-10 X 4.5-5.5 RH	
S-9999	1.25-10 X 4.5-5.5 LH	

HUBCAPS

NEWSTAR NUMBER	REPLACEMENT FOR	TYPE
S-B359	340-4975	
S-B360	343-4009	
S-B361	343-4013	
S-B358	343-4024	
S-B362	343-4075	
S-B363	343-4095	
S-B364	343-4249	
S-B365	359-5990	
S-E781	359-5995	
S-5285	330-3009	

GLADHANDS

NEWSTAR NUMBER	REPLACEMENT FOR	TYPE
S-10043	11451	
S-10044	11452	
S-10045	11450	
S-10046	11444	
S-10047	11445	

All reference to BENDIX®, HALDEX®, NEWAY, SEALCO, and WABCO part numbers and trademarks are for identification purposes only. There is no intent to represent these parts as made by these manufacturers.

Copyright © 2005 S & S Truck Parts, Inc. All rights reserved.

LATEST ADDITIONS TO OUR CATALOG

ALL PARTS SUPPLIED ARE S & S/NEWSTAR. USE OF OTHER MANUFACTURERS' NAMES, PART NUMBERS, OR TRADEMARKS ARE FOR INFORMATIONAL AND IDENTIFICATION PURPOSES ONLY. PRICES ARE SUBJECT TO CHANGE OR WITHDRAWAL WITHOUT NOTICE.



INTERCHANGE INDEX

Replacement for ARVIN MERITOR

NEW★STAR NUMBER	REPLACEMENT FOR	PAGE
S-3145	.2758-A-53	.64
S-A943	.A1-2297-M-6461	.61
S-A173	.A2-3722-G-501	.62
S-7598	.A3261G319	.71
S-E904	.A-3280-Q-9455	.50
S-D971	.A-3280-X-9072	.51
S-3502	.A3-3722-E-421	.62
S-3886	.A-3787-N-14	.63
S-C120	.A-3787-Q-17	.63
S-E049	.KIT-1125	.69
S-E904	.KIT-5385	.50
S-A701	.KIT-8000	.69
S-E061	.KIT-8000HD	.69
S-E042	.KIT-8004	.69
S-E045	.KIT-8029	.69
S-E809	.KIT-8042	.70
S-E811	.KIT-8048	.70
S-E812	.KIT-8078A	.70
S-E053	.KIT-8081	.69
S-E813	.KIT-8289	.70
S-E052	.KIT-8824HD	.69
S-E808	.KIT-9078	.70
S-E046	.KIT-9094	.69
S-E039	.R507000	.69
S-E057	.R507002	.69
S-E047	.R507004	.69
S-E040	.R507005	.69
S-E063	.R507008	.69
S-E062	.R507010	.69
S-E058	.R507014	.69
S-E059	.R507015	.69
S-E064	.R507057	.69
S-E048	.R507063	.69
S-E054	.R507064	.69
S-E060	.R507068	.69
S-E041	.R507072	.69
S-E043	.R507076	.69
S-E044	.R507077	.69
S-E050	.R507080	.69
S-E051	.R507081	.69
S-E055	.R507094	.69
S-E056	.R507095	.69
S-E065	.R509002	.69
S-E805	.R615002	.70
S-E806	.R615004	.70
S-E807	.R615005	.70
S-E814	.R615008	.70
S-E804	.R615010	.70
S-A238	.R65030U	.76
S-A232	.R65060U	.76
S-A233	.R65071U	.76
S-A239	.R65078U	.76
S-A236	.R65092U	.76
S-A241	.R65111U	.76
S-A231	.R65152U	.76
S-A227	.R65165U	.76
S-A229	.R65172U	.76
S-A234	.R65261U	.76
S-A237	.R65262U	.76
S-A225	.R65263U	.76
S-A230	.R65270U	.76
S-A240	.R65275U	.76

Replacement for ARVIN MERITOR

NEW★STAR NUMBER	REPLACEMENT FOR	PAGE
S-A228	.R65283U	.76
S-A235	.R65298U	.76
S-A226	.R65356U	.76
S-A246	.R69699	.76
S-A245	.R70596	.76
S-A243	.R70597	.76
S-A242	.R70598	.76
S-C300	.R801003	.60
S-C299	.R801004	.60
S-A669	.R801040	.60
S-B888	.R801041	.60
S-A669	.R801042	.60
S-B888	.R801043	.60
S-A669	.R801044	.60
S-B889	.R801071	.60
S-A670	.R801072	.60
S-A670	.R801073	.60
S-B889	.R801074	.60
S-B889	.R801075	.60
S-A670	.R801079	.60
S-A943	.R801700	.61
S-9642	.R822000	.61
S-9523	.R822001	.61
S-9863	.R822003	.61
S-9862	.R822004	.61
S-9861	.R822007	.61
S-9867	.R822008	.61
S-9868	.R822009	.61
S-9866	.R822010	.61
S-9642	.R824000	.61
S-9523	.R824001	.61
S-9863	.R824003	.61
S-9862	.R824004	.61
S-9861	.R824007	.61
S-9867	.R824008	.61
S-9868	.R824009	.61
S-9866	.R824010	.61
S-9869	.R824013	.61
S-9999	.R824014	.61
S-11611	.R950011	.29

Replacement for BATCO

S-9523	.5-201	.61
S-9865	.5-202	.61
S-9642	.5-203	.61
S-9868	.5-214	.61
S-9866	.5-215	.61
S-9869	.5-232	.61
S-9999	.5-233	.61
S-9862	.5-237	.61
S-9643	.5-238	.61
S-9861	.5-240	.61

Replacement for BENDIX

S-4929	.11119	.71
S-4967	.11122	.71
S-5046	.11466	.71
S-5030	.11467	.71
S-5085	.11468	.71
S-7194	.33320	.71
S-7193	.33321	.71
S-5009	.33338	.71

Replacement for BENDIX CONT'D

NEW★STAR NUMBER	REPLACEMENT FOR	PAGE
S-7209	.33376	.71
S-7203	.33377	.71
S-5010	.33400	.71
S-7217	.33580	.71
S-5135	.33581	.71
S-3050	.33582	.71
S-7598	.33584	.71
S-7720	.33606	.71
S-7212	.33607	.71
S-7220	.33655	.71
S-7196	.33656	.71
S-5137	.33714	.71
S-5138	.33715	.71
S-7206	.33716	.71
S-7192	.33717	.71
S-A917	.55245	.72
S-A782	.55250	.72
S-A916	.55251	.72
S-C671	.55252	.73
S-10130	.55849	.73
S-10131	.55850	.73
S-E585	.94010	.73
S-D880	.065125	.10
S-C517	.065145	.11
S-C518	.065146	.11
S-9795	.065157	.22
S-C299	.065164	.60
S-C300	.065167	.60
S-B888	.065170	.60
S-A669	.065172	.60
S-A670	.065174	.60
S-B889	.065175	.60
S-B889	.065176	.60
S-A670	.065247	.60
S-E694	.065313	.18
S-E630	.065315	.19
S-A669	.065344	.60
S-C300	.065403	.60
S-A142	.065437	.16
S-B888	.065700	.60
S-A151	.101112	.15
S-D813	.101135	.6
S-A152	.101622	.15
S-D482	.101670	.28
S-D877	.101781	.8
S-9352	.101805	.46
S-E576	.101818	.18
S-A584	.101930	.10
S-C334	.102048	.46
S-C335	.102100	.46
S-9356	.102511	.46
S-6006	.102626	.10
S-9357	.102802	.46
S-6006A	.103009	.10
S-8255	.103010	.11
S-8255A	.103028	.11
S-A149	.103061	.15
S-A143	.103081	.9
S-A561	.103294	.11
S-D881	.103833	.11
S-D883	.103835	.11
S-D878	.103912	.10

INTERCHANGE INDEX

Replacement for BENDIX CONT'D

NEW★ NUMBER	REPLACEMENT FOR	PAGE
S-A473	103981	29
S-D812	104165	10
S-A473	104358	29
S-D879	104561	10
S-B285	106113	21
S-D882	106313	11
S-C336	106932	46
S-C428	107216	46
S-D824	107516	46
S-A474	107794	29
S-A474	107796	29
S-A568	107798	30, 46
S-E856	107799	29
S-E857	107800	29
S-C352	108123	46
S-C337	108367	46
S-8941	108687	64
S-C338	109015	46
S-E854	109495	31
S-E855	109496	31
S-C680	109578	31, 46
S-E277	109579	31, 46
S-E859	109869	30
S-E859	109871	30
S-A323	109994	29
S-11505	110100	18
S-C645	131081	2
S-C291	205105	2
S-E279	217380	8
S-C617	217698	5
S-11607	221154	2
S-8444	227717	4
S-8444	227788	4
S-8445	227870	4
S-8444	227871	4
S-C565	228165	28
S-A264	228600	27
S-A265	228750	28
S-C566	228928	25
S-C403	229505	3
S-A275	229603	4
S-5676	229617	23
S-5676	229635	23
S-A270	229813	3
S-B073	229844	3
S-4922	229859	3
S-8328	229860	3
S-5025	234099	58
S-1797	234100	58
S-1798	234101	58
S-5024	234189	58
S-5023	234226	58
S-5028	234362	58
S-5022	234433	58
S-9195	239357	24
S-A888	240302	24
S-A591	241866	24
S-8721	245835	46
S-9624	248433	24
S-A522	248502	24
S-9977	267051	48
S-9977	267098	48

Replacement for BENDIX CONT'D

NEW★ NUMBER	REPLACEMENT FOR	PAGE
S-9977	267100	48
S-10277	275107	19
S-5675	275175	20
S-A268	275250	20
S-6106	275491	1
S-F496	275491-12	1
S-10277	275509	19
S-11201	275747	17
S-9359	276119	46
S-C339	276120	46
S-9349	276121	46
S-B267	276122	46
S-10277	276270	19
S-A268	276462	20
S-B924	276472	2
S-5675	276566	20
S-5675	276567	20
S-D973	276599	28
S-D817	277147	7
S-D822	277148	7
S-D814	277155	28
S-D668	277227	7
S-11504	277340	8
S-8361	277863	17
S-9869	278294	61
S-9999	278295	61
S-9868	278302	61
S-9866	278303	61
S-9867	278305	61
S-9865	278312	61
S-9523	278321	61
S-9642	278323	61
S-9874	278326	61
S-D871	278427	6
S-A560	278450	20
S-A269	278614	5
S-C340	278614K	46
S-8887	279000	26
S-D809	279015	6
S-5865	279180	9
S-9864	279316	61
S-A266	279416	28
S-A267	279786	20
S-A144	279787	20
S-D696	279926	6
S-E692	279950	17
S-A147	279952	9
S-5865	280375	9
S-C617	280479	5
S-D821	280758	8
S-C341	280758K	46
S-9354	280856	46
S-C342	280857	46
S-C343	280858	46
S-C344	280915	46
S-C345	281084	46
S-9350	281126	46
S-C346	281127	46
S-D816	281318	8
S-C567	281459	8
S-A267	281587	20
S-D958	281857	6

Replacement for BENDIX CONT'D

NEW★ NUMBER	REPLACEMENT FOR	PAGE
S-7558	281860	13
S-7558	281865	13
S-A271	281923	6
S-10129	281946	22
S-C347	282098	46
S-C348	282134	46
S-9358	282812	46
S-C429	282813	46
S-9861	283411	61
S-C568	283590	6
S-C349	283861	46
S-C350	283863	46
S-A143	283932	9
S-7656	284142	2
S-E023	284143	2
S-A535	284358	1
S-D970	284412	6
S-A146	284760	18
S-D815	284793	28
S-D970	284795	6
S-4771	286171	17
S-A272	286364	15
S-9174	286370	9
S-9174	286371	9
S-C570	286453	28
S-A273	286500	7
S-C351	286500K	46
S-9643	286965	61
S-B499	287049	21
S-9169	287238	22
S-9351	287367	46
S-9360	287368	46
S-9355	287370	46
S-A150	287376	15
S-8898	287417	20
S-8898	287600	20
S-C353	287691	46
S-D872	288084	6
S-5677	288239	21
S-B285	288241	21
S-B286	288242	21
S-4922	288251	3
S-9863	288282	61
S-B898	288323	7
S-C571	288383	18
S-A274	288605	26
S-5677	288721	21
S-A145	288746	21
S-9862	288753	61
S-C354	289061	46
S-9625	289144	3
S-E463	289148	3
S-C572	289296	5
S-C355	289352	46
S-C356	289500	46
S-9749	289714	3
S-C357	289714K	47
S-9623	290655	24
S-9256	291054	24
S-E859	298948	30
S-7927	308664	64
S-7928	308665	64

INTERCHANGE INDEX

Replacement for BENDIX CONT'D

NEW STAR NUMBER	REPLACEMENT FOR	PAGE
S-C088	.378414	.7
S-C645	.800154	.2
S-E630	.800318	.19
S-E859	.800350	.2, 30
S-A480	.800370	.4
S-E424	.800372	.4
S-E598	.800373	.4
S-C573	.800376	.4
S-D810	.800405	.30, 47
S-9795	.800516	.22
S-E694	.800583	.18
S-E694	.800629	.18
S-E630	.800632	.19
S-A568	.5004336	.30, 47
S-A568	.5004337	.30, 47
S-E278	.5004338	.30
S-E278	.5004381	.47
S-A568	.5005037	.30, 47
S-A323	.5008414	.29
S-D418	.H5635	.73
S-A917	.MKD184	.72
S-A916	.MKD224	.72
S-E738	.MKD225	.72
S-C671	.MKD236	.73

Replacement for BOSCH

S-11611	.I-487-434-901	.29, 49
---------	----------------	---------

Replacement for BOSTROM

S-5116	.1650	.39
--------	-------	-----

Replacement for BWP

S-9862	.M2577	.61
S-9869	.M2580	.61
S-9999	.M2581	.61
S-9866	.M2582	.61
S-9642	.M435	.61
S-9865	.M452	.61
S-9523	.M457	.61
S-9861	.M474	.61
S-9643	.M638	.61
S-E054	.MK105	.69
S-E058	.MK11	.69
S-E056	.MK112	.69
S-E059	.MK12	.69
S-E808	.MK17	.70
S-E805	.MK19	.70
S-E807	.MK20	.70
S-E814	.MK24	.70
S-E804	.MK26	.70
S-E065	.MK3	.69
S-E061	.MK39HD	.69
S-E062	.MK42	.69
S-E060	.MK43	.69
S-E042	.MK45	.69
S-E039	.MK46	.69
S-E040	.MK47	.69
S-E046	.MK52	.69
S-E049	.MK52A	.69
S-E041	.MK58	.69
S-E044	.MK6	.69
S-E811	.MK61	.70

Replacement for BWP

NEW STAR NUMBER	REPLACEMENT FOR	PAGE
S-E806	.MK63	.70
S-E047	.MK77	.69
S-E045	.MK79	.69
S-E809	.MK81	.70
S-E043	.MK83	.69
S-E064	.MK84	.69
S-E813	.MK90	.70
S-E048	.MK91	.69
S-E050	.MK94	.69
S-E051	.MK95	.69
S-E052	.MK98	.69
S-E057	.MK99	.69

Replacement for C/R

S-A241	.34386	.76
S-A241	.34387	.76
S-A225	.35059	.76
S-A225	.35066	.76
S-A240	.38709	.76
S-A231	.38779	.76
S-A231	.38780	.76
S-A240	.39988	.76
S-A234	.40133	.76
S-A234	.40136	.76
S-A237	.42622	.76
S-A237	.42623	.76
S-A233	.42671	.76
S-A233	.42672	.76
S-A235	.43752	.76
S-A236	.43763	.76
S-A236	.43764	.76
S-A235	.43786	.76
S-A230	.45097	.76
S-A230	.45099	.76
S-A239	.45102	.76
S-A239	.45103	.76
S-A229	.45158	.76
S-A229	.45160	.76
S-A232	.46304	.76
S-A232	.46305	.76
S-A226	.47695	.76
S-A226	.47697	.76
S-A228	.47699	.76
S-A227	.48000	.76
S-A227	.48001	.76
S-A238	.52658	.76

Replacement for Crewson Brunner

S-B888	.CB21102	.60
S-A669	.CB21103	.60
S-A670	.CB22102	.60
S-B889	.CB22103	.60
S-B889	.CB22104	.60
S-C299	.CB24100	.60
S-C300	.CB25100	.60

Replacement for CHELSEA

NEW STAR NUMBER	REPLACEMENT FOR	PAGE
S-C581	.328388-37X	.42
S-E205	.328388-79X	.41
S-C085	.328863X	.40
S-E900	.328865X	.41
S-D523	.329219X	.41
S-D522	.329358X	.40
S-C456	.378884	.40
S-C086	.378978	.40
S-C455	.379640	.40

Replacement for CHRSLER

S-D423	.1269447	.71
S-B007	.924642	.71
S-B006	.924643	.71

Replacement for CUMMINS

S-8288	.3035342	.38
S-9366	.3035344	.38
S-8288	.BM-69973	.38
S-9366	.BM-69973-24	.38

Replacement for DANA®

S-C453	.313042	.51
S-C454	.313630X	.50

Replacement for DELCO

S-E884	.12C-6-1	.33
S-E878	.12C-6-2	.32
S-E880	.4992908	.33
S-E879	.4992909	.33
S-E882	.5549703	.33
S-E881	.5549704	.33
S-E884	.5549705	.33
S-E878	.5549706	.32
S-E879	.22062523	.33
S-E884	.22062524	.33
S-E880	.22062525	.33
S-E882	.22063226	.33
S-E881	.22063227	.33
S-E878	.22063228	.32
S-E883	.22069066	.32
S-E883	.22069147	.32

Replacement for EATON

S-8931	.46805	.38
--------	--------	-----

Replacement for EATON / FULLER

S-8904	.14651	.55
S-3774	.15512	.55
S-2022	.16743	.51
S-4397	.16859	.54
S-3774	.19974	.55
S-A937	.4300810	.55
S-3103	.A-3546	.52
S-3291	.A-3991	.50
S-6529	.A-4041	.51
S-8011	.A-4487	.54
S-8800	.A-4490	.54
S-5494	.A-4491	.54
S-3291	.A-4688	.50
S-9146	.A-4740	.51
S-8030	.A-5000	.50

INTERCHANGE INDEX

Replacement for EATON / FULLER

NEW STAR NUMBER	REPLACEMENT FOR	PAGE
S-E648	A-5013	.53
S-E467	A-5510	.52
S-C462	A-6909	.52
S-E467	A-6910	.52
S-C461	A-6913	.52
S-C460	A-6915	.53
S-E648	A-6918	.53
S-E649	A-7313	.53
S-E650	A-7315	.53
S-E651	A-7318	.53
S-5696	K-1486	.47
S-5743	K-1550	.47
S-4405	K-1566	.47
S-9043	K-1698	.47
S-3307	K-1699	.47
S-9404	K-1826	.47
S-9405	K-1921	.47
S-9406	K-1922	.47
S-9407	K-1935	.47
S-A210	K-2170	.51
S-8336	K-2424	.50
S-E336	K-3121	.55
S-10291	K-3331	.55

Replacement for EUCLID

S-E054	E10244	.69
S-9865	E1063HD	.61
S-E055	E10760	.69
S-E056	E10875	.69
S-9861	E1574HD	.61
S-E057	E1887AHD	.69
S-E058	E2030HD	.69
S-E808	E-2086B	.70
S-E807	E-2090	.70
S-E805	E-2125	.70
S-E039	E2126	.69
S-E040	E2286	.69
S-E814	E2287	.70
S-E059	E2402HD	.69
S-E060	E2403HD	.69
S-9643	E2458	.61
S-9863	E2458HD	.61
S-9862	E2459HD	.61
S-E804	E2469	.70
S-E806	E2696A	.70
S-9869	E2762RH	.61
S-9999	E2763LH	.61
S-A701	E2769	.69
S-E061	E2769SHDR	.69
S-E041	E2821	.69
S-E331	E2826	.71
S-E042	E3484	.69
S-E811	E3520-AHD	.70
S-E062	E3710HD	.69
S-E063	E3710S	.69
S-E043	E3782	.69
S-E044	E3801	.69
S-E045	E3869	.69
S-4929	E3883	.71
S-4967	E3884	.71
S-E809	E3993B	.70
S-E046	E4691	.69

Replacement for EUCLID CONT'D

NEW STAR NUMBER	REPLACEMENT FOR	PAGE
S-9868	E4904	.61
S-E047	E5139	.69
S-5009	E5148	.71
S-7217	E5149	.71
S-5010	E5150	.71
S-7598	E5151	.71
S-7209	E5153	.71
S-7203	E5154	.71
S-5135	E5161	.71
S-3050	E5162	.71
S-5137	E5163	.71
S-5138	E5164	.71
S-7212	E5167	.71
S-7720	E5168	.71
S-7220	E5169	.71
S-7196	E5170	.71
S-7206	E5173	.71
S-7192	E5174	.71
S-7194	E5179	.71
S-7193	E5180	.71
S-E064	E5481A	.69
S-E048	E5515	.69
S-E813	E6078	.70
S-9642	E612HD	.61
S-E049	E6879	.69
S-E050	E7231	.69
S-E051	E7237	.69
S-5085	E7827	.71
S-5030	E7828	.71
S-5046	E7875	.71
S-E052	E9064	.69
S-E812	E9079HD	.70
S-E810	E9080	.70
S-9866	E939	.61
S-9523	E940HD	.61
S-E053	E9644	.69
S-E065	E-KIT-4S	.69

Replacement for FMSI

S-A173	1303	.62
S-3502	2085	.62
S-3502	2086	.62
S-3502	2086-DD	.62
S-6003	2095	.62
S-4641	6056	.63

Replacement for FORD

S-7927	B9T-2634-B	.64
S-7928	B9T-2749-A	.64
S-3145	C1TZ-2634-A	.64
S-5010	C5TZ2261A	.71
S-7212	C8TZ2261-B	.71
S-7720	C8TZ2261-C	.71
S-5138	C9TZ2061A	.71
S-5137	C9TZ2062A	.71
S-3886	CITZ-2A642-A	.63
S-7192	D0TZ2061-A	.71
S-3050	D0TZ2061C	.71
S-7206	D0TZ2062-A	.71
S-5135	D0TZ2062C	.71
S-7212	D1TZ2261-A	.71
S-7217	E0HZ2261A	.71

Replacement for FORD CONT'D

NEW STAR NUMBER	REPLACEMENT FOR	PAGE
S-A916	E6HG-2B120-B	.72
S-A755	F8IZ-2200-CA	.62

Replacement for GM

S-7193	2254354	.71
S-7194	2254355	.71
S-7203	2404321	.71
S-7209	2404322	.71
S-7927	2473916	.64
S-7928	2473917	.64
S-7220	2620632	.71
S-7196	2620633	.71
S-A782	15618891	.72
S-A916	15619099	.72

Replacement for GROVER

S-9749	1630	.25
--------	------	-----

Replacement for GT

S-C058	3200-1A	.43
S-C059	3200-3A	.43
S-C060	3202-1A	.43
S-C061	3202-2E	.43
S-C062	3220-1	.44
S-C065	3222-1	.44
S-C063	3223-1	.44
S-C064	3223-2	.44
S-C066	3224-1	.44
S-C056	3244-1	.42
S-C057	3244-3	.42
S-C069	4000-6	.45
S-C068	4000-8	.45
S-8797	GT134-3	.39

Replacement for GUNITE

S-A669	AS1100	.60
S-B889	AS1101	.60
S-C299	AS1105	.60
S-C300	AS1107	.60
S-B888	AS1119	.60
S-A670	AS1120	.60
S-B888	AS1132	.60
S-A669	AS1133	.60
S-C299	AS1136	.60
S-C300	AS1138	.60
S-A670	AS1140	.60
S-B889	AS1141	.60
S-C022	D6153	.74
S-E743	D6176	.74

Replacement for HADLEY

S-8481	H-00450-AJ	.32
S-8692	H-00450-AM	.32
S-5965	H-00450-CE	.35
S-5965	H-00450-CR	.35
S-E844	H500CB	.34
S-E845	H500CF	.34
S-E847	H500CG	.34
S-E846	H500FS	.34
S-A194	H500HCV	.35
S-F316	H600	.34

INTERCHANGE INDEX

Replacement for HENDRICKSON

NEW STAR NUMBER	REPLACEMENT FOR	PAGE
S-E978	.57977-000	.36
S-E978	.60826-000	.36

Replacement for INTERNATIONAL TRUCK

S-5085	.1646988C91	.71
S-7873	.1653421C91	.39
S-A782	.1658-443C91	.72
S-9127	.1658-820C1	.27
S-A917	.1669-311C91	.72
S-5965	.1670556C91	.35
S-C022	.2007173C	.74
S-3145	.233009R1	.64
S-3886	.233010R1	.63
S-5116	.244283R91	.39
S-10131	.2501838C91	.73
S-10130	.2501839C91	.73
S-10130	.2509253C91	.73
S-10131	.2509254C91	.73
S-E585	.254468C	.73
S-7598	.260551C91	.71
S-5135	.341035C91	.71
S-3050	.341036C91	.71
S-5137	.341037C91	.71
S-5138	.341038C91	.71
S-11177	.3531661C2	.74
S-E743	.3531662C2	.74
S-A173	.388912C91	.62
S-C120	.388914C1	.63
S-A140	.476356C92	.19
S-4967	.55070R91	.71
S-5965	.574696C91	.35
S-A917	.582024C91	.72
S-A917	.582028C	.72
S-9093	.598860C1	.27
S-5009	.684834R91	.71
S-5010	.684835R91	.71
S-5030	.878977R92	.71
S-5085	.897757R93	.71
S-5046	.965563R91	.71
S-E738	.990953C	.72
S-D418	.990956C91	.73

Replacement for KNORR

S-9639	.AE-4170	.48
S-9976	.DR-3500	.48
S-11611	.I-85127-004	.29, 49

Replacement for LELAND

S-9643	.L1308	.61
S-9869	.L1379	.61
S-9999	.L1380	.61
S-9862	.L1648	.61
S-9642	.L196	.61
S-9868	.L2494	.61
S-9865	.L562	.61
S-9861	.L841	.61
S-9523	.L845	.61

Replacement for MACK

S-8481	.20-QE-3126-P2	.32
S-8692	.20-QE-3191	.32
S-C566	.20-QE-39311	.25

Replacement for MAN

NEW STAR NUMBER	REPLACEMENT FOR	PAGE
S-9976	.81-52101-6146	.48

Replacement for MERCEDES BENZ

S-9639	.001-431-87-06	.48
S-9639	.001-431-89-06	.48
S-9639	.001-431-93-06	.48
S-9976	.002-431-00-06	.48
S-9976	.002-431-49-06	.48
S-9976	.002-431-52-06	.48
S-9976	.002-431-60-06	.48
S-9976	.002-431-63-06	.48

Replacement for MIDLAND

S-10046	.11444	.59
S-10047	.11445	.59
S-10045	.11450	.59
S-10043	.11451	.59
S-10044	.11452	.59
S-8884	.12105	.6
S-9160	.12352	.13
S-5022	.18090	.58
S-5023	.18120	.58
S-5024	.18160	.58
S-5025	.18200	.58
S-1797	.18240	.58
S-1798	.18300	.58
S-5028	.18360	.58
S-C562	.A-25079	.24
S-F466	.A-72420	.39
S-6106	.KN-18530	.1
S-A535	.KN-18534	.1
S-5675	.KN-20021	.20
S-5677	.KN-20025	.21
S-A276	.KN-20030	.23
S-A276	.KN-20031	.23
S-C734	.KN-20033	.23
S-9169	.KN-20035	.22
S-A140	.KN-20541	.19
S-11528	.KN-20611	.23
S-11529	.KN-20615	.22
S-9623	.KN-20900	.24
S-9624	.KN-20901	.24
S-A522	.KN-20903	.24
S-D970	.KN-21021	.6
S-8361	.KN-22100	.17
S-4771	.KN-22140	.17
S-4771	.KN-22150	.17
S-8444	.KN-23000	.4
S-8445	.KN-23010	.4
S-A558	.KN-23040	.4
S-C573	.KN-23060	.4
S-A271	.KN-24000	.6
S-D970	.KN-24005	.6
S-A269	.KN-25060	.5
S-C572	.KN-25080	.5
S-A530	.KN-26000	.16
S-9978	.KN-27000	.32
S-4898	.KN-28060	.12
S-6670	.KN-28071	.12
S-6085	.KN-28500	.12
S-6086	.KN-28510	.12
S-6029	.KN-28520	.12

Replacement for MIDLAND CONT'D

NEW STAR NUMBER	REPLACEMENT FOR	PAGE
S-C361	.KN-28600K	.47
S-9322	.KN-30400	.13
S-C089	.KN-31000	.7
S-C089	.KN-31001	.7
S-E279	.KN-31070	.8
S-7656	.KN-31200	.2
S-7656	.KN-31400	.2
S-4922	.KN-32005	.3
S-8328	.KN-32011	.3
S-C403	.KN-32030	.3
S-9749	.KN-32041	.3
S-11452	.KN-34110	.26
S-9861	.KN-44041	.61
S-9644	.KN-44042	.61
S-9643	.KN-44051	.61
S-9862	.KN-44061	.61
S-9863	.KN-44071	.61
S-9642	.KN-47001	.61
S-9864	.KN-47002	.61
S-9523	.KN-47011	.61
S-9865	.KN-47081	.61
S-9866	.KN-48001	.61
S-9867	.KN-48002	.61
S-9868	.KN-48031	.61
S-9869	.KN-49000	.61
S-9999	.KN-49010	.61
S-8931	.KN-68230	.38
S-9367	.KN-68237	.38
S-C358	.RN10BX	.47
S-9361	.RN10HK	.47
S-9364	.RN10HL	.47
S-9362	.RN10HM	.47
S-C359	.RN10HR	.47
S-C360	.RN10HV	.47
S-11201	.SN-4017A	.17

Replacement for NATIONAL

S-A225	.370001A	.76
S-A226	.370003A	.76
S-A227	.370005A	.76
S-A228	.370006A	.76
S-A229	.370021A	.76
S-A230	.370022A	.76
S-A231	.370023A	.76
S-A232	.370025A	.76
S-A233	.370031A	.76
S-A240	.370033A	.76
S-A234	.370036A	.76
S-A235	.370037A	.76
S-A241	.370047A	.76
S-A236	.370048A	.76
S-A237	.370065A	.76
S-A238	.370069A	.76
S-A239	.370131A	.76
S-A236	.370182A	.76
S-A235	.370338A	.76
S-A234	.370349A	.76
S-A237	.376590A	.76

INTERCHANGE INDEX

Replacement for NEWAY

NEW STAR NUMBER	REPLACEMENT FOR	PAGE
S-87189005400736
S-C2939005407537
S-C2929005407937
S-F1749005408825
S-C617900541385
S-C088905541077
S-94349055424149
S-103509055461537
S-E4649055466237
S-E464K91001437
S-11200K91005837
S-C322SRK16836

Replacement for RVI

S-96395000-788-50348
--------	-------------------	---------

Replacement for SCANIA

S-9977110708248
S-997729354648
S-997733385148

Replacement for SEALCO

S-C562019024
S-B2841000-5A14
S-C36210-547
S-C36310-5 WD47
S-1141711017016
S-1141811017116
S-C36411018547
S-1141911019116
S-B23911020014
S-C36511020147
S-1142011031016
S-1142111031516
S-C36611840047
S-A956A-1000S14

Replacement for STEMCO

S-A234307-071376
S-A237307-072376
S-A232307-074376
S-A235307-074476
S-A225308-083676
S-A239308-085576
S-A236308-086476
S-A230309-090376
S-A233309-090476
S-A231309-091276
S-A241309-093576
S-A238309-094876
S-A227309-096076
S-A229309-096476
S-A228309-097076
S-A226309-097376
S-5285330-300977
S-B359340-497577
S-B360343-400977
S-B361343-401377
S-B358343-402477
S-B362343-407577
S-B363343-409577
S-B363343-409877

Replacement for STEMCO CONT'D

NEW STAR NUMBER	REPLACEMENT FOR	PAGE
S-B364343-424977
S-B365359-599077
S-E781359-599577

Replacement for TIMKEN

S-A30357275
S-A30458075
S-A305592A75
S-A306594A75
S-A307598A75
S-A30865375
S-A30966375
S-C525372075
S-C526378275
S-D7152862275
S-D7142868275
S-A3103952075
S-A3113959075
S-E0384522075
S-A0504782075
S-A0514789075
S-A074H71531175
S-A075H71533475
S-A076H71534375
S-A312HM21201175
S-A313HM21204775
S-A314HM21204975
S-A315HM21821075
S-A316HM21824875
S-A317HM51841075
S-A318HM51844575

Replacement for VOLVO

S-9977105504748
S-9977119353248

Replacement for WABCO

S-11611432-410-020-229
S-11611432-410-020-249
S-11611432-420-220-229
S-11611432-420-220-249
S-9434464-002-443-049
S-C381897-120-536-458
S-C382897-120-546-458
S-9639934-102-250-048
S-A584934-702-250-010
S-9976975-303-473-048

Replacement for WAGNER

S-E331F101271
S-E144F11239871
S-B139F125171
S-B290F1653471
S-B291F1653571
S-C419F17930A71
S-11590F206171
S-11591F226171
S-5009F2448971

Replacement for WAGNER CONT'D

NEW STAR NUMBER	REPLACEMENT FOR	PAGE
S-7217F2615971
S-5010F2617271
S-7598F2618171
S-B134F279671
S-4967F284271
S-7209F3234971
S-7203F3235071
S-E215F352771
S-5085F4208271
S-5046F4326071
S-5137F4337571
S-5138F4337671
S-5135F4338371
S-3050F4338471
S-D951F441971
S-D423F54471
S-5030F5469971
S-C417F5940271
S-C418F5940371
S-B300F608671
S-E296F635371
S-E350F635471
S-4929F66171
S-B067F663071
S-7720F7123871
S-7206F7350071
S-7192F7350171
S-B293F736871
S-B292F737971
S-7212F7874371
S-7220F7874471
S-7196F7874571
S-7194F885271
S-7193F885371
S-B006F937571
S-B007F937671

Replacement for MISC. INDUSTRY INTERCHANGES

S-E331101271
S-E331106701671
S-B067106775771
S-E14411239871
S-B139125171
S-117331308ENS2068
S-117351308ENS20 KIT68
S-117251308QNS2067
S-117271308QNS20 KIT67
S-117371443ESNS2068
S-117391443ESNS20 KIT68
S-C41917930A71
S-11590206171
S-11591226171
S-50092448971
S-50102617271
S-4967284271
S-E215352771
S-50303615371
S-50463617071
S-50853634071
S-51373703371

INTERCHANGE INDEX

Replacement for MISC. INDUSTRY INTERCHANGES

NEW★STAR NUMBER	REPLACEMENT FOR	PAGE
S-5138	.37034	.71
S-7209	.37091	.71
S-7203	.37092	.71
S-7212	.37149	.71
S-7720	.37152	.71
S-5135	.37167	.71
S-3050	.37168	.71
S-7217	.37180	.71
S-7598	.37222	.71
S-7220	.37240	.71
S-7196	.37241	.71
S-7206	.37252	.71
S-7192	.37253	.71
S-11713	.4311ENS20	.66
S-11715	.4311ENS20 KIT	.66
S-11714	.4311ENS23	.66
S-11716	.4311ENS23 KIT	.66
S-D951	.4419	.71
S-11705	.4515QNS20	.66
S-11707	.4515QNS20 KIT	.66
S-11706	.4515QNS23	.66
S-11708	.4515QNS23 KIT	.66
S-11721	.4515X3NS20	.67
S-11723	.4515X3NS20 KIT	.67
S-11722	.4515X3NS23	.67
S-11724	.4515X3NS23 KIT	.67
S-11729	.4702Q+NS20	.68
S-11731	.4702Q+NS20 KIT	.68
S-11709	.4707Q+NS20	.66
S-11711	.4707Q+NS20 KIT	.66
S-11710	.4707Q+NS23	.66
S-11712	.4707Q+NS23 KIT	.66
S-11717	.4709ES2NS20	.67
S-11719	.4709ES2NS20 KIT	.67
S-11718	.4709ES2NS23	.67
S-11720	.4709ES2NS23 KIT	.67
S-4929	.48175H	.71
S-D423	.544	.71
S-C417	.59402	.71
S-C418	.59403	.71
S-E296	.6353	.71
S-E350	.6354	.71
S-4929	.661	.71
S-B067	.6630	.71
S-C419	.7035410	.71
S-D951	.7348976	.71
S-B293	.7368	.71
S-D423	.7373718	.71
S-B139	.7410830	.71
S-E144	.7411070	.71
S-E215	.7539267	.71
S-B134	.805223	.71
S-B290	.807356	.71
S-B291	.807357	.71
S-B067	.8333648	.71
S-7194	.8852	.71
S-7193	.8853	.71
S-B292	.A1484	.71
S-B300	.A556	.71
S-B293	.A6110	.71
S-5023	.D12	.58
S-5024	.D16	.58

Replacement for MISC. INDUSTRY INTERCHANGES

NEW★STAR NUMBER	REPLACEMENT FOR	PAGE
S-5025	.D20	.58
S-1797	.D24	.58
S-C381	.D24LS	.58
S-1798	.D30	.58
S-C382	.D30LS	.58
S-5028	.D36	.58
S-5022	.D9	.58

Replacement for INDUSTRY MODEL TYPES

S-9812	.12SC	.57
S-9813	.16SC	.57
S-9814	.20SC	.57
S-E713	.2424-TI	.56
S-B297	.2430-TI	.56
S-9815	.24SC	.57
S-7930	.3030-SI	.56
S-D603	.3030-TI	.56
S-5630	.30SC	.57

INTERCHANGE INDEX - LISTED BY OUR **NEW★STAR** NUMBER

NEW★STAR NUMBER	PAGE	NEW★STAR NUMBER	PAGE	NEW★STAR NUMBER	PAGE
S-1797	.58	S-7558	.13	S-9639	.48
S-1798	.58	S-7598	.71	S-9642	.61
S-2022	.51	S-7656	.2	S-9643	.61
S-3050	.71	S-7720	.71	S-9644	.61
S-3103	.52	S-7873	.39	S-9749	.3, 25
S-3145	.64	S-7927	.64	S-9795	.22
S-3291	.50	S-7928	.64	S-9812	.57
S-3307	.47	S-7930	.56	S-9813	.57
S-3502	.62	S-8011	.54	S-9814	.57
S-3774	.55	S-8030	.50	S-9815	.57
S-3886	.63	S-8255	.11	S-9861	.61
S-4252	.72	S-8255A	.11	S-9862	.61
S-4397	.54	S-8288	.38	S-9863	.61
S-4405	.47	S-8328	.3	S-9864	.61
S-4641	.63	S-8336	.50	S-9865	.61
S-4719	.27	S-8361	.17	S-9866	.61
S-4771	.17	S-8444	.4	S-9867	.61
S-4817	.27	S-8445	.4	S-9868	.61
S-4898	.12	S-8481	.32	S-9869	.61
S-4922	.3	S-8692	.32	S-9874	.61
S-4929	.71	S-8718	.36	S-9976	.48
S-4967	.71	S-8721	.46	S-9977	.48
S-5009	.71	S-8797	.39	S-9978	.32
S-5010	.71	S-8800	.54	S-9999	.61
S-5022	.58	S-8884	.6	S-10043	.59
S-5023	.58	S-8887	.26	S-10044	.59
S-5024	.58	S-8898	.20	S-10045	.59
S-5025	.58	S-8904	.55	S-10046	.59
S-5028	.58	S-8931	.38	S-10047	.59
S-5030	.71	S-8941	.64	S-10129	.22
S-5046	.71	S-9043	.47	S-10130	.73
S-5085	.71	S-9093	.27	S-10131	.73
S-5116	.39	S-9127	.27	S-10277	.19
S-5135	.71	S-9137	.57	S-10291	.55
S-5137	.71	S-9146	.51	S-10350	.37
S-5138	.71	S-9160	.13	S-11177	.74
S-5285	.77	S-9169	.22	S-11200	.37
S-5494	.54	S-9174	.9	S-11201	.17
S-5630	.57	S-9195	.24	S-11417	.16
S-5675	.20	S-9256	.24	S-11418	.16
S-5676	.23	S-9322	.13	S-11419	.16
S-5677	.21	S-9349	.46	S-11420	.16
S-5696	.47	S-9350	.46	S-11421	.16
S-5743	.47	S-9351	.46	S-11452	.26
S-5828	.62	S-9352	.46	S-11504	.8
S-5829	.62	S-9353	.47	S-11505	.18
S-5865	.9	S-9354	.46	S-11528	.23
S-5965	.35	S-9355	.46	S-11529	.22
S-6003	.62	S-9356	.46	S-11590	.71
S-6006	.10	S-9357	.46	S-11591	.71
S-6006A	.10	S-9358	.46	S-11607	.2
S-6029	.12	S-9359	.46	S-11611	.29, 49
S-6085	.12	S-9360	.46	S-11705	.66
S-6086	.12	S-9361	.47	S-11706	.66
S-6106	.1	S-9362	.47	S-11707	.66
S-6529	.51	S-9364	.47	S-11708	.66
S-6670	.12	S-9366	.38	S-11709	.66
S-7192	.71	S-9367	.38	S-11710	.66
S-7193	.71	S-9404	.47	S-11711	.66
S-7194	.71	S-9405	.47	S-11712	.66
S-7196	.71	S-9406	.47	S-11713	.66
S-7203	.71	S-9407	.47	S-11714	.66
S-7206	.71	S-9434	.35, 49	S-11715	.66
S-7209	.71	S-9523	.61	S-11716	.66
S-7212	.71	S-9623	.24	S-11717	.67
S-7217	.71	S-9624	.24	S-11718	.67
S-7220	.71	S-9625	.3	S-11719	.67

INTERCHANGE INDEX - LISTED BY OUR **NEW★STAR** NUMBER

NEW★STAR NUMBER	PAGE	NEW★STAR NUMBER	PAGE	NEW★STAR NUMBER	PAGE
S-11720	.67	S-A304	.75	S-B889	.60
S-11721	.67	S-A305	.75	S-B898	.7
S-11722	.67	S-A306	.75	S-B924	.2
S-11723	.67	S-A307	.75	S-C022	.74
S-11724	.67	S-A308	.75	S-C056	.42
S-11725	.67	S-A309	.75	S-C057	.42
S-11727	.67	S-A310	.75	S-C058	.43
S-11729	.68	S-A311	.75	S-C059	.43
S-11731	.68	S-A312	.75	S-C060	.43
S-11733	.68	S-A313	.75	S-C061	.43
S-11735	.68	S-A314	.75	S-C062	.44
S-11737	.68	S-A315	.75	S-C063	.44
S-11739	.68	S-A316	.75	S-C064	.44
S-A050	.75	S-A317	.75	S-C065	.44
S-A051	.75	S-A318	.75	S-C066	.44
S-A074	.75	S-A323	.29	S-C068	.45
S-A075	.75	S-A473	.29	S-C069	.45
S-A076	.75	S-A474	.29	S-C085	.40
S-A140	.19	S-A480	.4	S-C086	.40
S-A142	.16	S-A522	.24	S-C088	.7
S-A143	.9	S-A530	.16	S-C089	.7
S-A144	.20	S-A535	.1	S-C120	.63
S-A145	.21	S-A558	.4	S-C291	.2
S-A146	.18	S-A560	.20	S-C292	.37
S-A147	.9	S-A561	.11	S-C293	.37
S-A149	.15	S-A568	.30, 46, 47	S-C299	.60
S-A150	.15	S-A584	.10	S-C300	.60
S-A151	.15	S-A591	.24	S-C322	.36
S-A152	.15	S-A669	.60	S-C334	.46
S-A173	.62	S-A670	.60	S-C335	.46
S-A194	.35	S-A701	.69	S-C336	.46
S-A210	.51	S-A755	.62	S-C337	.46
S-A225	.76	S-A782	.72	S-C338	.46
S-A226	.76	S-A888	.24	S-C339	.46
S-A227	.76	S-A916	.72	S-C340	.46
S-A228	.76	S-A917	.72	S-C341	.46
S-A229	.76	S-A937	.55	S-C342	.46
S-A230	.76	S-A943	.61	S-C343	.46
S-A231	.76	S-A956	.14	S-C344	.46
S-A232	.76	S-B006	.71	S-C345	.46
S-A233	.76	S-B007	.71	S-C346	.46
S-A234	.76	S-B067	.71	S-C347	.46
S-A235	.76	S-B073	.3	S-C348	.46
S-A236	.76	S-B134	.71	S-C349	.46
S-A237	.76	S-B139	.71	S-C350	.46
S-A238	.76	S-B239	.14	S-C351	.46
S-A239	.76	S-B267	.46	S-C352	.46
S-A240	.76	S-B284	.14	S-C353	.46
S-A241	.76	S-B285	.21	S-C354	.46
S-A242	.76	S-B286	.21	S-C355	.46
S-A243	.76	S-B290	.71	S-C356	.46
S-A245	.76	S-B291	.71	S-C357	.47
S-A246	.76	S-B292	.71	S-C358	.47
S-A264	.27	S-B293	.71	S-C359	.47
S-A265	.28	S-B297	.56	S-C360	.47
S-A266	.28	S-B300	.71	S-C361	.47
S-A267	.20	S-B358	.77	S-C362	.47
S-A268	.20	S-B359	.77	S-C363	.47
S-A269	.5	S-B360	.77	S-C364	.47
S-A270	.3	S-B361	.77	S-C365	.47
S-A271	.6	S-B362	.77	S-C366	.47
S-A272	.15	S-B363	.77	S-C381	.58
S-A273	.7	S-B364	.77	S-C382	.58
S-A274	.26	S-B365	.77	S-C403	.3
S-A275	.4	S-B451	.57	S-C417	.71
S-A276	.23	S-B499	.21	S-C418	.71
S-A303	.75	S-B888	.60	S-C419	.71

INTERCHANGE INDEX - LISTED BY OUR **NEW★STAR** NUMBER

NEW★STAR NUMBER	PAGE	NEW★STAR NUMBER	PAGE	NEW★STAR NUMBER	PAGE
S-C428	.46	S-E038	.75	S-E813	.70
S-C429	.46	S-E039	.69	S-E814	.70
S-C453	.51	S-E040	.69	S-E844	.34
S-C454	.50	S-E041	.69	S-E845	.34
S-C455	.40	S-E042	.69	S-E846	.34
S-C456	.40	S-E043	.69	S-E847	.34
S-C460	.53	S-E044	.69	S-E854	.31
S-C461	.52	S-E045	.69	S-E855	.31
S-C462	.52	S-E046	.69	S-E856	.29
S-C509	.78	S-E047	.69	S-E857	.29
S-C517	.11	S-E048	.69	S-E859	.2, 30
S-C518	.11	S-E049	.69	S-E878	.32
S-C525	.75	S-E050	.69	S-E879	.33
S-C526	.75	S-E051	.69	S-E880	.33
S-C562	.24	S-E052	.69	S-E881	.33
S-C565	.28	S-E053	.69	S-E882	.33
S-C566	.25	S-E054	.69	S-E883	.32
S-C567	.8	S-E055	.69	S-E884	.33
S-C568	.6	S-E056	.69	S-E900	.41
S-C570	.28	S-E057	.69	S-E904	.50
S-C571	.18	S-E058	.69	S-E978	.36
S-C572	.5	S-E059	.69	S-F174	.25
S-C573	.4	S-E060	.69	S-F316	.34
S-C581	.42	S-E061	.69	S-F322	.72
S-C617	.5	S-E062	.69	S-F323	.73
S-C619	.78	S-E063	.69	S-F466	.39
S-C645	.2	S-E064	.69	S-F496	.1
S-C671	.73	S-E065	.69		
S-C680	.31, 46	S-E067	.41		
S-C686	.78	S-E144	.71		
S-C734	.23	S-E205	.41		
S-D418	.73	S-E215	.71		
S-D423	.71	S-E277	.31, 46		
S-D482	.28	S-E278	.30, 47		
S-D522	.40	S-E279	.8		
S-D523	.41	S-E296	.71		
S-D603	.56	S-E331	.71		
S-D668	.7	S-E336	.55		
S-D696	.6	S-E350	.71		
S-D714	.75	S-E424	.4		
S-D715	.75	S-E463	.3		
S-D809	.6	S-E464	.37		
S-D810	.30, 47	S-E467	.52		
S-D812	.10	S-E576	.18		
S-D813	.6	S-E585	.73		
S-D814	.28	S-E598	.4		
S-D815	.28	S-E630	.19		
S-D816	.8	S-E648	.53		
S-D817	.7	S-E649	.53		
S-D821	.8	S-E650	.53		
S-D822	.7	S-E651	.53		
S-D824	.46	S-E692	.17		
S-D871	.6	S-E693	.35		
S-D872	.6	S-E694	.18		
S-D877	.8	S-E713	.56		
S-D878	.10	S-E738	.72		
S-D879	.10	S-E743	.74		
S-D880	.10	S-E781	.77		
S-D881	.11	S-E804	.70		
S-D882	.11	S-E805	.70		
S-D883	.11	S-E806	.70		
S-D951	.71	S-E807	.70		
S-D958	.6	S-E808	.70		
S-D970	.6	S-E809	.70		
S-D971	.51	S-E810	.70		
S-D973	.28	S-E811	.70		
S-E023	.2	S-E812	.70		

ADDITIONAL CATALOGS AVAILABLE



DRIVETRAIN COMPONENTS

INCLUDING: DIFFERENTIAL COMPONENTS
TRANSMISSION COMPONENTS
CLUTCH ASSEMBLIES & COMPONENTS
BEARING KITS & OIL SEALS



DRIVELINE COMPONENTS

INCLUDING: SLIP YOKES
WELD YOKES
END YOKES
FLANGE YOKES
SPLINED STUB ENDS & SHAFTS
CENTER BEARINGS
SURFACE SLEEVES
COUPLING SHAFT KITS
UNIVERSAL JOINTS & STRAP KITS



CHASSIS COMPONENTS

INCLUDING: TIE ROD ENDS
KING PIN KITS
DRAG LINKS
SPRING PINS
SHACKLES
BUSHINGS



STEERING COMPONENTS

INCLUDING: POWER STEERING PUMPS
PUMP MASTER SEAL KITS
STEERING GEAR BOXES
GEARBOX MASTER SEAL KITS
GEARBOX SECTOR SHAFTS, BUSHINGS



PTO COMPONENTS

INCLUDING: COMPLETE PTO ASSEMBLIES
DUMP PUMPS
PTO DRIVELINE COMPONENTS
CABLES
CONTROL VALVES



S & S WARRANTY

We warrant all new parts against defective material or workmanship when such parts are used in appropriate applications. We will NOT extend this warranty to parts where failure or damage was caused by misapplication, accident, or abuse.

Unless otherwise stated, authorization from your salesperson is required to initiate any return for warranty. If our examination shows the parts to be defective, we will replace such parts free of charge. This warranty extends solely to replacement of defective parts; we disclaim liability for labor and/or special or consequential damages of any nature.

If it is necessary to return any parts under this warranty, the buyer agrees to wait for settlement of his claim before any deductions are made in payments to S & S. Any expenses incurred without the consent of S & S will be disallowed.

NEW★STAR

PARTS COMPONENT GROUP



Established in 1954, S & S Truck Parts, Inc. is one of the largest independent suppliers of replacement truck parts in the world. Traditionally known as a drive train gear specialist, S&S has aggressively expanded its product range with the **NEW★STAR** Parts Component Group.

The **NEW★STAR** Product Range includes the following categories: Powertrain, Transmission, Differential, Chassis, Drive Line, PTO/Hydraulic, Power Steering, and Air Brake Parts.

S & S TRUCK PARTS, INC.

600 W. IRVING PARK ROAD , SCHAUMBURG, ILLINOIS 60193
LOCAL PHONE :847-584-2000
TOLL FREE:1-800-621-1553 ORDER DESK
LOCAL FAX :847-584-3000
TOLL FREE FAX :1-800-621-1558
MEXICO TOLL FREE :001-800-727-8373
E-MAIL ADDRESS :INFO@SANDSTRUCK.COM

ALSO THREE CANADIAN LOCATIONS TO SERVE YOU:

6460 KESTREL ROAD
MISSISSAUGA, ONTARIO
L5T 1Z7
TEL : 905-564-7100
FAX : 905-564-3485
1-800-363-4148

19272-96TH AVENUE, UNIT #15
SURREY, BRITISH COLUMBIA
V4N 4C1
TEL : 604-882-2577
FAX : 604-882-3898
1-800-665-4327

16210-114 AVENUE
EDMONTON, ALBERTA
T5M 2Z5
TEL : 780-454-1010
FAX : 780-454-1555
1-800-665-4327



IS A WHOLLY OWNED SUBSIDIARY OF



S & S TRUCK PARTS, INC.

VISIT OUR WEBSITE AT WWW.SANDSTRUCK.COM

AMERICAN EXPRESS, MASTERCARD AND VISA ACCEPTED

