

HARLEY-DAVIDSON MOTOR CO.  
3700 West Juneau Avenue  
Post Office Box 653  
Milwaukee, Wisconsin 53208  
[www.harley-davidson.com](http://www.harley-davidson.com)

99556-10MPA Send address changes or removals to: Catalog List Changes, P.O. Box 514012, Milwaukee, Wisconsin 53203

©2009, H-D. PRINTED IN U.S.A.

HARLEY-DAVIDSON®  
2010 GENUINE MOTOR  
ACCESSORIES &  
GENUINE MOTOR PARTS

## YOUR CUSTOM STARTS HERE

HARLEY-DAVIDSON® 2010 GENUINE MOTOR ACCESSORIES & GENUINE MOTOR PARTS



The only way to get Genuine Motor Accessories and Genuine Motor Parts is through an authorized Harley-Davidson® dealer. For a dealer near you, call toll free 1-800-588-2743 in the U.S.A. and Canada — or use our dealer locator at [Harley-Davidson.com](http://Harley-Davidson.com), where you can also check out Genuine Motor Accessories on the Web.

We care about you. When riding your Harley-Davidson® motorcycle be sure to ride safely, respectfully and within the limits of the law and your abilities. Always wear an approved helmet, proper eyewear and protective clothing and insist your passenger does too. Never ride while under the influence of alcohol or drugs. Know your Harley® motorcycle and read and understand your owner's manual from cover to cover. Sign up for a Harley-Davidson Rider's Edge® Course (call 1-800-588-2743 for a course near you) or a Motorcycle Safety Foundation rider course (call 1-800-446-9227 for a course near you). Protect your privilege to ride by joining the American Motorcyclist Association. Visit [www.ama-cycle.org](http://www.ama-cycle.org) for more information.

The sale or use of these parts or accessories does not grant the purchaser a license or other right under any Harley-Davidson patent.

IMPORTANT – PLEASE READ We have tried to make this catalog comprehensive and factual. All product descriptions (including depictions, specifications, dimensions, measurements, ratings and competitive comparisons) are based on available information at the time of publication. Although such descriptions are believed correct, errors and changes can occur and complete accuracy cannot be guaranteed. Harley-Davidson may make changes at anytime to prices and specifications, and may change or discontinue any of the items depicted in this catalog, without notice and without incurring any obligation.

ATTENTION Vehicles in the configurations shown and the accessories described in this catalog may not be available for sale or use in some locations. Please check with your dealer for complete product details and the latest information.



# CONTENTS

## BY MODEL FAMILY

*Dive right into the quality parts and accessories specific to your model family. We have a great lineup of new items as well as all those time-tested classics. Find the combination that will set your ride apart from the crowd.*



<i>Building Your Perfect Ride</i> .....	04
<i>Finding Your Fit</i> .....	06
<i>Gearing Up for Your Ride</i> .....	08
<i>Defining Your Style</i> .....	10
<i>Realizing Your Dream Bike</i> .....	12

### VRSC™

14

<i>Fit &amp; Function</i> .....	16
<i>Guide to Style</i> .....	18
<i>Inspiration</i> .....	20
<i>Windscreens</i> .....	24
<i>Seating</i> .....	26
<i>Backrests</i> .....	29
<i>Saddlebags &amp; Luggage</i> .....	32
<i>Engine &amp; Chassis Trim</i> .....	35
<i>Wheels &amp; Sprockets</i> .....	42
<i>Brakes</i> .....	44
<i>Engine Guards</i> .....	45
<i>Hand &amp; Foot Controls</i> .....	46
<i>Lighting</i> .....	51

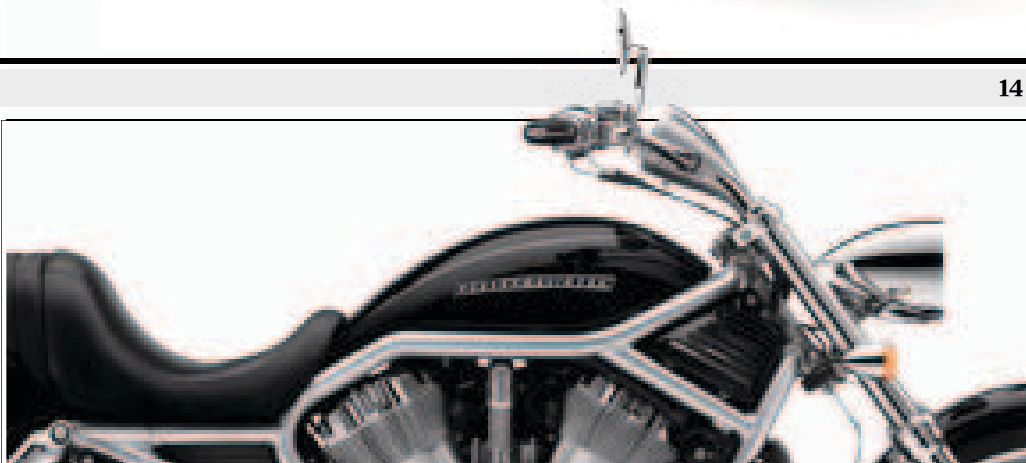

### SPORTSTER®

54

<i>Fit &amp; Function</i> .....	56
<i>Guide to Style</i> .....	58
<i>Inspiration</i> .....	60
<i>XRI200 Accessories</i> .....	64
<i>Windscreens</i> .....	66
<i>Seating</i> .....	69
<i>Backrests &amp; Racks</i> .....	74
<i>Saddlebags &amp; Luggage</i> .....	80
<i>Chassis Trim</i> .....	84
<i>Brakes</i> .....	99
<i>Suspension</i> .....	101
<i>Hand &amp; Foot Controls</i> .....	102
<i>Engine Guards</i> .....	109
<i>Console &amp; Gauges</i> .....	110
<i>Horns, Lighting &amp; License Plates</i> .....	113





**DYNA®**

120

<i>Fit &amp; Function</i> .....	122
<i>Guide to Style</i> .....	124
<i>Inspiration</i> .....	126
<i>Windscreens</i> .....	130
<i>Seating</i> .....	134
<i>Backrests &amp; Racks</i> .....	143
<i>Saddlebags &amp; Luggage</i> .....	151
<i>Suspension</i> .....	157
<i>Chassis Trim</i> .....	160, 171
<i>Brakes</i> .....	169
<i>Hand &amp; Foot Controls</i> .....	174
<i>Engine Guards</i> .....	182
<i>Consoles &amp; Gauges</i> .....	183

**SOFTAIL®**

192

<i>Fit &amp; Function</i> .....	194
<i>Guide to Style</i> .....	196
<i>Inspiration</i> .....	198
<i>Windscreens</i> .....	208
<i>Seating</i> .....	218
<i>Backrests &amp; Racks</i> .....	230
<i>Saddlebags &amp; Luggage</i> .....	243
<i>Suspension</i> .....	258
<i>Chassis Trim</i> .....	260, 283
<i>Brakes</i> .....	280
<i>Hand Controls</i> .....	288
<i>Foot Controls</i> .....	292, 303
<i>Engine Guards</i> .....	300
<i>Gauges &amp; Consoles</i> .....	308

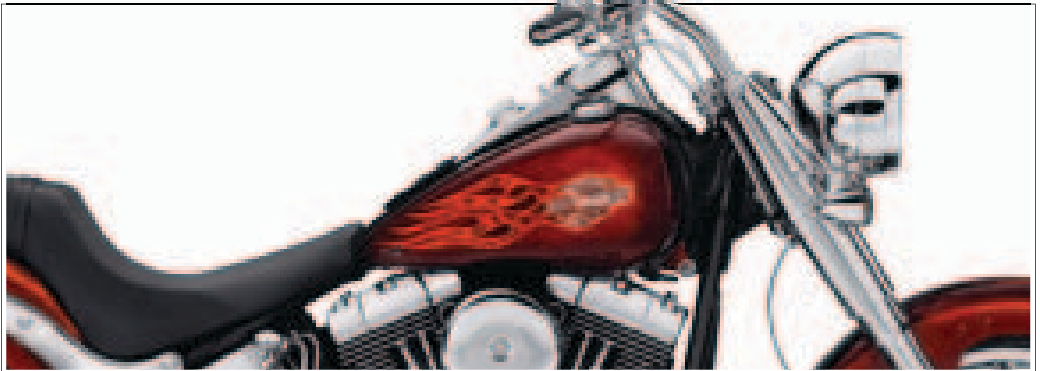
**TOURING**

322

<i>Fit &amp; Function</i> .....	324
<i>Guide to Style</i> .....	326
<i>Inspiration</i> .....	328
<i>Windscreens</i> .....	338
<i>Fairing Lower</i> .....	348
<i>Wind Deflectors</i> .....	352
<i>Seating</i> .....	353
<i>Backrests &amp; Racks</i> .....	368
<i>Tour-Pak® Luggage</i> .....	376
<i>Tour-Pak &amp; Saddlebag Accessories</i> .....	390
<i>Luggage</i> .....	404
<i>Suspension</i> .....	406
<i>Chassis Trim</i> .....	408, 419
<i>Brakes</i> .....	416
<i>Hand &amp; Foot Controls</i> .....	424
<i>Engine Guards &amp; Highway Pegs</i> .....	432
<i>Footboards</i> .....	434
<i>Dash, Console &amp; Gauges</i> .....	439
<i>Trike Accessories</i> .....	456
<i>Sidecar Accessories</i> .....	460

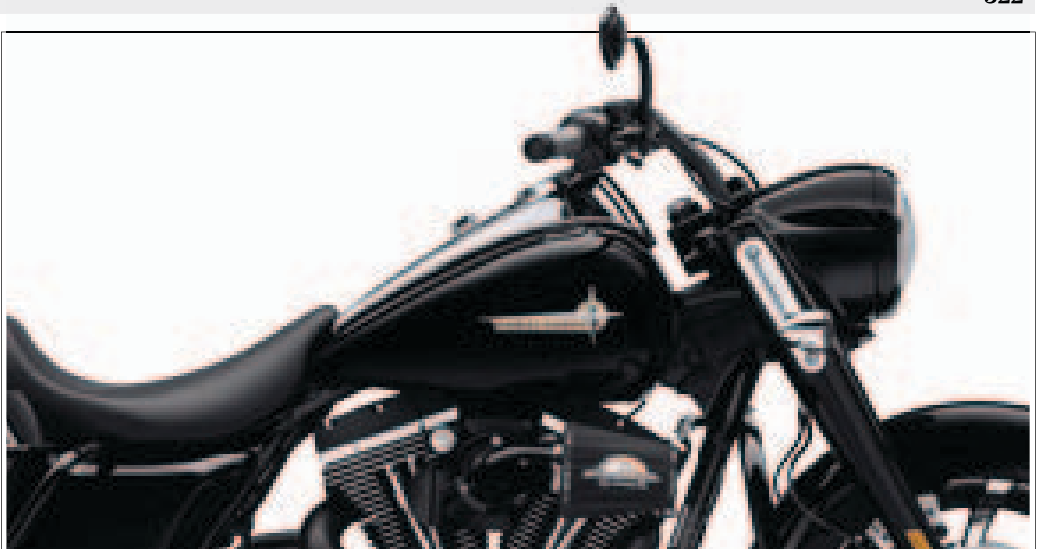

# CONTENTS **BY CATEGORY**

See what else we have to offer with our huge selection of multi-fit parts and accessories. With everything from decorative collections to turn-by-turn navigation systems, you'll find exactly what you need to make your ride one-of-a-kind.

## **SCREAMIN' EAGLE®** 462



<i>Sportster® Performance Kits</i> .....	467
<i>Twin Cam &amp; Evolution Performance Kits</i> .....	468
<i>Air Cleaner Kits &amp; Covers</i> .....	471
<i>Exhaust Systems</i> .....	475
<i>Engine &amp; Transmission Components</i> .....	492
<i>Ignition</i> .....	498
<i>Decorative Accessories</i> .....	500
<i>Specialty Tools</i> .....	501

## **ENGINE REMANUFACTURING** 506



<i>Engine Remanufacturing</i> .....	506
<i>Revolution®, Evolution® &amp; Twin Cam® Engines</i> .....	508
<i>Transmissions</i> .....	511

## **ENGINE TRIM** 512



<i>Oil Coolers</i> .....	514
<i>Fans &amp; Starters</i> .....	515
<i>Derby, Point &amp; Inspection Covers</i> .....	516
<i>Primary &amp; Rocker Box Covers</i> .....	524
<i>Engine &amp; Transmission Covers</i> .....	528
<i>Carb &amp; EFI Cables</i> .....	534
<i>Oil Level Dipsticks</i> .....	536
<i>Cylinder Head Covers</i> .....	538
<i>Air Cleaner Covers</i> .....	540
<i>Hardware Covers &amp; Chrome Hardware</i> .....	542

## **HAND CONTROLS** 548



<i>Hand Grips &amp; Foot Controls</i> .....	550
<i>Foot Pegs &amp; Footboards</i> .....	566
<i>Highway Pegs</i> .....	570
<i>Mirrors</i> .....	572
<i>Handlebars</i> .....	576
<i>Hand Controls &amp; Levers</i> .....	599
<i>Control Cables &amp; Brake Lines</i> .....	606

## **GPS & AUDIO** 616



<i>GPS Navigation</i> .....	617
<i>XM® Portable Audio &amp; Advanced Audio Radio</i> .....	620
<i>Intercom &amp; Communications</i> .....	623
<i>Headsets &amp; Antennas</i> .....	624

## **LIGHTING** 627

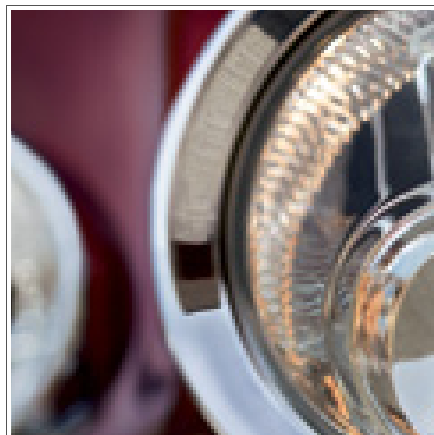

<i>Headlights</i> .....	628
<i>Turn Signals</i> .....	640
<i>Tail &amp; Brake Lamps</i> .....	648
<i>LED Lights</i> .....	652
<i>Horns &amp; Horn Covers</i> .....	658
<i>License Plate Mounts</i> .....	660

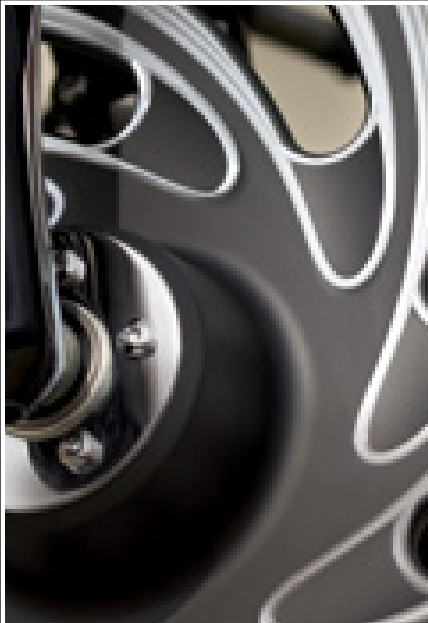
**WHEELS****664**

<i>Custom Wheels</i> .....	665
<i>Sprocket Covers</i> .....	685
<i>Brake Rotors</i> .....	688
<i>Brake &amp; Pulley Hardware</i> .....	690

**LUGGAGE****691**

<i>Sissy Bar &amp; Rack Bags</i> .....	693
<i>Sissy Bar &amp; Fork Bags</i> .....	698
<i>Windshield Bags</i> .....	700
<i>Luggage Accessories</i> .....	704

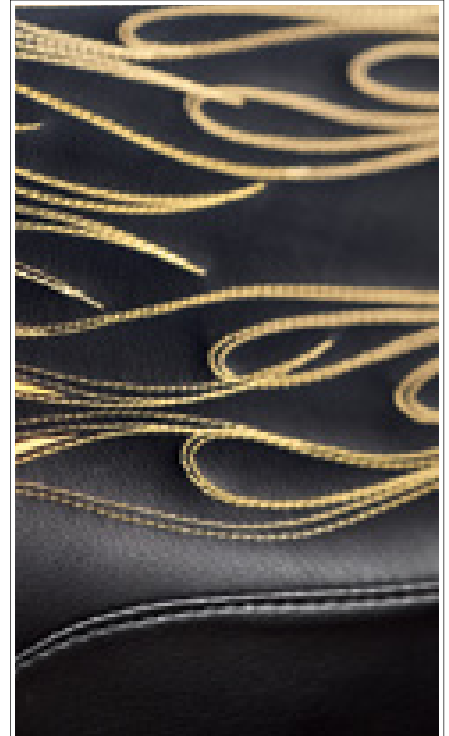
**CUSTOM SEAT PROGRAM****706****PAINT & BODYWORK****710**

<i>Limited Series Custom Paint Sets</i> .....	714
<i>Core Series Custom Paint Sets</i> .....	725
<i>California Kid Paint Sets</i> .....	730
<i>Spectrum Custom Color Program</i> .....	734
<i>Color-Matched Accessories</i> .....	738
<i>Medallions</i> .....	746

**SECURITY & STORAGE****748**

<i>Security Systems</i> .....	749
<i>Locks &amp; Keys</i> .....	752
<i>Storage Covers &amp; Tie-Downs</i> .....	755

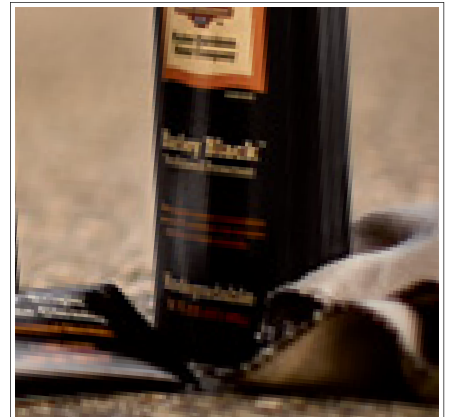
**CLEANING & MAINTENANCE****760**

<i>Surface Care Products</i> .....	762
<i>Battery Chargers</i> .....	772
<i>Tools &amp; Maintenance</i> .....	774
<i>Oil &amp; Lube</i> .....	778
<i>Batteries, Filters &amp; Spark Plugs</i> .....	783
<i>Tires, Brakes &amp; Classic Parts</i> .....	788

**INDEX****795**

<i>Part Number Index</i> .....	795
<i>Alphabetic Index</i> .....	812



STARTING OUT STOCK

DARK SIDE UNLEASHED

COVERED IN CHROME

GEARED UP FOR THE ROAD

# BUILDING YOUR PERFECT RIDE

*Regardless of which bike you choose, any Harley-Davidson® motorcycle can be tailored to match your unique body type, riding style and personality. By adding Harley-Davidson® Genuine Motor Parts and Accessories, any model can become the perfect one-of-a-kind ride. The most important piece of the puzzle is you.*

*Take this Softail® Fat Boy® motorcycle, for example. Look how one model can be tailor-made for different riders and different roads with three completely different approaches to customizing. It's not about what everybody else is doing. It's about what's right for you.*

## **WHERE TO BEGIN?**

Customizing your bike relies on three key elements: Fit, Function and Style. First, your bike needs to be set up to accommodate your physical stature. Second, your bike should be equipped to tackle the demands of the roads you want to ride. And last, your bike should be dressed to show off your personality. [Turn the page for more details.](#)



## TAILOR YOUR RIDE.

*How you fit your motorcycle is a major factor in maximizing comfort and enjoyment. The correct riding position can build confidence when you put your feet down at a stoplight. It can enhance the feeling of control on a winding road. And it can add 100 miles to a day's ride. It's as simple as selecting the right seat, handlebar and ride height.*



### FOUR KEY AREAS

Enhance your feeling of control and confidence with a natural position, having all controls at just the right reach. Consider these four adjustable areas to confirm your riding fit:

#### A. RIDE HEIGHT

*Adjusting the ride height by lowering the suspension may be the first step in fitting the bike to your inseam length. Combining a low-profile suspension and a narrow seat is the easiest way for a shorter rider to fit comfortably on a larger bike.*

#### B. BUTT PLACEMENT

*For maximum comfort, a broad seating surface distributes weight to reduce pressure points, and a narrow, tapered thigh zone provides easier reach to the ground. A stepped seat profile keeps the rider from sliding back during acceleration.*

#### C. HAND POSITION

*Where the bar positions your hands, wrists and arms directly affects how you feel on the motorcycle. The shape of the bar determines your reach to the hand controls and, therefore, your overall comfort and feeling of control.*

#### D. FOOT LOCATION

*A long stretch to the controls or a "knees-high" cramped riding position puts strain on your body after even a short ride. Repositioning your feet on the controls relieves muscle tension, takes pressure off the tail bone, and reduces rider fatigue.*

### STOPPING BY THE FIT SHOP



The more you ride, the more you'll appreciate feeling good in the saddle. But finding the right fit by trial and error can be frustrating. And expensive. Don't go it alone.

*The H-D® Fit Shop experts at your local Harley® dealership are here to share years of experience and priceless tribal knowledge. They've helped thousands of other riders find the perfect combination of seat, suspension, and hand- and foot controls to maximize their riding comfort and enjoyment. Stop by and see for yourself. They're here to help you find your fit.*



**BE PREPARED NO MATTER THE DESTINATION.**

*How you equip your bike for the miles ahead significantly impacts your comfort and convenience. Saddlebags, windshields, luggage racks and passenger backrests all help you get the most out of your ride and keep your options open. And if you need versatility, Harley-Davidson® offers a full lineup of detachable options to keep you ready for any situation.*

**DETACHABLES AND INSTALLATION**

Designed to be installed or removed in seconds, the Harley-Davidson® Detachables accessories give you the flexibility to outfit your bike on the fly, changing the look and function of your motorcycle in minutes.



**INSTALLING A DETACHABLE WINDSHIELD**

*Designed to be installed or removed without tools in seconds, a Detachable Windshield gives you the freedom to define your ride at the drop of a hat. Ride across country protected from the elements, then quickly remove it to hit the streets in style.*

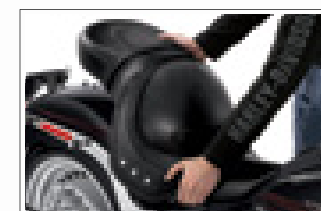

**CHANGING A SEAT**

*Switching out your seat is simple. And because certain rides call for certain styles, some folks like to have multiple seats to match the occasion. Install a comfortable, supportive touring seat for the longer treks, and swap it out for a low-profile seat for a night on the town.*



**INSTALLING A DETACHABLE BACKREST**

*With a detachable backrest and luggage rack, your bike can go from a stripped-down afternoon cruiser to a fully loaded two-up touring machine in seconds. Comfort- and convenience-driven accessories ease the physical strain of life on the road, and make for a less stressful ride.*

**FOUR KEY AREAS**

Check out these four critical areas to choose the options that will work hardest for you when out and away from the homestead.

**A. WINDSHIELDS**

*At speed, your chest captures all the air pressure and causes fatigue in your arms, neck and shoulders. Shaped to divert the air, rain and road debris, a windshield can add hours of riding comfort.*

**B. PASSENGER BACKRESTS**

*A detachable backrest can take your ride from a stripped-down cruiser to a two-up touring machine in seconds. After all, a comfortable and confident passenger is a happy passenger.*

**C. LUGGAGE RACKS**

*Luggage racks are versatile hardware that help you take more stuff along for the ride. Outfitted with a soft duffel, a luggage rack can haul a change of clothes, a rain suit and all the gear you need.*

**D. SADDLEBAGS**

*Versatile saddlebags provide ample storage and carry the weight low on the bike to maintain a good riding balance. Detachable leather bags allow you to strip the bike down when you get there.*

If you are looking for the basics and beginning accessories, look to your family Fit and Function section for Rider's Essentials. They're a perfect custom foundation.





# DEFINING YOUR STYLE

## MAKE YOUR BIKE SING...

*For those that walk on the wild side and don't mind showing it, this is your time to shine. Start with high-impact chrome wheels, pipes and front forks, and then finish it off with details like custom trim pieces and collections that will leave a lasting impression.*



### ...OR MAKE IT GROWL.

*If you come alive at night, or just want to add a touch of attitude, you're in the right place. Slap on a wicked grind or denim paint set to make the streets hiss, then finish your engine, pipes and hand controls in black to mark your territory.*





# REALIZING YOUR DREAM BIKE

## BUILD YOUR BIKE ONLINE.

*The Customizer interactive Web tool lets you select your bike, install and remove accessories, and view, save and print the list for the ride you've created.*

*The Customizer gives you the freedom to try different options, reduce the trial and error, and lets you see the visual impact of an accessory before you buy.*



[WWW.HARLEY-DAVIDSON.COM/CUSTOMIZER](http://WWW.HARLEY-DAVIDSON.COM/CUSTOMIZER)

Starting with your choice of motorcycle model and color, add options from a long list of Harley-Davidson® Accessories. Save or print your list and bring it to your local dealer to make your dream bike a reality.



FANTASIZE



VISUALIZE



CUSTOMIZE



REALIZE

## THE GUIDE TO CUSTOMIZING.

*The custom journey is not an overnight trip. It's a voyage with no final destination. To keep from getting lost, take advantage of the experts at your local Harley-Davidson® dealership. They're here to lend over a hundred years of experience to your custom adventure.*



### MORE CUSTOMIZING DETAILS

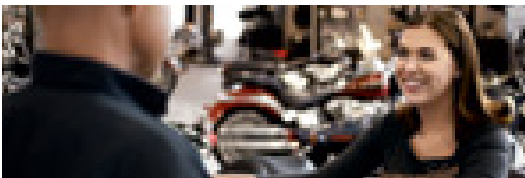

#### VISIT YOUR DEALER

For a more in-depth look at the process of personalizing your ride, ask your dealer for a copy of *The Guide to Customizing*. It's full of information that will help you save time, money and hassle when personalizing your motorcycle. Working in tandem with your Parts & Accessories Catalog, you'll be on the road to a one-of-a-kind ride in no time.

Log on for a video view and in-depth information on Fit, Function and Style; visit: [www.harley-davidson.com/customize](http://www.harley-davidson.com/customize)





# VRSC™

*VRSC models are known for performance, but that doesn't mean you need to forget about a slow cruise on Main Street, or shy away from logging countless miles. The entire VRSC family of motorcycles can be equipped to comfortably fit almost any rider, and equipped to go the distance in style. It's all fair game on the road to the perfect ride.*

*For the complete list of Genuine Motor Accessories that appear on these motorcycles or any other VRSC motorcycles shown, visit: [www.harley-davidson.com/gallery](http://www.harley-davidson.com/gallery).*

LEFT	VRSCAW V-Rod® <i>Vivid Black</i>
RIGHT	VRSCF V-Rod Muscle® <i>Vivid Black</i>
LOCATION	LAKESHORE STATE PARK, MILWAUKEE, WI
GPS	N 43° 01.917' - W 87° 53.787'



**ONLY YOU CAN DECIDE HOW YOU RIDE.**

*Fit and function are the bare essentials of customizing. If you do nothing else to your motorcycle, make sure your bike fits your body properly and accommodates the type of riding you plan to do.*

*Having the right accessories makes all the difference in the comfort and control you feel on the road. Take the time to learn how your VRSC™ model can be personalized so you can get the most out of your riding experience.*

**FINDING YOUR FIT AND FUNCTION**

To make your VRSC™ motorcycle fit you like a well-worn pair of jeans, your inspiration is only a few pages away. The page numbers listed at the right will help you quickly navigate to the section of the Catalog that most interests you. Turn the pages, and mark your trail with bent-over corners and scribbled notes in the margins. Customizing is a journey...travel well.

*For the complete list of Genuine Motor Accessories that appear on this motorcycle visit: [www.harley-davidson.com/gallery](http://www.harley-davidson.com/gallery).*



**STOPPING BY THE FIT SHOP**



**A. SEATS**

*Where the seat positions your waist relative to the foot controls, hand controls and the ground will impact your riding comfort, so test-sit a variety of seats to get it right.*

**B. FOOT CONTROLS**

*Where your feet meet the controls is equal parts riding style and physical necessity; it also determines the angle of your hip, knee and ankle, so keep it comfortable.*

**C. HANDLEBAR & CONTROLS**

*Each bar has a unique combination of rise, width and pullback—putting your hands, wrists, arms and shoulders in different configurations. See what feels natural and stick with it.*

**D. RIDE HEIGHT**

*Suspension components and seat shape combine to determine your riding position. Finding the right combination is the easiest way for a shorter rider to fit comfortably on a larger bike.*

**GEARING UP WITH RIDER ESSENTIALS**

Selecting even the basic accessories can be daunting. Start by adding versatility and long-haul comfort. These windshields, backrests and luggage racks are designed to fit your specific VRSC™ model and will get you ready for the open road.

**FOR '09–LATER VRSCF**

- Quick-Release Detachable Windshield . 57610-09
- Cast Upright Backrest Pad . . . . . 51600-09
- Cast One-Piece Luggage Rack . . . . . 53315-09

**FOR '07–LATER VRSCDX**

- Quick-Release Detachable Windshield . 57870-07
- Touring Passenger Pillion . . . . . 51780-07
- Black Fender Base Plate . . . . . 51220-07
- Black Low Sissy Bar Upright . . . . . 51312-07
- Touring Passenger Backrest Pad . . . . . 51780-07

**FOR '07–LATER VRSCA**

- Quick-Release Detachable Touring Windshield . . . . . 57211-05
- Touring Passenger Pillion . . . . . 51780-07
- Chrome Fender Base Plate . . . . . 51138-07
- Chrome Low Sissy Bar Upright . . . . . 51162-06
- Touring Passenger Backrest Pad . . . . . 51780-07



**SHOW OFF THE STYLE YOU WERE BORN WITH.**

*This is where your ride becomes a true individual. Where leather and steel become a reflection of your passion, commitment and character. Think about styling your bike as a whole, and what look you are after. Even though your style and taste may change over time, there's only one opinion that matters here, and that's yours.*

**FINDING YOUR STYLE**

This Catalog is packed with options that will let you establish your own sense of style. Flip through for inspiration, or use the page numbers below to help you quickly navigate to the pages that cover the areas you would like to customize.



SCREAMIN' EAGLE® PERFORMANCE  
PG : 462

ENGINE TRIM  
PG : 35

PAINT & BODYWORK  
PG : 710

GRIPS & PEGS  
PG : 550

LIGHTING  
PG : 51

FRONT END  
PG : 38

WHEELS  
PG : 42

GPS & AUDIO  
PG 616

SECURITY & STORAGE  
PG 748

CLEANING & MAINTENANCE  
PG 760

LUGGAGE  
PG 691

**DEFINING YOUR STYLE**

The possibilities are endless, so it pays to have an overall plan. Think through your customizing efforts to manage installation costs and minimize your time off the road.

**A. FRONT & REAR END**

*The front forks and rear swingarm are some of the most striking elements on your motorcycle. Custom sliders, axle covers and hardware maximize the visual impression.*

**B. PAINT**

*Your bike's paint sets the tone for the rest of your ride. From the classic and understated to the modern and brash, we have the options to help you find exactly what you want.*

**C. CUSTOM DETAILS**

*Your bike really comes alive in the details. Chrome, stylized or black components will help set your bike apart from the crowd and pull your vision together.*

**D. WHEELS**

*Your wheels, sprocket and rotors take up a lot of visual real estate and are a great way to complement or instantly overhaul the look of your ride.*

**WHAT'S HOT**

*We're always pushing our design teams to come up with new, innovative, functional and stylish components to reflect your personal needs. Take a minute to see what we've cooked up, and you'll find the right additions to help you accelerate your riding experience.*



BLACK HANDLEBAR FOR NIGHT ROD® SPECIAL  
PG 46



REACTOR FIVE-SPOKE  
CUSTOM WHEEL  
PG : 42



ENGINE GUARD KIT – GLOSS BLACK  
PG 45



BOOM! AUDIO™  
HALF-HELMET  
MUSIC HEADSET  
PG : 624



QUICK-RELEASE  
COMPACT SPORT  
WINDSHIELD  
PG : 25



ROAD TECH™ ZUMO® 660 GPS NAVIGATOR  
PG 617



CAST ONE-PIECE BACKREST  
& LUGGAGE RACK  
PG : 32

RIGID SADDLEBAGS  
PG : 33



BILLET HEADLAMP SHELL  
PG 51

VRSCDX  
**NIGHT ROD® SPECIAL**

Production Color: *Vivid Black / Mirage Orange*  
*Pearl Racing Stripe*

**About This Bike** Some black rides are basic and understated, but not this one. Ready to take on a passenger, this Night Rod Special lives up to its name and stands out, even in the dark.

ACCESSORIES FOR FIT

Reach® Rider Seat ..... 51781-07

ACCESSORIES FOR FUNCTION

PASSENGER BACKREST

Fender Base Plate – *Black* ..... 51220-07

Low Sissy Bar – *Black* ..... 51313-07

Backrest Pad – *Smooth* ..... 51782-07

Luggage Rack – *Black* ..... 51142-04A

ACCESSORIES FOR STYLE

WHEELS & ROTORS

Black Reactor Wheel – 19" *Front* ..... 43501-08

Black Reactor Wheel – 18" *Rear* ..... 43616-08

Wheel Installation Kit – *Front* ..... 41455-08B

Wheel Installation Kit – *Rear* ..... 41456-08B

Black Reactor Sprocket ..... 40162-09

Black Compensator Bowl ..... 40169-09

FRONT END

Front Axle Covers – *Black* ..... 43428-09

Banjo Bolt Kit – *Chrome* ..... 41843-08

Front Wheel Spacers – *Chrome* ..... 41360-08

LIGHTING

Turn Signal Relocation Kit ..... 57205-05

LED Tail Lamp – *Clear* ..... 69367-07

HAND CONTROLS

Black Handlebar ..... 56981-07

Mirror with Turn Signal – *Black* ..... 92068-08

Hand Lever Kit – *Satin Black* ..... 42275-07A

Hand Grips – *Tribal* ..... 56254-09

ENGINE & CHASSIS TRIM

Cam Cover Medallions – *Chrome* ..... 44497-02

Oil Temperature Dipstick ..... 62962-01A

FOOT CONTROLS

**NEW** Slotted Shift Lever – *Black* ..... 34551-09

**NEW** Slotted Brake Lever – *Black* ..... 48983-09

**NEW** Rider Footpeg Mounting Kit – *Black* ..... 50863-09

Shift Linkage – *"V-Rod"* ..... 33867-02

Chrome Jiffy Stand ..... 49742-01A

REAR END

Pivot Bolt Covers – *Black* ..... 47647-09

Rear Axle Covers – *Black* ..... 43430-09

For the complete list of Genuine Motor Accessories that appear on this motorcycle visit: [www.barley-davidson.com/gallery](http://www.barley-davidson.com/gallery).

LOCATION MARQUETTE INTERCHANGE, MILWAUKEE, WI

GPS N 43° 02.070' – W 87° 55.260'





VRSCF  
**V-ROD MUSCLE®**  
 Production Color: *Red Hot Sunglo*

**About This Bike** Performance and touring bikes are not polar opposites. Equipped to take on the interstate, this Muscle is built to haul ass, and to haul all the stuff you need when you get there.

**ACCESSORIES FOR FUNCTION**

Quick-Release Mid-Sport Windshield – 18" <i>Smoked</i> . . . . .	57610-09
Cast Upright and Backrest Pad . . . . .	51600-09
Cast Luggage Rack . . . . .	53315-09
Rigid Saddlebags . . . . .	91172-09
<b>NEW</b> Road Tech™ zümo® 660 GPS Navigator . . . . .	92115-09
<b>NEW</b> Road Tech zümo 660 Mount Kit . . . . .	92378-09
Engine Guard Kit – <i>Black</i> . . . . .	49388-09

**ACCESSORIES FOR STYLE**

**FRONT END**

Headlamp Housing – <i>Chrome</i> . . . . .	68778-04
Caliper Screen Insert – <i>Front, Chrome (2)</i> . . . . .	42054-05
Banjo Bolt Kit – <i>Chrome</i> . . . . .	41843-08

**HAND CONTROLS**

Hand Grips – <i>Aileron</i> . . . . .	56425-02
Hand Levers – <i>Slotted</i> . . . . .	34648-07
Clutch and Brake Master Cylinder Kit – <i>Chrome</i> . . . . .	42100-06A
Switch Housing Kit – <i>Chrome</i> . . . . .	70222-96B

**ENGINE & CHASSIS TRIM**

Coolant Hose Cover Kit . . . . .	29770-01
Socket Head Bolt Covers – <i>Chrome (3)</i> . . . . .	94046-03

**CHROME HARDWARE KITS**

Clutch and Water Pump . . . . .	94002-03
Alternator Cover . . . . .	94001-03

**REAR END**

Swingarm Pivot Bolt Cover – <i>Chrome</i> . . . . .	48893-01
Upper Belt Guard – <i>Chrome</i> . . . . .	60837-07
Lower Belt Guard – <i>Chrome</i> . . . . .	60839-07
Rear Axle Cover Kit – <i>Chrome</i> . . . . .	45621-02
Caliper Screen Insert – <i>Rear, Chrome</i> . . . . .	42053-05

For the complete list of Genuine Motor Accessories that appear on this motorcycle visit: [www.harley-davidson.com/gallery](http://www.harley-davidson.com/gallery).

LOCATION TRANSFER ROAD, SLINGER, WI  
 GPS N 43° 18.870' – W 88° 15.785'



**WINDSHIELDS**

Whether it's for keeping bugs off your face or warmth in your body, a windshield has a huge impact on rider and passenger comfort. By diverting air pressure past your chest and over your helmet, a windshield can add hours of riding comfort. For maximum protection from wind and weather, select a windshield that tops out just below your line of sight. You avoid looking through rain drops, bug spots and road grime to get a clear view of the highway ahead.

**A. QUICK-RELEASE ULTIMATE TOURING WINDSHIELD**

The oversized Touring Windshield features an aerodynamic design shaped to provide hours of riding comfort. The additional center width directs airflow past the hand grips, and deflects rain and road debris around the rider. The windshield mounts to the fork tubes with elegant die-cast lever-release clamps, so the windshield does not require any "leave-behind" docking hardware. You get quick on-and-off convenience, and a clean, custom look. No tools are required. The tough, hard-coated polycarbonate windshield features a stylish horizontal brace with the Bar & Shield logo to accent the long, lean look of the V-Rod® model. Kit includes Turn Signal Relocation Kit.

**57177-05** 25" Clear. **\$444.95**

Fits '02-later VRSCA, '04-'05 VRSCB and '07 VRSCX models. '05 VRSCB models require separate purchase of Headlamp Visor P/N 67750-88T and Visor Screw P/N 3383. Windshield dimensions: Overall height – 30.3"; width – 23.6".

**B. QUICK-RELEASE TOURING WINDSHIELD**

Shaped to split the wind, this unique clear Touring Windshield is sized for maximum long-distance riding comfort. The contoured shape and stylish horizontal brace with the Bar & Shield logo accent the long, lean look of the V-Rod® model. The windshield mounts to the fork tubes with elegant die-cast lever-release clamps, so the windshield does not require any "leave-behind" docking hardware. You get quick on-and-off convenience, and can strip the bike down to its street fighter profile in just a few seconds. No tools are required. Kit includes Turn Signal Relocation Kit and everything needed to install the windshield.

**57211-05** 23" Clear. **\$424.95**

Fits '02-later VRSCA, '04-'05 VRSCB and '07 VRSCX models. '05 VRSCB models require separate purchase of Headlamp Visor P/N 67750-88T and Visor Screw P/N 3383. Windshield dimensions: Overall height – 27.4"; width – 23".



**A. QUICK-RELEASE ULTIMATE TOURING WINDSHIELD**



**B. QUICK-RELEASE TOURING WINDSHIELD**





**C. DETACHABLE TOURING WINDSHIELD – VRSCR**



**D. QUICK-RELEASE 18" COMPACT MID-SPORT WINDSHIELD – VRSCF**



**E. COMPACT MID-SPORT WINDSHIELD (VRSCR SHOWN)**



**E. COMPACT MID-SPORT WINDSHIELD (VRSCD SHOWN)**



**F. SUPER SPORT WINDSHIELD**



**G. COTTON WINDSHIELD STORAGE BAG**

**C. DETACHABLE TOURING WINDSHIELD – VRSCR MODELS**

This unique clear Touring Windshield is sized for maximum long-distance riding comfort. Once installed, the detachable hardware permits quick on-and-off convenience, and allows you to strip the bike down to its street fighter profile in just a few seconds. The contoured shape and the stylish horizontal brace with the Bar & Shield logo accent the long, lean look of the Street Rod® model.

**57229-06** 23" Clear. **\$329.95**

Fits '06-'07 VRSCR models. Requires separate purchase of Windshield Docking Hardware Kit P/N 57226-06. Windshield dimensions: Overall height – 28.8"; width – 23".

**Shown with:  
WINDSHIELD DOCKING HARDWARE KIT**

This kit is required when installing Touring Windshield P/N 57229-06 on VRSCR models. Kit includes hardware required to relocate turn signals from the handlebar to the forks.

**57226-06** Fits '06-'07 VRSCR models. **\$69.95**

**D. QUICK-RELEASE 18" COMPACT MID-SPORT WINDSHIELD – VRSCF MODELS**

Shaped to split the wind. This tough, hard-coated polycarbonate Mid-Sport Windshield wraps around the headlamp to offer the maximum wind protection available in a compact profile. The windshield mounts to the fork tubes with elegant die-cast lever-release clamps, and to the handlebar with "plug-in" docking points, so the windshield does not require any "leave-behind" hardware. You get quick on-and-off convenience, and a clean, custom look. No tools are required.

**57610-09** 18" Lightly Smoked. **\$334.95**

Fits '09-later VRSCF models. Overall height – 20"; width – 17.5".

**E. COMPACT MID-SPORT WINDSHIELDS**

Wind protection and style combined. This Mid-Sport Windshield wraps around the contour of the headlamp to offer the maximum wind protection available in a compact profile. The multi-point mounting system attaches to the fork and bars for a positive grip. Kit includes all necessary mounting hardware.

**57861-06** 12" Clear. **\$344.95**

Fits '06-'08 VRSCD models. Windshield dimensions: Overall height – 21.3"; width – 17.9".

**57870-07** 12" Clear. **\$344.95**

Fits '07-later VRSCDX models. Windshield dimensions: Overall height – 20.1"; width – 17.9".

**57213-06** 18" Clear. **\$344.95**

Fits '06-'07 VRSCR and '07 VRSCX models. Windshield dimensions: Overall height – 21.3"; width – 18.2".

**F. SUPER SPORT WINDSHIELD**

Super is an apt description for this do-it-all shield. Easily removable, this sporty windshield provides protection from the elements when you need it. The high-quality lightly-smoked Lexan® shield is hard coated to resist scratching.

**57109-01** 21" Lightly Smoked. **\$324.95**

Fits '02-later VRSCA models. Windshield dimensions: Overall height – 21.5"; width – 18.3".

**G. COTTON WINDSHIELD STORAGE BAG**

This bag is constructed of breathable cotton material and is designed for a scratch-free storage area. The outside of the bag features an embroidered Bar & Shield logo to match the cotton cycle covers.

**95982-98B** **\$69.95**

Fits all Harley-Davidson® windshields.

# VRSC™ RIDING COMFORT

## NEVER IN A TIGHT SPOT

*On the road, you've got to feel good in the saddle. Whether you're cruising around town or out for the long haul, your bike should welcome you like an old friend and feel like an extension of yourself. Once you've picked the bike, it's time to choose the seat, controls and ride height that best equip your ride for your personal dimensions.*



### VRSC COMFORT OPTIONS

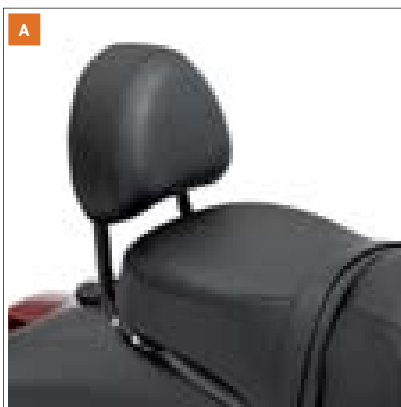

#### A. PASSENGER BACKRESTS

*Share your wicked ride. Covered to match the smooth Original Equipment seats, wide touring pillions and backrest pads are shaped to provide added passenger comfort and support.*

#### B. RIDER SEAT

*Choose a Sundowner™ touring seat for comfort, or a Reach® forward position seat to move you closer to the controls. And, because the seats are simple to change, you can have one of each for maximum versatility.*

#### C. REDUCED REACH FOOT CONTROLS

*Limit the stretch to the forward controls by moving the pegs and shift and brake levers closer to the rider. Original Equipment on the V-Rod Muscle.®*

### THE FIT SHOP LIST

Here are a few options to consider when outfitting your bike to fit you. Find your model, and flip to the pages for more information.

2010	SUSPENSION	SEATS	HAND CONTROLS	FOOT CONTROLS
VRSCAW / VRSCDX	N/A	Reach® Rider Seat (pg. 28)	Small & Large Diameter Grips (pg. 550-564)	Reduced Reach Control Kit Reduced Reach Footpeg Kit (pg. 48)



**A. SUNDOWNER RIDER SEAT (SHOWN WITH SMOOTH LOOK TOURING PASSENGER PILLION AND BACKREST PAD)**

#### A. SUNDOWNER™ RIDER SEAT

With its wide and deep bucket shape, this Sundowner Rider Bucket Seat is designed to maximize rider comfort for the long haul. Styled to match the Original Equipment passenger pillion or the available Touring Passenger Pillion P/N 51780-07, this rider touring seat features a contoured bucket that provides additional lower back support.

**51778-07 \$179.95**

Fits '07-later VRSC™ models (except VRSCF and VRSCR). Requires use of Original Equipment Passenger Pillion or Touring Passenger Pillion P/N 51780-07. Seat width 13.0".

**Shown with:**

#### SMOOTH LOOK TOURING PASSENGER PILLION

Although the VRSC™ family of motorcycles is built for speed, they can also make radical touring machines. The smooth seating surface complements the Original Equipment, Reach®, and Sundowner rider's seats, and delivers maximum passenger comfort for long hauls or around-town riding.

**51780-07 \$99.95**

Fits '07-later VRSC models (except VRSCF and VRSCR). Requires separate purchase of model-specific Fender Base Plate. Pillion width 11.0".

**Shown with:**

#### SMOOTH LOOK TOURING PASSENGER BACKREST PAD

**51783-07 \$79.95**

Fits '07-later VRSC (except VRSCF), '06-'07 VRSCR and '06 VRSCSE2 models equipped with Low Sissy Bar Upright P/N 51162-06 or 51313-07. Also fits FXCW models equipped with Sissy Bar Upright P/N 52804-08 and Dyna® models equipped with Sissy Bar Upright P/N 52726-09.

#### B. SUNDOWNER RIDER SEAT AND PILLION

Designed for the long haul, this touring seat continues in the comfort tradition of the popular Sundowner line. With rider comfort in mind, this seat has a deep contoured bucket that provides lower back support and keeps you comfortable longer. The wide passenger pillion bucket provides added passenger support as well.

**53432-02 \$269.95**

Fits '02-'06 VRSCA, VRSCB and VRSCD models. Also fits '05-'06 VRSCSE models. Requires use of Fender Base Plate or One-Piece Luggage Rack (sold separately). Seat width 15.5"; pillion width 12.0".

#### C. SUNDOWNER RIDER SEAT – VRSCR MODELS

With its wide and deep bucket shape, this Sundowner Rider Bucket Seat is designed to maximize rider comfort for the long haul. Styled to match the Original Equipment passenger pillion or the available Touring Passenger Pillion P/N 53036-05, this rider touring seat features a contoured bucket that provides additional lower back support.

**53030-05 \$179.95**

Fits '06-'07 VRSCR models. Requires use of Original Equipment passenger pillion or Touring Passenger Pillion P/N 53036-05 (sold separately). Seat width 12.5".

**Shown with:**

#### TOURING PASSENGER PILLION FOR VRSCR MODELS

Styled to complement the Sundowner Rider Seat P/N 53030-05 or the Original Equipment Street Rod® seat, this Touring Pillion has the extra width and padding needed for maximum passenger comfort on the long haul.

**53036-05 \$109.95**

Fits '06-'07 VRSCR models. Requires separate purchase of Fender Base Plate P/N 51156-06. Pillion width 10.5".

**Also shown with:**

#### PASSENGER BACKREST PAD FOR VRSCR MODELS

**53762-06 \$69.95**

Fits '07-later VRSC (except VRSCF), '06-'07 VRSCR and '06 VRSCSE2 models equipped with Low Sissy Bar Upright P/N 51162-06 or 51313-07. Also fits FXCW models equipped with Sissy Bar Upright P/N 52804-08 and Dyna models equipped with Sissy Bar Upright P/N 52726-09.



**B. SUNDOWNER RIDER SEAT AND PILLION**



**C. SUNDOWNER RIDER SEAT – VRSCR MODELS (SHOWN WITH TOURING PASSENGER PILLION AND PASSENGER BACKREST PAD)**

## 28 VRSC™

### Seating

#### A. REACH® RIDER SEAT

Offering a different riding option, this seat alters the rider's position by moving them 1.5" forward, and the narrow thigh area brings the legs closer together to shorten the reach to the ground. The smooth seating surface complements the Original Equipment passenger pillion or the available Touring Passenger Pillion P/N 51780-07.

**51781-07** **\$139.95**

Fits '07-later VRSC™ models (except VRSCF and VRSCR). Requires use of Original Equipment passenger pillion or Touring Passenger Pillion P/N 51780-07. Seat width 12.0".

#### B. REACH RIDER SEAT

Offering a different riding option, this seat alters the rider's position by moving them 1" forward. Seat matches stock VRSCA passenger pillion.

**52024-01** **\$139.95**

Fits '02-'06 VRSCA, VRSCB and VRSCD models. Also fits '05-'06 VRSCSE models. Seat width 13.0".

#### C. TALLBOY® RIDER SEAT AND PILLION

Stretch out those legs for a long, comfortable ride. The Tallboy® Seat is designed to move the rider up and back, providing 1.5" added room and a straight-leg reach to the forward controls. This two-piece seat retains the hinged access to the under-seat fuel filler, and the generous Passenger Touring Pillion provides added rider back support for the long haul.

**52927-05** **\$259.95**

Fits '02-'06 VRSCA, VRSCB and VRSCD models. Also fits '05 VRSCSE models. Installation requires a Fender Base Plate or One-Piece Luggage Rack (sold separately). Seat width 13.5"; pillion width 10.5".



A. REACH RIDER SEAT (SHOWN WITH ORIGINAL EQUIPMENT PASSENGER PILLION)



B. REACH RIDER SEAT (SHOWN WITH ORIGINAL EQUIPMENT PASSENGER PILLION)



C. TALLBOY RIDER SEAT AND PILLION

Notice: The prices appearing in this catalog are the manufacturer's suggested retail prices. Actual retail prices may vary.



**D. SMOOTH LOOK TOURING PASSENGER PILLION (SHOWN WITH SMOOTH LOOK TOURING PASSENGER BACKREST PAD)**

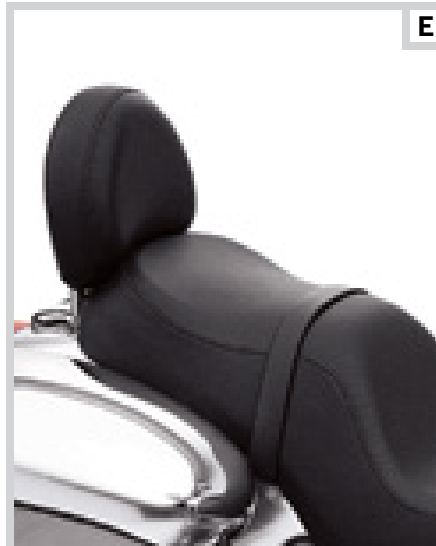

**E. TOURING PASSENGER PILLION (SHOWN WITH TOURING PASSENGER BACKREST PAD)**



**F. TOURING PASSENGER PILLION FOR VRSCR MODELS (SHOWN WITH TOURING PASSENGER BACKREST PAD FOR VRSCR MODELS)**



**G. CIRCULATOR SEAT PAD**

**D. SMOOTH LOOK TOURING PASSENGER PILLION**

Although the VRSC™ family of motorcycles is built for speed, they can also make radical touring machines. The smooth seating surface complements the Original Equipment, Reach®, and Sundowner™ rider's seats, and delivers maximum passenger comfort for long hauls or around-town riding.

**51780-07 \$99.95**

Fits '07-later VRSC models (except VRSCF and VRSCR). Requires separate purchase of model-specific Fender Base Plate. Pillion width 11.0".

**Shown with:**

**SMOOTH LOOK TOURING PASSENGER BACKREST PAD**

Covered to match the smooth Original Equipment, Reach®, and Sundowner Seats, this wide Touring Backrest is shaped to provide added passenger comfort and support.

**51783-07 \$79.95**

Fits '07-later VRSC (except VRSCF), '06-'07 VRSCR and '06 VRSCSE2 models equipped with Low Sissy Bar Upright P/N 51162-06 or 51313-07. Also fits FXCW models equipped with Sissy Bar Upright P/N 52804-08 and Dyna models equipped with Sissy Bar Upright P/N 52726-09.

**E. TOURING PASSENGER PILLION**

Although the V-Rod® model is built for speed, it can also make a radical touring machine. Styled to complement the stock seat or the Reach™ Seat, this textured Passenger Pillion delivers maximum passenger comfort for long hauls or around-town riding.

**52023-01A \$99.95**

Fits '02-'06 VRSCA, VRSCB and VRSCD models. Also fits '05 VRSCSE models. Requires use of Fender Base Plate or One-Piece Luggage Rack (sold separately). Pillion width 11.5".

**Shown with:**

**TOURING PASSENGER BACKREST PAD**

When used in conjunction with Touring Pillion P/N 52023-01A and V-Rod Sundowner™ Seat P/N 53432-02, this textured backrest pad provides more support for the passenger.

**51569-01 \$79.95**

Fits '02-'06 VRSCA, VRSCB and VRSCD models equipped with Low Sissy Bar Upright P/N 51126-01A or 51145-04A.

**F. TOURING PASSENGER PILLION FOR VRSCR MODELS**

Styled to complement the Sundowner Rider Seat P/N 53030-05 or the Original Equipment Street Rod® Seat, this Touring Pillion has the extra width and padding needed for maximum passenger comfort on the long haul.

**53036-05 \$109.95**

Fits '06-'07 VRSCR models. Requires separate purchase of Fender Base Plate P/N 51156-06. Pillion width 10.5".

**Shown with:**

**TOURING PASSENGER BACKREST PAD – VRSCR**

Add touring comfort to the aggressive stance of the Street Rod® motorcycle. Curved and contoured for maximum passenger support, this wide Touring Backrest Pad is styled to complement the VRSCR model's Original Equipment, Sundowner™ Seat, or Touring Pillion.

**53763-06 \$79.95**

Fits '07-later VRSC™ (except VRSCF), '06-'07 VRSCR and '06 VRSCSE2 models equipped with Low Sissy Bar Upright P/N 51162-06 or 51313-07. Also fits FXCW models equipped with Sissy Bar Upright P/N 52804-08 and Dyna® models equipped with Sissy Bar Upright P/N 52726-09.

**G. CIRCULATOR SEAT PADS**

Keep comfortable on your next long ride. These breathable Circulator Seat Pads feature 3D construction that promotes air movement and reduces heat build-up where the rider's body touches the seat. Designed to keep the rider cool by reducing the perspiration build-up between you and the seating surface, the Circulator Pads can be installed and removed in seconds for easy cleaning. The low-profile design minimizes seat-height change compared to inflatable pads, while enhancing comfort with its shock-absorbing construction. Manufactured of UV-stable materials, these seat pads resist fading when exposed to the sun. Elastic under-seat strap and non-slip base provide secure installation, and the available Circulator Passenger Pillion Pad attaches to the rider pad with hook-and-loop tabs.

**51074-10 Medium Pad (14.5" width) \$79.95**

Fits VRSC, XL and Dyna® models with Original Equipment and accessory seats.

**51078-10 Passenger Pillion Pad (13.0" width) \$69.95**

Fits Original Equipment and accessory passenger pillions.



# 30 VRSC™

## Backrests

### A. FENDER BASE PLATE KITS

Styled to give your VRSC™ motorcycle street appeal, this Base Plate provides the attachment point for upright and luggage rack options. This great-looking base plate can be left in place to complement the fender styling, or it can be easily removed with simple tools for a quick return to stock configuration. Kit includes chrome mounting hardware.

Fits '07-later VRSCAW, VRSCDX and VRSCX models.

<b>51138-07</b>	Chrome.	<b>\$179.95</b>
<b>51220-07</b>	Gloss Black.	<b>\$179.95</b>

Fits '07-'08 VRSCD models.

<b>51120-07</b>	Chrome.	<b>\$179.95</b>
-----------------	---------	-----------------

Fits '06-'07 VRSCR models.

<b>51156-06</b>	Chrome.	<b>\$179.95</b>
-----------------	---------	-----------------

Fits '02-'06 VRSCA, VRSCB, VRSCD and '05 VRSCSE models. Does not fit VRSCSE2 or models equipped with Wide Tire Kit P/N 43687-06 or 43820-05.

<b>51120-01A</b>	Chrome.	<b>\$99.95</b>
<b>51140-04A</b>	Gloss Black.	<b>\$99.95</b>

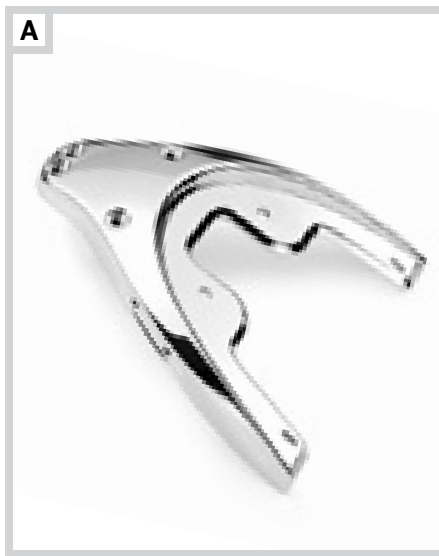

A. FENDER BASE PLATE KIT – CHROME

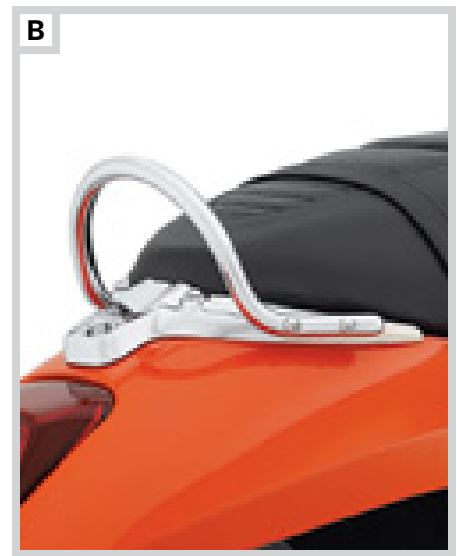

B. MINI SISSY BAR UPRIGHT – CHROME

### B. MINI SISSY BAR UPRIGHT

A stylish complement to low-profile seats, this Mini Sissy Bar Upright attaches to the Fender Base Plate without traditional sideplates and is styled to be used without a backrest pad. Installation of this easily removable upright requires the use of a Fender Base Plate. Hardware included.

Fits '06-'07 VRSCR models and '07-later VRSCAW, VRSCD, VRSCDX, and VRSCX models. Requires separate purchase of Fender Base Plate P/N 51156-06, 51138-07, 51220-07 or 51120-07.

<b>51177-06</b>	Chrome.	<b>\$59.95</b>
-----------------	---------	----------------

### C. LOW SISSY BAR UPRIGHTS

Designed to blend with the sleek look of the VRSC model, this easily removable upright attaches directly to the Fender Base Plate for a clean look. Hardware included.

Fits '06-'07 VRSCR models and '07-later VRSCAW, VRSCD, VRSCDX, and VRSCX models. Requires separate purchase of Fender Base Plate P/N 51156-06, 51138-07, 51220-07 or 51120-07.

<b>51162-06</b>	Chrome.	<b>\$59.95</b>
<b>51313-07</b>	Gloss Black.	<b>\$59.95</b>

Fits '02-'06 VRSCA, VRSCB, VRSCD and '05 VRSCSE models. Requires separate purchase of Fender Base Plate P/N 51120-01A or 51140-04A.

<b>51126-01A</b>	Chrome.	<b>\$59.95</b>
<b>51145-04A</b>	Gloss Black.	<b>\$59.95</b>

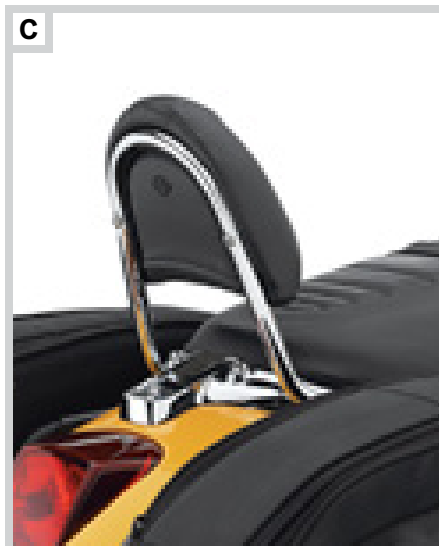

C. LOW SISSY BAR UPRIGHT – CHROME

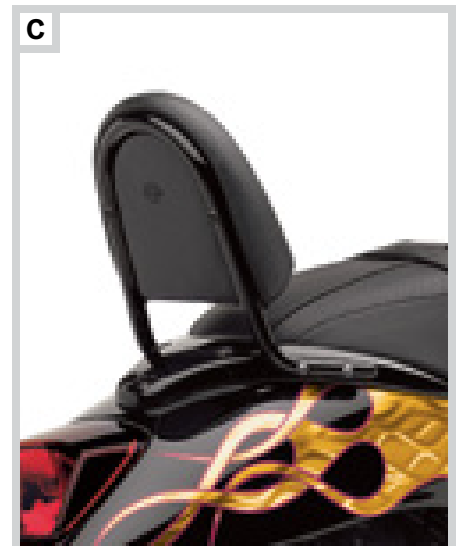

C. LOW SISSY BAR UPRIGHT – GLOSS BLACK

### D. CAST AND CHROME MINI SISSY BAR

Accent the low and lean look of the VRSC motorcycle with this highly styled Mini Sissy Bar. The unique die-cast shape and mirror-chrome finish blends with the Fender Base Plate to form a functional, yet stylish backrest. The included smooth look pad complements Original Equipment and low-profile custom seats. Kit includes mini upright, pad and chrome mounting hardware. Fender Base Plate sold separately.

<b>52759-04</b>		<b>\$69.95</b>
-----------------	--	----------------

Fits '02-'06 VRSCA, VRSCB, VRSCD and '05 VRSCSE models equipped with Fender Base Plate P/N 51120-01A or 51140-04A. (Does not fit with luggage rack.)



D. CAST AND CHROME MINI SISSY BAR

### E. LUGGAGE RACK FOR VRSC™ MODELS\*

This Luggage Rack is the ideal option for your ride across town or across the state. This rack is designed specifically for the VRSC motorcycle, and the simple installation requires the use of a Fender Base Plate. Easily removed with simple tools. Chrome hardware included.

Fits '02-later VRSC models (except VRSCF) equipped with a Fender Base Plate.

<b>51119-01A</b>	Chrome.	<b>\$114.95</b>
<b>51142-04A</b>	Gloss Black.	<b>\$114.95</b>



E. LUGGAGE RACK FOR VRSC MODELS



**\*WARNING:** Do not use this rack as a seat. Do not exceed the fender rack weight capacity. Using as seat or exceeding this capacity could cause handling problems which could result in loss of control and death or serious injury.

Notice: The prices appearing in this catalog are the manufacturer's suggested retail prices. Actual retail prices may vary.



**F. COMPACT PASSENGER BACKREST PAD**



**G. SMOOTH LOOK COMPACT PASSENGER BACKREST PAD**

**F. COMPACT PASSENGER BACKREST PAD**

This backrest pad complements the stock VRSCA seat as well as the Reach Seat P/N 52024-01 and the Sundowner™ Seat P/N 53432-02.

**52748-02** **\$69.95**  
Fits '02-'06 VRSCA, VRSCB and VRSCD models equipped with Low Sissy Bar Upright P/N 51126-01A or 51145-04A.

**G. SMOOTH LOOK COMPACT PASSENGER BACKREST PAD**

This backrest sports a smooth, clean finish that looks great with any smooth surface seat.

**51782-07** **\$69.95**  
Fits '07-later VRSC™ (except VRSCF), '06-'07 VRSCR and '06 VRSCSE2 models equipped with Low Sissy Bar Upright P/N 51162-06 or 51313-07. Also fits FXCW models equipped with Sissy Bar Upright P/N 52804-08 and Dyna® models equipped with Sissy Bar Upright P/N 52726-09.

**51583-01** **\$69.95**  
Fits '02-'06 VRSCA, VRSCB and VRSCD models equipped with Low Sissy Bar Upright P/N 51126-01A or 51145-04A.

**H. TOURING PASSENGER BACKREST PAD – VRSCD**

~~Covered to match the Original Equipment "tuck-and-roll" VRSCD model seat, this wide Touring Backrest is shaped to provide added passenger comfort and support.~~

~~**51645-06** **\$89.95**  
Fits '02-'06 VRSCA, VRSCB and VRSCD models equipped with Low Sissy Bar Upright P/N 51126-01A or 51145-04A.~~

**OBSOLETE**



**H. TOURING PASSENGER BACKREST PAD – VRSCD**



**I. COMPACT PASSENGER BACKREST PAD – VRSCR**

**I. COMPACT PASSENGER BACKREST PAD – VRSCR**

Patterned to complement the Original Equipment seat on the VRSCR, this compact Backrest Pad offers both style and passenger comfort.

**53762-06** **\$69.95**  
Fits '07-later VRSC (except VRSCF), '06-'07 VRSCR and '06 VRSCSE2 models equipped with Low Sissy Bar Upright P/N 51162-06 or 51313-07. Also fits FXCW models equipped with Sissy Bar Upright P/N 52804-08 and Dyna models equipped with Sissy Bar Upright P/N 52726-09.

**J. CHROME HARDWARE KITS – VRSC Sissy Bar AND LUGGAGE RACK**

Finish the show-winning look with brilliant chrome hardware. Manufactured to Original Equipment specifications, this kit replaces all exposed sissy bar upright, base plate and backrest pad hardware with mirror-finish chrome.

**1. 94112-04** Sissy Bar Upright and Base Plate. **\$21.95**  
Fits '02-later VRSC models (except VRSCF) equipped with a Fender Base Plate and a Sissy Bar Upright.

**2. 94263-04** Luggage Rack. **\$21.95**  
Fits '02-later VRSC models (except VRSCF) equipped with Luggage Rack P/N 51119-01A or 51142-04A.

**K. DOCUMENT HOLDER**

This Document Holder provides a convenient storage space under the VRSC hinged seat or in saddlebags. The clear zip-closure pouch attaches to the underside of the seat or to the interior of a saddlebag with convenient hook-and-loop strips, and the pouch can be removed and replaced with a simple lift and pull.

**94206-03** **\$9.95**  
Fits '02-later VRSC models (except VRSCR).

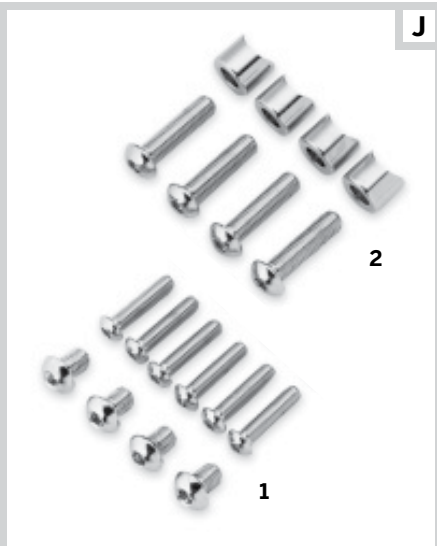

**J. CHROME HARDWARE KITS – VRSC Sissy Bar AND LUGGAGE RACK**



**K. DOCUMENT HOLDER**

Notice: The prices appearing in this catalog are the manufacturer's suggested retail prices. Actual retail prices may vary.

## 32 VRSC™

### Backrests & Saddlebags

#### A. CAST UPRIGHT AND BACKREST PAD

Accent the low and lean look of the VRSCF motorcycle with this highly styled passenger backrest. The unique cast upright with hidden hardware and the silver powder-coated finish blends with the bike to form a functional, yet stylish backrest. The smooth vinyl split pad complements the Original Equipment seat. Kit includes upright, pad and mounting hardware.

**51600-09** **\$159.95**

Fits '09-later VRSCF models. Requires separate purchase of Upright Installation Kit P/N 51607-09 or Cast Luggage Rack P/N 53315-09.

#### Also available:

##### UPRIGHT INSTALLATION KIT

Required for installation of Cast Upright and Backrest Pad P/N 51600-09, when installed without Cast One-Piece Luggage Rack P/N 53315-09.

**51607-09** **\$23.95**

Fits '09-later VRSCF models. Installation requires drilling holes in rear fender.

#### B. CAST ONE-PIECE LUGGAGE RACK\*

Beautifully die-cast, polished and finished in satin chrome, the one-piece design features hidden mounting hardware for a seamless style. The long rearward sweep continues the lines of the VRSCF rear fender, and the angular design blends with the passenger pillion for a true custom look. The rack looks great alone, or can be installed with Cast Sissy Bar P/N 51600-09 for added functionality.

**53315-09** **\$159.95**

Fits '09-later VRSCF models. Installation requires drilling holes in rear fender.

#### C. SPORT SADDLEBAGS

These full-featured, handcrafted saddlebags have been designed to complement the VRSC motorcycle's sporting image. The ballistic nylon construction and "VRSC" logo add durability and style that builds on the VRSC family's muscular image. The Sport Saddlebags are quick-detachable from the available mounting supports for carrying ease, and feature exterior pockets, an interior pouch, and a large dual zipper opening. Kit includes left and right detachable bags and rain covers. Luggage capacity: 1900 cubic inches total.

**91136-07A** **\$329.95**

Fits '02-later VRSC™ models (except VRSCF). Installation requires separate purchase of model specific Saddlebag Mounting Hardware Kit.



A. CAST UPRIGHT AND BACKREST PAD (SHOWN WITH CAST ONE-PIECE LUGGAGE RACK)



A. CAST UPRIGHT AND BACKREST PAD (SHOWN WITH UPRIGHT INSTALLATION KIT)



B. CAST ONE-PIECE LUGGAGE RACK



C. SPORT SADDLEBAGS



**\*WARNING:** Do not use this rack as a seat. Do not exceed the fender rack weight capacity. Using as seat or exceeding this capacity could cause handling problems which could result in loss of control and death or serious injury.

Notice: The prices appearing in this catalog are the manufacturer's suggested retail prices. Actual retail prices may vary.



D



D. RIGID SADDLEBAGS

**D. RIGID SADDLEBAGS**

Maximize your touring capabilities with these extra large capacity saddlebags without detracting from the sleek styling of the VRSCF model. These saddlebags feature a molded synthetic tub wrapped in durable vinyl with perforated vinyl accents to match the Original Equipment seat. The large interior is accessed through an easy-to-open water-resistant zippered flap, and the powerful magnetic catch holds everything in place. The complete kit includes all necessary hardware for installation of saddlebags and side-mount license plate. Luggage capacity: 2950 cubic inches total.

**91172-09** **\$749.95**  
Fits '09-later VRSCF models.

**Also available:**

**DELUXE SADDLEBAG LINERS** (not shown)

**91885-97A** **\$44.95**  
Fits '94-later Touring models equipped with Color-Matched Hard Saddlebags and '09-later VRSCF models equipped with Rigid Saddlebags P/N 91172-09. (pair)

**E. NYLON SADDLEBAGS**

Styled to match the Night Rod® model, these saddlebags feature a rigid plastic tub, wrapped in UV-resistant ballistic nylon. The double zipper and hook-and-loop top closure protects your valuables from the elements. The bags feature an embroidered "Harley-Davidson" logo and three chrome accents to complement the styling of the Night Rod model. Rain cover included. Luggage capacity: 1900 cubic inches total.

**91441-06A** **\$329.95**  
Fits '02-later VRSC™ models (except VRSCF). Installation requires separate purchase of model specific Saddlebag Mounting Hardware Kit.

**SADDLEBAG MOUNTING HARDWARE KIT**

Required to install VRSC Saddlebag P/N 91441-06A, or 91136-07A.

**91432-07** **\$259.95**  
Fits '07-later VRSCAW, VRSCDX and VRSCX models.

**91431-07** **\$259.95**  
Fits '07-'08 VRSCD models.

**91338-06** **\$259.95**  
Fits '06-'07 VRSCR models.

**91440-06** **\$279.95**  
Fits '02-'06 VRSCA, VRSCB and VRSCD models.

E



E. NYLON SADDLEBAGS

Notice: The prices appearing in this catalog are the manufacturer's suggested retail prices. Actual retail prices may vary.

# 34 VRSC™

## Luggage

### A. RACK BAG

Designed for easy removal, this Rack Bag is the perfect size for the shorter trip. The high-quality foam backed water-resistant material helps the bag maintain its shape. The Bar & Shield logo and the built-in rain cover add reflective surfaces for maximum visibility. The bag features 2 exterior side pockets for storage, 2 interior pockets (1 mesh, 1 soft cotton), and interior key hook. The bag measures 16" W x 11" D x 11" T; Luggage capacity: 1800 cubic inches.

**98923-09 \$139.95**

Fits VRSC™ and FXCW models equipped with a sissy bar upright, backrest pad, and luggage rack (if not mounting luggage on passenger pillion).



A. RACK BAG



B. SISSY BAR BACKPACK – SHOWN MOUNTED

### B. SISSY BAR BACKPACK

Keep your stuff with you when you're on the road. This backpack straps securely to the passenger backrest and provides convenient storage on your way to work. The interior features a padded laptop pocket with a secure strap for safe transportation, and the convenient mesh side pockets hold water bottles or anything you need easy access to. The padded backpack straps stow in their own storage pocket, and the wide "hook-and-loop" strap mount fits many backrest and luggage rack combinations. Includes rain cover for all weather protection. Dimensions: 18" T x 14" W x 13" D; Luggage capacity: 1600 cubic inches.

**94751-08 \$149.95**

Installation requires a sissy bar upright, backrest pad, and luggage rack (if not mounting luggage on passenger pillion). Does not fit with Mini or Short sissy bar uprights.



C. AIR BOX COVER BRA



D. FRAME BAG

### C. AIR BOX COVER BRA

Protect the finish of your VRSC model's air box cover from scratches caused by keys, belt buckles and road debris. This "tank" bra is made with non-abrasive, fleece-backed vinyl and features an embroidered Bar & Shield logo. Designed for easy installation and a custom fit.

**57850-01 \$39.95**

Fits '02-later VRSC models (except VRSCF).

### D. FRAME BAG

Great for small items like cell phones and sunglasses, this compact bag tucks neatly in the left side of the frame for a clean look.

**94204-03A \$29.95**

Fits '02-later VRSC models (except VRSCR).

### E. COLOR-MATCHED RADIATOR COVER AND SPOILER\*

This Color-Matched Radiator Cover incorporates a scooped chin spoiler and chrome-plated perforated screen for a racy, custom appearance. Manufactured from high-impact composite materials, the insert covers the Original Equipment center section and stretches the color of the radiator end caps across the front of the bike. Kit includes the necessary hardware for quick and easy installation.

Fits '02-'07 VRSC™ models. Will not fit with Engine Guard P/N 49267-01 or 49275-06. Will not fit with Voltage Regulator Cover P/N 74496-03 or 74497-03.

**57621-06BDJ Aluminum Silver finish. \$224.95**

**57621-06BPS Black Cherry. \$224.95**

**57621-06BYM Black Denim. \$224.95**

**57621-07BPY Black Pearl. \$224.95**

**57621-06BYF Brandy Wine Sunglo. OBSOLETE \$224.95**

**57621-06BJK Lava Red Sunglo. \$224.95**

**57621-07CGP Pacific Blue Pearl. \$224.95**

**57621-06NZ Racing Orange. \$224.95**

**57621-06BPV Rich Sunglo Blue. \$224.95**

**57621-06BJL Smokey Gold. OBSOLETE \$224.95**

**57621-06BDP Sterling Silver. OBSOLETE \$224.95**

**57621-06DH Vivid Black. \$224.95**

**57621-06BPZ Yellow Pearl. \$224.95**



E. COLOR-MATCHED RADIATOR COVER AND SPOILER

\*NOTE: This product is a "Paint to Order" accessory. Please allow for an average of 5 weeks delivery for this item.

Notice: The prices appearing in this catalog are the manufacturer's suggested retail prices. Actual retail prices may vary.



F

F. CHROME VRSC ENGINE KIT

**F. CHROME VRSC™ ENGINE KIT**

Upgrade your silver and black motor with brilliant chrome components. Kit includes upper and lower cam covers, clutch actuator cover, sprocket cover, water pump cover, clutch cover, derby cover, alternator cover, and all gaskets.

**16309-04A** \$949.95

Fits '04-later VRSC models (except VRSCF). Stock on VRSCA and VRSCAW models.

**G. CHROME HARDWARE KIT – VRSC CAM COVER**

Kit includes chrome washers and smooth socket head metric screws made to Harley-Davidson specifications. Kit includes the hardware required to replace the visible set of zinc-plated fasteners on the cam cover.

**94014-03** Fits '02-later VRSC models. \$36.95

**H. CHROME HARDWARE KIT – VRSC CLUTCH HOUSING AND WATER PUMP**

Kit includes chrome washers and smooth socket head metric screws made to Harley-Davidson specifications. Kit includes the hardware required to replace the visible set of zinc-plated fasteners on the clutch cover, secondary clutch actuator cover, and water pump cover.

**94002-03** Fits '02-later VRSC models. \$69.95

**I. CHROME HARDWARE KIT – VRSC ALTERNATOR COVER AND FRONT SPROCKET COVER**

Kit includes chrome washers and smooth socket head metric screws made to Harley-Davidson specifications. Kit includes the hardware required to replace the visible set of zinc-plated fasteners on the alternator cover, derby cover, and front sprocket cover.

**94001-03** Fits '02-later VRSC models. \$59.95

**J. CLASSIC CHROME SOCKET HEAD BOLT COVERS – METRIC**

Finish the show-winning look with these easy-to-install hardware covers. These machined brass and chrome-plated covers are corrosion resistant, and the internal spring steel retention clip resists vibration and thermal cycling to securely hold the covers in place. Metric M6 size fits most engine hardware on the V-Rod® model.

**94046-03** \$36.95

Fits M6 metric socket head screws with hex drive.

Sold in package of 10.



G

G. CHROME HARDWARE KIT – VRSC CAM COVER

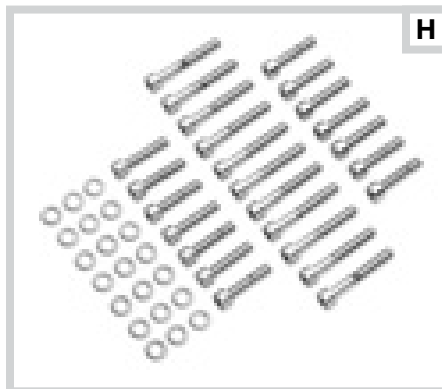

H

H. CHROME HARDWARE KIT – VRSC CLUTCH HOUSING AND WATER PUMP

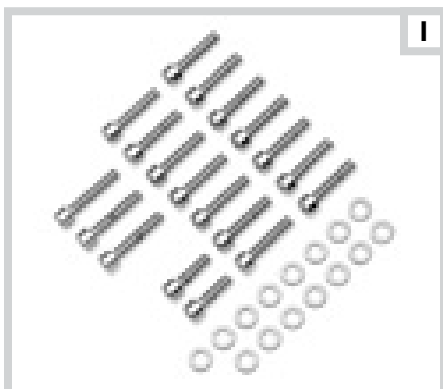

I

I. CHROME HARDWARE KIT – VRSC ALTERNATOR COVER AND FRONT SPROCKET COVER



J

J. CLASSIC CHROME SOCKET HEAD BOLT COVERS – METRIC

Notice: The prices appearing in this catalog are the manufacturer's suggested retail prices. Actual retail prices may vary.



## A. COOLANT HOSE COVER KIT

Chrome Coolant Hose Cover picks up where the stock water pump cover leaves off. This cover extends from the tee behind the upper frame to the top of the water pump. All necessary mounting hardware is included.

**29770-01** \$44.95

Fits '02-later VRSC™ models. Will not fit with Braided Stainless Steel Coolant Line P/N 26792-01.

## B. BRAIDED STAINLESS STEEL COOLANT LINE

Add the performance look that only braided steel can provide with this custom Coolant Line Kit. Complemented by machined billet aluminum chrome-plated end caps, for exact fitment and flawless function.

**26792-01** Fits '02-later VRSC models. \$79.95

## C. CHROME THERMOSTAT HOUSING

The ideal complement to the Revolution® engine, this Chrome Thermostat Housing looks great against the silver or the black finish. Manufactured from Original Equipment components for superior fit, this thermostat housing is polished and plated to a brilliant shine.

**26808-04** Fits '02-later VRSC models. \$59.95

## D. CHROME BILLET CAM COVER MEDALLION KIT

These mirror-finished chrome-plated cam cover inserts add a touch of chrome to the VRSC™ model's silver heads. The domed contour catches your eye, and is a perfect complement to the Billet Front Sprocket Inserts P/N 44493-02. Easy installation with high-strength adhesive backing. Kit includes four medallions.

**44497-02** Fits '02-later VRSC models. \$35.95

## E. OIL TEMPERATURE DIPSTICK WITH LIGHTED LCD READOUT

Add function and style by replacing the stock dipstick with this hardworking version, which includes a chrome-plated cap and LCD (liquid crystal display) oil temperature readout. The readout is push-button activated with an automatic shut-off in 5 seconds, and can be programmed to stay illuminated for up to 15 minutes. The easy-to-read blue light display can be easily changed from Fahrenheit to Celsius. Display orientation is adjustable for easy viewing. Includes replaceable standard battery.

**62982-03B** \$99.95

Fits '02-later VRSC models (except VRSCF).

**66373-06** CR2032 3v. \$1.95

Lithium Replacement Battery

## F. OIL TEMPERATURE DIPSTICK

Replace your Original Equipment oil dipstick with this custom-styled version featuring an easy-to-see mechanical temperature readout with "Harley-Davidson" logo. A knurled, chrome-plated aluminum cap completes the styling and provides an easy grip for removal.

**62962-01A** \$29.95

Fits '02-later VRSC models (except VRSCF).



A. COOLANT HOSE COVER KIT



B. BRAIDED STAINLESS STEEL COOLANT LINE



C. CHROME THERMOSTAT HOUSING



D. CHROME BILLET CAM COVER MEDALLION KIT



E. OIL TEMPERATURE DIPSTICK WITH LIGHTED LCD READOUT



F. OIL TEMPERATURE DIPSTICK

**G. CHROME VOLTAGE REGULATOR COVER****G. CHROME VOLTAGE REGULATOR COVER**

With a look that creates its own electricity, this chrome-plated cover features an embossed Bar & Shield logo and an open-center grill that allows air to flow right through for regulator cooling. Designed for easy installation. Chrome mounting hardware included.

**74497-03** **\$38.95**  
Fits '02-'07 VRSC™ models. Will not fit with Engine Guard P/N 49267-01, 49275-06 or 49388-09.

**H. VENTED CHROME SIDE COVERS FOR VRSC MODELS**

Add a deeply contoured look to the VRSC model's aggressive profile. These chrome-plated steel Side Covers feature a recessed black vent for a distinctive appearance. Easy-to-install kit includes left and right covers and chrome-plated mounting hardware.

**66331-05** **\$84.95**  
Fits '02-later VRSC models (except VRSCF).

**I. CHROME FUEL CELL SIDE COVER KIT**

Fill the side openings in the V-Rod motorcycle's hydro-formed frame with a dash of chrome. This two-piece kit conceals the fuel tank and ignition switch housing, and adds a contrasting shine to the silver or black frame rails. Easy-to-install, no hardware required.

**66310-02** **\$54.95**  
Fits '02-'06 VRSCA, VRSCB and VRSCD models.

**J. MUFFLER END CAP KIT**

These die-cast and chrome-plated aluminum End Caps surround the exhaust outlet and add a finishing touch to the flowing lines of the V-Rod® exhaust. Complete kit includes two End Caps and all required mounting hardware. Installation requires drilling mounting holes.

**65000-04** **\$84.95**  
Fits '02-later VRSCA, VRSCB and VRSCX models equipped with Original Equipment or Screamin' Eagle® Pro Slip-Fit Muffler Kit P/N 65030-02.

**K. CHROME BILLET MUFFLER CLAMP KIT**

Complete the flowing lines of the VRSC mufflers with brilliant chrome. These highly polished and chrome-plated machined billet aluminum clamps provide the perfect finishing touch to the long and lean VRSC exhaust. These clamps replace the Original Equipment strap muffler clamps, are re-usable and fit with the Original Equipment or Screamin' Eagle® Slip-Fit Mufflers.

**65271-03** **\$99.95**  
Fits '02-later VRSCA, VRSCAW, VRSCB and VRSCX models equipped with Original Equipment mufflers.

**H. VENTED CHROME SIDE COVER FOR VRSC MODELS****I. CHROME FUEL CELL SIDE COVER KIT****J. MUFFLER END CAP KIT****K. CHROME BILLET MUFFLER CLAMP KIT**

*Notice: The prices appearing in this catalog are the manufacturer's suggested retail prices. Actual retail prices may vary.*

### A. CHROME FRONT FORK SLIDERS

Competitively priced, these chrome-plated Lower Fork Sliders give your bike upfront style. To ensure proper fitment and function, these sliders are manufactured from Original Equipment components. Form follows function, with polished triple chrome-plating and a stamped "Harley-Davidson" logo for product identification. Kit includes right and left side sliders.

**46526-02B** **\$329.95**  
Fits '02-later VRSC™ models (except VRSCR and VRSCF).

### B. CLASSIC CHROME FRONT AXLE NUT COVER KIT

Cover the front axle in a classic style. Axle nuts look great with Original Equipment satin-finish fork sliders, or add a finishing touch to a complete chrome front end (*sold in pairs*).

Fits '02-later VRSC (except VRSCR and VRSCF), '08-later XL, '07-later Softail® (except Springer®, FXCW, FXCWC and FXSTD), '08-later Dyna®, and '08-later Touring models.

**44117-07A** Die-cast. **\$26.95**  
**44116-07A** Billet. **\$41.95**

### C. GLOSS BLACK FRONT AXLE NUT COVER KIT

Gloss black covers conceal the front axle hardware for a clean, custom look. Kit includes set screws and Allen wrench for easy installation.

**43428-09** **\$41.95**  
Fits '02-later VRSC (except VRSCR and VRSCF), '08-later XL, '07-later Softail (except Springer, FXCW, FXCWC and FXSTD), '08-later Dyna, and '08-later Touring models.

### D. "H-D MOTOR CO." LOGO FRONT AXLE NUT COVER KIT

Die-cast, chrome-plated covers feature the "Harley-Davidson Motor Co." logo in black. Includes set screws and Allen wrench for easy installation.

**44148-07A** **\$26.95**  
Fits '02-later VRSC (except VRSCR and VRSCF), '08-later XL, '07-later Softail (except Springer, FXCW, FXCWC and FXSTD), '08-later Dyna, and '08-later Touring models.

### E. WILLIE G. SKULL COLLECTION FRONT AXLE NUT COVER KIT

Add a little attitude to your ride. Styled to complement Harley-Davidson® Skull accessory items, the menacing raised skull with black-filled eyes leaps from a field of chrome. The surrounding "Harley-Davidson Motorcycles" script is the perfect finishing touch. The Axle Nut Covers are easy-to-install, and include all necessary mounting hardware (*sold in pairs*).

**43163-08A** **\$28.95**  
Fits '88-later XL, '84-later Softail (except Springer, FXCW, FXCWC and FXSTD), '02-later VRSC (except VRSCR and VRSCF), '91-later Dyna, and '99-later Touring models.



A. CHROME FRONT FORK SLIDERS

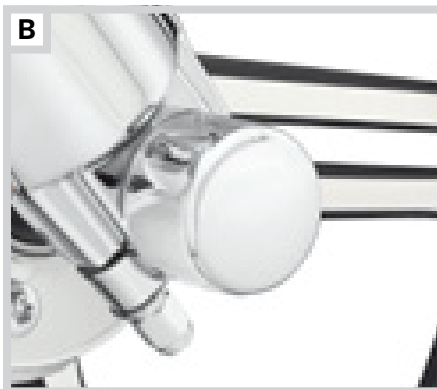

B. CLASSIC CHROME FRONT AXLE NUT COVER KIT

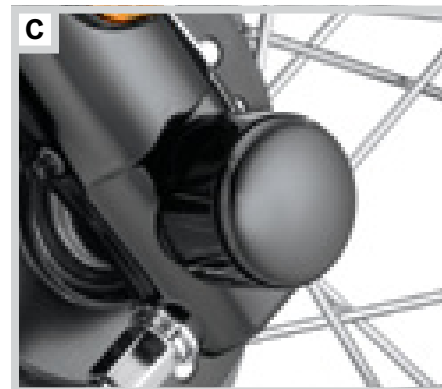

C. GLOSS BLACK FRONT AXLE NUT COVER KIT



D. "H-D MOTOR CO." LOGO FRONT AXLE NUT COVER KIT



E. WILLIE G. SKULL COLLECTION FRONT AXLE NUT COVER KIT





NEW F

F. LOW-PROFILE FRONT AXLE NUT COVER KIT



G

G. ALUMINATOR CHROME BILLET FRONT AXLE NUT COVER KIT

**F. LOW-PROFILE FRONT AXLE NUT COVER KIT**

Thanks to the tapered design, these die-cast Low-Profile Axle Covers appear smaller than a traditional axle cover. The brilliant chrome finish looks great with Original Equipment polished or accessory chrome fork sliders, and the hidden fasteners keep the look clean.

**47646-09 \$45.95**  
Fits '08-later Dyna® models (except FXDSE) and '06-later VRSC™ models (except VRSCF and VRSCR).

**G. ALUMINATOR CHROME BILLET FRONT AXLE NUT COVER KIT**

Chrome-plated aluminum Billet Axle Cover Kit with the classic styling of the Aluminator Collection. Includes mounting hardware and wrench for easy installation.

**44114-07 \$41.95**  
Fits '07-later Softail® models (except Springer®, FXCW, FXCWC and FXSTD), '08-later Dyna® and Touring (except Trike) and '02-later VRSC™ models (except VRSCR and VRSCF).



H

H. TAPERED FRONT AXLE NUT COVER KIT



I

I. CHROME FRONT WHEEL SPACER – TAPERED

**H. TAPERED FRONT AXLE NUT COVER KIT**

Thanks to an exclusive contoured profile, these unique chrome die-cast Front Axle Nut Covers appear smaller than others when installed.

**44109-07 \$26.95**  
Fits '07-later Softail® models (except Springer®, FXCW, FXCWC and FXSTD), '08-later Dyna and Touring (except Trike) and '02-later VRSC models (except VRSCR and VRSCF).

**I. CHROME FRONT WHEEL SPACERS – TAPERED**

Complete your total front end with these highly polished chrome-plated wheel spacers. Manufactured to the Original Equipment tolerances, they deliver exact fitment and custom shine.

**41360-08 \$29.95**  
Fits '08-later VRSC models (except models equipped with ABS option).

**J. CHROME HARDWARE KIT – VRSC HEADLAMP AND FRONT FENDER**

Kit includes chrome washers and smooth socket and button-head metric screws made to Harley-Davidson specifications. Kit includes the hardware required to replace the visible set of zinc-plated fasteners on chrome headlamp mounting bracket and chrome front fender bracket. Lock patch included on fasteners where required.

**94013-03 \$20.95**  
Fits '02-later VRSCA, VRSCAW, VRSCR and VRSCX models.



J

J. CHROME HARDWARE KIT – VRSC HEADLAMP AND FRONT FENDER



J

**K. SCREAMIN' EAGLE® CHROME FORK BRACE**

These chrome fork braces are machined from billet aluminum, then polished and chrome-plated to complement the curve of the front fender. The machined Screamin' Eagle® logo finishes the look with crisp detail. Easy-to-install, these braces offer increased torsional rigidity. Does not fit with Fluted Fork Slider Dust Covers.

**46595-06A \$199.95**  
Fits '06-later Dyna® models (except FXDF, FXDFSE/2, FXDWG and FXDSE/2), and '02-later VRSCA, VRSCB, VRSCD and VRSCX models.

**L. CHROME UPPER FORK STEM COVER KIT**

Finish off your custom front end with these three-piece Fork Stem Cover sets. Kit includes two slider caps and one steering stem bolt cover. The set is easy-to-install with an Allen wrench (included).

**46213-02 \$26.95**  
Fits '02-'08 VRSCA, VRSCX, VRSCB and VRSCD models.



K

K. SCREAMIN' EAGLE CHROME FORK BRACE



L

L. CHROME UPPER FORK STEM COVER KIT

Notice: The prices appearing in this catalog are the manufacturer's suggested retail prices. Actual retail prices may vary.

## 40 VRSC™

Chassis Trim – Rear End

### A. CHROME UPPER BELT GUARD

A must-have accessory for all V-Rod® motorcycle owners, this decoratively polished and chrome-plated upper belt guard offers custom styling to an already radical bike. Mount it using your Original Equipment mounting hardware. Instructions included for easy installation.

**60837-07** **\$159.95**  
Fits '07-later VRSC™ models (except VRSCR).

**60469-01A** **\$159.95**  
Fits '02-'06 VRSC (except '06 VRSCSE2) and '07 VRSCR models.

**Shown with:**

### CHROME LOWER BELT GUARD

Chrome out the entire belt and sprocket area with the addition of this uniquely styled, chrome-plated accessory. Featuring a one-of-a-kind shape and an outlined Bar & Shield logo, it's also styled to match the Chrome Upper Belt Guard for seamless integration when installed together. Kit comes complete with hardware and instructions for installation.

**60839-07** **\$99.95**  
Fits '07-later VRSC models (except VRSCR).

**60484-01B** **\$99.95**  
Fits '02-'06 VRSC (except '06 VRSCSE2) and '07 VRSCR models.

### B. SLOTTED UPPER BELT GUARD

Designed to give the V-Rod model a unique and stylish look, the mirror-finish Chrome Slotted Belt Guard opens up the left side of the bike for an aggressive profile. Easy-to-install, the Slotted Guard replaces the stock painted unit, and mounts with the Original Equipment hardware.

**60495-04** **\$189.95**  
Fits '02-'06 VRSC (except '06 VRSCSE2) and '07 VRSCR models.

**Shown with:**

### SLOTTED LOWER BELT GUARD

Add to the custom look with this slotted debris deflector. Styled to match the Slotted Upper Belt Guard, this mirror-polished chrome Lower Belt Guard is designed to complete a one-piece look to the rear end of the V-Rod motorcycle. This easy-to-install kit includes all required mounting hardware.

**60493-04A** **\$119.95**  
Fits '02-'06 VRSC (except '06 VRSCSE2) and '07 VRSCR models.



A. CHROME UPPER AND LOWER BELT GUARDS



B. SLOTTED UPPER AND LOWER BELT GUARDS



B. SLOTTED UPPER AND LOWER BELT GUARDS

*Notice: The prices appearing in this catalog are the manufacturer's suggested retail prices. Actual retail prices may vary.*



C. REAR AXLE COVER KIT – CHROME



C. REAR AXLE COVER KIT – GLOSS BLACK

**C. REAR AXLE COVER KIT**

This one-piece axle cover blends into the unique styling of the rear swingarm, and covers the rear axle and axle adjuster for a finished look.

Fits '02-later VRSC™ models.

<b>45621-02</b>	Chrome.	<b>\$41.95</b>
<b>43430-09</b>	Gloss Black.	<b>\$41.95</b>

**D. SWINGARM PIVOT BOLT COVER KIT**

Complete the radical styling of your VRSC™ model's swingarm with these custom pivot bolt covers. Easy press-fit installation. Sold in pairs.

Fits '02-later VRSC models.

<b>48893-01</b>	Chrome.	<b>\$26.95</b>
<b>47647-09</b>	Gloss Black.	<b>\$26.95</b>

**E. BILLET FRONT SPROCKET COVER INSERT KIT**

These chrome-plated Billet Front Sprocket Cover Inserts feature a striking beveled edge that'll make your bike shine. Kit complements Billet Cam Cover Medallion Inserts P/N 44497-02 and includes two inserts. Easy installation with high-strength adhesive backing.

<b>44493-02</b>		<b>\$54.95</b>
-----------------	--	----------------

Fits '02-'06 VRSCA, VRSCB and VRSCD models.



D. SWINGARM PIVOT BOLT COVER KIT – CHROME



D. SWINGARM PIVOT BOLT COVER KIT – GLOSS BLACK

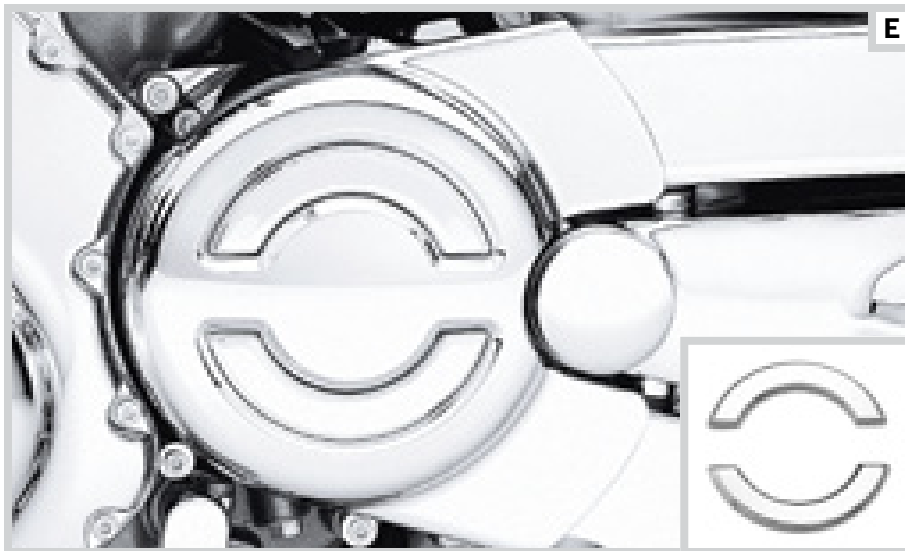

E. BILLET FRONT SPROCKET COVER INSERT KIT

Notice: The prices appearing in this catalog are the manufacturer's suggested retail prices. Actual retail prices may vary.

## 42 VRSC™

### Wheels & Sprockets

#### A. REACTOR FIVE-SPOKE CUSTOM WHEEL

The five slim spokes of this custom wheel dramatically change the look of the VRSC™ motorcycle. Available in mirror chrome or gloss black, the "ball-milled" spokes radiate from the unique center hub to blend with the machined rim, opening the bike for a light, sporting profile. The smooth curving rim, highlighted with machined grooves, adds to the true custom look without compromising strength or performance. The raised bosses on the hub carry the Original Equipment floating brake rotors, and add to the clean appearance of the installed wheel.

##### 19" Front

Fits '02-later VRSC models. Requires separate purchase of model-specific Wheel Installation Kit. See page 665 or your Dealer for more information. '07 VRSCX, '08 VRSCAW Anniversary models, and other models equipped with laced front wheels also require additional purchase of (2) Front Brake Rotors P/N 44553-06A.

**43219-08** Chrome. **\$1,199.95**

**43501-08** Gloss Black/Orange Stripe. **\$1,199.95**

##### 18" Rear (240 Tire)

Fits '07-later VRSC models (except '07-'08 VRSCD and '07 VRSCR). Requires separate purchase of model-specific Wheel Installation Kit. See page 665 or your Dealer for more information.

**43728-08** Chrome. **\$1,399.95**

**43616-08** Gloss Black/Orange Stripe. **\$1,399.95**

##### 18" Rear (180/55 Tire)

Fits '02-'06 VRSCA and VRSCB models, '06-'08 VRSCD and '05-'07 VRSCR models. Requires separate purchase of model-specific Wheel Installation Kit. See page 665 or your Dealer for more information.

**43215-08** Chrome. **\$1,199.95**



A. REACTOR FIVE-SPOKE CUSTOM WHEEL – CHROME



A. REACTOR FIVE-SPOKE CUSTOM WHEEL – GLOSS BLACK/ORANGE STRIPE

*Notice: The prices appearing in this catalog are the manufacturer's suggested retail prices. Actual retail prices may vary.*





B

**B. REACTOR BILLET SPROCKET – GLOSS BLACK/ORANGE STRIPE SHOWN**

**B. REACTOR BILLET SPROCKET**

Styled to complement the Reactor Custom Wheels for VRSC models, the five thin spokes mirror the design of the wheel and add a light profile to the rear of the bike.

Fits '07-later VRSC models (except VRSCR). Separate purchase of bearing is required (P/N 40670-06 for '07 models and P/N 9254 for '08-later models).

<b>40161-09</b>	Chrome.	<b>\$499.95</b>
<b>40162-09</b>	Gloss Black/Orange Stripe.	<b>\$499.95</b>

Fits '02-'06 VRSC models (except '06 VRSCSE2). Also fits '07 VRSCR models.

<b>40229-04</b>	Chrome.	<b>\$499.95</b>
-----------------	---------	-----------------

**C. REACTOR SPROCKET COMPENSATOR BOWL**

Show off the back of your Reactor Wheel and Sprocket combination. This Sprocket Compensator Bowl replaces the Original Equipment painted part, and dresses up the view when you look through the open design of the Reactor Five Spoke Custom Wheel. Kit reuses Original Equipment compensator cushion.

Fits '07-later VRSC™ models (except VRSCR) equipped with Reactor Five-Spoke Custom Rear Wheel.

<b>40169-09</b>	Gloss Black.	<b>\$49.95</b>
<b>40168-09</b>	Chrome.	<b>\$49.95</b>

Fits '02-'06 VRSC models (except '06 VRSCSE2) and '07 VRSCR and '07-'08 VRSCD models equipped with Reactor Five-Spoke Custom Wheel.

<b>40541-05</b>	Chrome.	<b>\$49.95</b>
-----------------	---------	----------------

**D. BLACK 5-SPOKE CAST ALUMINUM WHEEL**

Dress your V-Rod® in the latest style. First introduced on the 2008 Night Rod™, these black and polished 5-Spoke Wheels add a touch of attitude to your early VRSC™ model.

<b>43634-08</b>	19" Front.	<b>\$342.00</b>
-----------------	------------	-----------------

Fits '02-'07 VRSC models. Requires separate purchase of model-specific Wheel Installation Kit P/N 43848-08.

'07 VRSCX models and other models equipped with laced front wheel also require additional purchase of (2) Front Brake Rotors P/N 44553-06A.

<b>43635-08</b>	18" Rear, (180/55 Tire).	<b>\$342.00</b>
-----------------	--------------------------	-----------------

Fits '02-'06 VRSCA and VRSCB models and '06-'07 VRSCD and VRSCR models. Does not fit models equipped with 240mm rear tire. Requires separate purchase of model-specific Wheel Installation Kit P/N 43861-08.

**E. CHROME REAR WHEEL SPACER KIT – TAPERED**

Add some chrome detail to an often overlooked area of the bike with this highly-polished Chrome Wheel Spacer Kit. Manufactured to the Original Equipment tolerances, they ensure product fitment and quality.

<b>41367-08</b>		<b>\$29.95</b>
-----------------	--	----------------

Fits '08-later VRSC™ models (except models equipped with ABS option).



B

**B. REACTOR BILLET SPROCKETS**



C

**C. REACTOR SPROCKET COMPENSATOR BOWL**



D

**D. BLACK 5-SPOKE CAST ALUMINUM WHEEL**



E

**E. CHROME REAR WHEEL SPACER KIT – TAPERED**

Notice: The prices appearing in this catalog are the manufacturer's suggested retail prices. Actual retail prices may vary.

# 44 VRSC™

## Brakes

### A. CHROME BREMBO® BRAKE CALIPER KIT

Add the shine of chrome to your bike with these highly polished Chrome Brake Caliper Kits. Manufactured from Original Equipment components for proven performance, these calipers are a great addition to the stock bike, or add the finishing touch to a complete custom equipped with chrome wheels, rotors, fork sliders and swingarm. (Brake pads not included.)

**42012-06A** Front. **\$824.95**  
Fits '06-later VRSC™ and '08-later Touring models.

### B. CHROME CALIPER SCREEN INSERT

Chrome-plated caliper inserts replace the Original Equipment satin-finish screens featured on Brembo® Brake Calipers. Easy pop-in installation. Sold individually.

**42054-05** Front. **\$25.95**  
Fits '06-later VRSC and '08-later Touring models.

**42053-05** Rear. **\$25.95**  
Fits '06-later VRSC and '08-later Touring models.

### C. CHROME FRONT CALIPER KIT

Add the shine of chrome to your front end with this highly polished Chrome Front Brake Caliper Kit. Manufactured from Original Equipment components for proven performance, these calipers are a great addition to the stock front end, or add the finishing touch to a complete custom with chrome wheels, rotors and chrome fork sliders. (Brake pads and pad pins not included.)

**44392-00A** Dual disc. **\$789.95**  
Fits '00-'03 XL, '02-'05 VRSC™ and '00-'07 Dyna®, Softail® and Touring models equipped with dual disc front brakes.

### D. CHROME REAR CALIPER KIT

With H-D® chrome behind you, you're cruising with confidence. This Rear Caliper Kit offers a brilliant, long lasting chrome finish while delivering Original Equipment performance and exact fit. Bolts right to existing mounting holes. (Brake pads and pad pins not included.)

**44539-02A** **\$399.95**  
Fits '00-'07 FL Softail® (except '07 FLSTF), '00-'05 FX Softail (except FXSTD) and '02-'04 VRSC models. Not compatible with accessory Wide Tire Kits.

**42030-05** **\$399.95**  
Fits '02-'07 Touring models and '05 VRSCA and VRSCB models.

### E. CHROME BANJO BOLT KIT

Replace the Original Equipment zinc finish brake line hardware with brilliant chrome custom banjo bolts.

**41844-06** **\$27.95**  
Fits '02-'05 VRSCA and VRSCB models and '93-'07 Touring models. Does not fit with Banjo Bolt Cover P/N 32715-98. Kit includes three 3/8" banjo bolts and six sealing washers.

**41843-08** **\$44.95**  
Fits '06-later VRSC models and '08-later Touring models.



A. CHROME BREMBO BRAKE CALIPER KIT – FRONT



B. CHROME CALIPER SCREEN INSERT – FRONT SHOWN



C. CHROME FRONT CALIPER KIT



D. CHROME REAR CALIPER KIT

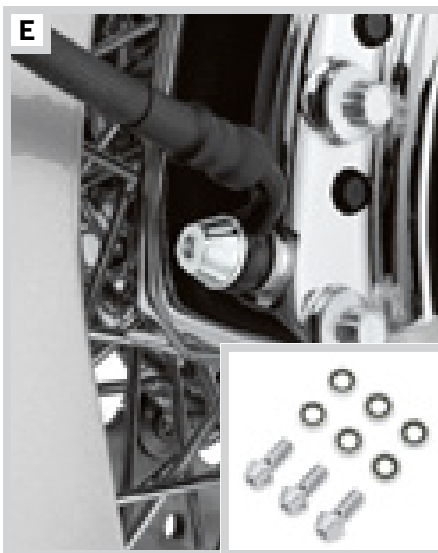

E. CHROME BANJO BOLT KIT ('02-'05 MODELS)



E. CHROME BANJO BOLT KIT ('06-LATER MODELS)

Notice: The prices appearing in this catalog are the manufacturer's suggested retail prices. Actual retail prices may vary.



F

F. ENGINE GUARD KIT – CHROME

**F. ENGINE GUARD KIT\***

Protect your Revolution® engine in style. The unique S-curve shape adds style to function. The engine guard features a two-piece design that allows for easy radiator service. Each side can be removed independently by simply removing two bolts.

Fits '02-later VRSC™ (except VRSCR) models. Will not fit with Regulator Cover P/N 74496-03 and 74497-03 or with VRSCSE Chin Fairing.

<b>49267-01A</b>	Chrome.	<b>\$299.95</b>
<b>49388-09</b>	Gloss Black.	<b>\$299.95</b>

**G. ENGINE GUARD KIT – VRSCR\***

Protect the Revolution engine without sacrificing ground clearance or style. The V-angle design and the two piece construction simplifies radiator service.

**49275-06** **\$299.95**

Fits '06-'07 VRSCR models. Will not fit with Regulator Cover P/N 74496-03 and 74497-03 or with VRSCSE Chin Fairing.

**H. CHROME JIFFY STAND**

With this beautifully chrome-plated accessory, your VRSC™ model won't just stand on its own – it will stand out. Using the Original Equipment jiffy stand to ensure quality and fitment, this piece is polished and plated to decoratively enhance a very visual component on the vehicle. Re-uses Original Equipment spring for installation.

**49742-01A** **\$79.95**

Fits '02-later VRSC models (except VRSCR and VRSCF). Does not fit '07-later International models.



NEW

F

F. ENGINE GUARD KIT – GLOSS BLACK



G

G. ENGINE GUARD KIT – VRSCR



H

H. CHROME JIFFY STAND



**\*WARNING:** These guards may provide limited leg and cosmetic vehicle protection under unique circumstances (fall over while stopped, very low speed slide). They are not made nor intended to provide protection from bodily injury in a collision with another vehicle or any other object.

Notice: The prices appearing in this catalog are the manufacturer's suggested retail prices. Actual retail prices may vary.

# 46 VRSC™

## Hand Controls

### A. BLACK HANDLEBAR FOR NIGHT ROD SPECIAL

Complete the transition to the "dark side." Elegant satin-black finished handlebar retains the comfortable contour of the Original Equipment bar, and complements the black finished hand controls and mirrors.

**56981-07** Fits '07-later VRSCDX models. **\$69.95**

### B. CHROME CLUTCH BRACKET AND MASTER CYLINDER RESERVOIR KIT

Replace your stock painted aluminum controls with brilliant chrome, without compromising quality. This kit is manufactured from the Original Equipment components and includes Chrome Master Cylinder Cover. When combined with Chrome Switch Housing Kit, Chrome Switch Caps, and other Harley-Davidson® Genuine Motor Accessories, this front brake control kit provides a look that does more than stop your bike – it can stop traffic.

**42100-06A** Fits '06-later VRSC™ models. **\$639.95**

**46112-02D** **\$399.95**

Fits '02-'05 VRSC models. Also fits hydraulic clutch equipped '96-'05 Dyna®, Softail®, and '96-'04 Touring models with dual disc front brakes.

### C. CHROME SWITCH HOUSING KIT

Convert your housings from black to chrome with this complete kit. Includes left, right, upper and lower housings. No switches or wiring required. Installation instructions included.

**70222-96B** **\$139.95**

Fits '96-later VRSC, XL, XR, Dyna, Softail® and FLHR Road King® models. Does not fit FXSTDSE and FLHRSEI2 models.

### D. CHROME SWITCH CAP KIT

Not satisfied until everything you see is chrome? This Chrome Switch Cap Kit will add style to one of the most visible areas of your bike, the switches. Shaped for the same ergonomic feel as the Original Equipment hand control switches, these caps replace the stock black caps without re-wiring. The chrome switch caps complement other chrome hand control accessories (Chrome Master Cylinder Kit, Chrome Hand Levers, Chrome Switch Housings and Chrome Master Cylinder Cover) to complete the custom look.

**71804-03** **\$18.95**

Fits '96-later XL, XR, Dyna, Softail and FLHR models, '02-later VRSC models, and '98-'01 FLHR models. FLHR models equipped with cruise control use Kit P/N 71808-03.

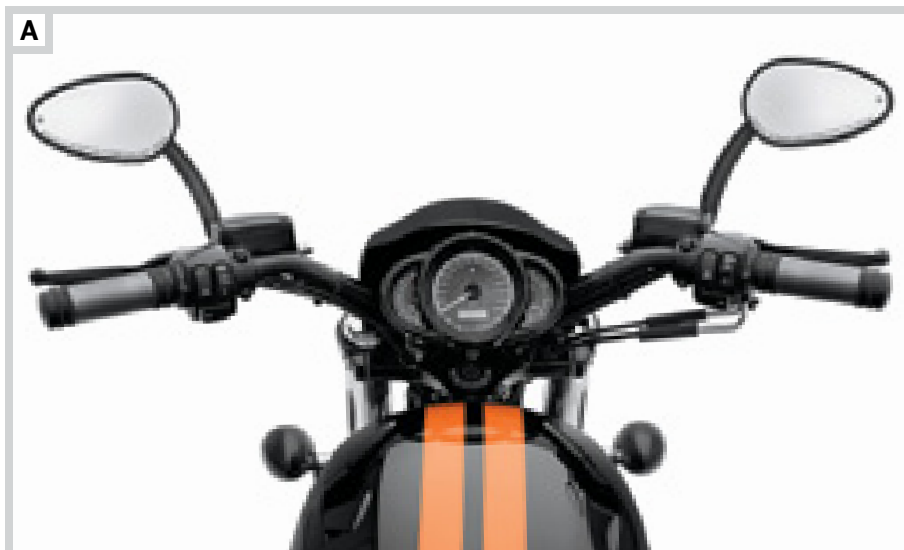

A. BLACK HANDLEBAR FOR NIGHT ROD SPECIAL



B. CHROME CLUTCH BRACKET AND MASTER CYLINDER RESERVOIR KIT ('06-LATER MODELS)



B. CHROME CLUTCH BRACKET AND MASTER CYLINDER RESERVOIR KIT ('02-'05 MODELS) (SHOWN WITH CHROME SWITCH HOUSING)



C. CHROME SWITCH HOUSING KIT



D. CHROME SWITCH CAP KIT (SHOWN WITH CHROME SWITCH HOUSING)





E. HAND CONTROL LEVER – CHROME



E. HAND CONTROL LEVER – BLACK

**E. HAND CONTROL LEVER KIT**

Continue the “blacked-out” or chrome theme with these Hand Control Levers. Cast from aluminum, these levers feature a custom finish designed to match the black or chrome hydraulic clutch components and Original Equipment-style hand controls.

Fits '06 VRSC™ models.

**42270-06A** Chrome. **\$159.95**

Fits '06-later VRSC™ models.

**42275-07A** Black. **\$99.95**

Fits '02-'05 VRSC™ and '96-'06 Dyna®, Softail® and Touring models equipped with hydraulic clutch.

**46114-07** Chrome. **\$85.95**

**46157-03** Black. **\$99.95**

**F. SLOTTED HAND CONTROL LEVER KIT**

Add that stripped-down custom look to your handlebar with these Slotted Chrome Hand Control Levers. Finished to a mirror-like shine, these billet look levers place a touch of brilliance in the palm of your hand.

**34648-07** Fits '06-later VRSC models. **\$159.95**

**G. CUSTOM HAND CONTROL LEVER KIT**

Squeeze your way down the asphalt with these billet style hand levers, inspired by the V-Rod® motorcycle. The slotted billet design complements the long and lean look of any Harley-Davidson® motorcycle and is a perfect match for the Slotted Chrome Brake and Shift Levers.

~~**45533-02** **\$123.95**~~

~~Fits '02-'05 VRSC and '96-'06 Dyna®, Softail and Touring models equipped with hydraulic clutch.~~



F. SLOTTED HAND CONTROL LEVER



G. CUSTOM HAND CONTROL LEVER

**H. CHROME MASTER CYLINDER COVER KIT**

Update the view over the handlebars with a touch of chrome. Kit includes left and right Master Cylinder Reservoir Covers and all necessary installation hardware.

**42114-06A** Fits '06-later VRSC models. **\$129.95**

**I. CHROME MASTER CYLINDER COVER KIT**

Includes one chrome-plated cover, gasket, and decal. Easily installed with included stainless steel screws.

**45078-96D** **\$34.95**

Fits '96-'03 XL, '02-'05 VRSC, '96-'05 Dyna, Softail and '96-'04 Touring models.



H. CHROME MASTER CYLINDER COVER KIT ('06-LATER MODELS)



I. CHROME MASTER CYLINDER COVER KIT ('02-'05 MODELS)

Notice: The prices appearing in this catalog are the manufacturer's suggested retail prices. Actual retail prices may vary.

### A. REDUCED REACH CONTROL KIT

Shorten your reach to the V-Rod® motorcycle forward controls with this complete foot control relocation kit. Designed for the shorter rider, this kit brings the footpegs and the shift and brake levers back and up toward the rider by 1". When combined with a Reach® Seat, your reach is reduced up to 2". Complete kit includes shift linkage, brake lever, shifter peg and footpeg mounts.

**50360-04** **\$299.95**

Fits '02-later VRSCA, VRSCAW, VRSCB, VRSCSE, VRSCSE2, VRSCDX and VRSCX models. Will not fit with accessory gear shift linkages. Original Equipment on VRSCF models.

### B. REDUCED REACH FOOTPEG KIT

Designed with the shorter rider's ergonomics in mind, this chrome-finished kit offers a different riding option for V-Rod® models. When used alone, this kit moves the footpegs back and up 1". When used in conjunction with a Reach® Seat your reach is reduced up to 2", giving you maximum riding comfort.

**50270-02A** **\$134.95**

Fits '02-later VRSCA, VRSCAW, VRSCB, VRSCF, VRSCSE, VRSCSE2, VRSCDX and VRSCX models.

### C. CHROME SHIFT LEVER

Highlight the standard forward controls of your VRSC™ motorcycle with this chrome-plated shift lever. We use the Original Equipment component to ensure product quality and fitment, then polish and plate it to a mirror-like finish. Install the matching Chrome Brake Lever P/N 24226-01A to complete the look.

**33833-01A** **\$69.95**

Fits '02-later VRSCA, VRSCAW, VRSCB, VRSCF, VRSCSE, VRSCSE2, VRSCDX and VRSCX models.

### D. CHROME BRAKE LEVER

Put your foot down on chrome. We've taken the Original Equipment brake lever to maximize product quality and fit, and then polished and plated it for a lasting shine. Add the matching Chrome Shift Lever P/N 33833-01A to complete the look.

**24226-01A** **\$79.95**

Fits '02-later VRSCA, VRSCAW, VRSCB, VRSCF, VRSCSE, VRSCSE2, VRSCDX and VRSCX models.

### E. "V-ROD" SCRIPTED GEAR SHIFT LINKAGE

With the custom looks of the V-Rod® model, stock just won't do. So kick your customizing into gear with a polished stainless steel Gear Shift Linkage. Featuring aircraft quality rod ends, a stainless steel transmission lever cover and decorative acorn nuts for maximum custom effect. The polished, stainless steel finish won't chip, peel or discolor. Easy-to-install.

**33867-02** **\$159.95**

Fits '02-later VRSCA, VRSCAW, VRSCB, VRSCSE, VRSCSE2, VRSCDX and VRSCX models. Will not fit VRSCF or models with Reduced Reach Control Kit P/N 50360-04.



A. REDUCED REACH CONTROL KIT



B. REDUCED REACH FOOTPEG KIT



C. CHROME SHIFT LEVER



D. CHROME BRAKE LEVER



E. "V-ROD" SCRIPTED GEAR SHIFT LINKAGE



F. SLOTTED CHROME SHIFT LEVER



G. SLOTTED CHROME REAR BRAKE LEVER



H. SLOTTED BLACK SHIFT LEVER



I. SLOTTED BLACK REAR BRAKE LEVER



J. RIDER FOOTPEG MOUNTING KIT – CHROME



K. RIDER FOOTPEG MOUNTING KIT – BLACK

**F. SLOTTED CHROME SHIFT LEVER**

The high style of the VRSC™ model is reflected in this mirror-finish chrome shift lever. The slotted billet design and integral molded rubber pad with Bar & Shield logo is a look that will get noticed.

**34555-01A** **\$169.95**

Fits '02-later VRSCA, VRSCAW, VRSCB, VRSCF, VRSCSE, VRSCSE2, VRSCDX and VRSCX models.

**G. SLOTTED CHROME REAR BRAKE LEVER**

Styled to complement the lean and low look of the VRSC motorcycle, the mirror-chrome finish and the slotted design add a finishing touch to your stock forward controls. Includes ribbed brake pedal pad with embossed Bar & Shield logo.

**42964-01A** **\$169.95**

Fits '02-later VRSCA, VRSCAW, VRSCB, VRSCF, VRSCSE, VRSCSE2, VRSCDX and VRSCX models.

**H. SLOTTED BLACK SHIFT LEVER**

The high style of the VRSC™ model is reflected in this satin black shift lever. The slotted billet design and integral molded rubber pad with the Bar & Shield logo is a look that will get noticed. Install the matching Black Slotted Brake Lever P/N 48983-09 for a complete look.

**34551-09** **\$169.95**

Fits '02-later VRSCA, VRSCAW, VRSCB, VRSCF, VRSCSE, VRSCSE2, VRSCDX, and VRSCX models.

**I. SLOTTED BLACK REAR BRAKE LEVER**

Styled to complement the lean and low look of the VRSC motorcycle, the satin black finish and slotted design add a finishing touch to your stock forward controls. Includes a ribbed brake pedal pad with embossed Bar & Shield logo. Install the matching Black Slotted Shift Lever P/N 34551-09 for a complete custom look.

**48983-09** **\$169.95**

Fits '02-later VRSCA, VRSCAW, VRSCB, VRSCF, VRSCSE, VRSCSE2, VRSCDX, and VRSCX models.

**J. RIDER FOOTPEG MOUNTING KIT – CHROME**

Add the splash of chrome that your feet deserve. These chrome replacements for the Original Equipment Rider Footpeg Mounts catch your eye while they are catching the light. Kit includes Original Equipment style footpeg mounts in brilliant chrome.

**50809-02A** **\$79.95**

Fits '02-later VRSCA, VRSCAW, VRSCB, VRSCSE, VRSCSE2, VRSCDX and VRSCX models.

**K. RIDER FOOTPEG MOUNTING KIT – BLACK**

Add the look of blacked out that your feet deserve. These are black replacements for the Original Equipment Rider Footpeg Mounts. They complement the Black Slotted Rear Brake Lever P/N 48983-09 and Shift Lever P/N 34551-09. Kit includes Original Equipment-style footpeg mounts in black powder coat finish.

**50863-09** **\$79.95**

Fits '02-later VRSCA, VRSCAW, VRSCB, VRSCSE, VRSCSE2, VRSCDX, and VRSCX models.

# 50 VRSC™

## Foot Controls

### A. REAR MASTER CYLINDER COVER KIT

This bullet-shaped chrome cover is designed to add a custom look while hiding the working components of the V-Rod rear master cylinder. The two-piece design covers both the brake line banjo bolt and the cartridge housing. This easy-to-install kit includes all necessary mounting hardware.

**42204-04** **\$41.95**  
Fits '02-'05 VRSCA and VRSCB models.

### B. MINI FOOTBOARD KIT

This Mini Footboard Kit can be installed in place of traditional footpegs and provides a little additional leg support and more options to move your feet around on a long run. Mini Footboards mount to standard H-D style footpeg supports, and can be used in many rider and passenger applications. A little larger than a bicycle pedal, Footboards can be pivoted to the proper angle for maximum riding comfort. The sole-gripping horizontal black rubber bands complement the mirror-chrome finish, and add vibration isolation and a rich appearance to the pegs. Complete the look with Shifter Pegs and Brake Pedal Pads from the Chrome and Rubber Collection.

**50451-09** **\$109.95**  
Fits models with forward controls (except FXCW/C, VRSCDX and VRSCF). Does not fit with mid-controls or with Frame Mounted Highway Pegs P/N 50855-09 and 50865-09. Fits Passenger male mount style Footpeg supports on most models (except '03-earlier XL, '06-earlier VRSC, '05-earlier Dyna, and FXSTD, FLSTSB, FLSTF, FLSTN and Softail models with shotgun exhaust). Softail passenger position also requires Support Kit P/N 50454-09.

### C. CHROME REAR PASSENGER FOOTPEG BRACKETS

Upgrade the Original Equipment finish with bright chrome. Nicely complements the addition of any accessory passenger footpeg kit. Kit includes polished stainless steel footpeg mounting pins.

**51000-02** **\$84.95**  
Fits '02-'06 VRSCA, VRSCB, VRSCSE and VRSCSE2 models.

### D. ADJUSTABLE PASSENGER FOOTPEG MOUNT KIT

Maximize your passenger's riding comfort. Proper foot position reduces the cramped or stretched-out feeling, and relieves pressure on the knees and the tail bone. These Adjustable Mounts raise and lower the passenger footpeg to accommodate taller and shorter passengers. Easy to adjust with common tools, the mount adjusts through a possible 360° range (depending on vehicle), allowing both fore and aft and up and down height adjustment. Kit includes left and right adjustable support assembly and all required mounting hardware. Footpegs sold separately.

**50763-09** **\$149.95**  
Fits models with H-D male mount style passenger footpeg supports (except Softail models). Does not fit with Heel Raiser Footpeg Kit P/N 50178-09. Does not fit the rider position.

### E. PREMIUM AIR HORN KIT

Sit up and get noticed. This Premium Air Horn is one of the loudest motorcycle horns available. The compact design has the compressor attached directly to the horn assembly, eliminating the need for separate mounting of the compressor and air hoses. The horn features an integrated chrome cover for a stylish look. Separate purchase of a vehicle-specific installation kit is required.

**69423-05** **\$139.95**  
Fits '02-later VRSC™, '04-later XL, '08-later XR, '96-later Dyna®, '00-later Softail® (except FLSTS, FLSTSC and FXCW/C), and '99-later Touring models. Requires separate purchase of vehicle-specific Installation Kit.

#### Shown with:

### PREMIUM AIR HORN INSTALLATION KIT

Required for installation of Premium Air Horn Kit P/N 69423-05 on specific models.

**69412-07** Fits '02-later VRSC models. **\$74.95**



A. REAR MASTER CYLINDER COVER KIT



B. MINI FOOTBOARD KIT



C. CHROME REAR PASSENGER FOOTPEG BRACKETS



D. ADJUSTABLE PASSENGER FOOTPEG MOUNT KIT



E. PREMIUM AIR HORN AND INSTALLATION KIT





**F. BILLET HEADLAMP SHELL (SHOWN WITH INSTALLATION BRACKET AND TURN SIGNAL RELOCATION KIT)**

#### F. BILLET HEADLAMP SHELL

Add style and substance to the front fork with this bullet-shaped Headlamp Shell. Manufactured from billet aluminum, this extended headlamp housing recesses the headlamp for a true custom appearance. The mirror-finish chrome surfaces and the close-fitting inner trim ring create the appearance of a one-piece design. Kit includes chrome-plated mounting hardware and a custom billet mount.

**67704-03 \$329.95**

Fits '00-later FXST, FXSTB, FXSTC and FXSTD models, '99-'05 FXDWG models and '02-later VRSC™ models (except VRSCF) equipped with Installation Bracket P/N 68211-05. (Does not fit International models.)

**Shown with:**

#### BILLET HEADLAMP INSTALLATION BRACKET FOR VRSC MODELS

Add to the long and lean look of the VRSC model family. This bracket allows you to replace the Original Equipment headlamp with the mirror-chrome extended Billet Headlamp Shell.

**68211-05 \$124.95**

Fits '02-later VRSCA, VRSCAW, VRSCB, VRSCD and VRSCX models. Requires separate purchase of Billet Headlamp Shell Kit P/N 67704-03 and Headlamp Bulb P/N 68297-05. VRSCD models require removal of Original Equipment Color-Matched Speed Screen Visor.



**G. CONTOURED HEADLAMP TRIM VISOR**

#### G. CONTOURED HEADLAMP TRIM VISOR

Draped around the curving profile of the distinctive sloping V-Rod® headlamp, this mirror-finish visor blends with the headlamp mounting bracket for a true custom look. Designed to direct light away from the leading edge of the windshield, this styled visor looks great with or without a windshield.

**69236-04 \$34.95**

Fits '02-later VRSCA, VRSCAW, VRSCX, VRSCR and '04 VRSCB models.



**H. CONTOURED CHROME HEADLAMP BRACKET**

#### H. CONTOURED CHROME HEADLAMP BRACKET

Surround the V-Rod motorcycle radical headlamp in chrome. Styled to incorporate the headlamp mount and visor in one elegant shape, this simple-to-install Headlamp Bracket replaces the Original Equipment support with mirror-polished chrome.

**69772-04 \$109.95**

Fits '02-'06 VRSCA, VRSCAW, VRSCX and '04 VRSCB models. Does not fit with Detachable Windshields.

#### I. CHROME HEADLAMP HOUSING KIT

Complete your custom VRSC model transformation with this beautifully polished and chrome-plated Headlamp Housing. Manufactured from Original Equipment components, this chrome housing replaces the painted headlamp shell. When combined with a chrome headlamp bracket or chrome headlamp visor, this Headlamp Housing adds a leading edge custom look.

**68778-04 \$59.95**

Fits '02-later VRSCA, VRSCAW, VRSCX and '04 VRSCB models.



**I. CHROME HEADLAMP HOUSING KIT**

#### J. HEADLAMP VISOR

Direct the light away from the leading edge of the windshield with this simple-to-install Headlamp Visor. Standard equipment with most VRSCA model windshield kits, this chrome-plated visor mounts between the headlamp shell and the headlamp bracket with Original Equipment hardware.

**69200-01 \$31.95**

Fits '02-later VRSCA, VRSCAW, VRSCX, VRSCR and '04 VRSCB models.



**J. HEADLAMP VISOR**

*Notice: The prices appearing in this catalog are the manufacturer's suggested retail prices. Actual retail prices may vary.*

**A. TURN SIGNAL RELOCATION KIT**

Styled to blend with the lower triple clamp, this chrome-plated Turn Signal Relocation Kit moves the Original Equipment bullet-style turn signals from the handlebar to the front fork for a clean, streamlined look. Kit includes left and right mounting stalk and all required hardware.

**57205-05** **\$44.95**  
 Fits '02-later VRSCA, VRSCB, VRSCD and '07-later VRSCX and VRSCDX models.

**B. MINI-BULLET LED TURN SIGNAL KIT**

Take a new direction in lighting. Bright, fast-acting LED turn signal elements are housed in a mirror chrome-plated or satin black mini-bullet housing for definitive style. The compact turn signals tuck in tight to the hand controls and the small size trims the rear profile for a custom look. Available with clear, smoked or amber lenses, kit includes front and rear signals and the required controller. Vehicle specific mounting kit sold separately.

NOTE: These signals were designed to meet European lighting requirements and are ECE approved. As part of the ECE requirements, the front turn signals do not operate as running lamps; they only operate as directional lamps. These turn signals do not conform to DOT requirements for North America because the lens diameter is too small. The turn signal diameter is 45mm (1-3/4").

Fits '02-later VRSC (except VRSCF), '08-later XR, '04-later XL (except XL883N and XL1200N), '02-later Dyna®, (except '09-later FXDWG and FXDB), '00-'07 FXSTD, '02-later FXST, FXSTB, FXSTC, FXSTS, FLSTF, FLSTS, FLSTSB and FLSTSC models. Installation requires separate purchase of appropriate Mounting Kit. Intended for use on HDI models only.

**69474-07** Chrome Housing, Amber Lenses. **\$214.95**  
**69475-07** Chrome Housing, Smoked Lenses. **\$214.95**  
**69476-07** Chrome Housing, Clear Lenses. **\$214.95**

Fits '02-later VRSC models (except VRSCF) and '08-later XR models. Installation requires separate purchase of appropriate Mounting Kit. Intended for use on HDI models only.

**68863-08** Black Housing, Smoked Lens. **\$214.95**

**MOUNTING KIT FOR MINI-BULLET LED TURN SIGNALS**

Kit includes the wiring harness, mounting brackets, and hardware required to install Mini-Bullet LED Turn Signals on a specified model.

**69593-08A** Chrome. **\$99.95**  
 Required for installation of Mini-Bullet LED Turn Signal Kits P/N 69474-07, 69475-07 or 69476-07 on '02-later VRSC models.

**C. FLAMED TURN SIGNALS**

Turn up the heat on your custom ride. The mirror-chrome visor-style turn signals feature a raised flame design that flows across the surface. Available with amber or smoked lenses, the kit includes both front and rear turn signals and wiring.

Fits '02-later VRSC™ models (except VRSCR and VRSCF). Installation of front turn signals requires separate purchase of Turn Signal Relocation Kit P/N 57205-05. Installation of rear turn signals requires separate purchase of Turn Signal Installation Kit P/N 69895-08. Also fits '05-'06 VRSCSE/2 models with Original Equipment turn signal mounts.

**69844-08** Amber – Domestic. **\$149.95**  
**69945-08** Smoked – Domestic. **\$149.95**  
**69845-08** Amber – HDI. **\$149.95**  
**69960-08** Smoked – HDI. **\$149.95**

**Also available:**

**REAR FLAMED TURN SIGNAL MOUNTING KIT FOR VRSC MODELS**

Installs the rear turn signals from the Flamed Turn Signal Kits onto VRSC models.

**69895-08** **\$59.95**  
 Required for installation of Rear Flamed Turn Signals P/N 69844-08, 69845-08, 69945-08, or 69960-08 on '02-later VRSC models (except VRSCF). (Not required for '05 VRSCSE and '06 VRSCSE2 models.)



**A. TURN SIGNAL RELOCATION KIT**

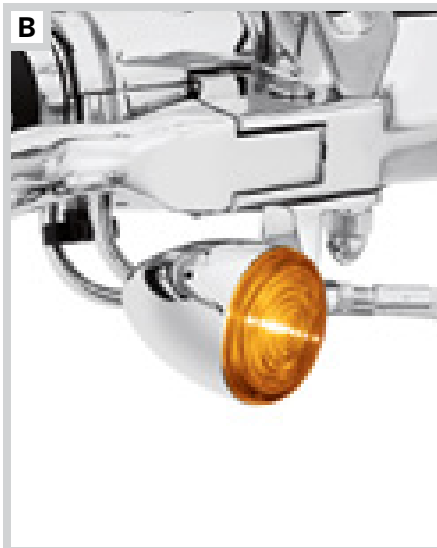

**B. MINI-BULLET LED TURN SIGNAL KIT – CHROME HOUSING (AMBER LENS SHOWN)**

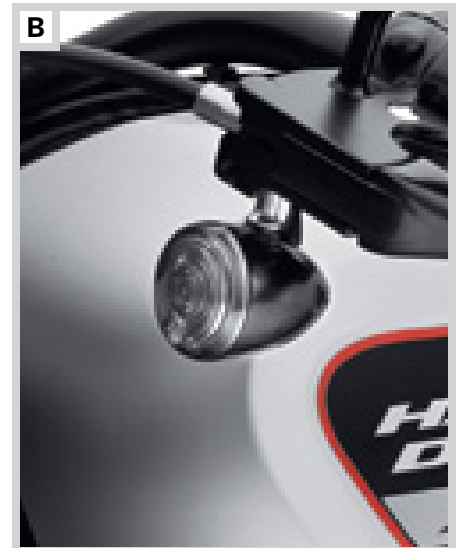

**B. MINI-BULLET LED TURN SIGNAL KIT – BLACK HOUSING (SMOKED LENS)**



**C. FLAMED TURN SIGNAL – FRONT**

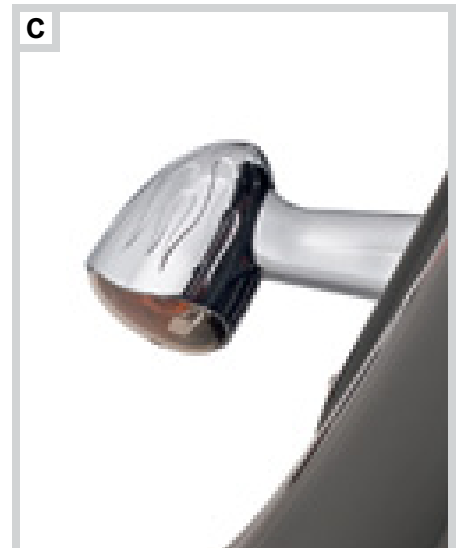

**C. FLAMED TURN SIGNAL – REAR**

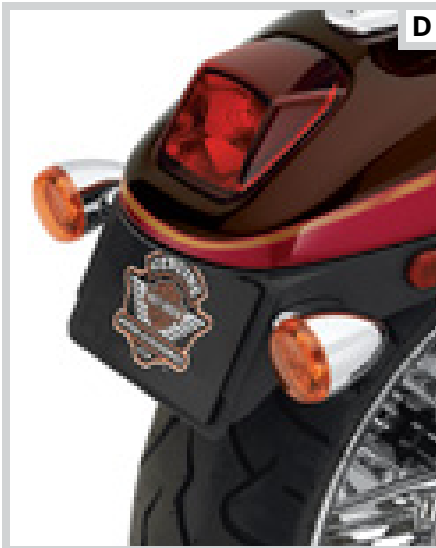

**D. CHROME BULLET REAR TURN SIGNAL KIT FOR VRSC MODELS**



**E. AUXILIARY RUNNING LIGHT/BRAKE LIGHT/TURN SIGNAL CONVERSION KIT**

**D. CHROME BULLET REAR TURN SIGNAL KIT FOR VRSC™ MODELS**

Replace the Original Equipment rear flat black bullet turn signal housings with brilliant chrome. Kit includes chrome-plated bullet-style turn signal housings, chrome rear supports, and amber-colored lenses.

**69374-05A** Bullet Lens Style. **\$94.95**  
Fits '02-later Domestic VRSCA, VRSCB, VRSCD and '07 VRSCX models.

**E. AUXILIARY RUNNING LIGHT/BRAKE LIGHT/TURN SIGNAL CONVERSION KIT**

Turn signal module adds an auxiliary brake light and running light function to your existing turn signals for auxiliary rear lighting. Red lenses glow when the headlamp is on, and increase in intensity when brakes or turn signals are activated. Easy-to-install, the kit simply plugs into your existing wiring harness. Red turn signal lenses are included. Meets DOT requirements.

**69464-06** Bullet Lens Style. **\$59.95**  
Fits '02-'06 VRSC models equipped with stock bullet turn signals.

**69580-07** Bullet Lens Style. **\$59.95**  
Fits '07-later VRSC models (except VRSCF) equipped with stock bullet turn signals.

**F. CUSTOM LED TAIL LAMP**

Function and style in one. 23 brilliant red LED lamps are set in a mirror-finished chrome inner reflector. The "diamond cut" facets shape and direct the light, and add a style all their own. Available with a red or clear outer lens, the installed lens adds a red metallic or chrome finishing touch to the rear fender. Easy plug-in connection to the Original Equipment wiring harness. Meets DOT and TUV requirements.

**69367-07** Clear Lens with Chrome Reflector. **\$134.95**  
Fits '02-later VRSC models (except VRSCF) and '00-'07 FXSTD models.

**69366-07** Red Lens with Chrome Reflector. **\$134.95**  
Fits '02-later VRSC models (except VRSCF) and '00-'07 FXSTD models.

**G. CHROME TAIL LIGHT COVER**

Dress your tail lamp in style. This chrome-plated Tail Light Cover follows the contour of the lens for a custom look. Self-adhesive backing for easy installation.

**68478-05** **\$26.95**  
Fits '02-'06 VRSC models and '07-'08 VRSCD and VRSCR models with 180mm rear tire.

**H. CHROME LICENSE PLATE MOUNT COVER**

Show off your tail. This chrome-plated cover fits over the stock fender mount license plate bracket. This mirror-finished cover features a custom reflector with graphics. Includes mounting hardware for cover and license plate.

**59726-04** **\$34.95**  
Fits '04-later VRSC models (except VRSCF).



**F. CUSTOM LED TAIL LAMP – CLEAR LENS**

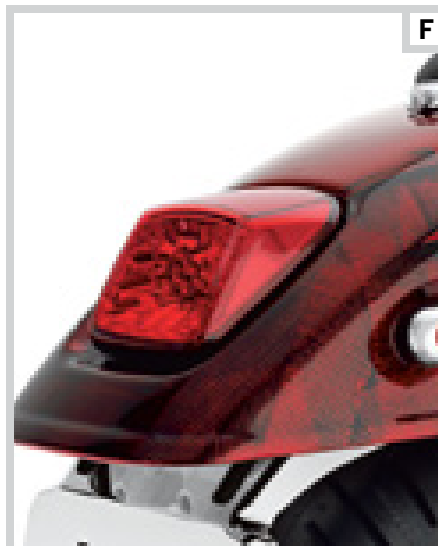

**F. CUSTOM LED TAIL LAMP – RED LENS**



**G. CHROME TAIL LIGHT COVER**



**H. CHROME LICENSE PLATE MOUNT COVER**

Notice: The prices appearing in this catalog are the manufacturer's suggested retail prices. Actual retail prices may vary.





# SPORTSTER®

*For over 50 years, the Sportster motorcycle has been a do-it-all road machine. Take advantage of its versatility by matching your bike's dimensions, functionality and character to your own personal needs. This classic gets even better when you put your signature on it.*

*For the complete list of Genuine Motor Accessories that appear on these motorcycles or any other Sportster motorcycles shown, visit: [www.harley-davidson.com/gallery](http://www.harley-davidson.com/gallery).*

LEFT XL1200N Sportster® 1200 Nightster® Scarlet Red / Vivid Black  
 RIGHT XL1200L Sportster® 1200 Low Color Shop - Pink / Vivid Black  
 LOCATION BIG STAR DRIVE-IN, KENOSHA, WI  
 GPS N 42° 35.930' - W 87° 49.655'



**ONLY YOU CAN DECIDE HOW YOU RIDE.**

*Fit and function are the bare essentials of customizing. If you do nothing else to your motorcycle, make sure your bike fits your body properly and accommodates the type of riding you plan to do.*

*Having the right accessories makes all the difference in the comfort and control you feel on the road. Take the time to learn how your Sportster® model can be personalized so you can get the most out of your riding experience.*

**FINDING YOUR FIT AND FUNCTION**

To make your Sportster® motorcycle fit you like a well-worn pair of jeans, your inspiration is only a few pages away. The page numbers listed at the right will help you quickly navigate to the section of the Catalog that most interests you. Turn the pages, and mark your trail with bent-over corners and scribbled notes in the margins. Customizing is a journey...travel well.

*For the complete list of Genuine Motor Accessories that appear on this motorcycle visit: [www.harley-davidson.com/gallery](http://www.harley-davidson.com/gallery).*



**STOPPING BY THE FIT SHOP**



**A. SEATS**

*Where the seat positions your waist relative to the foot controls, hand controls and the ground will impact your riding comfort, so test-sit a variety of seats to get it right.*

**B. FOOT CONTROLS**

*Where your feet meet the controls is equal parts riding style and physical necessity; it also determines the angle of your hip, knee and ankle, so keep it comfortable.*

**C. HANDLEBAR & CONTROLS**

*Each bar has a unique combination of rise, width and pullback—putting your hands, wrists, arms and shoulders in different configurations. See what feels natural and stick with it.*

**D. RIDE HEIGHT**

*Suspension components and seat shape combine to determine your riding position. Finding the right combination is the easiest way for a shorter rider to fit comfortably on a larger bike.*

**GEARING UP WITH RIDER ESSENTIALS**

Selecting even the basic accessories can be daunting. Start by adding versatility and long-haul comfort. These windshields, backrests and luggage racks are designed to fit your specific Sportster® model and will get you ready for the open road.

**FOR '04–LATER XL MODELS WITH TWO-UP SEATS**

Quick-Release Windshield .....	58063-04
Medium Low Upright .....	52754-04
Detachable Sissy Bar Sideplates .....	53913-04
Medium Low Backrest Pad .....	52626-04
Five Bar Sport Luggage Rack .....	53862-00
Detachable Docking Hardware .....	53529-04

**FOR '07–LATER XL1200N**

Quick-Release Windshield .....	58063-04
Black Detachable Solo Luggage Rack .....	53512-07
Detachable Docking Hardware .....	53529-04

**FOR '07–LATER XL883 & XL883N**

Quick-Release Windshield .....	58063-04
Sundowner™ Touring Seat .....	51736-07
Medium Low Upright .....	52754-04
Detachable Sissy Bar Sideplates .....	53913-04
Medium Low Backrest Pad .....	52626-04
Detachable Docking Hardware .....	53529-04
Passenger Footpeg Kit .....	50203-04

# SPORTSTER® STYLE

## SHOW OFF THE STYLE YOU WERE BORN WITH.

*This is where your ride becomes a true individual. Where leather and steel become a reflection of your passion, commitment and character. Think about styling your bike as a whole, and what look you are after. Even though your style and taste may change over time, there's only one opinion that matters here, and that's yours.*

### FINDING YOUR STYLE

This Catalog is packed with options that will let you establish your own sense of style. Flip through for inspiration, or use the page numbers below to help you quickly navigate to the pages that cover the areas you would like to customize.



GPS & AUDIO  
PG 616

CUSTOM SEAT PROGRAM  
PG 706

SECURITY & STORAGE  
PG 748

CLEANING & MAINTENANCE  
PG 760

LUGGAGE  
PG 691

### DEFINING YOUR STYLE

The possibilities are endless, so it pays to have an overall plan. Think through your customizing efforts to manage installation costs and minimize your time off the road.

#### A. FRONT & REAR END

*The front forks and rear swingarm are some of the most striking elements on your motorcycle. Custom sliders, axle covers and hardware maximize the visual impression.*

#### B. PAINT

*Your bike's paint sets the tone for the rest of your ride. From the classic and understated to the modern and brash, we have the options to help you find exactly what you want.*

#### C. CUSTOM DETAILS

*Your bike really comes alive in the details. Chrome, stylized or black components will help set your bike apart from the crowd and pull your vision together.*

#### D. WHEELS

*Your wheels, sprocket and rotors take up a lot of visual real estate and are a great way to complement or instantly overhaul the look of your ride.*

# WHAT'S HOT

*We're always pushing our design teams to come up with new, innovative, functional and stylish components to reflect your personal needs. Take a minute to see what we've cooked up, and you'll find the right additions to help you accelerate your riding experience.*

DARK CUSTOM™ LOGO COLLECTION  
PG : 89



SCREAMIN' EAGLE® MUFFLERS  
PG 477



SILENCER COLLECTION  
PG : 553



PG : 565  
MINI FOOTBOARD KIT



BOOM! AUDIO™  
HALF-HELMET  
MUSIC HEADSET  
PG : 624



ONE-PIECE  
DETACHABLE  
PASSENGER  
SISSY BAR  
PG : 78



ROAD TECH™ ZŪMO® 660 GPS NAVIGATOR  
PG 617

BROWN LEATHER  
SOLO SPRING SADDLE  
PG : 71



CHOPPED REAR FENDER  
PG : 84



PG : 553  
TRIBAL COLLECTION

XR1200  
**SPORTSTER® XR1200™**

Production Color: *Brilliant Silver Denim*

**About This Bike** Share your back road ride. Equipped to carry a passenger and a day's worth of gear, this XR1200 features performance suspension and braided brake lines that let you feel every nuance of the road.

ACCESSORIES FOR FUNCTION

Detachable Sport Windscreen.....	57262-08
Tank Bag.....	88227-08
Passenger Upright and Backrest Pad.....	53976-08
Luggage Rack.....	53920-08
Bungee Bars.....	90363-08
<b>NEW</b> Performance Suspension Kit.....	54530-10

ACCESSORIES FOR STYLE

LIGHTING

Mini Bullet Turn Signals – <i>Black with Smoked Lens</i> .....	68863-08
Mini Bullet Turn Signal Mounting Kit.....	69926-08

HAND CONTROLS

Hand Grips – <i>Diamond Black</i> .....	56405-08
Black Hand Control Levers.....	46944-07A
Front Brake Lines – <i>Braided Stainless</i> .....	45851-08

FOOT CONTROLS

Footpegs with Wear Peg – <i>Diamond Black</i> .....	50695-08
Footpegs – <i>Diamond Black</i> .....	50911-08
Rear Brake Lines – <i>Braided Stainless</i> .....	45868-08A

For the complete list of Genuine Motor Accessories that appear on this motorcycle visit: [www.harley-davidson.com/gallery](http://www.harley-davidson.com/gallery).

LOCATION.....	HWY 67, OSCEOLA, WI
GPS.....	N 43° 41.361' – W 88° 10.388'







**XL1200N  
SPORTSTER®  
1200 NIGHTSTER®**

Color Shop Custom Paint: *California Kid*

**About These Bikes** Plays well with others. Solo or two-up, this dressed-up Nightster and raw-boned Iron 883™ are ready to take on the mean streets.

**COLOR SHOP CUSTOM PAINT**

California Kid Custom Paint – *Yellow / Orange Flames* ..... 94282

**ACCESSORIES FOR FIT**

Sidekick® Seat ..... 52859-04A

**ACCESSORIES FOR FUNCTION**

**NEW** Luggage Rack – *Chopped Fender, Black* ..... 54250-10

**NEW** Sissy Bar Upright – *Black* ..... 51146-10

Backrest Pad – *Short* ..... 52631-07

**ACCESSORIES FOR STYLE**

**FRONT & REAR END**

Front Axle Covers – *Black* ..... 43428-09

Wheel Spacers – *Front, Chrome* ..... 41370-08

**HAND & FOOT CONTROLS**

Hand Levers – *Black* ..... 46944-07A

Hand Grips – *Diamond Black* ..... 56405-08

Dome Billet Mirrors – *Black* ..... 92423-08

Forward Control Kit – *Black* ..... 33397-07A

Footpegs – *Diamond Black* ..... 50911-08

Shifter Peg – *Diamond Black* ..... 34690-08

**ENGINE & CHASSIS TRIM**

Derby Cover – *Dark Custom* ..... 25563-09

Timer Cover – *Dark Custom* ..... 32415-09

**REAR END**

Rear Axle Cover – *Black* ..... 43013-09

Pivot Bolt Cover – *Black* ..... 47625-09

**SCREAMIN' EAGLE® PERFORMANCE**

Stage I Air Cleaner ..... 29782-07

Street Performance Mufflers – *Black* ..... 80726-09A

Buckshot Exhaust Shield Kit – *Black* ..... 64924-09

**XL883N  
SPORTSTER®  
IRON 883™**

Production Color: *Black Denim*

**COLOR SHOP CUSTOM PAINT**

Headlamp Visor – *Primed (Custom Painted)* ..... 68129-97

Front Spoiler – *Primed (Custom Painted)* ..... 58882-04BDK

**ACCESSORIES FOR FIT**

Brawler® Solo Seat ..... 52941-04A

**ACCESSORIES FOR STYLE**

**FRONT END**

Front Axle Covers – *Black* ..... 43428-09

**LIGHTING**

**NEW** Visor Turn Signal Ring – *Smoked Lens, Black* ..... 73342-09

**NEW** Visor Turn Signal Ring – *Red Lens, Black* ..... 73344-09

**HAND & FOOT CONTROLS**

**NEW** Hand Grips – *Silencer* ..... 55869-10

**NEW** Shifter Peg – *Silencer* ..... 35286-10

**NEW** Footpeg with Wear Peg – *Silencer* ..... 50039-10

**ENGINE & CHASSIS TRIM**

Oil Temperature Dipstick ..... 63023-05

Timer Cover – *Screamin' Eagle®, Black* ..... 32565-97A

**REAR END**

Rear Axle Cover – *Black* ..... 43013-09

Pivot Bolt Cover – *Black* ..... 47625-09A

Wheel Spacers – *Rear, Chrome* ..... 41369-08

**SCREAMIN' EAGLE® PERFORMANCE**

Stage I Air Cleaner ..... 29782-07

Street Performance Mufflers – *Black* ..... 80726-09A

Buckshot Exhaust Shield Kit – *Black* ..... 64924-09

*For the complete list of Genuine Motor Accessories that appear on these motorcycles visit: [www.harley-davidson.com/gallery](http://www.harley-davidson.com/gallery).*

**LOCATION**

PUENTE'S BARBER SHOP, MILWAUKEE, WI

**GPS**

N 43° 00.109' – W 87° 54.172'

## 64 SPORTSTER®

XR1200 Accessories

### A. DETACHABLE SPORT WINDSCREEN

Styled specifically for the XR1200™ motorcycle, this wind deflector leads your charge down the asphalt. The compact shape preserves the bike's raw, muscular look, but still splits the wind to take some of the air pressure off the chest. The sleek low-profile wind deflector features a clear-to-black gradient fade for style, and a quick-release mounting system that makes installation and removal a simple, no-tools operation.

**57262-08** 11" Gradient. **\$339.95**  
Fits '08-later XR1200 models. Overall height – 13.8"; width – 12.8".



A. DETACHABLE SPORT WINDSCREEN

### B. QUICK-RELEASE SUPER SPORT WINDSHIELD

Reduces the pounding of wind and shower of bugs, but keeps the wind-in-the-hair feeling. Ideal for a cool morning ride, the sleek profile of the Super Sport Windshield hugs the front headlamp for a sporty look. The windshield mounts to the fork tubes with elegant die-cast lever locking clamps, so the windshield does not require any "leave-behind" docking hardware. You get quick on-and-off convenience and a clean, custom look. No tools are required, and the kit includes everything needed to install the windshield.

**57260-08** 13" Lightly Smoked. **\$339.95**  
Fits '08-later XR1200 models. Overall height – 18.7"; width – 13.8".



B. QUICK-RELEASE SUPER SPORT WINDSHIELD

### C. LUGGAGE RACK\*

Add touring capabilities to your XR1200 model. This curved black rack complements the sporting lines of the rear fender, and the reinforced polymer and steel construction adds strength and durability. Rack features molded tie-down notches that easily accept cargo net or bungee cord hooks for secure loading.

**53920-08** **\$119.95**  
Fits '08-later XR1200 models.

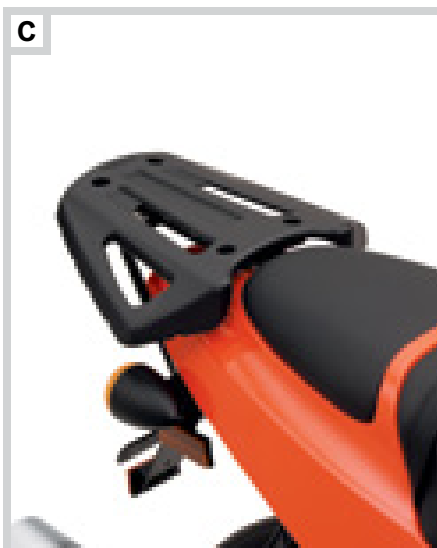

C. LUGGAGE RACK

### D. PASSENGER BACKREST

Add comfort and support for your passenger. Black polymer and steel upright provides a solid mounting point for the form fitted black vinyl backrest pad. Easy-to-install, the upright bolts into position on Luggage Rack P/N 53920-08 (sold separately).

**53976-08** **\$129.95**  
Fits '08-later XR1200 models. Installation requires separate purchase of Luggage Rack P/N 53920-08.

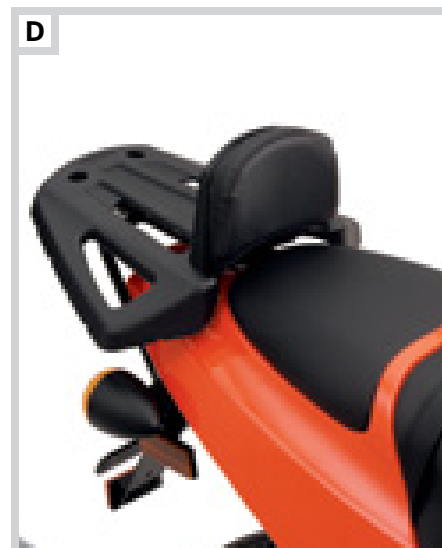

D. PASSENGER BACKREST

### E. SPORT SADDLEBAGS

Transport your stuff in style. These detachable saddlebags are custom fitted to the XR1200 model. Each molded saddlebag is covered with charcoal-colored UV and weather-resistant nylon, and is finished with simulated carbon-fiber inserts. The rigid molded body will maintain its shape empty or full, and the easy-loading clamshell bags feature water-resistant zippers to protect the contents from the elements. Quick-release clips allow the bag to be removed for packing or transportation. The left side bag features an internal pocket and the right side bag includes a mini organizer. Luggage capacity: 1000 cubic inches total. Kit includes black steel mounting brackets, bungee bars and all necessary mounting hardware.

**90328-08** **\$329.95**  
Fits '08-later XR1200 models (except XR1200X and models equipped with Performance Suspension Kit P/N 54530-10).



E. SPORT SADDLEBAGS

### F. TANK BAG

Shaped to fit the contour of the XR1200™ fuel tank, this molded Tank Bag is covered with charcoal-colored UV and weather-resistant nylon. The bag features a simulated carbon fiber top insert, electronics port, and a removable double-sided map pocket. The rigid molded body will maintain its shape when empty, and the large compartment features 3 small internal pockets to keep the contents organized. The large top opening is secured with a full-length water-resistant zipper. Bag expands up to 3.5" for increased storage capacity. Quick-release clips allow the bag to be removed for access to the fuel cap, and the comfortable carrying handle makes transportation a breeze. Luggage capacity: 555 cubic inches (unexpanded).

**88227-08** **\$139.95**  
Fits '08-later XR1200 models.



**\*WARNING:** Do not use this rack as a seat. Do not exceed the fender rack weight capacity. Using as seat or exceeding this capacity could cause handling problems which could result in loss of control and death or serious injury.

Notice: The prices appearing in this catalog are the manufacturer's suggested retail prices. Actual retail prices may vary.



F. TANK BAG



G. TAIL BAG

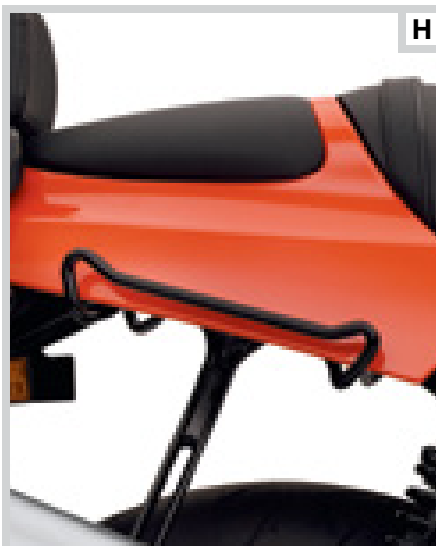

H. BUNGEE BARS

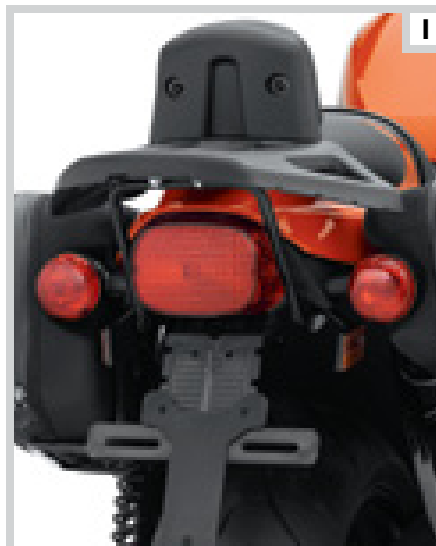
I. AUXILIARY BRAKE LIGHT/RUNNING LIGHT/  
TURN SIGNAL CONVERSION KIT

J. PERFORMANCE SUSPENSION KIT

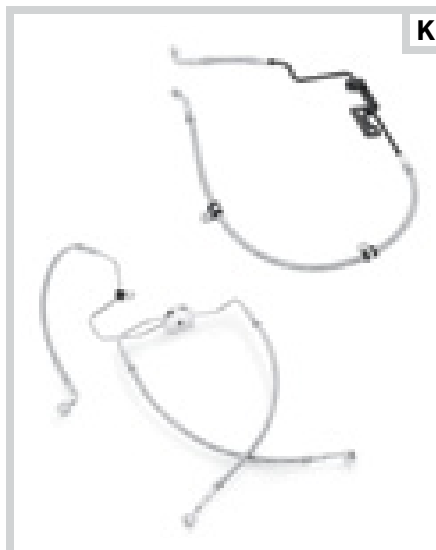

K. STAINLESS STEEL BRAIDED BRAKE LINE KITS

**G. TAIL BAG**

This removable Tail Bag is shaped to fit the XR1200 model. The molded bag is covered with charcoal-colored UV and weather-resistant nylon, and is finished with a simulated carbon fiber top insert. The rigid molded body will maintain its shape when empty, and the large center compartment and two small side compartments allow you to pack for a weekend get-away. The generous openings are secured with full-length water-resistant zippers to protect the contents from the elements. Top surface features a bungee cord web to trap small items like a hat, gloves or water bottle. Quick-release clips allow the bag to be removed for packing, and the comfortable carrying handle makes transportation a breeze. The bag doubles as a backpack when used with the included padded shoulder straps. Installed directly on the passenger pillion. Can be used with Passenger Backrest P/N 53976-08. Luggage capacity: 1040 cubic inches.

**90409-08**

Fits '08-later XR1200 models.

**\$169.95****H. BUNGEE BARS**

Secure your soft luggage or spare helmet to the passenger pillion. Bungee Bars provide a solid anchor point for bungee cords or cargo net hooks and protect the fender finish from damage. Black powder-coated steel bars feature formed detents on each side. Kit includes left and right bars and all required mounting hardware.

**90363-08**

Fits '08-later XR1200 models.

**\$49.95****I. AUXILIARY BRAKE LIGHT/RUNNING LIGHT/  
SIGNAL CONVERSION KIT**

Turn signal module adds an auxiliary brake light and running light function to your existing turn signals for auxiliary rear lighting. Red lenses glow when the headlamp is on, and increase in intensity when brakes or turn signals are activated. Easy-to-install, the kit simply plugs into your existing wiring harness. Red turn signal lenses are included. Meets DOT requirements.

**68468-09**

Fits U.S. only '09-later XR1200 models.

**\$59.95****J. PERFORMANCE SUSPENSION KIT**

Maximize the canyon-carving ability of your XR1200 motorcycle with this complete Performance Suspension Kit. Fully-adjustable light-weight suspension system features Showa's new Big Piston Front fork (BPF) design. The BPF eliminates many of the internal components used in a cartridge-type fork, simplifying construction and resulting in lighter overall fork weight. The large-diameter of the BPF's internal piston allows a reduction in damping pressure, for better feedback and smoother action. This performance suspension kit also provides a very controlled feeling which leads to more rider confidence. The BPF's rebound and compression damping force settings are easily fine tuned via two adjuster screws located on top of the fork bolts. The spring pre-load is adjusted via a M5 hex screw on the axle holders. The rear Showa shocks feature 36mm pistons with piggyback nitrogen-charged reservoirs. The compression damping can be adjusted via a knob on top of the piggyback reservoir. The rebound is adjusted with a thumb wheel on the lower clevis. Rear spring pre-load is also adjustable on the shock for optimum 1G sag. The kit includes one set of Big Piston Front Forks and one set of rear shocks.

**54530-10**

Fits '08-later XR 1200 models. Stock on '10 XR 1200X models. Does not fit with Sport Saddlebag Kit P/N 90328-08.

**\$1,499.95****K. STAINLESS STEEL BRAIDED BRAKE LINE KITS**

Dress your bike for maximum custom impact. Harley-Davidson® stainless steel lines, with chrome-plated banjo ends, are custom fit to particular model applications. They meet all DOT requirements and include all necessary hardware. Kits for dual disc models consist of three brake lines with a chrome-plated junction tee.

Fits '08-later XR1200 models.

**45851-08**

Front.

**\$129.95****45868-08A**

Rear.

**\$99.95**

# SPORTSTER® WINDSHIELDS

## SPLIT THE WIND.

*At highway speed, you take the wind full-force in the chest, causing fatigue in your arms, neck and shoulders. Take the pressure off with an easy-to-install detachable windshield. Shaped to divert air, rain and road debris around the rider, a windshield can add hours of riding comfort.*

### SPORTSTER WINDSHIELD TYPES



**SUPER SPORT WINDSHIELD**

*Low and lean shape gives your bike a sleek and athletic appearance. Minimal coverage, but sometimes that's all you need to extend your ride into the next straightaway.*



**COMPACT WINDSHIELD**

*Standard issue windshield for any ride. The compact size takes on everything the road throws at it while maintaining a clean and strictly business look.*



**THE SELECTION GUIDE**

*For maximum wind protection, and the best view down the road, select a windshield that tops out just below your line of sight. Your dealer has the tools to make the selection simple.*

### CHANGING YOUR WINDSHIELD



Designed to be installed or removed without tools in seconds, a Detachable Windshield gives you the freedom to define your ride at the drop of a hat. Ride across the country protected from the elements, then quickly remove the windshield to hit the streets in style.

- A. STANDARD DETACH HARDWARE
- B. QUICK-DETACH HARDWARE

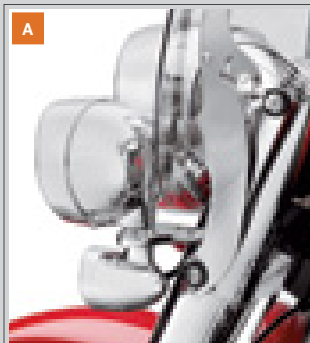





A. 18" QUICK-RELEASE COMPACT WINDSHIELD – POLISHED BRACES



A. 14" QUICK-RELEASE COMPACT WINDSHIELD – GLOSS BLACK (SHOWN WITH GLOSS BLACK DIRECTIONAL RELOCATION KIT)



B. QUICK-RELEASE SUPER SPORT WINDSHIELD

**WINDSHIELDS**

Whether it's for keeping bugs off your face or warmth in your body, a windshield has a huge impact on rider and passenger comfort. By diverting air pressure past your chest and over your helmet, a windshield can add hours of riding comfort. For maximum protection from wind and weather, select a windshield that tops out just below your line of sight. You avoid looking through rain drops, bug spots and road grime to get a clear view of the highway ahead.

**A. QUICK-RELEASE COMPACT WINDSHIELD**

Combine the classic Harley-Davidson® windshield shape with a revolutionary new attachment system, and you have the best of style and function. The windshield mounts to the fork tubes with elegant die-cast lever-release clamps, so the windshield does not require any "leave-behind" docking hardware. You get quick on-and-off convenience, and a clean, custom look. No tools are required, and the kit includes everything needed to install the windshield. The tough, hard-coated polycarbonate windshield is available with traditional polished or gloss black horizontal and vertical braces.

Fits '88-later XL and '91-'05 Dyna® models (except FXDWG and FXDXT).

**Polished Braces**

**58063-04** 18" Clear. **\$349.95**

Windshield dimensions: Overall height – 26.8"; width – 19.7".

**58601-04** 18" Lightly Smoked. **\$384.95**

Windshield dimensions: Overall height – 26.8"; width – 19.7".

**58602-04** 14" Lightly Smoked. **\$374.95**

Windshield dimensions: Overall height – 22.8"; width – 19.5".

**Gloss Black Braces**

**58706-09** 18" Clear. **\$374.95**

Windshield dimensions: Overall height – 26.8"; width – 19.7".

**58703-09** 14" Lightly Smoked. **\$399.95**

Windshield dimensions: Overall height – 22.8"; width – 19.5".

**Also available:****FRONT DIRECTIONAL RELOCATION KIT**

This kit includes the required hardware and wiring to move the front directional lamps from the handlebar to the lower triple clamp.

Fits '88-later XL and '91-'05 Dyna models (except FXDWG and FXDXT).

**68517-94A** Chrome. **\$28.95**

**68643-09** Gloss Black. **\$28.95**

**B. QUICK-RELEASE SUPER SPORT WINDSHIELD**

Reduces the pounding of wind and shower of bugs, but keeps the wind-in-the-hair feeling. Ideal for a cool morning ride, the sleek profile of the Super Sport Windshield hugs the front headlamp for a sporty look. The windshield mounts to the fork tubes with elegant die-cast lever locking clamps, so the windshield does not require any "leave-behind" docking hardware. You get quick on-and-off convenience and a clean, custom look. No tools are required, and the kit includes everything needed to install the windshield.

**57838-08** 19" Lightly Smoked. **\$309.95**

Fits '88-later XL and '91-'05 Dyna® models (except FXDWG and FXDXT). XL Custom models require Front Directional Relocation Kit P/N 68517-94A. Windshield dimensions: Overall height – 25.0"; width – 20.1".

Notice: The prices appearing in this catalog are the manufacturer's suggested retail prices. Actual retail prices may vary.

# 68 SPORTSTER®

Windshields

## A. QUICK-RELEASE TOURING WINDSHIELD

The Touring Windshield features an aerodynamic design shaped to provide hours of riding comfort. The additional center width directs airflow past the hand grips, and deflects rain and road debris around the rider. The windshield mounts to the fork tubes with elegant die-cast lever-release clamps, so the windshield does not require any "leave-behind" docking hardware. You get quick on-and-off convenience, and a clean, custom look. No tools are required, and the kit includes everything needed to install the windshield. The tough, hard-coated polycarbonate windshield features traditional chrome horizontal and vertical braces.

**58158-08** 19" Clear. **\$424.95**  
Fits '88-later XL and '91-'05 Dyna® models (except FXDWG and FXDXT). Windshield dimensions: Overall height – 28.3"; width – 22.1".

## B. DETACHABLE COMPACT WINDSHIELD FOR MODELS WITH AUXILIARY LIGHTING

Dress up or down with the convenience of a Detachable Windshield on your XL or Dyna® model equipped with Auxiliary Lighting Kits. Choose either clear or lightly smoked.

**57716-01** 18" Clear. **\$274.95**  
Fits '88-later XL and '91-'05 Dyna models (except FXDWG and FXDXT) equipped with Auxiliary Lamps. Requires the separate purchase of Docking Hardware Kit P/N 58164-96A and Turn Signal Relocation Kit P/N 68603-01. Windshield dimensions: Overall height – 26.8"; width – 19.7".

## DOCKING HARDWARE FOR DETACHABLE WINDSHIELDS (not shown)

Each kit includes polished clamps and all required mounting hardware.

**58164-96A** **\$69.95**  
Required for installation of Detachable Windshields on '88-later XL and '91-'05 Dyna models (except FXDWG and FXDXT). XL and Dyna models with Front Turn Signals originally located on the upper triple clamp may require the additional purchase of Turn Signal Wiring Kit P/N 72389-96.

## C. SPORT WINDSHIELD KIT

Formed of Lexan® polycarbonate and hard-coated to resist scratching. Lightly smoked windshield is contoured to fit the headlamp and incorporates adjustable four-point mounting. Functional styling helps deflect wind to reduce upper body fatigue.

**58192-87A** 17" Lightly Smoked. **\$164.95**  
Fits '88-later XL and '91-'05 Dyna models (except XL Custom, FXDWG and FXDXT). Windshield dimensions: Overall height – 18.5"; width – 16.3".

**58024-96A** 17" Lightly Smoked. **\$169.95**  
Fits '96-later XL Custom and '87-'94 FXLR models. Also fits '99-'00 FXR models. Windshield dimensions: Overall height – 19.1"; width – 16.3".

## D. DETACHABLE QUARTER FAIRING KIT

Sleek, racy styling and sweeping lines are the make up of this innovative fairing. Its quarter-sized, detachable design gives your bike a whole new, sporty look that can be changed in an instant. Available in prime or Vivid Black. Requires the installation of Detachable Docking Hardware Kit P/N 58164-96A.

Fits '88-later XL, FXR and '95-'05 Dyna models (except XL Custom, FXLR, FXDXT and FXDWG).

**57070-98** Primed. **\$264.95**  
**57070-97DH** Vivid Black. **\$394.95**

## E. HEADLAMP VISOR

Add an element of racy style to stock headlamps with these visors, available in prime or Vivid Black.

Fits '95-later XL models (except XL Custom) '95-'05 Dyna models (except FXDWG and FXDXT), '82-'94 FXR and FXRS models.

**68129-97** Primed. **\$114.95**  
**68129-98DH** Vivid Black. **\$214.95**

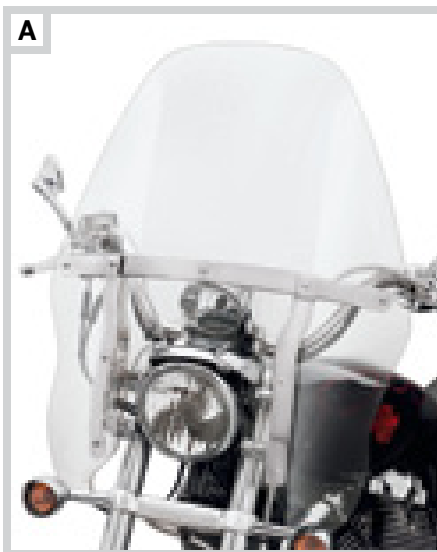

A. QUICK-RELEASE TOURING WINDSHIELD



B. DETACHABLE COMPACT WINDSHIELD FOR MODELS WITH AUXILIARY LIGHTING



C. SPORT WINDSHIELD KIT – XL CUSTOM



C. SPORT WINDSHIELD KIT – XL/DYNA



D. DETACHABLE QUARTER FAIRING KIT

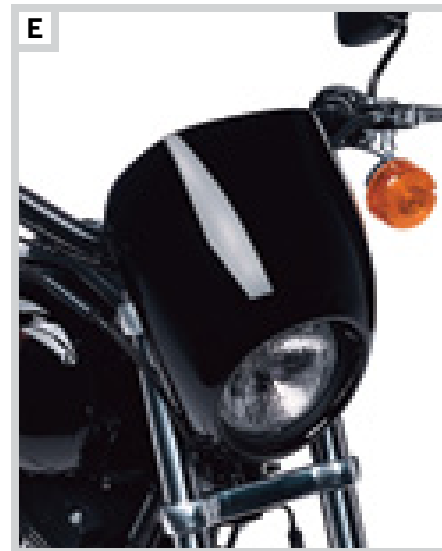

E. HEADLAMP VISOR

Notice: The prices appearing in this catalog are the manufacturer's suggested retail prices. Actual retail prices may vary.

## NEVER IN A TIGHT SPOT.

*On the road, you've got to feel good in the saddle. Your bike should welcome you like an old friend and feel like an extension of yourself. Choose the seat, controls and ride height that best equip your ride to match your personal dimensions.*

### SPORTSTER COMFORT

#### BACKREST & LUGGAGE RACK

*Detachable backrest and luggage rack add touring capabilities to a stripped-down custom.*



#### PROFILE® LOW SUSPENSION

*Front and rear suspension components drop the seat height to help you plant your feet firmly on the ground.*

#### HAND & FOOT CONTROLS

*Change your riding position by adding pull back handlebars, handlebar risers and forward controls.*



### SPORTSTER SEAT TYPES

Solo or two-up, comfort or style, check out these seats to get an idea of where you want to sit.



#### LOW-PROFILE SEATS

*These saddles combine radical styling with a "deep in the bike" riding position. Long and lean, Badlander®, Brawler® and Sidekick® seats bring you lower to the ground than most other seats.*

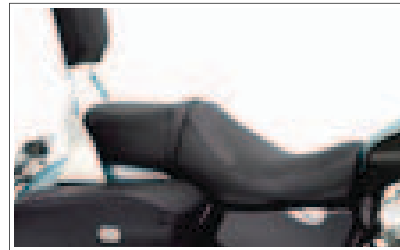

#### POSITION SEATS

*Specially designed to move shorter riders closer to the controls, the Reach® Seat features a low profile and a narrow thigh zone to bring the legs closer together to minimize leg stretch.*

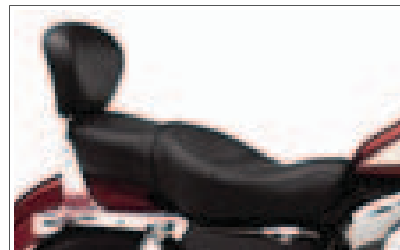

#### TOURING SEATS

*Designed for comfort, touring seats and passenger pillions offer a broad seating surface to reduce pressure points. The disbed shape holds you in place and provides additional back support.*

### THE FIT SHOP LIST



Here are a few options to consider when outfitting your bike to fit you. Find your model, and flip to the pages for more information.

2010	SUSPENSION	SEATS	HAND CONTROLS	FOOT CONTROLS
XL883L / XL883N / XL1200N	Two-up Profile® Low Rear Shock (pg. 101)	Reach® Seat Brawler® / Sidekick® Seat Badlander® Seat (pg. 70-71)	Various handlebar and / or riser options available (pg. 102-103)	Forward Control Kit (pg. 106)
XL1200L	N / A	Same as above (pg. 70-71)	Same as above (pg. 102-103)	Same as above (pg. 106)
XL883C / XL1200C	Profile Low Front Suspension (pg. 101)	Same as above (pg. 70-71)	Pullback Handlebar (pg. 102)	N / A

# 70 SPORTSTER®

## Seating

### A. BRAWLER® SEAT

When it's time to go it alone, go in style. These premium quality cowhide leather solo saddles feature a smooth, sleek design that hugs the frame rails for a true custom look. Top-grain leather seating surface and contoured foam padding add long-haul comfort, and the durable hand-laid fiberglass seat pan is carpeted to protect the paint finish. This seat does not fit with passenger pillions.

**52940-04A** **\$269.95**  
Fits '04-later XL883C, XL1200C, XL1200L and '08-later XL1200R models. Seat width 12.5".

**52941-04A** **\$269.95**  
Fits '04-later XL 50th Anniversary, XL883, XL883L, XL883N, XL883R, XL1200N and '04-'07 XL1200R models. Seat width 12.5".

**52198-03** **\$269.95**  
Fits '83-'03 XL models. Seat width 12.5".



A. BRAWLER SEAT

### B. SIDEKICK® SEAT

Share your custom ride with a passenger. This two-up cowhide leather seat offers a frame-hugging look, but adds back support for the rider and additional padding for the passenger. Top-grain leather seating surface and contoured foam padding add long-haul comfort, and the durable hand-laid fiberglass seat pan is carpeted to protect the paint finish.

**52849-04A** **\$299.95**  
Fits '04-later XL883C, XL1200C, XL1200L and '08-later XL1200R models. Seat width 12.5"; passenger pillion width 5.0".

**52859-04A** **\$299.95**  
Fits '04-later XL 50th Anniversary, XL883, XL883L, XL883N, XL883R, XL1200N and '04-'07 XL1200R models. (XL883, XL883L, XL883N and XL1200N models require separate purchase of Passenger Footpeg Kit P/N 50203-04.) XL883N and XL1200N models also require separate purchase of Retention Washer P/N 7487. Seat width 12.5"; passenger pillion width 5.0".



B. SIDEKICK SEAT

### C. RALLYRUNNER® SEAT

The two-up profile of this custom seat maintains a lean look, but adds back support for the rider, and additional padding for the passenger. Made of the highest quality cowhide, this premium seat offers a radical style with a touch of comfort. Top-grain leather seating surface and contoured foam padding add long-haul comfort, and the durable hand-laid fiberglass seat pan is carpeted to protect the paint finish.

**52916-04A** **\$299.95**  
Fits '04-later XL883C, XL1200C, XL1200L and '08-later XL1200R models. Seat width 12.5"; passenger pillion width 8.0".

**52923-04A** **\$299.95**  
Fits '04-later XL 50th Anniversary, XL883, XL883L, XL883N, XL883R, XL1200N and '04-'07 XL1200R models. (XL883, XL883L, XL883N, and XL1200N models require separate purchase of Passenger Footpeg Kit P/N 50203-04.) XL883N and XL1200N models also require separate purchase of Retention Washer P/N 7487. Seat width 12.5"; passenger pillion width 8.0".



C. RALLYRUNNER SEAT

### D. BADLANDER® SEAT

A perfect seating surface for cruising the town, this low, slammed seat offers a clean, custom look. The smooth covers and subtle top-stitching feature two embroidered "Harley-Davidson" logos.

**51749-07** **\$199.95**  
Fits '07-later XL883C, XL1200L, XL1200C and '08-later XL1200R models. Seat width 12.0"; passenger pillion width 5.0".

**52379-04** **\$199.95**  
Fits '04-'06 XL883C, XL 1200C and XL1200L models. Seat width 12.0"; passenger pillion width 5.0".

**51747-07** **\$199.95**  
Fits '07-later XL 50th Anniversary, XL883, XL883L, X883N, XL883R, XL1200N and '07 XL1200R models. XL883, XL883L, XL883N and XL1200N models require separate purchase of Passenger Footpeg Kit P/N 50203-04. XL883N and XL1200N models also require separate purchase of Retention Washer P/N 7487. Seat width 12.0"; passenger pillion width 5.0".

**52381-04** **\$199.95**  
Fits '04-'06 XL883, XL883L, XL883R, and XL1200R models. XL883 and XL883L require separate purchase of Passenger Footpeg Kit P/N 50203-04. Seat width 12.0"; passenger pillion width 5.0".

**52296-94B** **\$199.95**  
Fits '83-'03 XL models. Seat width 12.0"; passenger pillion width 5.0".



D. BADLANDER SEAT



**NEW****E****SPORTSTER® 71**

Seating

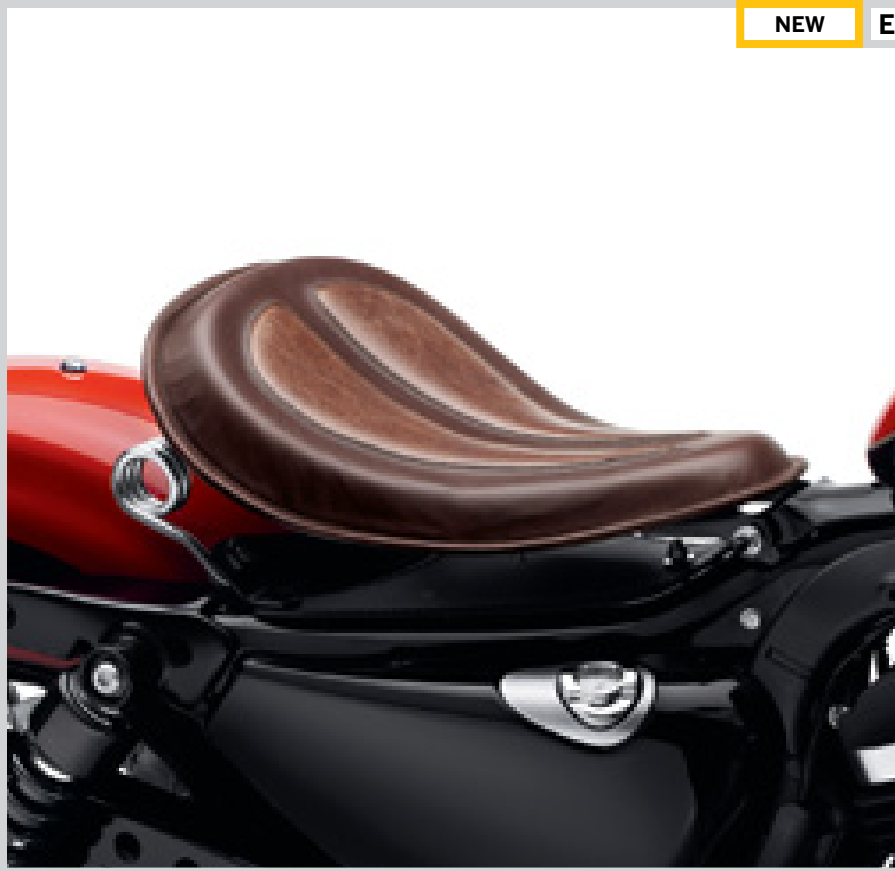
**E. SOLO SPRING SADDLE – BROWN LEATHER****E. SOLO SPRING SADDLE – BROWN LEATHER**

Add nostalgic "bobber" looks to your modern Harley-Davidson motorcycle. This elegant two-tone distressed leather solo seat features a low-profile design that provides the minimalist "just enough to ride" look. The torsion-style springs are designed for the optimum balance between spring suspension and support. The smooth metal seat pan and the simple frame cover leave a clean, finished appearance. Easy-to-install, the bolt-on seat and model-specific Spring Seat Installation Kits includes everything you need to get the bobber look. No cutting, welding, or fabrication is necessary, and the seat can be removed and replaced with a touring seat for a two-up night on the town.

**54072-10 \$269.95**

Fits '10 XL, '04-'06 XL, and '06-later Dyna models. Installation requires separate purchase of model-specific Seat Installation Kit P/N 54074-10 or 54075-10. Seat width 10.5".

**Spring Seat Installation Kit**

Required for installation of Solo Spring Saddle Kit P/N 54072-10. Kit includes springs, mounting brackets, frame cover and hardware.

**54074-10 \$229.95**

Fits '10 and '04-'06 XL models.

**F. REACH® SEAT**

Designed specifically for riders requiring a close to the bar riding position, without compromising comfort. This seat positions the rider approximately 1/2" forward, closer to the hand and foot controls. The narrow front profile brings your legs closer together to help you plant your feet firmly on the ground. The slightly bucketed rider seat offers lower back support and features a textured insert to prevent you from sliding around while riding.

**51738-07 \$199.95**

Fits '07-later XL883C, XL1200L, XL1200C and '08-later XL1200R models. Seat width 14.0"; passenger pillion width 10.0".

**51737-07 \$199.95**

Fits '07-later XL 50th Anniversary, XL883, XL883L, XL883N, XL883R, XL1200N and '07 XL1200R models. (XL883, XL883L, XL883N and XL1200N models require separate purchase of Passenger Footpeg Kit P/N 50203-04.) XL883N and XL1200N models also require separate purchase of Retention Washer P/N 7487. Seat width 14.0"; passenger pillion width 10.0".

**51533-04 \$199.95**

Fits '04-'06 XL883, XL883L, XL883R and XL1200R models. XL883 and XL883L require separate purchase of Passenger Footpeg Kit P/N 50203-04. Seat width 11.5"; passenger pillion width 6.0".

**G. REACH SOLO SEAT**

Need to get your feet firmly on the ground? This ergonomically friendly Solo Seat moves the rider 1/2" forward, and offers a truly comfortable seating option for the rider with a shorter inseam. The wide bucket surface provides a comfortable perch for those long rides, while the narrow front brings your legs together for a more natural riding position around town.

**51751-07 \$139.95**

Fits '07-later XL883C, XL1200L, XL1200C and '08-later XL1200R models. Seat width 14.0".

**51750-07 \$139.95**

Fits '07-later XL 50th Anniversary, XL883, XL883L, XL883N, XL883R, XL1200N and '07 XL1200R models. XL883N and XL1200N models also require separate purchase of Retention Washer P/N 7487. Seat width 14.0".

**H. LOW-PROFILE SOLO SEAT**

This Low-Profile Solo Seat offers a truly comfortable seating option for the rider with a shorter inseam. The wide bucket surface provides a comfortable perch for those long rides, while the narrow front brings your legs together for a more natural riding position around town.

**51538-04 \$139.95**

Fits '04-'06 XL883C, XL1200C and XL1200L models. Seat width 14.5".

**51538-00 \$139.95**

Fits '83-'03 Sportster® models. Seat width 14.5".

**F. REACH SEAT****G. REACH SOLO SEAT****H. LOW-PROFILE SOLO SEAT**

Notice: The prices appearing in this catalog are the manufacturer's suggested retail prices. Actual retail prices may vary.

SPORTSTER

# 72 SPORTSTER®

## Seating

### A. SUNDOWNER™ DEEP BUCKET SEAT

The Sundowner™ Seat provides the maximum in long-riding comfort, along with a healthy helping of style and quality. This seat features a deep, contoured rider bucket that provides lower back support to keep you comfortable longer. The wide passenger pillion gives your passenger added comfort as well.

**51739-07** **\$269.95**

Fits '07-later XL883C, XL1200L, XL1200C and '08-later XL1200R models. Seat width 14.5"; passenger pillion width 12.0".

**51736-07** **\$269.95**

Fits '07-later XL 50th Anniversary, XL883, XL883L, XL883N, XL883R, XL1200N and '07 XL1200R models. XL883, XL883L, XL883N and XL1200N models require separate purchase of Passenger Footpeg Kit P/N 50203-04. XL883N and XL1200N models also require separate purchase of Retention Washer P/N 7487. Seat width 14.5"; passenger pillion width 12.0".

**51507-04** **\$269.95**

Fits '04-'06 XL883C, XL1200C and XL1200L models. Seat width 15"; passenger pillion width 12.5".

**51509-04** **\$269.95**

Fits '04-'06 XL883, XL883L, XL883R and XL1200R models. XL883 and XL883L require separate purchase of Passenger Footpeg Kit P/N 50203-04. Seat width 15"; passenger pillion width 12.5".

**51544-01A** **\$269.95**

Fits '83-'03 XL models. Seat width 15"; passenger pillion width 12.5".

#### Shown with:

#### LOW BACKREST PAD – SMOOTH BUCKET

Features large bucket shape, with a generous radius and ample padding. This Backrest Pad offers extra comfort for your passenger.

**51132-98** **\$89.95**

Fits Low Medallion Plate Style Sissy Bar Upright.

### B. PILLOW-LOOK TOURING SEAT

This Pillow-Look Seat is designed with wider, bucket-shaped seating areas. The increased filler thickness adds additional support and long-distance comfort. Includes passenger grab strap.

**52109-04** **\$199.95**

Fits '04-'06 XL883C, XL1200C and XL1200L models. Seat width 12.0"; passenger pillion width 11.5".

**52112-04** **\$199.95**

Fits '04-'06 XL883, XL883L, XL883R and XL1200R models. XL883 and XL883L require separate purchase of Passenger Footpeg Kit P/N 50203-04. Seat width 12.0"; passenger pillion width 11.5".

**52105-93C** **\$199.95**

Fits '83-'03 XL models. XL1200S, XL1200C and XL883C requires separate purchase of Seat Bracket Kit P/N 52030-98. Seat width 12.0"; passenger pillion width 11.5".

### C. CIRCULATOR SEAT PAD

Keep comfortable on your next long ride. These breathable Circulator Seat Pads feature 3D construction that promotes air movement and reduces heat build-up where the rider's body touches the seat. Designed to keep the rider cool by reducing the perspiration build-up between you and the seating surface, the Circulator Pad can be installed and removed in seconds for easy cleaning. The low-profile design minimizes seat-height change compared to inflatable pads, while enhancing comfort with its shock-absorbing construction. Manufactured of UV-stable materials, these seat pads resist fading when exposed to the sun. Elastic under-seat strap and non-slip base provide secure installation, and the available Circulator Passenger Pillion Pad attaches to the rider pad with hook-and-loop tabs.

**51074-10** Medium Pad (14.5" width). **\$79.95**

Fits VRSC, XL and Dyna models with Original Equipment and accessory seats.

**51078-10** Passenger Pillion Pad (13.0" width). **\$69.95**

Fits Original Equipment and accessory passenger pillions.



A. SUNDOWNER DEEP BUCKET SEAT  
(SHOWN WITH SMOOTH BUCKET LOW BACKREST PAD)



B. PILLOW-LOOK TOURING SEAT (SHOWN WITH PILLOW-LOOK LOW BACKREST PAD)



C. CIRCULATOR SEAT PAD

Notice: The prices appearing in this catalog are the manufacturer's suggested retail prices. Actual retail prices may vary.

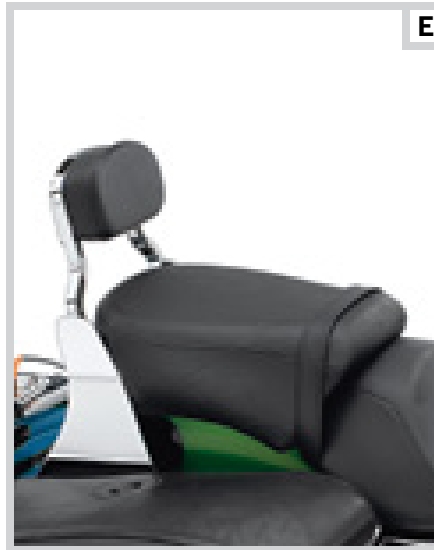
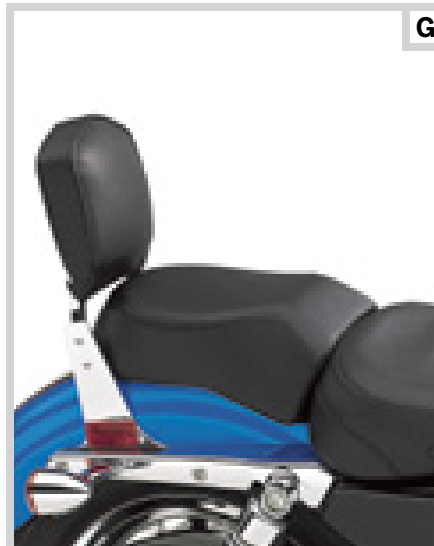
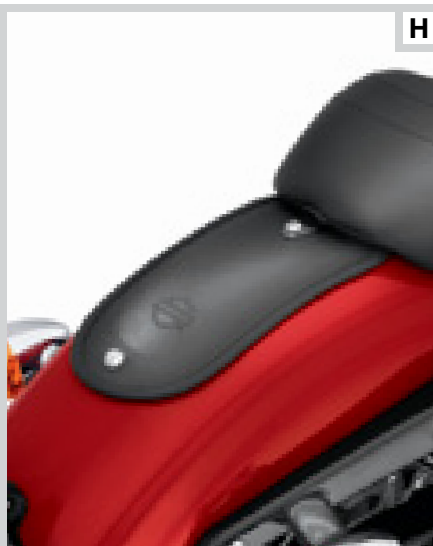
**D. PASSENGER PILLION – '07-LATER MODELS****E. PASSENGER PILLION FOR XL883 LOW MODELS – '05-'06 MODELS****F. PASSENGER PILLION FOR XL883 MODELS – '04-'06 MODELS****G. LOW-PROFILE PASSENGER PILLION – '04-'06 MODELS****H. REAR FENDER BIB – SPORTSTER MODELS****I. DETACHABLE SEAT HARDWARE KIT****D. PASSENGER PILLION\***

Bring a guest along on your solo-seat equipped Sportster® model. The smooth cover and top stitching of this Passenger Pillion complements the Original Equipment Solo Seat and the Reach® Solo Seat. Kit includes grab strap and mounting hardware.

**51744-07** **\$99.95**

Fits '07-later XL models equipped with Original Equipment or Reach Solo Seats. Requires installation of passenger footpegs (*sold separately*). Pillion width 10.0".

**E. PASSENGER PILLION FOR XL883 LOW MODELS\***

Styled to match the stitching and texture of the Original Equipment rider seat on the Sportster XL883 Low. This stylish pillion provides an extra comfortable ride for your passenger on those long journeys. Includes grab strap and mounting hardware.

**51810-05** **\$109.95**

Fits '05-'06 XL883L models. Requires installation of passenger footpegs (*sold separately*). Pillion width 11.0".

**F. PASSENGER PILLION FOR XL883 MODELS\***

Bring a passenger along for the ride. This passenger pillion matches the Sportster® 883 Standard Original Equipment Solo Seat, and includes a passenger grab strap.

**51546-04** **\$109.95**

Fits '04-'06 XL883 models. Requires installation of passenger footpegs (*sold separately*). Pillion width 9.5".

**G. LOW-PROFILE PASSENGER PILLION\***

Bring a guest along on your solo-seat equipped Sportster model. This Low-Profile Passenger Pillion matches the Sportster Low-Profile Solo Seat and includes grab strap and mounting hardware.

**51539-04** **\$109.95**

Fits '04-'06 XL883C, XL1200C and XL1200L models equipped with Reach Seat P/N 51538-04. Requires installation of passenger footpegs (*sold separately*). Pillion width 6.0".

**51539-00** **\$109.95**

Fits '83-'03 Sportster models equipped with Reach Seat P/N 51538-00. Requires installation of passenger footpegs (*sold separately*). Pillion width 6.0".

**H. REAR FENDER BIB – SPORTSTER® MODELS**

Go solo in style. Form-fitted to hug the contour of the rear fender, this decorative fender cover hides the seat mounting holes that are exposed when riding with a solo seat. Wrapped in smooth vinyl to match Original Equipment or accessory solo seats, the Fender Bib features an embossed Bar & Shield logo for added style. The molded base is finished with a soft felt under-liner designed to protect the fender's painted surface.

**52017-08** **\$59.95**

Fits '04-later XL models equipped with Original Equipment solo seat or Reach Solo Seat P/N 51750-07 or 51751-07. Will not fit models equipped with Bobtail Rear Fender.

**I. DETACHABLE SEAT HARDWARE KIT**

These hardware kits allow the rider to remove one-piece Harley-Davidson® seats quickly and easily.

**51676-97A** **\$24.95**

Fits '97-later XL, Dyna®, Softail® and Touring models. Does not fit seats equipped with spring-loaded rear seat bracket.



**\*WARNING:** Do not install on XL models that are not equipped with passenger footpegs. Doing so could result in death or serious injury.

Notice: The prices appearing in this catalog are the manufacturer's suggested retail prices. Actual retail prices may vary.

# Choosing a Backrest

A sissy bar upright and passenger backrest are the starting point to build a complete touring machine. The backrest provides long-range comfort and support, and adds a feeling of control and confidence for the passenger. For permanent installation, choose rigid sideplates and a style of upright that suits your riding style. For added flexibility, choose a detachable sideplate kit and appropriate Docking Hardware to make adding or removing a Detachable accessory a simple “slide and click” proposition.

**GENUINE HARLEY-DAVIDSON®  
SISSY BAR SIDEPLATES**

Add your choice of sissy bar uprights, backrest pads and luggage racks when you install rigid or detachable sideplates to your motorcycle. Manufactured and tested to rigorous Harley-Davidson standards, these sideplates are designed to specific model application for exact fit.

**Rigid Mount Sideplates**

Fits '04-later XL models.

**1. 53925-04** Chrome. **\$84.95**

Fits '94-'03 XL models.

**2. 52806-94B** Chrome. **\$84.85**

**Detachable Sideplates**

Fits '04-later XL models. Requires separate purchase of Docking Hardware Kit (see docking hardware matrix).

**3. 53913-04** Chrome. **\$139.95**

**4. 52710-07** Gloss Black. **\$139.95**

Fits '94-'03 XL models. Requires separate purchase of Docking Hardware Kit (see docking hardware matrix).

**5. 53545-95** Chrome. **\$139.95**

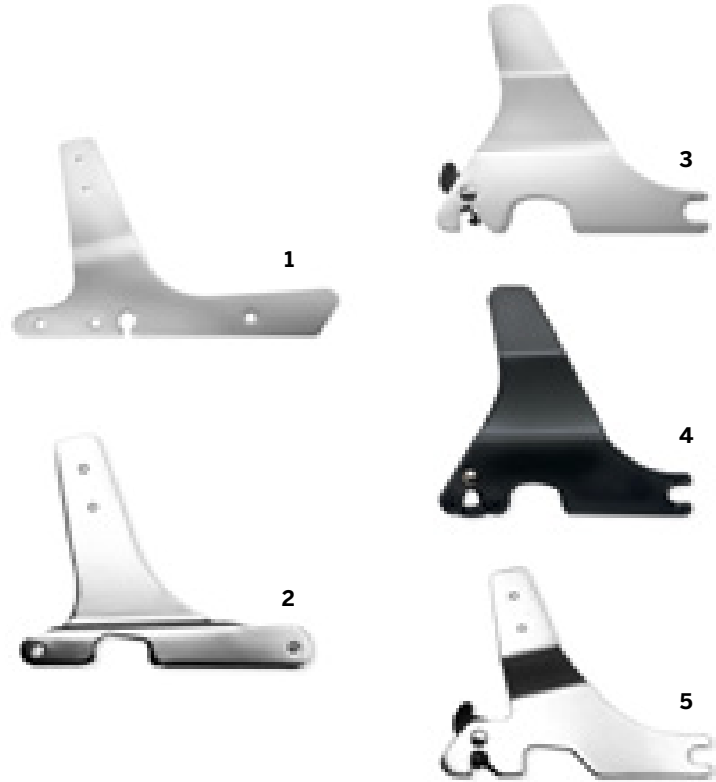

GENUINE HARLEY-DAVIDSON SISSY BAR SIDEPLATES

**Required Docking Hardware for Detachable Racks and Sideplates with or without the use of Saddlebags**

**2004-later XL Detachable Docking Kit**  
*Detachable Accessory*

<i>Detachable Accessory</i>	<i>Available to fit:</i>	<b>Detachable Sideplate Options</b>	<b>Required Docking Hardware</b>
Detachable Sideplates or Detachable Solo Rack 53494-04, 53512-07 or Detachable Solo Tour-Pak® Rack P/N 53655-04 with Leather Saddlebag P/Ns 53050-04B, 90330-08 or 88312-07.	2004-later XL models (except XL883N and XL1200N)	<b>53913-04</b> Chrome <b>52710-07</b> Black	<b>53544-04</b> <b>\$34.95</b>
Detachable Sideplates or Detachable Solo Rack 53494-04 or 53512-07 without Leather Saddlebags.	2004-later XL models	<b>53913-04</b> Chrome <b>52710-07</b> Black	<b>53529-04</b> <b>\$39.95</b>
Detachable Sideplates or Detachable Solo Rack 53494-04, 53512-07 or Solo Tour-Pak Mounting Rack 53655-04 with Hard Saddlebags 91412-00XX.	2004-later XL models (except XL883N and XL1200N)	<b>53913-04</b> Chrome <b>52710-07</b> Black	<b>53529-04 &amp; 91405-04</b> <b>\$39.95</b> <b>\$49.95</b>

**1994-2003 XL Detachable Docking Kit**

Detachable Sideplates; 53545-95, 53609-01 or Detachable Solo Rack 53495-95 with: Leather Saddlebags; 90598-04, 90342-04A or 90330-08.	1994-2001 XL models	<b>53545-95</b> Chrome	<b>90465-98A</b> <b>\$41.95</b>
	2002-2003 XL (except XL Sport)	<b>53545-95</b> Chrome	<b>53532-02</b> <b>\$41.95</b>
Detachable Sideplates; 53545-95, 53609-01 or Detachable Solo Rack 53495-95 without Leather Saddlebags.	1994-2003 XL models	<b>53545-95</b> Chrome	<b>53528-95B</b> <b>\$39.95</b>
Detachable Sideplates; 53545-95, 53609-01 or Detachable Solo Rack 53495-95 with Hard Saddlebags 91370-00XX.	1994-2003 XL models (except XL1200 Sport or 883R with remote reservoir shocks)	<b>53545-95</b> Chrome	<b>53528-95B &amp; 91385-00</b> <b>\$39.95</b> <b>\$34.95</b>

Notice: The prices appearing in this catalog are the manufacturer's suggested retail prices. Actual retail prices may vary.



## Select a Height



Tall



Low



Medium Low



Short



Mini

### Tall Sissy Bar Uprights

Let your passenger ride tall in the saddle with a Tall Sissy Bar Upright. This upright provides maximum upper back support when equipped with your choice of Backrest Pad.

### Low Sissy Bar Uprights

Give your passenger additional back support with a Low Sissy Bar Upright, designed to accept a wide variety of backrest pads.

### Medium Low Sissy Bar Upright

Shaped to complement a thicker passenger pillion, this Sissy Bar Upright stands between the Low and Short Sissy Bar Upright. The ideal match for touring style seats, this upright also offers an additional height option to riders with custom style seats.

### Short Rail Sissy Bar Upright

This Sissy Bar Upright is lower than traditional low uprights and the hidden Backrest Pad Mounting System allows for a sleek look when the pad is removed.

### Mini Rail Sissy Bar Upright

Unique hidden Backrest Pad attachment makes for ultra-clean look with pad removed. NOTE: Must only be installed on models equipped with Badlander®, Stripper®, Sidekick®, Sidekick Custom and Rallyrunner® Style Seats.

## Select a Style

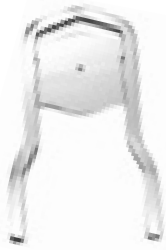

Medallion Style



Insert Style



Mini Medallion Style



Padded Logo Style

### Padded Logo Insert

**99013-82** **\$10.35**

For use with Low Sissy Bar Upright P/N 52739-83. (Separate purchase of screws P/N 2711 required for installation.)

## Select a Finish

### Sissy Bar Uprights for XL Models

Height	Style	Finish	Fits '82-'03 XL models		Fits '04-later XL models with Rigid Sideplates		Fits '04-later XL models with Detachable Sideplates	
			P/N	Price	P/N	Price	P/N	Price
Mini		Chrome	52744-94	\$64.95	51512-02	\$64.95	52738-94A	\$64.95
Short		Chrome	52728-95	\$69.95	51513-02	\$69.95	52737-94A	\$69.95
Short		Gloss Black	—	—	—	—	52706-07	\$69.95
Short		Wrinkle Black	—	—	—	—	53010-98	\$69.95
Medium Low	Medallion	Chrome	—	—	—	—	52754-04	\$89.95
Medium Low	Medallion	Gloss Black	—	—	—	—	51851-09	\$94.95
Low	Insert	Chrome	—	—	51515-02	\$89.95	52736-85A	\$89.95
Low	Medallion	Chrome	52655-84	\$89.95	52909-02	\$89.95	52735-85	\$89.95
Low	Medallion	Wrinkle Black	—	—	51517-02	\$89.95	53007-98	\$89.95
Low	Bar & Shield	Chrome	52739-83	\$89.95	51514-02	\$89.95	—	—
Tall	Insert	Chrome	—	—	—	—	53552-81A	\$94.95
Tall	Medallion	Chrome	52777-85A	\$94.95	51519-02	\$94.95	52749-85A	\$94.95

Notice: The prices appearing in this catalog are the manufacturer's suggested retail prices. Actual retail prices may vary.

# 76 SPORTSTER®

## Backrests & Racks

### A. MINI RAIL BACKREST PAD

Innovative mounting system features a brushed stainless steel insert framed with chrome plate and hardware.

**52513-94** **\$49.95**

Fits XL, FXR, Dyna®, and Softail® models (except FXSTD) equipped with Badlander® Seats, select low-profile seats and Mini Rail Sissy Bar Upright.



A. MINI RAIL BACKREST PAD



B. SHORT RAIL BACKREST PAD

### B. SHORT RAIL BACKREST PAD

Innovative Backrest Pad Mounting System features a brushed stainless steel insert framed with chrome plate and hardware.

**52517-94** Fits Short Rail Sissy Bar Upright. **\$49.95**

### C. MEDIUM LOW BACKREST PADS

Styled to complement Original Equipment and accessory seats, these pads are sized to match the Medium Low Sissy Bar Upright. Backrest pads include chrome-plated mounting hardware.

Fits Medium Low Medallion Plate-Style Sissy Bar Upright.

**1. 52652-04** Smooth. **\$59.95**

**2. 52626-04** Smooth Top-Stitched. **\$59.95**

**3. 52656-04** Pillow-Look. **\$59.95**

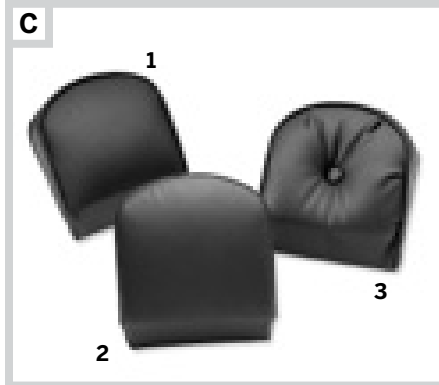

C. MEDIUM LOW BACKREST PADS



D. LOW BACKREST PADS

### D. LOW BACKREST PADS

Includes all necessary mounting hardware.

Fits Low Medallion Plate-Style Sissy Bar Upright.

**1. 52412-79A** Embossed Bar & Shield logo. **\$59.95**

**2. 52545-84** Pillow-Look. **\$59.95**

**3. 52612-95** Smooth Top-Stitched. **\$59.95**

### E. LOW BACKREST PAD – SMOOTH BUCKET

Features large bucket shape, with a generous radius and ample padding. This backrest pad offers extra comfort for your passenger.

**51132-98** **\$89.95**

Fits Low Medallion Plate-Style Sissy Bar Upright.

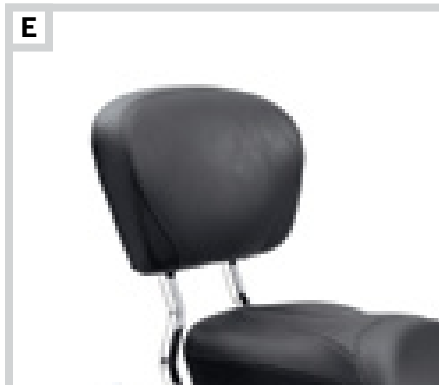

E. LOW BACKREST PAD – SMOOTH BUCKET

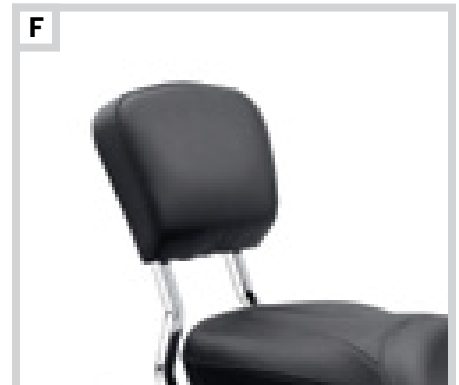

F. LOW BACKREST PAD – TOURING

### F. LOW BACKREST PAD – TOURING

With a larger backrest pad for comfortable two-up cruising, this pad is designed to complement Sportster® and Dyna® Seats.

**51667-98** **\$59.95**

Fits Low Medallion Plate-Style Sissy Bar Upright.

### G. TALL BACKREST PADS

Quality backrest pads include chrome-plated mounting brackets and hardware.

Fits Tall Insert-Style or Medallion Plate-Style Sissy Bar Upright.

**1. 52965-98** Smooth Top-Stitched. **\$69.95**

**2. 91770-85** Pillow-Look. **\$69.95**



G. TALL BACKREST PADS



H. SISSY BAR UPRIGHT SLIP-OVER BACKREST PADS

### H. SISSY BAR UPRIGHT SLIP-OVER BACKREST PADS

Slip on for passenger comfort. Easily removed to show off chrome Sissy Bar Upright.

**1. 52563-82** Fits Tall Sissy Bar Upright. **\$59.95**

**2. 91819-85** Fits Low Sissy Bar Upright. **\$59.95**



**I. CHROME BACKREST MOUNT – MINI RAIL UPRIGHT**



**J. REAR DOCKING HARDWARE COVER KIT – CHROME SHOWN**



**K. DETACHABLES LOCK**



**L. TANK BRA FOR SPORTSTER FUEL TANKS**



**M. RAIN COVER – TWO-UP SEAT**



**M. RAIN COVER – SOLO SEAT**

NEW

J

### I. CHROME BACKREST MOUNT

Chrome-plated Backrest Mount with hidden fasteners. Allows the mounting of sissy bar medallions or can be used as is for a clean look.

**52527-01** Mini Rail Upright. **\$25.95**

Fits XL, Dyna, and Softail models equipped with Harley-Davidson Mini Sissy Bar Upright and matching Backrest Pad.

**52531-01** Short Rail Upright. **\$25.95**

Fits XL, Dyna, and Softail models equipped with Harley-Davidson Short Sissy Bar Upright and matching Backrest Pad.

### J. REAR DOCKING HARDWARE COVER KIT

Disguise the rear docking hardware with these easy-to-install covers. The caps slide over the exposed docking points, and are held in place by a strong magnetic pull. The caps are easy to remove when you wish to reinstall detachable accessories. Covers are available with brilliant chrome or durable gloss black finish to match your bike's attitude (*sold in pairs*).

Fits many accessory docking hardware kits. Refer to the fitment matrix in the P&A Catalog page 543 or the Parts & Accessories section of [www.harley-davidson.com](http://www.harley-davidson.com) for details.

**48218-10** Short Chrome (*pair*). **\$24.95**

**48220-10** Large Chrome (*pair*). **\$24.95**

**48035-09** Small Chrome (*pair*). **\$24.95**

**48221-10** Short Black (*pair*). **\$24.95**

**48223-10** Large Black (*pair*). **\$24.95**

**48225-10** Small Black (*pair*). **\$24.95**

### K. DETACHABLES LOCK\*

Now you can have the convenience of Detachables with the security of barrel locks. This unique lock replaces the cam-lock on your Harley-Davidson® Detachable accessories, providing additional security and peace-of-mind when parking your vehicle. Kit includes two extended-reach barrel-style keys for easy access to the lock. Designed exclusively by Harley-Davidson. Key registration\* and replacement service is available.

Fits models equipped with Detachable Sideplates, Racks and Tour-Pak® Luggage Carriers (except '09-later Touring models equipped with Detachable Solo Tour-Pak Rack).

**46063-98** Single. **\$46.95**

**46106-00** ~~Set of Two.~~ ~~OBSOLETE~~ **\$89.95**

\*Key Registration and Replacement Service. This service is provided by the lock manufacturer. Information is included in the product packaging.

### L. TANK BRA FOR SPORTSTER® FUEL TANKS

This tank bra is made with non-abrasive, fleece-backed vinyl material and features an embroidered Bar & Shield logo. It protects your fuel tank from scratches from keys, belt buckle, etc. Designed for easy installation and a custom fit without disassembly of the tank or seat.

**62027-04** **\$39.95**

Fits '04-later XL883C, XL1200L, XL1200C and '08-later XL1200R models.

**62030-04** **\$34.95**

Fits '04-later XL 50th Anniversary, XL883, XL883L, XL883N, XL883R, XL1200N and '04-'07 XL1200R models.

**61929-98** Fits '97-'03 3.3 gallon XL fuel tanks. **\$34.95**

### M. RAIN COVERS\*\*

Featuring a handy storage sack, this black nylon, water-resistant, Cordura® cover packs easily and shelters your seat from the storm.

**51637-97** Two-Up Seat. **\$29.95**

Fits H-D® two-up seats (except XR, FLSTS and Softail® Seats with Rider Backrests).

**51638-97** Solo Seat. **\$29.95**

Fits H-D solo seats (except XR and FLSTS models).



**\*\*WARNING:** Do not use while riding; could result in death or serious injury.

Notice: The prices appearing in this catalog are the manufacturer's suggested retail prices. Actual retail prices may vary.

# 78 SPORTSTER®

Backrests & Racks

## A. ONE-PIECE DETACHABLE PASSENGER Sissy BAR UPRIGHT – GLOSS BLACK

The sweeping shape and gloss black finish of this slim solid bar Passenger Upright complement the classic “bobber” look of the Nightster® and Iron 883™ models. The one-piece design eliminates separate sideplates for a clean appearance, and the perforated “buckshot” base and stylized upper kick angle mimics the old-school sissy bars of the 50s and 60s. Can be used with Passenger Bracket Pad P/N 52631-07.

**51146-10** **\$199.95**  
Fits '04-later XL models. Installation requires separate purchase of appropriate Docking Hardware Kit.

**Shown with:**

### PASSENGER BACKREST PAD

Styled to complement available touring and custom seats. This pad fits the Original Equipment FXSTC sissy bar upright.

**52631-07** **\$59.95**  
Fits models equipped with Sissy Bar Upright P/N 52729-08, 51853-07 or 51849-07.

## B. CHOPPED FENDER LUGGAGE RACK\*

This Luggage Rack is the ideal option for your ride across town or across the state. Designed for the chopped rear fender featured on Nightster and Iron 883 models, this simple rack adds practical luggage space without compromising style. Rear supports attach to the fender struts, and the rack is secured to the passenger pillion mounting point on the rear fender. Rack is compatible with Detachable accessories and Docking Hardware, and is styled to complement the One-Piece Detachable Upright P/N 51146-10.

**54250-10** Gloss Black. **\$129.95**  
Fits '09-later XL883N and '07-later XL1200N models.

## C. TAPERED LUGGAGE RACKS\*

Styled to enhance the lines of the motorcycle, this sleek, compact Tapered Rack is an elegant solution for carrying your lunch to work or your luggage across the country.

Fits '04-later XL models equipped with Detachable Sideplates, '06-later Dyna® models (except FXDF, FXDFSE/2 and '10 FXDWG) equipped with Rigid or Detachable Sideplates, and '00-'05 Softail® models (except FXSTD and FLSTN) and '06-later FLST, FLSTC and FLSTSC models equipped with Detachable or Rigid Mount Sideplates.

**53718-04** Chrome. **\$119.95**  
**53510-07** Gloss Black. **\$119.95**

Fits '04-later XL models equipped with Rigid Sideplates P/N 53925-04 and '02-'05 Dyna models equipped with Rigid Sideplates or Detachable Sideplates.

**53742-04** Chrome. **\$119.95**

## D. SPORT LUGGAGE RACKS – FOUR BAR\*

This sleek rack complements the lines of your motorcycle. Can be used with Detachable or Rigid Mount Sissy Bar Sideplates.

Fits '04-later XL models equipped with Rigid Sideplates P/N 53925-04 and '02-'05 Dyna models equipped with Rigid Sideplates or Detachable Sideplates.

**53899-02** Chrome. **\$119.95**  
**53900-02** Wrinkle Black. **\$119.95**

Fits '90-'03 XL models with Detachable Sideplate Kit P/N 53545-95, '82-'03 XL models with Rigid Mount Sideplate Kit P/N 52806-94B or 52782-82B; '82-'94 FXR models with Rigid Sideplate Kit P/N 52781-82B (except FXRS-CONV. and FXRT). Fits '96-'01 Dyna models (except FXDWG). All '96-'01 Dyna models equipped with Rigid Mount Sideplates require the separate purchase of Luggage Rack Adapter Kit P/N 53828-00. Also fits '99-'00 FXR models.

**53711-96A** Chrome. **\$119.95**



**A. ONE-PIECE DETACHABLE PASSENGER Sissy BAR UPRIGHT – GLOSS BLACK**

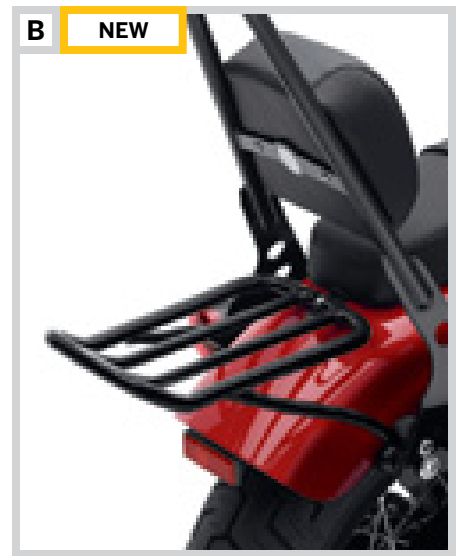

**B. CHOPPED FENDER LUGGAGE RACK**



**C. TAPERED LUGGAGE RACK – CHROME**

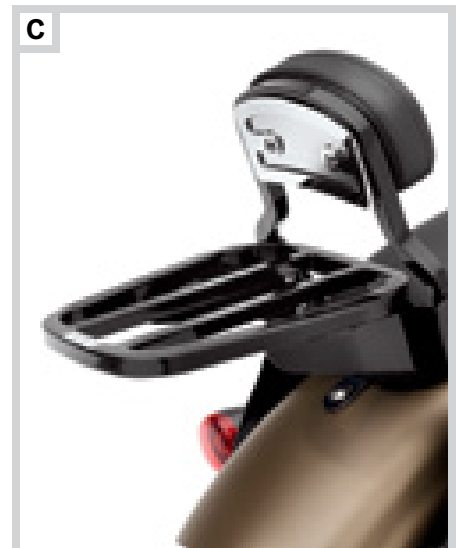

**C. TAPERED LUGGAGE RACK – GLOSS BLACK**



**D. SPORT LUGGAGE RACK – FOUR BAR, CHROME**



**D. SPORT LUGGAGE RACK – FOUR BAR, WRINKLE BLACK**



**\*WARNING:** Do not use this rack as a seat. Do not exceed the fender rack weight capacity. Using as seat or exceeding this capacity could cause handling problems which could result in loss of control and death or serious injury.

Notice: The prices appearing in this catalog are the manufacturer's suggested retail prices. Actual retail prices may vary.





E. SPORT LUGGAGE RACK – FIVE BAR, CHROME



E. SPORT LUGGAGE RACK – FIVE BAR, WRINKLE BLACK



F. TWO-UP SPORT LUGGAGE RACK – CHROME



F. TWO-UP SPORT LUGGAGE RACK – WRINKLE BLACK



G. SPORTSTER DETACHABLE SOLO RACK – CHROME ('04-LATER MODELS)



G. SPORTSTER DETACHABLE SOLO RACK – GLOSS BLACK ('04-LATER MODELS)

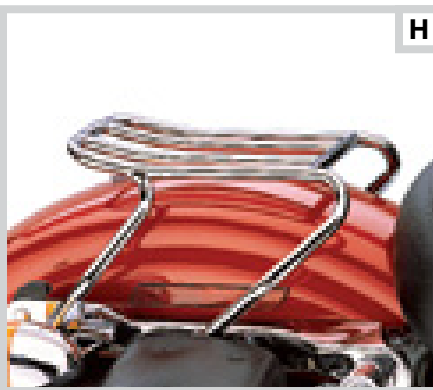

H. SPORTSTER DETACHABLE SOLO RACK ('94-'03 MODELS)



I. CHROME BOBTAIL FENDER RACK

**E. SPORT LUGGAGE RACKS – FIVE BAR\***

This rack brings touring flexibility to your motorcycle. Can be used with Detachable or Rigid Mount Sissy Bar Sideplates.

Fits '04-later XL models equipped with Detachable Sideplates, '06-later Dyna models (except FXDF, FXDFSE/2 and '10 FXDWG) equipped with Rigid or Detachable Sideplates, and '00-'05 Softail® models (except FXSTD and FLSTN) and '06-later FLST, FLSTC, and FLSTS models equipped with Detachable or Rigid Mount Sideplates.

<b>53862-00</b>	Chrome.	<b>\$134.95</b>
<b>53939-03</b>	Wrinkle Black.	<b>\$134.95</b>

**F. TWO-UP SPORT LUGGAGE RACKS\***

A sleek rack that complements the lines of your motorcycle. Works with both Detachable and Rigid Mount Sideplates.

Fits '04-later XL models equipped with Detachable Sideplates, '00-'05 Softail® models (except FXSTD and FLSTN), and '06-'07 FL Softail (except FLSTN, FLSTFSE2 and '07 FLSTF) equipped with Detachable or Rigid-mount Sideplates. Also fits '08-later FLSTC models with Original Equipment rigid sideplates.

<b>53713-96A</b>	Chrome.	<b>\$149.95</b>
<b>53850-00A</b>	Wrinkle Black.	<b>\$149.95</b>

Fits '90-'03 XL models with Detachable Sideplate Kit P/N 53545-95. '82-'03 XL models with Rigid Mount Sideplate Kit P/N 52806-94B or 52782-82B; '82-'94 FXR models with Rigid Sideplate Kit P/N 52781-82B (except FXRS-CONV. and FXRT). Fits '96-'01 Dyna® models (except FXDWG). All '96-'01 Dyna models equipped with Rigid Mount Sideplates require the separate purchase of Luggage Rack Adapter Kit P/N 53828-00. Also fits '99-'00 FXR models.

<b>53866-00</b>	Chrome.	<b>\$149.95</b>
-----------------	---------	-----------------

**G. SPORTSTER® DETACHABLE SOLO RACKS\***

Add touring capabilities to your solo seat Sportster® model in less than 60 seconds. This Detachable Solo Rack fits over the fender when the passenger pillion is removed. The rack features brazen hand-polished tubing, and the chrome-plated or gloss black finish adds a stylish flair. Requires Docking Hardware.

Fits '04-later XL models equipped with solo seat. Requires separate purchase of appropriate Detachable Docking Hardware.

<b>53494-04</b>	Chrome.	<b>\$179.95</b>
<b>53512-07</b>	Gloss Black.	<b>\$179.95</b>

**H. SPORTSTER DETACHABLE SOLO RACK\***

Detachable Solo Rack fits over the fender when the passenger pillion is off. The rack features brazen construction, hand-polished tubing, and chrome-plated finish. Requires Docking Hardware.

<b>53495-95</b>		<b>\$179.95</b>
-----------------	--	-----------------

Fits '94-'03 XL models equipped with solo seats. Requires separate purchase of appropriate Detachable Docking Hardware.

**I. CHROME BOBTAIL FENDER RACK\***

Functional and stylish, this chrome-plated rack is a great way to emphasize the legendary lines of the Bobtail Fender. Designed for easy installation on models with or without Sissy Bar Uprights, the rack features an embossed "Harley-Davidson" nameplate as a finishing touch.

<b>53948-04</b>		<b>\$99.95</b>
-----------------	--	----------------

Fits '04-later XL models (except XL883N and XL1200N) equipped with Color-Matched Bobtail Rear Fender Kit and Bobtail Rear Fender Installation Kit P/N 69714-04A.



**\*WARNING:** Do not use this rack as a seat. Do not exceed the fender rack weight capacity. Using as seat or exceeding this capacity could cause handling problems which could result in loss of control and death or serious injury.

Notice: The prices appearing in this catalog are the manufacturer's suggested retail prices. Actual retail prices may vary.

# 80 SPORTSTER®

## Saddlebags & Luggage

### A. RIGID LEATHER LOCKING SADDLEBAGS

These saddlebags combine a premium leather finish with extra-durable construction. The hard-shell design is covered in leather for a traditional look, while the locking hinged lids offer modern convenience and security. Styled to complement the sleek, narrow Sportster® profile, these bags offer plenty of storage for a trip across town or across the country. Kit includes reflectors.

**53050-04C** **\$699.95**

Fits '04-later XL models (except XL883N and XL1200N). Requires separate purchase of Turn Signal Relocation Kit P/N 68732-02A (Domestic), 68733-02A (International) or Layback License Plate Kit P/N 60215-06. Fits with Detachable Sideplates when used with Hardware Kit P/N 53544-04. Does not fit with Rear Axle Covers or Bobtail Fender.

### B. SPORTSTER® LEATHER SADDLEBAGS

These saddlebags are constructed from 9-oz. leather with thermoformed backs for added shape retention. Bags feature an embossed "Sportster" script logo for style, and quick-disconnect clips under traditional chrome buckles for easy access.

**90342-04A** **\$599.95**

Fits '94-later XL models. (Does not fit XL883N, XL1200N, XL1200S, '02-'03 XL883R, and models equipped with Rear Axle Covers, Flat Lens Turn Signals or accessory Bullet Style Turn Signals P/N 68005-99 and 68637-99.) '04-later models require separate purchase of Directional Relocation Kit P/N 68474-04. '94-'03 models require separate purchase of Directional Relocation Kit P/N 68485-04. (Will work with Detachable Sideplates on '94-'03 models when used with Hardware Kit P/N 90465-98A or 53532-02.) (Will not fit with Detachable Sideplates or Bobtail Fender on '04-later XL models.)

### C. SYNTHETIC LEATHER SADDLEBAGS

Combine street attitude with long-haul versatility and you get these custom bags. Styled with sweeping lines to complement the Sportster fender, these bags feature plenty of storage space for a ride to the store, or to Sturgis. The rigid plastic tub, wrapped in rich synthetic leather, offers long-term durability. The traditional straps hide quick-disconnect closures for packing convenience, and the chrome buckles provide a look that's pure Harley-Davidson. Luggage capacity: 2000 cubic inches total.

**90330-08** **\$399.95**

Fits '04-later XL models (except XL883N, XL1200N, '02-'03 XL883R and models equipped with Rear Axle Nut covers or Flat Lens Turn Signals, and models equipped with 2-into-1 exhaust). '04-later models require separate purchase of Turn Signal Relocation kit P/N 68732-02A (Domestic), 68733-02A (International) or Layback License Plate kit P/N 60215-06.

#### Directional Relocation Hardware Kit

Required when installing Saddlebag P/N 90342-04A on '04-later XL models.

**68474-04B** Chrome. **\$54.95**

Fits '04-later XL models.

#### Directional Relocation Hardware Kit (not shown)

Required when installing Saddlebag P/N 79073-04, 79052-04, 90342-04A or 90598-04 on '94-'03 XL models.

**68485-04** **\$89.95**

Fits '94-'03 XL models (except XL1200S and 883R).

#### Detachable Docking Hardware Kit (not shown)

Required when installing detachable sideplates with Saddlebag P/N 53050-04A.

**53544-04** **\$34.95**

Fits '04-later XL models (except XL883N and XL1200N). Required when installing detachable accessories with Saddlebag P/N 53050-04A.



A. RIGID LEATHER LOCKING SADDLEBAGS



B. SPORTSTER LEATHER SADDLEBAGS



C. SYNTHETIC LEATHER SADDLEBAGS

Notice: The prices appearing in this catalog are the manufacturer's suggested retail prices. Actual retail prices may vary.



D. "EXPRESS RIDER" LARGE CAPACITY LEATHER SPORTSTER SADDLEBAGS



E. LEATHER THROW-OVER SADDLEBAGS



F. SLANT-STYLE LATIGO LEATHER SADDLEBAGS



G. SYNTHETIC LEATHER THROW-OVER ADJUSTABLE SADDLEBAGS

**D. "EXPRESS RIDER" LARGE CAPACITY LEATHER SPORTSTER® SADDLEBAGS**

Traditional "pony express" throw-over bag styling is enhanced with a modern rigid mounting structure on this handsome set of leather saddlebags. Our largest capacity Sportster® saddlebag offers the convenience of quick-release clips under conventional buckles for easy access. The riveted leather patch with embossed Bar & Shield logo completes the ageless look. Luggage capacity: 2400 cubic inches total.

**88312-07** **\$499.95**

Fits '04-later XL models (except XL883N and XL1200N). Requires separate purchase of Turn Signal Relocation Kit P/N 68732-02A (Domestic), 68733-02A (International) or Layback License Plate Kit P/N 60215-06. Fits with Detachable Sideplates when used with Docking Hardware Kit P/N 53544-04. Installation on all models equipped with Sundowner or Reach Seats and no Sideplates or Rigid Sideplates requires separate purchase of Docking Hardware Kit P/N 53544-04. Does not fit with Rear Axle covers. Does not fit with Bobtail Fender.

**E. LEATHER THROW-OVER SADDLEBAGS**

The ideal complement to the '07-later Nightster model, these traditional Leather Throw-Over bags feature large side gussets for increased capacity and full-length straps with hidden quick-disconnect clips for easy access.

**91008-82C** **\$299.95**

Fits '82-later XL, '08-later Dyna and '84-'99 Softail models equipped with H-D Chrome Saddlebag Supports.

**F. SLANT-STYLE LATIGO LEATHER SADDLEBAGS**

Convenience and style share the road with these durable saddlebags. Constructed from high-quality leather and a sturdy steel frame, they feature a quick-disconnect system with hidden carry straps that make road trips easy. The contoured styling implies constant motion and the embossed Bar & Shield logo and engraved, nickel-plated buckles provide a look that is pure Harley-Davidson.

**91010-91A** **\$499.95**

Fits '04-later XL models (except XL883N, XL1200N, XL1200S and XL883R) and '91-'05 Dyna® models. All models require separate purchase of model specific Fender Yoke, Saddlebag Supports, and Directional Relocation Kit. Does not fit with Flat Lens Turn Signals, Rear Axle Cover(s) or with Bobtail Fenders. Does not fit with Detachable Sideplates on '04-later XL models.

**Also available:**

**LEATHER FENDER YOKES FOR SLANT-STYLE SADDLEBAGS** (not shown)

Required for a proper fitment of Slant-Style Saddlebags on Harley-Davidson® motorcycles.

**91125-04A** **\$69.95**

Fits '04-later XL models (except XL883N and XL1200N) equipped with Saddlebag Support P/N 90799-94C.

**G. SYNTHETIC LEATHER THROW-OVER ADJUSTABLE SADDLEBAGS**

Synthetic leather with embossed "Eagle Wing" logo. 11" x 10" x 3-3/4".

**90570-86TA** **\$99.95**

Fits '82-'03 XL, '91-'05 Dyna® and '84-'99 Softail® models equipped with Saddlebag Supports.



# 82 SPORTSTER®

Saddlebags & Luggage

## A. COLOR-MATCHED HARD SADDLEBAGS FOR SPORTSTER® MODELS\*

Sporty is the best way to describe any Sportster® decked out with these lockable bags. Using injection-molded construction, these hard bags are painted to match stock colors for seamless style. Kit includes Turn Signal Relocation Hardware. Luggage capacity: 2500 cubic inches total.

Fits '94-later XL models (except XL883N, XL1200S, XL1200N, and '02-'03 883R). Installation on vehicles equipped with Detachable Sissy Bar or Luggage Rack requires the separate purchase of Mounting Hardware Kit. '94-'03 models require Hardware Kit P/N 91385-00 and '04-later models require Hardware Kit P/N 91405-04.

**See below** Primed. **\$1,149.95**  
**See below** Color-Matched. **\$1,399.95**

## B. COLOR-MATCHED SPORT TOUR-PAK® LUGGAGE\*

Designed to complement the styling of the Softail® and Sportster® Hard Saddlebags, the Color-Matched Sport Tour-Pak® luggage adds increased storage for your ride across town or across the country. The injection molded Tour-Pak Luggage is lockable, and includes an interior rubber mat. Large enough to store most full-faced helmets. Backrest Pad P/N 52872-01 sold separately. Luggage capacity: 2245 cubic inches total.

Fits '04-later XL models equipped with Solo Tour-Pak mounting Rack. Racks and docking kits sold separately.

**See below** Color-Matched. **\$674.95**

Color	Saddlebags	Sport Tour-Pak
Primed.	91412-04BDK	-
Big Purple Flake.	91412-09CWR	53929-09CWR
Birch White.	91412-04AV	53929-06AV
Black Cherry.	91412-05BPS	53929-06BPS
Black Ice.	91412-09CWL	53929-09CWL
Black Ice Denim. <b>OBSELETE</b>	-	<b>53929-10DBP</b>
Black Pearl.	91412-05BPY	53929-06BPY
Brilliant Silver.	91412-04BHT	53929-10BHT
Brilliant Silver Denim.	-	53929-08COV
Candy Red Sunglo.	91412-08CPF	53929-08CPF
Chopper Blue.	91412-05BPO	53929-06BPO
Copper Pearl.	91412-08CPH	53929-08CPH
Copperhead Pearl.	91412-08CPL	53929-08CPL
Crimson Red Sunglo.	91412-08COZ	53929-08COZ
Dark Blue Pearl.	91412-08CPC	53929-08CPC
Deep Cobalt.	91412-06BXT	53929-06BXT
Deep Turquoise.	-	53929-09CWN
Fire Red Pearl.	91412-06BXY	-
Flame Blue Pearl.	91412-09CWA	53929-09CWA
Glacier White Pearl.	91412-04BHX	53929-06BHX
Golden Glow.	91412-08CPJ	53929-08CPJ
Lava Red Sunglo.	91412-04BJK	-
Light Candy Root Beer.	91412-09CWT	53929-09CWT
Luxury Blue.	91412-04XE	-
Mirage Orange.	91412-06BNR	53929-06BNR
Olive Pearl.	91412-08CGV	-
Olive Pearl Denim.	-	53929-08COS
Pacific Blue Pearl.	91412-07CGP	-
Pewter Pearl.	91412-07CGR	-
Purple Haze.	91412-08CPK	53929-08CPK
Red Hot Sunglo.	91412-09CYS	53929-09CYS
Scarlet Red.	91412-10DBJ	53929-10DBJ
Sierra Red.	91412-04BHS	53929-06BHS
Suede Blue Pearl.	91412-08CGT	53929-08CGT
Sunset Yellow Pearl.	91412-08CPE	<b>53929-08CPE</b> <b>OBSELETE</b>
Vivid Black.	91412-04DH	53929-06DH
White Gold Pearl.	91412-07CGS	53929-07CGS
White Pearl.	91412-04ZB	-
Yellow Pearl.	91412-05BPZ	53929-06BPZ



A. COLOR-MATCHED HARD SADDLEBAGS FOR SPORTSTER MODELS

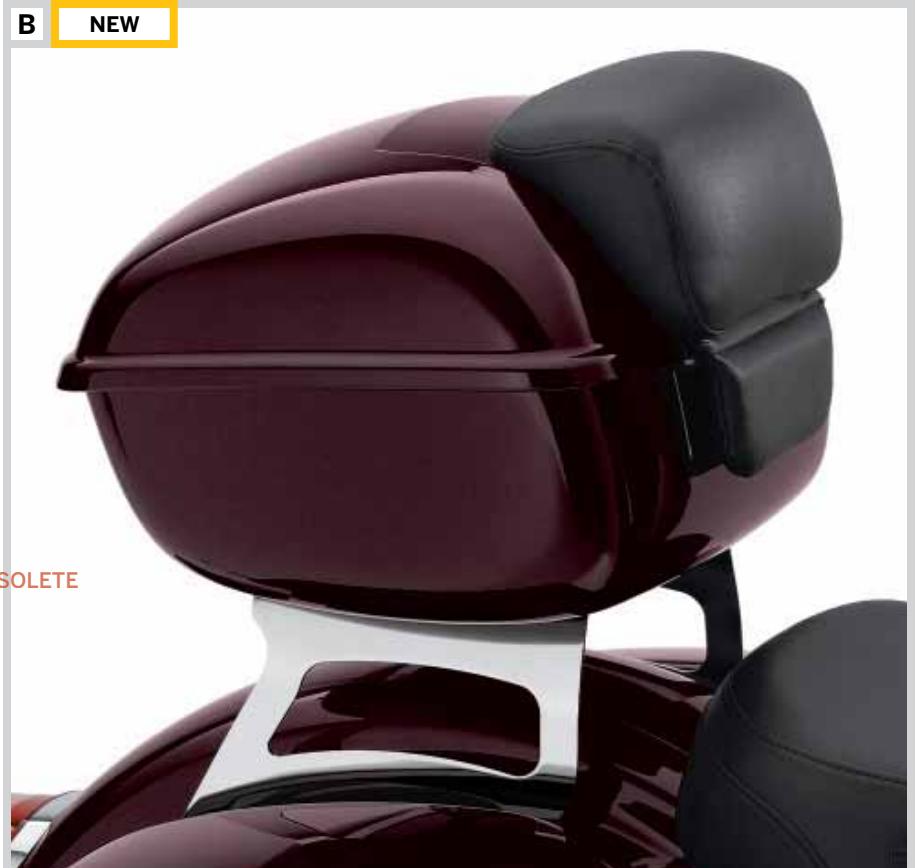

B. COLOR-MATCHED SPORT TOUR-PAK LUGGAGE (SHOWN WITH DETACHABLE SOLO TOUR-PAK RACK AND BACKREST PAD)

\*NOTE: This product is a "Paint to Order" accessory. Please allow for an average of 5 weeks delivery for this item.

Notice: The prices appearing in this catalog are the manufacturer's suggested retail prices. Actual retail prices may vary.



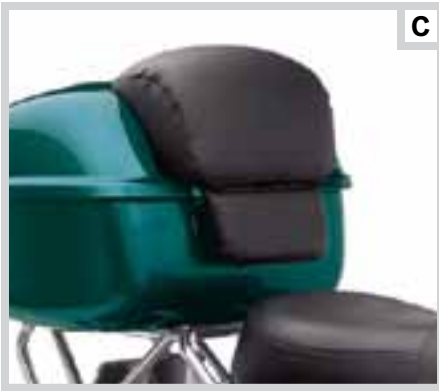

**C. BACKREST PAD FOR SPORT TOUR-PAK LUGGAGE**



**D. DETACHABLE SOLO TOUR-PAK MOUNTING RACK**



**E. SMOOTH TOUR-PAK LUGGAGE (SHOWN WITH SPORTSTER SOLO TOUR-PAK MOUNTING RACK)**



**F. LINER BAG FOR LEATHER TOUR-PAK LUGGAGE**



**G. SADDLEBAG LINERS FOR LEATHER SADDLEBAGS (91957-97 SHOWN)**



**G. SADDLEBAG LINERS FOR SLANT-STYLE LEATHER SADDLEBAGS (91959-97 SHOWN)**



**G. SADDLEBAG LINERS FOR SPORTSTER AND DYNA HARD SADDLEBAGS**



**H. CHROME SADDLEBAG SUPPORTS**

**C. BACKREST PAD FOR SPORT TOUR-PAK LUGGAGE**

This Sport Tour-Pak Backrest Pad is styled to complement a wide variety of Original Equipment or custom seats, and provides comfortable support for you or your passenger.

**52872-01** **\$89.95**

Fits models equipped with Color-Matched Sport Tour-Pak Luggage.

**D. DETACHABLE SOLO TOUR-PAK® MOUNTING RACK\***

The Solo Tour-Pak Rack places the Sport Tour-Pak in a comfortable back supporting position. The rack is designed to position the Tour-Pak for solo riding. Simply remove the Tour-Pak Rack from the convenient detachable hardware, add a passenger pillion, and the bike is ready for two-up riding. Tour-Pak, Passenger Backrest Pad and Docking Hardware sold separately.

**53655-04** **\$139.95**

Fits '04-later XL models equipped with solo seat. Designed to accept Color-Matched Sport Tour-Pak P/N 53929-Yyxxx, Leather Tour-Pak P/N 53151-00A, 53147-98B, 53018-04A or 53690-06. Requires separate purchase of appropriate Detachable Docking Hardware.

**E. SMOOTH TOUR-PAK® LUGGAGE**

Add cross-country luggage capacity to your ride with accessory Tour-Pak Luggage. A cavernous interior will hold one full face helmet or two half helmets. Kit includes backrest pad, interior rubber mat, hardware and instructions. Luggage Capacity: 2500 cubic inches. Dimensions: 18.5" W x 17" D x 13" H. Racks and docking kits sold separately. International models may require separate purchase of License Plate Relocation Kit P/N 60095-00A.

**53690-06A** **\$499.95**

Fits '00-later Softail models (except Deuce, Rocker and FXSTSSE3) equipped with Detachable Solo or Two-Up Tour-Pak Rack. Fits '97-later Touring models (except Trike) equipped with Detachable Two-Up or Solo Tour-Pak Racks. Fits '04-later XL models equipped with Solo Tour-Pak Rack. '10 FLSTSE models require separate purchase of Mounting Hardware Kit P/N 54245-10.

**F. LINER BAG FOR LEATHER TOUR-PAK LUGGAGE**

This liner features a dual-direction zipper, map pocket and convenient carrying straps. The liner is constructed of water-resistant nylon and features an embroidered Bar & Shield logo. Designed specifically to fit Leather Tour-Pak Luggage.

**53621-98** **\$39.95**

Fits Harley-Davidson® Leather Tour-Pak Luggage.

**G. SADDLEBAG LINERS**

Water-resistant liners make packing easy. Feature inner pockets for extra storage and an embroidered Bar & Shield logo.

**91957-97** **\$44.95**

Fits Heritage Softail® Classic and Heritage Springer® style saddlebags. Also fits saddlebags P/Ns 88312-07, 88237-07, 88238-07, 90119-00B, 90130-00C, 90300-98, 90342-98A, 90598-96B, 90835-90C, 90876-05, 91537-00C.

**91959-97** **\$44.95**

Fits Saddlebags P/N 79078-02, 79300-04B, 79300-06B, 88224-06, 90181-08, ~~90300-98A~~, 90307-06, 90330-08, 90369-06, 90460-06B, 90564-06A, 90680-97 and 91010-91A.

**91486-01** **\$44.95**

Fits XL models and Dyna models equipped with Color-Matched Hard Saddlebags.

**H. CHROME SADDLEBAG SUPPORTS**

Fit with or without Sissy Bar Uprights, attach easily, and protect bags from contacting brake and swingarm.

**90799-94D** **\$99.95**

Fits '94-later XL models (except XL1200S and '02-'03 XL883R). Does not fit with Detachables. (Includes Chrome Upper Shock Covers P/N 54711-94.)

**90799-86C** **\$109.95**

Fits '82-'93 XL models. Does not fit with Detachables.



**\*WARNING:** Do not use this rack as a seat. Do not exceed the fender rack weight capacity. Using as seat or exceeding this capacity could cause handling problems which could result in loss of control and death or serious injury.

# 84 SPORTSTER®

Bodywork

## A. SPORT FRONT FENDERS\*

The custom double arch Sport Front Fenders are manufactured from injection molded high-impact composite materials and are contoured to match the stock rear fender. The fenders are available in Vivid Black or a primed surface ready for your custom paint design. Each fender is supplied with internal mounting plates and mounting hardware making installation quick and easy.

Fits '88-later XL and '91-'05 Dyna® models equipped with 39mm front forks. Will not fit FXDWG models.

**59496-97** Primed. **\$124.95**

**59496-97DH** Vivid Black. **\$229.95**

## B. CHOPPED REAR FENDER FOR SPORTSTER MODELS

Complete "bolt-on" fender kit includes everything you need to convert your '04-later Sportster model to the chopped rear fender look. Available in Vivid Black or primed finish, this kit can be installed with simple tools and requires no frame modifications or fabrication. The chopped fender eliminates the traditional tail lamp, and replaces the Original Equipment rear turn signals with "stop-turn-tail" lights for a clean, stripped-down appearance. All you need to add is a Side Mount or under-fender mount license plate bracket (*sold separately*).

Fits '07-'09 XL models (Stock on XL1200N and XL883N). Requires separate purchase of Side Mount License Plate Assembly P/N 60318-07. NOTE: Laws regarding the location of the license plate vary from place to place. Please check with local authorities and obey all applicable laws and regulations.

**60236-09BEO** Primed. **\$419.95**

**60236-09DH** Vivid Black. **\$499.95**

Fits '04-'06 and '10 XL models (Stock on XL1200N and XL883N). Requires separate purchase of Side Mount License Plate Assembly P/N 60318-07. NOTE: Laws regarding the location of the license plate vary from place to place. Please check with local authorities and obey all applicable laws and regulations.

**60236-10BEO** Primed. **\$419.95**

**60236-10DH** Vivid Black. **\$499.95**

## C. BOBTAIL REAR FENDER KIT FOR SPORTSTER® MODELS\*

Get all of the custom attitude without the big bike expense. The radically styled Bobtail fender adds a pure custom back-end to the muscled XL family.

Fits '99-'03 XL models. Requires separate purchase of Installation Kit P/N 69704-00 or 60081-00.

**60025-01** Primed. **\$179.95**

**60025-01DH** Vivid Black. **\$259.95**

Fits '04-'06 XL models. Requires separate purchase of Sportster Bobtail Fender Installation Kit P/N 69714-04A. Will not fit with Leather Saddlebags.

**59985-04** Primed. **\$179.95**

**60052-04DH** Vivid Black. **\$349.95**

Fits '07-later XL models (except XL883N and XL1200N). Requires separate purchase of Sportster Bobtail Fender Installation Kit P/N 69714-04A. Will not fit with Leather Saddlebags.

**59985-07** Primed. **\$179.95**

**60052-07DH** Vivid Black. **\$349.95**



A. SPORT FRONT FENDER

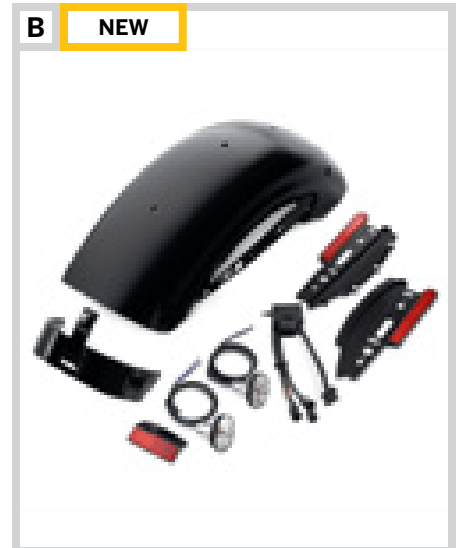

B. CHOPPED REAR FENDER FOR SPORTSTER MODELS



C. BOBTAIL REAR FENDER KIT FOR SPORTSTER MODELS

\*NOTE: This product is a "Paint to Order" accessory. Please allow for an average of 5 weeks delivery for this item.

Notice: The prices appearing in this catalog are the manufacturer's suggested retail prices. Actual retail prices may vary.

D



D. CHROME SPORTSTER ENGINE COMPONENTS ('04-LATER MODELS)

## D. CHROME SPORTSTER® ENGINE COMPONENTS ('04-LATER)

<b>1. Sportster Chrome Gearcase Cover</b>		
<b>25213-04</b>	Fits '04-later XL models.	<b>\$478.00</b>
<b>2. Sportster Chrome Transmission Sprocket Cover</b>		
<b>34932-04</b>	Fits '04-later XL models.	<b>\$129.00</b>
<b>3. Sportster Chrome Inner Rocker Cover</b>		
<b>17537-07</b>	Fits '07-later XL models.	<b>\$115.45</b>
<b>17537-96C</b>	Fits '86-'06 XL models. (each)	<b>\$115.45</b>
<b>4. Sportster Chrome Outer Rocker Cover</b>		
<b>17551-04</b>	Fits '04-later XL models. (each)	<b>\$126.90</b>
<b>5. Sportster Chrome Primary Cover</b>		
<b>25460-06</b>	Fits '06-later XL models.	<b>\$349.00</b>
<b>25460-04</b>	Fits '04-'05 XL models.	<b>\$349.00</b>
<b>6. Sportster Chrome Primary Chain Inspection Cover</b>		
<b>34761-04A</b>	Fits '04-'08 XL models.	<b>\$23.35</b>
<b>7. Sportster Chrome Derby Cover</b>		
<b>34760-04</b>	Fits '04-later XL models.	<b>\$63.95</b>

## E. CHROME SPORTSTER ENGINE COMPONENTS ('86-'03)

<b>1. Chrome Gearcase Cover Replacement</b>		
<b>25213-96B</b>	Fits '91-'03 XLH models.	<b>\$478.00</b>
<b>2. Chrome Transmission Sprocket Cover Replacement</b>		
<b>34932-96</b>	Fits '91-'03 XL models.	<b>\$129.00</b>
<b>3. Sportster Chrome Inner Rocker Cover</b>		
<b>17537-96C</b>	Fits '86-'06 XLH models. (each)	<b>\$115.45</b>
<b>4. Sportster Chrome Rocker Cover Spacer</b>		
<b>17538-96</b>	Fits '91-'03 XLH models. (each)	<b>\$98.80</b>
<b>5. Sportster Chrome Outer Rocker Cover</b>		
<b>17551-96</b>	Fits '86-'03 XLH models. (each)	<b>\$126.90</b>
<b>6. Chrome Primary Chain Cover</b>		
<b>25460-94</b>	Fits '94-'03 XL models.	<b>\$349.00</b>
<b>7. Chrome Primary Chain Inspection Cover</b>		
<b>34761-94</b>	Fits '94-'03 XL models.	<b>\$23.35</b>
<b>8. Chrome Derby Cover</b>		
<b>34760-94</b>	Fits '94-'03 XL models.	<b>\$63.95</b>
<b>9. Chrome Shift Lever</b>		
<b>34606-90T</b>	Fits '91-'03 XL models.	<b>\$32.00</b>

E

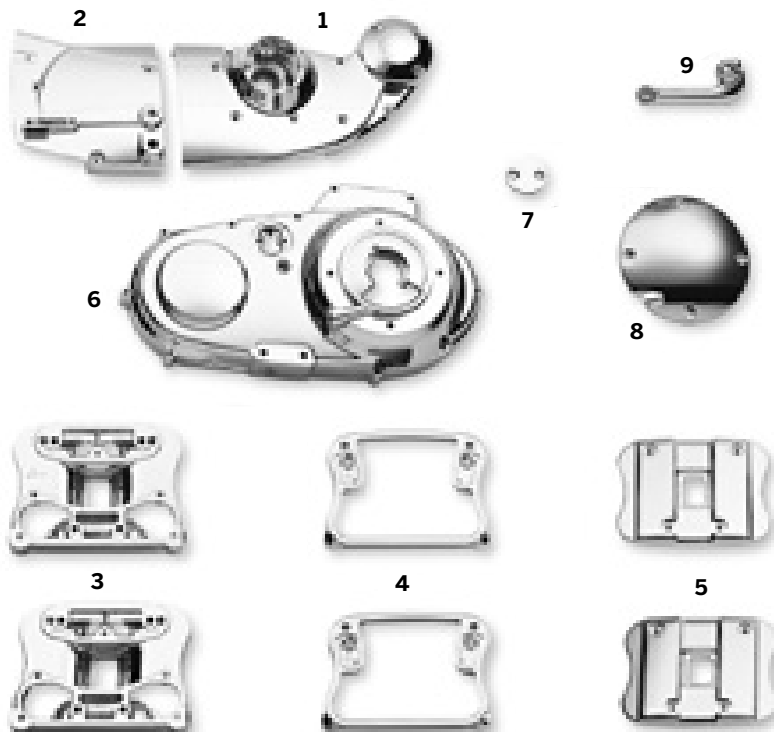

E. CHROME SPORTSTER ENGINE COMPONENTS ('86-'03 MODELS)

Notice: The prices appearing in this catalog are the manufacturer's suggested retail prices. Actual retail prices may vary.

# 86 SPORTSTER®

Engine & Engine Trim

## A. CHROME ENGINE KIT FOR SPORTSTER® MODELS

Upgrade your motor with brilliant chrome components. Kit includes chrome gear cover, transmission sprocket cover, primary chain inspection cover, derby cover, inner and outer rocker covers and all gaskets.

**16295-07A** **\$949.95**

Fits '07-later XL and '08-later XR models. Stock on '07-later XL1200C, XL1200L and XL 50th Anniversary models.

**Also available:**

## SPORTSTER CHROME PRIMARY CHAIN COVER KIT

Kit includes chrome primary chain cover, chrome derby cover, chrome primary chain inspection cover, and gaskets and seals as needed.

**25539-06** **\$329.95**

Fits '06-later XL and '08-later XR models. Stock on '06-later XL1200C, XL1200L and XL 50th Anniversary models.

## B. CHROME PRIMARY COVER TRIM

Dress your engine in chrome. This precision stamped steel cover wraps the Original Equipment aluminum primary cover in brilliant chrome, at a fraction of the cost of chrome replacement components. Kit includes chrome-plated installation hardware.

**25233-04** Fits '04-later XL and XR models. **\$119.95**

## C. CHROME GEARCASE COVER TRIM

Rather than spending the time and money on chrome exchanges, this brilliant chrome cover fits over the Original Equipment aluminum gearcase like a second skin. This steel cover is shaped to mirror the contour for a perfect fit, and when matched with Chrome Sprocket Cover Trim, is a simple way to add instant style. Kit includes chrome-plated mounting hardware.

**1. 25231-04** Fits '04-later XL models. **\$74.95**

~~**25216-98** Fits '96-'03 XL models. **\$74.95**~~

**Shown with:**

## CHROME ENGINE SPROCKET COVER TRIM

This chrome-plated steel skin fits over the Original Equipment aluminum sprocket cover, giving the appearance of a chrome engine at a fraction of the cost. When combined with the available Chrome Gearcase Cover Trim, you get a complete chrome look from front to rear. Kit includes chrome-plated mounting hardware.

**2. 34944-04** Fits '04-later XL models. **\$37.95**

~~**34939-98** Fits '96-'03 XL models. **\$37.95**~~



A. CHROME ENGINE KIT FOR SPORTSTER MODELS



B. CHROME PRIMARY COVER TRIM



C. CHROME GEARCASE COVER TRIM (SHOWN WITH CHROME ENGINE SPROCKET COVER TRIM)

Notice: The prices appearing in this catalog are the manufacturer's suggested retail prices. Actual retail prices may vary.





**D. CYLINDER BASE COVER WITH BAR & SHIELD LOGO**



**E. CYLINDER BASE COVER FOR SPORTSTER MODELS**



**F. TAPPET BLOCK COVER KIT**



**G. STARTER MOTOR COVER FOR SPORTSTER MODELS**



**H. CHROME STARTER SOLENOID COVER KIT**



**I. STARTER SOLENOID COVER**



**J. ENRICHENER/CHOKE KNOB COVER**



**K. CHROME FUEL PETCOCK COVER**

**D. CYLINDER BASE COVER WITH BAR & SHIELD LOGO**

Add a finished chrome look to the left side of the Sportster engine. The mirror-chrome surface complements both silver and black engine finishes, and the deep embossed Bar & Shield logo provides a custom touch. Easy-to-install, the complete kit includes all necessary mounting hardware.

**32729-07** Fits '04-later XL models. **\$49.95**

**E. CYLINDER BASE COVER FOR SPORTSTER MODELS**

Adds chrome highlights to the left side of a Sportster model. Installs in minutes.

**32732-98** Fits '91-'03 XL models. **\$49.95**

**F. TAPPET BLOCK COVER KIT**

This one-piece chrome-plated cover is designed to conceal the lifter blocks and hardware for a clean, custom look. Featuring an embossed Bar & Shield logo, this complete kit covers the lifter block area and extends the chrome look from the gearcase cover to the pushrod tubes. All exposed hardware is chrome-plated, and the kit includes all necessary mounting hardware.

**18241-04** Fits '04-later XL models. **\$59.95**

**G. STARTER MOTOR COVER FOR SPORTSTER® MODELS**

This brilliantly chrome-plated cover conceals the starter motor and starter solenoid. All necessary mounting hardware is provided. All exposed hardware is chrome-plated.

**31314-99** **\$69.95**  
Fits '91-'94 XL1200 models and '95-'03 XL models.

**H. CHROME STARTER SOLENOID COVER KIT**

Add chrome to an often-overlooked area with this cover, featuring the same high-quality, bright finish used on most of our accessories.

**31783-00** **\$21.95**  
Fits '94-later models (except '02-later VRSC™).

**I. STARTER SOLENOID COVER**

With die-cast grooves that add texture, this chrome-plated cover is an easy-to-install element of style. Includes stainless steel hardware.

**31724-98** **\$21.95**

Fits '90-later Evolution® 1340-equipped models, '99-'06 Twin Cam-equipped models (except '06 Dyna®), '95-later XL883 and '91-later XL1200 models. (Does not fit with Oil Vent Hose Cover P/N 37961-02.)

**J. ENRICHENER/CHOKE KNOB COVER**

A subtle chrome touch that can make all the difference, this cover features the Bar & Shield logo and can be installed in minutes.

**29431-97** Fits '86-'06 carbureted models. **\$29.95**

**K. CHROME FUEL PETCOCK COVER**

This cover offers unique styling, with chrome plating and a "Harley-Davidson Motor Co." logo. Cover is notched for position identification.

**62968-02** Fits '02-'06 carbureted models. **\$34.95**

**62863-98** Fits '94-'01 carbureted models. **\$34.95**

# 88 SPORTSTER®

Engine & Engine Trim

## A. THE SPORTSTER® COLLECTION

The Sportster® Collection from Harley-Davidson adds depth and shadows to your custom ride. The layered design is formed from die-cast aluminum, polished, and chrome-plated to a mirror finish. The bold "Sportster" script is filled with black for a distinctive contrast.

- 1. 25343-04A** Derby Cover. **\$43.95**  
Fits '04-later XL and XR models. Includes chrome-plated stainless steel mounting hardware.
- 2. 32675-04A** Timer Cover. **\$20.95**  
Fits '04-later XL models. Includes chrome-plated stainless steel mounting hardware.
- 3. 29642-04** Air Cleaner Trim. **\$29.95**  
Fits '04-later XL models equipped with Original Equipment air cleaner cover.



A. THE SPORTSTER COLLECTION

## B. THE WILLIE G.® SKULL COLLECTION

Add a little attitude to your ride. Styled to complement Harley-Davidson® Skull accessory items, the menacing raised skull with black-filled eyes leaps from a field of chrome. The surrounding "Harley-Davidson Motorcycles" script is the perfect finishing touch. This complete collection of engine covers dresses your bike for a true look.

- 1. 25440-04A** Derby Cover. **\$59.95**  
Fits '04-later XL and XR models. Includes chrome-plated stainless steel mounting hardware.
- 2. 32972-04A** Timer Cover. **\$25.95**  
Fits '04-later XL models. Includes chrome-plated stainless steel mounting hardware.
- 3. 29416-04** Air Cleaner Insert. **\$39.95**  
Fits '04-later XL models equipped with Original Equipment air cleaner cover.



B. THE WILLIE G. SKULL COLLECTION

## C. CHROME "H-D MOTOR CO." LOGO COLLECTION

This collection personifies Harley style. It had better, because we put our name on it – Harley-Davidson Motor Co. Collection.

- 1. 25130-04A** Derby Cover. **\$41.95**  
Fits '04-later XL and XR models. Includes chrome-plated stainless steel mounting hardware.
- 25332-98** Derby Cover. *(not shown)* **\$41.95**  
Fits '94-'03 Sportster® models.
- 2. 32668-98A** Timer Cover. **\$20.95**  
Fits models with horizontal holes on timer cover. Includes chrome-plated stainless steel mounting hardware.



C. CHROME "H-D MOTOR CO." LOGO COLLECTION

*Notice: The prices appearing in this catalog are the manufacturer's suggested retail prices. Actual retail prices may vary.*



D. DARK CUSTOM LOGO COLLECTION

**D. DARK CUSTOM LOGO COLLECTION**

The famous Harley-Davidson #1 logo with a sinister twist. Machined from billet aluminum, these covers feature domed surfaces that are polished and black anodized to a rich satin sheen, and then re-machined to expose the raw aluminum. The resulting high-contrast design complements both polished and painted engine finishes.

- |  |                 |
|--|-----------------|
| <b>1. 25563-09</b> Derby Cover.<br>Fits '04-later XL models. | <b>\$129.95</b> |
| <b>2. 32415-09</b> Timer Cover.<br>Fits '04-later XL models. | <b>\$59.95</b>  |

**E. NUMBER ONE SKULL COLLECTION – CHROME**

The sinister Harley-Davidson #1 Skull logo dresses for a night on the town. This complete die-cast aluminum collection has been polished and chrome-plated to a brilliant shine, then finished with a contrasting black-filled Dark Custom Skull logo. The black-filled race track stripe and recessed hardware pockets provide added depth and dimension. Includes chrome-plated mounting hardware. (Available September, 2009)

- |  |                |
|--|----------------|
| <b>1. 25333-10</b> Derby Cover.<br>Fits '04-later XL models.   | <b>\$64.95</b> |
| <b>2. 32520-10</b> Timer Cover.<br>Fits '04-later XL models.   | <b>\$25.95</b> |
| <b>3. 27957-10</b> Air Cleaner Trim.<br>Fits '04-later XL models equipped with Original Equipment air cleaner cover. | <b>\$44.95</b> |



E. NUMBER ONE SKULL COLLECTION – CHROME

**F. THE FLAMES COLLECTION**

Ever since they began emerging on gas tanks a few decades ago, flames have been a symbol of custom styling. Now, Harley-Davidson continues the tradition with the Flames Collection.

- |   |                |
|---|----------------|
| <b>1. 25125-04A</b> Derby Cover.<br>Fits '04-later XL and XR models. Includes chrome-plated stainless steel mounting hardware.                      | <b>\$59.95</b> |
| <b>25400-98</b> Derby Cover. ( <i>not shown</i> )<br>Fits '94-'03 Sportster® models.  | <b>\$59.95</b> |
| <b>2. 32571-98A</b> Timer Cover.<br>Fits all models with horizontal holes on timer cover. Includes chrome-plated stainless steel mounting hardware. | <b>\$25.95</b> |
| <b>3. 29824-04</b> Air Cleaner Trim.<br>Fits '04-later XL models equipped with Original Equipment Air Cleaners.                                     | <b>\$39.95</b> |

**G. THE HARLEY-DAVIDSON "LIVE TO RIDE" LOGO COLLECTION**

"Live to Ride, Ride to Live." It has become the motto of the Harley-Davidson nation, accompanying riders over millions of miles of travel. This collection is a tribute to that way of life.

- |  |  |
|--|--|
| <b>1. 25127-04A</b> Derby Cover – Gold.<br>Fits '04-later XL and XR models. Includes chrome-plated stainless steel mounting hardware.  | <b>\$59.95</b>                               |
| <b>25398-95T</b> Derby Cover – Gold. ( <i>not shown</i> )<br>Fits '94-'03 Sportster® models.   | <b>\$59.95</b>                               |
| <del><b>25397-95T</b> Derby Cover – Chrome. (<i>not shown</i>)</del><br>Fits '94-'03 Sportster® models.  | <del><b>\$41.95</b></del><br><b>OBSOLETE</b> |
| <b>2. 32581-85T</b> Timer Cover – Chrome.<br>Fits models with horizontal mounting holes (except '04-later XL models).  | <b>\$25.95</b>                               |
| <b>32581-90TB</b> Timer Cover – Gold. ( <i>not shown</i> )<br>Fits models with horizontal mounting holes (except '04-later XL models). Includes chrome-plated stainless steel mounting hardware. | <b>\$32.95</b>                               |
| <b>3. 29823-04</b> Air Cleaner Trim – Gold.<br>Fits '04-later XL models equipped with Original Equipment air cleaner.  | <b>\$39.95</b>                               |
| <b>29405-90T</b> Air Cleaner Trim – Gold. ( <i>not shown</i> )<br>Fits '66-'78 and '83-'03 XL models, '67-early '78 FL, and '71-early '78 FX models.   | <b>\$39.95</b>                               |

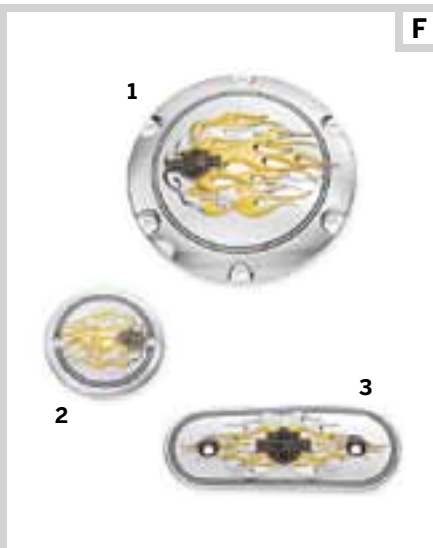

F. THE FLAMES COLLECTION



G. THE HARLEY-DAVIDSON "LIVE TO RIDE" LOGO COLLECTION

# 90 SPORTSTER®

Engine & Chassis Trim

## A. PREMIUM OIL COOLER FOR SPORTSTER® MODELS

Big Twin oil cooler technology for the Sportster® model. This vertical-mount cooler features a unique "Turbulator" system that efficiently distributes oil across the cooling chambers. The air fins feature several louvers to efficiently dissipate heat. The Premium Oil Cooler has been designed for ease of installation, and features oil lines that connect directly to the oil pump and engine. Kit includes oil cooler, oil lines and mounting hardware.

**62996-07** Fits '04-later XL models. **\$224.95**

**Inside View of Premium Oil Cooler with Turbulators**

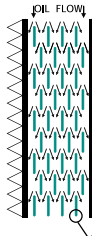

Turbulators disperse and mix oil inside cooler to provide more efficient cooling capabilities. The cooler oil is not allowed to remain along the boundaries of the flow tube as in conventional coolers.

**Inside View of Conventional Oil Cooler without Turbulators**

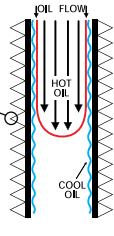

Coolers without the Turbulator system allow oil to flow only in a straight path. Oil does not mix and the cooler oil remains along the outer boundaries, while the hotter oil remains along the center path of flow. Without the mixing effects of the Turbulators, the conventional oil cooler provides less efficient cooling capabilities.



**A. PREMIUM OIL COOLER FOR SPORTSTER MODELS**

## B. CHROME OIL COOLER COVER

Add a beautiful accent to your Sportster Premium Oil Cooler. This chrome cover is designed to allow proper air flow through the integrated duct work. Requires Grey Silicone RTV Adhesive P/N 99650-02 for installation.

**63087-07** **\$34.95**  
Fits '04-later XL models equipped with Premium Oil Cooler Kit P/N 62996-07.

## C. CHROME "H-D MOTOR CO." LOGO OIL DIPSTICK

Oil dipstick features "H-D® Motor Co." logo.

**62734-96A** **\$14.95**  
Fits '82-'03 Sportster® models.

## D. OIL DIPSTICK WITH TEMPERATURE GAUGE

Replace your Original Equipment oil dipstick with this custom-styled version featuring an easy-to-see mechanical temperature readout with "Harley-Davidson" logo. A chrome-plated cap completes the styling and provides an easy grip for removal.

**63023-05** Fits '04-later XL and XR models. **\$45.95**

**62667-87TA** Fits '82-'03 XL models. **\$27.95**



**B. CHROME OIL COOLER COVER**



**C. CHROME "H-D MOTOR CO." LOGO OIL DIPSTICK**



**D. OIL DIPSTICK WITH TEMPERATURE GAUGE – '04-LATER MODELS**



**D. OIL DIPSTICK WITH TEMPERATURE GAUGE – '82-'03 MODELS**

Notice: The prices appearing in this catalog are the manufacturer's suggested retail prices. Actual retail prices may vary.





E. CHROME HEADBOLT BRIDGE KIT



F. FINNED HEADBOLT BRIDGE



G. CLASSIC CHROME ROCKER BOX BOLT COVERS



H. CHROME SPARK PLUG/HEADBOLT COVER



I. CLASSIC CHROME HEADBOLT COVER KIT



J. GLOSS BLACK HEADBOLT COVER KIT



K. CHROME "H-D MOTOR CO." HEADBOLT COVER KIT



L. CHROME BAR &amp; SHIELD LOGO HEADBOLT COVER KIT

**E. CHROME HEADBOLT BRIDGE KIT**

This exclusive Headbolt Bridge covers both the headbolts and spark plug with a splash of chrome and an engraved Bar & Shield emblem. Easy-to-install with unique headbolt mounts. Kit includes all necessary mounting hardware (sold in pairs).

**44432-04** Fits '04-later XL and XR models. **\$54.95**

**F. FINNED HEADBOLT BRIDGE**

This exclusive aluminum die-cast Headbolt Bridge covers both headbolts and the spark plug, filling out your cylinder fins all the way to the rocker box. Featuring an engraved Bar & Shield emblem, the bridge is easy-to-install with unique headbolt mounts (sold in pairs). All necessary mounting hardware included.

**44296-04** Black. **\$47.95**  
Fits '04-later XL models (except XL883N).

**G. CLASSIC CHROME ROCKER BOX BOLT COVERS**

Matching the styling of our classic chrome headbolt covers, these chrome-plated Rocker Box Bolt Covers add chrome to your engine. Easy-to-install, the covers are held in place by a spring steel clip. Sold in packages of four.

**43943-01** **\$23.95**  
Fits '84-'99 Evolution 1340-equipped models and '87-later XL and '08-later XR models.

**H. CHROME SPARK PLUG/HEADBOLT COVER**

Quickly add a chrome accent from the headbolt covers to the spark plug. Installs in seconds without tools.

**43835-98** **\$54.95**  
Fits '84-'99 Evolution® 1340-equipped and '83-'03 XL models. (Does not fit Screamin' Eagle® Evolution Cylinder Heads.)

**I. CLASSIC CHROME HEADBOLT COVER KIT**

Precision-machined of high-quality aluminum and manufactured in the U.S.A. Hand-polished and chrome-plated. This kit includes 4 chrome headbolt covers, set screws, and an Allen wrench for easy installation.

**43890-93** **\$36.95**  
Fits '84-'99 Evolution 1340-equipped models and '87-later XL and '08-later XR models.

**J. GLOSS BLACK HEADBOLT COVER KIT**

The perfect accessory for your blacked-out motorcycle, these gloss black, powder-coated covers feature two machined grooves that add that subtle, yet distinctive custom highlight.

**43896-99** **\$38.95**  
Fits '92-'99 Evolution 1340, XL and XR models.  
Also fits '99-later Twin Cam-equipped models.

**K. CHROME "H-D MOTOR CO." HEADBOLT COVER KIT**

**43884-96** **\$36.95**  
Fits '92-'99 Evolution® 1340, XL and XR models.  
Also fits '99-later Twin Cam-equipped models.

**L. CHROME BAR & SHIELD LOGO HEADBOLT COVER KIT**

Precision-machined of high-quality aluminum and manufactured in the U.S.A. Hand-polished and chrome-plated. Kit includes 4 headbolt covers, set screws and Allen wrench for easy installation.

**43911-95** **\$36.95**  
Fits '84-'99 Evolution 1340-equipped models and '87-later XL and '08-later XR models.

# 92 SPORTSTER®

Engine & Chassis Trim

## A. CHROME HARDWARE KIT – PRIMARY COVER

Kit includes smooth socket head screws and washers, button head derby cover and flat head inspection cover screws made to Harley-Davidson specifications. Kit includes the hardware required to replace the visible set of zinc-plated fasteners on the outer primary cover. Inspection and derby cover hardware included. Lock patch included where required.

**94281-04** Fits '04-later XL models. **\$59.95**

## B. CHROME HARDWARE KIT – GEARCASE/FRONT SPROCKET COVER

Kit includes smooth socket head screws and washers, and button head timer cover screws made to Harley-Davidson specifications. Kit includes the hardware required to replace the visible set of zinc-plated fasteners on the gearcase and front sprocket cover. Lock patch included where required.

**94280-04** Fits '04-later XL models. **\$42.95**

## C. CHROME HARDWARE KIT – ROCKER BOX COVER

Kit includes smooth socket head screws and washers made to Harley-Davidson specifications. Kit includes the hardware required to replace the visible set of zinc-plated fasteners on the rocker box covers. Lock patch included where required.

**94291-04A** Fits '04-later XL models. **\$34.95**

## D. CLASSIC COVERS KIT

Customize your bike down to the last detail. These hardware Cover Kits include the chrome-plated ABS caps and plugs in the sizes and styles required to dress the viewable hardware on the motorcycle. Classic Covers are available as complete Bike Kits with the covers for both engine and chassis hardware, or as Engine-only kits to dress the Twin Cam or XL engine. The kits are easy to install, with no tools required.

**94946-07** Bike Kit. **\$184.95**  
Fits '04-later XL models.

**94944-07** Engine Kit. **\$94.95**  
Fits '04-later XL models.

## E. CLUTCH CABLE CONNECTOR COVER

Add the finishing touch to your transmission. This chrome-plated die-cast cover conceals the clutch cable connector as it enters the primary cover. The two-piece grooved and tapered cover is easy-to-install, and includes chrome-plated mounting hardware.

**33401-05** **\$26.95**  
Fits '00-later XL and XR models with cable operated clutch.

## F. VOLTAGE REGULATOR COVER

With a look that creates its own electricity, this chrome-plated cover features an embossed Bar & Shield logo and an open-center grill that allows air to flow through for regulator cooling. Designed for easy installation. Chrome mounting hardware included.

**74609-04** **\$38.95**  
Fits '04-'06 XL models.

**74579-97** **\$38.95**

Fits '85-'03 XL models. Will not fit with Front Spoiler P/N 58597-97, unless also equipped with the Sport Front Fender and the additional purchase of Voltage Regulator Hardware Kit P/N 74568-98.

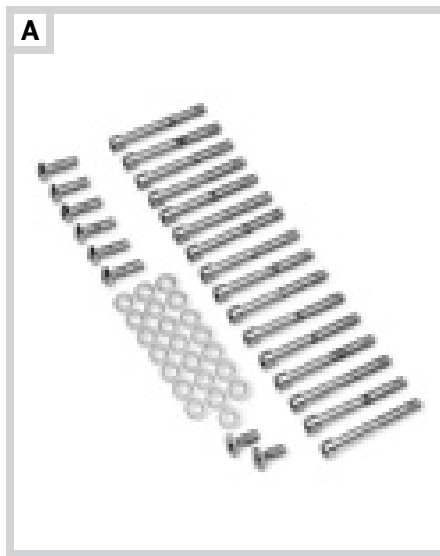

A. CHROME HARDWARE KIT – PRIMARY COVER



B. CHROME HARDWARE KIT – GEARCASE/FRONT SPROCKET COVER



C. CHROME HARDWARE KIT – ROCKER BOX COVER



D. CLASSIC COVERS KIT (NOT ALL COMPONENTS SHOWN)



E. CLUTCH CABLE CONNECTOR COVER



F. VOLTAGE REGULATOR COVER

Notice: The prices appearing in this catalog are the manufacturer's suggested retail prices. Actual retail prices may vary.



G. CHROME RIGHT SIDE OIL TANK COVER



H. SIDE COVER WING TIP



I. CHROME OIL TANK COVER FOR SPORTSTER MODELS



J. BAR &amp; SHIELD LOGO COIL COVER KIT



K. CHROME BATTERY SIDE COVER

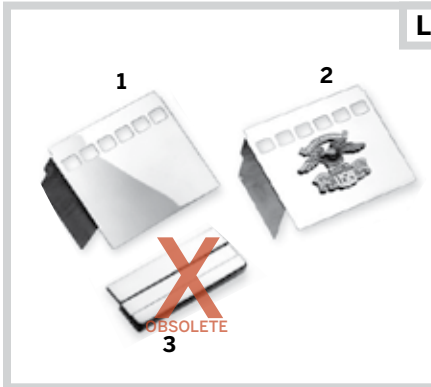

L. CHROME BATTERY COVERS



M. CHROME IGNITION MODULE COVER



N. CHROME IGNITION SWITCH COVER

**G. CHROME RIGHT SIDE OIL TANK COVER**

Like oil on blacktop, this Chrome Oil Tank Cover adds a brilliant sheen to the surface. Easy-to-install, the mirror-chrome cover follows the contour of the frame and blends perfectly with the pop-up dipstick. A perfect complement for the Chrome Left Side Battery Cover P/N 66261-04.

**66262-04** Fits '04-later XL models.

**\$99.95**

**Also available:****CHROME LEFT SIDE BATTERY COVER** (not shown)

Designed to hug the contour of the frame, this mirror-chrome Battery Cover layers a splash of chrome to the left side of the bike. Easy-to-install, this cover is the ideal companion to the Chrome Oil Tank Cover P/N 66262-04.

**66261-04** Fits '04-later XL models.

**\$104.95**

**H. SIDE COVER WING TIPS**

Formed to hug the contour of the Sportster® Side Covers, the kit features three-dimensional trim with contrasting bright and brushed finishes for a distinctive appearance. A classic addition to painted or chrome side covers. Self-adhesive and easy-to-install, the kit includes left and right trim pieces.

**66264-04** Fits '04-later XL models.

**\$37.95**

**I. CHROME OIL TANK COVER FOR SPORTSTER® MODELS**

Chrome Oil Tank Cover gives the appearance of having your oil tank chromed. Installs in minutes. Mounting hardware included.

**62512-97**

**\$74.95**

Fits '94-'03 XL models (except models with Touring Seat P/N 52105-93, 93A, 93B, 93C).

**J. BAR & SHIELD LOGO COIL COVER KIT**

Dress your coil in chrome. The sleek Coil Cover is styled to add a custom touch to a very visible part of your Sportster motorcycle. Featuring mirror-finish chrome-plating and an open-face Bar & Shield logo, this easy-to-install kit includes chrome-plated mounting hardware.

**31767-04** Fits '04-'06 XL models.

**\$37.95**

**K. CHROME BATTERY SIDE COVER**

This chrome-plated cover is designed for use with the Harley-Davidson® AGM sealed maintenance-free batteries, and can be used in combination with Battery Top Cover P/N 66367-97 or 66368-97.

**66718-01**

**\$41.95**

Fits '97-'03 XL models and '97-'05 Dyna® models.

**L. CHROME BATTERY COVERS\***

Chrome-plated battery enclosures include slotted openings for convenient visual check of battery fluid levels. Easy installation.

**1. 66340-78** Chrome Vented.

**\$38.80**

Fits '82-'03 XL models, electric start FX, FXWG models, and '91-'96 Dyna models.

**2. 66358-83** USA Eagle.

**\$54.95**

Fits '82-'03 XL models, electric start FX, FXWG models, and '91-'96 Dyna models.

**3. 66367-73** Top Cover.

**\$26.95**

Fits '82-'96 XL models.

**OBSOLETE**

**66367-97** Top Cover. (not shown)

**\$24.95**

Fits '97-'03 XL models.

\*NOTE: Battery dimensions of Harley-Davidson® AGM Batteries P/N 65989-97A, 65989-90B and 65991-82B may not allow use of accessory battery side covers on XL and Dyna models.

**M. CHROME IGNITION MODULE COVER**

**66328-82T** Fits '82-'03 XL models.

**\$22.95**

**N. CHROME IGNITION SWITCH COVER**

A direct replacement for the stock black ignition switch cover, this chrome-plated cover is made of lightweight ABS plastic. Includes ignition switch position decal.

**71527-04** Fits '04-later XL models.

**\$21.95**

**71514-98** Fits '95-'03 XL models.

**\$19.95**

Notice: The prices appearing in this catalog are the manufacturer's suggested retail prices. Actual retail prices may vary.

# SPORTSTER® CHASSIS TRIM

## DEFINE YOUR LOOK.

*Customizing your motorcycle is about selecting accessories that work together to reflect your personality. Envision your bike as a whole and choose the options that will make that vision a reality. Developing a “look” for your bike doesn’t have to be difficult; before you start, just decide on a direction and stick with it.*



### BLACK & CHROME

Genuine H-D® Accessories are developed by the same folks that built your bike, so you can be assured that plated or painted parts will match the Original Equipment finishes for a unified look.



## FOCUS ON THE PROFILE

### FRONT END TRIM

*Custom fork sliders, wheels and rotors put your sense of style front and center. And simple additions like custom axle covers and hardware finish the look.*

### REAR END TRIM

*A chrome swingarm and custom wheels make a major visual impact, and easy-to-install axle covers, belt guards and custom hardware give a unified look.*

### HAND CONTROLS

*Adding mirrors, grips and a little chrome puts style in full view of the rider. A custom master cylinder, switch covers and hand levers give instant gratification.*

### FOOT CONTROLS

*Custom foot pegs, foot levers and shift linkages offer exceptional function and style, and highway pegs and engine guards add comfort and engine protection.*

### CONSOLES & GAUGES

*The link between your brain and the bike. Auxiliary gauges help you monitor your engine's vital signs, and a custom console says a lot beyond the numbers.*

### LIGHTING

*Lighting adds distinctive style and aids visibility. Choose from a variety of auxiliary lamps, headlamp trim and LED lighting to grab maximum attention.*





A. CHROME LOWER FORK SLIDERS

**A. CHROME LOWER FORK SLIDERS**

Competitively priced, these chrome-plated Lower Fork Sliders give your bike upfront style. To ensure proper fitment and function, these sliders are manufactured from Original Equipment components. Form follows function, with polished triple chrome-plating and a stamped "Harley-Davidson" script logo for product identification.

**46562-04A** **\$299.95**

Fits '08-later XL models (except XL883R, XL883N, XL1200N and XL1200R) and '04-'05 Dyna® FXD, FXDC and FXDL models.

**46487-08** **\$299.95**

Fits '08-later XL883R and XL1200R models.

**46492-00** **\$299.95**

Fits '00-'07 XL models (except XL883R, XL1200S and XL1200R) and '00-'03 FXD and '01-'03 FXDL models.

**45275-98** **\$304.95**

Fits '88-'99 XL models and FXD Super Glide®, '87-later FXLR and '88-'99 FXR and FXRS. (Does not fit Sportster Sport models.)

**B. CHROME FRONT END KITS\***

The front forks on a Harley-Davidson® motorcycle set the tone for the bike, and can lead the way to a full-bore custom statement. So start customizing by adding chrome where it will have the most noticeable impact on the overall look of the bike, your front end. This package includes components necessary to completely chrome the front forks and includes some or all of the following (Kit components vary depending on your model): Chrome Fork Sliders, Chrome Fork Axle Retainer Nut Kit, Chrome Fork Slider Drain Screw Kit, Chrome Front Wheel Spacers, Classic Chrome Front Axle Nut Cover Kit, and Chrome Upper Fork Nut Covers.

**46331-08A** **\$379.95**

Fits '08-later XL883, XL883L, XL883C, XL1200L and XL1200C models.

**46331-04** **\$389.95**

Fits '00-'07 XL models (except XL883R, XL1200R and XL1200S).

\*Chrome Front End Package price does not include labor or supplies.

**C. CHROME FRONT WHEEL SPACERS**

Complete your total front end with these highly polished chrome-plated wheel spacers. Manufactured to the Original Equipment tolerances, they deliver exact fitment and custom shine.

**41370-08** Tapered. **\$29.95**

Fits '08-later XL models.

**41616-02** Smooth. (inset) **\$29.95**

Fits '00-'07 XL models and '00-'03 FXD, FXDL, FXDX, FXDXT and FXDS-CONV. models.

**D. CHROME FORK AXLE RETAINER NUT KIT**

It's the details that count. Complete the chrome transformation by adding this finishing touch to your chrome fork sliders. This Axle Retainer Nut Kit includes the stylish chrome-plated nuts and chrome lockwashers necessary to replace the stock hardware.

**45802-03** **\$7.95**

Fits '88-later XL models, '93-'05 Dyna FXD, FXDL, FXDS-CONV., FXDX, FXDX-T models and '88-'94 FXR, FXRS, FXRS-SP, FXRS-CONV., FXLR, FXRT models.

Shown with:

**CHROME FORK SLIDER DRAIN SCREW KIT**

It's the details that count. Complete the chrome transformation by adding this finishing touch to your chrome fork sliders. This Fork Slider Drain Screw Kit includes two chrome-plated drain screws and the seals required to replace the stock hardware.

**45815-03** **\$3.95**

Fits '73-later XL models (except XL Sport), '78-'86 FX models, '94-'05 Dyna FXD/DL/DS-CONV., '99-'00 FXR2/3/4 models, and '00-'07 FXSTD models.

**E. SCREAMIN' EAGLE® CHROME FORK BRACE**

This Chrome Fork Brace is machined from billet aluminum, then polished and chrome-plated. Easy-to-install, this brace offers increased torsional rigidity. Made in the U.S.A.

**46192-99A** 39mm. **\$184.95**

Fits '87-later XL (except XL1200N), '91-'05 Dyna (except FXDWG) and FXR models (except FXRT) with 39mm front forks. (Does not fit with Chrome Fork Sliders.)



B. CHROME FRONT END KITS



C. CHROME FRONT WHEEL SPACER



D. CHROME FORK AXLE RETAINER NUT KIT (SHOWN WITH CHROME DRAIN SCREW KIT)



E. SCREAMIN' EAGLE CHROME FORK BRACE

Notice: The prices appearing in this catalog are the manufacturer's suggested retail prices. Actual retail prices may vary.

# 96 SPORTSTER®

Chassis Trim – Front End

## A. CLASSIC CHROME FRONT AXLE NUT COVER KIT

Cover the front axle in a classic style. Chrome-plated axle nut covers look great with Original Equipment satin-finish fork sliders, or add a finishing touch to a complete chrome front end (*sold in pairs*).

Fits '02-later VRSC™ models (except VRSCR and VRSCF), '08-later XL, '07 Softail® (except Springer®, FXCW, FXCWC and FXSTD), '08-later Dyna® and '08-later Touring models.

**44116-07A** Billet. **\$41.95**

**44117-07A** Die Cast. **\$26.95**

Fits '84-'06 Softail® (except Springer and FXSTD); '91-'03 FXD, FXDX, FXDXT, FXDL, FXDS-CONV.; '93-'05 FXDWG; '80-'99 Touring; '88-'07 XL, FXR and '87-later FLXR/FXRS-SP, FXWG models.

**43899-86A** Die Cast. **\$26.95**



**A. CLASSIC CHROME FRONT AXLE NUT COVER KIT**



**B. GLOSS BLACK FRONT AXLE NUT COVER KIT**

## B. GLOSS BLACK FRONT AXLE NUT COVER KIT

Gloss black covers conceal the front axle hardware for a clean, custom look. Kit includes set screws and Allen wrench for easy installation.

**43428-09** **\$41.95**

Fits '02-later VRSC™ models (except VRSCR and VRSCF), '08-later XL, '07-later Softail® (except Springer®, FXCW, FXCWC and FXSTD), '08-later Dyna® and '08-later Touring models.

## C. WILLIE G.® SKULL COLLECTION FRONT AXLE NUT COVER KIT

Add a little attitude to your ride. Styled to complement Harley-Davidson® Skull accessory items, the menacing raised skull with black-filled eyes leaps from a field of chrome. The surrounding "Harley-Davidson Motorcycles" script is the perfect finishing touch. The Axle Nut Covers are easy-to-install, and include all necessary mounting hardware (*sold in pairs*).

**43163-08A** **\$28.95**

Fits '08-later XL, '84-later Softail (except Springer, FXCW, FXCWC and FXSTD), '02-later VRSC (except VRSCR and VRSCF), '91-later Dyna, and '99-later Touring models.



**C. WILLIE G. SKULL COLLECTION FRONT AXLE NUT COVER KIT**

## D. SPORTSTER® COLLECTION FRONT AXLE NUT COVER KIT

The Sportster Collection from Harley-Davidson adds depth and shadows to your custom ride. The layered design is formed, polished, and chrome-plated to a mirror finish. The bold "Sportster" script is filled with black for a distinctive contrast. The tapered Axle Nut Covers are easy-to-install, and include all necessary mounting hardware.

**43378-04** Fits '88-'07 XL models. **\$26.95**



**D. SPORTSTER COLLECTION FRONT AXLE NUT COVER KIT**

## E. "H-D MOTOR CO." LOGO FRONT AXLE NUT COVER KIT

Die-cast, chrome-plated covers feature the "Harley-Davidson Motor Co." logo in black. Includes Allen-head set screws and wrench for easy installation.

**44148-07A** **\$26.95**

Fits '02-later VRSC models (except VRSCR and VRSCF), '08-later XL, '07-later Softail (except Springer, FXCW, FXCWC and FXSTD), '08-later Dyna and '08-later Touring models.



**E. "H-D MOTOR CO." LOGO FRONT AXLE NUT COVER KIT**

## F. ALUMINATOR® CHROME BILLET FRONT AXLE NUT COVER KIT

Includes set screws and Allen wrench for easy installation.

**43907-94** **\$41.95**

Fits '84-'06 Softail® (except Springer and FXSTD); '91-'03 FXD, FXDX, FXDXT, FXDL, FXDS-CONV.; '93-'05 FXDWG; '80-'99 Touring; '88-'07 XL, FXR and '87-later FLXR/FXRS-SP, FXWG models.



**F. ALUMINATOR CHROME BILLET FRONT AXLE NUT COVER KIT**

Notice: The prices appearing in this catalog are the manufacturer's suggested retail prices. Actual retail prices may vary.



**G. BAR & SHIELD LOGO REAR AXLE COVER KIT – CHROME**



**G. BAR & SHIELD LOGO REAR AXLE COVER KIT – GLOSS BLACK**

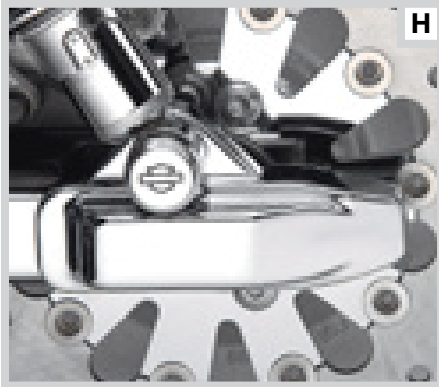

**H. REAR AXLE COVER FOR SPORTSTER MODELS**



**I. CHROME REAR WHEEL SPACER KITS**

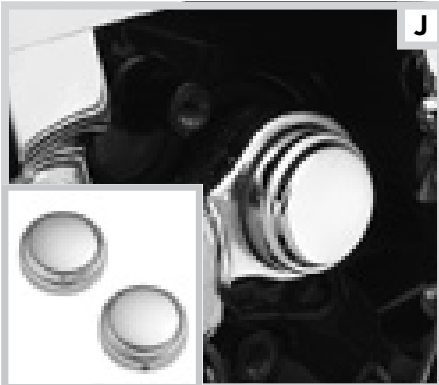

**J. CLASSIC CHROME SWINGARM PIVOT BOLT COVER KIT**

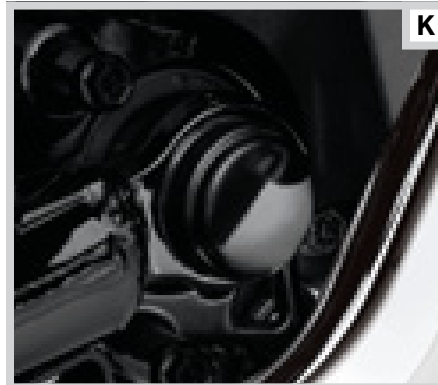

**K. GLOSS BLACK SWINGARM PIVOT BOLT COVER KIT**



**L. THE WILLIE G. SKULL COLLECTION PIVOT BOLT COVER KIT**



**M. SPORTSTER COLLECTION PIVOT BOLT COVER KIT**

### G. BAR & SHIELD LOGO REAR AXLE COVER KIT

Die-cast cover conceals the side of the swingarm and axle. Unique styling features an embossed Bar & Shield logo. Easy-to-install without removing the rear wheel. Kit includes all necessary mounting hardware.

Fits '05-later XL883L, XL883C, XL883N, XL1200N, XL1200L and XL1200C models. Also fits '05-later XL models equipped with Low Rear Suspension Kit P/N 54731-04, 54733-04 or 54750-05. (Will not fit models equipped with saddlebags or Chrome Billet Shock Hardware Kit P/N 54337-05.)

**46399-05** Chrome. **\$54.95**

**43013-09** Gloss Black. **\$54.95**

### H. REAR AXLE COVER FOR SPORTSTER® MODELS

The sleek contours of this chrome-plated steel cover dress up the Sportster rear axle and swingarm. The die-cast cover for the lower shock mount features a black paint filled Bar & Shield logo.

**45448-04** Fits '04 XL models only. **\$54.95**

### I. CHROME REAR WHEEL SPACER KITS

Add some chrome detail to an often overlooked area of the bike with this highly-polished Chrome Wheel Spacer Kit. Manufactured to the Original Equipment tolerances, they ensure product fitment and quality.

**1. 41369-08** Tapered. **\$29.95**

Fits '08-later XL and XR models. Does not fit Japanese models.

**2. 41653-05** Straight. **\$29.95**

Fits '05-'07 XL models. Does not fit Japanese models.

### J. CLASSIC CHROME SWINGARM PIVOT BOLT COVER KIT

Cover the swingarm pivot bolt in classic style. The easy-to-install kit includes left and right chrome-plated die-cast pivot bolt covers and necessary mounting hardware.

**43580-04** Fits '04-later XL models. **\$26.95**

### K. GLOSS BLACK SWINGARM PIVOT BOLT COVER KIT

Cover the swingarm pivot bolt in classic style. The easy-to-install kit includes left and right die-cast pivot bolt covers and necessary mounting hardware.

**47625-09** Fits '04-later XL models. **\$26.95**

### L. THE WILLIE G.® SKULL COLLECTION PIVOT BOLT COVER KIT

Add a little attitude to your ride. Styled to complement Harley-Davidson Skull accessory items, the menacing raised skull with black-filled eyes leaps from a field of chrome. The surrounding "Harley-Davidson Motorcycles" script is the perfect finishing touch. This easy-to-install kit includes left and right pivot bolt covers and necessary mounting hardware.

**42072-07** Fits '04-later XL models. **\$28.95**

### M. SPORTSTER® COLLECTION PIVOT BOLT COVER KIT

The Sportster Collection from Harley-Davidson adds depth and shadows to your custom ride. The layered design is formed, polished, and chrome-plated to a mirror finish. The bold "Sportster" script is filled with black for a distinctive contrast. This easy-to-install kit includes left and right pivot bolt covers and necessary mounting hardware.

**43556-04** Fits '04-later XL models. **\$28.95**

# 98 SPORTSTER®

Chassis Trim – Rear End

## A. CHROME SWINGARM

The ultimate chrome accessory, polished to the highest standard using bright plating to match Original Equipment chrome. Affordable and convenient, with no troublesome exchanges necessary. Factory specifications guarantee exact fitment, unparalleled quality and an affordable price. Stamped with the Harley-Davidson® Bar & Shield logo.

**48434-05** Fits '05-later XL models. **\$199.95**

**Shown with:**

### CHROME UPPER BELT GUARD

Attract attention to your Sportster® motorcycle by replacing the black Original Equipment component, providing exceptional chrome-plated detail to the rear drive system. Easy to clean, and simple to install.

**60402-04** Fits '04-later XL models. **\$89.95**

**Also shown with:**

### CHROME LOWER BELT GUARD

This handsome steel cover is polished, chrome-plated and designed to replace the Original Equipment black plastic cover. Easy-to-install, this guard looks great when combined with a Harley-Davidson® Chrome Upper Belt Guard.

**60413-04** Fits '04-later XL models. **\$79.95**

**60480-94T** Fits '91-'03 XL models. **\$79.95**

## B. BLACK BUCKSHOT UPPER BELT GUARD

Add the "blacked-out" look of the Nightster motorcycle to your Sportster model. The perforated "Buckshot" design visually lightens the belt guard and adds a raw, purposeful edge to the bike's profile.

**60379-09** **\$89.95**  
Fits '04-later XL models. Original Equipment on XL1200N.

## C. CHROME "BIG SPOKE" SPROCKET COVER

Muscle rules. Big, beefy spokes define the distinctive hot rod styling, and the small trapezoidal openings are reminiscent of Detroit's street performance wheels of the late 60s. The chrome-plated steel cover disguises the Original Equipment sprocket, and complements both stock and custom wheels. Easy-to-install, this cover provides the look of a billet sprocket at a fraction of the cost.

**40124-10** Fits '04-later XL models. **\$49.95**

## D. CHROME SPROCKET COVER

The five-spoke Sprocket Cover matches the styling of the Original Equipment sprocket, providing the appearance of a chrome sprocket at a fraction of the cost. The raised ribs mimic the look of a billet sprocket. Easy-to-install, the cover looks great with Chrome Upper and Lower Belt Guards.

**91746-03** Fits '04-later XL and XR models. **\$49.95**



**A. CHROME SWINGARM (SHOWN WITH CHROME UPPER AND LOWER BELT GUARDS AND CHROME SPROCKET COVER)**

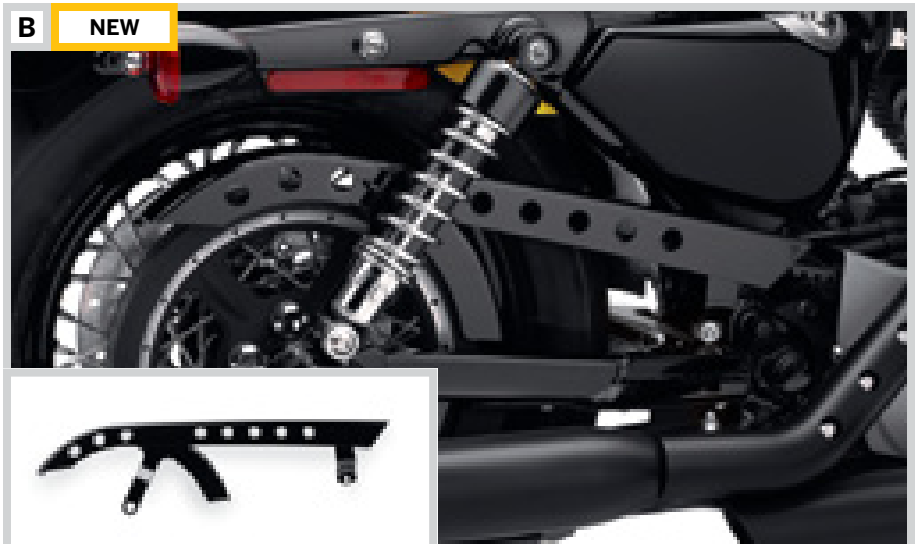

**B. BLACK BUCKSHOT UPPER BELT GUARD**



**C. CHROME "BIG SPOKE" SPROCKET COVER**



**D. CHROME SPROCKET COVER**

*Notice: The prices appearing in this catalog are the manufacturer's suggested retail prices. Actual retail prices may vary.*

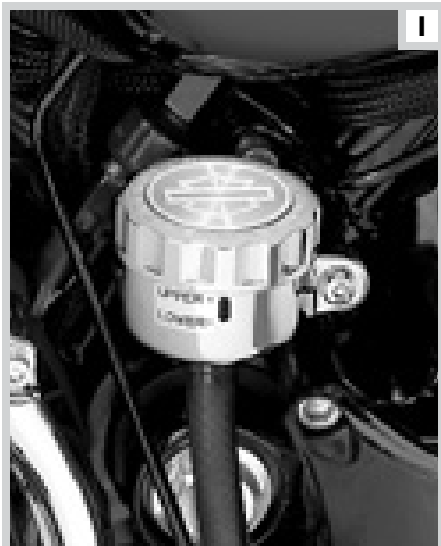

**E. CHROME SPROCKET COVER WITH HOLES****F. REAR SPROCKET BOLT COVER KIT****G. CHROME HARDWARE KIT FOR REAR BELT SPROCKET - HEX HEAD****H. CHROME BRAKE DISC HARDWARE KIT****I. REAR BRAKE RESERVOIR COVER****J. CHROME BANJO BOLT KIT****E. CHROME SPROCKET COVER WITH HOLES**

This handsome steel cover is polished and chrome-plated. Easy-to-install. Looks great when combined with Harley-Davidson® Chrome Belt Guard. Chrome Hardware Kit P/N 94708-98 completes the look.

**40279-91A** Fits '91-'03 XL models. **\$49.95**

**F. REAR SPROCKET BOLT COVER KIT**

These chrome-plated covers with internal spring clips hide the Original Equipment sprocket bolts for a clean, custom look. Set of 5 covers.

**43876-04** **\$38.95**

Fits '93-later Softail®, '99-later Touring (except Trike) and '04-later XL models with Original Equipment 7/16" hex head sprocket mounting bolts (5/8" hex across the flats).

**G. CHROME HARDWARE KIT FOR REAR BELT SPROCKET - HEX HEAD**

This kit includes highly-polished, chrome-plated, grade 8 hex-head screws with chrome-plated washers, providing an extra custom accent. The perfect addition to the chrome sprocket. Made from the same Original Equipment bolts to ensure product integrity. Also works with chrome belt sprocket covers and Original Equipment sprockets.

**94708-98** **\$29.95**

Fits '93-'99 Softail, '93-'99 Dyna, '91-later Sportster® rear belt sprockets.

**H. CHROME BRAKE DISC HARDWARE KIT**

It's the details, like this chrome hardware kit, that really get your bike noticed. These Button Head Screws add a unique, chrome-plated finish to the Original Equipment or accessory floating brake rotors. Kit includes 5 chrome-plated bolts manufactured to factory specifications to ensure fit and performance.

**46646-05** Front. **\$12.95**

Fits '90-later models (except VRSC™, XR, '06-later Dyna® models with cast wheel option and '07-later FLHRSE3/4). Dual disc models require purchase of two kits.

**46647-05** Rear. **\$13.95**

Fits '92-later models (except XR and Trike).

**I. REAR BRAKE RESERVOIR COVER**

Dress the remote brake fluid reservoir with a new chrome skin. Kit includes chrome top cover with Bar & Shield medallion, reservoir side cover, chrome hardware and a Torx wrench for easy installation.

**45424-08** Fits '07-later XL models. **\$31.95**

**45762-04** Fits '04-'06 XL models. **\$31.95**

**J. CHROME BANJO BOLT KIT**

Replace the Original Equipment 12-point zinc finish brake-line hardware with brilliant chrome custom tapered banjo bolts.

**41842-06** **\$27.95**

Fits '91-'03 XL, '91-later Dyna (except FXDF), '95-later Softail® and '99-'00 FXR models equipped with single front brake. Does not fit with Banjo Bolt Cover P/N 32715-98.

# 100 SPORTSTER®

## Brakes

### A. CHROME FRONT CALIPER KIT

Add the shine of chrome to your front end with this highly polished Chrome Front Brake Caliper Kit. Manufactured from Original Equipment components for proven performance, these calipers are a great addition to the stock front end or add the finishing touch to a complete custom with chrome wheels, rotors and chrome fork sliders. (Brake pads and pad pins not included.)

**44395-00A** **\$359.95**  
Fits '00-'03 XL and '00-'07 Dyna® and Softail® (except Springer®) models equipped with single disc front brakes.

**44392-00A** **\$789.95**  
Fits '00-'03 XL, '02-'05 VRSC™ and '00-'07 Dyna, Softail and Touring models equipped with dual disc front brakes.

### B. BRAKE BLEEDER AND BANJO BOLT COVERS

#### 1. Brake Bleeder Screw Cover

This cover adds chrome to the unfinished bleeder valve on all stock H-D® calipers. Package of two.

**43834-98** **\$21.95**  
Fits '84-later stock calipers (except XR models).

#### 2. Chrome Banjo Bolt Cover

Die-cast chrome cover provides a custom look to your stock banjo bolts. Fits banjo bolts on front and rear brake master cylinders and front and rear calipers. Installs in seconds.

**32715-98** **\$19.95**  
Fits '84-later models with stock master cylinders and calipers. (Does not fit VRSC™ Rear Master Cylinder, '06-later VRSC calipers, '08-later Touring or '04-later XL models.)

#### Shown with:

#### SMOOTH FULL COVERAGE CALIPER COVERS

These covers provide the easiest and least expensive way to add chrome to the flat black finish of stock brake calipers. They install in minutes without tools.

Fits '84-'99 models.

**43260-98** Front. **\$29.95**

### C. BRAKE CALIPER INSERTS

Easy to install inserts add a finishing touch to the front and rear brake calipers. Select a style that follows your custom direction. Self-adhesive backing.

Fits front and rear calipers on '04-later XL models.

**44620-04** Classic Chrome Collection. **\$13.95**

**42070-07** Skull Collection. **\$13.95**

**1. 44110-04** Sportster® Collection. **\$13.95**

**2. 44621-04** "H-D Motor Co." Logo Collection. **\$13.95**

**3. 44622-04** "Live to Ride" Logo Collection. **\$13.95**

**4. 44623-04** Flames Collection. **\$13.95**

### D. CUSTOM CALIPER BOLT COVER KIT

Complete the custom transformation. This complete kit hides the exposed Original Equipment caliper hardware with machined brass chrome-plated covers. Held firmly in place with an internal retention clip, this easy-to-install kit includes the large and small 12-point bolt covers required to customize a single caliper.

**40955-05** Four Large and Two Small Covers. **\$27.95**  
Fits '00-later front brake calipers (except Springer® models, '04-later XL models, '08-later Touring, '06-later VRSC™ models and models equipped with caliper covers). Also fits rear calipers on '06-later FXST, FXSTB, FXSTS and FLSTSB models.

**40959-05** Three Large and Two Small Covers. **\$22.95**  
Fits '00-later rear brake calipers (except '04-later XL models, '08-later Touring, '06-later FXST, FXSTB, FXSTS and FLSTSB, '06-later VRSC models and models equipped with caliper covers).

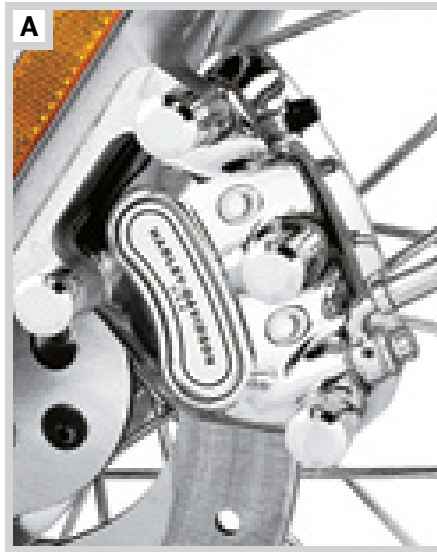

A. CHROME FRONT CALIPER KIT

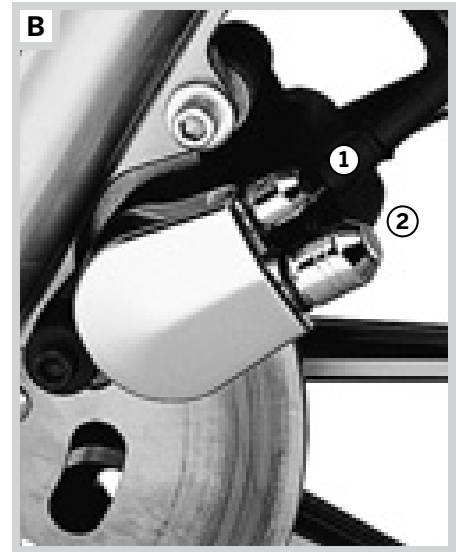

B. BRAKE BLEEDER AND BANJO BOLT COVERS (SHOWN WITH SMOOTH FULL COVERAGE CALIPER COVERS)



C. BRAKE CALIPER INSERT – CLASSIC CHROME



C. BRAKE CALIPER INSERT – SKULL COLLECTION



C. BRAKE CALIPER INSERTS



D. CUSTOM CALIPER BOLT COVER KIT (SHOWN WITH ALUMINATOR BRAKE CALIPER INSERT)

Notice: The prices appearing in this catalog are the manufacturer's suggested retail prices. Actual retail prices may vary.



E. PROFILE LOW FRONT SUSPENSION KIT



F. PROFILE LOW FRONT SUSPENSION KIT



G. PROFILE LOW REAR SHOCK KIT



H. TWO-UP PROFILE LOW REAR SHOCK KIT



I. CHROME H-D MOTOR CO. LOGO SHOCK TOWER COVER KIT



J. XL BELT-DRIVE TRANSMISSION SPROCKET KITS (SHOWN WITH BELT AND DEBRIS DEFLECTOR - SOLD SEPARATELY)

**E. PROFILE® LOW FRONT SUSPENSION KIT\***

This kit is designed to lower the front suspension by approximately 1" while preserving the ride quality. The shorter fork springs are progressively wound to allow a compliant, controlled ride. Kit includes two fork springs and damper tubes.

**45500-09** **\$99.95**

Fits '09-later XL883, XL883C, XL883R, XL1200C and XL1200R models. '09-later XL883, XL883R and XL1200R models must also have Low Rear Shock Kit P/N 54754-09 installed.

**F. PROFILE LOW FRONT SUSPENSION KIT\***

Original Equipment on the '04-'06 XL883L and '06-'08 XL1200L, this kit is designed to lower the front suspension by approximately 1" while preserving the ride quality. The shorter fork springs are progressively wound to allow a compliant, controlled ride. Kit includes two fork springs and damper tubes.

**45480-05** **\$99.95**

Fits '04-'08 XL models (except '07-'08 XL883L and XL1200N). Stock on '04-'06 XL883L and '06-'08 XL1200L models. XL883, XL883R, and XL1200R models must also have Low Rear Shock Kit P/N 54750-05A, 54731-04, or 54733-04 installed.

**G. PROFILE LOW REAR SHOCK KIT\***

Plant your feet firmly on the ground. This reduced length version of the Original Equipment rear suspension lowers the seat height by approximately 1". Shocks feature chrome-plated springs and body caps, and suspension preload is adjustable for rider and passenger load.

**54754-09** **\$219.95**

Fits '06-later XL883, XL883R and XL1200R models. Stock on '09-later XL883C, XL1200L and XL1200C models. Kit includes shorter jiffy stand.

**54733-04** **\$219.95**

Fits '91-'05 XL883, XL883DLX, XL883R and XL1200 models. Does not lower XL Custom, XL883L, XL1200L, XL 50th Anniversary or Hugger® models.

**H. TWO-UP PROFILE LOW REAR SHOCK KIT\***

These heavy-duty shocks are tuned for the touring rider carrying a passenger or loaded saddlebags. Shock length and spring rate are engineered to maintain the factory low seat height. The chrome-bodied shocks feature adjustable preload for a comfortable, controlled ride.

**54704-07** **\$184.95**

Fits '07-later XL883L, XL883N and XL1200N models.

**I. CHROME "H-D MOTOR CO." LOGO SHOCK TOWER COVER KIT**

These Chrome Upper Shock Covers are designed to replace your stock polished aluminum covers, and complement the chrome-plated fender strut covers.

**54616-96** **\$22.95**

Fits '90-'03 XL models (except XL1200 Sport). (Does not fit Profile Shocks.) (sold in pairs)

**J. XL BELT-DRIVE TRANSMISSION SPROCKET KITS**

**40202-91B** **\$241.00**

Fits '91-'03 XL models. Stock on '91-later XL1200. (29-tooth sprocket)

**40285-91B** **\$241.00**

Fits '91-'03 XL models. Stock on '91-'04 XL883. (27-tooth sprocket)



**\*WARNING:** Installation of any accessory suspension components may affect cornering clearance and jiffy stand operation. This could distract the rider, causing loss of control and death or serious injury.

Notice: The prices appearing in this catalog are the manufacturer's suggested retail prices. Actual retail prices may vary.

# 102 SPORTSTER®

## Hand Controls

### A. MINI APE HANDLEBAR – SATIN BLACK\*

Raise your fists to the wind. This 12" high, 1" diameter Mini Ape Handlebar features a conservative rise and bend for rider comfort, and a matte black finish that complements the aggressive look of the Nightster® and Street Bob® models.

**56075-07 \$69.95**

Fits '04-later XL883L, XL883N, XL1200L and XL1200N models. Also fits '06-later FXDB and '96-'05 FXDWG models with Original Equipment Handlebar P/N 58079-93. XL models require separate purchase of additional components.

#### XL Models Require:

Diamond-Black Brake Line P/N 46720-09

Diamond-Black Clutch Cable P/N 38911-09A

Diamond-Black Throttle/Idle Cable P/N 38913-09

Switch Wire Extension Kit P/N 70234-07

Turn Signal Wire Extension Kit P/N 72137-03

### B. PULL BACK HANDLEBAR

This chrome handlebar is designed to bring the controls closer to the rider for increased comfort. Especially helpful for shorter riders or for riders that prefer a close-to-the-bar riding position.

**56021-04B \$99.95**

Fits '04-later XL883C and XL1200C models. Installation requires separate purchase of additional components.

#### XL Custom models require:

Braided Stainless Brake Line P/N 45113-03

Braided Stainless Clutch Cable P/N 38732-04

Braided Stainless Throttle/Idle Cable P/N 56340-04 ('04-'06 models)

Braided Stainless Throttle/Idle Cable P/N 56360-09 ('07-'10 models)

### C. CUSTOM BRAIDED CONTROL CABLES AND BRAKE LINES

Dress your bike for maximum custom impact. Harley-Davidson offers a choice of three braided cable finishes to match your customizing style.

Throttle and idle cable kits offer great looks and a smooth, precise action. Internal anti-friction inserts and cable pre-lubrication ensure long life and consistent performance. Kit includes throttle cable, idle cable and any necessary installation hardware.

Clutch cable kits feature anti-friction inserts and factory pre-lubrication to ensure smooth, long lasting cable operation. The internal cable seal eliminates the possibility of transmission fluid leaks, and the exclusive silicone boot attractively and effectively protects the cable adjuster components from moisture. Kit includes clutch cable, adjuster boot, and any necessary installation hardware.

Brake lines are offered in a choice of three braided brake line finishes to match your customizing style. Kits for dual disc models consist of three brake lines with a chrome-plated junction tee, while kits for single disc models consist of a single line.

*Refer to the Multi-Fit section pages 607–615 for specific model requirements.*

\*NOTE: Installation of some handlebars and risers may require a change in clutch and/or throttle cable and brake hose for some models. Handlebar height is regulated in many states. Check state or local laws before installation.

Notice: The prices appearing in this catalog are the manufacturer's suggested retail prices. Actual retail prices may vary.



A. MINI APE HANDLEBAR – SATIN BLACK



B. PULL BACK HANDLEBAR (SHOWN WITH BRAIDED STAINLESS CABLES AND BRAKE LINES)



C. CUSTOM BRAIDED CONTROL CABLES AND BRAKE LINES – DIAMOND-BLACK SHOWN



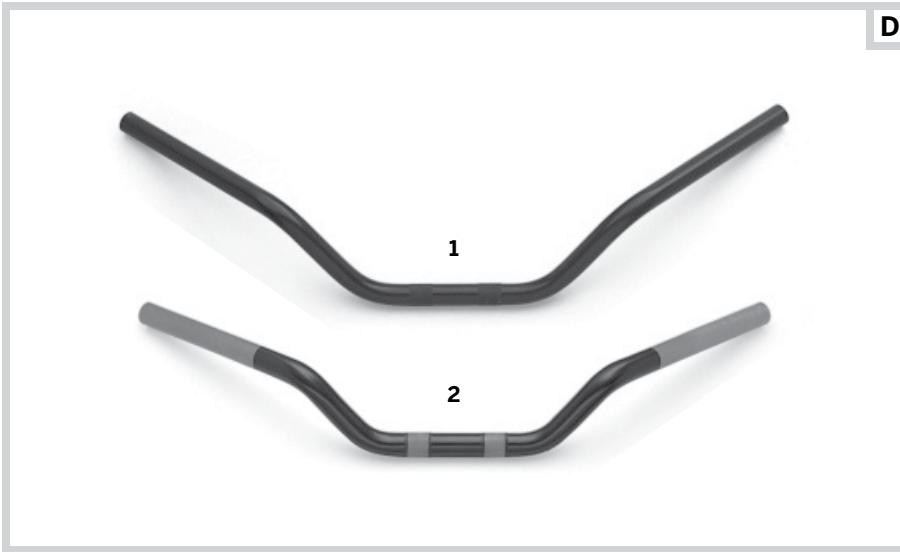

D. BLACK HANDLEBARS

**D. BLACK HANDLEBARS\***

Pick from a variety of handlebars to fit your riding style. These bars are made from high-quality steel for strength and durability.

- |   |                |
|---|----------------|
| <b>1. 56085-83A</b>   | <b>\$53.95</b> |
| Fits most XL models (except 883C/1200C). Stock on XL1200N, XL883R, and XR1200 models. |                |
| <b>2. 56110-98</b>  | <b>\$56.95</b> |
| Fits most XL models (except 883/1200C). Stock on '98-'03 XL1200 Sport models.         |                |

**E. CHROME HANDLEBARS\***

Chrome-plated handlebars are designed to be exact replacements for the Original Equipment stainless steel handlebars.

- |   |                |
|---|----------------|
| <b>1. 56085-83T</b>   | <b>\$69.95</b> |
| Fits XL and FXD models equipped with P/N 56085-83 or 56004-00 as Original Equipment.          |                |
| <b>2. 56082-83T</b>   | <b>\$69.95</b> |
| Fits XL and FXR models equipped with P/N 56082-83 as Original Equipment.                      |                |
| <b>3. 56081-82T</b>   | <b>\$69.95</b> |
| Fits FLHS, XL, FX, FXR, FXD and FXST models equipped with P/N 56081-82 as Original Equipment. |                |

**F. CUSTOM HANDLEBARS\***

**1. Chrome Longhorn Handlebar**  
Slightly wider and lower than stock. Bolt-on replacement for stock handlebar on listed models. Made in the U.S.A.

~~56556-95 ————— \$69.95~~  
Fits XL1200, Deluxe, Hugger, FXD, FXDL, FXR, FXRS, and FXSTC models equipped with Buckhorn Handlebar P/N 56081-82. (Does not fit models with Air Reservoir Style Handlebars.) **OBSOLETE**

**2. Chrome Ape Hangers Handlebar**

Traditional Ape Hangers now available for Sport models. Bolt-on replacement for stock handlebar on listed models. Made in the U.S.A.

**56563-95** ————— **\$69.95**  
Fits XL1200, Deluxe, Hugger, FXD, FXDL, FXRS, FXR models equipped with Buckhorn Handlebar P/N 56081-82. (Does not fit models with Air Reservoir Style Handlebars.)

**3. Chrome Drag Bar**

The traditional flat Drag Bar now available for Custom applications. Combine with our straight or curved chrome risers for an exceptional look. Made in the U.S.A.

**56558-95** ————— **\$69.95**  
Designed for Custom applications or stock replacement on '99-later FXSTB, '99-'03 XL883 Custom and '99-'03 XL1200 Custom models.

**4. Sportster Sport Handlebar**

Lower and wider than stock bars, they install using all stock cables, hoses and wiring.

Fits '96-'03 XL1200, XL1200S and '86-'03 XL883 models (except '99-'03 XL883C).

**56113-98** — Black. ————— **\$69.95**  
~~56473-98 — Chrome. (not shown) — OBSOLETE — \$69.95~~

**G. CHROME RISER CUP WASHER KIT**

Add a finishing touch to the riser on your bike. This kit includes two styled and chrome-plated washers that replace the standard metal washers below the handlebar risers. Replaces Original Equipment P/N 56159-73.

**56486-01** ————— **\$23.95**  
Fits many XL (except '04-later XL models), Dyna® and Softail® models. See your Dealer for specific model application. Does not fit with Polyurethane Handlebar Bushing P/N 56165-03.

**H. POLYURETHANE HANDLEBAR RISER BUSHINGS**

These Handlebar Riser Bushings replace the Original Equipment stacked rubber and zinc washer combination with a molded one-piece polyurethane bushing and chrome cover. The long-lasting bushing can reduce handlebar vibration, and the chrome cover adds a bright finishing touch.

**56165-03** ————— **\$39.95**  
Fits '97-'03 XL, '86-later Dyna® (except FXDB) and Softail® (except Springer® and FXSTD) models. '86-'93 FL Softail models require use of '94-later Riser Bolts. Will not fit with Chrome Riser Cup Washer Kit P/N 56486-01.

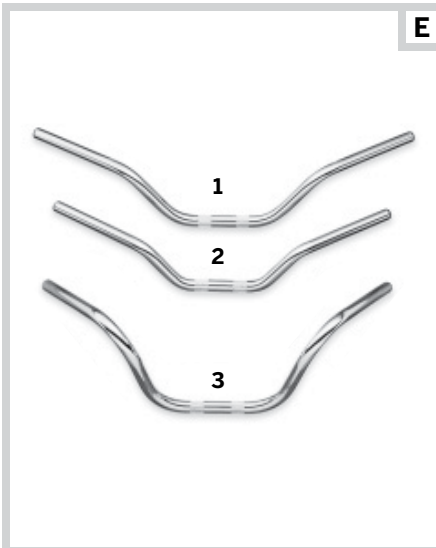

E. CHROME HANDLEBARS



F. CUSTOM HANDLEBARS



G. CHROME RISER CUP WASHER KIT



H. POLYURETHANE HANDLEBAR RISER BUSHINGS

# 104 SPORTSTER®

## Hand Controls

### A. CHROME CLUTCH BRACKET AND MASTER CYLINDER RESERVOIR KIT

Replace your stock painted aluminum controls with brilliant chrome, without compromising quality. This kit is manufactured from the Original Equipment components and includes Chrome Master Cylinder Cover. When combined with Chrome Switch Housing Kit, Chrome Switch Caps, and other Genuine Motor Accessories, this front brake control kit provides a look that does more than stop your bike – it can stop traffic.

**42307-07** **\$329.95**  
Fits '07-later XL models with single disc front brakes.

**42307-04** **\$349.95**  
Fits '04-'06 XL models with single disc front brakes.

**45284-99D** **\$329.95**  
Fits '96-'03 XL, '96-'05 Dyna® and Softail® models with single disc front brakes. (Does not fit models equipped with hydraulic clutch.)

**45281-99D** **\$329.95**  
Fits '96-'03 XL, '96-'05 Dyna, Softail and '96-'04 Touring models with dual disc front brakes. (Does not fit models equipped with hydraulic clutch.)

### B. CHROME MASTER CYLINDER COVER

Includes one chrome-plated cover, gasket and decal. Easily installed with included stainless steel screws.

**42313-07** Fits '07-later XL models. **\$39.95**

**42313-04** Fits '04-'06 XL models. **\$39.95**

**45078-96D** **\$34.95**  
Fits '96-'03 XL, '02-'05 VRSC™, '96-'05 Dyna, Softail and '96-'04 Touring models.

### C. CHROME SWITCH HOUSING KIT

Convert your housings from black to chrome with this complete kit. Includes left, right, upper and lower housings. No switches or wiring required. Installation instructions included.

**70222-96B** **\$139.95**  
Fits '96-later VRSC, XL, XR, Dyna, Softail and FLHR Road King® models. Does not fit FXSTDSE and FLHRSEI2 models.

#### Shown with:

#### CHROME SWITCH CAP KIT

Not satisfied until everything you see is chrome? This Chrome Switch Cap Kit will add style to one of the most visible areas of your bike, the switches. Shaped for the same ergonomic feel as the Original Equipment hand control switches, these caps replace the stock black caps without re-wiring. The chrome switch caps complement other chrome hand control accessories (Chrome Master Cylinder Kit, Chrome Hand Levers, Chrome Switch Housings, and Chrome Master Cylinder Cover) to complete the custom look.

**71804-03** **\$18.95**  
Fits '96-later XL, XR, Dyna, Softail and FLHR models, '02-later VRSC models, and '98-'01 FLHRC models. FLHR models equipped with cruise control use Kit P/N 71808-03.

### D. CHROME HAND CONTROL LEVER KIT

Continue the chrome theme with these Hand Control Levers. Cast from aluminum, these levers feature a custom finish designed to match the accessory chrome hand controls or complement Original Equipment-style black components. Clutch anti-rattle clip and new pivot bushings included.

**44992-07** **\$109.95**  
Fits '04-later XL and XR models.

**45075-07** **\$99.95**  
Fits '96-'03 XL models and '96-'07 Dyna, Softail® and Touring models. (Does not fit police models, VRSC models, or models equipped with hydraulic clutch.)

### E. BLACK HAND CONTROL LEVER KIT

Grab some black with these levers – a natural fit for black accessory handlebars or to further the blacked-out look of your motorcycle. A clutch anti-rattle clip and new pivot bushings are included.

**46944-07A** **\$79.95**  
Fits '04-later XL and XR models.

**44994-07** **\$99.95**  
Fits '96-'03 XL models and '96-'07 Dyna, Softail and Touring models (Does not fit police models, VRSC models, or models equipped with hydraulic clutch.)



A. CHROME CLUTCH BRACKET AND MASTER CYLINDER RESERVOIR KIT ('04-LATER MODELS)



A. CHROME CLUTCH BRACKET AND MASTER CYLINDER RESERVOIR KIT ('96-'03 MODELS)



B. CHROME MASTER CYLINDER COVER ('04-LATER MODELS)



C. CHROME SWITCH HOUSING KIT (SHOWN WITH CHROME SWITCH CAP KIT)



D. CHROME HAND CONTROL LEVER KIT

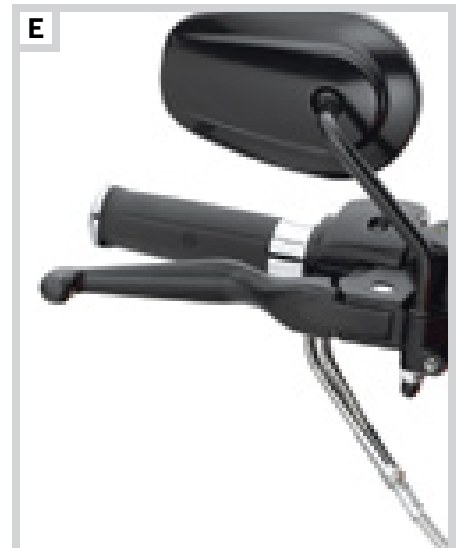

E. BLACK HAND CONTROL LEVER KIT



**F. CHROME UPPER FORK STEM COVERS**



**G. CLASSIC CHROME STEERING STEM BOLT COVER KIT**



**H. CHROME HANDLEBAR CLAMP HARDWARE KIT**



**I. BILLET BRAKE LINE CLIP**



**J. CHROME THROTTLE CABLE CLIP**



**K. CHROME BILLET CLUTCH CABLE CLAMP**

**F. CHROME UPPER FORK STEM COVERS**

Highlighted with a unique Bar & Shield logo, these polished triple chrome-plated covers add an additional clean looking appearance to your upper fork. Kit comes complete with three covers, mounting hardware and wrench for easy on-the-spot installation.

**46129-98B** **\$48.95**

Fits '86-later FLSTC, '90-later FLSTF, '95-'05 FXD, '93-'05 FXDL, '94-'05 FXDS-CONV., and '88-later XL models (except XL Custom and XL1200S models).

**G. CLASSIC CHROME STEERING STEM BOLT COVER KIT**

For a finished appearance of the upper fork clamp on all models with 39mm forks.

**48329-90A** **\$31.95**

Fits XL, Dyna, and FXR models with 39mm forks. (Does not fit FXDWG.)

**H. CHROME HANDLEBAR CLAMP HARDWARE KIT**

Finish the show-winning look with brilliant chrome hardware. Manufactured to Original Equipment specifications, this kit replaces the zinc-plated exposed handlebar clamp bolts with chrome-plated socket head cap screws.

**94453-05** **\$8.95**

Fits '95-later XL models (except XL Custom, XL883N, XL1200L and XL1200N), and '94-'05 FXD, FXDC, FXDX, FXDXT and FXDS-CONV. models.

**94454-05** **\$8.95**

Fits XL1200L, XL1200N, '96-'06 XL883C and XL1200C, '07-later Dyna®, '00 FXR4, FLSTFSE/2 and '10 FLSTSE models.

**I. BILLET BRAKE LINE CLIP**

It's the details that count. Replace the Original Equipment black brake line clamp with this beautifully chrome-plated billet aluminum clip. Sized for Original Equipment or accessory braided brake lines, these "ball-milled" clips mount in the factory position for easy installation. Kit includes chrome-plated mounting hardware.

**91369-03** **\$21.95**

Fits '00-later XL and Dyna® (except FXDWG) models equipped with Harley-Davidson® Braided Brake Lines. Also fits '08-later Dyna models (except FXDWG) with Original Equipment brake lines.

**J. CHROME THROTTLE CABLE CLIP**

Tie up the loose ends to complete your custom ride. When matched to Original Equipment black cables or available braided cables, these chrome-plated clips link the throttle/idle cables with brilliant chrome.

**91274-04** **\$29.95**

Fits '84-later models (except '08-later Touring).

**K. CHROME BILLET CLUTCH CABLE CLAMP**

The perfect addition to braided or stock black clutch cables. This Clutch Cable Clamp is machined from aluminum billet, and polished and plated for a lasting shine. The clamp is designed to grip the cable and the frame down tube, adding a custom look to the front of your cycle.

**91249-04** **\$39.95**

Fits '04-later XL and '09-later Touring models with 1-3/8" diameter front frame down tube.

**91147-02** **\$39.95**

Fits models with 1-1/4" diameter front frame down tube (except Touring, '04-later XL, '08-later XR and '06-later Dyna models).

# 106 SPORTSTER®

## Foot Controls

### A. FORWARD CONTROL KIT FOR SPORTSTER® MODELS\*

Add the stretched-out look and extended riding position to your Sportster® model. The complete kit includes all hardware necessary to convert your Sportster model from mid controls to forward controls. Available in black, polished or brilliant chrome-plated finish, these forward controls add style and long range comfort. Polished version is stock on XL Custom models. (Footpegs and shifter peg not included.)

Fits '06-later XL models with mid controls. XL 1200L models require separate purchase of Footpegs P/Ns 33134-07CAZ and 33135-07CAZ.

<b>33395-06A</b>	Chrome.	<b>\$449.95</b>
<b>33398-06A</b>	Polished.	<b>\$349.95</b>
<b>33397-07A</b>	Black.	<b>\$399.95</b>

Fits '04-'05 XL models. (Does not fit with 2-into-1 Exhaust Systems.)

<b>33395-04</b>	Chrome.	<b>\$449.95</b>
<b>33398-04</b>	Polished.	<b>\$349.95</b>

Fits '91-'03 XL (except 883R). (Does not fit with 2-into-1 Exhaust Systems.) Current owners of Engine Guard P/N 49018-88A and 49018-88B will need to purchase bracket P/N 49014-86A for proper fitment (*sold separately*). This kit will not fit on vehicles equipped with an early style engine guard. Use Engine Guard Kit P/N 49018-88C when adjustable highway peg supports are installed.

<b>33891-98</b>	Chrome.	<b>\$489.95</b>
<b>33892-98</b>	Polished.	<b>\$399.95</b>

### B. CHROME FORWARD CONTROL FOOTREST SUPPORT

Upgrade the look of your stock black forward controls with these mirror-finish chrome brackets. Manufactured from Original Equipment components to ensure proper fit and function, these polished and plated support brackets add a custom touch to your Sportster Custom motorcycle.

<b>42705-04</b>	<b>\$94.95</b>
-----------------	----------------

Fits '04-later XL883C and XL1200C models.

### C. BLACK BRAKE AND SHIFT LEVER KIT

Give your Nightster™ model a sinister look. These flat black-finished versions of the Original Equipment foot brake and shift levers complement the blacked-out look of the Nightster, 1200 Low, 883R and 1200R models.

<b>42930-07</b>	<b>\$109.95</b>
-----------------	-----------------

Fits '04-later XL models with mid controls.

### D. HIGH POLISH BRAKE LEVER

We've taken the stock brake lever and highly polished it for added styling. Kit includes bushing for easy installation.

<b>42447-96</b>	<b>\$69.95</b>
-----------------	----------------

Fits '87-'03 XL models (except models equipped with forward controls). Standard on '97-'98 XL883C models.

Shown with:

### CHROME GEAR SHIFT LEVER FOR SPORTSTER® MODELS

Shift in style with this brilliant, chrome-plated shift lever. Complete the look with a custom shifter peg.

<b>34615-94</b>	<b>\$59.95</b>
-----------------	----------------

Fits '91-'03 XL models (except models equipped with Forward Controls).



A. FORWARD CONTROL KIT FOR SPORTSTER MODELS – BLACK

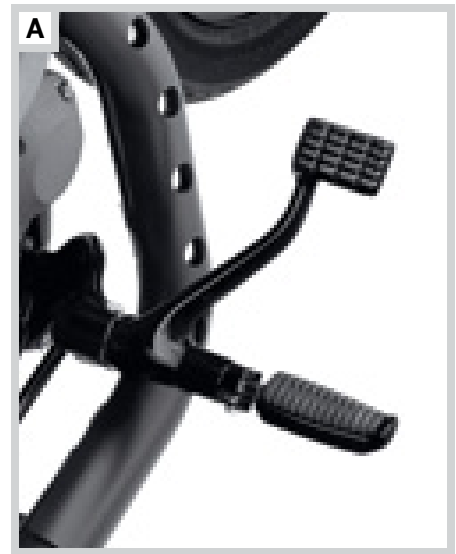

A. FORWARD CONTROL KIT FOR SPORTSTER MODELS – BLACK



A. FORWARD CONTROL KIT FOR SPORTSTER MODELS – CHROME



B. CHROME FORWARD CONTROL FOOTREST SUPPORT



C. BLACK BRAKE AND SHIFT LEVER KIT



D. HIGH POLISH BRAKE LEVER (SHOWN WITH CHROME GEAR SHIFT LEVER)



**\*WARNING:** Installation of accessory Forward Control Kits may affect cornering clearance. This could distract the rider, causing loss of control, resulting in death or serious injury.

Notice: The prices appearing in this catalog are the manufacturer's suggested retail prices. Actual retail prices may vary.



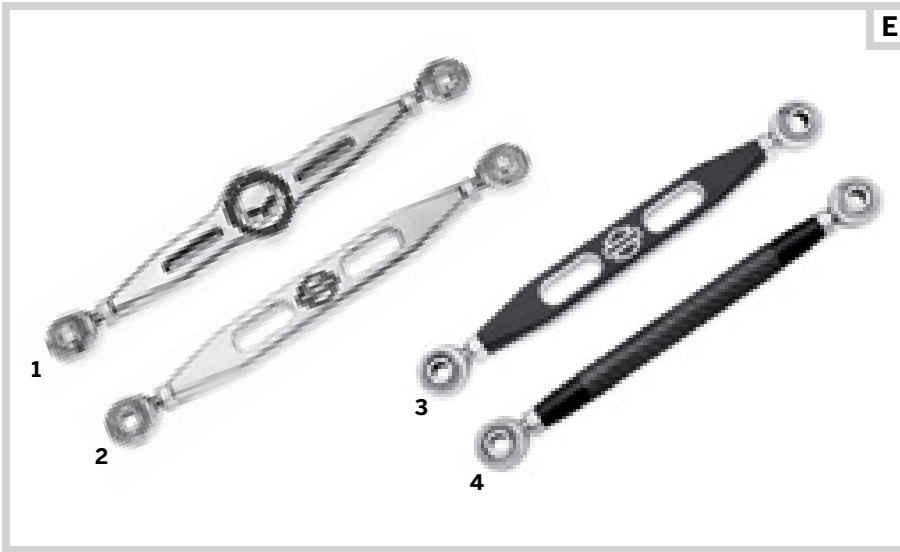

E. CUSTOM GEAR SHIFT LINKAGES

**E. CUSTOM GEAR SHIFT LINKAGES**

Kick your custom into gear with this collection of high quality custom shift linkages. Available in a variety of designs to match your bike's style, these linkages feature aircraft quality rod ends for easy adjustment and smooth operation. The easy-to-install linkage kit includes a transmission lever cover and decorative acorn nuts and bolts for a complete custom look. Easy-to-install.

Fits '04-later XL models equipped with forward controls.

<b>1. 34840-09</b>	Skull.	<b>\$99.95</b>
<b>2. 34586-09</b>	Slotted with Bar & Shield Logo.	<b>\$99.95</b>
<b>3. 33778-09</b>	Black Anodized Slotted Linkage.	<b>\$99.95</b>
<b>4. 33930-09</b>	Diamond Black Linkage.	<b>\$99.95</b>

**F. PASSENGER FOOTPEG MOUNT KIT**

A necessary addition when converting your solo seat XL883 to a two-up passenger-carrying ride. Kit includes black mounting brackets, Original Equipment-style footpegs, and all necessary mounting hardware.

**50203-04** **\$94.95**

Fits '04-later XL models. XL883, XL883L, XL883N and XL1200N models require separate purchase of four Screws P/N 4748.

**G. CHROME PASSENGER FOOTPEG SUPPORT**

Nicely complements any of the passenger footpeg kits. We've taken the Original Equipment black painted component to ensure product quality, and polished and chrome-plated it for a great look. Footpegs sold separately.

**49322-04** **\$94.95**

Fits '04-later XL models. XL883, XL883L, XL883N and XL1200N models require separate purchase of four Screws P/N 4748.

**H. CHROME PASSENGER FOOTPEG MOUNTING KIT**

**50610-86T** Fits '82-'03 XL models. **\$29.95**

**I. ADJUSTABLE PASSENGER FOOTPEG MOUNT KIT**

Maximize your passenger's riding comfort. Proper foot position reduces the cramped or stretched-out feeling, and relieves pressure on the knees and the tail bone. These Adjustable Mounts raise and lower the passenger footpeg to accommodate taller and shorter passengers. Easy to adjust with common tools, the mount adjusts through a 360° range (depending on model), allowing both fore and aft and up and down height adjustment. Kit includes left and right adjustable support assembly and all required mounting hardware. Footpegs sold separately.

**50763-09** **\$149.95**

Fits models with H-D male mount style passenger footpeg supports (except Softail models). Does not fit with Heel Raiser Footpeg Kit P/N 50178-09. Does not fit the rider position.



F. PASSENGER FOOTPEG MOUNT KIT



G. CHROME PASSENGER FOOTPEG SUPPORT



H. CHROME PASSENGER FOOTPEG MOUNTING KIT



I. ADJUSTABLE PASSENGER FOOTPEG MOUNT KIT

Notice: The prices appearing in this catalog are the manufacturer's suggested retail prices. Actual retail prices may vary.

# 108 SPORTSTER®

## Foot Controls & Highway Pegs

### A. ADJUSTABLE HIGHWAY PEG SUPPORT KIT\*

So you're not your average Sportster® motorcycle rider. But then again, there is nothing average about Harley-Davidson®. These chrome-plated Highway Peg Supports adjust easily and quickly into three height-accommodating positions. Use with your choice of H-D® small Male-Mount-Style footpegs (not included). Includes all necessary hardware.

**49053-04A** **\$199.95**  
Fits '04-later XL models with mid controls.

**49053-96A** **\$199.95**  
Fits '84-1/2-'03 XL models alternator style (except '99-later XL883C and XL1200C models).

### B. HEEL RAISER FOOTPEG KIT

Comfort and cool, clean looks in one. Heel Raiser Chrome and Rubber Footpegs provide a large surface area that lets you change foot position for maximum comfort, and the fold-out heel rest provides floorboard-style support that relieves calf and thigh tension on the highway. The heel rest can be deployed or retracted with your boot while riding. The sole-gripping horizontal black rubber bands complement the mirror-chrome finish, and add vibration isolation and a rich appearance to the pegs. Complete the look with Shifter Pegs and Brake Pedal Pads from the Chrome and Rubber Collection. Heel Raiser mounts to the standard H-D style footpeg support, so it can be used in many rider and passenger applications.

**50178-09** **\$189.95**  
Fits H-D® male mount style footpeg supports (except the rider position on '02-later VRSCD/DX/F/R/X, '07-later XL883L, XL883N, XL1200N, '09-later XR, '08-later FXCW/C, and passenger position on Softail® models). Fits mid-control equipped XL and Dyna® models when equipped with engine guards and Highway Peg Mount P/N 50964-98 or 50957-02B. Does not fit with Adjustable Passenger Footpeg Support P/N 50763-09 or 50787-09, or Whiskers Adjustable Highway Bar P/N 50855-09 and 50865-09. Does not fit mid-control position.

### C. MINI FOOTBOARD KIT

This Mini Footboard Kit can be installed in place of traditional footpegs and provides a little additional leg support and more options to move your feet around on a long run. Mini Footboards mount to standard H-D style footpeg supports, and can be used in many rider and passenger applications. A little larger than a bicycle pedal, Footboards can be pivoted to the proper angle for maximum riding comfort. The sole-gripping horizontal black rubber bands complement the mirror-chrome finish, and add vibration isolation and a rich appearance to the pegs. Complete the look with Shifter Pegs and Brake Pedal Pads from the Chrome and Rubber Collection.

**50451-09** **\$109.95**  
Fits models with forward controls (except FXCW/C, VRSCDX and VRSCF). Does not fit with mid-controls or with Frame Mounted Highway Pegs P/N 50855-09 and 50865-09. Fits Passenger male mount style Footpeg supports on most models (except '03-earlier XL, '06-earlier VRSC™, '05-earlier Dyna, and FXSTD, FLSTSB, FLSTF, FLSTN and Softail models with shotgun exhaust). Softail passenger position also requires Support Kit P/N 50454-09.

### D. JIFFY STAND EXTENSION

Park it quick and easy with this chrome-plated Jiffy Stand Extension. Makes locating and maneuvering your jiffy stand easier.

**50250-04** **\$44.95**  
Fits '04-later XL883C, XL1200C and XL1200L models.

**50212-98** **\$44.95**  
Fits '84-'03 XL models (except 883 Hugger® and '92-'99 XL Custom models).



A. ADJUSTABLE HIGHWAY PEG SUPPORT KIT

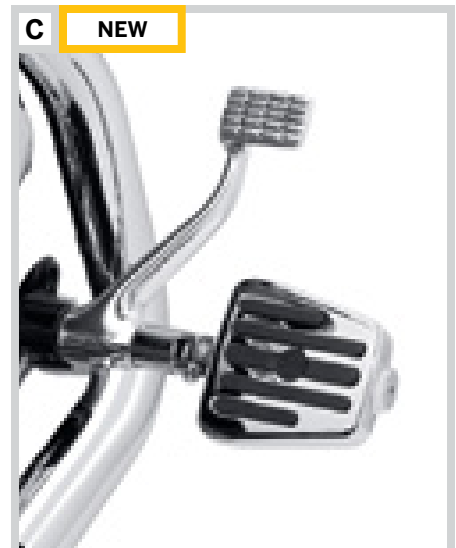

B. HEEL RAISER FOOTPEG KIT

C. MINI FOOTBOARD KIT

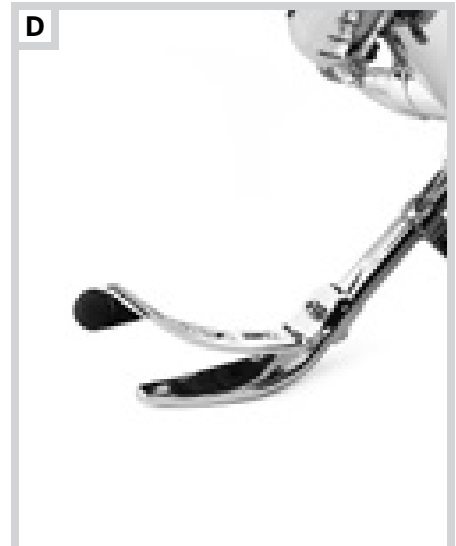
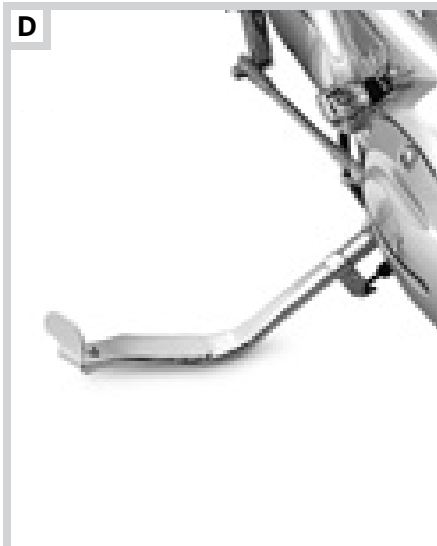

D. JIFFY STAND EXTENSION ('04-LATER MODELS)

D. JIFFY STAND EXTENSION ('84-'03 MODELS)



**\*WARNING:** Do not use highway pegs under normal stop and go operating conditions. Doing so could result in death or serious injury.

Notice: The prices appearing in this catalog are the manufacturer's suggested retail prices. Actual retail prices may vary.

# SPORTSTER® 109

Engine Guards

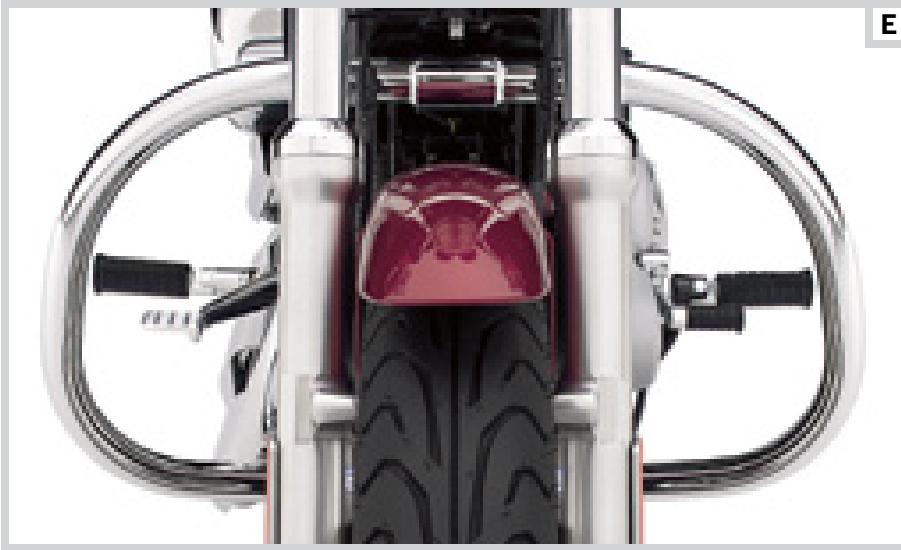

E

## E. ENGINE GUARD\*

The unique soft curve shape adds style to function. The one-piece Engine Guard is designed to complement the lines of the Sportster® motorcycle, and the choice of finishes adds the perfect finishing touch.

Fits '04-later XL and XR models. (Will not fit with Front Spoilers.)

<b>49060-04</b>	Chrome.	<b>\$209.95</b>
<b>49215-07</b>	Gloss Black.	<b>\$209.95</b>

## F. CHROME ENGINE GUARD\*

This highly polished, chrome-plated guard matches stock plating and works great with the Sportster® Forward Controls.

**49018-88C** **\$209.95**

Fits '84 1/2-'03 XL models. (Will not fit with Front Spoilers.)

(NOTE: '82-early '84 models require Bracket P/N 49014-85.)

SPORTSTER

E. ENGINE GUARD – CHROME



E

E. ENGINE GUARD – GLOSS BLACK



F

F. CHROME ENGINE GUARD



**\*WARNING:** Engine guards may provide limited leg and cosmetic vehicle protection under unique circumstances (fall over while stopped, very low speed slide). They are not made nor intended to provide protection from bodily injury in a collision with another vehicle or any other object.

Notice: The prices appearing in this catalog are the manufacturer's suggested retail prices. Actual retail prices may vary.

# 110 SPORTSTER®

Console & Gauges

## A. 4" COMBINATION SPEEDOMETER/TACHOMETER – COLOR-MATCHED LIGHTING

Now available for 4" Speedometer applications. This unique Combination Speedometer/Tachometer allows you to monitor engine speed without adding a handlebar-mounted tach. The unit mounts in the stock 4" gauge opening and is a direct plug-in installation. Utilizing the trip reset push-button, the multi-color LED lighting system allows the rider to adjust the backlighting of the gauge to the color of choice. With over 600 color tone options, the gauge lighting can be matched to any paint scheme or viewing preference. The gauge features an easy-to-read LCD odometer/tripmeter. Mileage reinstatement is available through your Dealer.

**74726-08** \$499.95

Fits '07-later XL models. '07 models require separate purchase of Resistor Pack P/N 72545-08.



A. 4" COMBINATION SPEEDOMETER/TACHOMETER – COLOR-MATCHED LIGHTING

## B. 2-5/8" MINI TACH KITS WITH SHIFT LIGHT

Now available with an attention-grabbing rider-selectable shift light, these chrome-plated, 0-8,000 RPM mini tachometers add style and function. Measuring 2-5/8 inches in diameter, these chrome-plated tachs boast superior illumination and high-quality construction. The hard-coated lens is both fog and scratch-resistant and is ultrasonically welded to the case, resulting in a strong, reliable seal. These tach kits deliver impressive accuracy and response. Our exclusive, balanced pointer design allows for a quick, precise needle sweep and minimal low idle flutter. Plus, reverse polarity and over-voltage protection ensures these quality tachs are immune to voltage surges, low-voltage interference and ignition coil inductive kick-back. Complete wiring, hardware, and installation instructions are included. (NOTE: Mini Tach Kits are not compatible with Windshield Bags.)

Fits '96-'03 and '07-later XL Custom, '96-later FXDWG, '06 FXD35, '07-later FXDC, '08-later FXDF, '84-later FX Softail®, (except FXCW/C) '86-later FL Softail (except '07-later FLSTF and FLSTFB), and '94-later Road King® models equipped with Mini Tach Mounting Bracket. Separate purchase of application-specific Mounting Brackets and Gauge Housing is required.

**69829-06** Black Face. \$229.95

**69828-06** Spun Aluminum Face. \$229.95



B. 2-5/8" MINI TACH KIT WITH SHIFT LIGHT – BLACK FACE



B. 2-5/8" MINI TACH KIT WITH SHIFT LIGHT – SPUN ALUMINUM FACE

## C. 2-5/8" MINI TACH MOUNTING BRACKET

Polished and plated to a brilliant shine, this steel bracket is designed to mount a 2-5/8" Mini Gauge at the ideal viewing angle. Designed for specific applications, these brackets are easy-to-install, and do not interfere with hand controls or indicator lights. Gauge installation requires separate purchase of Gauge Housing.

**69426-04** \$49.95

Fits '04-later XL Custom models. Not compatible with Windshield Bags.



C. 2-5/8" MINI TACH MOUNTING BRACKET



D. 2-5/8" BLACK FACE MINI TACH KIT

## D. 2-5/8" MINI TACH KITS

Add style and function with these chrome-plated, 0-8,000 RPM mini tachometers. Measuring 2-5/8 inches in diameter, these chrome-plated tachs boast superior illumination and high-quality construction. Complete wiring, hardware, and installation instructions are included. (NOTE: Mini Tach Kits are not compatible with Windshield Bags.)

Fits '96-'03 and '07-later XL Custom, '96-later FXDWG, '06 FXD35, '07-later FXDC, '08-later FXDF, '84-later FX Softail® (except FXCW/C), '86-later FL Softail (except '07-later FLSTF and FLSTFB), and '94-later Road King® models equipped with Mini Tach Mounting Bracket. Separate purchase of application-specific Mounting Brackets and Gauge Housing is required.

**68953-04** Black Face. \$209.95



E. MINI TACH CYLINDRICAL GAUGE HOUSING



F. MINI TACH TAPERED GAUGE HOUSING

## E. MINI TACH CYLINDRICAL GAUGE HOUSING

Finish your gauge installation in style. Chrome-plated steel housing features a flat bottom and cylindrical shape for a traditional appearance.

**67523-04** \$59.95

Fits models equipped with 2-5/8" Mini Tach and appropriate mounting bracket.

## F. MINI TACH TAPERED GAUGE HOUSING

Housing features a "tapered look" to dress up the Mini Tach for a sleek appearance. Easy replacement for the original Mini Tach gauge housing.

**67524-04** \$24.95

Fits models equipped with 2-5/8" Mini Tach and appropriate mounting bracket.





NEW

G

G. SPORTSTER FUEL GAUGE KIT – CHROME



NEW

G

G. SPORTSTER FUEL GAUGE KIT – BLACK

**G. SPORTSTER FUEL GAUGE KIT\***

Finally, keep an eye on your Sportster model fuel level without watching how many miles you have traveled. In-tank sending unit employs capacitive sensing technology to accurately monitor the fuel level, and relays the information to a handlebar-mounted LED indicator for at-a-glance viewing. The segmented LED display is set into a distinctive housing that replaces the brake master cylinder cover on the right hand control. The individual LED segments glow when the tank is full, and count down one-by-one as the fuel level drops. Available in black or chrome finish to match your Original Equipment satin black or accessory chrome hand controls. Kit includes sending unit, LED master cylinder cover, wiring harness, and all necessary installation hardware. (Available September 2009)

Fits '07-later XL and '08-later XR models.

<b>75031-09</b>	Black.	<b>\$249.95</b>
<b>75338-09</b>	Chrome.	<b>\$249.95</b>

**H. TACH KIT FOR SPORTSTER® MODELS**

Upgrade your XL883 to dual instruments. The kit includes an electronic tachometer, wrinkle-black dual gauge mounting bracket, and hardware required for installation. Tachometer graphics complement Original Equipment speedometer and brackets allow for installation of your stock indicator lights.

**67182-07** **\$285.95**  
Fits '07-later XL883 STD, XL883L, XL883N and XL883R models. Stock on '07-later XL1200R.

**67182-04** **\$285.95**  
Fits '04-'06 XL883 STD, XL883L and XL883R models. Stock on '04-'06 XL1200R. Use with accessory Handlebar Clamp requires separate purchase of (2) Screw P/N 3485A and (2) Spacer P/N 5775.

**67182-95D** **\$285.95**  
Fits '95-'03 XL883 models. (Does not fit XL Custom models.) Use with accessory Handlebar Clamp requires separate purchase of (2) Screw P/N 3485A and (2) Spacer P/N 5775.

**I. CHROME SPEEDOMETER BRACKET KIT**

Replace the stock wrinkle black components. Kit includes chrome speedometer mounting bracket and backplate.

**1. 67293-95** **\$94.95**  
Fits '95-later XL883 models and '95-'04 FXD Super Glide® models equipped with single gauge.

**CHROME SPEEDOMETER/TACHOMETER BRACKET KIT**

Kit includes chrome dual gauge mounting bracket and chrome speedometer and tachometer backplates.

**2. 67294-95A** **\$104.95**  
Fits '99-'05 FXDX and '01-'03 FXDXT, '95-'04 FXDS-CONV. and '95-later XL1200 models (except XL1200L, XL1200N and XL1200C). Will also fit '95-later XL883, Deluxe and Hugger®, and FXD Super Glide® models that have been upgraded to dual gauges.

**J. SPUN ALUMINUM FACE GAUGES**

Add a touch of luxury and style to your handlebar. The spun aluminum face offers a rich contrast to the Original Equipment black face gauge, and features subtle racing orange backlighting for a unique night time look. Mileage reinstatement is available through your dealer.

Fits '04-'06 XL models.

<b>67057-04B</b>	4" Speedometer – MPH.	<b>\$211.95</b>
<b>67061-04B</b>	4" Speedometer – KPH.	<b>\$273.00</b>
<b>67522-04B</b>	4" Tachometer.	<b>\$189.95</b>

**K. GAUGE VISOR RING**

A touch of chrome makes all the difference. These easy-to-install trim rings feature an integrated eyebrow visor to shield the gauge face from the sun's glare. Self-adhesive backing for secure mount.

**74662-04** 3-3/4" Gauge. **\$22.95**  
Fits '99-later XL, Dyna® (except FXDWG) and '98-later Road Glide® models.



H

H. TACH KIT FOR SPORTSTER MODELS



I

I. CHROME SPEEDOMETER/TACHOMETER BRACKET KITS



J

J. SPUN ALUMINUM FACE GAUGES – 4" SPEEDOMETER



K

K. GAUGE VISOR RING – 3-3/4"

\*Some local regulations prohibit using colored lights during vehicle operation on public streets. May not conform to local lighting regulations.

Notice: The prices appearing in this catalog are the manufacturer's suggested retail prices. Actual retail prices may vary.

# 112 SPORTSTER®

Console & Gauges

## A. FUEL CAP – SKULL

Add a little attitude to your ride. Styled to complement Harley-Davidson Skull accessory items, the menacing raised skull with black-filled eyes features a rich chrome-plated finish and a styled shape that is easy to grip, even while wearing gloves.

**75097-05** \$49.95

Fits '92-later XL and Dyna (except '04-later FXD, FXDX, '05-'06 FXDC, FXDSE), '00-later Softail® models (except FXSTD, FXSTSSE/2), and '94-later Road King® models. Does not fit with Low-Profile Chrome Fuel Tank Console P/N 71208-07.



A. FUEL CAP – SKULL



B. FUEL CAP – DIAMOND BLACK COLLECTION

## B. FUEL CAP – DIAMOND BLACK COLLECTION

Drift over to the dark side. This matte-black fuel cap features a machined Bar & Shield logo and knurled edges for a raw look and easy grip. The design complements the Diamond Black Fuel Gauge, and is the perfect addition to a “blacked-out” custom ride.

**62778-10** \$49.95

Fits '92-later XL and Dyna (except '04-later FXD, FXDX, '05-'06 FXDC and '07 FXDSE), '00-later Softail models, and '94-later Road King models.

## C. BILLET FUEL CAPS

Set your gas tank apart from the rest. These machined Billet Fuel Caps feature a rich chrome-plated finish and a styled shape that is easy to grip, even while wearing gloves.

Fits '92-later XL and Dyna® (except '04-later FXD, FXDX, '05-'06 FXDC and '07 FXDSE), '00-later Softail® models, and '94-later Road King models.

**62816-03** Cross. \$49.95

**62819-03** Six Shooter. \$49.95



C. BILLET FUEL CAP – CROSS



C. BILLET FUEL CAP – SIX SHOOTER

## D. FUEL CAP MEDALLION – NUMBER ONE SKULL COLLECTION

Put the sinister Harley-Davidson #1 Skull Collection right in front of you. This decorative steel cover is contoured to hug the Original Equipment Fuel Cap, and is easy-to-install with the factory-applied adhesive backing. (Available September 2009)

Fits '83-later models (except VRSC, '04-later XL 1200L and XL1200C, '08-later XR, all FXD and FXDX models, '05-'06 FXDC, all FXR with plastic fuel cap, Electra Glide, Road Glide, Tour-Glide, Trike, and all fuel caps with gauges).

**99673-10** Polished. \$19.95

**99688-10** Black. \$19.95



D. FUEL CAP MEDALLION – NUMBER ONE SKULL COLLECTION



E. FUEL CAP MEDALLION – SKULL COLLECTION

## E. FUEL CAP MEDALLION – SKULL COLLECTION

Add a little attitude to your ride. Styled to complement Harley-Davidson Skull accessory items, the menacing raised skull with black-filled eyes leaps from a field of chrome. The surrounding “Harley-Davidson Motorcycles” script is the perfect finishing touch. These Fuel Cap Medallions top off the Original Equipment fuel cap, and are self-adhesive for easy installation.

**99670-04** \$16.95

Fits '83-later models (except '08-later XR, '04-later XL1200L, and XL1200C models, FXD and FXDX and '05-'06 FXDC models, all FXR with plastic fuel cap; Electra Glide®, Road Glide®, Tour Glide™, Trike and VRSC™ models; and all fuel caps with gauges).

**99669-04** \$16.95

Fits '04-later XL Custom and XL1200L models.

## F. FUEL CAP MEDALLIONS

Top off your Original Equipment fuel cap. Adhesive backing for easy installation.

Fits '04-later XL Custom and XL1200L models.

**99668-04** Flames Collection. \$22.95

**99667-04** Live to Ride Collection. \$22.95

**99666-04** “H-D Motor Co.” Logo Collection. \$13.95

Fits '83-later models (except VRSC, '04-later XL 1200L and XL1200C, '08-later XR, all FXD and FXDX models, '05-'06 FXDC, all FXR with plastic fuel cap, Electra Glide, Road Glide, Tour-Glide, Trike, and all fuel caps with gauges).

**99686-98** Flames Collection. \$22.95

**99020-86T** Chrome “Live to Ride”. \$16.95

**99020-90T** Gold “Live to Ride”. \$22.95

**99539-97** “H-D Motor Co.” Logo. \$13.95

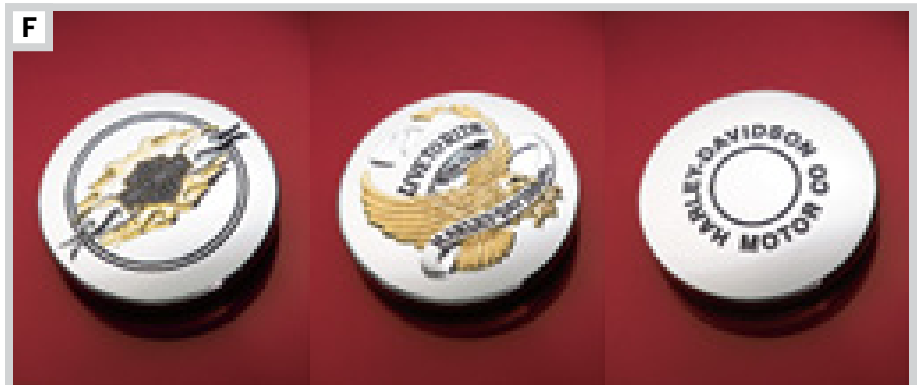

F. FUEL CAP MEDALLIONS

Notice: The prices appearing in this catalog are the manufacturer's suggested retail prices. Actual retail prices may vary.



G. CHROME FUEL TANK TRIM PANEL KIT

**G. CHROME FUEL TANK TRIM PANEL KIT**

Set your fuel tank apart from the rest with this mirror-chrome Fuel Tank Trim cap and is adhesive backed.

**61653-04** **\$124.95**

Fits '04-later XL883C, XL1200L, XL1200C and '08-later XL1200R models. Also fits '04-later XL models equipped with a Sportster® Large Capacity Fuel Tank and Installation Kit P/N 62999-04 or 62999-07.

**H. PREMIUM AIR HORN KIT**

Sit up and get noticed. This Premium Air Horn is one of the loudest motorcycle horns available. The compact design has the compressor attached directly to the horn assembly, eliminating the need for separate mounting of the compressor and air hoses. The horn features an integrated chrome cover for a stylish look. Separate purchase of a vehicle-specific mounting kit is required.

**69423-05** **\$139.95**

Fits '02-later VRSC™, '04-later XL, '08-later XR, '96-later Dyna®, '00-later Softail® (except FLSTS, FXCW/C and FLSTSC), and '99-later Touring models. Requires separate purchase of vehicle-specific Installation Kit.

**Shown with:****PREMIUM AIR HORN INSTALLATION KIT**

Required for installation of Premium Air Horn Kit P/N 69423-05 on specific models.

**69415-05A** **\$59.95**

Fits '04-later XL (except XL1200 Custom) and '08-later XR models.

**69422-05** **\$59.95**

Fits '04-later XL1200 Custom models.

**I. AIR WING HORN COVER**

This exclusive Air Wing chrome-plated horn cover is styled to complement the Harley-Davidson® Billet Air Cleaner Cover, and is a stylish replacement for the Original Equipment horn cover. Mounts easily to stock horn cover bracket.

**69167-02A** **\$46.95**

Fits '93-later models with side-mounted horn.

**J. SMOOTH HORN COVER**

Add a custom touch to your ride. Styled to complement the Smooth Air Cleaner Cover P/N 29153-07, this compact round horn cover features a mirror-chrome finish. Mounts easily to the stock horn cover bracket.

**68189-07** **\$37.95**

Fits '93-later models with side-mounted horn.

**K. BAR & SHIELD LOGO HORN COVER**

Complement your engine fins with this chrome-plated horn cover with engraved inserts, which feature a Bar & Shield emblem accented by a black background. Easily mounts to stock horn bracket.

**69166-01A** **\$46.95**

Fits '93-later models with side-mounted horn.

**L. CHROME HORN KIT**

Convert your stock Sportster horn to the look of a Big Twin.

**69112-95D** **\$89.95**

Fits '92-later XL883, XL883H, XL883C, XL883L, XL883N, XL833R, XL1200, XL1200L, XL1200N, XL1200R and '08-later XR models.



H. PREMIUM AIR HORN KIT AND INSTALLATION KIT



I. AIR WING HORN COVER



J. SMOOTH HORN COVER



K. BAR &amp; SHEILD LOGO HORN COVER



L. CHROME HORN KIT

*Notice: The prices appearing in this catalog are the manufacturer's suggested retail prices. Actual retail prices may vary.*



# 114 SPORTSTER®

Lighting – Headlamp

## A. BULLET HEADLAMP KIT

Light the way to a custom look. This mirror-chrome Bullet Headlamp Kit features a high-tech deep drawn aluminum housing that is precision machined for a perfect contour and surface finish. The visor-style shell adds a unique profile to the bike's front end, and the complete kit includes a smooth lens lamp assembly with a replaceable halogen bulb.

Fits '96-later XL1200C, '98-later XL883C, '94-later FXDWG, '06-later FXD, FXDL, FXDC, FXDB, FXD35, FXDSE, FXDF, '99-'00 FXR2, FXR3, FXR4, '84-'99 FXSTC, '99-later FXST, FXSTB, FXSTC, '08-later FXCW, FXCWC and '00-'07 FXSTD models. Installation requires separate purchase of appropriate Headlamp Mounting System P/N 68595-06 or 69611-06.

<b>68593-06</b>	5-3/4"	<b>\$329.95</b>
<b>69851-06</b>	4-1/2"	<b>\$309.95</b>

Shown with:

### HEADLAMP MOUNTING SYSTEM FOR BULLET HEADLAMP

Chrome-plated headlamp mounts are designed to position the Bullet Headlamp Kit in the proper location for specific vehicle applications. The mount is machined from solid steel for performance and durability, and is polished and plated for a superior custom look.

<b>69611-06</b>	Tall Mount.	<b>\$41.95</b>
-----------------	-------------	----------------

Fits '96-later XL1200C, '98-later XL883C, '06-later FXD, FXDL, FXDC, FXDB, FXD35, FXDWG, FXDSE, FXDF, and '99-'00 FXR2, FXR3, FXR4 models. Also fits '00-later FX Softail® models equipped with Custom Inverted Fork Kit.

## B. CHROME AUXILIARY LIGHTING KIT

There's a lot of road on this planet, and these chrome lamps will light the way. Just add the desired lamp kit to complete the installation. This kit includes the chrome lamp housings, and the chrome mounting brackets that match the contour of the triple tree and highlight the headlamp. Kit comes complete with the necessary wiring, switch and hardware for installation. Can be used with Turn Signal Relocation Kit P/N 68603-01. Bulbs sold separately.

<b>69284-05</b>		<b>\$289.95</b>
-----------------	--	-----------------

Fits '88-later XL and '91-'05 Dyna® models (except FXDWG, FXDS-CONV., and FXDXT). Also fits '88-'94 FXR, FXRS, FXLR models. ('88-'97 XL883, '88-'96 XL883 Deluxe, '96-'97 XL1200S, '88-'94 FXRS-SP, and '91-'92 FXDB-S require Turn Signal Relocation Kit P/N 68603-01.) Will not fit FXR models equipped with engine guards or Front Directional Signal Relocation Kit P/N 68517-94A.

Shown with:

### TURN SIGNAL RELOCATION KIT

This kit relocates the turn signals to the passing lamp bracket and allows the use of a Detachable Windshield. Kit includes all necessary hardware required for installation.

<b>68603-01</b>		<b>\$39.95</b>
-----------------	--	----------------

Fits '88-later XL, '91-'05 Dyna, and '84-later FXST, FXSTC and FXSTB Softail® models equipped with Auxiliary Lighting Kits.

## C. FRONT DIRECTIONAL RELOCATION KIT

This kit includes the required hardware and wiring to move the front directional lamps from the handlebar to the lower triple clamp.

Fits '88-later XL and '91-'05 Dyna models (except FXDWG and FXDXT models).

<b>68517-94A</b>	Chrome.	<b>\$28.95</b>
<b>68643-09</b>	Gloss Black.	<b>\$28.95</b>



A. 5-3/4" BULLET HEADLAMP KIT AND MOUNTING SYSTEM



A. 4-1/2" BULLET HEADLAMP KIT AND MOUNTING SYSTEM



B. CHROME AUXILIARY LIGHTING KIT (SHOWN WITH TURN SIGNAL RELOCATION KIT)



C. FRONT DIRECTIONAL RELOCATION KIT – CHROME



C. FRONT DIRECTIONAL RELOCATION KIT – GLOSS BLACK

Notice: The prices appearing in this catalog are the manufacturer's suggested retail prices. Actual retail prices may vary.





D

D. CHROME HEADLAMP BRACKET



E

E. CHROME HEADLIGHT COVER



F

F. HEADLAMP TRIM RING – XL STANDARD



G

G. VISOR STYLE HEADLAMP TRIM RING – XL STANDARD



H

H. CHROME HEADLAMP HOUSING KIT (SHOWN WITH HEADLAMP TRIM RING)



I

I. ELECTRICAL ACCESSORY ADAPTER

**D. CHROME HEADLAMP BRACKET**

Replace stock aluminum with this chrome-plated visor eyebrow – one part of a perfectly chromed front end.

**69709-00** **\$59.95**

Fits '92-later XL models (except XL Custom) and '93-'05 Dyna® models (except FXDWG).

**E. CHROME HEADLIGHT COVER**

Cover the Original Equipment aluminum headlamp eyebrow with this polished and chrome-plated cover.

**67871-85TA** With cutout. **\$19.95**

Fits '60-later XL models (except '96-later XL Custom), '91-'05 FXDL, '71-later FX and FXR models (except FXWG and FXST).

**67884-90TA** Without cutout. (not shown) **\$19.95**

Fits XL models (except '96-later XL Custom) and FXR models with indicator lights mounted in speedometer bracket and '91-'05 Dyna models (except FXDWG).

**F. HEADLAMP TRIM RINGS**

This chrome-plated Headlamp Trim Ring extends forward, giving the headlamp assembly a "frenched" look reminiscent of classic "Hot Rod" car designs by recessing the headlamp and adding the appearance of depth. Functions as a direct replacement for the Original Equipment trim ring. Will not allow the use of Headlamp Visor.

**69624-99A** Headlamp. **\$31.95**

Fits '07-later FXSTC, '96-later XL 1200C, XL883C, '99 FXR, '93-later FXSTS, '95-'97 FXSTSB, '97-'03 FLSTS, '05-later FLSTSC, and '00-'07 FXSTD models.

**69623-99A** Headlamp. **\$31.95**

Fits '94-'99 FXSTC, '94-later FXLR, FXST, FXSTB models, '94-later Dyna® models (except FXDF), '04-later XL883, XL883L, XL883N, XL883R, XL1200L, XL1200N, XL1200R and '05 VRSCB models. Also fits '08-later FLSTSB models.

**69622-99B** Passing Lamp. (not shown) **\$49.95**

Fits '62-later models equipped with Original Equipment or accessory Auxiliary Lamp Kits. (sold in pairs)

**G. VISOR STYLE TRIM RING COLLECTION**

These chrome-plated Visor-Style Trim Rings recess the headlamp into the housing, and add a traditional "eyebrow" design to the headlamp shell. The trim ring stretches the profile of the bike for a long, lean appearance. Add matching Visor-Style Passing Lamp and Turn Signal Trim Rings for a true custom look.

**69738-05** Headlamp. **\$36.95**

Fits '07-later FXSTC, '96-later XL1200C, XL883C, '99 FXR, '93-later FXSTS, '95-'97 FXSTSB, '97-'03 FLSTS, '05-later FLSTSC, and '00-'07 FXSTD models.

**69735-05** Headlamp. **\$36.95**

Fits '94-'99 FXSTC, '94-later FXLR, FXST, FXSTB models, '94-later Dyna models (except FXDF), '04-later XL883, XL883L, XL883N, XL883R, XL1200L, XL1200N, XL1200R and '05 VRSCB models. Also fits '08-later FLSTSB models.

**69732-05** Passing Lamp. (not shown) **\$54.95**

Fits '62-later models equipped with Original Equipment or accessory Auxiliary Lamp Kits. (Sold in pairs.)

**H. CHROME HEADLAMP HOUSING KIT**

Complete your custom transformation with this beautifully polished and chrome-plated headlamp housing. Manufactured from Original Equipment components, this chrome housing replaces the black headlamp shell. When combined with a headlamp trim ring or visor, this accessory is an economical alternative to billet-style headlamp housings.

**69620-04A** **\$64.95**

Fits '04-later XL models (except XL Custom). Also fits '09-later XR models, '02-'05 FXD, FXDL and FXDX models and '05 VRSCB models. Wiring is pre-installed with quick connectors for easy installation.

**I. ELECTRICAL ACCESSORY ADAPTER**

Harness accommodates the addition of multiple electrical accessories to the main battery power circuit on '04-later models.

**70270-04** **\$15.95**

Fits '04-later XL, XR, Dyna®, Softail® and Touring models.

# 116 SPORTSTER®

Lighting – Turn Signals

## A. TURN SIGNAL LENS KIT – SMOKED AND CLEAR

Add a unique touch to your bike, and finish the full-custom or minimalist look. Available in clear and smoked versions, these Turn Signal Lens Kits replace the front amber lenses for a clean appearance. Styled to complement the Original Equipment chrome or painted turn signal housings, this kit includes 2 lenses and amber bulbs. Meets DOT requirements.

Fits '08-later FXCW, FXCWC and XL1200N models.

<b>69226-09</b>	Clear (2 bulbs & lenses).	<b>\$19.95</b>
<b>69208-09</b>	Smoked (2 bulbs & lenses).	<b>\$19.95</b>

Fits '00-later models (except VRSC™ and XL1200N) with Bullet Turn Signals. Will also fit V-Rod® models equipped with Chrome Turn Signal Kits P/N 69374-05 or 69065-05.

<b>69303-02</b>	Clear (4 bulbs & lenses).	<b>\$37.95</b>
<b>69304-02</b>	Smoked (4 bulbs & lenses).	<b>\$37.95</b>



A. TURN SIGNAL LENS – CLEAR



A. TURN SIGNAL LENS – SMOKED

## B. TURN SIGNAL TRIM RINGS

Trim ring contour matches the turn signal housing and extends out past the lens for a sleek appearance. These easy-to-install trim rings look great alone, or in combination with Headlamp Trim Rings. Available in Visor Style for a nostalgic look, or in Trim Ring style for contemporary “frenched” contour (sold in pairs).

### Bullet Front or Rear, Amber Lenses

Fits models equipped with bullet style turn signals (except VRSC™, XL883N, XL1200N and FXCW/C rear signals and rear of models with Auxiliary Turn Signal Brake Light Kit P/Ns 69465-06, 69463-06 or 69462-06A).

<b>69756-05</b>	Visor Ring Style – Chrome.	<b>\$31.95</b>
<b>69739-01</b>	Trim Ring Style – Chrome.	<b>\$31.95</b>

### Bullet Front, Smoked Lenses with Amber Bulbs

Fits models equipped with front bullet style turn signals (except XL883N and XL1200N).

<b>69758-05</b>	Visor Ring Style – Chrome.	<b>\$34.95</b>
<b>69752-04</b>	Trim Ring Style – Chrome.	<b>\$34.95</b>

### Bullet Rear, Smoked Lenses with Amber Bulbs

Fits models equipped with rear bullet style turn signals (except VRSC, XL883N, XL1200N, FXCW/C, '09-later FXDB, FXDWG and models equipped with Auxiliary Turn Signal Brake Light Kit P/Ns 69465-06, 69463-06 or 69462-06A).

<b>69759-05</b>	Visor Ring Style – Chrome.	<b>\$34.95</b>
<b>69753-04</b>	Trim Ring Style – Chrome.	<b>\$34.95</b>

### Bullet Front, Clear Lenses with Amber Bulbs

Fits models equipped with front bullet style turn signals (except XL883 and XL1200N).

<b>69760-05</b>	Visor Ring Style – Chrome.	<b>\$34.95</b>
<b>69754-04</b>	Trim Ring Style – Chrome.	<b>\$34.95</b>

### Bullet Rear, Clear Lenses with Amber Bulbs

Fits models equipped with rear bullet style turn signals (except VRSC, XL883N, XL1200N, FXCW/C, '09-later FXDB, FXDWG and models equipped with Auxiliary Turn Signal Brake Light Kit P/Ns 69465-06, 69463-06 or 69462-06A).

<b>69761-05</b>	Visor Ring Style – Chrome.	<b>\$34.95</b>
<b>69755-04</b>	Trim Ring Style – Chrome.	<b>\$34.95</b>

### Bullet Rear, Red Lenses

Fits rear of all models equipped with bullet style turn signals (except VRSC and International models) and Auxiliary Brake Light Kit P/Ns 69465-06 or 69462-06.

<b>69757-05</b>	Visor Ring Style – Chrome.	<b>\$31.95</b>
<b>69736-02</b>	Trim Ring Style – Chrome.	<b>\$31.95</b>

### Bullet Front, Smoked Lenses with Amber Bulbs

Fits '08-later XL883N, XL1200N and FLSTSB models.

<b>73342-09</b>	Visor Ring Style – Black.	<b>\$34.95</b>
-----------------	---------------------------	----------------

### Bullet Rear, Red Lenses

Fits '08-later XL883N and XL1200N models. Also fits FLSTSB models equipped with Auxiliary Turn Signal and Brake Light Kit P/N 69462-06A.

<b>73344-09</b>	Visor Ring Style – Black.	<b>\$31.95</b>
-----------------	---------------------------	----------------



B. TURN SIGNAL VISOR TRIM RING – BULLET STYLE, SMOKED LENS



B. TURN SIGNAL TRIM RING – BULLET STYLE, SMOKED LENS



B. TURN SIGNAL VISOR TRIM RINGS – BLACK WITH SMOKED LENS



B. TURN SIGNAL VISOR TRIM RINGS – BLACK WITH RED LENS

Notice: The prices appearing in this catalog are the manufacturer's suggested retail prices. Actual retail prices may vary.



**C. MINI-BULLET LED TURN SIGNAL KIT – CHROME HOUSING (AMBER LENS SHOWN)**



**C. MINI-BULLET LED TURN SIGNAL KIT – BLACK HOUSING**

### C. MINI-BULLET LED TURN SIGNAL KIT

Take a new direction in lighting. Bright, fast-acting LED turn signal elements are housed in a mirror chrome-plated mini-bullet housing for definitive style. The compact turn signals tuck in tight to the hand controls and the small size trims the rear profile for a custom look. Available with clear, smoked or amber lenses, kit includes front and rear signals and the required controller. Vehicle-specific mounting kit sold separately. NOTE: These signals were designed to meet European lighting requirements and are ECE approved. As part of the ECE requirements, the front turn signals do not operate as running lamps; they only operate as directional lamps. These turn signals do not conform to DOT requirements for North America because the lens diameter is too small. The turn signal diameter is 45mm (1-3/4").

Fits '02-later VRSC™ (except VRSCF), '08-later XR, '04-later XL (except XL883N and XL1200N), '02-later Dyna® (except '09-later FXDWG and FXDB), '00-later FXSTD, and '02-later FXST, FXSTB, FXSTC, FXSTS, FLSTF, FLSTS, FLSTSB and FLSTSC models. Installation requires separate purchase of appropriate Mounting Kit. Intended for use on HDI models only.

**69474-07** Chrome Housing, Amber Lenses. **\$214.95**

**69475-07** Chrome Housing, Smoked Lenses. **\$214.95**

**69476-07** Chrome Housing, Clear Lenses. **\$214.95**

Fits '02-later VRSC™ (except VRSCF) and '08-later XR models. Installation requires separate purchase of appropriate Mounting Kit. Intended for use on HDI models only.

**68863-08** Black Housing, Smoked Lenses. **\$214.95**

### MOUNTING KIT FOR MINI-BULLET LED TURN SIGNALS

Kit includes the wiring harness, mounting brackets, and hardware required to install Mini-Bullet Turn Signals on a specified model.

**69590-07** Chrome. **\$99.95**

Required for installation of Mini-Bullet LED Turn Signal Kits P/N 69474-07, 69475-07, or 69476-07 on '04-later XL models.

**69926-08** Black. **\$89.95**

Required for installation for Mini-Bullet LED Turn Signal Kits P/N 68863-08 on '08-later XR models.



**D. FLAMED TURN SIGNALS – FRONT SMOKED**



**D. FLAMED TURN SIGNALS – REAR SMOKED**

### D. FLAMED TURN SIGNALS

Turn up the heat on your custom ride. The mirror-chrome visor-style turn signals feature a raised flame design that flows across the surface. Available with amber or smoked lenses, the kit includes both front and rear turn signals and wiring.

Fits '02-later XL models (except XL1200N). Installation of front turn signal requires separate purchase of Directional Relocation Kit P/N 68517-94A or 68266-03.

**69844-08** Amber – Domestic. **\$149.95**

**69945-08** Smoked – Domestic. **\$149.95**

**69845-08** Amber – HDI. **\$149.95**

**69960-08** Smoked – HDI. **\$149.95**

### E. CHROME FRONT TURN SIGNAL MOUNT KIT

Chrome left and right turn signal mounting bracket with swivel adjustment. Fits models equipped with handlebar mounted bullet front turn signals.

**68266-03** **\$64.95**

Fits XL (except '04-later XL), Dyna® and Softail® models equipped with handlebar mounted bullet-style turn signals. Stock on '05-later FLSTSC models.

### F. CHROME TURN SIGNAL SWIVEL ASSEMBLY KIT

Add a subtle chrome detail to match your own chrome accessories with this swivel kit, a durable stylish replacement for the stock zinc-plated swivel.

**68185-00** **\$19.95**

Fits '88-'03 XLH883, XLH883 Hugger®, XL1200S, XL1200C; '88-later FXR, FXRS, FXLR; '91-later FXD, FXDL, FXDWG, FXDX and FXDXT; '88-later FXSTC, FXSTS, FLSTF, FLSTS, FXST, FXSTB, FXSTD and FXSTSB models. (Does not fit with Turn Signal Relocation Kits or '03 FXSTDSE, '03 FLHRSEI2 or '05-later FLSTSC.)

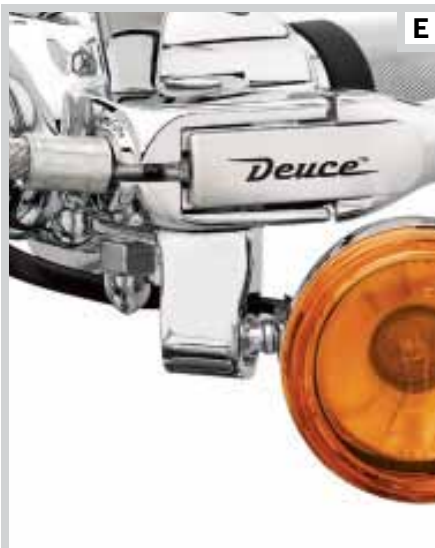

**E. CHROME FRONT TURN SIGNAL MOUNT KIT**



**F. CHROME TURN SIGNAL SWIVEL ASSEMBLY KIT**

Notice: The prices appearing in this catalog are the manufacturer's suggested retail prices. Actual retail prices may vary.



# 118 SPORTSTER®

Lighting – Tail Lamp

## A. LED TAIL LAMP WITH BAR & SHIELD LOGO

Combine LED technology and contemporary styling for a bright new look. Featuring a full array of 20 fast-acting red LED lamps, this brilliant running and brake lamp will grab everyone's attention. Designed to fit the contour of both bobtail and full rear fenders, the smoked or red lens Bar & Shield logo-accented tail lamp complements any custom direction. The available black or chrome surrounds are wrapped with a clear housing for a mirror-like finish. Easy plug-in connection to the Original Equipment wiring harness.

Fits '99-later XL (except XL883N and XL1200N), '99-later Dyna® (except '09-later FXDB), '03-later FXST, FXSTS, FXSTB, and FXSTC, '00-later FLST, FLSTF, FLSTSB and FLSTC, and '99-'08 Touring models (except FLHX, FLHTCSE2, FLHRSE3/4 and models equipped with License Plate Relocation Kit P/N 53702-04). Also fits '09-later FLHR, FLHTC and FLHTCU models.

<b>68085-08</b>	Red Lens, Chrome Housing.	<b>\$139.95</b>
<b>68086-08</b>	Smoked Lens, Chrome Housing.	<b>\$139.95</b>
<b>68087-08</b>	Smoked Lens, Black Housing.	<b>\$139.95</b>



A. LED TAIL LAMP WITH BAR & SHIELD LOGO

## B. SISSY BAR AUXILIARY BRAKE AND TAIL LAMP

This high-mounted Sissy Bar Auxiliary LED Lamp operates as a supplemental rear running light and brake light. The one-piece lamp assembly features an upper and lower arched lens that surrounds the sissy bar medallion plate, and the fast-acting LED lamp produces a red or smoked neon-like glow that is bound to get you noticed. The kit includes an adapter harness that connects to the vehicle wiring harness and features a quick disconnect that allows a detachable sissy bar to be easily removed from the vehicle. Available with Red or Smoked Lens.

Fits '99-later XL models, '96-later Dyna models, and '96-later Softail® models equipped with a Medallion Plate-Style Sissy Bar Upright. Will not fit with Backrest Pads that have mounting brackets that match the contour of the sissy bar medallion. Will not fit with sissy bar mounted storage bags. Some Touring and Bucket Backrest pads require separate purchase of Sissy Bar Lamp Mounting Bracket Kit P/N 59545-04.

<b>59470-06</b>	Smoked Lens.	<b>\$84.95</b>
<b>59429-04</b>	Red Lens.	<b>\$84.95</b>

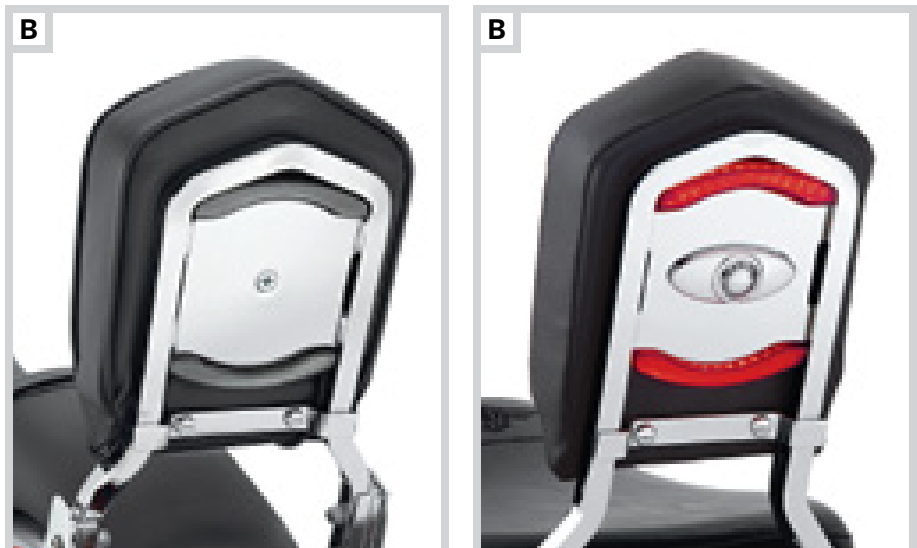

B. SISSY BAR AUXILIARY BRAKE AND TAIL LAMP – SMOKED LENS

B. SISSY BAR AUXILIARY BRAKE AND TAIL LAMP – RED LENS

## C. AUXILIARY RUNNING LIGHT/BRAKE LIGHT/TURN SIGNAL CONVERSION KIT

Turn signal module adds an auxiliary brake light and running light function to your existing turn signals for auxiliary rear lighting. Red lenses glow when the headlamp is on, and increase in intensity when brakes or turn signals are activated. Easy-to-install, the kit simply plugs into your existing wiring harness. Red turn signal lenses are included. Meets DOT requirements.

<b>69463-06</b>	Bullet Lens Style.	<b>\$59.95</b>
Fits '04-later XL models (except XL883N and XL1200N).		

**69462-06A** Bullet Lens Style. **\$59.95**  
Fits '02-'03 XL, '02-later Dyna (except FXDXT and '09 FXDB), and '02-later Softail® (except FXSTD/I) models equipped with stock bullet-style turn signals. (NOTE: Not intended for use on '04-later FLHX, FLHRS, FLTR, FLHTCSE models, '05-later FLSTN models or models equipped with Bullet Turn Signal Bar Kit P/N 68615-04 or 68617-04. If installed on these models, the system will function properly but will not meet the DOT minimum separation requirements for a red tail light to red turn signal.)



C. AUXILIARY RUNNING LIGHT/BRAKE LIGHT/TURN SIGNAL CONVERSION KIT

Notice: The prices appearing in this catalog are the manufacturer's suggested retail prices. Actual retail prices may vary.



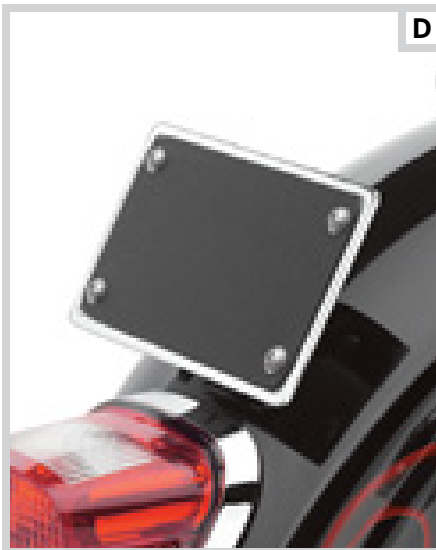

D. LAYBACK LICENSE PLATE MOUNT

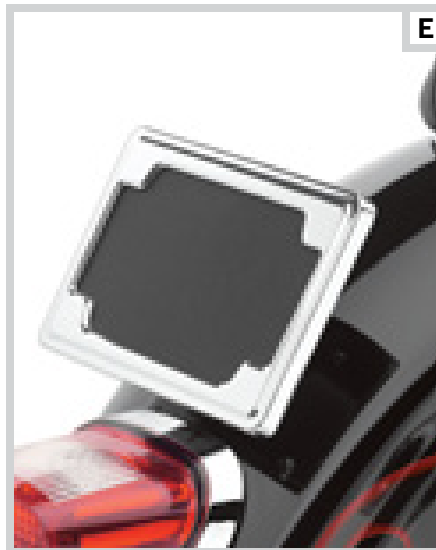

E. FRAMED LAYBACK LICENSE PLATE MOUNT



F. LAYBACK LICENSE PLATE AND TURN SIGNAL RELOCATION KIT



G. CHROME LICENSE PLATE MOUNT - SOFTAIL DEUCE SHOWN



H. BILLET LICENSE PLATE FRAME



I. CHROME TAIL LAMP COLLAR

**D. LAYBACK LICENSE PLATE MOUNT**

Showcase your laid-back attitude by replacing the stand-up license-plate mount. Chrome-plated die-cast mount tips the license plate back for a low-profile style. Kit accepts plates measuring to 7-1/4" by 4-1/4" (184 x 108mm). Kit includes chrome-plated license mounting hardware, installation hardware, and rear fender reflector.

**60280-07** **\$41.95**

Fits license plate up to 7-1/4" x 4-1/4". Fits models with a three-hole rear fender mount license plate bracket. (Does not fit XL883N, XL1200N, FLSTS, FXDS-CONV., FXDXT, '00-'01 FXDX, Touring, VRSC™ or models with a Bobtail Rear Fender.)

**E. FRAMED LAYBACK LICENSE PLATE MOUNT**

Wrap your license plate in chrome. This mirror-finish license mount tips the plate back for a sleek appearance, and conceals the mounting hardware for a custom look. The front frame covers the license holes, and the mirror-smooth back plate hides the unfinished rear of the plate. Kit accepts plates measuring to 7-1/4" by 4-1/4" (184 x 108mm). Kit includes installation hardware and rear fender reflector.

**60193-07** **\$59.95**

Fits license plate up to 7-1/4" x 4-1/4". Fits models with a three-hole rear fender mount license plate bracket. (Does not fit XL883N, XL1200N, FLSTS, FXDS-CONV., FXDXT, '00-'01 FXDX, Touring, VRSC™ or models with a Bobtail Rear Fender.)

**F. LAYBACK LICENSE PLATE AND TURN SIGNAL RELOCATION KIT**

This kit combines the popular Layback License Plate Mount with an integrated turn signal bar to add a stylish slant to the rear fender. Kit relocates the Original Equipment bullet-style turn signals from the fender strut to the turn signal bar to allow clearance for saddlebags. This kit is a stylish alternative to Turn Signal Relocation Kit P/N 68732-02A, and includes all necessary mounting hardware.

**60215-06** **\$79.95**

Fits '04-later XL models (except XL883N and XL1200N) and '02-later Dyna® models (except FXDWG, FXDF and '09-later FXDB).

**G. CHROME LICENSE PLATE MOUNT**

Show off your tail. This chrome-plated cover fits over the stock fender mount license plate bracket. This mirror-finished cover features a custom reflector with "Harley-Davidson" graphics. Includes mounting hardware for cover and license plate.

**59720-01A** **\$37.95**

Fits '99-later FXDWG, '00-later FXSTD, FXST, FXSTB, FXSTC, FLSTSB, FXSTS and XL and Dyna® models equipped with H-D® Bobtail Fender Kit.

**H. BILLET LICENSE PLATE FRAME**

Make a custom statement. Manufactured from billet aluminum, this mirror-polished license plate frame features hidden hardware and bright polished stainless steel backing plate for a clean look. The kit includes "Harley-Davidson", "Sportster", "Fat Boy" and "Road King" logo engraved inserts for the ultimate finishing touch. Chrome-plated stainless steel mounting hardware included.

**60060-04** **\$74.95**

Fits 7-1/4" x 4-1/4" license plates (except XR, Trike and models equipped with Layback License Plate Mounting Kits or side-mount license plates).

**I. CHROME TAIL LAMP COLLAR**

This chrome-plated ABS tail lamp collar dramatically changes the appearance of your rear fender. The collar is easy-to-install, and the kit includes all mounting hardware.

**68311-01** **\$31.95**

Fits '03-later XL (except XL883N and XL1200N), Dyna (except FXDWG and '09-later FXDB), FLSTF, '03-'08 Touring models (except FLHX), and '09-later FLHRC, FLHTC and FLHTCU models with Original Equipment tail lamp.



# DYNA<sup>®</sup>

*As an original expression of the custom motorcycle, the long, low and lean Dyna models are ready for anything right out of the box. Now it's time to mold it to fit you and the demands of the road you're on. It's time your Dyna motorcycle became an original expression of you.*

*For the complete list of Genuine Motor Accessories that appear on these motorcycles or any other Dyna motorcycles shown, visit: [www.harley-davidson.com/gallery](http://www.harley-davidson.com/gallery).*

LEFT FXDB Dyna<sup>®</sup> Street Bob<sup>®</sup> Color Shop - Trust Me  
 RIGHT FXDF Dyna<sup>®</sup> Fat Bob<sup>®</sup> Silver Denim  
 LOCATION MILWAUKEE, WI  
 GPS N 43° 01.732' - W 87° 55.116'

**ONLY YOU CAN DECIDE HOW YOU RIDE.**

*Fit and function are the bare essentials of customizing. If you do nothing else to your motorcycle, make sure your bike fits your body properly and accommodates the type of riding you plan to do.*

*Having the right accessories makes all the difference in the comfort and control you feel on the road. Take the time to learn how your Dyna® model can be personalized so you can get the most out of your riding experience.*

**FINDING YOUR FIT AND FUNCTION**

To make your Dyna® motorcycle fit you like a well-worn pair of jeans, your inspiration is only a few pages away. The page numbers listed at the right will help you quickly navigate to the section of the Catalog that most interests you. Turn the pages, and mark your trail with bent-over corners and scribbled notes in the margins. Customizing is a journey...travel well.

*For the complete list of Genuine Motor Accessories that appear on this motorcycle visit: [www.harley-davidson.com/gallery](http://www.harley-davidson.com/gallery).*



**STOPPING BY THE FIT SHOP**



**A. SEATS**

*Where the seat positions your waist relative to the foot controls, hand controls and the ground will impact your riding comfort, so test-sit a variety of seats to get it right.*

**B. FOOT CONTROLS**

*Where your feet meet the controls is equal parts riding style and physical necessity; it also determines the angle of your hip, knee and ankle, so keep it comfortable.*

**C. HANDLEBAR & CONTROLS**

*Each bar has a unique combination of rise, width and pullback—putting your hands, wrists, arms and shoulders in different configurations. See what feels natural and stick with it.*

**D. RIDE HEIGHT**

*Suspension components and seat shape combine to determine your riding position. Finding the right combination is the easiest way for a shorter rider to fit comfortably on a larger bike.*

**GEARING UP WITH RIDER ESSENTIALS**

Selecting even the basic accessories can be daunting. Start by adding versatility and long-haul comfort. These windshields, backrests and luggage racks are designed to fit your specific Dyna® model and will get you ready for the open road.

**FOR '06-LATER FXDC & FXDL**

- Quick-Release Windshield.....58346-06
- Medallion Style Low Upright.....52735-85
- Detachable Sissy Bar Sideplates.....52866-06
- Smooth Backrest Pad.....52612-95
- Five Bar Sport Luggage Rack.....53862-00
- Rear Directional Relocation Kit.....53968-06B

**FOR '06-LATER FXD & FXDB**

- Quick-Release Windshield.....58346-06
- Gloss Black Rigid Mount Solo Rack.....52796-09
- Detachable Passenger Pillion.....52689-09
- Gloss Black Low Sissy Bar Upright.....52726-09
- Passenger Backrest Pad.....51782-07
- Passenger Footpeg Supports.....50210-06
- Passenger Footpegs.....33048-72

**FOR '08-LATER FXDF**

- Quick-Release Windshield.....57338-08
- Medium Low Upright.....52877-08
- Detachable Sissy Bar Sideplates.....52866-06
- Smooth Passenger Backrest Pad.....52612-95
- Five Bar Sport Luggage Rack.....53982-08

## SHOW OFF THE STYLE YOU WERE BORN WITH.

*This is where your ride becomes a true individual. Where leather and steel become a reflection of your passion, commitment and character. Think about styling your bike as a whole, and what look you are after. Even though your style and taste may change over time, there's only one opinion that matters here, and that's yours.*

### FINDING YOUR STYLE

This Catalog is packed with options that will let you establish your own sense of style. Flip through for inspiration, or use the page numbers below to help you quickly navigate to the pages that cover the areas you would like to customize.



GPS & AUDIO  
PG 616

CUSTOM SEAT PROGRAM  
PG 706

SECURITY & STORAGE  
PG 748

CLEANING & MAINTENANCE  
PG 760

LUGGAGE  
PG 691

### DEFINING YOUR STYLE

The possibilities are endless, so it pays to have an overall plan. Think through your customizing efforts to manage installation costs and minimize your time off the road.

#### A. FRONT & REAR END

*The front forks and rear swingarm are some of the most striking elements on your motorcycle. Custom sliders, axle covers and hardware maximize the visual impression.*

#### B. PAINT

*Your bike's paint sets the tone for the rest of your ride. From the classic and understated to the modern and brash, we have the options to help you find exactly what you want.*

#### C. CUSTOM DETAILS

*Your bike really comes alive in the details. Chrome, stylized or black components will help set your bike apart from the crowd and pull your vision together.*

#### D. WHEELS

*Your wheels, sprocket and rotors take up a lot of visual real estate and are a great way to complement or instantly overhaul the look of your ride.*



# WHAT'S HOT

*We're always pushing our design teams to come up with new, innovative, functional and stylish components to reflect your personal needs. Take a minute to see what we've cooked up, and you'll find the right additions to help you accelerate your riding experience.*

TYPHOON  
CUSTOM WHEEL  
PG : 669



SCREAMIN' EAGLE® MUFFLERS  
PG 479

HEEL RAISER  
FOOTPEG  
PG : 565



ROAD TECH™ ZÜMO® 660 GPS NAVIGATOR  
PG 617

DARK CUSTOM™ LOGO  
COLLECTION  
PG : 517



SCREAMIN' EAGLE  
HEAVY BREATHER  
PG : 472

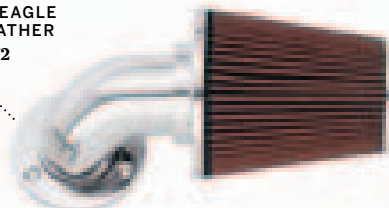

DISTRESSED  
BROWN LEATHER  
SADDLEBAGS  
PG : 154



BROWN LEATHER  
SOLO SPRING SADDLE  
PG 138



OIL TEMPERATURE DIPSTICK  
WITH LIGHTED LED READOUT  
PG 537

PG : 146  
ONE-PIECE  
DETACHABLE  
PASSENGER  
SISSY BAR



**FXDWG**  
**DYNA® WIDE GLIDE®**

Production Color: *Vivid Black*

**About This Bike** Stripped down and ready to run, this blacked-out Wide Glide is the dictionary definition of a true street custom. With room for a passenger and a little gear, you can disappear for a night on the town.

**ACCESSORIES FOR FIT**

Fat Drag Handlebar – *Black* ..... 55977-09

**ACCESSORIES FOR FUNCTION**

**NEW** Slip-Over Backrest Pad ..... 51732-10

**NEW** Chopped Luggage Rack – *Black* ..... 54252-10

**ACCESSORIES FOR STYLE**

**FRONT END**

Chrome Fork Sliders ..... 46589-06B

Axle Nut Covers – *Front, Black* ..... 43428-09

Wheel Spacers – *Front, Chrome* ..... 41361-08

Caliper Insert – *Chrome (2)* ..... 44477-99

Bullet Headlamp Kit – *4½"* ..... 69851-06

Smoked Turn Signal Lens Kit – *Front* ..... 69208-09

**HAND CONTROLS & GAUGES**

Mirrors – *Tribal, Black* ..... 92398-09

Hand Levers – *Black* ..... 44994-08

Hand Grips – *Tribal* ..... 56254-09

Flush Mount Fuel Cap and Gauge – *Black* ..... 75327-09

4" Combination Speedo/Tachometer ..... 74735-09

**NEW** Oil Level & Temp Dipstick – *Black* ..... 63065-09

**ENGINE & CHASSIS TRIM**

Rocker Cover – *Wrinkle Black (2)* ..... 17620-99

Derby Cover – *Black Fin* ..... 25454-01

Timer Cover – *Black Fin* ..... 32677-01

Headbolt Bridge – *Finned, Black* ..... 43859-00

**FOOT CONTROLS**

Shift Linkage – *Slotted Black Anodized* ..... 33745-09

Billet Shift Lever – *Black* ..... 34016-08

Billet Brake Lever – *Black* ..... 46873-09

Shifter Peg – *Tribal* ..... 34669-09A

Footpegs – *Tribal (2)* ..... 51376-09

Brake Pedal Pad – *Tribal* ..... 42008-09

**REAR END**

Wheel Spacers – *Rear, Chrome* ..... 41362-08

Rear Axle Covers – *Black* ..... 43422-09

Belt Guard – *Black OE* ..... 60339-07A

**SCREAMIN' EAGLE® PERFORMANCE**

Stage I Air Cleaner Kit ..... 29440-99D

Air Cleaner Back Plate – *Wrinkle Black* ..... 29586-06

Round Air Cleaner – *Vivid Black* ..... 29400-08

Street Performance Mufflers – *Black* ..... 80601-09

Exhaust Shield Kit – *Black* ..... 65247-09

For the complete list of Genuine Motor Accessories that appear on this motorcycle visit: [www.barley-davidson.com/gallery](http://www.barley-davidson.com/gallery).

LOCATION ..... ATOMIC TATTOO; MILWAUKEE, WI

GPS ..... N 43° 03.591' – W 87° 53.521'





**FXDB**  
**DYNA® STREET BOB®**  
 Color Shop Custom Paint: *Limited Series – Night*

**About These Bikes** Closing the generation gap. Old-school clean or new school mean, the tradition of flat black paint and distressed brown leather transcends time.

**COLOR SHOP CUSTOM PAINT**  
**NEW** Limited Series Paint – *Night* ..... 95723-10DDK

**ACCESSORIES FOR FIT**

- NEW** Solo Spring Seat – *Brown Leather* ..... 54072-10
- NEW** Spring Seat Installation Kit ..... 54075-10
- Forward Control Kit – *Black* ..... 49021-09
- Mini Ape Handlebar – *Black* ..... 56075-07

**ACCESSORIES FOR STYLE**

- LIGHTING & FRONT END**
- Turn Signal Relocation Kit – *Front* ..... 69433-08
  - Headlamp Trim Ring ..... 69623-99A
  - Front Axle Covers – *Black* ..... 43428-09

**HAND & FOOT CONTROLS**

- Hand Grips – *Nostalgic* ..... 56275-96B
- Hand Control Levers – *Black Flame* ..... 42535-08
- Dome Billet Mirrors – *Black* ..... 92423-08
- Footpegs – *Custom* ..... 50916-90T

- Shifter Peg – *Custom* ..... 34635-90T

**ENGINE & CHASSIS TRIM**

- Timer Cover – *Black Fin* ..... 32677-01
- Derby Cover – *Black Fin* ..... 25454-01
- Derby Cover Gasket ..... 25416-99C
- Rocker Box Covers – *Wrinkle Black (2)* ..... 17620-99
- Headbolt Covers – *Gloss Black* ..... 43896-99
- Smooth Air Cleaner Cover ..... 29153-07

**REAR END**

- Rear Axle Covers – *Black* ..... 43422-09
- Sprocket Hardware – *Chrome* ..... 94773-07

**SCREAMIN' EAGLE® PERFORMANCE**

- Stage I Air Cleaner Kit ..... 29440-99D
- NEW** Street Performance Mufflers – *Black* ..... 80794-10
- NEW** Exhaust Shields – *Black* ..... 80821-10



**FXDF**  
**DYNA® FAT BOB®**  
 Color Shop Custom Paint: *Core Series – Purgatory*

**COLOR SHOP CUSTOM PAINT**

- NEW** Core Series Paint – *Purgatory* ..... 95760-10DDC

**ACCESSORIES FOR FIT & FUNCTION**

- NEW** Low-Profile Solo Seat – *Brown Leather* ..... 51937-10
- NEW** Passenger Pillion – *Brown Leather* ..... 54089-10
- NEW** Saddlebags – *Brown Leather* ..... 88348-10
- Fat Drag Handlebar – *Black* ..... 55977-09
- Rear Detachable Docking Hardware ..... 53964-06A

**ACCESSORIES FOR STYLE**

**WHEELS & ROTORS**

- Fang Wheel – *16" Front* ..... 43265-09
- Fang Wheel – *16" Rear* ..... 43268-09

**FRONT & REAR END**

- Lower Fork Sliders – *Chrome* ..... 48748-08A
- Axle Nut Covers – *Front, Chrome* ..... 44116-07A
- Swingarm – *Chrome* ..... 48458-06
- Rear Axle Covers – *Chrome* ..... 43132-08

**HAND & FOOT CONTROLS**

- Dome Billet Mirrors – *Black* ..... 92423-08
- Hand Levers – *Black* ..... 44994-08
- Hand Grips – *Diamond-Black* ..... 56405-08
- Footpegs – *Diamond Black (2)* ..... 50911-08
- Shifter Peg – *Diamond Black* ..... 34690-08

- Brake Pedal Pad – *Diamond Black* ..... 41850-08
- Billet Shift Lever – *Chrome* ..... 34539-00
- Billet Brake Lever – *Chrome* ..... 42666-03

**ENGINE & CHASSIS TRIM**

- Rocker Cover – *Wrinkle Black (2)* ..... 17620-99
- Timer Cover – *Black Fin* ..... 32677-01

**SCREAMIN' EAGLE® PERFORMANCE**

- Street Performance Mufflers – *Jet Black* ..... 80601-09
- Exhaust Shield Kit – *Black* ..... 65247-09

For the complete list of Genuine Motor Accessories that appear on these motorcycles visit: [www.harley-davidson.com/gallery](http://www.harley-davidson.com/gallery).

# DYNA® WINDSHIELDS

## SPLIT THE WIND

*At highway speed, you take the wind full-force in the chest, causing fatigue in your arms, neck and shoulders. Take the pressure off with an easy-to-install detachable windshield. Shaped to divert air, rain and road debris around the rider, a windshield can add hours of riding comfort.*

### DYNA WINDSHIELD TYPES



**SUPER SPORT WINDSHIELD**

*Low and lean shape gives your bike a sleek and athletic appearance. Minimal coverage, but sometimes that's all you need to extend your ride into the next straightaway.*



**COMPACT WINDSHIELD**

*Standard issue windshield for any ride. The compact size takes on everything the road throws at it while maintaining a clean and strictly business look.*



**THE SELECTION GUIDE**

*For maximum wind protection, and the best view down the road, select a windshield that tops out just below your line of sight. Your dealer has the tools to make the selection simple.*

### CHANGING YOUR WINDSHIELD



Designed to be installed or removed without tools in seconds, a Detachable Windshield gives you the freedom to define your ride at the drop of a hat. Ride across the country protected from the elements, then quickly remove the windshield to hit the streets in style.

- A. STANDARD DETACH HARDWARE
- B. QUICK-DETACH HARDWARE

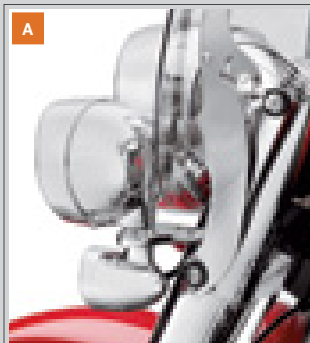





**A. QUICK-RELEASE COMPACT WINDSHIELD – 18", LIGHTLY SMOKED SHOWN**

**QUICK-RELEASE COMPACT WINDSHIELD**

Combine the classic Harley-Davidson® windshield shape with a revolutionary new attachment system, and you have the best of style and function. The windshield mounts to the fork tubes with elegant die-cast lever-release clamps, so the windshield does not require any "leave-behind" docking hardware. You get quick on-and-off convenience, and a clean, custom look. No tools are required, and the kit includes everything needed to install the windshield. The tough, hard-coated polycarbonate windshield features traditional polished or gloss black horizontal and vertical braces.

**A. Polished Braces**

Fits '06-later Dyna® models (except FXDWG, FXDF and FXDSE).

Overall height – 26.8"; width – 19.7".

**58346-06** 18" Clear. **\$349.95**

**58347-06** 18" Lightly Smoked. **\$384.95**

Overall height – 22.8"; width – 19.5".

**58348-06** 14" Lightly Smoked. **\$374.95**

Fits '88-later XL and '91-'05 Dyna models (except FXDWG and FXDXT).

Overall height – 26.8"; width – 19.7".

**58063-04** 18" Clear. **\$349.95**

**58601-04** 18" Lightly Smoked. **\$384.95**

Overall height – 22.8"; width – 19.5".

**58602-04** 14" Lightly Smoked. **\$374.95**

Fits '06-later FXDWG models.

Overall height – 26.8"; width – 19.5".

**58387-06** 18" Clear. **\$349.95**

**58413-06** 18" Lightly Smoked. **\$384.95**

Overall height – 22.8"; width – 19.5".

**58444-06** 14" Lightly Smoked. **\$374.95**

Fits '93-'05 FXDWG and '86-later FXST, FXSTC and FXSTB models.

Overall height – 23.8"; width – 21.4".

**59802-05** 19" Clear. **\$414.95**

**58751-05** 19" Lightly Smoked. **\$434.95**

Overall height – 20.8"; width – 21.4".

**57199-05** 16" Lightly Smoked. **\$424.95**

Fits '08-later FXDF and FXDFSE models.

Overall height – 27.0"; width – 19.6".

**57338-08** 19" Clear. **\$349.95**

Overall height – 23.0"; width – 19.6".

**57340-08** 15" Lightly Smoked. **\$374.95**

**B. Black Braces**

Fits '88-later XL and '91-'05 Dyna models (except FXDWG and FXDXT).

Overall height – 26.8"; width – 19.7".

**58706-09** 18" Clear. **\$374.95**

Overall height – 22.8"; width – 19.5".

**58703-09** 14" Lightly Smoked. **\$399.95**

Fits '93-'05 FXDWG and '86-later FXST, FXSTC and FXSTB models.

Overall height – 23.8"; width – 21.4".

**58360-09** 18" Clear. **\$439.95**

Overall height – 20.8"; width – 21.4".

**58376-09** 16" Lightly Smoked. **\$449.95**

Fits '08-later FXDF and FXDFSE models.

Overall height – 27.0"; width – 19.6".

**58617-09** 19" Clear. **\$374.95**

Overall height – 23.0"; width – 19.6".

**58630-09** 15" Lightly Smoked. **\$399.95**



**A. QUICK-RELEASE COMPACT WINDSHIELD – 14", LIGHTLY SMOKED SHOWN**



**B. QUICK-RELEASE COMPACT WINDSHIELD – 14", GLOSS BLACK SHOWN**

Notice: The prices appearing in this catalog are the manufacturer's suggested retail prices. Actual retail prices may vary.

# 132 DYNA®

## Windshields

### A. QUICK-RELEASE SUPER SPORT WINDSHIELD

Reduces the pounding of wind and shower of bugs, but keeps the wind-in-the-hair feeling. Ideal for a cool morning ride, the sleek profile of the Super Sport Windshield hugs the front headlamp for a sporty look. The windshield mounts to the fork tubes with elegant die-cast lever locking clamps, so the windshield does not require any "leave-behind" docking hardware. You get quick on-and-off convenience and a clean, custom look. No tools are required, and the kit includes everything needed to install the windshield.

**57300-06** 19" Lightly Smoked. **\$329.95**  
Fits '06-later Dyna® models (except FXDWG, FXDF and FXDSE/2). Windshield dimensions: Overall height – 25"; width – 20.1".

**57301-06** 19" Lightly Smoked. **\$329.95**  
Fits '06-later FXDWG models. Windshield dimensions: Overall height – 25"; width – 20.1".

**57838-08** 19" Lightly Smoked. **\$309.95**  
Fits '88-later XL and '91-'05 Dyna models (except FXDWG and FXDXT). XL Custom models require Front Directional Relocation Kit P/N 68517-94A. Windshield dimensions: Overall height – 25"; width – 20.1".

**57331-07** 16" Lightly Smoked. **\$349.95**  
Fits '07-'08 FXDSE and '00-later FXST, FXSTB and FXSTC models equipped with Custom Inverted Front Fork Kit P/N 46321-05, 46321-05A or 48646-06. Windshield dimensions: Overall height – 22.1"; width – 15.3".

### B. QUICK-RELEASE TOURING WINDSHIELD

The Touring Windshield features an aerodynamic design shaped to provide hours of riding comfort. The additional center width directs airflow past the hand grips, and deflects rain and road debris around the rider. The windshield mounts to the fork tubes with elegant die-cast lever-release clamps, so the windshield does not require any "leave-behind" docking hardware. You get quick on-and-off convenience, and a clean, custom look. No tools are required, and the kit includes everything needed to install the windshield. The tough, hard-coated polycarbonate windshield features traditional polished horizontal and vertical braces.

Fits '06-later Dyna® models (except FXDF, FXDWG and FXDSE). Windshield dimensions: Overall height – 26.3"; width – 25".

**57015-06** 19" Clear. **\$424.95**

**57016-06** 19" Lightly Smoked. **\$444.95**

Fits '88-later XL and '91-'05 Dyna models (except FXDWG and FXDXT). Windshield dimensions: Overall height – 28.3"; width – 22.1".

**58158-08** 19" Clear. **\$424.95**

### C. QUICK-RELEASE COMPACT WINDSHIELD FOR MODELS EQUIPPED WITH AUXILIARY LIGHTING

Combine the classic Harley-Davidson® windshield shape with a revolutionary new attachment system, and you have the best of style and function. The windshield mounts to the fork tubes with elegant die-cast lever-release clamps, so the windshield does not require any "leave-behind" docking hardware. You get quick on-and-off convenience, and a clean, custom look. No tools are required, and the kit includes everything needed to install the windshield. The tough, hard-coated polycarbonate windshield features traditional polished horizontal and vertical braces. Can be used with Turn Signal Relocation Kit P/N 68603-01.

Fits '06-later Dyna models (except FXDWG, FXDSE and FXDF) equipped with Auxiliary Lighting Kits. Windshield dimensions: Overall height – 26.8"; width – 19.7".

**57609-08** 18" Clear. **\$369.95**



A. QUICK-RELEASE SUPER SPORT WINDSHIELD (STREET BOB SHOWN)



B. QUICK-RELEASE TOURING WINDSHIELD – LIGHTLY SMOKED



C. QUICK-RELEASE COMPACT WINDSHIELD FOR MODELS EQUIPPED WITH AUXILIARY LIGHTING



D. DETACHABLE SUPER SPORT WINDSHIELD

**D. DETACHABLE SUPER SPORT WINDSHIELD**

Super is an apt description for this do-it-all windshield with detachable convenience and sport styling. The windshield mounts to the fork tubes with Detachable Docking Hardware (sold separately) for easy on-and-off convenience and a quick return to a sporting profile.

**57965-97A** 18" Lightly Smoked. **\$219.95**  
Fits '84-later FXST, FXSTC, FXSTB, '93-'05 FXDWG, '80-'86 FXWG. (Does not fit FXSTD.) Use Docking Hardware Kit P/N 58350-96. Windshield dimensions: Overall height – 22.3"; width – 17.8".

**DOCKING HARDWARE FOR DETACHABLE WINDSHIELDS** (not shown)

**58164-96A** For 39mm Forks. **\$69.95**  
Required for installation of Detachable Windshields on '88-later XL, and '91-'05 Dyna models (except FXDWG and FXDXT). XL and Dyna models with Front Turn Signals originally located on the upper triple clamp may require the additional purchase of Turn Signal Wiring Kit P/N 72389-96.

**58350-96** For 41mm Forks. **\$69.95**  
Required for installation of Detachable Windshields on '84-later FXST, FXSTC, FXSTB, '93-'05 FXDWG, '80-'86 FXWG models. (Does not fit FXSTD.)

**E. DETACHABLE COMPACT WINDSHIELD FOR MODELS WITH AUXILIARY LIGHTING KITS**

Dress up or down with the convenience of a Detachable Windshield on your XL or Dyna model equipped with Auxiliary Lighting Kits.

**57716-01** 18" Clear. **\$274.95**  
Fits '88-later XL and '91-'05 Dyna models (except FXDWG and FXDXT) equipped with Auxiliary Lighting Kits. Requires the separate purchase of Docking Hardware Kit P/N 58164-96A and Turn Signal Relocation Kit P/N 68603-01. Windshield dimensions: Overall height – 26.8"; width – 19.7".

**58865-03** 18" Clear. **\$284.95**  
Fits '93-'05 FXDWG and '84-later FXST, FXSTC, FXSTB models equipped with Auxiliary Lighting Kits. Requires separate purchase of Docking Hardware Kit P/N 58361-03. Windshield dimensions: Overall height – 21.9"; width – 21.4".

**Shown with:****TURN SIGNAL RELOCATION KIT**

This kit relocates the turn signals to the passing lamp bracket, and allows the use of a Detachable Windshield. Kit includes all necessary hardware required for installation.

**68603-01** **\$39.95**  
Fits '88-later XL, '91-'05 Dyna, and '84-later FXST, FXSTC and FXSTB Softail® models equipped with Auxiliary Lighting Kits.

**58742-05** **\$44.95**  
Fits '93-'05 FXDWG, '86-later FXST, FXSTC, FXSTB, and '00-'07 FXSTD models.

**Also available:****WINDSHIELD DOCKING HARDWARE AND TURN SIGNAL RELOCATION KIT**

Required for installation of Detachable Windshields on FXDWG and FXST models equipped with Auxiliary Lighting Kits. Includes windshield mounting hardware and turn signal relocation hardware.

**58361-03** **\$74.95**  
Fits '93-'05 FXDWG and '84-later FXST, FXSTC, FXSTB models equipped with Auxiliary Lighting Kits.

**F. SPORT WINDSHIELD KIT**

Formed of Lexan® polycarbonate and hard-coated to resist scratching. Lightly smoked windshield is contoured to fit the headlamp and incorporates adjustable four-point mounting. Functional styling helps deflect wind to reduce upper body fatigue.

**58192-87A** 18" Lightly Smoked. **\$164.95**  
Fits '88-later XL and '91-'05 Dyna models (except XL Custom, FXDWG and FXDXT). Includes black mounting hardware. Windshield dimensions: Overall height – 18.5"; width – 16.3".

**91820-85A** 18" Lightly Smoked. **\$164.95**  
Fits '84-later FXST, FXSTB, FXSTC, '93-'05 FXDWG, and '86-earlier FXWG models. Windshield dimensions: Overall height – 20"; width – 15".



E. DETACHABLE COMPACT WINDSHIELD FOR MODELS WITH AUXILIARY LIGHTING KITS



F. SPORT WINDSHIELD KIT

# DYNA® SEATS

## SEAT OF POWER

*The right seat is equal parts ergonomics and comfort. Its shape anchors your position and determines the reach to the ground and to the controls; and the padding supports your tailbone and hips to relieve stress and pressure. Pick the right one for you...and your passenger.*

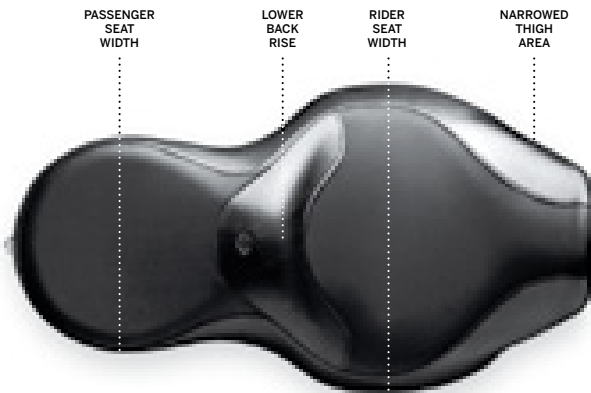

### COMFORT ZONE

A seat is more than just leather and foam. For maximum highway comfort, a broad seating surface distributes weight to reduce pressure points. For a short rider, a narrow, tapered thigh zone provides easier reach to the ground. And a stepped seat profile keeps the rider from sliding back during acceleration.

### DYNA SEAT TYPES

Solo or two-up, comfort or style, check out these seats to get an idea of where you want to sit.

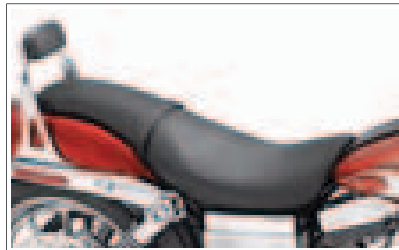

#### LOW-PROFILE SEATS

*These saddles combine radical styling with a "deep in the bike" riding position. Long and lean, Badlander®, Brawler® and Sidekick® seats bring you lower to the ground than most other seats.*



#### POSITION SEATS

*Designed to place the rider in the best relationship to the controls, Reach® and Tallboy® seats position short and tall riders for a comfortable extension of the arms and legs.*



#### TOURING SEATS

*Designed for comfort, touring seats and passenger pillions offer a broad seating surface to reduce pressure points. The dish shape holds you in place and provides additional back support.*

### CHANGING YOUR SEAT

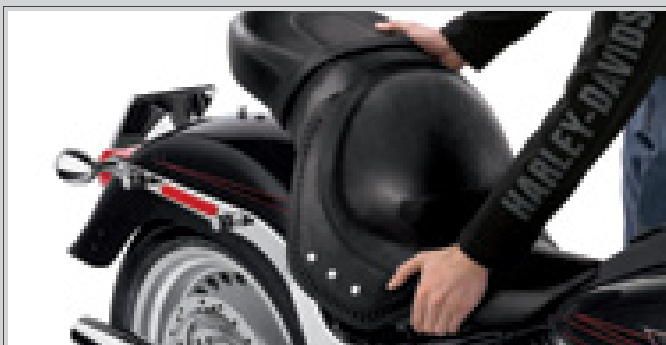

Switching out your seat is simple. And because certain rides call for certain styles, some folks like to have multiple seats to match the occasion. Install a comfortable, supportive touring seat for the longer treks, and swap it out for a low-profile seat for a night on the town. Please see your owner's manual for proper removal and installation of seats.

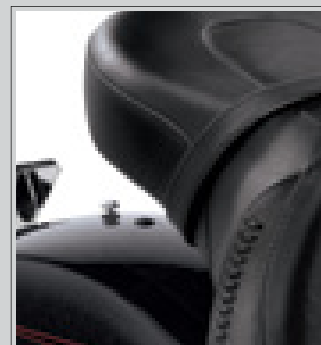





A. LEATHER BADLANDER SEAT

**A. LEATHER BADLANDER® SEAT**

The traditional Badlander® Seat, with a low and lean style is enhanced with supple top-grain leather and an embroidered "H-D" logo. Kit includes leather care product, seat, grab strap and mounting hardware.

**52359-06 \$239.95**

Fits '06-later Dyna® models. FXD and FXDB models require separate purchase of Seat Bumper Kit P/N 51653-06, Passenger Footpegs, and Passenger Footpeg Mounting Kit P/N 50210-06. Seat width 11.0"; passenger pillion width 5.0".

**52359-04 \$239.95**

Fits '04-'05 Dyna models. Seat width 11.0"; passenger pillion width 5.0".

**52359-97 \$239.95**

Fits '96-'03 Dyna models. Seat width 11.0"; passenger pillion width 5.0".

**B. BADLANDER® SEAT**

The popular Harley-Davidson® Badlander Seat is aggressively styled with a clean, smooth shape that flows from the fuel tank into the rear fender. Subtle top-stitching and the dual embroidered "Harley-Davidson" script logo add the finishing touches.

**52284-06 \$199.95**

Fits '06-later Dyna models. FXD and FXDB models require separate purchase of Seat Bumper Kit P/N 51653-06, Passenger Footpegs, and Passenger Footpeg Mounting Kit P/N 50210-06. Seat width 11.0"; passenger pillion width 5.0".

**52284-04 \$199.95**

Fits '04-'05 Dyna models. Seat width 11.0"; passenger pillion width 5.0".

**52284-96A \$199.95**

Fits '96-'03 Dyna models. Seat width 11.0"; passenger pillion width 5.0".

**52295-94A \$199.95**

Fits '82-'94 FXR models. Also fits '99-'00 FXR models. Seat width 11.0"; passenger pillion width 5.0".

**C. LOW-PROFILE LEATHER SEAT**

Prowl the town in style. Featured as Original Equipment on the '07 CVO Dyna model, this low-profile seat features a breathable perforated leather insert. The firm padding makes you feel a part of the bike, and the raised back stop keeps you in place when you hit the gas.

**52378-07 \$299.95**

Fits '06-later Dyna models. FXD and FXDB models require separate purchase of Passenger Footpegs and Passenger Footpeg Mounting Kit P/N 50210-06. Seat width 12.0"; passenger pillion width 7.0".



B. BADLANDER SEAT



C. LOW-PROFILE LEATHER SEAT

NOTE: Some Harley-Davidson® seats are made of leather. Fine leathers or other natural materials WILL gain "character," such as wrinkles or wear, with age. This is normal. A fine, aged patina and character wrinkles are a sign of the extremely high quality materials used to construct your seat or backrest. The appearance of scars or marks on the leather are a result of using natural leather panels and should not be thought of as an imperfection. Please use Harley-Davidson Leather Dressing P/N 98261-91V to protect your investment.

Notice: The prices appearing in this catalog are the manufacturer's suggested retail prices. Actual retail prices may vary.

# 136 DYNA®

## Seating

### A. BRAWLER® SEAT

When it's time to go it alone, go solo in style. These premium quality cowhide leather saddles are designed to create a subtle and distinctive look. Top-grain leather seating surfaces and contoured foam padding add long-haul comfort, and the durable hand-laid fiberglass seat pan is carpeted to protect the paint finish. Does not fit with passenger pillions.

**51375-06** **\$299.95**  
Fits '06-later Dyna® models. Seat width 12.5".

### B. SIDEKICK® SEAT

Share your custom ride. The two-up design of these premium cowhide leather seats offers a frame-hugging look, but adds back support for the rider, and additional padding for the passenger. Top-grain leather seating surfaces and contoured foam padding add long-haul comfort, and the durable hand-laid fiberglass seat pan is carpeted to protect the paint finish.

**51353-06** **\$369.95**  
Fits '06-later Dyna models. FXD and FXDB models require separate purchase of Passenger Footpegs, and Passenger Footpeg Mounting Kit P/N 50210-06. Seat width 12.5"; passenger pillion width 6.0".



A. BRAWLER SEAT



B. SIDEKICK SEAT

NOTE: Some Harley-Davidson® seats are made of leather. Fine leathers or other natural materials WILL gain "character," such as wrinkles or wear, with age. This is normal. A fine, aged patina and character wrinkles are a sign of the extremely high quality materials used to construct your seat or backrest. The appearance of scars or marks on the leather are a result of using natural leather panels and should not be thought of as an imperfection. Please use Harley-Davidson Leather Dressing P/N 98261-91V to protect your investment.

Notice: The prices appearing in this catalog are the manufacturer's suggested retail prices. Actual retail prices may vary.

THE CUSTOM SEAT PROGRAM  
ALLOWS YOU TO SELECT THE  
STITCH PATTERNS, LEATHER  
INLAYS AND THREAD COLORS  
TO COMPLEMENT FACTORY OR  
CUSTOM PAINT.

See pages 706-709 for more information.





D. STRIPPER SEAT

**D. STRIPPER® SEAT**

These cowhide leather low-profile saddles feature smooth lines to create a subtle and distinctive custom effect. Top-grain leather seating surfaces and contoured foam padding add long-haul comfort, and the durable hand-laid fiberglass seat pan is carpeted to protect the paint finish.

**51381-06** **\$369.95**

Fits '06-later Dyna® models. FXD and FXDB models require separate purchase of Passenger Footpegs, and Passenger Footpeg Mounting Kit P/N 50210-06. Seat width 12.5"; passenger pillion width 6.0".

**E. SIDEKICK® CUSTOM SEAT**

Combine the long and lean styling of our low-profile custom seat with the back support of the two-up seat, and you get the best of both worlds. These cowhide saddles feature smooth surfaces, a sleek tapered pillion for style and a rider position designed for comfort. Top-grain leather seating surfaces and contoured foam padding add long-haul comfort, and the durable hand-laid fiberglass seat pan is carpeted to protect the paint finish.

**51359-06** **\$369.95**

Fits '06-later Dyna® models. FXD and FXDB models require separate purchase of Passenger Footpegs, and Passenger Footpeg Mounting Kit P/N 50210-06. Seat width 12.5"; passenger pillion width 6.0".



E. SIDEKICK CUSTOM SEAT

**F. RALLYRUNNER® SEAT**

Share your custom ride. The two-up design of these premium cowhide leather seats offers a frame hugging look, but adds back support for the rider, and additional padding for the passenger. Top-grain leather seating surfaces and contoured foam padding add long-haul comfort, and the durable hand-laid fiberglass seat pan is carpeted to protect the paint finish.

**51369-06** **\$369.95**

Fits '06-later Dyna models. FXD and FXDB models require separate purchase of Passenger Footpegs, and Passenger Footpeg Mounting Kit P/N 50210-06. Seat width 12.5"; passenger pillion width 8.0".



F. RALLYRUNNER SEAT

NOTE: Some Harley-Davidson® seats are made of leather. Fine leathers or other natural materials WILL gain "character," such as wrinkles or wear, with age. This is normal. A fine, aged patina and character wrinkles are a sign of the extremely high quality materials used to construct your seat or backrest. The appearance of scars or marks on the leather are a result of using natural leather panels and should not be thought of as an imperfection. Please use Harley-Davidson Leather Dressing P/N 98261-91V to protect your investment.

Notice: The prices appearing in this catalog are the manufacturer's suggested retail prices. Actual retail prices may vary.

# 138 DYNA®

## Seating

### A. SOLO SPRING SADDLE – BROWN LEATHER

Add nostalgic “bobber” looks to your modern Harley-Davidson motorcycle. This elegant two-tone distressed leather solo seat features a low-profile design that provides the minimalist “just enough to ride” look. The torsion-style springs are designed for the optimum balance between spring suspension and support. The smooth metal seat pan and the simple frame cover leave a clean, finished appearance. Easy-to-install, the bolt-on seat and model-specific Spring Seat Installation Kits includes everything you need to get the bobber look. No cutting, welding, or fabrication is necessary, and the seat can be removed and replaced with a touring seat for a two-up night on the town.

**54072-10** **\$269.95**

Fits '10 XL, '04-'06 XL, and '06-later Dyna® models. Installation requires separate purchase of model-specific Seat Installation Kit P/N 54074-10 or 54075-10. Seat width 10.5".

#### Spring Seat Installation Kit

Required for installation of Solo Spring Saddle Kit P/N 54072-10. Kit includes springs, mounting brackets, frame cover and hardware.

**54075-10** **\$229.95**

Fits '06-later Dyna models.

### B. LOW-PROFILE SOLO SEAT – DISTRESSED BROWN LEATHER

Vintage looks meets modern comfort. Shaped to impart a minimalistic style reminiscent of the early 50s garage-built motorcycles, this solo seat establishes your street credibility from the moment you roll out of the garage. The low-profile seat hugs the frame for a slammed look, while its deep bucket design cradles the rider in surprising comfort. The rich brown leather has the warm distressed feel of a well-worn bomber jacket, and the supple untreated surfaces will continue to age and develop character marks with every mile. But you don't have to ride alone to appreciate the look. Add the matching Brown Leather Passenger Pillion P/N 54089-10 and Low Backrest Pad P/N 54091-10 and treat your date to a ride back in time.

**51937-10** **\$339.95**

Fits '06-later Dyna models. Seat width 12".

### C. PASSENGER PILLION – DISTRESSED BROWN LEATHER

Bring a passenger along for the ride. Styled to complement the Distressed Brown Solo Seat P/N 51937-10, this “fender pad” passenger pillion features a matching brown leather skirt and grab strap. Easy-to-install, the pad can be added or removed when your companionship situation changes.

**54089-10** **\$199.95**

Fits '06-later Dyna models equipped with Brown Solo Seat P/N 51937-10. Pillion width 5.5".

### D. REACH® SEAT

Designed specifically for riders requiring a close to the bar riding position, this seat positions the rider approximately 1" forward, closer to the hand and foot controls. The narrow front profile brings your legs closer together to help you plant your feet firmly on the ground. The seat features a textured vinyl insert and a “Harley-Davidson” logo that shows you are riding in style.

**52288-06** **\$249.95**

Fits '06-later Dyna models. FXD and FXDB models require separate purchase of Seat Bumper Kit P/N 51653-06, Passenger Footpegs, and Passenger Footpeg Mounting Kit P/N 50210-06. Seat width 12.0"; passenger pillion width 9.0".

**52288-04** **\$249.95**

Fits '04-'05 Dyna models. Seat width 12.0"; passenger pillion width 9.0".

**52289-04** **\$249.95**

Fits '96-'03 Dyna models. Seat width 12.0"; passenger pillion width 9.0".

NOTE: Some Harley-Davidson® seats are made of leather. Fine leathers or other natural materials WILL gain “character,” such as wrinkles or wear, with age. This is normal. A fine, aged patina and character wrinkles are a sign of the extremely high quality materials used to construct your seat or backrest. The appearance of scars or marks on the leather are a result of using natural leather panels and should not be thought of as an imperfection. Please use Harley-Davidson Leather Dressing P/N 98261-91V to protect your investment.

Notice: The prices appearing in this catalog are the manufacturer's suggested retail prices. Actual retail prices may vary.



A. SOLO SPRING SADDLE – BROWN LEATHER



B. LOW-PROFILE SOLO SEAT – DISTRESSED BROWN LEATHER

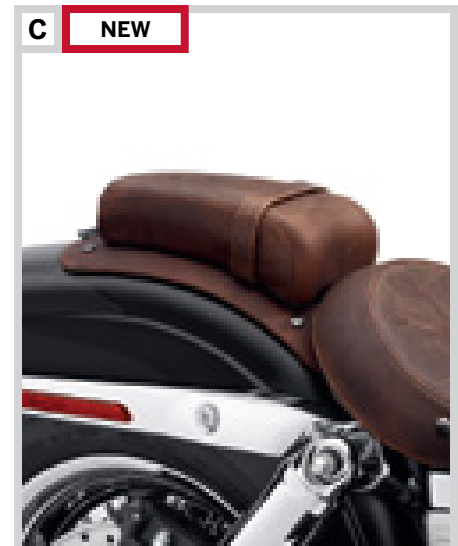

C. PASSENGER PILLION – DISTRESSED BROWN LEATHER



D. REACH SEAT





**E. SUNDOWNER DEEP BUCKET SEAT  
(SHOWN WITH SMOOTH BUCKET LOW BACKREST PAD)**



**F. SUNDOWNER DEEP BUCKET SOLO SEAT  
(SHOWN WITH SUNDOWNER PASSENGER PILLION)**



**G. TOURING SEAT**

### E. SUNDOWNER™ DEEP BUCKET SEAT

The Sundowner™ Deep Bucket Seat provides the maximum in long-riding™ comfort, along with a healthy helping of style and quality. This seat features a deep, contoured rider bucket that provides lower back support to keep you comfortable longer. The wide passenger pillion gives your passenger added comfort as well.

**51540-06 \$269.95**

Fits '06-later Dyna® models. FXD and FXDB models require separate purchase of Seat Bumper Kit P/N 51653-06, Passenger Footpegs, and Passenger Footpeg Mounting Kit P/N 50210-06. Seat width 16.0"; passenger pillion width 12.0".

**51540-04 \$269.95**

Fits '04-'05 Dyna models. Seat width 16.0"; passenger pillion width 12.0".

**51540-01A \$269.95**

Fits '96-'03 Dyna models. FXDWG models require separate purchase of Bracket P/N 52152-97. Seat width 16.0"; passenger pillion width 12.0".

**Shown with:**

#### LOW BACKREST PAD – SMOOTH BUCKET

Features large bucket shape, with a generous radius and ample padding. This backrest pad offers extra comfort for your passenger.

**51132-98 \$89.95**

Fits Low Medallion Plate-Style Sissy Bar Uprights.

### F. SUNDOWNER™ DEEP BUCKET SOLO SEAT

Ride solo on your Dyna motorcycle in Sundowner comfort and style. This unique seat combines the deep bucket design and added back support of the two-up seat with the stripped-down look of a solo saddle. Matching passenger pillion is available for added versatility.

**51933-06 \$199.95**

Fits '06-later Dyna models. Seat width 14.5".

**51933-04 \$199.95**

Fits '04-'05 Dyna models. Seat width 14.5".

**51933-01 \$199.95**

Fits '96-'03 Dyna models. Seat width 14.5".

**Shown with:**

#### SUNDOWNER PASSENGER PILLION

Bring someone along for the ride without giving up your solo status. This carefully styled pillion matches Dyna Sundowner Solo Seat and provides your passenger with that great Sundowner comfort.

**51473-06A \$129.95**

Fits '06-later Dyna models equipped with Sundowner Solo Seat P/N 51933-06 or Original Equipment solo seat (except '09-later FXDB and '10 FXDWG). FXD and FXDB models require separate purchase of Passenger Footpegs, and Passenger Footpeg Mounting Kit P/N 50210-06. Pillion width 12.0".

**51934-01 \$129.95**

Fits '96-'05 Dyna models (except FXDWG) equipped with Sundowner Solo Seat P/N 51933-01 or 51933-04. Pillion width 12.5".

### G. TOURING SEAT

For those looking for long-range comfort when riding their Dyna® motorcycle, this Touring Seat delivers. The seat is styled to complement the Wide Glide® motorcycle Original Equipment seat, and the deep bucket rider position and the wide passenger pillion are shaped to provide additional passenger room and comfort. Seat width: 15.0"; passenger pillion width 12.0".

**51472-06 \$229.95**

Fits '06-later Dyna models. FXD and FXDB models require separate purchase of Seat Bumper Kit P/N 51653-06, Passenger Footpegs, and Passenger Footpeg Mounting Kit P/N 50210-06.

# 140 DYNA®

## Seating

### A. TALLBOY® SEAT

Stretch your legs in style. The Tallboy® one-piece seat moves the rider back 1.75" and up 2.0" as compared to the Original Equipment seat. The new position allows additional leg and arm movement for the long-limbed rider, and a comfortable seating space for the open road. The Tallboy Seat also features a wide pillion for added passenger comfort.

**51471-06** **\$259.95**

Fits '06-later Dyna® models. FXD and FXDB models require separate purchase of Seat Bumper Kit P/N 51653-06, Passenger Footpegs, and Passenger Footpeg Mounting Kit P/N 50210-06. Seat width 16.0"; passenger pillion width 12.0".

### B. PILLOW-LOOK SEAT

This pillow-tufted seat features gathered surfaces and smooth side panels for a unique, visually appealing look, and a deep padded design for long-haul comfort. The seat includes an embroidered Bar & Shield logo for added style.

**52159-06** **\$229.95**

Fits '06-later Dyna models. FXD and FXDB models require separate purchase of Seat Bumper Kit P/N 51653-06, Passenger Footpegs, and Passenger Footpeg Mounting Kit P/N 50210-06. Seat width 12.0"; passenger pillion width 10.0".

### C. SEAT WITH ADJUSTABLE RIDER BACKREST

This rider backrest is the most adjustable on the market. With one quick pull from the integrated gas spring, you can instantly adjust the riding position through a 30-degree range. The backrest removes easily and has a push-button-activated, five position, 1.5" height adjustment. The rider backrest folds down to allow easier passenger mounting.

**53042-04** **\$499.95**

Fits '04-'05 Dyna® models. Seat width 15.5"; passenger pillion width 11.5".

**53042-01A** **\$499.95**

Fits '96-'03 Dyna models. FXDWG models require separate purchase of Bracket P/N 52152-97. Seat width 15.5"; passenger pillion width 11.5".

#### Shown with:

#### LOW BACKREST PAD – SMOOTH BUCKET

Features large bucket shape, with a generous radius and ample padding. This backrest pad offers extra comfort for your passenger.

**51132-98** **\$89.95**

Fits Low Medallion Plate-Style Sissy Bar Uprights.

Press push-button in the center of backrest pad to adjust vertically to five different heights.

**Backrest Height**

**Backrest Angle**

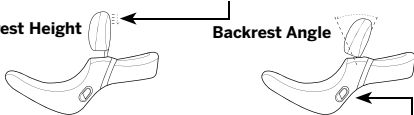

Pull tab on side of seat to adjust angle of backrest pad 30° forward or backward.



A. TALLBOY SEAT



B. PILLOW-LOOK SEAT



C. SEAT WITH ADJUSTABLE RIDER BACKREST  
(SHOWN WITH SMOOTH BUCKET LOW BACKREST PAD)

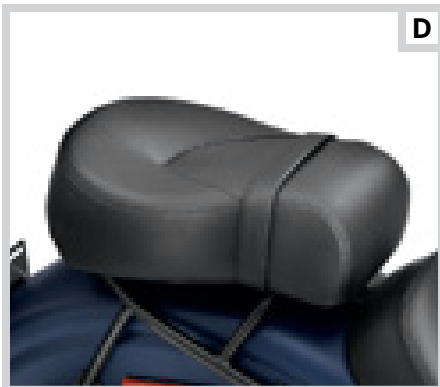

**D. DETACHABLE PASSENGER PILLION – INSTALLED**



**D. DETACHABLE PASSENGER PILLION – REMOVED**



**E. PASSENGER PILLION – DYNA SUPER GLIDE**



**F. PASSENGER PILLION – SMOOTH STYLING**

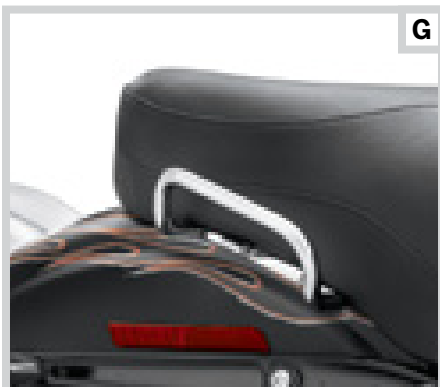

**G. PASSENGER GRAB RAIL**



**H. PASSENGER HANDRAIL COVERS**



**I. CHROME BILLET SEAT MOUNTING BRACKET**



**J. DETACHABLE SEAT HARDWARE KIT**

#### **D. DETACHABLE PASSENGER PILLION**

Styled to complement stock or accessory solo seats, this Passenger Pillion delivers maximum passenger comfort on the road. The pillion is easily removable from the Solo Rack P/N 52796-09 with a simple finger-pull release. The available Sissy Bar Upright P/N 52726-09 attaches directly to the pillion to provide a completely removable touring system.

**52689-09 \$179.95**

Fits '06-later Dyna® models (except FXDF or FXDFSE) with solo seats. Installation requires separate purchase of Rigid Solo Rack P/N 52796-09. FXD and FXDB models require separate purchase of Passenger Footpegs, and Passenger Footpeg Mounting Kit P/N 50210-06. Pillion width 11.0".

#### **E. PASSENGER PILLION – DYNA® SUPER GLIDE®**

Bring a passenger along for the ride. This Passenger Pillion matches the Dyna Super Glide® Original Equipment solo seat, and includes a passenger grab strap.

**51474-06A \$129.95**

Fits '06-later Dyna models (except '09-later FXDB and '10 FXDWG). FXD and FXDB models require separate purchase of Passenger Footpegs, and Passenger Footpeg Mounting Kit P/N 50210-06. Pillion width 9.5".

#### **F. PASSENGER PILLION – SMOOTH STYLING**

Bring a passenger along for the ride. This Passenger Pillion matches any smooth solo seat, and includes a passenger grab strap.

**51404-10 \$129.95**

Fits '09-later FXDB and '10 FXDWG models with Original Equipment solo seat. Installation on FXDB models requires separate purchase of Passenger Footpegs and Passenger Footpeg Mounting Kit P/N 50210-06.

**51535-06A \$129.95**

Fits '06-later Dyna models (except '09-later FXDB and '10 FXDWG). FXD and FXDB models require separate purchase of Passenger Footpegs and Passenger Footpeg Mounting Kit P/N 50210-06. Pillion width 9.5".

#### **G. PASSENGER GRAB RAIL**

Add comfort and confidence for your riding companion. Chrome-plated handrail provides a convenient hand grip for your passenger, and a secure tie-down point for pillion-mounted touring luggage. For a custom look, add Passenger Handrail Covers P/N 91668-05 (sold separately).

**97018-08 \$119.95**

Fits '06-later Dyna models equipped with a two-up seat (except FXDWG, FXDF, FXDFSE/2, and Dyna models equipped with Bobtail fender).

#### **H. PASSENGER HANDRAIL COVERS**

Beef up the look of the passenger handrail with these easy-to-install chrome-plated grips. The thick diameter offers a firm and comfortable hand hold for your passenger, and features jet black rubber inserts, "ball-milled" grooves and Bar & Shield logo for added style. Kit includes right and left grip and stainless steel mounting hardware.

**91668-05 \$54.95**

Fits '06-later Dyna, Softail® and '99-later Touring models equipped with accessory Passenger Grab Rails.

#### **I. CHROME BILLET SEAT MOUNTING BRACKET**

The highly stylized design of this bracket adds a stunning new look to the back of most seats.

**51804-02 \$19.95**

Replaces Bolt-On Seat Brackets P/N 51798-00, 51652-97 and 51652-83B used on most Original Equipment and accessory seats and pillions. See parts catalog or instruction sheet for your application.

#### **J. DETACHABLE SEAT HARDWARE KIT**

These hardware kits allow the rider to remove one-piece Harley-Davidson® seats quickly and easily.

**51676-97A \$19.95**

Fits '97-later XL, Dyna, Softail and Touring models. Does not fit seats equipped with spring-loaded rear seat bracket.

**51676-96 \$24.95**

Fits '96 XL, FXST, FXSTS and Dyna models with two-up, one-piece seats.

NOTE: These kits do not work with Softail® Seats with Rider Backrests.

# 142 DYNA®

## Seating

### A. CIRCULATOR SEAT PAD

Keep comfortable on your next long ride. These breathable Circulator Seat Pads feature 3D construction that promotes air movement and reduces heat build-up where the rider's body touches the seat. Designed to keep the rider cool by reducing the perspiration build-up between you and the seating surface, the Circulator Pad can be installed and removed in seconds for easy cleaning. The low-profile design minimizes seat-height change compared to inflatable pads, while enhancing comfort with its shock-absorbing construction. Manufactured of UV-stable materials, these seat pads resist fading when exposed to the sun. Elastic under-seat strap and non-slip base provide secure installation, and the available Circulator Passenger Pillion Pad attaches to the rider pad with hook-and-loop tabs.

**51074-10** Medium Pad (14.5" width). **\$79.95**  
Fits VRSC™, XL and Dyna® models with Original Equipment and accessory seats.

**51078-10** Passenger Pillion Pad (13.0" width). **\$69.95**  
Fits Original Equipment and accessory passenger pillions.

### B. RAIN COVERS\*

Featuring a handy storage sack, this black nylon, water-resistant, Cordura® cover packs easily and shelters your seat from the storm.

**51637-97** Two-Up Seat. **\$29.95**  
Fits H-D® two-up seats (except XR, FLSTS and Softail® Seats with Rider Backrests).

**51638-97** Solo Seat. **\$29.95**  
Fits H-D solo seats (except XR and FLSTS).



**\*WARNING:** Do not use while riding; could result in death or serious injury.

### C. REAR FENDER BIB

Go solo in style. Form-fitted to hug the contour of the rear fender, this decorative fender cover hides the seat mounting holes that are exposed when riding with a solo seat. Wrapped in smooth vinyl to match Original Equipment or accessory solo seats, the Fender Bib features an embossed Bar & Shield logo for added style. The molded base is finished with a soft felt under-liner designed to protect the fender's painted surface.

**52036-08** **\$59.95**  
Fits '06-later Dyna models equipped with Original Equipment solo seat, Brawler® Seat, or Sundowner™ Solo Seat.

### D. TANK BRA

This tank bra is made with nonabrasive, fleece-backed vinyl material and features an embroidered Bar & Shield logo. It protects your fuel tank from scratches from keys, belt buckles and other objects. Designed for easy installation and a custom fit without disassembly of the tank or seat.

**62028-04** Fits '04-later Dyna® models. **\$39.95**

**57799-00** **\$39.95**  
Fits '00-later Softail® models (except FXCW/C, FXSTD, FXSTSSE3 and FLSTSB) and '93-'03 FXDWG models.



A. CIRCULATOR SEAT PAD



B. RAIN COVER – TWO-UP SEAT



B. RAIN COVER – SOLO SEAT



C. REAR FENDER BIB

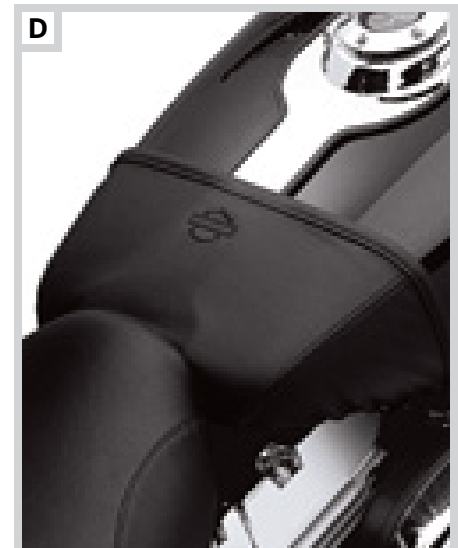

D. TANK BRA

Notice: The prices appearing in this catalog are the manufacturer's suggested retail prices. Actual retail prices may vary.



## COMFORT ON THE GO

*With a detachable backrest and luggage rack, your bike can go from a stripped-down afternoon cruiser to a fully loaded two-up touring machine in seconds. The backrest provides long-range comfort and support while adding a feeling of control and confidence for the passenger.*

### THE RIGHT COMBINATION

#### BUILD YOUR OWN

*A detachable sissy bar upright and backrest pad is the starting point for a complete touring machine. Start by shopping the following pages and selecting all the components required for your particular model.*



#### ALL IN ONE PIECE

*When brought together, the sideplates, upright, pad and luggage rack form a complete assembly that can be installed or removed from your bike in seconds.*



#### CHOOSE YOUR STYLE

*Sissy bar uprights are available in a wide variety of heights to satisfy your passenger's idea of comfort.*

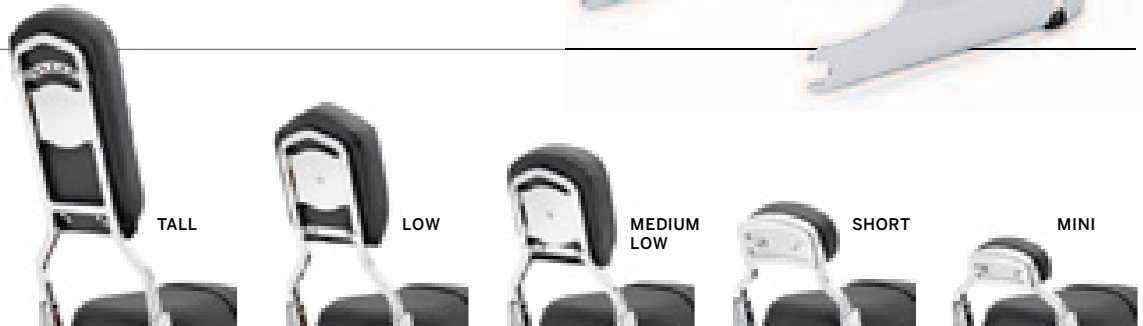

### CHANGING YOUR BACKREST



With a Docking Hardware Kit installed, adding or removing a detachable accessory is a simple “slide and click” proposition. Rotate the cam-lock to release the sissy bar from the rear docking points. Pivot the sissy bar forward, and lift it free from the front docking points.

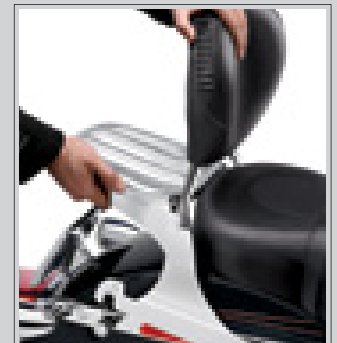

# Choosing a Backrest

A sissy bar upright and passenger backrest are the starting point to build a complete touring machine. The backrest provides long-range comfort and support, and adds a feeling of control and confidence for the passenger. For permanent installation, choose rigid sideplates and a style of upright that suits your riding style. For added flexibility, choose a detachable sideplate kit and appropriate Docking Hardware to make adding or removing a Detachable accessory a simple "slide and click" proposition.

**GENUINE HARLEY-DAVIDSON® Sissy Bar Sideplates**

Add your choice of sissy bar uprights, backrest pads and luggage racks when you install rigid or detachable sideplates to your motorcycle. Manufactured and tested to rigorous Harley-Davidson standards, these sideplates are designed to specific model application for exact fit.

**Rigid Mount Sideplates**

1. Fits '06-later Dyna® models (except FXDWG, FXDF, and FXDFSE/2).

**52856-06** Chrome. **\$84.95**

2. Fits '06-later FXDWG, '08-later FXDF and FXDFSE/2 models.

**53020-06A** Chrome. **\$104.95**

3. Fits '96-'05 FXD and FXDL models (standard on '96-'00 FXDS-CONV.). Also fits '99 and '02-'05 FXDX and '01-'05 FXDXT models.

**52783-96B** Chrome. **\$74.95**

**Detachable Sideplates**

4. Fits '06-later Dyna models. Requires separate purchase of appropriate docking hardware kit.

**52866-06** Chrome. **\$139.95**

**52124-09** Gloss Black. **\$139.95**

5. Fits '93-'05 FXDWG models. '93-'01 models using these sideplates in combination with Luggage Rack P/N 53711-96A, 53852-00 & 53866-00 will require separate purchase of Adapter Kit P/N 53828-00. ('02-later models with Luggage Rack P/N 53899-02 do not require Adapter Kit.) (Not compatible with Saddlebags.)

**53870-01A** Chrome. **\$139.95**

6. Fits '96-'05 Dyna models (except FXDWG and FXDXT). '96-'01 models using these sideplates in combination with Luggage Racks P/N 53711-96A, 53852-00 and 53866-00 will require separate purchase of Luggage Rack Adapter Kit P/N 53828-00.

**53543-95A** Chrome. **\$139.95**

**53834-00A** Wrinkle Black. **\$139.95**

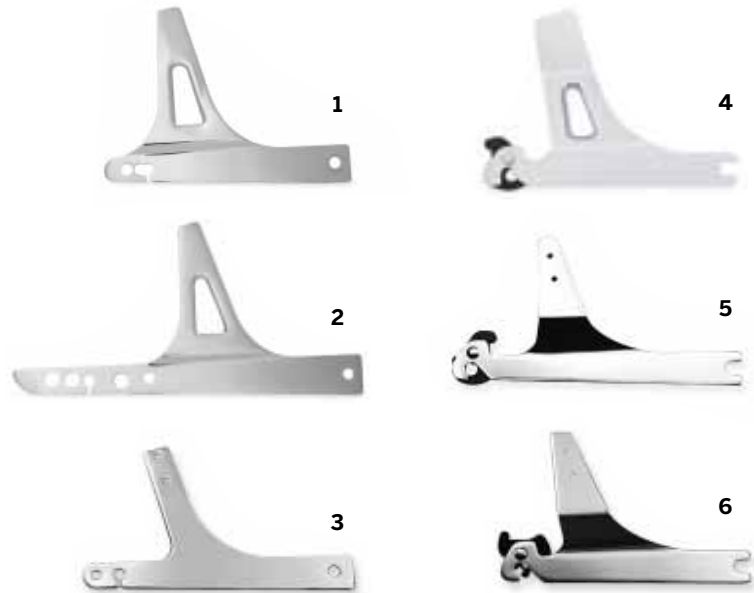

GENUINE HARLEY-DAVIDSON Sissy Bar Sideplates

**Dyna® Docking Hardware for Detachable Racks and Sideplates**

Docking hardware fitment is dependent on vehicle model and saddlebag configuration.

Detachable Accessory	Available to fit:	Detachable Sideplate Options	Required Docking Hardware	Turn Signal Relocation Kit
Detachable Sideplates; 53543-95A, 53834-00A only OR: with Saddlebags: 90390-98A, 90307-98	1999 FXDX, 1996-2001 FXD & FXDL	53543-95A – Chrome 53834-00A – Black	53527-95A \$41.95	– –
	2000-2001 FXDX	53543-95A – Chrome 53834-00A – Black	53839-00 \$23.95	– –
Detachable Sideplates; 53543-95A, 53834-00A only OR: with Saddlebags: 90564-02, 90369-02, 91617-03, 79300-06, 90564-06, 90369-06, 90181-08, 88200-09, 91615-09, 88348-10	2002-2005 FXD, FXDC, FXDL, & FXDX	53543-95A – Chrome 53834-00A – Black	53533-02A \$41.95	– –
Chrome Detachable Sideplates; 53870-01A only (Not compatible with Saddlebags)	1993-2001 FXDWG, 2001 FXDWG2, 2002 FXDWG3 & 2002-2005 FXDWG	53870-01A – Chrome	53858-01 \$41.95	– –
		53870-01A – Chrome	53882-02A \$41.95	
Detachable Sideplates; 53543-95A, 53834-00A with Hard Saddlebags 90126-00xx	1996-2001 FXD, FXDL, & 1999 FXDX 2002-2005 FXD, FXDC, & FXDL	53543-95A – Chrome 53834-00A – Black	53527-95A \$41.95	– –
		53543-95A – Chrome 53834-00A – Black	53533-02A \$41.95	
Detachable Sideplates; 52866-06 or Detachable Solo Rack 53511-06 with or without Saddlebags 79300-06, 90564-06, 90369-06, 90181-08, 88200-09, 91615-09	2006-2008 FXDWG & 2008-later FXDF and FXDFSE/2	52866-06 – Chrome 52124-09 – Gloss Black	53964-06A \$29.95	– –
Detachable Sideplates; 52866-06 or Detachable Solo Rack 53511-06 with Saddlebags 79300-06, 90564-06, 90369-06, 90181-08, 88200-09, 91615-09, 88348-10	2006-later FXD, FXDC, FXDL & FXDSE/2, '06-'08 FXDB	52866-06 – Chrome 52124-09 – Gloss Black	53961-06 \$41.95	– –
Detachable Sideplates 52866-06 or Detachable Solo Rack 53511-06 without Saddlebags.	2006-later FXD, FXDC, FXDL & FXDSE/2, '06-'08 FXDB	52866-06 – Chrome 52124-09 – Gloss Black	53961-06 \$41.95	53968-06C \$34.95
Detachable Sideplates; 52866-06 or Detachable Solo Rack 53511-06 with Saddlebags 79300-06, 90564-06, 90369-06, 90181-08, 88200-09, 91615-09, 88348-10	2009-later FXDB	52866-06 – Chrome 52124-09 – Gloss Black	53797-09 \$59.95	68227-09 \$84.95
Detachable Sideplates 52866-06 or Detachable Solo Rack 53511-06 without Saddlebags	2009-later FXDB	52866-06 – Chrome 52124-09 – Gloss Black	53797-09 \$59.95	53968-06C \$34.95
Detachable Sideplates 52866-06, 52124-09 or One-Piece Detachable Upright 51161-10 or Luggage Racks 54252-10, 54049-10, 54055-10; With or without saddlebags 90181-08A	2010 FXDWG	52866-06 – Chrome 52124-09 – Gloss Black	54097-10 \$41.95	53968-06C \$34.95

## Select a Height



Tall



Low



Medium Low



Short



Mini

### Tall Sissy Bar Uprights

Let your passenger ride tall in the saddle with a Tall Sissy Bar Upright. This upright provides maximum upper back support when equipped with your choice of Backrest Pad.

### Low Sissy Bar Uprights

Give your passenger additional back support with a Low Sissy Bar Upright, designed to accept a wide variety of backrest pads.

### Medium Low Sissy Bar Upright

Shaped to complement a thicker passenger pillion, this Sissy Bar Upright stands between the Low and Short Sissy Bar Upright. The ideal match for touring style seats, this upright also offers an additional height option to riders with custom style seats.

### Short Rail Sissy Bar Upright

This Sissy Bar Upright is lower than traditional low uprights and the hidden Backrest Pad Mounting System allows for a sleek look when the pad is removed.

### Mini Rail Sissy Bar Upright

Unique hidden Backrest Pad attachment makes for ultra-clean look with pad removed. NOTE: Must only be installed on models equipped with Badlander®, Stripper®, Sidekick®, Sidekick Custom and Rallyrunner® Style Seats.

DYNA

## Select a Style



Medallion Style



Insert Style



Mini Medallion Style



Padded Logo Style

### Padded Logo Insert

**99013-82 \$10.35**

For use with Low Sissy Bar Upright P/N 52739-83. (Separate purchase of screws P/N 2711 required for installation.)

## Select a Finish

### Square Tube Upright

Height	Style	Finish	'91-'01 Dyna® models, '82-'00 FXR models		'02-'05 Dyna models		'06-later Dyna models (except FXDF, FXDFSE/2 and '10 FXDWG)		'08-'09 FXDF and FXDFSE models	
			P/N	Price	P/N	Price	P/N	Price	P/N	Price
Mini	Insert	Chrome	52744-94	\$64.95	51512-02	\$64.95	52738-94A	\$64.95	—	—
Short	Insert	Chrome	52728-95	\$69.95	51513-02	\$69.95	52737-94A	\$69.95	—	—
Short	Insert	Gloss Black	—	—	—	—	52706-07	\$69.95	—	—
Short	Insert	Wrinkle Black	—	—	—	—	53010-98	\$69.95	—	—
Medium Low	Medallion	Chrome	—	—	—	—	52754-04	\$89.95	—	—
Medium Low	Medallion	Gloss Black	—	—	—	—	51851-09	\$94.95	—	—
Low	Insert	Chrome	—	—	51515-02	\$64.95	52736-85A	\$89.95	—	—
Low	Medallion	Chrome	52655-84	\$89.95	52909-02	\$89.95	52735-85	\$89.95	52877-08	\$89.95
Low	Medallion	Wrinkle Black	—	—	51517-02	\$89.95	53007-98	\$89.95	—	—
Low	Bar & Shield	Chrome	52739-83	\$89.95	51514-02	\$89.95	—	—	—	—
Tall	Insert	Chrome	—	—	51518-02	\$94.95	53552-81A	\$94.95	—	—
Tall	Medallion	Chrome	52777-85A	\$94.95	51519-02	\$94.95	52749-85A	\$94.95	—	—

### Round Tube Upright

Height	Style	Finish	Fits '10 FXDF, FXDFSE2 and FXDWG models							
			P/N	Price	P/N	Price	P/N	Price	P/N	Price
Low	Mini Medallion	Chrome	52877-10	\$89.95	—	—	—	—	—	—
Low	Mini Medallion	Gloss Black	51168-10	\$89.95	—	—	—	—	—	—

# 146 DYNA®

## Backrests & Racks

### A. ONE-PIECE DETACHABLE PASSENGER SISSY BAR UPRIGHT – GLOSS BLACK

The sweeping shape and gloss black finish of this slim solid bar Passenger Upright complements the classic "bobber" look of the Dyna Fat Bob and Wide Glide models. The one-piece design eliminates separate sideplates for a clean appearance, and the stylized upper kick angle mimics the old-school sissy bars of the 50s and 60s. Can be used with Passenger Backrest Pad P/N 52631-07.

**51161-10** Gloss Black. **\$199.95**  
Fits '10 FXDWG and FXDF models. Installation requires separate purchase of appropriate Docking Hardware Kit. Wide Glide models require separate purchase of Docking Hardware Kit P/N 54097-10 and Turn Signal Relocation Kit P/N 53968-06C.

#### Shown with:

#### PASSENGER BACKREST PAD

Styled to complement available touring and custom seats, this pad fits the Original Equipment FXSTC sissy bar upright.

**52631-07** **\$59.95**  
Fits models equipped with Sissy Bar Upright P/N 52729-08, 51853-07 or 51849-07.



A. ONE-PIECE DETACHABLE PASSENGER SISSY BAR UPRIGHT – GLOSS BLACK



B. PASSENGER SISSY BAR UPRIGHT (SHOWN WITH PASSENGER PILLION AND SMOOTH LOOK BACKREST PAD)

### B. PASSENGER SISSY BAR UPRIGHT

Styled to blend with the muscular look of the Dyna family, this gloss black upright attaches directly to the passenger pillion for a clean look. Combine with Backrest Pad P/N 51782-07 for a complete touring system.

**52726-09** Gloss Black. **\$59.95**  
Fits '06-later Dyna® models (except FXDF, FXDFSE/2 or '10 FXDWG) with solo seats. Installation requires separate purchase of Rigid Solo Rack P/N 52796-09 and Passenger Pillion P/N 52689-09.

#### Shown with:

#### SMOOTH LOOK PASSENGER BACKREST PAD

This backrest sports a smooth, clean finish that looks great with any smooth surface seat.

**51782-07** **\$69.95**  
Fits '07-later VRSC™ (except VRSCF) and '06-'07 VRSCR and '06 VRSCSE2 models equipped with Low Sissy Bar Upright P/N 51162-06 or 51313-07. Also fits FXCW models equipped with Sissy Bar Upright P/N 52804-08 and Dyna models equipped with Sissy Bar Upright P/N 52726-09.

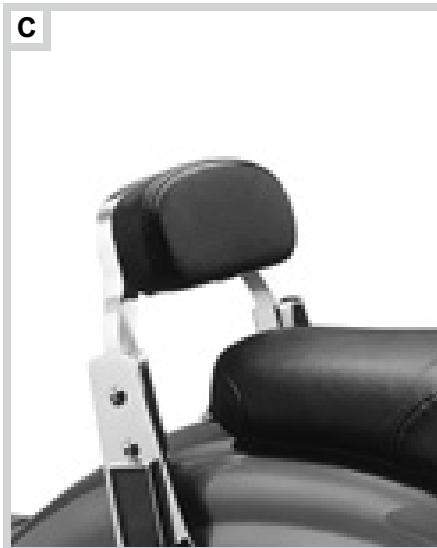

C. MINI RAIL BACKREST PAD

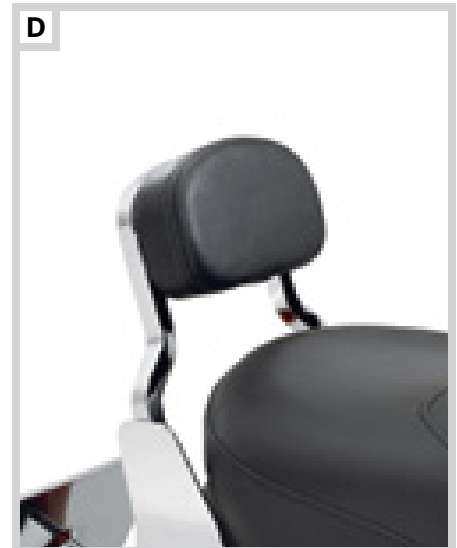

D. SHORT RAIL BACKREST PAD – SMOOTH

### C. MINI RAIL BACKREST PAD

Innovative Mounting System features a brushed stainless steel insert framed with chrome plate and hardware.

**52513-94** **\$49.95**  
Fits XL, FXR, FXD, and Softail® models (except FXSTD) equipped with Badlander® Seats, select low-profile seats and appropriate Mini Rail Sissy Bar Upright.

### D. SHORT RAIL BACKREST PAD

Innovative Backrest Pad Mounting System features a brushed stainless steel insert framed with chrome plate and hardware.

**52517-94** Smooth. **\$49.95**  
Fits Short Rail Sissy Bar Upright.

### E. SLIP-OVER PASSENGER BACKREST PAD

This Slip-Over Backrest Pad provides a touch of passenger comfort, while maintaining the long, lean style of the Dyna Wide Glide model. Held in place with hook-and-loop tabs, this rich black pad features grey stitching that complements the Original Equipment seat and pillion.

**51732-10** **\$59.95**  
Fits '10 FXDWG models with Original Equipment sissy bar upright.

### F. MEDIUM LOW BACKREST PADS

Styled to complement Original Equipment and accessory seats, these pads are sized to match the Medium Low Sissy Bar Upright. Backrest pads include chrome-plated mounting hardware.

Fits Medium Low Medallion Plate-Style Sissy Bar Upright.

**1. 52652-04** Smooth. **\$59.95**  
**2. 52626-04** Smooth Top-Stitched. **\$59.95**  
**3. 52656-04** Pillow-Look. **\$59.95**



E. SLIP-OVER PASSENGER BACKREST PAD



F. MEDIUM LOW BACKREST PADS

Notice: The prices appearing in this catalog are the manufacturer's suggested retail prices. Actual retail prices may vary.





G

G. LOW BACKREST PADS



NEW

H

H. LOW BACKREST PAD – DISTRESSED BROWN LEATHER

**G. LOW BACKREST PADS**

Includes all necessary mounting hardware.

Fits Low Medallion Plate-Style Sissy Bar Upright.

1. 52412-79A	With Embossed Bar & Shield Logo.	\$59.95
2. 52545-84	Pillow-Look.	\$59.95
3. 52612-95	Smooth Top-Stitched.	\$59.95

**H. LOW BACKREST PAD – DISTRESSED BROWN LEATHER**

Styled to complement the Distressed Brown Leather seat and saddlebag collection, this top-stitched pad is sized to match the Low Sissy Bar Upright. Backrest pads include chrome-plated mounting hardware.

54091-10		\$99.95
Fits Low Medallion Plate-Style Sissy Bar Upright.		

**I. LOW BACKREST PAD – DYNA® LOW RIDER®**

Matches the stitch pattern on the '06-later Dyna FXDL model.

51711-06		\$59.95
Fits Low Medallion Plate-Style Sissy Bar Upright.		

**J. LOW BACKREST PAD – TOURING**

With a larger backrest pad for comfortable two-up cruising, this pad is designed to complement Sportster® and Dyna® Seats.

51667-98		\$59.95
Fits Low Medallion Plate-Style Sissy Bar Upright.		

**K. LOW BACKREST PAD – SMOOTH BUCKET**

Features large bucket shape, with a generous radius and ample padding. This backrest pad offers extra comfort for your passenger.

51132-98		\$89.95
Fits Low Medallion Plate-Style Sissy Bar Upright.		

**L. TALL BACKREST PADS**

Quality backrest pads include chrome-plated mounting brackets and hardware.

Fits Tall Insert-Style or Medallion Plate-Style Sissy Bar Uprights.

1. 52965-98	Smooth Top-Stitched.	\$69.95
2. 91770-85	Pillow-Look.	\$69.95

**M. SISSY BAR UPRIGHT SLIP-OVER BACKREST PADS**

Slip-on for passenger comfort. Easily removed to show off chrome sissy bar upright.

52563-82	Fits Tall Sissy Bar Upright.	\$59.95
91819-85	Fits Low Sissy Bar Upright.	\$59.95

**N. CHROME BACKREST MOUNT**

Chrome-plated backrest mount with hidden fasteners. Allows the mounting of sissy bar medallions or can be used as-is for a clean look.

52527-01	Mini Rail Upright.	\$25.95
Fits XL, Dyna, and Softail® models equipped with Harley-Davidson Mini Sissy Bar Upright and matching Backrest Pad.		

52531-01	Short Rail Upright.	\$25.95
Fits XL, Dyna, and Softail models equipped with Harley-Davidson Short Sissy Bar Upright and matching Backrest Pad.		



I

I. LOW BACKREST PAD – DYNA LOW RIDER



J

J. LOW BACKREST PAD – TOURING



K

K. LOW BACKREST PAD – SMOOTH BUCKET



L

L. TALL BACKREST PADS



M

M. SISSY BAR UPRIGHT SLIP-OVER BACKREST PADS

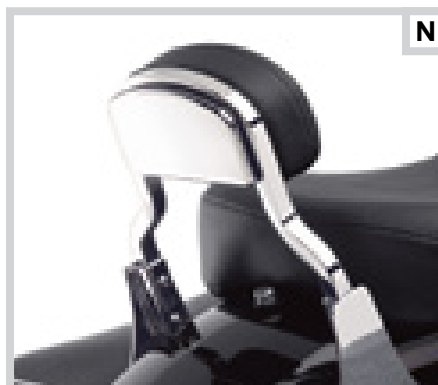

N

N. CHROME BACKREST MOUNT – SHORT RAIL

DYNA

Notice: The prices appearing in this catalog are the manufacturer's suggested retail prices. Actual retail prices may vary.

# 148 DYNA®

## Backrests & Racks

### A. CHOPPED FENDER LUGGAGE RACK\*

This Luggage Rack is the ideal option for your ride across town or across the state. Designed for the chopped rear fender featured on the Wide Glide model, this simple rack adds practical luggage space without compromising style. Rear supports attach to the fender struts, and the rack is secured to the passenger pillion mounting point on the rear fender. Rack is compatible with Detachable accessories and Docking Hardware, and is styled to complement the Original Equipment Short Upright or the available One-Piece Detachable Upright P/N 51161-10.

**54252-10** Gloss Black. **\$129.95**  
Fits '10 FXDWG models.

### B. TAPERED LUGGAGE RACKS\*

Styled to enhance the lines of the motorcycle, this sleek, compact Tapered Rack is an elegant solution for carrying your lunch to work or your luggage across the country.

Fits '04-later XL models equipped with Detachable Sideplates, '06-later Dyna® models (except FXDF, FXDFSE/2 and '10 FXDWG) equipped with Rigid or Detachable Sideplates, '00-'05 Softail® models (except FXSTD and FLSTN) and '06-later FLST, FLSTC and FLSTSC models equipped with Detachable or Rigid Mount Sideplates.

**53718-04** Chrome. **\$119.95**  
**53510-07** Gloss Black. **\$119.95**

Fits '04-later XL models equipped with Rigid Sideplates P/N 53925-04 and '02-'05 Dyna models equipped with Rigid Sideplates or Detachable Sideplates.

**53742-04** Chrome. **\$119.95**

### C. TAPERED SPORT LUGGAGE RACK – FIVE BAR\*

Cross town or cross-country, this rack adds touring flexibility to your Fat Bob® model. This rack is the perfect addition to the necessary sissy bar upright and sideplate kits available for your Fat Bob model.

**53982-08** Chrome. **\$134.95**  
Fits '08-'09 FXDF and '09-later FXDFSE models with Rigid or Detachable Sideplates. Requires separate purchase of Upright P/N 52877-08.

### D. CUSTOM TAPERED SPORT LUGGAGE RACK

Smooth sweeping curves and rich finishes define the look of this Sport Luggage Rack. Designed to complement the Custom Low Upright, this rack adds a practical and stylish touch to the rear of the Fat Bob and Wide Glide models.

Fits '10 FXDF, FXDFSE2 and FXDWG models equipped with Rigid or Detachable Sideplates and Sissy Bar Uprights.

**54049-10** Gloss Black. **\$134.95**  
**54055-10** Chrome. **\$134.95**



A. CHOPPED FENDER LUGGAGE RACK



B. TAPERED LUGGAGE RACK – CHROME

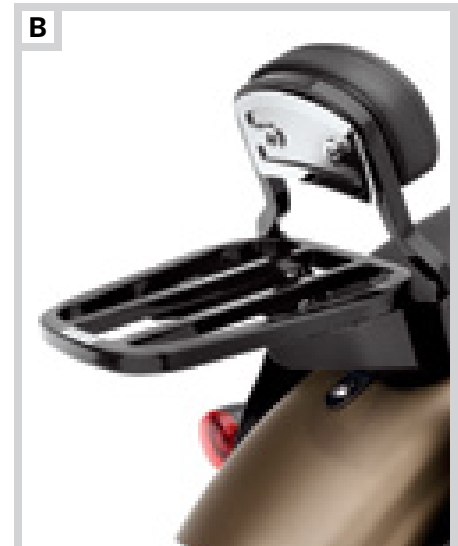

B. TAPERED LUGGAGE RACK – GLOSS BLACK



C. TAPERED SPORT LUGGAGE RACK – FIVE BAR, CHROME



D. CUSTOM TAPERED SPORT LUGGAGE RACK – GLOSS BLACK



**\*WARNING:** Do not use this rack as a seat. Do not exceed the fender rack weight capacity. Using as seat or exceeding this capacity could cause handling problems which could result in loss of control and death or serious injury.

Notice: The prices appearing in this catalog are the manufacturer's suggested retail prices. Actual retail prices may vary.



**E. SPORT LUGGAGE RACK –  
FOUR BAR, CHROME**



**E. SPORT LUGGAGE RACK –  
FOUR BAR, WRINKLE BLACK**



**F. SPORT LUGGAGE RACK –  
FIVE BAR, CHROME**



**F. SPORT LUGGAGE RACK –  
FIVE BAR, WRINKLE BLACK**



**G. TWO-UP SPORT LUGGAGE RACK – CHROME**

#### **E. SPORT LUGGAGE RACKS – FOUR BAR\***

This sleek rack complements the lines of your motorcycle. Can be used with Detachable or Rigid Mount Sissy Bar Sideplates.

Fits '04-later XL models equipped with Rigid Sideplates P/N 53925-04 and '02-'05 Dyna models equipped with Rigid Sideplates or Detachable Sideplates.

<b>53899-02</b>	Chrome.	<b>\$119.95</b>
<b>53900-02</b>	Wrinkle Black.	<b>\$119.95</b>

Fits '90-'03 XL models with Detachable Sideplate Kit P/N 53545-95. '82-'03 XL models with Rigid Mount Sideplate Kit P/N 52806-94B or 52782-82B; '82-'94 FXR models with Rigid Sideplate Kit P/N 52781-82B (except FXRS-CONV. and FXRT). Fits '96-'01 Dyna models (except FXDWG). All '96-'01 Dyna models equipped with Rigid Mount Sideplates require the separate purchase of Luggage Rack Adapter Kit P/N 53828-00. Also fits '99-'00 FXR models.

<b>53711-96A</b>	Chrome.	<b>\$119.95</b>
------------------	---------	-----------------

#### **F. SPORT LUGGAGE RACKS – FIVE BAR\***

This rack brings touring flexibility to your motorcycle. Can be used with Detachable or Rigid Mount Sissy Bar Sideplates.

Fits '04-later XL models equipped with Detachable Sideplates, '06-later Dyna® models (except FXDF, FXDFSE/2 and '10 FXDWG) equipped with Rigid or Detachable Sideplates, '00-'05 Softail® models (except FXSTD and FLSTN), and '06-later FLST, FLSTC and FLSTSC models equipped with Rigid or Detachable Sideplates.

<b>53862-00</b>	Chrome.	<b>\$134.95</b>
<b>53939-03</b>	Wrinkle Black.	<b>\$134.95</b>

#### **G. TWO-UP SPORT LUGGAGE RACK\***

A sleek rack that complements the lines of your motorcycle. Works with both Detachable and Rigid Mount Sideplates.

<b>53866-00</b>	Chrome.	<b>\$149.95</b>
-----------------	---------	-----------------

Fits '90-'03 XL models with Detachable Sideplate Kit P/N 53545-95. '82-'03 XL models with Rigid Mount Sideplate Kit P/N 52806-94B or 52782-82B; '82-'94 FXR models with Rigid Sideplate Kit P/N 52781-82B (except FXRS-CONV. and FXRT). Fits '96-'01 Dyna® models (except FXDWG). '96-'01 Dyna models equipped with Rigid Mount Sideplates require the separate purchase of Luggage Rack Adapter Kit P/N 53828-00. Also fits '99-'00 FXR models.

#### **LUGGAGE RACK ADAPTER KIT (not shown)**

This kit has been specifically developed for Dyna® Convertible™ owners to adapt the Chrome Luggage Rack P/N 53711-96A to sideplates and uprights. Also required to mount Luggage Racks P/N 53711-96A, 53866-00 and 53860-00 to Rigid and Detachable Sideplates for '96-'01 Dyna models.

<b>53828-00</b>		<b>\$9.95</b>
-----------------	--	---------------

Fits '94-'00 FXDS-CONV. models and '96-'01 FXD, FXDL and FXDX with Rigid Sideplate P/N 52783-96B or Detachable Sideplate P/N 53543-95A or 53834-00A.



**\*WARNING:** Do not use this rack as a seat. Do not exceed the fender rack weight capacity. Using as seat or exceeding this capacity could cause handling problems which could result in loss of control and death or serious injury.

Notice: The prices appearing in this catalog are the manufacturer's suggested retail prices. Actual retail prices may vary.

# 150 DYNA®

## Backrests & Racks

### A. RIGID SOLO RACK\*

Versatile rigid-mount Solo Luggage Rack features a rich gloss black finish that complements almost any paint color. Equip the contoured rack with a duffle bag for a cross-country solo ride, or attach the available Detachable Passenger Pillion P/N 52689-09 for a comfortable two-up tour.

**52796-09** Gloss Black. **\$159.95**  
Fits '06-later Dyna models with solo seats (except FXDF, FXDFSE/2 or '10 FXDWG).

### B. DETACHABLE SOLO RACK\*

Add touring capabilities to your solo seat Dyna model in less than 60 seconds. This Detachable Solo Rack fits over the fender when the passenger pillion is removed. The rack features a hand-polished and chrome-plated finish to add a stylish flair. Requires Docking Hardware.

**53511-06** Chrome. **\$199.95**  
Fits '06-later Dyna models (except FXDF, FXDFSE/2 or '10 FXDWG) equipped with solo seat. Requires separate purchase of appropriate Detachable Docking Hardware.

### C. BOBTAIL FENDER RACK\*

Enhances sculpted Bobtail rear fender. Manufactured of polished and chrome-plated steel tubing.

**56802-06** **\$99.95**  
Fits '06-'08 FXDWG and '08-'09 FXDF models.  
Does not fit FXDFSE.

**56495-02** **\$99.95**  
Fits '02-'05 FXDWG models. Installation of Bobtail Rack with Saddlebags P/N 79078-02 or 91622-03 requires Turn Signal Relocation Kit P/N 68718-02.

**56469-93C** Fits '93-'01 FXDWG models. **\$99.95**

### D. DETACHABLES LOCK\*\*

Now you can have the convenience of Detachables with the security of barrel locks. This unique lock replaces the cam-lock on your Harley-Davidson® Detachable accessories, providing additional security and peace-of-mind when parking your vehicle. Kit includes two extended-reach barrel-style keys for easy access to the lock. Designed exclusively by Harley-Davidson. Key registration\* and replacement service is available.

Fits all models equipped with Detachable Sideplates, Racks and Tour-Pak® Luggage Carriers (except '09-later Touring models equipped with Detachable Solo Tour-Pak® Rack).

**46063-98** Single. **\$46.95**  
~~**46106-00** Set of two. **OBSOLETE** **\$89.95**~~

\*\*Key Registration and Replacement Service: This service is provided by the lock manufacturer. Information is included in the product packaging.

### E. REAR DOCKING HARDWARE COVER KIT

Disguise the rear docking hardware with these easy-to-install covers. The caps slide over the exposed docking points, and are held in place by a strong magnetic pull. The caps are easy to remove when you wish to reinstall detachable accessories. Covers are available with brilliant chrome or durable gloss black finish to match your bike's attitude (*sold in pairs*).

Fits many accessory docking hardware kits. Refer to the fitment matrix in the P&A Catalog page 543 or the Parts & Accessories section of [www.harley-davidson.com](http://www.harley-davidson.com) for details.

**48218-10** Short Chrome (*pair*). **\$24.95**  
**48220-10** Large Chrome (*pair*). **\$24.95**  
**48035-09** Small Chrome (*pair*). **\$24.95**  
**48221-10** Short Black (*pair*). **\$24.95**  
**48223-10** Large Black (*pair*). **\$24.95**  
**48225-10** Small Black (*pair*). **\$24.95**



**\*WARNING:** Do not use this rack as a seat. Do not exceed the fender rack weight capacity. Using as seat or exceeding this capacity could cause handling problems which could result in loss of control and death or serious injury.



A. RIGID SOLO RACK



B. DETACHABLE SOLO RACK



C. BOBTAIL FENDER RACK (56802-06 SHOWN)



C. BOBTAIL FENDER RACK (56495-02 SHOWN)



D. DETACHABLES LOCK



E. REAR DOCKING HARDWARE COVER KIT – CHROME SHOWN

Notice: The prices appearing in this catalog are the manufacturer's suggested retail prices. Actual retail prices may vary.



## LOAD IT UP

*Rain gear, extra clothing and basic supplies are easy to take along when you add soft luggage to your bike. Designed for maximum versatility, this complete collection of saddlebags, soft touring luggage and compact storage pouches makes sure you can pack what you need for your next trip.*

### NEAR OR FAR



#### SADDLEBAGS

*Saddlebags are available in many different styles. Hard saddlebags offer lockable, color-matched storage with a sleek profile. Rigid saddlebags combine the look of leather with the security of hard bags. And leather saddlebags feature classic good looks that were born on the boulevard.*



#### SOFT LUGGAGE (RIGHT)

*Pack for work or a cross-country ride. Available in a variety of sizes, these Touring bags provide convenient and versatile storage.*

#### WINDSHIELD BAGS (LEFT)

*Versatile windshield bags fit most windshields, and offer convenient storage for sunglasses, maps and toll-booth change.*

#### SISSY BAR BAGS

*Compact and convenient, a Sissy Bar Bag fits right behind your seat for quick and easy access. Perfect for phones, maps and sunscreen.*



# 152 DYNA®

Saddlebags & Luggage

## A. COLOR-MATCHED HARD SADDLEBAGS FOR DYNA® MODELS\*

The Dyna models are designed to devour miles and these bags add to the appetite. Painted to match your factory paint, these bags are lockable and provide secure storage for the road. Using injection-molded construction, these bags offer a fresh, alternative look as compared with their leather cousins. Kit includes Turn Signal Relocation hardware. Luggage capacity: 2500 cubic inches total.

Fits '96-later Dyna models (except FXDS-CONV, '00-'03 FXDX, FXDXT, '09-later FXDB and '10 FXDWG). Fits with Detachable or rigid-mounted Sissy Bars and luggage racks. (Will not fit FXDWG or FXDF models equipped with Detachable Sideplates.)

<b>90126-00A</b>	Primed.	<b>\$1,149.95</b>
<b>90126-09CWR</b>	Big Purple Flake.	<b>\$1,399.95</b>
<b>90126-05BPS</b>	Black Cherry.	<b>\$1,399.95</b>
<b>90126-07BYM</b>	Black Denim.	<b>\$1,399.95</b>
<b>90126-09CWL</b>	Black Ice.	<b>\$1,399.95</b>
<b>90126-05BPY</b>	Black Pearl.	<b>\$1,399.95</b>
<b>90126-04BHT</b>	Brilliant Silver.	<b>\$1,399.95</b>
<b>90126-10COV</b>	Brilliant Silver Denim.	<b>\$1,399.95</b>
<b>90126-08CPF</b>	Candy Red Sunglo.	<b>\$1,399.95</b>
<b>90126-08CPL</b>	Copperhead Pearl.	<b>\$1,399.95</b>
<b>90126-08CPH</b>	Copper Pearl.	<b>\$1,399.95</b>
<b>90126-08CPD</b>	Crimson Red Denim.	<b>\$1,399.95</b>
<b>90126-08CPG</b>	Dark Blue Denim.	<b>\$1,399.95</b>
<b>90126-08CPC</b>	Dark Blue Pearl.	<b>\$1,399.95</b>
<b>90126-00ZL</b>	Diamond Ice Pearl.	<b>\$1,399.95</b>
<b>90126-04BHX</b>	Glacier White Pearl.	<b>\$1,399.95</b>
<b>90126-08CPJ</b>	Golden Glow.	<b>\$1,399.95</b>
<b>90126-03BDT</b>	Gunmetal Pearl.	<b>\$1,399.95</b>
<b>90126-06BXY</b>	Fire Red Pearl.	<b>\$1,399.95</b>
<b>90126-09CWA</b>	Flame Blue Pearl.	<b>\$1,399.95</b>
<b>90126-09CWT</b>	Light Candy Root Beer.	<b>\$1,399.95</b>
<b>90126-01XE</b>	Luxury Blue.	<b>\$1,399.95</b>
<b>90126-08COS</b>	Olive Pearl Denim.	<b>\$1,399.95</b>
<b>90126-07CHG</b>	Pacific Blue Denim.	<b>\$1,399.95</b>
<b>90126-07CGP</b>	Pacific Blue Pearl.	<b>\$1,399.95</b>
<b>90126-07CHH</b>	Pewter Denim.	<b>\$1,399.95</b>
<b>90126-07CGR</b>	Pewter Pearl.	<b>\$1,399.95</b>
<b>90126-08CPK</b>	Purple Haze. <del>OBSOLETE</del>	<del>\$1,399.95</del>
<b>90126-02BBN</b>	Real Red.	<b>\$1,399.95</b>
<b>90126-09CYS</b>	Red Hot Sunglo.	<b>\$1,399.95</b>
<b>90126-05BPV</b>	Rich Sunglo Blue.	<b>\$1,399.95</b>
<b>90126-10DBJ</b>	Scarlet Red.	<b>\$1,399.95</b>
<b>90126-04BHS</b>	Sierra Red.	<b>\$1,399.95</b>
<b>90126-03BDP</b>	Sterling Silver.	<b>\$1,399.95</b>
<b>90126-08CPE</b>	Sunset Yellow Pearl <del>OBSOLETE</del>	<del>\$1,399.95</del>
<b>90126-00DH</b>	Vivid Black.	<b>\$1,399.95</b>
<b>90126-07CGS</b>	White Gold Pearl.	<b>\$1,399.95</b>
<b>90126-02ZB</b>	White Pearl.	<b>\$1,399.95</b>

Also available:

### SADDLEBAG LINERS FOR SPORTSTER® AND DYNA HARD SADDLEBAGS (not shown)

These saddlebag liners make for easy packing and quick gear removal, and also feature an inner pocket for smaller road necessities.

**91486-01** **\$44.95**

Fits XL and Dyna models equipped with Color-Matched Hard Saddlebags.



A. COLOR-MATCHED HARD SADDLEBAGS FOR DYNA MODELS – WHITE GOLD PEARL SHOWN



A. COLOR-MATCHED HARD SADDLEBAGS FOR DYNA MODELS – VIVID BLACK SHOWN

\*NOTE: This product is a "Paint to Order" accessory. Please allow for an average of 5 weeks delivery for this item.

Notice: The prices appearing in this catalog are the manufacturer's suggested retail prices. Actual retail prices may vary.



**B. DETACHABLE LEATHER SADDLEBAGS FOR DYNA MODELS**



**B. DETACHABLE LEATHER SADDLEBAGS FOR DYNA MODELS – SHOWN WITH SADDLEBAG REMOVED**



**C. LEATHER THROW-OVER SADDLEBAGS**

**B. DETACHABLE LEATHER SADDLEBAGS FOR DYNA® MODELS**

These large capacity Detachable Saddlebags are completely removable with the simple pull of the internal handle, leaving your bike clean and ready to cruise the boulevard. The handsome leather bags feature hidden quick-release clips behind the traditional strap and buckle. When removed, the large capacity bags leave behind two simple, inconspicuous docking points. The bags are compatible with both rigid and detachable accessories when installed with the appropriate docking hardware kits. Luggage capacity: 2400 cubic inches total.

**90181-08A \$899.95**

Fits '06-later Dyna models. '09-later FXDB models require separate purchase of Turn Signal Relocation Kit P/N 68227-09. '10-later FXDWG models require separate purchase of Turn Signal Relocation Kit P/N 68544-10. All other models (except '06-'08 FXDWG) require separate purchase of Turn Signal Relocation Kit P/N 68732-02A (Domestic), P/N 68733-02A (International) or Layback License Plate Kit P/N 60215-06. Does not fit with Rear Axle Covers. (Available September 2009)

**TURN SIGNAL RELOCATION KIT**

Kit moves turn signals from rear fender struts to a license bracket mounted turn signal bar.

Required for installation of rigid mounted saddlebags and detachable accessories on '09-later FXDB models.

**68227-09 \$84.95** Fits '09-later FXDB models.

Required to install Saddlebag P/N 91615-09, 88200-09, 90181-08A, 90460-06B, 79300-06A, 90564-06B, 90369-06A, 90369-02, 91615-09 and 88200-09. Fits '02-later Dyna models (except FXDWG, FXDF and '09-later FXDB) and '04-later XL models (except XL883N and XL1200N). Does not fit with Layback License Plate Mounting Kits.

**68732-02A \$74.95** Domestic.

**68733-02A \$84.95** International.

Required to install Saddlebag P/N 79078-02, 79300-04B and 91622-03.

**68718-02 \$39.95** Fits '02-'05 FXDWG models.

**DYNA LICENSE PLATE/TURN SIGNAL RELOCATION KIT**

Required for installation of Saddlebags.

**68544-10 \$199.95**

Fits '10-later FXDWG models. (Available September 2009)

**C. LEATHER THROW-OVER SADDLEBAGS**

The ideal complement to the '07-later Nightster model, these traditional Leather Throw-Over bags feature large side gussets for increased capacity and full-length straps with hidden quick disconnect clips for easy access.

**91008-82C \$299.95**

Fits '82-later XL, '08-later Dyna and '84-'99 Softail® models equipped with H-D® Chrome Saddlebag Supports.

NOTE: Some Harley-Davidson® saddlebags are made of leather. Fine leathers or other natural materials WILL gain "character," such as wrinkles or wear, with age. This is normal. A fine, aged patina and character wrinkles are a sign of the extremely high quality materials used to construct your saddlebags. The appearance of scars or marks on the leather are a result of using natural leather panels and should not be thought of as an imperfection. Please use Harley-Davidson Leather Dressing P/N 98261-91V to protect your investment.

Notice: The prices appearing in this catalog are the manufacturer's suggested retail prices. Actual retail prices may vary.



# 154 DYNA®

## Saddlebags & Luggage

### A. DISTRESSED BROWN LEATHER SADDLEBAGS

A vintage look for a modern ride. These large-capacity saddlebags are dressed in brown distressed leather for a timeless appearance. The raw edging and untreated leather surfaces will age and weather for a warm, comfortable feel, but the rigid back construction will help the bag hold its shape. Dark metal snaps and an embossed Bar & Shield logo continue the Bomber Jacket look. Luggage capacity: 2380 cubic inches total.

**88348-10** **\$599.95**

Fits '02-later Dyna® models (except '02-'05 FXDWG). '02-'05 models require separate purchase of Mounting Hardware Kit P/N 92025-09. '10-later FXDWG models require separate purchase of Turn Signal Relocation kit P/N 68544-10. '09-later FXDB models require separate purchase of Turn Signal Relocation Kit 68227-09. All other years and models (except FXDF and FXDWG) require separate purchase of Turn Signal Relocation Kit 68732-02A (Domestic), 68733-02A (International) or Layback License Plate Kit 60215-06. Not compatible with Rear Axle Covers on FXDF and FXDWG models.

### B. DISTRESSED LEATHER SADDLEBAGS

Step over to the dark side. Distressed leather and aged buckles provide a weathered, "anti-chrome" look to your blacked-out ride. The riveted "Dark Custom" patch on the rear of each bag completes the edgy, tradition-breaking appearance. Luggage capacity: 2380 cubic inches total.

**88200-09A** **\$599.95**

Fits '02-later Dyna models (except '02-'05 FXDWG). '02-'05 models require separate purchase of Mounting Hardware Kit P/N 92025-09. '10-later FXDWG models require separate purchase of Turn Signal Relocation kit P/N 68544-10. '09-later FXDB models require separate purchase of Turn Signal Relocation Kit 68227-09. All other years and models (except FXDF and FXDWG) require separate purchase of Turn Signal Relocation Kit 68732-02A (Domestic), 68733-02A (International) or Layback License Plate Kit 60215-06. Not compatible with Rear Axle Covers on FXDF and FXDWG models.

### C. LEATHER SADDLEBAGS FOR DYNA MODELS

These genuine leather saddlebags deliver style and large capacity all in one. Constructed around a rigid plastic tub for long term durability, the leather bag features a stylish design with lines that enhance the smooth Dyna model profile. The leather saddlebags provide custom looks and tons of storage space for the road. Hidden quick-release closures add packing convenience. Luggage capacity: 2380 cubic inches total.

**90369-06D** **\$599.95**

Fits '02-later Dyna models (except '02-'05 FXDWG). '02-'05 models require separate purchase of Mounting Hardware Kit P/N 92025-09. '10-later FXDWG models require separate purchase of Turn Signal Relocation kit P/N 68544-10. '09-later FXDB models require separate purchase of Turn Signal Relocation Kit 68227-09. All other years and models (except FXDF and FXDWG) require separate purchase of Turn Signal Relocation Kit 68732-02A (Domestic), 68733-02A (International) or Layback License Plate Kit 60215-06. Not compatible with Rear Axle Covers on FXDF and FXDWG models.



A. DISTRESSED BROWN LEATHER SADDLEBAGS



B. DISTRESSED LEATHER SADDLEBAGS



C. LEATHER SADDLEBAGS FOR DYNA MODELS

NOTE: Some Harley-Davidson® saddlebags are made of leather. Fine leathers or other natural materials WILL gain "character," such as wrinkles or wear, with age. This is normal. A fine, aged patina and character wrinkles are a sign of the extremely high quality materials used to construct your saddlebags. The appearance of scars or marks on the leather are a result of using natural leather panels and should not be thought of as an imperfection. Please use Harley-Davidson Leather Dressing P/N 98261-91V to protect your investment.

Notice: The prices appearing in this catalog are the manufacturer's suggested retail prices. Actual retail prices may vary.





D. LEATHER SADDLEBAGS FOR DYNA MODELS

**D. LEATHER SADDLEBAGS FOR DYNA® MODELS**

Combine street attitude with long-haul versatility and you get these custom leather bags. Styled with sweeping lines to complement the Dyna fender, these bags feature plenty of storage space for a ride to the store, or to Sturgis. The rigid plastic tub, wrapped in genuine leather, offers long-term durability. The traditional leather straps hide quick-disconnect closures for packing convenience, and the chrome buckles provide a look that's pure Harley-Davidson. Luggage capacity: 2380 cubic inches total.

**79300-06D \$599.95**

Fits '02-later Dyna models (except '02-'05 FXDWG). '02-'05 models require separate purchase of Mounting Hardware Kit P/N 92025-09. '10-later FXDWG models require separate purchase of Turn Signal Relocation Kit P/N 68544-10. '09-later FXDB models require separate purchase of Turn Signal Relocation Kit 68227-09. All other years and models (except FXDF and FXDWG) require separate purchase of Turn Signal Relocation Kit 68732-02A (Domestic), 68733-02A (International) or Layback License Plate Kit 60215-06. Not compatible with Rear Axle Covers on FXDF and FXDWG models.

**79300-04C \$599.95**

Fits '02-'05 FXDWG models. Does not fit with Rear Axle Covers or Detachable Docking Hardware. Requires Turn Signal Relocation Kit P/N 68718-02.



E. SYNTHETIC LEATHER SADDLEBAGS

**E. SYNTHETIC LEATHER SADDLEBAGS**

These synthetic leather saddlebags deliver both style and large capacity at a low cost. The rigid plastic tub is wrapped in synthetic leather for long-term durability. The bag features a large protective lid with hook-and-loop and snap closure, and an inner pocket for small item storage. Luggage capacity: 2380 cubic inches total.

**90564-06D \$409.95**

Fits '02-later Dyna® models (except '02-'05 FXDWG). '02-'05 models require separate purchase of Mounting Hardware Kit P/N 92025-09. '10-later FXDWG models require separate purchase of Turn Signal Relocation Kit P/N 68544-10. '09-later FXDB models require separate purchase of Turn Signal Relocation Kit 68227-09. All other years and models (except FXDF and FXDWG) require separate purchase of Turn Signal Relocation Kit 68732-02A (Domestic), 68733-02A (International) or Layback License Plate Kit 60215-06. Not compatible with Rear Axle Covers on FXDF and FXDWG models.



F. RIGID LOCKING LEATHER SADDLEBAGS

**F. RIGID LOCKING LEATHER SADDLEBAGS**

These saddlebags combine a premium leather finish with extra-durable construction. The hard-shell design is covered in leather for a traditional look, while the locking hinged lids offer modern convenience and security. Styled to complement the sleek, narrow Dyna profile, these bags offer plenty of storage for a trip across town or across the country. Kit includes reflectors. Luggage capacity: 2400 cubic inches total.

**91615-09A \$699.95**

Fits '02-later Dyna® models (except '02-'05 FXDWG). '02-'05 models require separate purchase of Mounting Hardware Kit P/N 92025-09. '10-later FXDWG models require separate purchase of Turn Signal Relocation Kit P/N 68544-10. '09-later FXDB models require separate purchase of Turn Signal Relocation Kit 68227-09. All other years and models (except FXDF and FXDWG) require separate purchase of Turn Signal Relocation Kit 68732-02A (Domestic), 68733-02A (International) or Layback License Plate Kit 60215-06. Not compatible with Rear Axle Covers on FXDF and FXDWG models.

# 156 DYNA®

## Saddlebags & Luggage

### A. SLANT-STYLE LATIGO LEATHER SADDLEBAGS

Convenience and style share the road with these durable saddlebags. Constructed from high-quality leather and a sturdy steel frame, they feature a quick-disconnect system with hidden carry straps that make road trips easy. The contoured styling implies constant motion and the embossed Bar & Shield logo and engraved, nickel-plated buckles provide a look that is pure Harley-Davidson.

**91010-91A \$499.95**

Fits '04-later XL models (except XL1200N, XL1200S and XL883R) and '91-'05 Dyna® models. All models require separate purchase of model specific Fender Yoke and Directional Relocation Kit. Does not fit with Flat Lens Turn Signals, Rear Axle Cover(s) or with Bobtail Fenders. Does not fit with Detachable Sideplates on '04-later XL models.

#### Leather Fender Yokes for Slant-Style Saddlebags (not shown)

Required for a proper fitment of Slant-Style Saddlebags on Sport-model Harley-Davidson® motorcycles.

**91015-91 \$69.95**

Fits '91-'05 Dyna models. Does not fit with Detachables.



A. SLANT-STYLE LATIGO LEATHER SADDLEBAGS



B. SYNTHETIC LEATHER THROW-OVER ADJUSTABLE SADDLEBAGS

### B. SYNTHETIC LEATHER THROW-OVER ADJUSTABLE SADDLEBAGS

Synthetic leather with embossed "Eagle Wing" logo. 11" x 10" x 3-3/4".

**90570-86TA \$99.95**

Fits '82-'03 XL, '91-'05 Dyna and '84-'99 Softail® models equipped with saddlebag supports.

### C. CHROME SADDLEBAG SUPPORTS

Fit with or without Sissy Bar Uprights, and attach easily, and protect bags from contacting brake and swingarm.

**90589-91D \$149.95**

Fits '91-'05 Dyna, and '96-'05 FXDWG models. '02-later Dyna models require separate purchase of (2) Bullet Turn Signals P/N 68425-01 (Domestic) or 68420-01 (International). '00-'01 FXDX models require the separate purchase of Hardware Kit P/N 90272-00. Does not fit with Detachable Hardware.

**91017-10 \$149.95**

Fits '08-later Dyna models (including '10 FXDWG models). Does not fit with Detachable Docking Hardware. Allows installation of Throw-Over Saddlebag Kit P/N 91008-82C on many '06-later Dyna models. (Available September 2009)



C. CHROME SADDLEBAG SUPPORTS



D. SADDLEBAG LINERS – SLANT-STYLE SHOWN

### D. SADDLEBAG LINERS

Water-resistant liners make packing easy. Feature inner pockets for extra storage and an embroidered Bar & Shield logo.

**91959-97 \$44.95**

Fits Saddlebag P/Ns 79078-02, 79300-04B, 79300-06B, 88224-06, 90181-08, ~~90300-98A~~, 90307-06, 90330-08, 90369-06, 90460-06B, 90564-06A, 90680-97 and 91010-91A. (pair)

**91958-97 \$44.95**

Fits Saddlebag P/Ns 90058-05A, 90130-00A, 90133-06B, 90419-08, 90901-95, 90990-95, 91190-97 and VRSC Molded Saddlebags. (pair)

### E. DYNA "THE BIG BAG" LEATHER SADDLEBAGS

This premium 8.5-oz leather saddlebag features quick-disconnect buckles that are designed behind traditional hardware. The largest capacity bags available for Dyna models, they provide plenty of extra storage space and offer the premium style of smooth lines highlighted by an embossed Bar & Shield logo and "Harley-Davidson" script logo. This saddlebag will also work with Detachable Sideplates. Luggage capacity: 3000-cubic inches total.

**90300-98A \$699.95**

Fits '96-'01 FXD, FXDL, FXDX and FXDWG models. '00-'01 FXDX models require Hardware Kit P/N 90305-00 for installation. (Will not fit with Flat Lens Turn Signals or any Rear Axle Covers.) Will not fit FXDWG models equipped with Detachable Sideplates.



E. DYNA "THE BIG BAG" LEATHER SADDLEBAGS

Notice: The prices appearing in this catalog are the manufacturer's suggested retail prices. Actual retail prices may vary.

## NEVER IN A TIGHT SPOT

*On the road, you've got to feel good in the saddle. Whether you're cruising around town or out for the long haul, your bike should welcome you like an old friend and feel like an extension of yourself. So, once you've picked the bike, it's time to choose the suspension that best equips your ride to your personal dimensions.*



### A STRONG FOUNDATION



Being sure-footed at a stop or when parking your bike enhances your feeling of control and confidence. Adjusting the ride height by lowering the suspension may be the first step in fitting the bike to your inseam length. Combining a low-profile suspension and a narrow seat is the easiest way for a shorter rider to fit comfortably on a larger bike.

### THE FIT SHOP LIST



Here are a few options to consider when outfitting your bike to fit you. Find your model, and flip to the pages for more information.

2010	SUSPENSION	SEATS	HAND CONTROLS	FOOT CONTROLS
FXDC	Low Suspension Stock	Reach® Seat Brawler® / Sidekick® Seat Badlander® Seat Tallboy® Seat (pg. 135-140)	Various handlebar and / or riser options available (pg. 576-597)	Forward Control Kit (pg. 177)
FXDB	Same as above	Same as above (pg. 135-140)	Same as above (pg. 576-597)	Same as above (pg. 177)
FXDF	Profile® Low Front Suspension (pg. 158)	Same as above (pg. 135-140)	Same as above (pg. 576-597)	N/A
FXDWG	Low Suspension Stock	Same as above (pg. 135-140)	Same as above (pg. 576-597)	N/A



# 158 DYNA®

## Suspension

### A. PROFILE® LOW FRONT SUSPENSION\* – FXDF\*

Designed by Harley-Davidson® to lower the front fork approximately 1" while preserving ride quality. Springs are wound to allow a compliant, yet controlled ride. Kit includes two fork springs, two damper tubes, and two fork tube plug oil seals.

**54676-09** **\$99.95**

Fits '08-later FXDF models. Stock on FXDFSE/2 models.

### B. PROFILE® LOW FRONT SUSPENSION\* – FXDWG\*

Designed by Harley-Davidson to lower the front fork approximately 1" while preserving ride quality. Springs are progressively wound for a compliant, yet controlled ride. Must only be installed on vehicles equipped with low-profile rear suspension.

**54621-05** **\$99.95**

Fits '00-later FXST, FXSTB and FXSTC models equipped with Profile Low Rear Suspension P/N 54648-00A, 54665-03, 54651-05A, 54652-05 or Rear Lowering Kit P/N 54001-04A. Also fits '00-'05 FXDWG models equipped with Low Rear Shock Kit P/N 54594-03 or Premium Billet Profile Low Rear Suspension P/N 54592-03.

### C. PROFILE LOW REAR SHOCK KIT\*

Plant your feet firmly on the ground. This reduced length version of the Original Equipment rear suspension lowers the seat height by approximately 1". Shocks feature chrome-plated springs and body caps, and suspension preload is adjustable for rider and passenger load.

**54625-06** **\$234.95**

Fits '06-'09 FXD, FXDC and FXDWG models. (Lowers '06-'09 FXDL, '08-'09 FXDF and FXDB models 1/4".) Does not lower '10 Dyna models.

**54594-03** **\$234.95**

Fits '93-'05 FXD, FXDL, FXDC and FXDWG models. Does not lower '01-'05 FXDL models.

### D. PREMIUM PROFILE LOW REAR SUSPENSION KIT\*

Introduced on the '08 FXDF model, these custom rear shocks lower your bike while they raise the level of style. These low-profile shocks lower the seat height by approximately 1". The rear shock and spring is completely covered with mirror-polished and chrome-plated sleeves for a sleek, beefy look.

**54619-08** **\$399.95**

Fits '07-later FXD, FXDC and FXDWG models. Stock on '08-later FXDF. Fits but does not lower '07-later FXDL, FXDB and '10 FXD, FXDC and FXDWG models. '07 Dyna® models require separate purchase of Chrome Belt Guard Kit P/N 60633-08. Does not fit with Detachable Saddlebags P/N 90181-08.

### E. CUSTOM FORK BRACE

This chrome-plated fork brace adds style to the front end.

**46097-98** **\$134.95**

Fits '93-'05 FXDWG and '84-later FX Softail models (except Springer®, FXCW/C and FXSTD). (Will not fit with Chrome Lower Fork Sliders.)

### F. SCREAMIN' EAGLE® CHROME FORK BRACE

These Chrome Fork Braces are machined from billet aluminum, then polished and chrome-plated to complement the curve of the front fender. The machined Screamin' Eagle logo finishes the look with crisp detail. Easy-to-install, these braces offer increased torsional rigidity. Does not fit with Fluted Fork Slider Dust Covers.

**46595-06A** **\$199.95**

Fits '06-later Dyna models (except FXDWG, FXDF, FXDFSE/2 and FXDSE/2), and '02-later VRSCA, VRSCB, VRSCD and VRSCX models.

**46192-99A** **\$184.95**

Fits '87-later XL (except XL1200N), '91-'05 Dyna (except FXDWG) and FXR models (except FXRT) with 39mm front forks. Will not fit with Chrome Fork Sliders.



A. PROFILE LOW FRONT SUSPENSION – FXDF MODELS



B. PROFILE LOW FRONT SUSPENSION – FXDWG MODELS



C. PROFILE LOW REAR SHOCK KIT



D. PREMIUM PROFILE LOW REAR SUSPENSION KIT



E. CUSTOM FORK BRACE



F. SCREAMIN' EAGLE CHROME FORK BRACE



**\*WARNING:** Installation of any accessory suspension components may affect cornering clearance and jiffy stand operation. This could distract the rider, causing loss of control and death or serious injury.



**\*WARNING:** The Profile® Low Front Spring Kit cannot be used independently and must be used with the appropriate Profile Rear Shock Lowering Kit. Installation of any accessory suspension components may affect cornering clearance and jiffy stand operation. This could distract the rider, causing loss of control and death or serious injury.





G

G. WIDE TIRE KIT – DYNA STREET BOB SHOWN

**G. WIDE TIRE KIT – DYNA® MODELS**

Add the wide tire look to your '06-later Dyna® model. The 180mm rear tire fills out the rear fender to add a menacing look from the back. A simple conversion at your first tire change, the kit includes the DUNLOP®/Screamin' Eagle® GT502 180/60B17 rear tire and the required installation brackets and hardware. This easy-to-install kit fits with the Original Equipment 17" wheel, and requires no frame or power-train alterations.

**43779-09** Fits '09-later FXDB models. Use with '10 FXDB requires separate purchase of DUNLOP front tire. Use with saddlebag kits requires separate purchase of two Fender Mounting Brackets P/N 60181-09 (not required when used with Docking Hardware for Detachable Racks and Sideplates Kit P/N 53797-09). **\$279.95**

**43705-06** Fits '06-'08 FXDWG models. **\$279.95**

**43768-06** Fits '06-later Dyna models (except FXDWG, FXDF, FXDSE/2, FXDFSE/2 and '09-later FXDB). Use with '10 FXD, FXDC and FXDL (JPN only) models requires separate purchase of DUNLOP front tire. Installation of Rigid Sideplate Kit P/N 52856-06 on models without saddlebags requires separate purchase of Hardware Kit P/N 53975-06. Installation of Detachable Sideplate Kit P/N 52866-06 on models without saddlebags requires separate purchase of Hardware Kit P/N 53974-06. **\$279.95**

**53975-06** Required to install Rigid Sideplate Kit P/N 52856-06 on '06-later Dyna models (except FXDWG, FXDF, FXDSE/2 and '09-later FXDB and FXDFSE/2) equipped with Wide Tire Kit P/N 43768-06. Requires separate purchase of Turn Signal Relocation Kit P/N 68732-02A or 60215-06 (Domestic) or P/N 68733-02A (International). **\$39.95**

**Also available:****SIDEPLATE INSTALLATION HARDWARE KIT**

Required for installation of Passenger Backrest Sideplates on Dyna models equipped with Wide Tire Kit P/N 43768-06. Not required on models equipped with Harley-Davidson® saddlebags.

**53974-06** Required to install Detachable Sideplate Kit P/N 52866-06 on '06-later Dyna models (except FXDWG, FXDF, FXDSE/2 and '09-later FXDB and FXDFSE/2) equipped with Wide Tire Kit P/N 43768-06. Requires separate purchase of Turn Signal Relocation Kit P/N 68732-02A or 60215-06 (Domestic) or P/N 68733-02A (International). **\$39.95**

**53974-06** Required to install Detachable Sideplate Kit P/N 52866-06 on '06-later Dyna models (except FXDWG, FXDF, FXDSE/2 and '09-later FXDB and FXDFSE/2) equipped with Wide Tire Kit P/N 43768-06. Requires separate purchase of Turn Signal Relocation Kit P/N 68732-02A or 60215-06 (Domestic) or P/N 68733-02A (International). **\$39.95**



G

G. WIDE TIRE KIT – DYNA WIDE GLIDE SHOWN

**DEFINE YOUR LOOK**

*Customizing your motorcycle is about selecting accessories that work together to reflect your personality. Envision your bike as a whole and choose the options that will make that vision a reality. Developing a “look” for your bike doesn’t have to be difficult; before you start, just decide on a direction and stick with it.*



**BLACK & CHROME**

Genuine H-D® Accessories are developed by the same folks that built your bike, so you can be assured that plated or painted parts will match the Original Equipment finishes for a unified look.

**FOCUS ON THE PROFILE**

**FRONT END TRIM**

Custom fork sliders, wheels and rotors put your sense of style front and center. And simple additions like custom axle covers and hardware finish the look.

**REAR END TRIM**

A chrome swingarm and custom wheels make a major visual impact, and easy-to-install axle covers, belt guards and custom hardware give a unified look.

**WHEELS & BRAKES**

Custom calipers, wheels and rotors can have a radical impact on the look, but small additions like caliper trim and chrome hardware can provide subtle style.

**CHASSIS TRIM**

One of the easiest ways to customize your motorcycle is adding decorative covers. Fender trim, component covers and custom hardware all grab your attention.

**HAND CONTROLS**

Adding mirrors, grips and a little chrome puts style in full view of the rider. A custom master cylinder, switch covers and hand levers give instant gratification.

**FOOT CONTROLS**

Custom foot pegs, foot levers and shift linkages offer exceptional function and style, and highway pegs and engine guards add comfort and engine protection.

**CONSOLES & GAUGES**

The link between your brain and the bike. Auxiliary gauges help you monitor your engine’s vital signs, and a custom console says a lot beyond the numbers.

**ENGINE TRIM & HARDWARE**

The V-Twin engine is the heart of the bike. Adding well-chosen covers, a custom air cleaner and a decorative collection instantly sets your bike apart from stock.

**LIGHTING**

Lighting adds distinctive style and aids visibility. Choose from a variety of auxiliary lamps, headlamp trim and LED lighting to grab maximum attention.

**PERFORMANCE**

Performance options make a styling statement as well. Screamin’ Eagle® high-flow air cleaners and custom exhaust systems show that you mean business.

# 162 DYNA®

Chassis Trim – Front End

## A. CHROME LOWER FORK SLIDERS

Competitively priced, these chrome-plated Lower Fork Sliders give your bike up-front style. To ensure proper fitment and function, these sliders are manufactured from Original Equipment components. Form follows function, with polished, triple chrome-plating and a stamped "Harley-Davidson" logo for product identification.

**48748-08A** Fits '08-later FXDF models. **\$299.95**

**46589-06B** Fits '06-later FXDWG models. **\$299.95**

**46586-06B** **\$299.95**

Fits '06-later Dyna® models (except FXDWG, FXDF, FXDFSE/2 and FXDSE/2).

**46562-04A** **\$299.95**

Fits '08-later XL models (except XL883N, XL883R, XL1200N and XL1200R) and '04-'05 Dyna FXD, FXDC and FXDL models.

**46492-00** **\$299.95**

Fits '00-'07 XL models (except XL883R, XL1200S and XL1200R) and '00-'03 FXD and '01-'03 FXDL models.

**45275-98** **\$304.95**

Fits '88-'99 Sportster® models and FXD Super Glide®, '87-later FXLR and '88-'99 FXR and FXRS. (Does not fit Sportster Sport models.)

**46477-00** **\$299.95**

Fits '00-'05 FXDWG, '00-'06 FXST and FXSTB models.

**45305-98** **\$329.95**

Fits '91-'99 FXDWG, FXST, FXSTB and FXSTC models.

## B. CHROME FRONT END KITS\*

The front forks on a Harley-Davidson® motorcycle set the tone for the bike, and can lead the way to a full-bore custom statement. So start customizing by adding chrome where it will have the most noticeable impact on the overall look of the bike, your front end. This package includes components necessary to completely chrome the front forks and includes some or all of the following (kit components vary depending on your model): Chrome Fork Sliders, Chrome Fork Axle Retainer Nut Kit, Chrome Fork Slider Drain Screw Kit, Chrome Front Wheel Spacers, Classic Chrome Front Axle Nut Cover Kit, and Chrome Upper Fork Nut Covers.

**46876-08A** **\$464.95**  
Fits '08-later Dyna models (except FXDWG, FXDSE2, FXDF and FXDFSE/2).

**46877-08A** Fits '08-later FXDWG models. **\$464.95**

**46850-06A** **\$479.95**

Fits '06-'07 Dyna models (except FXDWG and FXDSE).

**46851-06A** Fits '06-'07 FXDWG models. **\$479.95**

\*Chrome Front End Package price does not include labor or supplies.



A. CHROME LOWER FORK SLIDERS ('06 DYNA SHOWN)



B. CHROME FRONT END KITS  
(46851-06 SHOWN)



B. CHROME FRONT END KITS  
(46850-06 SHOWN)

Notice: The prices appearing in this catalog are the manufacturer's suggested retail prices. Actual retail prices may vary.



C. BILLET FORK SLIDER DUST COVERS



D. CHROME LOWER FRONT FORK DUST COVERS



E. DECORATIVE CHROME FORK JOINT COVERS



F. CHROME FRONT FENDER HARDWARE KIT



G. CHROME FORK AXLE RETAINER NUT KIT – DYNA/XL



G. CHROME FORK AXLE RETAINER NUT KIT – FXDWG

**C. BILLET FORK SLIDER DUST COVERS**

Kit replaces the Original Equipment dust cover with chrome-plated, stylish dust covers to complete the custom look of a chrome front end.

**46889-06** **\$59.95**

Fits '06-later Dyna® models (except FXDSE). Does not fit with Screamin' Eagle® Chrome Fork Brace P/Ns 46634-06 or 46595-06.

**D. CHROME LOWER FRONT FORK DUST COVERS**

Replace your stock black rubber fork slider seal with this beautiful, chrome billet 6061-T6 aluminum dust cover.

**45243-00** **\$59.95**

Fits '84-'99 FXSTC, '84-later FXST, FXSTB, and '91-'05 FXDWG and '80-'86 FXWG models.

**E. DECORATIVE CHROME FORK JOINT COVERS**

Add a bigger, beefy look to the fork slider dust covers without disassembling the front fork. This polished and chrome-plated kit is easy-to-install without tools.

**45415-82** **\$59.95**

Fits '84-'99 FXSTC, '84-later FXST, FXSTB, '93-'05 FXDWG and '80-'86 FXWG models.

**F. CHROME FRONT FENDER HARDWARE KIT**

Finish the show-winning look with brilliant chrome hardware. Manufactured to Original Equipment specifications, this kit replaces the zinc-plated exposed front fender mounting bolts with chrome-plated socket head cap screws.

**94415-05** **\$8.95**

Fits '91-later Softail® models (except FXCW/C, FXSTD and Springer®), and '93-'05 FXDWG models. Does not fit with Billet Fork Sliders or Inverted Front End Kit.

**G. CHROME FORK AXLE RETAINER NUT KIT**

It's the details that count. Complete the chrome transformation by adding this finishing touch to your chrome fork sliders. This Axle Retainer Nut Kit includes the stylish chrome-plated nuts and chrome lockwashers necessary to replace the stock hardware.

**45802-03** **\$7.95**

Fits '88-later XL models, '93-'05 Dyna FXD, FXDL, FXDS-CONV., FXDX, FXDX-T models and '88-'94 FXR, FXRS, FXRS-SP, FXRS-CONV., FXLR, FXRT models.

**45813-03** **\$7.95**

Fits '84-later Touring, '86-'07 FLST, FLSTC, FLSTF, FLSTN, '91-'07 FXST and FXSTB, '07 FXSTC and '91-'05 FXDWG models.

**Also available:**

**CHROME FORK SLIDER DRAIN SCREW KIT**

It's the details that count. Complete the chrome transformation by adding this finishing touch to your chrome fork sliders. This Fork Slider Drain Screw Kit includes two chrome-plated drain screws and the seals required to replace the stock hardware.

**45848-03** **\$3.95**

Fits '87-later Softail® (except Springer, FXCW/C and FXSTD), '87-later Touring models, and '93-'05 FXDWG models.

**45815-03** **\$3.95**

Fits '73-later XL models (except XL Sport), '78-'86 FX models, '94-'05 Dyna® FXD/DL/DS-CONV., '99-'00 FXR2/3/4 models, and '00-'07 FXSTD models.

Notice: The prices appearing in this catalog are the manufacturer's suggested retail prices. Actual retail prices may vary.



# 164 DYNA®

## Chassis Trim – Front End

### A. LOW-PROFILE FRONT AXLE NUT COVER

Thanks to the tapered design, these die-cast Low-Profile Axle Covers appear smaller than a traditional axle cover. The brilliant chrome finish looks great with Original Equipment polished or accessory chrome fork sliders, and the hidden fasteners keep the look clean.

**47646-09 \$45.95**

Fits '08-later Dyna® models (except FXDSE) and '06-later VRSC™ models (except VRSCF and VRSCR).

### B. CLASSIC CHROME FRONT AXLE NUT COVER KIT

Cover the front axle in a classic style. Chrome-plated axle nut covers look great with Original Equipment satin-finish fork sliders, or add a finishing touch to a complete chrome front end. Sold in pairs.

Fits '02-later VRSC™ models (except VRSCR and VRSCF), '08-later XL, '07-later Softail® (except Springer®, FXCW, FXCWC and FXSTD), '08-later Dyna® and '08-later Touring models.

**44116-07A Billet. \$41.95**

**44117-07A Die Cast. \$26.95**

Fits '00-'07 Touring models and '04-'07 Dyna models (except '04-'05 FXDWG and '07 FXDSE).

**43061-04 Billet. \$41.95**

**43062-04 Die Cast. \$26.95**

Fits '84-'06 Softail (except Springer and FXSTD); '91-'03 FXD, FXDX, FXDXT, FXDL, FXDS-CONV.; '93-'05 FXDWG; '80-'99 Touring; '88-'07 XL, FXR and '87-later FLXR/FXRS-SP, FXWG models.

**43899-86A Die Cast. \$26.95**

### C. GLOSS BLACK FRONT AXLE NUT COVER KIT

Gloss black covers conceal the front axle hardware for a clean, custom look. Kit includes set screws and Allen wrench for easy installation.

**43428-09 \$41.95**

Fits '02-later VRSC models (except VRSCR and VRSCF), '08-later XL, '07-later Softail (except Springer, FXCW, FXCWC and FXSTD), '08-later Dyna and '08-later Touring models.

### D. WILLIE G.® SKULL COLLECTION FRONT AXLE NUT COVER KIT

Add a little attitude to your ride. The Axle Nut Covers are easy-to-install, and include all necessary mounting hardware. Sold in pairs.

**43163-08A \$28.95**

Fits '88-later XL, '84-later Softail (except Springer, FXCW, FXCWC and FXSTD), '02-later VRSC (except VRSCR and VRSCF), '91-later Dyna, and '99-later Touring models.

### E. "H-D MOTOR CO." LOGO FRONT AXLE NUT COVER KIT

Die-cast, chrome-plated covers feature the "Harley-Davidson Motor Co." logo in black. Includes Allen-head set screws and wrench for easy installation.

**44148-07A \$26.95**

Fits '02-later VRSC models (except VRSCR and VRSCF), '08-later XL, '07-later Softail (except Springer, FXCW, FXCWC and FXSTD), '08-later Dyna and '08-later Touring models.

**43063-04 \$26.95**

Fits '00-'07 Touring models and '04-'07 Dyna models (except '04-'05 FXDWG and '07 FXDSE).

### F. TAPERED FRONT AXLE NUT COVER KIT

Thanks to an exclusive contoured profile, these unique chrome die-cast Front Axle Nut Covers appear smaller than others when installed. Sold in pairs.

**44109-07 \$26.95**

Fits '07-later Softail® models (except Springer®, FXCW, FXCWC and FXSTD), '08-later Dyna and Touring (except Trike) and '02-later VRSC models (except VRSCR and VRSCF).

**43051-01 \$26.95**

Fits '00-'07 Touring models and '04-'07 Dyna® models (except '04-'05 FXDWG and '07 FXDSE).



A. LOW-PROFILE FRONT AXLE NUT COVER



B. CLASSIC CHROME FRONT AXLE NUT COVER KIT



C. GLOSS BLACK FRONT AXLE NUT COVER KIT



D. WILLIE G. SKULL COLLECTION FRONT AXLE NUT COVER KIT



E. "HD MOTOR CO." LOGO FRONT AXLE NUT COVER KIT



F. TAPERED FRONT AXLE NUT COVER KIT

Notice: The prices appearing in this catalog are the manufacturer's suggested retail prices. Actual retail prices may vary.



G

**G. ALUMINATOR CHROME BILLET FRONT AXLE NUT COVER KIT**



H

**H. CHROME UPPER FORK NUT COVERS**

**G. ALUMINATOR® CHROME BILLET FRONT AXLE NUT COVER KIT**

Chrome-plated aluminum Billet Axle Cover Kit with the classic styling of the Aluminator Collection. Includes mounting hardware and wrench for easy installation.

**44114-07 \$41.95**

Fits '07-later Softail® models, (except Springer®, FXCW, FXCWC and FXSTD), '08-later Dyna® and Touring, and '02-later VRSC™ (except VRSCR and VRSCF) models.

**43059-04 \$41.95**

Fits '00-'07 Touring models and '04-'07 Dyna models (except '04-'05 FXDWG and '07 FXDSE).

**43907-94 \$41.95**

Fits '84-'06 Softail® (except Springer and FXSTD); '91-'03 FXD, FXDX, FXDXT, FXDL, FXDS-CONV.; '93-'05 FXDWG; '80-'99 Touring; '88-'07 XL, FXR and '87-later FLXR/FXRS-SP, FXWG models.

**H. CHROME UPPER FORK NUT COVERS**

Highlighted with a unique Bar & Shield logo, these polished triple chrome-plated covers add to the clean appearance of your upper fork. Kit comes complete with three covers and mounting hardware.

**46109-06 \$48.95**

Fits '06-later Dyna® models (except FXDSE/2).

**46129-98B \$48.95**

Fits '86-later FLSTC, '90-later FLSTF, '95-'05 FXD, '93-'05 FXDL, '94-'05 FXDS, and '88-later XL models (except XL Custom and XL1200S models).

**45002-98 \$49.95**

Fits '00-later FXST, FXSTB, FXSTD, '86-later FXSTC, and '93-'05 FXDWG models.

**I. CHROME FRONT WHEEL SPACER KIT**

There's always more room for chrome with these highly-polished Chrome Wheel Spacer Kits. They're manufactured to the Original Equipment tolerances, so you get exact product fitment and quality.

**41597-00 Straight \$29.95**

Fits '00-'06 FXST, FXSTB, FXSTD and '00-'05 FXDWG models. Also fits models equipped with Inverted Front Fork Kit and 3/4" Axle Kit P/N 42134-06, or Billet Fork Sliders P/N 46280-03. Does not fit '03-'04 FXSTDSE.

**41616-02 Straight \$29.95**

Fits '00-'07 XL models and '00-'03 FXD, FXDL, FXDX, FXDXT and FXDS-CONV. models.

**41420-08 Tapered \$29.95**

Fits '08-later Dyna models (except FXDWG, FXDF and FXDFSE/2). Does not fit with Typhoon Custom Wheel P/N 44615-08, 44657-08, 40774-10, Magnum 5 Custom Wheel P/N 43621-09, or Road Winder Custom Wheel P/N 44689-08.

**41361-08 Tapered \$29.95**

Fits '08-later FXDWG and FXDF models.

**41409-06 Tapered \$29.95**

Fits '06-'07 Dyna models (except FXDWG).

**41410-06 Tapered \$29.95**

Fits '06-'07 FXDWG models.



I

**I. CHROME FRONT WHEEL SPACER KIT – STRAIGHT**



I

**I. CHROME FRONT WHEEL SPACER KIT – TAPERED**

**J. GLOSS BLACK TRIPLE TREE KIT**

The classic Harley-Davidson® color is black. It shows your attitude, your feelings, and your desire to be different from the rest. This gloss black Triple Tree is the ultimate extension of the Harley-Davidson philosophy. Manufactured from Original Equipment components to ensure superior fit and finish, this Gloss Black Triple Tree complements the black fork sliders and the handlebar risers featured on the Dyna Fat Bob® model. Add the matching Black Handlebar P/N 55977-09 for a complete blacked-out look.

**48609-09 Fits '08-later FXDF models. \$249.95**

**K. CHROME TRIPLE TREE KIT**

Drape your front end in chrome. The ideal complement to chrome fork sliders, this beautifully polished and plated triple tree is manufactured from Original Equipment components to ensure quality and fit. The kit includes chrome hardware and fork stem installed in lower tree.

**45023-02 \$219.95**

Fits '90-'05 FXD, FXDL, FXDS-CONV. and FXDX models. Requires separate purchase of Bearing P/N 48300-60.



NEW

J

**J. GLOSS BLACK TRIPLE TREE KIT**



K

**K. CHROME TRIPLE TREE KIT**

DYNA

# 166 DYNA®

Chassis Trim – Rear End

## A. CHROME SWINGARM

The ultimate chrome accessory, polished to the highest standard using bright plating to match Original Equipment finish. Affordable and convenient, with no troublesome exchanges necessary. Factory specifications guarantee exact fitment, unparalleled quality and an affordable price. Stamped with the Harley-Davidson logo.

**48458-10** Fits '10 Dyna® models. **\$349.95**

**48458-06** Fits '06-'09 Dyna® models. **\$329.95**

**48439-00B** **\$349.95**

Fits '00-'05 Dyna models. Kit includes bearings.

Shown with:

### CHROME UPPER BELT GUARD

Hand-polished and chrome-plated to replace your factory-equipped black upper belt guard.

**60303-07** Fits '07-later Dyna models. **\$109.95**

**60303-06** Fits '06 Dyna models. **\$109.95**

**60293-00** Fits '00-'05 Dyna models. **\$111.00**

**60293-90A** **\$159.83**

Fits '92-'99 FXD, FXDX, FXDL, FXDWG models.

Shown with:

### CHROME LOWER BELT GUARD COVER

Designed to cover the Original Equipment black lower debris deflector, this mirror-chrome finished cover adds an exceptional finish to the rear drive components. Kit includes required mounting hardware.

**60514-07A** Fits '07-later Dyna models. **\$64.95**

**60489-06A** Fits '06 Dyna models. **\$64.95**

**60475-92A** **\$64.95**

Fits '91-'05 Dyna models and all '94-'99 International Dyna models equipped with 70- or 65-tooth sprockets.

## B. SLOTTED CHROME UPPER BELT GUARD

Designed to add a unique and stylish look, the hand-polished and chrome-plated Slotted Belt Guard opens up the left side of the bike for an aggressive profile. Easy-to-install, the Slotted Guard replaces the stock painted unit, and includes chrome-plated mounting hardware.

**60711-07** **\$109.95**

Fits '07-later Dyna models (except FXDF). Stock on '07-'08 FXDSE models.



A. CHROME SWINGARM – '06-LATER STYLE SHOWN  
(SHOWN WITH CHROME UPPER AND LOWER BELT GUARDS)

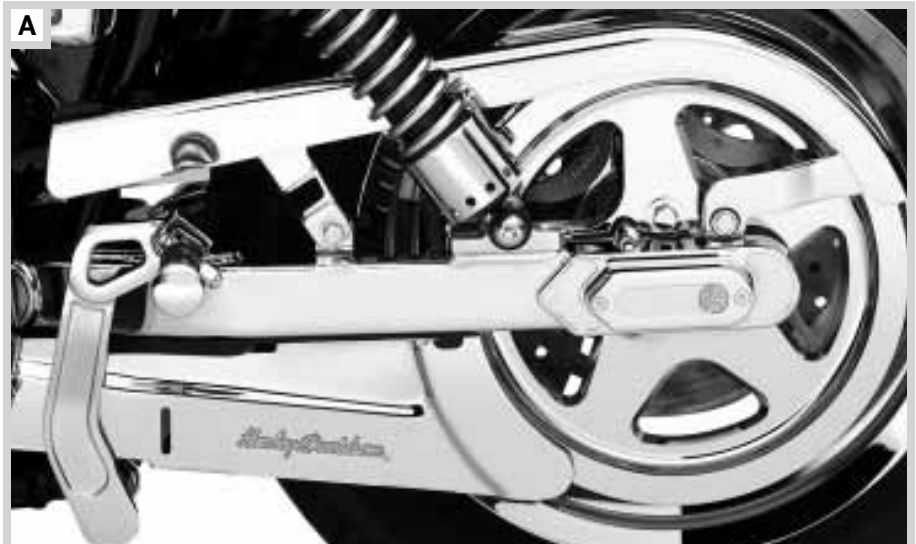

A. CHROME SWINGARM – '00-'05 STYLE SHOWN  
(SHOWN WITH CHROME UPPER AND LOWER BELT GUARDS)



B. SLOTTED CHROME UPPER BELT GUARD

Notice: The prices appearing in this catalog are the manufacturer's suggested retail prices. Actual retail prices may vary.





C. CHROME REAR WHEEL SPACER KIT

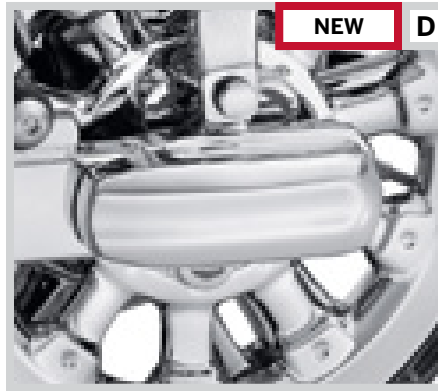

D. LOW-PROFILE REAR AXLE COVER KIT



E. "HARLEY-DAVIDSON" SCRIPT REAR AXLE COVER KIT



F. DYNA SWINGARM AXLE COVERS



G. REAR AXLE NUT COVER KIT – CLASSIC CHROME



G. REAR AXLE NUT COVER KIT – GLOSS BLACK



G. REAR AXLE NUT COVER KIT – WILLIE G. SKULL COLLECTION



G. REAR AXLE NUT COVER KIT – "H-D MOTOR CO." LOGO

NEW

**C. CHROME REAR WHEEL SPACER KIT**

Add some chrome detail to an often overlooked area of the bike with this highly-polished Chrome Wheel Spacer Kit. Manufactured to the Original Equipment tolerances, to ensure product fitment and quality.

**41362-08** Tapered. **\$29.95**  
Fits '08-later Dyna® models (except FXDF, FXDFSE/2 and '10 FXDWG).

**D. LOW-PROFILE REAR AXLE COVER KIT**

This Low-Profile Rear Axle Cover is contoured to accent the tail end of the swingarm. Designed to conceal both the rear axle nut and the adjusting hardware, the smooth chrome surface and sleek hidden fasteners complement either an Original Equipment black or accessory chrome swingarm. This easy-to-install kit includes all required installation hardware.

**47645-09** **\$134.95**  
Fits '08-later Dyna models. Original Equipment on '10 FXDFSE models. Will not fit models equipped with saddlebags.

**E. "HARLEY-DAVIDSON" SCRIPT REAR AXLE COVER KIT**

Chrome-plated die-cast cover conceals the side of the swingarm and the axle. Unique styling features a black-filled embossed "Harley-Davidson" script for a distinctive contrast. The kit is easy-to-install without removing the rear wheel. Kit includes all necessary mounting hardware.

**44346-06** **\$64.95**  
Fits '06-later Dyna® models. (Will not fit models equipped with saddlebags.)

**F. DYNA SWINGARM AXLE COVERS**

Chrome-plated, die-cast covers with textured highlights and Bar & Shield logo.

**44508-01** **\$79.95**  
Fits '02-'05 Dyna models and '00-'01 Dyna models with Swingarm P/N 47820-00A or 48439-00B installed. Does not fit with saddlebags.

**G. REAR AXLE NUT COVER KITS**

Cover your rear axle nut in the most traditional way. These Rear Axle Cover Kits complements the matching Front Axle Nut covers. Easy-to-install, these cover kits include necessary mounting hardware. Sold in pairs.

**Classic Chrome – Billet**

**43132-08** **\$41.95**  
Fits '08-later Dyna and Softail® models (except FXCW/C).

**Classic Chrome – Die Cast**

**41705-09** **\$24.95**  
Fits '08-later Dyna and Softail® models (except FXCW and FXCWC).

**42034-07** Fits '06-'07 Dyna models. **\$26.95**

**44262-01** Fits '91-'05 Dyna models. **\$26.95**

**Gloss Black**

**43422-09** **\$41.95**  
Fits '08-later Dyna and Softail models (except FXCW and FXCWC).

**Willie G.® Skull Collection**

**41706-09** **\$26.95**  
Fits '08-later Dyna and Softail models (except FXCW and FXCWC).

**42064-07** Fits '06-'07 Dyna models. **\$28.95**

**"H-D Motor Co." Logo**

**41704-09** **\$26.95**  
Fits '08-later Dyna and Softail models (except FXCW and FXCWC).

**42065-07** Fits '06-'07 Dyna models. **\$28.95**

**44257-01** Fits '91-'05 Dyna models. **\$28.95**

Notice: The prices appearing in this catalog are the manufacturer's suggested retail prices. Actual retail prices may vary.



# 168 DYNA®

Chassis Trim – Rear End

## A. CHROME SPROCKET COVER

This sprocket cover gives the appearance of a chrome sprocket at a fraction of the cost. It matches the styling of the Original Equipment sprocket, and bolts on using the Original Equipment hardware.

<b>37756-07</b>	Fits '07-later Dyna® models.	<b>\$49.95</b>
<b>40595-06</b>	Fits '06 Dyna models.	<b>\$49.95</b>

## B. CHROME SPROCKET COVER WITH HOLES

Chrome sprocket cover matches the styling of the Original Equipment sprocket. Gives the appearance of having a chrome sprocket at a fraction of the cost.

<b>91346-00</b>	70-Tooth Sprocket. Fits '00-'05 Dyna models.	<b>\$49.95</b>
-----------------	---	----------------

**91733-85A** 70-Tooth Sprocket.  
Fits '91-'99 Dyna models. Also fits '80-later Domestic 1340 models except '93 and '95-later Softail® models. '94 Domestic Softail models are equipped with 70-tooth rear sprockets. Also fits all '94-later International 1340 models (except International Softail and Swiss 1340 models).

<b>40317-94</b>	65-Tooth Sprocket. Fits '95-'99 Softail models and '94-later 1340 Swiss models with holes.	<b>\$54.95</b>
-----------------	---	----------------



A. CHROME SPROCKET COVER



B. CHROME SPROCKET COVER WITH HOLES

## C. TYPHOON SPROCKET COVER

Styled to match the distinctive Typhoon Custom Wheel. Available in mirror chrome or satin black, this Sprocket Cover gives the appearance of having a custom sprocket at a fraction of the cost. Cover easily bolts on using the stock hardware, or for a finished look, add the Chrome Hardware Kit P/N 94773-07 (sold separately).

Fits '07-later Dyna® models.

<b>40142-08</b>	Chrome.	<b>\$49.95</b>
<b>40154-08</b>	Satin Black.	<b>\$49.95</b>



C. TYPHOON SPROCKET COVER – CHROME



C. TYPHOON SPROCKET COVER – SATIN BLACK

## D. MAGNUM 5 SPROCKET COVER

Styled to match the distinctive Magnum 5 Custom Wheel. Available in mirror chrome or satin black, this Sprocket Cover gives the appearance of having a custom sprocket at a fraction of the cost. Cover is easy-to-install with Original Equipment hardware, or add the Chrome Hardware Kit P/N 94773-07 (sold separately) for a finished look.

Fits '07-later Dyna models.

<b>40120-09</b>	Chrome.	<b>\$54.95</b>
<b>40122-10</b>	Satin Black.	<b>\$54.95</b>

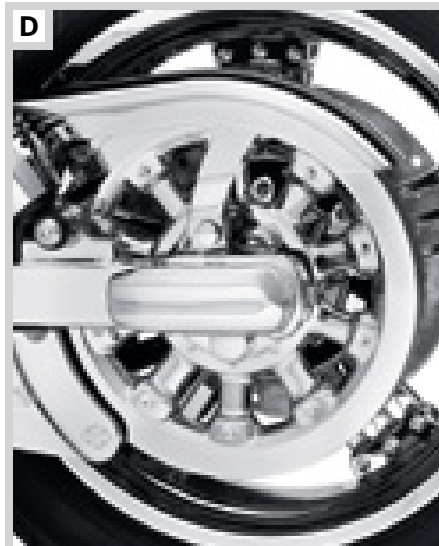

D. MAGNUM 5 SPROCKET COVER – CHROME

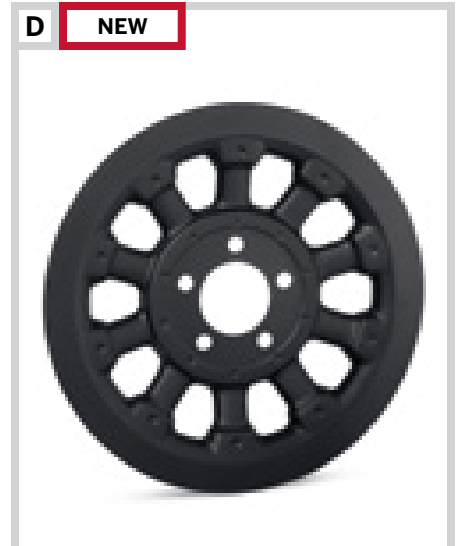

D. MAGNUM 5 SPROCKET COVER – SATIN BLACK

Notice: The prices appearing in this catalog are the manufacturer's suggested retail prices. Actual retail prices may vary.



**E. CHROME FRONT CALIPER KIT (SHOWN WITH CHROME CALIPER BOLT COVER KIT)**



**F. CHROME REAR CALIPER KIT (SHOWN WITH CHROME BRACKET) – '08-LATER DYNA**



**G. DEEP DISH BRAKE CALIPER INSERT**



**H. BRAKE CALIPER INSERTS**



**I. FRONT CALIPER COVER (SHOWN WITH CHROME CALIPER BOLT COVER KIT)**



**I. CHROME REAR CALIPER COVER**

**E. CHROME FRONT CALIPER KIT**

Add the shine of chrome to your bike with this highly polished Chrome Brake Caliper Kit. Manufactured from Original Equipment components for proven performance, these calipers add the finishing touch to a complete custom with chrome wheels, rotors and chrome fork sliders. (Brake pads and pad pins not included.)

**44395-08** **\$359.95**  
Fits '08-later Dyna® and Softail® models (except Springer®) equipped with single disc front brakes.

**44395-00A** **\$359.95**  
Fits '00-'03 XL and '00-'07 Dyna and Softail® (except Springer) models equipped with single disc front brakes.

**44392-00A** **\$789.95**  
Fits '00-'03 XL, '02-'05 VRSC™, and '00-'07 Dyna, Softail and Touring models equipped with dual disc front brakes.

**F. CHROME REAR CALIPER KIT**

With H-D® chrome behind you, you're cruising with confidence. This Rear Caliper Kit offers a brilliant, long-lasting chrome finish while delivering Original Equipment performance and exact fit. Bolts right to existing mounting holes. (Brake pads and pad pins not included.)

**42047-08** **\$319.95**  
Fits '08-later Dyna and Softail models.

**42035-06** **\$444.95** Fits '06-'07 Dyna models.

**Shown with:**

**CHROME REAR CALIPER BRACKET**

Complete a chrome rear brake conversion. This Rear Caliper Bracket sets your ride apart from the others by replacing the painted black mount with brilliant chrome. Manufactured from the Original Equipment components for exact fit, this mount will bolt to the existing mounting location.

**42002-08** **\$99.95** Fits '08-later Dyna models.

**G. DEEP DISH BRAKE CALIPER INSERT**

This chrome-plated caliper insert features a dished-out center profile for added "flash". Includes self-adhesive backing for easy installation.

**44542-03** **\$13.95**  
Fits '00-later front and rear brake calipers on all models (except Springer® front, '08-later Touring, '04-later XL and '06-later VRSC™ models).

**H. BRAKE CALIPER INSERTS**

Easy to install inserts add a finishing touch to the front and rear brake calipers. Select a style that follows your custom direction. Self-adhesive backing.

Fits '00-later front and rear brake calipers on all models (except Springer front, '08-later Touring, '04-later XL and '06-later VRSC models).

**1. 44477-99** Classic Chrome. **\$13.95**

**2. 44476-99** Harley-Davidson Script. **\$13.95**

**3. 44474-99** Flames. **\$13.95**

**I. CHROME CALIPER COVER**

Chrome-plated caliper cover styled with stepped contours and textured recess for a distinctive look. Does not require brake line removal.

**43759-00** Front Caliper. **\$41.95**  
Fits left hand calipers on '00-'07 FXDWG and '00-later Softail® models (except Springer® and FXSTD models). Will not fit with braided brake lines.

**43553-00** Rear Caliper. **\$37.95**  
Fits '00-'05 Dyna® and '00-'07 Softail models (except '06-'07 FXST, FXSTB, FXSTS and FLSTFSE2). Will not fit with braided brake lines.

Notice: The prices appearing in this catalog are the manufacturer's suggested retail prices. Actual retail prices may vary.

### A. SMOOTH FULL COVERAGE CALIPER COVER

These covers provide the easiest and least expensive way to add chrome to the flat black finish of stock brake calipers. They install in minutes without tools.

**43260-98** Front. **\$29.95**  
Fits '84-'99 models.

#### Shown with:

#### 1. Brake Bleeder Screw Cover

**43834-98** **\$21.95**  
Fits '84-later stock calipers (except XR models).

#### 2. Chrome Banjo Bolt Cover

**32715-98** **\$19.95**  
Fits '84-later models with stock master cylinders and calipers. (Does not fit VRSC™ Rear Master Cylinder, '06-later VRSC calipers, '08-later Touring or '04-later XL models.)

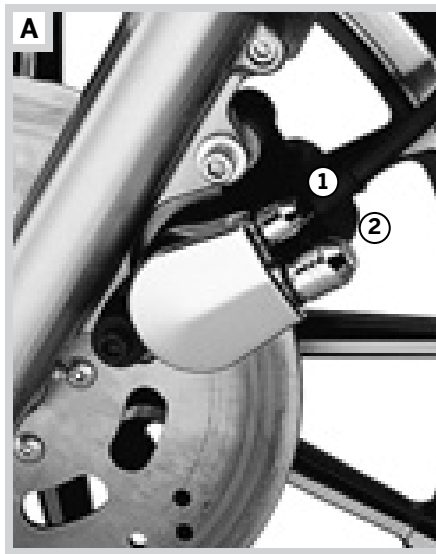

**A. SMOOTH FULL COVERAGE CALIPER COVER – FRONT**



**B. CUSTOM CALIPER BOLT COVER KIT**

### B. CUSTOM CALIPER BOLT COVER KIT

Complete the custom transformation. This complete kit hides the exposed Original Equipment caliper hardware with machined brass chrome-plated covers. Held firmly in place with an internal retention clip, this easy-to-install kit includes the large and small 12-point bolt covers required to customize a single caliper.

**40955-05** Four Large and Two Small Covers. **\$27.95**  
Fits '00-later front brake calipers (except Springer® models, '04-later XL, '08-later Touring, '06-later VRSC and models equipped with caliper covers). Also fits rear calipers on '06-later FXST, FXSTB, FXSTS, and FLSTSB models.

**40959-05** Three Large and Two Small Covers. **\$22.99**  
Fits '00-later rear brake calipers (except '04-later XL, '08-later Touring, '06-later FXST, FXSTB, FXSTS, FLSTSB, '06-later VRSC and models equipped with caliper covers).



**C. CHROME BANJO BOLT KIT**

### C. CHROME BANJO BOLT KIT

Replace the Original Equipment 12-point zinc finish brake line hardware with brilliant chrome custom tapered banjo bolts.

**41842-06** **\$27.95**  
Fits '91-'03 XL, '91-later Dyna® (except FXDF), '95-later Softail® and '99-'00 FXR models equipped with single front brake. Does not fit with Banjo Bolt Cover P/N 32715-98. Kit includes one 7/16" banjo bolt, three 3/8" banjo bolts and eight sealing washers.



**D. CHROME REAR AXLE ADJUSTER KIT**

### D. CHROME REAR AXLE ADJUSTER KIT

The perfect complement to a black or chrome swingarm, this mirror-finish Rear Axle Adjuster Kit replaces the stock zinc parts for a finished look. Manufactured from Original Equipment components for proven performance and reliability, this complete kit includes two chrome-plated adjuster plates and two chrome-plated socket head cap screws.

**41536-05** Fits '00-'05 Dyna models. **\$15.95**

### E. CHROME BRAKE DISC HARDWARE KIT

It's the details, like this chrome hardware kit, that really get your bike noticed. These Button Head Screws add a unique, chrome-plated finish to the Original Equipment or accessory floating brake rotors. Kit includes 5 chrome-plated bolts manufactured to factory specifications to ensure fit and performance.

**46646-05** Front. **\$12.95**  
Fits '90-later models (except VRSC™, XR, '06-later Dyna models with cast wheel option and '07-later FLHRSE3/4). Dual disc models require purchase of two kits.

**46647-05** Rear. **\$13.95**  
Fits '92-later models (except XR and Trike).

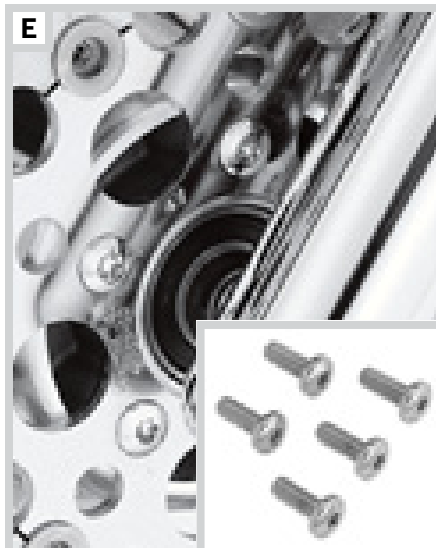

**E. CHROME BRAKE DISC HARDWARE KIT**



**F. CHROME HARDWARE KIT FOR REAR BELT SPROCKET – HEX HEAD**

### F. CHROME HARDWARE KIT FOR REAR BELT SPROCKET – HEX HEAD

This kit includes highly-polished, chrome-plated, grade 8 hex-head screws with chrome-plated washers, providing an extra custom accent.

**94773-07** **\$29.95**  
Fits '07-later Dyna and Softail models.

**94773-00A** **\$29.95**  
Fits '00-'06 Softail® and '00-'05 Dyna models.

**94708-98** **\$29.95**  
Fits '93-'99 Softail, '93-'99 Dyna, and '91-later XL models.





NEW

G

G. REAR FENDER SUPPORT COVER KIT – GLOSS BLACK

**G. REAR FENDER SUPPORT COVER KIT – GLOSS BLACK**

Manufactured from Original Equipment components to ensure superior fit and finish, the gloss black Fender Strut Covers conceal the cast fender struts and continue the dark look to the back of the bike. The ideal finishing touch for your "blacked-out" Fat Bob, these covers are the perfect complement to available gloss black Passenger Sissy Bars and Luggage Racks.

59473-09 Fits '08-later FXDF models.

**\$129.95****H. NARROW FRONT FENDER MUD FLAP**

Finish your narrow front fender with a splash of black and chrome. This black mud flap is formed to the fender contour for superior fit, and the rigid construction helps control road debris to keep your frame and engine clean. Styled chrome mount with Bar & Shield logo utilizes Original Equipment fender hole for no-drill installation.

59217-03

**\$69.95**

Fits '95-'07 FX Softail® models, and '95-'08 Dyna® models (except FXDF). Will not fit FXD, FXDX or FXDXT models equipped with Voltage Regulator Covers.

**I. CHROME FRONT FENDER EXTENSION**

Dress your front fender in chrome. This chrome-plated tapered Fender Extension is shaped to follow the curve of the fender for style and function. Using the Original Equipment fender hole, the extension mounts below the trailing edge of the fender to help control road dirt and spray.

59664-03

**\$47.95**

Fits '91-'08 Dyna and '84-'07 FX Softail models. Will not fit FXD, FXDX or FXDXT models equipped with Voltage Regulator Covers.

**J. BAR & SHIELD FRONT FENDER SPEAR**

This chrome-plated trim spear adds a sweeping dash of chrome to the front fender. Featuring a raised Bar & Shield logo set against a textured black field, this self-adhesive medallion is easy-to-install.

91194-04 Fits XL, Dyna and FX Softail® models. **\$34.95****K. CLASSIC COVERS KIT**

Customize your bike down to the last detail. These hardware Cover Kits include the chrome-plated ABS caps and plugs in the sizes and styles required to dress the viewable hardware on the motorcycle. Classic Covers are available as complete Bike Kits with the covers for both engine and chassis hardware, or as Engine-only kits to dress the Twin Cam or XL engine. The kits are easy to install, with no tools required.

94947-07 Bike Kit.

**\$259.95**

Fits '99-later Dyna® models.

94943-07 Engine Kit.

**\$109.95**

Fits Twin Cam-equipped models.



H

H. NARROW FRONT FENDER MUD FLAP

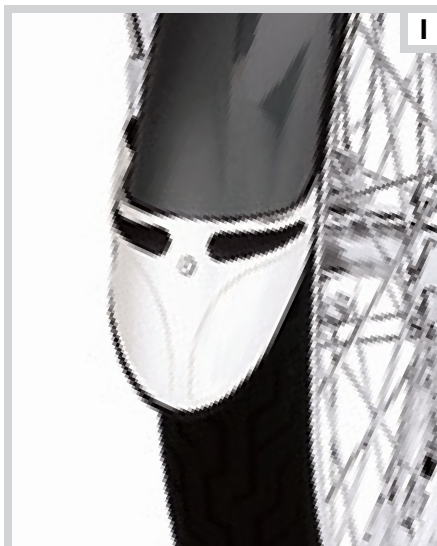

I

I. CHROME FRONT FENDER EXTENSION



J

J. BAR &amp; SHIELD FRONT FENDER SPEAR

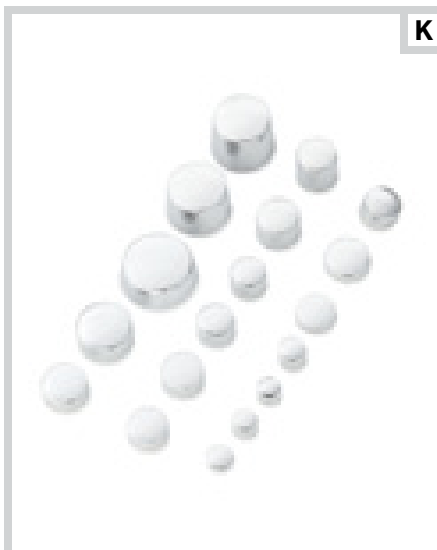

K

K. CLASSIC COVERS KIT – DYNA BIKE KIT (NOT ALL COMPONENTS SHOWN)

Notice: The prices appearing in this catalog are the manufacturer's suggested retail prices. Actual retail prices may vary.



# 172 DYNA®

Chassis Trim

## A. DYNA® CHROME BATTERY COVER

Dress your battery with a new chrome skin. This one-piece Chrome Battery Cover replaces the painted box, and adds a bright contrast to the Original Equipment satin aluminum trim band.

**66375-06** Fits '06-later Dyna® models. **\$77.00**

## B. CHROME BATTERY COVER BAND

This sweeping chrome band replaces the Original Equipment satin-finish band for a mirror-polished look. The easy-to-install ribbed chrome band is a high-contrast addition to a painted battery cover, or the perfect finishing touch to the Chrome Battery Cover P/N 66375-06.

**66439-07** Fits '06-later Dyna models. **\$29.95**

## C. "HARLEY-DAVIDSON" SCRIPT BATTERY COVER BAND

Replace the Original Equipment satin aluminum trim band with a splash of chrome. This easy-to-install custom contoured trim band features a black-filled embossed "Harley-Davidson" script design, and offers a stunning contrast to the factory painted battery cover or a great finishing touch for the Chrome Battery Cover P/N 66375-06.

**66443-06** Fits '06-later Dyna models. **\$37.95**

## D. SKULL BATTERY COVER BAND

Add a sinister touch to your Dyna motorcycle. This easy-to-install chrome band features a 3-dimensional skull design set off with black accents. Designed to replace the Original Equipment satin aluminum band, this chrome skull trim offers a stunning contrast to the factory painted battery cover or a great finishing touch for the Chrome Battery Cover P/N 66375-06.

**66442-06** Fits '06-later Dyna models. **\$37.95**

## E. BATTERY COVER FOR DYNA MODELS

This one-piece, chrome-plated Battery Cover has the top and side cover all-in-one. Bottom of cover is accented with a gloss black decal with Bar & Shield logo.

**66192-99** Fits '91-'05 Dyna models. **\$44.95**

## F. CHROME BATTERY SIDE COVER

This chrome-plated cover is designed for use with the new Harley-Davidson® AGM sealed maintenance-free batteries, and can be used in combination with Battery Top Cover P/N 66367-97 or 66368-97.

**66718-01** Fits '97-'03 XL models and '97-'05 Dyna models. **\$41.95**

## G. CHROME BATTERY COVERS\*

Chrome-plated battery enclosures include slotted openings for convenient visual check of battery fluid levels. Easy installation.

### Chrome

**1. 66375-97** **\$63.85**  
Fits '97-'05 FXD/X/XT models. Stock on FXDL, FXDWG and FXDS-CONV. models.

### Chrome Vented

**2. 66340-78** **\$38.80**  
Fits '82-'03 XL models, electric start FX, FXWG models, and '91-'96 Dyna models.

### USA Eagle

**3. 66358-83** **\$54.95**  
Fits '82-'03 XL models, electric start FX, FXWG models, and '91-'96 Dyna models.

\*NOTE: Battery dimensions of Harley-Davidson® AGM Batteries P/Ns 65989-97A, 65989-90B and 65991-82B may not allow use of accessory battery side covers on XL and Dyna models.

## H. CHROME BATTERY TOP COVER

Turn black to chrome with this easy-to-install cover.

**66368-97** Fits '97-'05 Dyna models. **\$51.00**

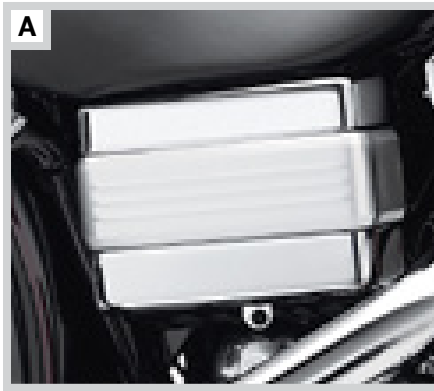

A. DYNA CHROME BATTERY COVER

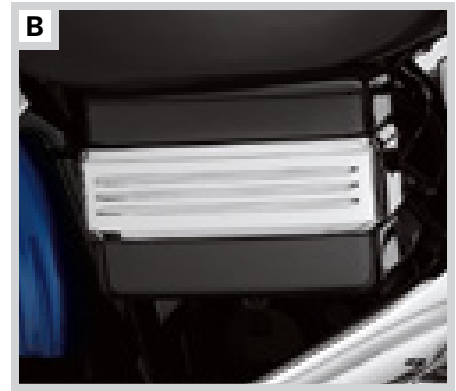

B. CHROME BATTERY COVER BAND



C. "HARLEY-DAVIDSON" SCRIPT BATTERY COVER BAND

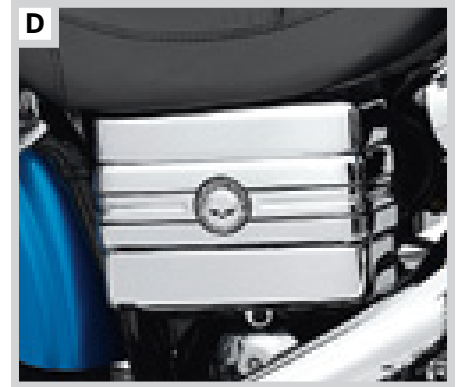

D. SKULL BATTERY COVER BAND



E. BATTERY COVER FOR DYNA MODELS



F. CHROME BATTERY SIDE COVER



G. CHROME BATTERY COVERS



H. CHROME BATTERY TOP COVER

Notice: The prices appearing in this catalog are the manufacturer's suggested retail prices. Actual retail prices may vary.

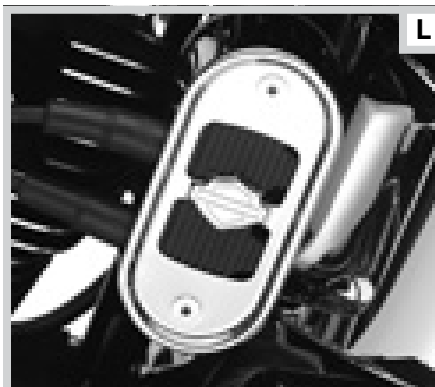
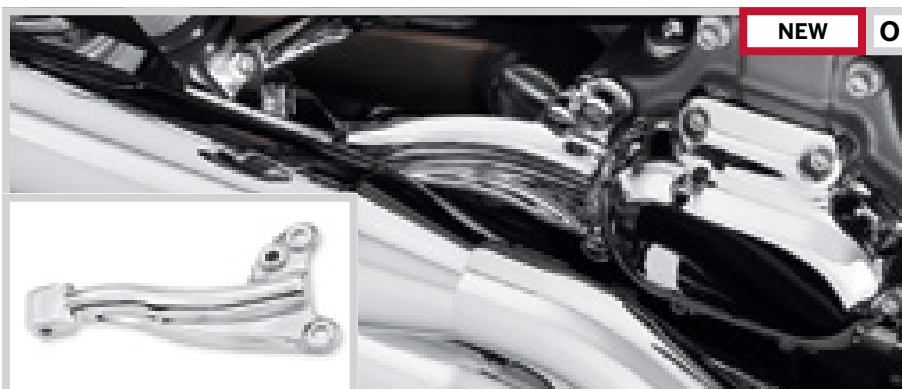
**I. CHROME ELECTRICAL PANEL COVER****J. CHROME ELECTRICAL PANEL COVER WITH TRIM****K. CHROME COIL COVER****L. BAR & SHIELD LOGO COIL COVER****M. VOLTAGE REGULATOR COVER FOR DYNA MODELS****N. VOLTAGE REGULATOR COVER****O. CHROME EXHAUST MOUNTING BRACKET****I. CHROME ELECTRICAL PANEL COVER****66333-90** Fits '91-'98 Dyna® models. **\$90.00****J. CHROME ELECTRICAL PANEL COVER WITH TRIM**

Chrome-plated Electrical Panel Cover with concealed mounting hardware provides a nice clean look. Kit includes panel cover, distinctive chrome-plated die-cast trim with black accented lines and Bar & Shield logo, and all necessary mounting hardware.

**66426-04** Fits '04-later Dyna models. **\$84.95****K. CHROME COIL COVER**

This sleek, Chrome Coil Cover features an innovative design that conceals all the mounting hardware. It offers a great, easy way to customize a very visible part of your Dyna motorcycles.

**31709-04** **\$37.95**

Fits '04-later fuel-injected Dyna models.

**L. BAR & SHIELD LOGO COIL COVER**

Featuring a radical open-face design with a Bar & Shield silhouette, this Chrome Coil Cover matches the Chrome Voltage Regulator Cover for an integrated custom look. Includes all mounting hardware.

**74616-04** **\$37.95**

Fits '01-later EFI Softail® models (except FXCW/C) and '04-later EFI Dyna models.

**M. VOLTAGE REGULATOR COVER FOR DYNA MODELS**

Designed for up-front style, the open face and floating Bar & Shield logo on this chrome cover provide good looks without compromising air flow across the voltage regulator. Kit includes chrome-plated mounting hardware.

**74667-06** Fits '06-later Dyna models. **\$38.95****74665-04** **\$38.95**

Fits '04-'05 FXDL and FXDWG models.

**N. VOLTAGE REGULATOR COVER**

With looks that create their own electricity, this chrome-plated cover features an embossed Bar & Shield logo and an open-center grill that allows air to flow through for regulator cooling. Designed for easy installation. Chrome mounting hardware included.

**74577-97** Fits '91-'03 Dyna models. **\$38.95****O. CHROME EXHAUST MOUNTING BRACKET**

Replace the stock black bracket with this brilliantly chrome-plated piece. Manufactured from Original Equipment components for precise fit, this Exhaust Bracket complements both chrome and jet black exhaust systems.

**80871-10** **\$64.95**

Fits '08-later FXDF and '10 FXDWG models.

# 174 DYNA®

## Hand Controls

### A. CHROME HAND CONTROL COMPONENTS

The flash of chrome. It's the first thing that everyone sees. And the one thing that everyone remembers. Dressing your bike's hand controls in chrome is one of the first steps in building a complete custom ride. After all, the hand controls are the one visual and physical connection you have with your bike every minute you are in the saddle. Harley-Davidson offers all the components you need to make the custom conversion.

A complete Chrome Hand Control makeover would include:

- Chrome Clutch Bracket and Master Cylinder Reservoir Kit
- Chrome Switch Housing Kit
- Chrome Switch Cap Kit
- Chrome Hand Control Levers
- Custom Hand Grips
- Custom Brake Lines and Control Cables

### B. CHROME CLUTCH BRACKET AND MASTER CYLINDER RESERVOIR KIT

Replace your stock painted aluminum controls with brilliant chrome, without compromising quality. This kit is manufactured from the Original Equipment components and includes Chrome Master Cylinder Cover. When combined with Chrome Switch Housing Kit, Chrome Switch Cap Kit, and other Genuine Motor Accessories, this front brake control kit provides a look that does more than stop your bike – it can stop traffic.

**45355-08** **\$329.95**  
Fits '08-later Dyna® and Softail® models equipped with single disc front brakes.

**45355-06A** **\$329.95**  
Fits '06-'07 Dyna® and Softail® models equipped with single disc front brakes. (Does not fit models equipped with hydraulic clutch.)

**45284-99D** **\$329.95**  
Fits '96-'03 XL, '96-'05 Dyna and Softail models with single disc front brakes. (Does not fit models equipped with hydraulic clutch.)

**45281-99D** **\$329.95**  
Fits '96-'03 XL, '96-'05 Dyna, Softail and '96-'04 Touring models with dual disc front brakes. (Does not fit models equipped with hydraulic clutch.)

**46418-05A** **\$329.95**  
Fits '05-'07 Touring and '06 Dyna and Softail models with dual disc front brakes. (Does not fit models equipped with hydraulic clutch.)

### C. CLASSIC CHROME STEERING STEM BOLT COVER KIT

For a finished appearance of the upper fork clamp on all models with 39mm forks.

**48329-90A** **\$31.95**  
Fits XL, Dyna, and FXR models with 39mm forks. (Does not fit FXDWG.)

### D. CHROME SWITCH HOUSING KIT

Convert your housings from black to chrome with this complete kit. Includes left, right, upper and lower housings. No switches or wiring required. Installation instructions included.

**70222-96B** **\$139.95**  
Fits '96-later VRSC™, XL, XR, Dyna, Softail and FLHR Road King® models. Does not fit FXSTDSE and FLHRSEI2 models.

#### Shown with:

#### CHROME SWITCH CAP KIT

Shaped for the same ergonomic feel as the Original Equipment hand control switches, these caps replace the stock black caps without re-wiring.

**71804-03** **\$18.95**  
Fits '96-later XL, XR, Dyna, Softail and FLHR models, '02-later VRSC models, and '98-'01 FLHRC models. FLHR models equipped with cruise control use Kit P/N 71808-03.

### E. CHROME MASTER CYLINDER COVER

Includes one chrome-plated cover, gasket, and decal. Easily installed with included stainless steel screws.

**46424-05B** **\$34.95**  
Fits '05-'07 Touring and '06-later Dyna and Softail models.

**45078-96D** **\$34.95**  
Fits '96-'03 XL, '02-'05 VRSC, '96-'05 Dyna, Softail and '96-'04 Touring models.



A. CHROME HAND CONTROL COMPONENTS



B. CHROME CLUTCH BRACKET AND MASTER CYLINDER RESERVOIR KIT (SHOWN WITH CHROME SWITCH HOUSING KIT)



C. CLASSIC CHROME STEERING STEM BOLT COVER KIT



D. CHROME SWITCH HOUSING KIT (SHOWN WITH CHROME SWITCH CAP KIT)



E. CHROME MASTER CYLINDER COVER

Notice: The prices appearing in this catalog are the manufacturer's suggested retail prices. Actual retail prices may vary.



F. CHROME HAND CONTROL LEVER KIT

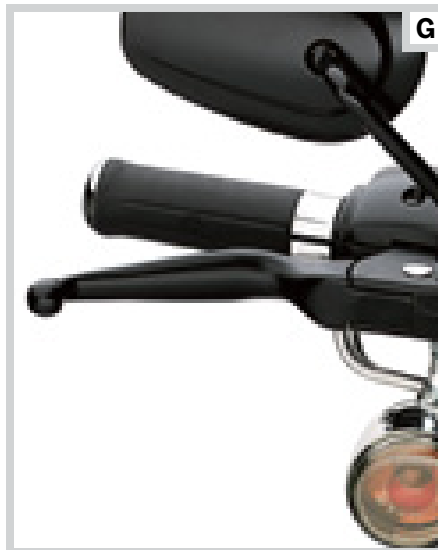

G. BLACK HAND CONTROL LEVER KIT

H. CHROME HANDLEBAR CLAMP  
HARDWARE KIT

I. HANDLEBAR CLAMP BOLT COVERS



J. BILLET HANDLEBAR RISER HARDWARE



K. CHROME HANDLEBAR RISER HARDWARE KIT

**F. CHROME HAND CONTROL LEVER KIT**

Continue the chrome theme with these Hand Control Levers. Cast from aluminum, these levers feature a custom finish designed to match the accessory chrome hand controls or complement Original Equipment-style black components. Clutch anti-rattle clip and new pivot bushings included.

**45075-08** **\$99.95**  
Fits '08-later Dyna® and Softail® models.

**45075-07** **\$99.95**  
Fits '96-'03 XL models and '96-'07 Dyna, Softail and Touring models. (Does not fit police models, VRSC™ models, or models equipped with hydraulic clutch.)

**46114-07** **\$85.95**  
Fits '02-'05 VRSC™ and '96-'06 Dyna, Softail and Touring models equipped with hydraulic clutch.

**G. BLACK HAND CONTROL LEVER KIT**

Grab some black with these levers – a natural fit for black accessory handlebars or to further the blacked-out look of your motorcycle. A clutch anti-rattle clip and new pivot bushings are included.

**44994-08** **\$99.95**  
Fits '08-later Dyna and Softail models.

**44994-07** **\$99.95**  
Fits '96-'03 XL models and '96-'07 Dyna, Softail and Touring models. (Does not fit police models, VRSC models, or models equipped with hydraulic clutch.)

**46157-03** **\$99.95**  
Fits '02-'05 VRSC™ and '96-'06 Dyna, Softail and Touring models equipped with hydraulic clutch.

**H. CHROME HANDLEBAR CLAMP HARDWARE KIT**

Finish the show-winning look with brilliant chrome hardware. Manufactured to Original Equipment specifications, this kit replaces the zinc-plated exposed handlebar clamp bolts with chrome-plated socket head cap screws.

**94452-05** **\$8.95**  
Fits '94-'06 FXDL, '06 FXD, FXDB, FXDC and FXD35, '94-'05 FXDWG, FXDWG2/3, FXR2/3, '94-later FXST, FXSTB, FXSTC, FLST, FLSTC, '94-'06 FLSTF and '93-'96 FLSTN models.

**94453-05** **\$8.95**  
Fits '95-later XL models (except XL Custom, XL883N, XL1200L and XL1200N), and '94-'05 FXD, FXDC, FXDX, FXDXT and FXDS-CONV. models.

**94454-05** **\$8.95**  
Fits XL1200L, XL1200N, '96-'06 XL883C and XL1200C, '07-later Dyna®, '00 FXR4, FLSTSE and FLSTFSE/2 models.

**I. HANDLEBAR CLAMP BOLT COVERS**

Complete the chrome hand control conversion. These thin-wall bolt covers are designed for easy installation over handlebar clamp bolts. The machined brass and chrome-plated covers are corrosion resistant, and the internal spring steel retention clip resists vibration and thermal cycling to securely hold the covers in place. Kit includes 4 covers.

**94413-04** **\$17.95**  
Fits 5/16" socket head handlebar clamp bolts. (Does not fit Touring models).

**J. BILLET HANDLEBAR RISER HARDWARE**

Provides a highly polished and plated, machined steel, conical shaped washer. Chrome socket head cap screw is countersunk into the washer upon installation for a very clean look. Screws are also chrome-plated. Looks great with Original Equipment or billet triple trees.

**63026-05** **\$39.95**  
Fits '91-later Dyna® models (except '08-later FXDB) and '97-later FXST, FXSTB, FXSTC, and FXSTD models. Also fits '93-'00 FXR models.

**K. CHROME HANDLEBAR RISER HARDWARE KIT**

Finish the show-winning look with brilliant chrome hardware. Manufactured to Original Equipment specifications, this kit replaces the zinc-plated exposed handlebar riser hardware with chrome-plated bolts and chrome lock washers.

**63027-05** **\$9.95**  
Fits '91-later Dyna models (except '08-later FXDB, FXDF and FXDSE/2) and '97-later FXST, FXSTB, FXSTC and FXSTD models. Also fits '93-'00 FXR models.



# 176 DYNA®

## Hand Controls

### A. BILLET BRAKE LINE CLIP

It's the details that count. Replace the Original Equipment black brake line clamp with this beautifully chrome-plated billet aluminum clip. Sized for Original Equipment or braided brake lines, these "ball-milled" clips mount in the factory position for easy installation. Kit includes chrome-plated mounting hardware.

**91336-03** **\$21.95**  
Fits '00-'07 FXST, FXSTB, FXSTC, FXSTD, and FXDWG models equipped with Original Equipment brake lines.

**91364-03** **\$21.95**  
Fits '00-later FXST, FXSTB, FXSTC, FXSTD, and FXDWG models equipped with Harley-Davidson® Braided Brake Lines. Also fits '08-later FXST, FXSTB, FXSTC and FXDWG with Original Equipment brake lines.

**91369-03** **\$21.95**  
Fits '00-later XL and Dyna® (except FXDWG) models equipped with Harley-Davidson Braided Brake Lines. Also fits '08-later Dyna models (except FXDWG) with Original Equipment brake lines.



A. BILLET BRAKE LINE CLIP



B. BILLET CLUTCH CABLE ADJUSTER DUST COVER

### B. BILLET CLUTCH CABLE ADJUSTER DUST COVER

Replace the black rubber clutch cable boot with brilliant chrome. Machined from billet aluminum, this two-piece "ball-milled" dust cover offers a striking contrast to Original Equipment black cables, and a natural finishing touch when installing a braided clutch cable. Easy-to-install with included hardware.

**64108-03** **\$49.95**  
Fits '00-later XL, Dyna® and Softail® models (except FLSTSE). '00-'03 XL models require installation of Clutch Cable Clamp P/N 91147-02, and '04-later XL models require installation of Clutch Cable Clamp P/N 91249-04 (sold separately).

### C. CHROME BILLET CLUTCH CABLE CLAMP

The perfect addition to braided or stock black clutch cables. This Clutch Cable Clamp is machined from aluminum billet, and polished and plated for a lasting shine. The clamp is designed to grip the cable and the frame down tube, adding a custom look to the front of your cycle.

**38804-07** **\$39.95**  
Fits models with 1-1/2" diameter front frame down tube. Fits '06-later Dyna® models. Stock on FXDSE and FXDFSE/2 models.

**91147-02** **\$39.95**  
Fits models with 1-1/4" diameter front frame down tube. (Does not fit Touring, '04-later XL, '08-later XR and '06-later Dyna models.)



C. CHROME BILLET CLUTCH CABLE CLAMP



D. CHROME THROTTLE CABLE CLIP

### D. CHROME THROTTLE CABLE CLIP

Tie up the loose ends to complete your custom ride. When matched to Original Equipment black cables or available braided cables, these chrome-plated clips link the throttle/idle cables with brilliant chrome.

**91274-04** **\$29.95**  
Fits '84-later models (except '08-later Touring).

### E. POLYURETHANE HANDLEBAR RISER BUSHINGS

These Handlebar Riser Bushings replace the Original Equipment stacked rubber and zinc washer combination with a molded one-piece polyurethane bushing and chrome cover. The long-lasting bushing can reduce handlebar vibration, and the chrome cover adds a bright finishing touch.

**56165-03** **\$39.95**  
Fits '97-'03 XL, '86-later Dyna® (except FXDB) and Softail® (except Springer® and FXSTD) models. '86-'93 FL Softail models require use of '94-later Riser Bolts. Will not fit with Chrome Riser Cup Washer Kit P/N 56486-01.

### F. REDUCED EFFORT CLUTCH KIT

Kit includes a new clutch spring and inner/outer ramps that significantly reduce clutch lever effort. Original Equipment on '06-later Twin Cam-equipped models.

**36808-05** **\$44.95**  
Fits '99-'05 Twin Cam-equipped models. Stock on '06-later Twin Cam-equipped models. This kit is not compatible with Screamin' Eagle® Performance Parts.



E. POLYURETHANE HANDLEBAR RISER BUSHINGS



F. REDUCED EFFORT CLUTCH KIT

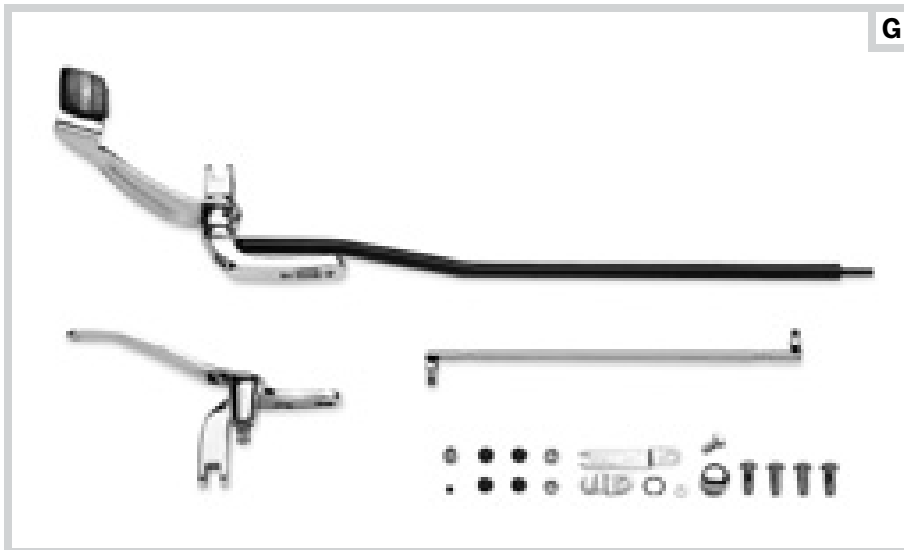

**G. FORWARD CONTROLS FOR DYNA MODELS – CHROME ('93-'05 MODELS SHOWN)**

**G. FORWARD CONTROLS FOR DYNA® MODELS\***

Stretch out for maximum comfort and style. This complete kit includes all components necessary to convert a mid-control equipped Dyna model to forward controls. Kit is available in chrome or gloss black versions to match your customizing style.

**49080-06A** Chrome. **\$359.95**  
Fits '06-later Dyna models with mid-controls.

**49021-09** Gloss Black. **\$339.95**  
Fits '06-later Dyna models with mid controls.

**49080-03A** Chrome. **\$349.95**  
Fits '93-'05 Dyna models. Stock on '03-'05 FXDWG models. Not compatible with Engine Guard on FXD and FXDL models.

**H. CHROME FORWARD CONTROL FOOTREST SUPPORT**

Upgrade the look of your stock black forward controls with these mirror-finish chrome brackets. Manufactured from Original Equipment components to ensure proper fit and function, these polished and plated support brackets add a custom touch to your Wide Glide® motorcycle.

**33695-03** Left Support. **\$99.95**  
Fits '03-later FXDWG, and '03-later Dyna models with forward controls.

**33697-03A** Right Support. **\$99.95**  
Fits '03-later FXDWG, and '03-later Dyna models with forward controls.

**42664-03A** Footpeg Clevis. (not shown) **\$29.95**  
Fits '03-later FXDWG, and '03-later Dyna models with forward controls.

**33695-93** Left Support. (not shown) **\$99.95**  
Fits '93-'02 FXDWG.

**33697-93** Right Support. (not shown) **\$99.95**  
Fits '93-'02 FXDWG models.

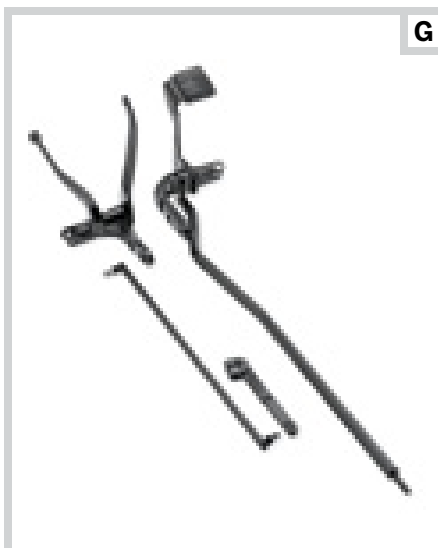

**G. FORWARD CONTROLS FOR DYNA MODELS – GLOSS BLACK**

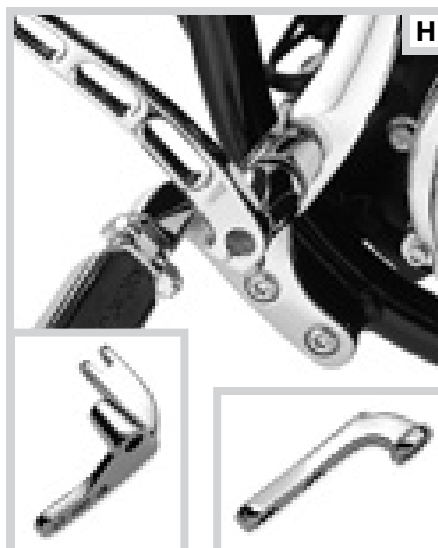

**H. CHROME FORWARD CONTROL FOOTREST SUPPORT**

**I. CHROME RISER CUP WASHER KIT**

Add a finishing touch to the riser on your bike. This kit includes two styled and chrome-plated washers that replace the standard metal washers below the handlebar risers. Replaces Original Equipment P/N 56159-73.

**56486-01** **\$23.95**  
Fits many XL (except '04-later XL models), Dyna and Softail models. See your Dealer for specific model application. Does not fit with Polyurethane Handlebar Bushing P/N 56165-03.

**J. CHROME BILLET ENGINE GUARD FOOTPEG MOUNTING KIT\*\***

Here's a stylish way to get your feet into the wind. This beautifully polished and chrome-plated billet aluminum footpeg mount kit installs easily on your engine guard, and lets you stretch your legs on cross-country rides. Works with all H-D style male-mount footpegs.

**50957-02B** **\$99.95**  
Fits front engine guards with 1-1/4" diameter tubing (except VRSC Guard P/N 49267-01A, 49388-09, XL Engine Guard P/N 49060-04A, 49215-07 or Softail® Nostalgic Engine Guard P/N 49037-05). Requires separate purchase of Chrome Bullet Tip Footpeg Bolt Kit P/N 94133-01.



**I. CHROME RISER CUP WASHER KIT**



**J. CHROME BILLET ENGINE GUARD FOOTPEG MOUNTING KIT**

**\*WARNING:** Installation of accessory Forward Control Kits may affect cornering clearance. This could distract the rider, causing loss of control, resulting in death or serious injury.

**\*\*WARNING:** Do not use engine guard footpegs under normal stop and go operating conditions. Doing so could result in death or serious injury.

Notice: The prices appearing in this catalog are the manufacturer's suggested retail prices. Actual retail prices may vary.

# 178 DYNA®

## Foot Controls

### A. BILLET STYLE REAR BRAKE LEVER

Styled to complement our billet style mirror stems and shift levers, these Billet Style Rear Brake Levers are forged from 2014-T6 aluminum, then machined, polished and chrome-plated or powder-coated for a beautiful, custom look. Levers are available in mirror-chrome or satin-black finish. Brake pedal pads sold separately.

**42666-03** Chrome. **\$139.95**  
Fits '03-later Dyna® models equipped with forward controls.

**46873-09** Satin Black. **\$139.95**  
Fits '03-later Dyna models equipped with forward controls.

### B. BILLET STYLE SHIFT LEVER

Styled to complement our billet style mirror stems, these Billet Style Shift Levers are forged from 6061-T6 aluminum, then machined and finished in chrome or satin black for a beautiful, custom look. Includes chrome hardware.

**34539-00** Chrome. **\$79.95**  
Fits '91-later Dyna and '90-later FX Softail® models.

**34016-08** Satin Black. **\$79.95**  
Fits '91-later Dyna® and '90-later FX Softail models equipped with forward controls.

### C. BULLET SHIFT LEVER

The "bullet-grooved" sweep of this forward-curving shift lever accents the style of your low and lean motorcycle. Designed to complement the "Bullet" shift linkage and mirrors, this beautifully chromed lever also looks great with Original Equipment brake levers and linkages.

**34616-02** ~~Chrome~~ **\$89.95**  
Fits '91-later Dyna and '90-later FX Softail® models.

### D. DYNA® CHROME REAR BRAKE LEVER

We start with a stock brake lever, then we add custom styling with highly polished chrome-plating, resulting in a great combination of form and function. Kit includes bushing, pin and linkages for easy installation.

**42617-99** **\$89.95**  
Fits '90-later Dyna® models (except FXDWG, FXDF, FXDFSE/2 and models with forward controls).



A. BILLET STYLE REAR BRAKE LEVER – CHROME



A. BILLET STYLE REAR BRAKE LEVER – SATIN BLACK



B. BILLET STYLE SHIFT LEVER – CHROME

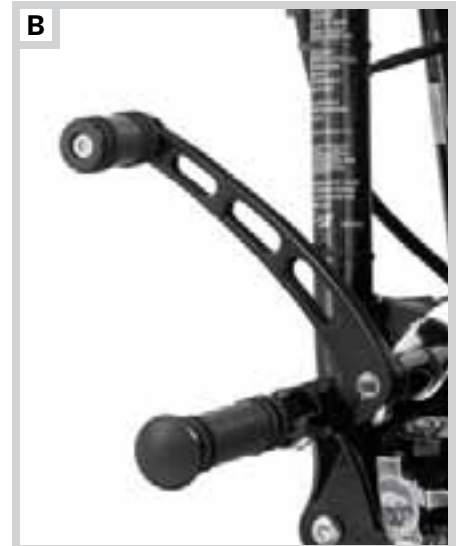

B. BILLET STYLE SHIFT LEVER – SATIN BLACK



C. BULLET SHIFT LEVER



D. DYNA CHROME REAR BRAKE LEVER

Notice: The prices appearing in this catalog are the manufacturer's suggested retail prices. Actual retail prices may vary.

NEW

E



E. CUSTOM GEAR SHIFT LINKAGES

**E. CUSTOM GEAR SHIFT LINKAGES**

Kick your custom into gear with this collection of high quality custom shift linkages. Available in a variety of designs to match your bike's style, these linkages feature aircraft quality rod ends for easy adjustment and smooth operation. The easy-to-install linkage kit includes a transmission lever cover and decorative acorn nuts and bolts for a complete custom look.

Fits '06-later Dyna® models equipped with forward controls.

<b>1. 33838-09</b>	Flame.	<b>\$149.95</b>
<b>2. 33761-09</b>	Slotted with Bar & Shield Logo.	<b>\$129.95</b>
<b>3. 34848-09</b>	Skull.	<b>\$129.95</b>
<b>4. 33815-06</b>	Round.	<b>\$89.95</b>
<b>5. 33745-09</b>	Black Anodized Slotted.	<b>\$129.95</b>
<b>6. 33917-09</b>	Diamond Black.	<b>\$129.95</b>

Fits '95-'05 FXDWG models and Dyna models equipped with Forward Control Kit P/N 49080-03.

<b>33815-98A</b>	Round.	<b>\$89.95</b>
------------------	--------	----------------

**F. SHIFTER LINKAGE COVER – “HARLEY-DAVIDSON” SCRIPT**

A simple and inexpensive way to detail your Dyna® model. These easy-to-install chrome-plated covers conceal the stock shifter linkage for a brilliant finish. Kit includes all necessary mounting hardware.

<b>33878-04</b>		<b>\$41.95</b>
Fits '97-'05 FXDWG and '93-'05 Dyna models equipped with Forward Control Kit P/N 49080-03.		

**G. POLISHED SHIFT LINKAGE FOR DYNA MODELS**

Replace your zinc-plated Original Equipment shift linkage with this polished stainless steel linkage.

<b>33872-06</b>		<b>\$84.95</b>
Fits '06-later Dyna models with mid-controls.		
<b>33872-00</b>		<b>\$84.95</b>
Fits '91-'05 FXD, FXDX, FXDL and FXDS-CONV. models.		

**H. JIFFY STAND EXTENSION**

Park it quick and easy with this chrome-plated Jiffy Stand Extension. Makes locating and maneuvering your jiffy stand easier.

<b>50214-98A</b>		<b>\$39.95</b>
Fits '93-later Dyna® models (except FXDS-CONV., FXDWG2, FXDFSE2 and '01 FXDL).		



F. SHIFTER LINKAGE COVER – “HARLEY-DAVIDSON” SCRIPT



G. POLISHED SHIFT LINKAGE FOR DYNA MODELS

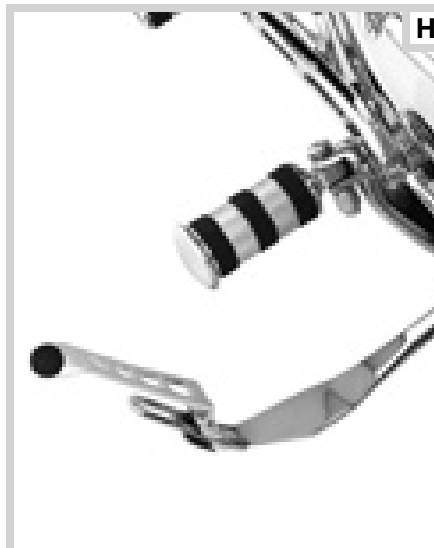

H. JIFFY STAND EXTENSION

Notice: The prices appearing in this catalog are the manufacturer's suggested retail prices. Actual retail prices may vary.



# 180 DYNA®

Foot Controls & Highway Pegs

## A. MINI FOOTBOARD KIT

This Mini Footboard Kit can be installed in place of traditional footpegs and provides a little additional leg support and more options to move your feet around on a long run. Mini Footboards mount to standard H-D style footpeg supports, and can be used in many rider and passenger applications. A little larger than a bicycle pedal, Footboards can be pivoted to the proper angle for maximum riding comfort. The sole-gripping horizontal black rubber bands complement the mirror-chrome finish, and add vibration isolation and a rich appearance to the pegs. Complete the look with Shifter Pegs and Brake Pedal Pads from the Chrome and Rubber Collection.

**50451-09 \$109.95**

Fits models with forward controls (except FXCW/C, VRSCDX and VRSCF). Does not fit with mid-controls or with Frame Mounted Highway Pegs P/N 50855-09 and 50865-09. Fits passenger male mount style footpeg supports on most models (except '03-earlier XL, '06-earlier VRSC™, '05-earlier Dyna®, and FXSTD, FLSTSB, FLSTF, FLSTN and Softail® models with shotgun exhaust). Softail passenger position also requires Support Kit P/N 50454-09.



A. MINI FOOTBOARD KIT

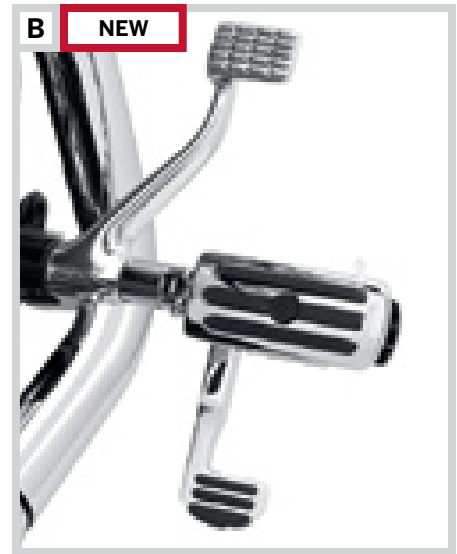

B. HEEL RAISER FOOTPEG KIT

## B. HEEL RAISER FOOTPEG KIT

Comfort and cool, clean looks in one. Heel Raiser Chrome and Rubber Footpegs provide a large surface area that lets you change foot position for maximum comfort, and the fold-out heel rest provides floorboard-style support that relieves calf and thigh tension on the highway. The heel rest can be deployed or retracted with your boot while riding. The sole-gripping horizontal black rubber bands complement the mirror-chrome finish, and add vibration isolation and a rich appearance to the pegs. Complete the look with Shifter Pegs and Brake Pedal Pads from the Chrome and Rubber Collection. Heel Raiser mounts to the standard H-D style footpeg support, so it can be used in many rider and passenger applications.

**50178-09 \$189.95**

Fits H-D® male mount style footpeg supports (except the rider position on '02-later VRSCD/DX/F/R/X, '07-later XL883L, XL883N, XL1200N, '09-later XR, '08-later FXCW/C, and passenger position on Softail models). Fits mid-control equipped XL and Dyna models when equipped with engine guards and Highway Peg Mount P/N 50964-98 or 50957-02B. Does not fit with Adjustable Passenger Footpeg Support P/N 50763-09 or 50787-09, or Whiskers Adjustable Highway Bar P/N 50855-09 and 50865-09. Does not fit mid-control position.



C. RIDER FOOTPEG HEEL RESTS FOR FORWARD CONTROLS

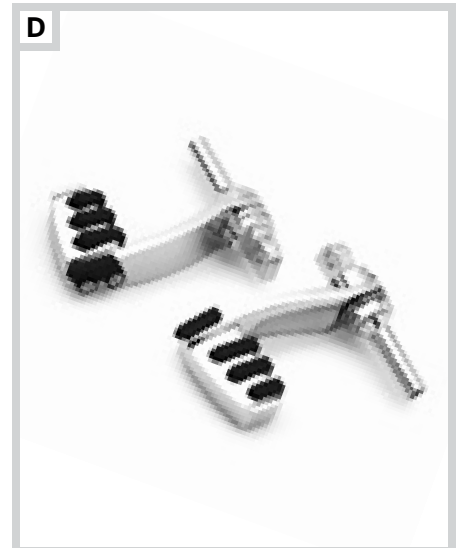

D. AIRFOIL HEEL RESTS

## C. RIDER FOOTPEG HEEL RESTS FOR FORWARD CONTROLS

Give your feet a rest while you're stretching out on your forward controls. These adjustable billet-style Rider Footpeg Heel Rests reduce fatigue and make you look as good as you feel. Just add a pair of matching shifter pegs to complete the custom look (sold separately).

**50227-01 \$119.95**

Fits '93-'02 FXDWG and '89-later FX Softail® models. Also fits Dyna® models equipped with Forward Control Kit P/N 49080-93 and late '87-'99 FXSTS and FXSTC models equipped with Extended Reach Forward Control Kit P/N 49163-91.

## D. AIRFOIL HEEL RESTS

Designed to complement H-D Airfoil Footpegs, these Airfoil Heel Rests help reduce rider fatigue on a long trip, and add a touch of style around town.

**50281-01 \$119.95**

Fits '89-later FX Softail models (except FXCW/C) and '90-later Dyna models (except '03-later FXDWG and Dyna models with forward controls).

## E. ADJUSTABLE HIGHWAY PEG MOUNTING KIT\*

Versatility with style and comfort. Choose from several H-D® custom footpegs to complete the cruiser look. Easy-to-install. (NOTE: Kit cannot be used with any front engine guard.)

**49002-98 \$104.95**

Fits Dyna® models (except FXDWG, FXDF, and models equipped with forward controls).



E. ADJUSTABLE HIGHWAY PEG MOUNTING KIT



F. HIGHWAY PEG MOUNTING KIT

## F. HIGHWAY PEG MOUNTING KIT\*

Kick back and cruise. Kit includes chrome mounting plates, chrome footpeg supports, and all necessary mounting hardware. Uses H-D® male-mount footpegs.

**49019-95 \$149.95**

Fits '95-later FXD and FXDC models.

*Notice: The prices appearing in this catalog are the manufacturer's suggested retail prices. Actual retail prices may vary.*



**NEW** **G**

**G. ADJUSTABLE PASSENGER FOOTPEG MOUNT KIT**



**NEW** **G**

**G. ADJUSTABLE PASSENGER FOOTPEG MOUNT KIT**

**G. ADJUSTABLE PASSENGER FOOTPEG MOUNT KIT**

Maximize your passenger's riding comfort. Proper foot position reduces the cramped or stretched-out feeling, and relieves pressure on the knees and the tail bone. These Adjustable Mounts raise and lower the passenger footpeg to accommodate taller and shorter passengers. Easy to adjust with common tools, the mount adjusts through a 360° range (depending on model), allowing both fore and aft and up and down height adjustment. Kit includes left and right adjustable support assembly and all required mounting hardware. Footpegs sold separately.

**50763-09** **\$149.95**

Fits models with H-D male mount style passenger footpeg supports (except Softail® models). Does not fit with Heel Raiser Footpeg Kit P/N 50178-09. Does not fit the rider position.

**H. CHROME PASSENGER FOOTPEG SUPPORT KIT**

These chrome-plated supports add a touch of style to your Dyna motorcycle. Kit includes left and right supports.

**49249-06** Fits '06-later Dyna® models. **\$129.95**

**I. WRINKLE BLACK PASSENGER FOOTPEG SUPPORT KIT**

Add footpegs to your solo seat-equipped Dyna motorcycle. Kit includes wrinkle black finished left and right footpeg supports and mounting hardware. Footpegs and footpeg hardware sold separately.

**50210-06** Fits '06-later Dyna models. **\$69.95**

**J. PASSENGER FOOTBOARD SUPPORT KIT**

Add the comfort and convenience of passenger footboards to your Dyna motorcycle. This support kit is designed to allow installation of Traditional D-Shaped, Swept Wing, Tapered, or Old-Style Passenger Footboards (*sold separately*) on Dyna models. Kit includes left and right supports, footboard mount hinge pins, and installation hardware.

Fits '06-later Dyna models (except FXDF and '10 FXDWG).

**49279-06** Chrome. **\$199.95**

**49349-07** Black. **\$179.95**

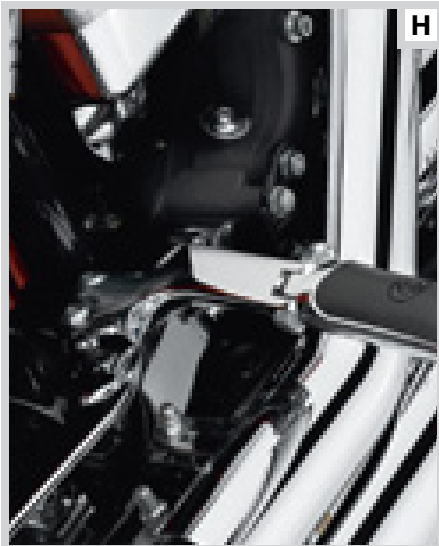

**H**

**H. CHROME PASSENGER FOOTPEG SUPPORT KIT**



**I**

**I. WRINKLE BLACK PASSENGER FOOTPEG SUPPORT KIT**



**J**

**J. PASSENGER FOOTBOARD SUPPORT KIT – CHROME**



**J**

**J. PASSENGER FOOTBOARD SUPPORT KIT – BLACK**



**\*WARNING:** Do not use highway pegs under normal stop and go operating conditions. Doing so could result in death or serious injury.

Notice: The prices appearing in this catalog are the manufacturer's suggested retail prices. Actual retail prices may vary.

# 182 DYNA®

## Engine Guards

### A. ENGINE GUARD KIT\*

Protect your bike without sacrificing ground clearance or style. The one-piece engine guard is designed to complement the lines of the motorcycle and the available chrome or gloss black finish adds the perfect finishing touch.

For use with the mid or forward controls. Fits '06-later Dyna® models. Fits with Oil Cooler Kit P/N 26151-07. Will not fit with Oil Cooler Kit P/N 26110-05. FXDSE/2 and FXDFSE/2 requires removal of front chin spoiler and separate purchase of Regulator Caddy P/N 70464-08. California models also require separate purchase of Canister Bracket P/N 47207-06.

<b>49320-09</b>	Black.	<b>\$209.95</b>
<b>49010-06</b>	Chrome.	<b>\$209.95</b>

For use with mid-controls. Fits '91-'05 Dyna models (except '93-'05 FXDWG and '94-'05 FXDS-CONV. models). Not compatible with Dyna Forward Control Kit P/N 49080-93 or Footboard Kit P/Ns 50580-01 and 50601-01. Will fit with Leather Tool Roll Kit P/N 91714-97A.

<b>49007-90A</b>	Chrome.	<b>\$209.95</b>
------------------	---------	-----------------

For use with forward controls. Fits '93-'05 FXDWG and FXDS-CONV. models. Also fits FXDX models. (Compatible with Forward Control Kit P/N 49080-93 only on FXDWG models.) Will not fit with Oil Cooler P/N 62871-00A, 26081-05, Dyna Fan Kit P/Ns 91551-00A or 91552-00A, Dyna Motor Mount Cover P/N 48426-98, Chrome Front Spoiler P/N 57081-01 or with Color-Matched Front Spoilers.

<b>49010-93</b>	Chrome.	<b>\$209.95</b>
-----------------	---------	-----------------

### B. PERSONAL ACCENTS CONSOLE INSERT COLLECTIONS

As a rider, there is probably no part of your bike you see more than your dash and tank console. And thanks to Personal Accents Inserts, it's also the easiest part of your bike to customize. Console inserts are available in a stylish assortment of finishes that blend with your personal direction. Matching Tour-Pak® Inserts are also available to complete the custom transformation.

Fits '00-later Softail® (except FXSTD, FXCW/C, FLSTSB and '09 FLSTC) and '99-'03 FXDWG models.

<b>1. 71129-05</b>	Bar & Shield.	<b>\$54.95</b>
<b>2. 71172-05</b>	Flamed.	<b>\$54.95</b>
<b>3. 71337-05</b>	Vivid Black.	<b>\$74.95</b>
<b>4. 70928-07</b>	Stacked Skulls.	<b>\$54.95</b>



A. ENGINE GUARD KIT – CHROME ('06 DYNA MODEL SHOWN)



A. ENGINE GUARD KIT – GLOSS BLACK



B. PERSONAL ACCENTS CONSOLE INSERT COLLECTIONS



**\*WARNING:** These guards may provide limited leg and cosmetic vehicle protection under unique circumstances (fall over while stopped, very low speed slide). They are not made nor intended to provide protection from bodily injury in a collision with another vehicle or any other object.

Notice: The prices appearing in this catalog are the manufacturer's suggested retail prices. Actual retail prices may vary.



**C. CHROME DASH PANEL EXTENSION – '04-'08 DYNA WIDE GLIDE MODELS**



**D. CHROME DASH PANEL EXTENSION – '95-'03 DYNA WIDE GLIDE MODELS**



**E. PREMIUM TANK PANEL WITH POUCH**



**F. LEATHER TANK PANEL WITH TEARDROP CONCHO AND POUCH**



**G. LEATHER TANK PANEL WITH POUCH AND BRAIDED TRIM**



**H. LEATHER TANK PANEL WITH POUCH, CONCHO AND CHROME STUDS**



**I. LEATHER TANK PANEL WITH POUCH, CONCHO AND BRAIDED FLAP**



**J. LEATHER TANK PANEL WITH EMBOSSED SKULL LOGO**

**C. CHROME DASH PANEL EXTENSION**

Stretch the lines of your chrome dash panel the full length of the fuel tank. This chrome-plated trim kit continues the lines and finishes of your standard tank panel to the front of the seat. The curving lines and Bar & Shield logo add a custom touch without the expense of a custom tank.

**71282-04** **\$41.95**  
Fits '04-'08 FXDWG, '06 FXD35 and '07-later FXDC models.

**D. CHROME DASH PANEL EXTENSION – DYNA® WIDE GLIDE® MODELS**

Stretch the lines of your chrome dash panel the full length of the fuel tank. This chrome-plated trim kit continues the lines and finishes of your standard tank panel to the front of the seat, adding a custom touch without the expense of a custom tank.

**71284-01** **\$41.95**  
Fits '95-'03 FXDWG models.

**E. PREMIUM TANK PANEL WITH POUCH**

This leather tank panel features an over-sized pouch for convenient "at your fingertips" storage. The heavy duty leather pouch will maintain its shape for miles to come while the bold chrome Bar & Shield medallion sits proudly on the flap for all to admire.

**91135-09** **\$99.95**  
Fits '00-later Softail® models (except FXCW/C, FXSTD, FLSTSB, FLSTFSE2 and FXSTSSE/2/3) and '93-'08 FXDWG, FXD35, '93-'05 FXDL and '07-later FXDC and FXDF models. '93-'03 FXDWG models require the separate purchase of Clip P/N 10102 and O-Ring P/N 11174.

**F. LEATHER TANK PANEL WITH TEARDROP CONCHO AND POUCH**

Stylish leather tank panel puts a convenient storage pouch right at your fingertips. Embossed basket-weave pattern and bright chrome teardrop concho matches the Softail® Springer® Classic trim, and complements other smooth leather and vinyl seats and bags.

**91469-06** **\$79.95**  
Fits '00-later Softail® models (except FXCW/C, FXSTD, FLSTSB, FLSTFSE2, FXSTSSE/2/3 and '09-later FLSTC) and '93-'08 FXDWG, '06 FXD35 and '07-later FXDF and FXDC models. '93-'03 FXDWG models require the separate purchase of Clip P/N 10102 and O-Ring P/N 11174.

**G. LEATHER TANK PANEL WITH POUCH AND BRAIDED TRIM**

**91409-00** **\$79.95**  
Fits '00-later Softail models (except FXCW/C, FXSTD, FLSTSB, FLSTFSE2, FXSTSSE/2/3 and '09-later FLSTC) and '93-'03 FXDWG models.

**H. LEATHER TANK PANEL WITH POUCH, CONCHO AND CHROME STUDS**

**91407-00** **\$79.95**  
Fits '00-later Softail models (except FXCW/C, FXSTD, FLSTSB, FLSTFSE2, FXSTSSE/2/3 and '09-later FLSTC) and '93-'03 FXDWG models.

**I. LEATHER TANK PANEL WITH POUCH, CONCHO AND BRAIDED FLAP**

**91408-00** **\$79.95**  
Fits '00-later Softail® models (except FXCW/C, FXSTD, FLSTSB, FLSTFSE2, FXSTSSE/2/3 and '09-later FLSTC) and '93-'03 FXDWG models.

**J. LEATHER TANK PANEL WITH EMBOSSED SKULL LOGO**

Add a little menace to your bike with this skull-embossed leather tank panel.

**91001-01** **\$49.95**  
Fits '00-later Softail® models (except FXCW/C, FXSTD, FLSTSB, FLSTFSE2, FXSTSSE1/2 and '09-later FLSTC) and '93-'03 FXDWG models.

*Notice: The prices appearing in this catalog are the manufacturer's suggested retail prices. Actual retail prices may vary.*



# 184 DYNA®

## Consoles & Gauges

### A. CHROME CONSOLE KIT

Replace the wrinkle black console with a sweep of chrome. Manufactured to Original Equipment specifications, this mirror-chrome dash panel fits like a glove around the stock fuel cap and fuel gauge. Kit includes chrome-plated stainless steel mounting hardware.

**67188-04** **\$134.95**  
Fits '04-later FXD, FXDX and '04-'06 FXDC models.

### B. CHROME CONSOLE KIT FOR DYNA® LOW RIDER® MODELS

Replace the standard black console with a sweep of chrome. Manufactured to Original Equipment specifications, this mirror-chrome dash panel fits like a glove around the stock speedometer and tachometer gauges. Kit includes chrome-plated stainless steel mounting hardware.

**67187-04** Fits '04-'09 FXDL models. **\$159.95**

### C. CHROME-PLATED TRIM PANEL

This hand-polished chrome panel is offered exclusively by Harley-Davidson.

**67221-97** **\$109.95**  
Fits '95-'03 FXD Super Glide®, '99-'03 FXDX, '01-'03 FXDXT, and '94-'00 FXDS-CONV. models.

### D. CHROME INSTRUMENT HOUSING AND FUEL TANK TRIM PANEL

Give the custom look of chrome to the fuel tank on Dyna® Low Rider® models. (Instrument housing and trim panel sold separately.)

#### 1. Instrument Housing

**67189-95** Fits '95-'03 FXDL models. **\$69.95**

#### 2. Chrome Fuel Tank Trim Panel

**61655-91** Fits '91-'03 FXDL models. **\$110.00**

### E. NOSTALGIC FACE SPEEDOMETER

The single numbers and pearl white sweep are the modern interpretation of a classic era speedometer face. This retro style gauge features subtle back lighting for easy night viewing, and an easy-to-read LCD odometer/tripmeter. Original Equipment on the Softail Deluxe, this speedometer mounts in the stock dash opening, and is a direct plug-in replacement. Mileage reinstatement is available through your Dealer.

**67566-05A** MPH. **\$199.95**  
Fits '04-'06 FXDWG and Softail®, '06 FXD35, '07 FXDC, and '04-'06 non-cruise control equipped Road King® models.

### F. SPUN ALUMINUM FACE SPEEDOMETER

Add a touch of luxury and style to your dash. First featured on the '04 Screamin' Eagle® Deuce™ and Electra Glide® motorcycles, these spun aluminum metal-faced gauges offer a rich contrast to a chrome console or black inner fairing surface. The gauges feature subtle Harley-Davidson racing orange back lighting for a unique night-time look. Mileage reinstatement is available through your Dealer.

Fits '04-'06 Dyna® FXDWG, Softail®, and Road King® models, and '06 Dyna FXD35 and '07 FXDC models.

**67313-05A** 5" Speedometer – MPH. **\$199.95**

**67315-05A** 5" Speedometer – KPH. **\$199.95**



**A. CHROME CONSOLE KIT (SHOWN WITH CHROME FLUSH-MOUNT FUEL CAP)**



**B. CHROME CONSOLE KIT FOR DYNA® LOW RIDER® MODELS**



**C. CHROME-PLATED TRIM PANEL (SHOWN WITH CLOISSONNÉ FUEL CAP MEDALLION)**

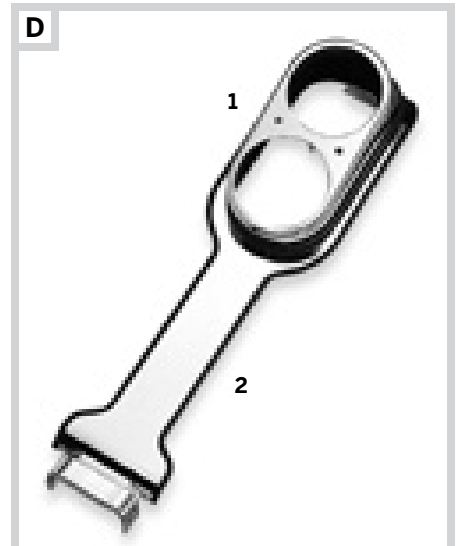

**D. CHROME INSTRUMENT HOUSING AND FUEL TANK TRIM PANEL**



**E. NOSTALGIC FACE SPEEDOMETER**



**F. SPUN ALUMINUM FACE SPEEDOMETER**



**G. 4" COMBINATION SPEEDOMETER/TACHOMETER – COLOR-MATCHED LIGHTING**

**COMBINATION SPEEDOMETER/TACHOMETERS**

Maintain the clean view over the handlebar. This unique Combination Speedometer/Tachometer allows you to monitor engine speed without adding a handlebar-mounted tach. The unit mounts in the stock dash opening and is a direct plug-in installation.

**G. COMBINATION SPEEDOMETER/TACHOMETER – COLOR-MATCHED LIGHTING**

Utilizing the trip reset push-button, the multi-color LED lighting system allows the rider to adjust the backlighting of the gauge to the color of choice. With over 600 color tone options, the gauge lighting can be matched to any paint scheme or viewing preference. The gauge features an easy-to-read LCD odometer/tripmeter. Mileage reinstatement is available through your Dealer.

Fits '09-later Dyna® models with 4" dash or handlebar mount speedometer.

**74735-09 MPH. \$499.95**

Fits '07-'08 Dyna models with 4" dash or handlebar mount speedometer.

**74735-07 MPH. \$499.95**

Fits '09-later Dyna models with 5" dash-mounted speedometer.

**74676-09 MPH. \$499.95**

**74677-09 KPH. \$499.95**

Fits '08 Dyna® models with 5" dash-mounted speedometer.

**74676-08 MPH. \$499.95**

**74677-08 KPH. \$499.95**

Fits '07 Dyna® FXDC, FXDWG, Softail®, and Road King® models.

**74676-07 MPH. \$499.95**

**74677-07 KPH. \$499.95**



**G. COMBINATION SPEEDOMETER/TACHOMETER – COLOR-MATCHED LIGHTING**



**H. COMBINATION SPEEDOMETER/TACHOMETER – NOSTALGIC FACE**

Styled to match the Nostalgic Face gauges. The backlit face aids night viewing, and the gauge features an easy-to-read LCD odometer/tripmeter. '08-later fitments include color-matched adjustable backlighting. Mileage reinstatement is available through your Dealer.

Fits '09-later Dyna models with 5" dash-mounted speedometer.

**74556-09 MPH. \$499.95**

**74557-09 KPH. \$499.95**

Fits '08 Dyna models with 5" dash-mounted speedometer.

**74556-08 MPH. \$499.95**

**74557-08 KPH. \$499.95**

Fits '07 Dyna FXDC, FXDWG, Softail, and Road King models.

**74556-07 MPH. \$449.95**

**74557-07 KPH. \$449.95**

Fits '04-'06 Dyna FXDC, FXDWG, Softail and Road King models.

**74556-04 MPH. \$449.95**

**74557-04 KPH. \$449.95**

**I. COMBINATION SPEEDOMETER/TACHOMETER – SPUN ALUMINUM FACE**

The backlit face aids night viewing and the gauge features an easy-to-read LCD odometer/tripmeter. Mileage reinstatement available through your Dealer.

Fits '09-later Dyna models with 5" dash-mounted speedometer.

**74718-09 MPH. \$499.95**

**74719-09 KPH. \$499.95**

Fits '08 Dyna models with 5" dash-mounted speedometer.

**74718-08 MPH. \$499.95**

**74719-08 KPH. \$499.95**

Fits '07 Dyna FXDC, FXDWG, Softail, and Road King models.

**74718-07 MPH. \$499.95**

**74719-07 KPH. \$499.95**



**H. COMBINATION SPEEDOMETER/TACHOMETER – NOSTALGIC FACE**



**I. COMBINATION SPEEDOMETER/TACHOMETER – SPUN ALUMINUM FACE**

Notice: The prices appearing in this catalog are the manufacturer's suggested retail prices. Actual retail prices may vary.

# 186 DYNA®

## Consoles & Gauges

### A. FLUSH-MOUNT FUEL CAP AND GAUGE KIT\*

Emphasize the long and lean look of the fuel tank. This flush-mount fuel cap and fuel gauge kit offers a pop-up filler design that when installed and sealed looks identical to the flush gauge. A simple push, and the fuel filler cap pops up to provide ample grip, even while wearing gloves. The flush fuel gauge features individual LED lamps that shine through coated glass that glows when the ignition is switched on. A photo-cell automatically adjusts LED brightness for improved visibility in direct sunlight, and dims at night to avoid distraction. Complete kit includes fuel cap, fuel gauge, trim ring, and plug-in wiring harness.

Fits '09-later Dyna® models (except FXD).

<b>62910-09A</b>	Chrome.	<b>\$199.95</b>
<b>75327-09A</b>	Gloss Black.	<b>\$199.95</b>

Fits '04-'08 FXDL, FXDB, FXD35, FXDWG and '07-'08 FXDC and FXDF models.

<b>62910-06A</b>	Chrome.	<b>\$199.95</b>
------------------	---------	-----------------

### LED FUEL GAUGES\*

This low-profile fuel gauge replaces the analog readout with bright LED lamps. The six edge-mounted LED lamps glow blue when the tank is full, and extinguish one by one as fuel is consumed. Plug-in installation without splicing. Available in seven styles to match Original Equipment and accessory fuel caps.

### B. LED FUEL GAUGE – SMOOTH\*

This low-profile fuel gauge matches the profile of the Original Equipment fuel cap.

<b>75242-08</b>	<b>\$139.95</b>
-----------------	-----------------

Fits '08-later Softail, Road King and '09-later Dyna models (except FXD).

<b>75237-03B</b>	<b>\$139.95</b>
------------------	-----------------

Fits '04-'08 FXDB, FXDL, FXD35, FXDF and FXDWG models, '07-'08 FXDC models, '04-'07 Softail models, '01-'03 EFI Softail models (except FXSTDI), '03-'07 Road King models, and '01-'02 EFI Road King models.

### C. LED FUEL GAUGE – BAR & SHIELD LOGO\*

This low-profile fuel gauge matches the Harley-Davidson Bar & Shield logo medallion style of the accessory Self-Locking Fuel Cap.

<b>75051-08</b>	<b>\$139.95</b>
-----------------	-----------------

Fits '08-later Softail, Road King and '09-later Dyna models (except FXD).

<b>75084-04B</b>	<b>\$139.95</b>
------------------	-----------------

Fits '04-'08 FXDB, FXDL, FXD35, FXDF and FXDWG models, '07-'08 FXDC models, '04-'07 Softail® models, '01-'03 EFI Softail models (except FXSTDI), '03-'07 Road King® models, and '01-'02 EFI Road King models.



A. FLUSH-MOUNT FUEL CAP AND GAUGE KIT – CHROME



A. FLUSH-MOUNT FUEL CAP AND GAUGE KIT – GLOSS BLACK



B. LED FUEL GAUGE – SMOOTH  
(FULL READING SHOWN)



C. LED FUEL GAUGE – BAR & SHIELD LOGO

\*Some local regulations prohibit using colored lights during vehicle operation on public streets. May not conform to local lighting regulations.

Notice: The prices appearing in this catalog are the manufacturer's suggested retail prices. Actual retail prices may vary.



NEW

D



**D. LED FUEL GAUGE – DIAMOND BLACK COLLECTION**

E



**E. LED FUEL GAUGE – THE SKULL COLLECTION**

**D. LED FUEL GAUGE – DIAMOND BLACK COLLECTION\***

This matte-black gauge features a machined Bar & Shield logo and knurled edges for a raw look. The design complements the Diamond Black Fuel Cap P/N 62778-10, and is the perfect addition to a “blacked-out” custom ride. Photocell automatically adjusts LED brightness for improved visibility in direct sunlight, and dims at night to avoid distraction.

**75358-10** **\$149.95**  
Fits '08-later Softail®, Road King® and '09-later Dyna models (except FXD).

**75357-10** **\$149.95**  
Fits '04-'08 FXDB, FXDL, FXD35, FXDWG and FXDF models, '07-'08 FXDC models, '04-'07 Softail® models, '01-'03 EFI Softail® models (except FXSTDI), '03-'07 Road King® and '01-'02 EFI Road King® models.

**E. LED FUEL GAUGE – THE SKULL COLLECTION\***

Complements the Skull Collection Billet Fuel Cap P/N 75097-05. Photocell automatically adjusts LED brightness for improved visibility in direct sunlight, and dims at night to avoid distraction.

**75098-08** **\$159.95**  
Fits '08-later Softail, Road King and '09-later Dyna models (except FXD).

**75095-05A** **\$159.95**  
Fits '04-'08 FXDB, FXDL, FXD35, FXDF and FXDWG models, '07-'08 FXDC models, '04-'07 Softail® models, '01-'03 EFI Softail models (except FXSTDI), '03-'07 Road King® models, and '01-'02 EFI Road King models.

**F. LED FUEL GAUGE – FLAMES COLLECTION\***

This cap complements the Flames Collection Billet Fuel Cap P/N 75176-08. Photocell automatically adjusts LED brightness for improved visibility in direct sunlight, and dims at night to avoid distraction.

**75231-08** **\$149.95**  
Fits '08-later Softail, Road King and '09-later Dyna models (except FXD).

**75311-08** **\$149.95**  
Fits '04-'08 FXDB, FXDL, FXD35, FXDWG and FXDF models, '07-'08 FXDC models, '04-'07 Softail® models, '01-'03 EFI Softail models (except FXSTDI), '03-'07 Road King and '01-'02 EFI Road King models.

**G. FUEL CAP – DIAMOND BLACK COLLECTION**

Drift over to the dark side. This matte-black Fuel Cap features a machined Bar & Shield logo and knurled edges for a raw look and easy grip. The design complements the Diamond Black Fuel Gauge, and is the perfect addition to a “blacked-out” custom ride.

**62778-10** **\$49.95**  
Fits '92-later XL and Dyna (except '04-later FXD, FXDX, '05-'06 FXDC and '07 FXDSE), '00-later Softail models, and '94-later Road King models.

**H. FUEL CAP – SKULL COLLECTION**

Add a little attitude to your ride. Styled to complement Harley-Davidson Skull accessory items, the menacing raised skull with black-filled eyes features a rich chrome-plated finish and a styled shape that is easy to grip, even while wearing gloves.

**75097-05** **\$49.95**  
Fits '92-later XL and Dyna® (except '04-later FXD, FXDX, '05-'06 FXDC, FXDSE), '00-later Softail models (except FXSTD, FXSTSSE/2), and '94-later Road King models. Does not fit with Low-Profile Chrome Fuel Tank Console P/N 71208-07.

**I. FUEL CAP – FLAMES COLLECTION**

Set your gas tank apart from the rest. These Fuel Caps feature a rich chrome-plated finish and a styled shape that is easy to grip, even while wearing gloves.

**75176-08** **\$49.95**  
Fits '92-later XL and Dyna (except '04-later FXD, FXDX, '05-'06 FXDC, and '07 FXDSE), '00-later Softail models (except Deuce), and '94-later Road King models.

F



**F. LED FUEL GAUGE – FLAMES COLLECTION**

NEW

G



**G. FUEL CAP – DIAMOND BLACK COLLECTION**

H



**H. FUEL CAP – SKULL COLLECTION**

I



**I. FUEL CAP – FLAMES COLLECTION**

DYNA

\*Some local regulations prohibit using colored lights during vehicle operation on public streets. May not conform to local lighting regulations.

Notice: The prices appearing in this catalog are the manufacturer's suggested retail prices. Actual retail prices may vary.



# 188 DYNA®

Consoles & Gauges

## A. BILLET FUEL CAP

Set your gas tank apart from the rest. These machined Billet Fuel Caps feature a rich chrome-plated finish and a styled shape that is easy to grip, even while wearing gloves.

Fits '92-later XL and Dyna® (except '04-later FXD, FXDX and '05-'06 FXDC and FXDSE), '00-later Softail models and '94-later Road King models. Also fits '99-'00 FXR models.

<b>62816-03</b>	Cross.	<b>\$49.95</b>
<b>62819-03</b>	Six Shooter.	<b>\$49.95</b>

## B. BAR & SHIELD LOGO SELF-LOCKING FUEL CAP

Functional and stylish, these polished, chrome-plated caps feature a convenient self-locking mechanism and a stamped Harley-Davidson Bar & Shield logo on the key hole cover. Maintains the same features as the Original Equipment fuel cap. The kits come complete with two keys.

<b>62803-97A</b>		<b>\$49.95</b>
------------------	--	----------------

Fits '92-later XL and Dyna (except '04-later FXD, FXDX and '05-'06 FXDC and FXDSE), '00-later Softail models and '94-later Road King model. Also fits '99-'00 FXR models.

## C. FUEL CAP MEDALLION – SKULL COLLECTION

Add a little attitude to your ride. Styled to complement Harley-Davidson Skull accessory items, the menacing raised skull with black-filled eyes leaps from a field of chrome. The surrounding "Harley-Davidson Motorcycles" script is the perfect finishing touch. These Fuel Cap Medallions top off the Original Equipment fuel cap, and are self-adhesive for easy installation.

<b>99670-04</b>		<b>\$16.95</b>
-----------------	--	----------------

Fits '83-later models (except '08-later XR, '04-later XL1200L, and XL1200C models, FXD and FXDX and '05-'06 FXDC models, all FXR with plastic fuel cap; Electra Glide®, Road Glide®, Tour Glide™, Trike and VRSC™ models; and all fuel caps with gauges).

<b>99669-04</b>		<b>\$16.95</b>
-----------------	--	----------------

Fits '04-later XL Custom and XL1200L models.

## D. FUEL CAP MEDALLION – NUMBER ONE SKULL COLLECTION

Decorative steel stamping with #1 skull emblem. Contoured to the original Equipment fuel cap. Easy adhesive back installation. (Available September 2009)

Fits '83-later models (except '04-later XL883C, XL1200L and 1200C models, FXD and FXDX models, '05-'06 FXDC, all FXR with plastic fuel cap, Electra Glide, Road Glide, Tour Glide, Trike and VRSC™ models, and all fuel caps with gauges).

<b>99673-10</b>	Chrome.	<b>\$19.95</b>
-----------------	---------	----------------

<b>99688-10</b>	Black.	<b>\$19.95</b>
-----------------	--------	----------------



A. BILLET FUEL CAP – CROSS



A. BILLET FUEL CAP – SIX SHOOTER



B. BAR & SHIELD LOGO SELF-LOCKING FUEL CAP



C. FUEL CAP MEDALLION – SKULL COLLECTION



D. FUEL CAP MEDALLION – NUMBER ONE SKULL COLLECTION

Notice: The prices appearing in this catalog are the manufacturer's suggested retail prices. Actual retail prices may vary.



E

E. CHROME FLUSH-MOUNT FUEL CAP



F

F. CHROME FUEL GAUGE BEZEL COVER



G

G. OIL LEVEL AND TEMPERATURE DIPSTICK WITH LIGHTED LCD READOUT



G

G. OIL LEVEL AND TEMPERATURE DIPSTICK WITH LIGHTED LCD READOUT



H

H. OIL TEMPERATURE DIPSTICK WITH LIGHTED LCD READOUT



I

I. OIL PRESSURE GAUGE KIT

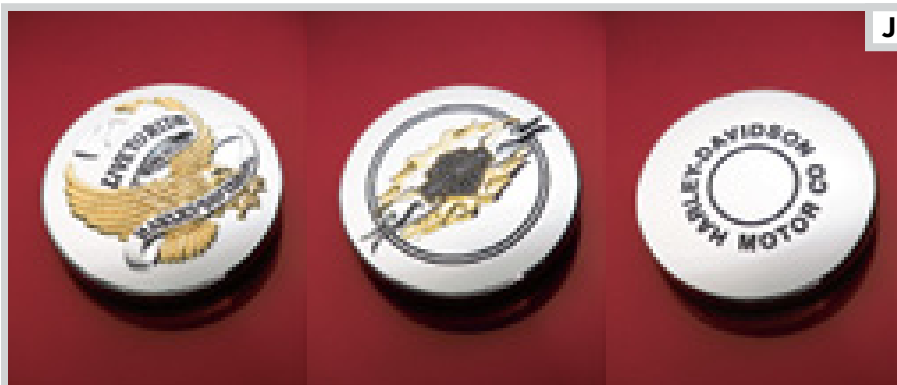

J

J. FUEL CAP MEDALLIONS

**E. CHROME FLUSH-MOUNT FUEL CAP**

This chrome-plated aircraft-style fuel cap adds a bright contrast to the wrinkle black Dyna console, or finishes a complete chrome dash conversion. Replaces the Original Equipment satin-finish flush mount cap on Dyna® Super Glide® and Super Glide® Sport models. Kit includes chrome fuel cap, chrome trim ring and stainless steel mounting hardware.

**61556-04** **\$99.95**  
Fits '04-later FXD, FXDX and '04-'06 FXDC models.

**F. CHROME FUEL GAUGE BEZEL COVER**

This chrome-plated fuel gauge bezel takes just seconds to install adding a bright contrast to the wrinkle black Dyna console, or a finishing touch to a complete chrome dash conversion. Includes adhesive mount for easy installation.

**74544-04A** **\$12.95**  
Fits '04-later FXD, FXDX and '04-'06 FXDC models.

**G. OIL LEVEL AND TEMPERATURE DIPSTICK WITH LIGHTED LCD READOUT**

New and improved "capacitive" level sensing technology provides the highest degree of accuracy and durability. Now available in chrome and black, these dipsticks allow you to check your oil level and oil temperature with the push of a button. Add function and style by replacing your stock dipstick with this hard working version. No more grabbing a rag to pull your hot dipstick. No more oil drips on your pipes and on the garage floor. Simply push the button and this dipstick lights up with a brilliant backlight. Oil level is indicated by a four-segment readout - it even reminds you to check your oil when it is hot. Designed to be waterproof, the LCD display operates on a long-lasting, replaceable Lithium coin-type battery (CR2032 3V, P/N 66373-06). Display features a low battery indicator, and press-and-hold feature to toggle between Fahrenheit and Celsius.

Fits '06-later Dyna® models.  
**62974-09** Chrome. **\$139.95**  
**63065-09** Black. **\$139.95**

**H. OIL TEMPERATURE DIPSTICK WITH LIGHTED LCD READOUT**

Add function and style by replacing your stock dipstick with this hardworking version, which includes a beautiful chrome cap and LCD (liquid crystal display) oil temperature readout. The readout is push button operated with an automatic shut-off in five seconds and operates within plus or minus one degree. Fahrenheit or Celsius can be changed with a simple push button operation. The readout is displayed with a rare blue light background for easier operation at night. Designed to be waterproof with replaceable Lithium battery.

**62938-00E** Fits '99-'05 Dyna models. **\$99.95**

**I. OIL PRESSURE GAUGE KIT**

Check your oil pressure at a glance with this oil-filled Pressure Gauge Kit, specifically designed to look good, fit right, and perform properly on your Twin Cam-equipped motorcycle. The custom mounting brackets have been polished and chrome-plated to rigid Harley-Davidson standards and the gauge offers premium reliability. The kit includes all necessary hardware and mounting brackets for quick and clean installation.

**75133-99** **\$84.95**  
Fits '99-'05 Dyna® models, '00-later Softail® models, and '99-later FLHT and FLHR models. (Does not fit with Chrome Forged Billet Aluminum Rocker Box Covers P/N 17658-03.)

**J. FUEL CAP MEDALLIONS**

Top off your Original Equipment fuel cap. Adhesive backing for easy installation.

Fits '83-later models (except '04-later XL Custom and XL1200L, FXD, and FXDX models, '05-'06 FXDC models, all FXR w/plastic fuel cap, Electra Glide, Tour Glide, Road Glide, VRSC™ and fuel caps with gauges).

**99020-86T** Live To Ride – Chrome. **\$16.95**  
**99020-90T** Live To Ride – Gold. **\$22.95**  
**99686-98** Flames Collection. **\$22.95**  
**99539-97** H-D Motor Co. **\$13.95**

Notice: The prices appearing in this catalog are the manufacturer's suggested retail prices. Actual retail prices may vary.

# 190 DYNA®

Consoles & Gauges

## A. MINI TACH CYLINDRICAL GAUGE HOUSING

Finish your gauge installation in style. Chrome-plated steel housing features a flat bottom and cylindrical shape for a traditional appearance.

**67523-04** **\$59.95**  
Fits models equipped with 2-5/8" Mini Tach and appropriate mounting bracket.

## B. MINI TACH TAPERED GAUGE HOUSING

Housing features a "tapered look" to dress up the Mini Tach for a sleek appearance. Easy replacement for the original Mini Tach gauge housing.

**67524-04** **\$24.95**  
Fits models equipped with 2-5/8" Mini Tach and appropriate mounting bracket.

## C. CHROME BRACKET KITS

### 1. Speedometer/Tachometer

Kit includes chrome dual gauge mounting bracket and chrome speedometer and tachometer backplates.

**67294-95A** **\$104.95**  
Fits '99-'05 FXDX and '01-'03 FXDXT, '95-'04 FXDS-CONV. and '95-later XL1200 models (except XL1200C, XL1200N and XL1200L). Will also fit '95-later XL883, Deluxe and Hugger®, and FXD Super Glide® models that have been upgraded to dual gauges. '04-later FXD models require accessory handlebar clamps and separate purchase of two Screw P/N 3485A and two Spacer P/N 5775.

### 2. Speedometer

Replace the stock wrinkle black components. Kit includes chrome speedometer mounting bracket and backplate.

**67293-95** **\$94.95**  
Fits '95-later XL883 models and '95-'04 FXD Super Glide® models equipped with single gauge. '04-later FXD models require accessory handlebar clamps and separate purchase of two Screw P/N 3485A and two Spacer P/N 5775.

## D. FXD SUPER GLIDE® TACHOMETER ADDITION KIT

Upgrade your FXD Super Glide model to dual instruments. Kit includes an electronic tachometer, mounting bracket, and hardware required for installation. Tachometer graphics complement speedometer for listed years.

**67224-04** **\$285.00**  
Fits '04-'05 FXD/I models. '05 FXD models require accessory handlebar clamps and separate purchase of two Screw P/N 3485A and two Spacer P/N 5775.

**67224-95C** **\$211.00**  
Fits '95-'03 FXD Super Glide models.

## E. INSTRUMENT GAUGE BEZEL

This chrome-plated gauge bezel installs easily to add subtle style to your instruments.

**74541-00** **\$14.95**  
Fits '00-later speedometer and tachometer gauges on Sportster®, Dyna® (except FXDWG), FLHT, and FLTR models. (sold individually)

## F. GAUGE VISOR RING

A touch of chrome makes all the difference. These easy-to-install trim rings feature an integrated eyebrow visor to shield the gauge face from the sun's glare. Self-adhesive backing for secure mount.

**74661-04** **\$24.95**  
Fits '99-'08 FXDWG, '99-'07 Road King® and '99-later Softail® models (except FXSTD, FXCW/C, FLSTFSE and Softail models equipped with Chrome Console P/N 67575-04).

**74662-04** **\$22.95**  
Fits '99-later XL, Dyna® (except FXDWG) and '98-later Road Glide® models.



A. MINI TACH CYLINDRICAL GAUGE HOUSING



B. MINI TACH TAPERED GAUGE HOUSING



C. CHROME BRACKET KITS



D. FXD SUPER GLIDE TACHOMETER ADDITION KIT



E. INSTRUMENT GAUGE BEZEL



F. GAUGE VISOR RING - 4-5/8" GAUGE

Notice: The prices appearing in this catalog are the manufacturer's suggested retail prices. Actual retail prices may vary.



G

**G. 2-5/8" MINI TACH KIT WITH SHIFT LIGHT – BLACK FACE**



G

**G. 2-5/8" MINI TACH KIT WITH SHIFT LIGHT – SPUN ALUMINUM FACE**

**G. 2-5/8" MINI TACH KITS WITH SHIFT LIGHT**

Now available with an attention-grabbing rider-selectable shift light, these chrome-plated, 0-8,000 RPM mini tachometers add style and function. Measuring 2-5/8 inches in diameter, these chrome-plated tachs boast superior illumination and high-quality construction. Complete wiring, hardware, and installation instructions are included. (NOTE: Mini Tach Kits are not compatible with Windshield Bags.)

Fits '96-'03 and '07-later XL Custom, '96-later FXDWG, '06 FXD35, '07-later FXDC, '08-later FXDF, '84-later FX Softail® (except FXCW/C), '86-later FL Softail (except '07-later FLSTF and FLSTFB), and '94-later Road King® models equipped with Mini Tach Mounting Bracket. Separate purchase of application-specific Mounting Brackets and Gauge Housing is required.

<b>69828-06</b>	Spun Aluminum Face.	<b>\$229.95</b>
<b>69829-06</b>	Black Face.	<b>\$229.95</b>

**H. 2-5/8" MINI TACH MOUNTING BRACKET**

Polished and plated to a brilliant shine, this steel bracket is designed to mount a 2-5/8" Mini Gauge at the ideal viewing angle. Designed for specific applications, these brackets are easy-to-install, and do not interfere with hand controls or indicator lights. Gauge installation requires separate purchase of Gauge Housing.

**1. 67268-06B** **\$64.95**  
Fits '06-later FXDWG, '08-later FXDF, '07-later FXSTC and '09-later FLSTC models. Will not fit models equipped with one-piece handlebar with integrated risers, models equipped with Headlamp Nacelle Kit, models equipped with Handlebar Mount Micro Gauges, Road Tech Electronic Compass or Road Tech Radio.

**2. 68150-05** **\$49.95**  
Fits '05-later FLSTN and '08-later FXDB models.

**3. 67206-04** **\$54.95**  
Fits '96-'05 FXDWG, '06-'07 FXDB, '06 FXD35, '07-later FXDC, '86-later FLSTF, '86-'08 FLSTC, '93-'96 FLSTN and '00-later FXSTB models. Will not fit models equipped with one-piece handlebar with integrated risers, models equipped with Headlamp Nacelle Kit, models equipped with Handlebar Mount Micro Gauges, Road Tech Electronic Compass or Road Tech Radio.



H

**H. 2-5/8" MINI TACH MOUNTING BRACKET**

**I. 2-5/8" MINI TACH KIT**

Add style and function with this chrome-plated, 0-8,000 RPM mini tachometer. Measuring 2-5/8 inches in diameter, this chrome-plated tach boasts superior illumination and high-quality construction. Complete wiring, hardware, and installation instructions are included. (NOTE: Mini Tach Kit is not compatible with Windshield Bags.)

Fits '96-'03 and '07-later XL Custom, '96-later FXDWG, '06 FXD35, '07-later FXDC, '08-later FXDF, '84-later FX Softail® (except FXCW/C), '86-later FL Softail (except '07-later FLSTF and FLSTFB), and '94-later Road King® models equipped with Mini Tach Mounting Bracket. Separate purchase of application-specific Mounting Brackets and Gauge Housing is required.

<b>68953-04</b>	Black Face.	<b>\$209.95</b>
-----------------	-------------	-----------------



I

**I. 2-5/8" MINI TACH KIT**



J

**J. CHROME BILLET MINI TACH MOUNT AND HANDLEBAR CLAMP**

**J. CHROME BILLET MINI TACH MOUNT AND HANDLEBAR CLAMP**

Precision-machined chrome-plated aircraft quality aluminum Mini Tach Mount incorporates a "ball-milled" handlebar clamp to add a custom touch to your Softail® or Dyna® Wide Glide® model. Add the appropriate 2-5/8" Mini Gauge and gauge housing (sold separately) to complete the custom look.

**68960-98A** **\$159.95**  
Fits '93-'05 FXDWG, '86-'06 FLSTF, and '86-later FLST, '86-'08 FLSTC, FLSTN and '99-later FXSTB models with Mini Tach. Does not fit FXDWG models equipped with windshields or FL Softail models with Chrome Headlamp Nacelle. (Does not work with Windshield P/Ns 91820-85A, 57965-97A or '00-later FLSTC models equipped with stock detachable windshield.) '99-earlier FLSTC models require Windshield Bracket Kit P/N 58155-90 for stock windshield to fit.

Notice: The prices appearing in this catalog are the manufacturer's suggested retail prices. Actual retail prices may vary.





# SOFTAIL®

*As a modern execution of the classic hardtail look, style plays a big role in the Softail family. But this bike does have a practical side. Whether you're tall or short, these motorcycles can be tailored to fit you like a glove. Look at your ride as a whole, and bring your custom vision to life.*

*For the complete list of Genuine Motor Accessories that appear on these motorcycles or any other Softail motorcycles shown, visit: [www.harley-davidson.com/gallery](http://www.harley-davidson.com/gallery).*

LEFT FLSTF Fat Boy® Color Shop - Raze  
 RIGHT FLSTN Softail® Deluxe Color Shop - Punishment  
 LOCATION THE JAIL HOUSE, JACKSON, WI  
 GPS N 43° 21.090' - W 88° 04.921'



## ONLY YOU CAN DECIDE HOW YOU RIDE.

*Fit and function are the bare essentials of customizing. If you do nothing else to your motorcycle, make sure your bike fits your body properly and accommodates the type of riding you plan to do.*

*Having the right accessories makes all the difference in the comfort and control you feel on the road. Take the time to learn how your Softail® model can be personalized so you can get the most out of your riding experience.*



### FINDING YOUR FIT AND FUNCTION

To make your Softail® motorcycle fit you like a well-worn pair of jeans, your inspiration is only a few pages away. The page numbers listed at the right will help you quickly navigate to the section of the Catalog that most interests you. Turn the pages, and mark your trail with bent-over corners and scribbled notes in the margins. Customizing is a journey...travel well.

*For the complete list of Genuine Motor Accessories that appear on this motorcycle visit: [www.harley-davidson.com/gallery](http://www.harley-davidson.com/gallery).*

### STOPPING BY THE FIT SHOP



#### A. SEATS

*Where the seat positions your waist relative to the foot controls, hand controls and the ground will impact your riding comfort, so test-sit a variety of seats to get it right.*

#### B. FOOT CONTROLS

*Where your feet meet the controls is equal parts riding style and physical necessity; it also determines the angle of your hip, knee and ankle, so keep it comfortable.*

#### C. HANDLEBAR & CONTROLS

*Each bar has a unique combination of rise, width and pullback—putting your hands, wrists, arms and shoulders in different configurations. See what feels natural and stick with it.*

#### D. RIDE HEIGHT

*Suspension components and seat shape combine to determine your riding position. Finding the right combination is the easiest way for a shorter rider to fit comfortably on a larger bike.*

### GEARING UP WITH RIDER ESSENTIALS

Selecting even the basic accessories can be daunting. Start by adding versatility and long-haul comfort. These windshields, backrests and luggage racks are designed to fit your specific Softail® model and will get you ready for the open road.

#### FOR '05–LATER FLSTN

Detachable Nostalgic Windshield	57140-05
Engine Guard	49004-00A
Detachable One-Piece Sissy Bar Upright	53618-05
Passenger Backrest Pad	51587-05

#### FOR '06–LATER FXST & FXSTB

Quick-Release Windshield	59802-05
Wrinkle Black Luggage Rack	53965-06
Low Backrest Pad	52612-95
Wrinkle Black Low Upright	53407-06
Wrinkle Black Detachable Sissy Bar Sideplates	53857-00A
Rear Directional Relocation Kit	53959-06

#### FOR '07–LATER FLSTF

Detachable Nostalgic Windshield	57140-05
Sissy Bar Upright	51477-06
Chrome Detachable Sissy Bar Sideplates	53810-00A
Passenger Backrest Pad	51622-07
Rear Directional Relocation Kit	53959-06

# SOFTAIL® STYLE

## SHOW OFF THE STYLE YOU WERE BORN WITH.

*This is where your ride becomes a true individual. Where leather and steel become a reflection of your passion, commitment and character. Think about styling your bike as a whole, and what look you are after. Even though your style and taste may change over time, there's only one opinion that matters here, and that's yours.*

### FINDING YOUR STYLE

This Catalog is packed with options that will let you establish your own sense of style. Flip through for inspiration, or use the page numbers below to help you quickly navigate to the pages that cover the areas you would like to customize.



GPS & AUDIO  
PG 616

CUSTOM SEAT PROGRAM  
PG 706

SECURITY & STORAGE  
PG 748

CLEANING & MAINTENANCE  
PG 760

LUGGAGE  
PG 691

### DEFINING YOUR STYLE

The possibilities are endless, so it pays to have an overall plan. Think through your customizing efforts to manage installation costs and minimize your time off the road.

#### A. FRONT & REAR END

*The front forks and rear swingarm are some of the most striking elements on your motorcycle. Custom sliders, axle covers and hardware maximize the visual impression.*

#### B. PAINT

*Your bike's paint sets the tone for the rest of your ride. From the classic and understated to the modern and brash, we have the options to help you find exactly what you want.*

#### C. CUSTOM DETAILS

*Your bike really comes alive in the details. Chrome, stylized or black components will help set your bike apart from the crowd and pull your vision together.*

#### D. WHEELS

*Your wheels, sprocket and rotors take up a lot of visual real estate and are a great way to complement or instantly overhaul the look of your ride.*

# WHAT'S HOT

*We're always pushing our design teams to come up with new, innovative, functional and stylish components to reflect your personal needs. Take a minute to see what we've cooked up, and you'll find the right additions to help you accelerate your riding experience.*

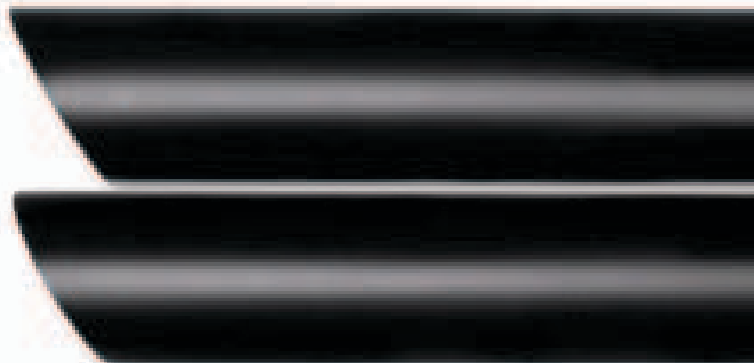

STINGER  
CUSTOM WHEEL  
PG : 671



SCREAMIN' EAGLE® MUFFLERS  
PG 485



PG : 624  
BOOM! AUDIO™  
HALF-HELMET  
MUSIC HEADSET

DARK CUSTOM™ LOGO  
COLLECTION  
PG : 517

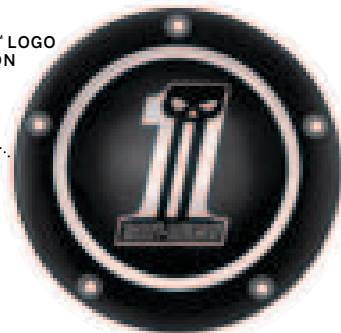

SCREAMIN' EAGLE®  
"VENTILATOR"  
PERFORMANCE  
AIR CLEANER  
PG : 473



PG : 706  
CUSTOM SEAT



ROAD TECH™ ZUMO® 660 GPS NAVIGATOR  
PG 617

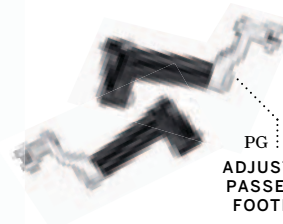

PG : 303  
ADJUSTABLE  
PASSENGER  
FOOTPEGS



GLOSS BLACK  
FORK COVER  
PG : 268



OIL TEMPERATURE DIPSTICK  
WITH LIGHTED LED READOUT  
PG 537



**FXCWC**  
**SOFTAIL® ROCKER™ C**

Production Color: *Vivid Black*

**About This Bike** The perfect balance of hot and cold. Sky-high ape hangers are the ultimate in cool, and the warmed-over Twin Cam motor features a Screamin' Eagle® performance free-flowing intake and exhaust.

**ACCESSORIES FOR FIT**

**HANDLEBAR**

Fat Mini Ape Handlebar .....	56832-04
Fat Bar Riser Kit .....	56916-07

**ACCESSORIES FOR STYLE**

**WHEELS & ROTORS**

Teardrop Brake Rotor – <i>Front</i> .....	44367-00
Teardrop Brake Rotor – <i>Rear</i> .....	44368-00
ThunderStar Sprocket .....	40126-07

**LIGHTING**

Bullet Headlamp Kit – 5¼" .....	68593-06
Bullet Headlamp Mount – <i>Short</i> .....	68595-06
Smoked Turn Signal Lenses – <i>Front</i> .....	69208-09

**FRONT END**

Brake Disc Hardware – <i>Front, Chrome</i> .....	46646-05
Caliper Inserts – <i>Chrome (2)</i> .....	44477-99
Front Turn Signal Mount – <i>Chrome</i> .....	68266-03

**HAND CONTROLS & GAUGES**

Hand Grips – <i>Narrow Band</i> .....	56443-00A
Hand Levers – <i>Chrome</i> .....	45075-08
Clutch and Master Cylinder Kit – <i>Chrome</i> .....	45355-08
Switch Housing Kit – <i>Chrome</i> .....	70222-96B
Switch Cap Kit – <i>Chrome</i> .....	71804-03
Dome Billet Mirrors – <i>Chrome</i> .....	91519-99

**ENGINE & CHASSIS TRIM**

Headbolt Bridge – <i>Finned Black</i> .....	43859-00
Timer Cover – <i>Chrome</i> .....	32679-99A

**FOOT CONTROLS**

Billet Brake Lever – <i>Chrome</i> .....	42632-07
Billet Shift Lever – <i>Chrome</i> .....	34539-00
Brake Pedal Pad – <i>Narrow Band</i> .....	42629-00
Footpegs – <i>Passenger, Narrow Band</i> .....	50978-99
Shifter Peg – <i>Narrow Band</i> .....	49254-99
Shift Linkage – <i>Hex</i> .....	33819-98A

**REAR END**

Rear Axle Cover – <i>Chrome</i> .....	44345-09
Contoured Frame Inserts – <i>Chrome</i> .....	48212-08
Wheel Spacer – <i>Rear, Chrome</i> .....	41378-08
Brake Disc Hardware – <i>Rear, Chrome</i> .....	46647-05
Sprocket Hardware – <i>Chrome Socket</i> .....	43245-07

**SCREAMIN' EAGLE® PERFORMANCE**

<b>NEW</b> Ventilator Performance Air Cleaner – <i>Chrome</i> .....	28721-10
<b>NEW</b> Street Performance Mufflers – <i>Black</i> .....	80813-10
<b>NEW</b> Exhaust Shields – <i>Black</i> .....	80818-10

For the complete list of Genuine Motor Accessories that appear on this motorcycle visit: [www.harley-davidson.com/gallery](http://www.harley-davidson.com/gallery).

LOCATION HARRY'S RESTAURANT, PORT WASHINGTON, WI  
 GPS N 43° 23.313' – W 87° 52.141'







**FXSTC  
SOFTAIL® CUSTOM**

Color Shop Custom Paint: *Limited Series – Burn*

*About These Bikes* Black it out or dip it in chrome, the Softail Custom model allows you to stretch your imagination. Either way, you get a ride that is the last word in personal expression.

**COLOR SHOP CUSTOM PAINT**

**NEW** Limited Series Paint – *Burn*..... 95703-10DDF

**ACCESSORIES FOR FIT**

Sidekick® Seat – *Custom* ..... 52193-08  
 Profile® Low Rear Suspension ..... 54652-05  
 Street Slammer Handlebar ..... 55975-08A

**ACCESSORIES FOR FUNCTION**

**NEW** Whiskers Highway Bar – *Black* ..... 50865-09

**ACCESSORIES FOR STYLE**

**WHEELS & ROTORS**  
**NEW** Typhoon Cut Back Wheel – *21" Front* ..... 40141-10  
**NEW** Typhoon Cut Back Wheel – *17" Rear* ..... 40156-10

**FRONT & REAR END**

Inverted Fork Kit – *Gloss Black* ..... 48646-06A  
 Bullet Headlamp Shell – *4½"* ..... 69851-06

**HAND & FOOT CONTROLS**

Dome Billet Mirrors – *Black* ..... 92423-08  
 Hand Levers – *Flame, Black* ..... 42535-08  
 Hand Grips – *Diamond Black* ..... 56405-08  
 Brake Lever – *Satin Black, Billet* ..... 41805-08  
 Shift Lever – *Satin Black, Billet* ..... 34016-08  
 Brake Pedal Pad – *Diamond Black* ..... 41850-08  
 Footpegs – *Diamond Black (2)* ..... 50911-08

**ENGINE & CHASSIS TRIM**

Billet Air Cleaner Cover – *Black Anodized* ..... 29506-09  
 Billet Air Cleaner Medallion – *Dark Custom* ..... 29902-09

**SCREAMIN' EAGLE® PERFORMANCE**

**NEW** Street Performance Mufflers – *Black* ..... 80813-10  
**NEW** Exhaust Shield Kit – *Black* ..... 80824-10

**FXSTC  
SOFTAIL® CUSTOM**

Color Shop Custom Paint: *Core Series – Edge Flame*

**COLOR SHOP CUSTOM PAINT**

Core Series Paint –  
*Edge Flame – Red Base w/ Black Flames* ..... 95703-08CMC

**ACCESSORIES FOR FIT**

Sidekick® Seat – *Custom* ..... 52193-08  
 Profile® Low Rear Suspension ..... 54651-05  
 Extended Reach Forward Controls – *Chrome* ..... 49171-08  
 Street Slammer Bar ..... 55975-08A

**ACCESSORIES FOR FUNCTION**

Bobtail Fender Rack – *Black* ..... 59931-08

**ACCESSORIES FOR STYLE**

**WHEELS & ROTORS**  
**NEW** Magnum 5 Chrome Wheel – *21" Front* ..... 40806-09  
**NEW** Magnum 5 Chrome Wheel – *17" Rear* ..... 40803-09  
**NEW** Magnum 5 Sprocket Cover – *Chrome* ..... 40121-09

**FRONT & REAR END**

Inverted Fork Kit – *Chrome* ..... 46321-05B  
 Swingarm – *Chrome* ..... 48607-08  
 Rear Axle Covers – *Chrome* ..... 43132-08  
 Pivot Bolt Covers – *Chrome* ..... 47612-08  
 Bullet Headlamp – *4½"* ..... 69851-06  
 Mini LED Turn Signals – *Smoked* ..... 69475-07

**HAND & FOOT CONTROLS**

Clutch and Master Cylinder Kit – *Chrome* ..... 45355-08  
 Switch Housing – *Chrome* ..... 70222-96B  
 Hand Levers – *Chrome* ..... 45075-08  
 Hand Grips – *Aileron* ..... 56425-02  
 Footpegs – *Aileron (2)* ..... 50305-02

**SCREAMIN' EAGLE® PERFORMANCE**

Heavy Breather Air Cleaner – *Chrome* ..... 29299-08  
 Street Performance Mufflers – *Slash Down* ..... 80495-07

*For the complete list of Genuine Motor Accessories that appear on these motorcycles visit: [www.harley-davidson.com/gallery](http://www.harley-davidson.com/gallery).*

LOCATION TELLO'S RESTAURANT, PORT WASHINGTON, WI  
 GPS N 43° 23.242' – W 87° 52.344'



**FLSTFB**  
**FAT BOY® LO**

Production Color: *Black Denim*

**About This Bike** Black as night. With its low front suspension and blacked-out forks, controls and Screamin' Eagle® exhaust, this bike is equipped for a ground-hugging look.

**COLOR SHOP CUSTOM PAINT**

Bullet Spoiler – *Primed (Custom Painted)* ..... 57039-08BDK

**ACCESSORIES FOR FIT**

Sidekick® Seat – *Custom* ..... 52193-08

Profile® Low Front Suspension ..... 54758-07

**NEW** Street Slammer Handlebar – *Black* ..... 55985-10

**ACCESSORIES FOR STYLE**

**WHEELS & ROTORS**

Classic Black Brake Rotor – *Front* ..... 46778-09

Classic Black Brake Rotor – *Rear* ..... 46777-09

**FRONT & REAR END**

**NEW** Fork Sliders – *Black* ..... 48645-09

Upper Fork Slider Covers – *Black* ..... 45591-02

Front Axle Nut Covers – *Black* ..... 43428-09

Front Wheel Spacers – *Chrome* ..... 41583-07

Rear Axle Nut Cover – *Black* ..... 43422-09

Pivot Bolt Covers – *Black* ..... 47649-09

Sprocket Hardware – *Chrome Socket* ..... 43245-07

Rear Axle Adjuster Hardware – *Chrome* ..... 41202-08

Rear Wheel Spacer Kit – *Chrome* ..... 41221-08

Layback License Plate ..... 60280-07

Smoked Turn Signal Lenses – *Front* ..... 69304-02

LED Tail Lamp – *Smoked & Black* ..... 68086-08

**HAND & FOOT CONTROLS**

Hand Grips – *Tribal* ..... 56254-09

Mirrors – *Tribal, Black* ..... 92398-09

Hand Levers – *Black* ..... 44994-08

Brake Pedal Pad – *Tribal* ..... 42560-09

Footpegs – *Tribal* ..... 51376-09

Shifter Peg – *Tribal (2)* ..... 34669-09A

Billet Brake Lever – *Black* ..... 41800-08

Billet Heel/Toe Shift Lever – *Black* ..... 34023-08

Gear Shift Linkage – *Slotted Black Anodized* ..... 34018-08

**GAUGES & ENGINE TRIM**

Flush Mount Fuel Cap and Gauge – *Black* ..... 75014-08A

**NEW** Oil Level & Temp Dipstick – *Black* ..... 62955-09

Derby Cover – *Black Fin* ..... 25454-01

Timer Cover – *Black Fin* ..... 32677-01

**SCREAMIN' EAGLE® PERFORMANCE**

**NEW** Ventilator Air Cleaner – *Black* ..... 28722-10

**NEW** Street Performance Mufflers – *Black* ..... 80621-10

**NEW** Exhaust Shields – *Black* ..... 80817-10

For the complete list of Genuine Motor Accessories that appear on this motorcycle visit: [www.harley-davidson.com/gallery](http://www.harley-davidson.com/gallery).

LOCATION ..... MILWAUKEE, WI

GPS ..... N 43° 01.447' – W 87° 55.608'







**FLSTSB**  
**SOFTAIL® CROSS BONES™**  
 Color Shop Custom Paint: *Spectrum Program – Olive*

**About These Bikes** Nothing beats the old school. Taking design cues from the past, these bikes dish up some dark twists that deliver a wickedly fun riding experience.

COLOR SHOP CUSTOM PAINT	
Spectrum Paint Set – <i>Olive</i>	98300A

**ACCESSORIES FOR FIT & FUNCTION**

Leather Solo Saddle	52004-25
Narrow Beach Bar – <i>Black</i>	56940-09
Detachable Solo Rack – <i>Black</i>	53612-08

**ACCESSORIES FOR STYLE**

FRONT & REAR END	
Front Axle Nut Covers – <i>Black</i>	41088-09
Rear Axle Cover – <i>Black</i>	43422-09
Pivot Bolt Cover – <i>Black</i>	47649-09

**HAND & FOOT CONTROLS**

Dome Billet Mirror – <i>Black</i>	92423-08
Hand Levers – <i>Black</i>	44994-08
Hand Grips – <i>Nostalgic</i>	56275-96B
Billet Brake Lever – <i>Black</i>	41800-08
Billet Shift Lever – <i>Black</i>	34023-08

**LIGHTING & HORN**

Auxiliary Lighting Kit	69286-05A
Bar & Shield Logo Lamp Covers	67593-05
Springer Chrome Horn Kit	69036-88A

**ENGINE & CHASSIS TRIM**

Derby Cover – <i>Black Fin</i>	25454-01
Timer Cover – <i>Black Fin</i>	32677-01
Rocker Covers – <i>Wrinkle Black (2)</i>	17620-99
Cam Cover – <i>Wrinkle Black</i>	25364-01B
Clutch Cover – <i>Wrinkle Black</i>	37135-06
Primary Cover – <i>Wrinkle Black</i>	60717-07

**SCREAMIN' EAGLE® PERFORMANCE**

<b>NEW</b> Street Performance Mufflers – <i>Black</i>	80781-10
<b>NEW</b> Exhaust Shield Kit – <i>Black</i>	80829-10

**FLSTN**  
**SOFTAIL® DELUXE**  
 Color Shop Custom Paint: *Limited Series – Chance*

COLOR SHOP CUSTOM PAINT	
<b>NEW</b> Limited Series Paint Set – <i>Chance</i>	95726-10DDD

ACCESSORIES FOR FIT	
Profile® Low Front Suspension	54758-07

ACCESSORIES FOR FUNCTION	
Rear Docking Hardware	53932-03
Leather Tank Panel with Pouch	91758-07

**ACCESSORIES FOR STYLE**

LIGHTING	
Headlamp Trim Ring	69626-99
Bullet Turn Signal Kit – <i>Front</i>	68005-99
Turn Signal Mount Kit – <i>Chrome</i>	68266-03

FRONT & REAR END	
<b>NEW</b> Fork Sliders – <i>Black</i>	48645-09
Upper Fork Slider Covers – <i>Black</i>	45591-02
<b>NEW</b> Triple Tree Cover Kit – <i>Black</i>	48608-09
Front Axle Nut Covers – <i>Black</i>	43428-09
Rear Axle Nut Covers – <i>Black</i>	43422-09
Pivot Bolt Covers – <i>Black</i>	47649-09

HAND & FOOT CONTROLS	
Hand Grips – <i>Nostalgic</i>	56275-96B
Hand Levers – <i>Black</i>	44994-08

Dome Billet Style Mirrors – <i>Black</i>	92423-08
Shifter Pegs – <i>Crested Bar &amp; Shield (2)</i>	33946-05
Brake Pad – <i>Crested Bar &amp; Shield</i>	42700-05

**SCREAMIN' EAGLE® PERFORMANCE**

Stage I Air Cleaner Kit	29440-99D
Round Air Cleaner Cover – <i>Vivid Black</i>	29400-08
<b>NEW</b> Street Performance Mufflers – <i>Black</i>	80781-10
<b>NEW</b> Exhaust Shield Kit – <i>Black</i>	80829-10

For the complete list of Genuine Motor Accessories that appear on these motorcycles visit: [www.harley-davidson.com/gallery](http://www.harley-davidson.com/gallery).

LOCATION	LEON'S FROZEN CUSTARD DRIVE-IN, MILWAUKEE, WI
GPS	N 42° 59.158' – W 87° 56.546'



FLSTC  
**HERITAGE SOFTAIL®  
 CLASSIC**

Production Color: *Flame Blue Pearl / Brilliant Silver*

**About This Bike** This Heritage Softail Classic is dressed for life on the open road, but with a quick turn of the detachable hardware, the windshield and Tour-Pak® luggage can be removed for a slow cruise around town.

**ACCESSORIES FOR FIT**

Profile® Low Front Suspension.....	54758-07
Signature Series™ Seat.....	51922-09
Profile Low Rear Suspension.....	54652-05

**ACCESSORIES FOR FUNCTION**

Passenger Grab Rail.....	97031-09
Chrome Center Stand.....	98959-08
Detachable Docking Hardware Kit.....	53931-03
Detachable Two-Up Tour-Pak® Mounting Rack.....	53066-00C
Leather Tour-Pak® – <i>Heritage Style</i> .....	53209-09

**ACCESSORIES FOR STYLE**

**WHEELS & ROTORS**

Polished Brake Rotor – <i>Front</i> .....	41830-05
Polished Brake Rotors – <i>Rear</i> .....	41832-05

**FRONT END**

Chrome Front End Package.....	46536-07B
Caliper Inserts – <i>Chrome (2)</i> .....	44477-99

**LIGHTING**

Visor Trim Ring – <i>Headlamp</i> .....	69734-05
Visor Trim Ring – <i>Front Turn Signal</i> .....	69749-05
Visor Trim Ring – <i>Passing Lamp</i> .....	69732-05
LED Tail Lamp – <i>Chrome &amp; Red</i> .....	68085-08

**HAND CONTROLS**

Hand Grips – <i>Nostalgic</i> .....	56275-96B
Switch Housing – <i>Chrome</i> .....	70222-96B
Clutch and Master Cylinder Kit – <i>Chrome</i> .....	45355-08
Hand Levers – <i>Chrome</i> .....	45075-08

**ENGINE & CHASSIS TRIM**

Timer Cover – <i>Chrome</i> .....	32679-99A
Harley-Davidson Air Cleaner Cover.....	29754-01
<b>NEW</b> Chrome Inner Primary Trim.....	60868-10
Engine/Transmission Interface Cover.....	66543-08
Chrome Headbolt Bridge.....	43858-00

**FOOT CONTROLS**

Rider Footboard Inserts – <i>Nostalgic</i> .....	50051-09
Shifter Pegs – <i>Nostalgic (2)</i> .....	34627-99
Brake Pedal Pad – <i>Nostalgic</i> .....	44248-96
Folding Heel Shifter.....	33876-07
Polished Shift Linkage – <i>Round</i> .....	33814-98A

**REAR END**

Sprocket Hardware – <i>Chrome</i> .....	94773-07
Sprocket Cover – <i>Chrome</i> .....	37757-07

For the complete list of Genuine Motor Accessories that appear on this motorcycle visit: [www.harley-davidson.com/gallery](http://www.harley-davidson.com/gallery).

LOCATION HWY 106, PALMYRA, WI  
 GPS N 42° 54.381' – W 88° 37.809'



# SOFTAIL® WINDSHIELDS

## SPLIT THE WIND

*At highway speed, you take the wind full-force in the chest, causing fatigue in your arms, neck and shoulders. Take the pressure off with an easy-to-install detachable windshield. Shaped to divert air, rain and road debris around the rider, a windshield can add hours of riding comfort.*

### SOFTAIL WINDSHIELD TYPES



#### SUPER SPORT WINDSHIELD

*Low and lean shape gives your bike a sleek and athletic appearance. Minimal coverage, but sometimes that's all you need to extend your ride into the next straightaway.*



#### COMPACT & KING WINDSHIELDS

*Standard issue windshield for any ride. The full coverage shape takes on everything the road throws at it while maintaining a clean and strictly business look.*



#### THE SELECTION GUIDE

*For maximum wind protection, and the best view down the road, select a windshield that tops out just below your line of sight. Your dealer has the tools to make the selection simple.*

### CHANGING YOUR WINDSHIELD



Designed to be installed or removed without tools in seconds, a Detachable Windshield gives you the freedom to define your ride at the drop of a hat. Ride across the country protected from the elements, then quickly remove the windshield to hit the streets in style.

- A. STANDARD DETACH HARDWARE
- B. QUICK-DETACH HARDWARE

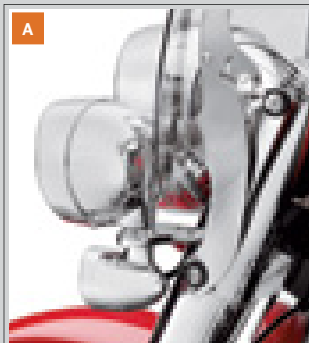



A. DETACHABLE SUPER SPORT WINDSHIELD



B. QUICK-RELEASE SUPER SPORT WINDSHIELD – INVERTED FORKS

**WINDSHIELDS**

Whether it's for keeping bugs off your face or warmth in your body, a windshield has a huge impact on rider and passenger comfort. By diverting air pressure past your chest and over your helmet, a windshield can add hours of riding comfort. For maximum protection from wind and weather, select a windshield that tops out just below your line of sight. You avoid looking through rain drops, bug spots and road grime to get a clear view of the highway ahead.

**A. DETACHABLE SUPER SPORT WINDSHIELD**

Super is an apt description for this do-it-all shield. Detachable convenience. Harley-Davidson sport styling. High-quality, lightly smoked Lexan® polycarbonate that shields you from the elements. The windshield mounts to the fork tubes with Detachable Docking Hardware (*sold separately*) for easy on-and-off convenience and a quick return to a sporting profile.

**57965-97A** 18" Lightly Smoked. **\$219.95**  
Fits '84-later FXST, FXSTC, FXSTB, '93-'05 FXDWG, '80-'86 FXWG. (Does not fit FXSTD.) Use Docking Hardware Kit P/N 58350-96. Windshield dimensions: Overall height – 22.3"; width – 17.8".

**57969-97A** 13" Lightly Smoked. **\$219.95**  
Fits '93-later FXSTS, FXSTSB, FXSTSSE models. Use Docking Hardware Kit P/N 58350-96. Will not fit with Chrome Billet Mini Tach Mounts. Windshield dimensions: Overall height – 22.8"; width – 17.7".

**57837-00A** 18" Lightly Smoked. **\$249.95**  
Fits '00-'07 FXSTD models (except FXSTDSE). Installation requires the separate purchase of Docking Hardware Kit P/N 58397-00. Windshield dimensions: Overall height – 22.9"; width – 18.3".

**DOCKING HARDWARE FOR DETACHABLE WINDSHIELDS** (*not shown*)

**58907-96B** For Springer® Forks **\$69.95**  
Required for installation of Detachable Windshields on '93-later FXSTS, FXSTSSE, FXSTSB, '97-later FLSTS, FLSTSB and FLSTSC models.

**58350-96** For 41mm Forks **\$69.95**  
Required for installation of Detachable Windshields on '84-later FXST, FXSTC, FXSTB, '93-'05 FXDWG, '80-'86 FXWG models. (Does not fit FXSTD.)

**58397-00** For Softail® Deuce™ **\$69.95**  
Required for installation of Detachable Windshields on '00-'07 FXSTD models (except FXSTDSE).

**B. QUICK-RELEASE SUPER SPORT WINDSHIELD**

Reduces the pounding wind and shower of bugs, but keeps the wind-in-the-hair feeling. Ideal for a cool morning ride, the sleek profile of the Super Sport Windshield hugs the front headlamp for a sporty look. The windshield mounts to the fork tubes with elegant die-cast lever-locking clamps, so the windshield does not require any "leave-behind" docking hardware. You get quick on-and-off convenience and a clean, custom look. No tools are required, and the kit includes everything needed to install the windshield.

Fits '07-'08 FXDSE and '00-later FXST, FXSTB and FXSTC models equipped with Custom Inverted Front Fork Kit P/N 46321-05, 46321-05A or 48646-06.

**57331-07** 16" Lightly Smoked. **\$349.95**  
Windshield dimensions: Overall height – 22.1"; width – 15.3".

# 210 SOFTAIL®

Windshields – FX Softail

## A. QUICK-RELEASE SUPER SPORT WINDSHIELD – ROCKER™ MODELS

Reduces the pounding wind and shower of bugs, but keeps the wind-in-the-hair feeling. Ideal for a cool morning ride, the sleek profile of the Super Sport Windshield hugs the front headlamp for a sporty look. The windshield mounts to the fork tubes with elegant die-cast lever-locking clamps, so the windshield does not require any “leave-behind” docking hardware. You get quick on-and-off convenience and a clean, custom look. No tools are required, and the kit includes everything needed to install the windshield.

Fits '08-later FXCW and FXCWC models.

**57251-08** 20" Clear. **\$369.95**  
Windshield dimensions: Overall height – 24.2"; width – 16.8".

**57253-08** 16" Lightly Smoked. **\$369.95**  
Windshield dimensions: Overall height – 20.2"; width – 15.2".

## B. SPORT WINDSHIELD KIT

Formed of Lexan® polycarbonate and hard-coated to resist scratching. Lightly smoked windshield is contoured to fit headlamp and incorporates adjustable four-point mounting. Functional styling helps deflect wind to reduce upper body fatigue.

**91820-85A** 17" Lightly Smoked. **\$164.95**  
Fits '84-later FXST, FXSTB, FXSTC, and '93-'05 FXDWG and '86-earlier FXWG models. Windshield dimensions: Overall height – 20"; width – 15".



A. QUICK-RELEASE SUPER SPORT WINDSHIELD FOR ROCKER MODELS – 16" LIGHTLY SMOKED



A. QUICK-RELEASE SUPER SPORT WINDSHIELD FOR ROCKER MODELS – 20" CLEAR



B. SPORT WINDSHIELD KIT

Notice: The prices appearing in this catalog are the manufacturer's suggested retail prices. Actual retail prices may vary.





C. QUICK-RELEASE COMPACT WINDSHIELD – 19" CLEAR

**C. QUICK-RELEASE COMPACT WINDSHIELD**

Combine the classic Harley-Davidson® windshield shape with a revolutionary new attachment system, and you have the best of style and function. The windshield mounts to the fork tubes with elegant die-cast lever-release clamps, so the windshield does not require any "leave-behind" docking hardware. You get quick on-and-off convenience, and a clean, custom look. No tools are required, and the kit includes everything needed to install the windshield. The tough, hard-coated polycarbonate windshield features traditional chrome horizontal and vertical braces.

Fits '93-'05 FXDWG and '86-later FXST, FXSTC and FXSTB models.

**59802-05** 19" Clear. **\$414.95**  
Windshield dimensions: Overall height – 23.8"; width – 21.4".

**58751-05** 19" Lightly Smoked. **\$434.95**  
Windshield dimensions: Overall height – 23.8"; width – 21.4".

**57199-05** 16" Lightly Smoked. **\$424.95**  
Windshield dimensions: Overall height – 20.8"; width – 21.4".

Fits '00-'07 FXSTD models (except FXSTDSE).

**57160-05** 19" Lightly Smoked. **\$444.95**  
Windshield dimensions: Overall height – 26.3"; width – 19.5".

**58779-05** 19" Clear. **\$434.95**  
Windshield dimensions: Overall height – 26.3"; width – 19.5".

**Shown with:****TURN SIGNAL RELOCATION KIT**

Styled to blend with the lower triple clamp. This chrome-plated Turn Signal Relocation Kit moves the Original Equipment bullet-style turn signals from the handlebar to the front fork for a clean, streamlined look. Kit includes left and right mounting stalk and all required hardware.

**58742-05** **\$44.95**  
Fits '93-'05 FXDWG, '86-later FXST, FXSTC, FXSTB, and '00-'07 FXSTD models.



C. QUICK-RELEASE COMPACT WINDSHIELD – 16" LIGHTLY SMOKED



C. QUICK-RELEASE COMPACT WINDSHIELD FOR SOFTAIL DEUCE – 19" CLEAR

## 212 SOFTAIL®

Windshields – FX Softail

### A. QUICK-RELEASE COMPACT WINDSHIELD – GLOSS BLACK

Combine the classic Harley-Davidson® windshield shape with a revolutionary new attachment system, and you have the best of style and function. The windshield mounts to the fork tubes with elegant die-cast lever-release clamps, so the windshield does not require any “leave-behind” docking hardware. You get quick on-and-off convenience, and a clean, custom look. No tools are required, and the kit includes everything needed to install the windshield. The tough, hard-coated polycarbonate windshield is now available with sinister gloss black horizontal and vertical braces.

Fits '93-'05 FXDWG and '86-later FXST, FXSTC and FXSTB models.

**58360-09** 19" Clear. **\$439.95**

Windshield dimensions: Overall height – 23.8"; width – 21.4".

**58376-09** 16" Lightly Smoked. **\$449.95**

Windshield dimensions: Overall height – 20.8"; width – 21.4".

### B. DETACHABLE COMPACT WINDSHIELD FOR MODELS WITH AUXILIARY LIGHTING

Dress up or down with the convenience of a Detachable Windshield. This compact-style windshield is designed to fit models equipped with Auxiliary Lighting Kit P/N 68268-03A or 69285-05.

Fits '93-'05 FXDWG and '84-later FXST, FXSTC, FXSTB models. Requires separate purchase of Docking Hardware Kit P/N 58361-03.

**58865-03** 19" Clear. **\$284.95**

Windshield dimensions: Overall height – 21.9"; width – 21.4".

#### Also available:

#### DOCKING HARDWARE FOR DETACHABLE WINDSHIELDS

**58361-03** **\$74.95**

Required for installation of Detachable Windshield on '93-'05 FXDWG and '84-later FXST, FXSTC, FXSTB models equipped with Auxiliary Lighting Kit.



A. QUICK-RELEASE COMPACT WINDSHIELD – GLOSS BLACK (19" CLEAR SHOWN)



B. DETACHABLE COMPACT WINDSHIELD FOR MODELS WITH AUXILIARY LIGHTING

Notice: The prices appearing in this catalog are the manufacturer's suggested retail prices. Actual retail prices may vary.



C. KING-SIZE DETACHABLE WINDSHIELD FOR FL SOFTAIL MODELS – 21" CLEAR

**C. KING-SIZE DETACHABLE WINDSHIELD FOR FL SOFTAIL® MODELS**

The Lexan® windshield is formed from hard-coated polycarbonate material to resist scratching and abrasion. Polished stainless steel mounting brackets are supported by molded-rubber bushings for improved isolation. It is offered in a 21" clear Lexan or 18" lightly smoked Lexan shield. Comes complete with all the hardware required to fit FLSTC, FLSTF and FLSTN models without auxiliary lamps. (Chrome Wind Deflector Kit P/N 58125-90A can be used with this windshield kit on '99-earlier models. Windshield will not fit with auxiliary lamps.)

Fits '86-'99 FLSTC, '90-later FLSTF, FLSTFB, '06 FLST, and '93-'96 FLSTN models without auxiliary lamps. (Does not fit Springer models.)

**58243-95** 21" Clear. **\$354.95**

Windshield dimensions: Overall height – 26.3"; width – 23.1".

**58278-95** 18" Lightly Smoked. **\$379.95**

Windshield dimensions: Overall height – 23.4"; width – 23.1".

**D. KING-SIZE DETACHABLE WINDSHIELD FOR FL SOFTAIL® MODELS – GLOSS BLACK**

Styled to complement the "blacked-out" look of the FLSTFB Fat Boy Lo, this windshield can be installed or removed in seconds without tools, keeping your bike ready for the open road or for a run down Main Street. The Lexan® windshield is formed from hard-coated polycarbonate material to resist scratching and abrasion, and is now available with gloss black braces and mounting brackets to blend with your blacked-out customizing style. Mounting brackets are supported by molded-rubber bushings for improved isolation. Windshield kit includes all the hardware required to fit FLSTC, FLSTF and FLSTN models without auxiliary lamps.

Fits '86-'99 FLSTC, '90-later FLSTF, FLSTFB, '06 FLST, and '93-'96 FLSTN models without auxiliary lamps. (Does not fit Springer models.)

**57688-10** 21" Clear. **\$354.95**

Windshield dimensions: Overall height – 26.3"; width – 23.1".

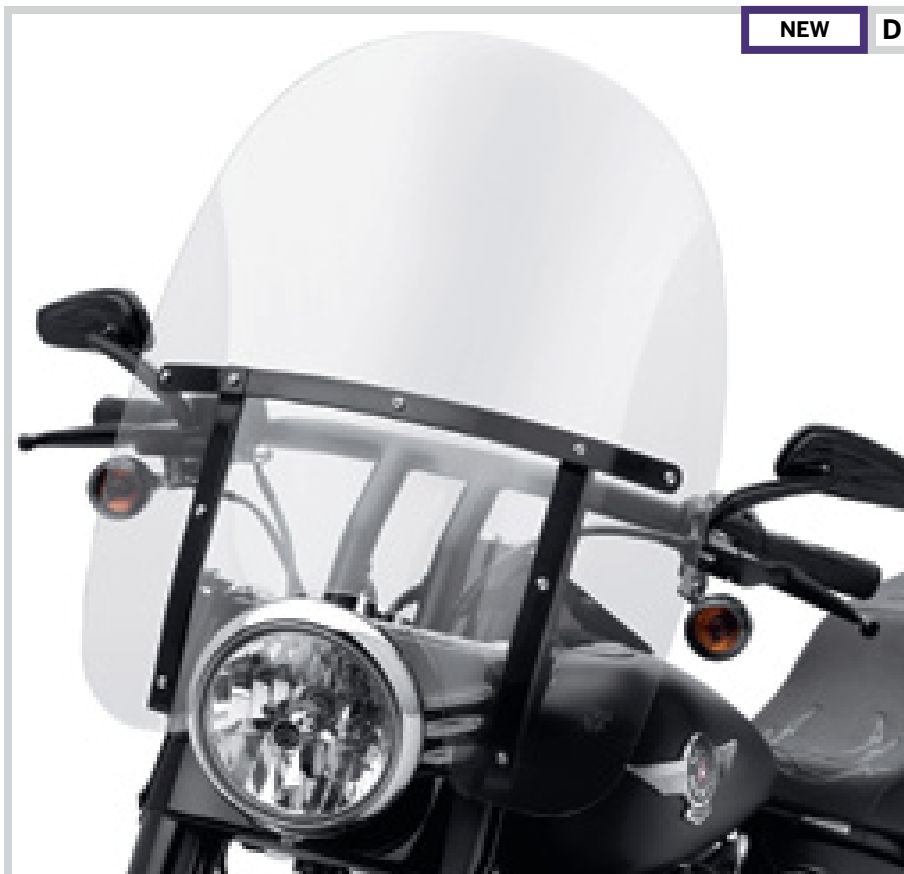

D. KING-SIZE DETACHABLE WINDSHIELD FOR FL SOFTAIL MODELS – GLOSS BLACK

# 214 SOFTAIL®

Windshields – FL Softail

## A. KING-SIZE NOSTALGIC DETACHABLE WINDSHIELD FOR FL SOFTAIL® MODELS

Formed from hard-coated Lexan® polycarbonate to resist scratching, this one-piece windshield features a nostalgic horseshoe-shaped outer brace with stylized Bar & Shield logo. The highly polished mounting brackets attach easily with the included mounting hardware, and after initial installation, the windshield can be removed and re-attached without tools in seconds. Detachable Windshields are available in 21" and 18" versions to match your need for wind protection.

Fits '05-later FLSTN, '86-later FLSTC, '00-later FLSTF, FLSTFB and '06 FLST models with or without auxiliary lamps. Additional mounting hardware not required.

**57140-05** 21" Clear. **\$374.95**  
Windshield dimensions: Overall height – 26.3"; width – 23.1".

**57141-05** 18" Lightly Smoked. **\$399.95**  
Windshield dimensions: Overall height – 23.4"; width – 23.1".

## B. KING-SIZE DETACHABLE WINDSHIELD FOR NACELLE EQUIPPED MODELS WITHOUT AUXILIARY LAMPS

This one-piece polycarbonate windshield is designed with a larger diameter opening to wrap around the contour on the Chrome Headlamp Nacelle Kit P/N 67907-96B. Full length windshield will not fit with Original Equipment or accessory Auxiliary Lamp Kits.

Fits '86-later FLSTC, FLSTF, FLSTFB, '06 FLST and '93-'96 FLSTN models equipped with the Chrome Headlamp Nacelle Kit P/N 67907-96B. Fits without auxiliary lamps.

**58652-97A** 19" Clear. **\$374.95**  
Windshield dimensions: Overall height – 26.3"; width – 23.1".

**58653-97A** 16" Lightly Smoked. **\$399.95**  
Windshield dimensions: Overall height – 23.4"; width – 23.1".

## C. KING-SIZE DETACHABLE WINDSHIELD FOR NACELLE EQUIPPED MODELS WITH AUXILIARY LIGHTING

This one-piece polycarbonate windshield is designed with a larger diameter opening to wrap around the contour on the Chrome Headlamp Nacelle Kit P/N 67907-96B. Windshield is shaped to accept Original Equipment or accessory Auxiliary Lamp Kits.

Fits '86-later FLSTC, FLSTF, FLSTFB, '06 FLST and '93-'96 FLSTN models equipped with the Chrome Headlamp Nacelle Kit P/N 67907-96B. Fits with auxiliary lamps.

**58649-97A** 19" Clear. **\$374.95**  
Windshield dimensions: Overall height – 26.3"; width – 23.1".

**58651-97A** 16" Lightly Smoked. **\$399.95**  
Windshield dimensions: Overall height – 23.4"; width – 23.1".



A. KING-SIZE NOSTALGIC DETACHABLE WINDSHIELD FOR FL SOFTAIL MODELS – 18" LIGHTLY SMOKED



B. KING-SIZE DETACHABLE WINDSHIELD FOR NACELLE – WITHOUT AUXILIARY LAMPS – 19" CLEAR



C. KING-SIZE DETACHABLE WINDSHIELD FOR NACELLE – WITH AUXILIARY LIGHTING – 16" LIGHTLY SMOKED

Notice: The prices appearing in this catalog are the manufacturer's suggested retail prices. Actual retail prices may vary.





**D. KING-SIZE DETACHABLE WINDSHIELD FOR FL SOFTAIL MODELS WITH AUXILIARY LIGHTING – 23" CLEAR**



**D. KING-SIZE DETACHABLE WINDSHIELD FOR FL SOFTAIL MODELS WITH AUXILIARY LIGHTING – 21" LIGHTLY SMOKED**



**D. KING-SIZE DETACHABLE WINDSHIELD FOR FL SOFTAIL MODELS WITH AUXILIARY LIGHTING – 16" CLEAR**



**D. KING-SIZE DETACHABLE WINDSHIELD FOR FL SOFTAIL MODELS WITH AUXILIARY LIGHTING – 18" LIGHTLY SMOKED**



**E. REPLACEMENT WINDSHIELD LEXAN**



**F. SKULL WITH WINGS WINDSHIELD TRIM KIT**

**D. KING-SIZE DETACHABLE WINDSHIELD FOR FL SOFTAIL® MODELS WITH AUXILIARY LIGHTING**

This one-piece Lexan® windshield is formed from hard-coated polycarbonate material to resist scratching. The Lexan® shield is attached to highly-polished stainless steel mounting brackets supported by molded-rubber bushings for improved isolation. Available in your choice of clear or lightly-smoked Lexan, and in a variety of heights to match your size and riding style. (Chrome Wind Deflector Kit P/N 58125-90A can be used with this windshield kit on '99-earlier models.)

Fits '00-later FLSTC models. (Additional mounting hardware not required.)

**57734-00** 18" Lightly Smoked. **\$349.95**

Windshield dimensions: Overall height – 23.4"; width – 23.1".

**57061-09** 16" Clear. **\$299.95**

Windshield dimensions: Overall height – 23.4"; width – 23.1". (Stock on '06-later HDI FLSTC models.)

**57061-00** 21" Clear. **\$304.95**

Windshield dimensions: Overall height – 26.3"; width – 23.1".

**57748-04** 23" Clear. **\$334.95**

Windshield dimensions: Overall height – 28.3"; width – 23.1".

Fits '86-'99 FLSTC and '90-later FLSTF, FLSTFB, '06 FLST, '93-'96 FLSTN models with auxiliary lighting. Includes mounting hardware. (Does not fit Springer models.)

**58275-95** 18" Lightly Smoked. **\$384.95**

Windshield dimensions: Overall height – 23.4"; width – 23.1".

**58240-95** 21" Clear. **\$354.95**

Windshield dimensions: Overall height – 26.3"; width – 23.1".

**58628-99** 21" Lightly Smoked. **\$384.95**

Windshield dimensions: Overall height – 26.3"; width – 23.1".

**57749-04** 23" Clear. **\$369.95**

Windshield dimensions: Overall height – 28.3"; width – 23.1".

**E. REPLACEMENT WINDSHIELD LEXAN®**

Tailor your existing windshield for your riding preference. Replace the original Lexan windshield with a screen sized to improve wind protection. Uses your existing mounting brackets and hardware for an easy, economical conversion.

Fits '86-later FLSTC and FLSTF, FLSTFB, '06 FLST and '93-'96 FLSTN models equipped with a Detachable King-Size Windshield. (Does not fit Springer® models.)

**57754-04** 23" Clear. **\$159.95**

**57975-99** 21" Lightly Smoked. **\$159.95**

**58277-95** 18" Lightly Smoked. **\$154.95**

Fits '86-later FLSTC and FLSTF, '06 FLST and '93-'96 FLSTN models equipped with the Chrome Headlamp Nacelle Kit P/N 67907-96B.

**58657-97A** 19" Clear. **\$144.95**

**58658-97A** 16" Lightly Smoked. **\$154.95**

**F. SKULL WITH WINGS WINDSHIELD TRIM KIT**

This Trim Kit replaces the horizontal inner and outer trim strips of your current windshield with a new bar featuring a cast "Skull with Wings" logo. Kit includes inner and outer trim and mounting tape for easy installation.

**58691-04** **\$89.95**

Fits '86-later FLSTC and FLSTF, FLSTFB, '06 FLST, and '94-later FLHR models equipped with King-Size Windshields.

# 216 SOFTAIL®

Windshields – Springer Models

## A. KING-SIZE DETACHABLE WINDSHIELD FOR HERITAGE SPRINGER® MODELS

This one-piece Lexan® windshield is formed from hard-coated polycarbonate material to resist scratching. The Lexan® shield is attached to highly-polished stainless steel mounting brackets supported by molded-rubber bushings for improved isolation.

Fits '97-'03 FLSTS and '05-'07 FLSTSC models. Installation requires the separate purchase of Windshield Docking Hardware Kit P/N 58907-96B. Will not fit with Chrome Billet Mini Tach Mounts.

**58772-97** 18" Clear. **\$314.95**  
Windshield dimensions: Overall height – 27"; width – 23.1".

### Shown with:

#### DOCKING HARDWARE FOR DETACHABLE WINDSHIELDS

**58907-96B** Polished Finish. **\$69.95**  
Required for installation of Detachable Windshields on '93-later FXSTS, FXSTSSE, FXSTSB, '97-later FLSTS, FLSTSB and FLSTSC models.

## B. DETACHABLE COMPACT WINDSHIELD – GLOSS BLACK

Get the convenience of Detachables and the traditional Harley-Davidson look in one easy-to-install windshield. This windshield is formed from a hard-coated Lexan® polycarbonate that resists scratching and abrasion. Equipped with Detachable docking hardware, the windshield can be installed or removed in seconds without tools, keeping your bike ready for the open road or for a run down Main Street. Now available with gloss black braces and mounting brackets, these windshields blend with your customizing style.

Fits '08-later FLSTSB models. Installation requires separate purchase of Windshield Docking Hardware Kit P/N 58907-96B (chrome) or 58165-09 (black).

**58073-09** 15" Clear. **\$324.95**  
Windshield dimensions: Overall height – 26.8"; width – 19.7".

**58161-09** 11" Lightly Smoked. **\$349.95**  
Windshield dimensions: Overall height – 22.8"; width – 19.7".

### Shown with:

#### DOCKING HARDWARE FOR DETACHABLE WINDSHIELDS

Kit includes detachable docking points and gloss black mounting hardware.

**58165-09** Black Finish. **\$69.95**  
Required for installation of Detachable Windshields on '93-later FXSTS, FXSTSSE, FXSTSB, '97-later FLSTS, FLSTSB and FLSTSC models.



A. KING-SIZE DETACHABLE WINDSHIELD FOR HERITAGE SPRINGER MODELS – 18" CLEAR

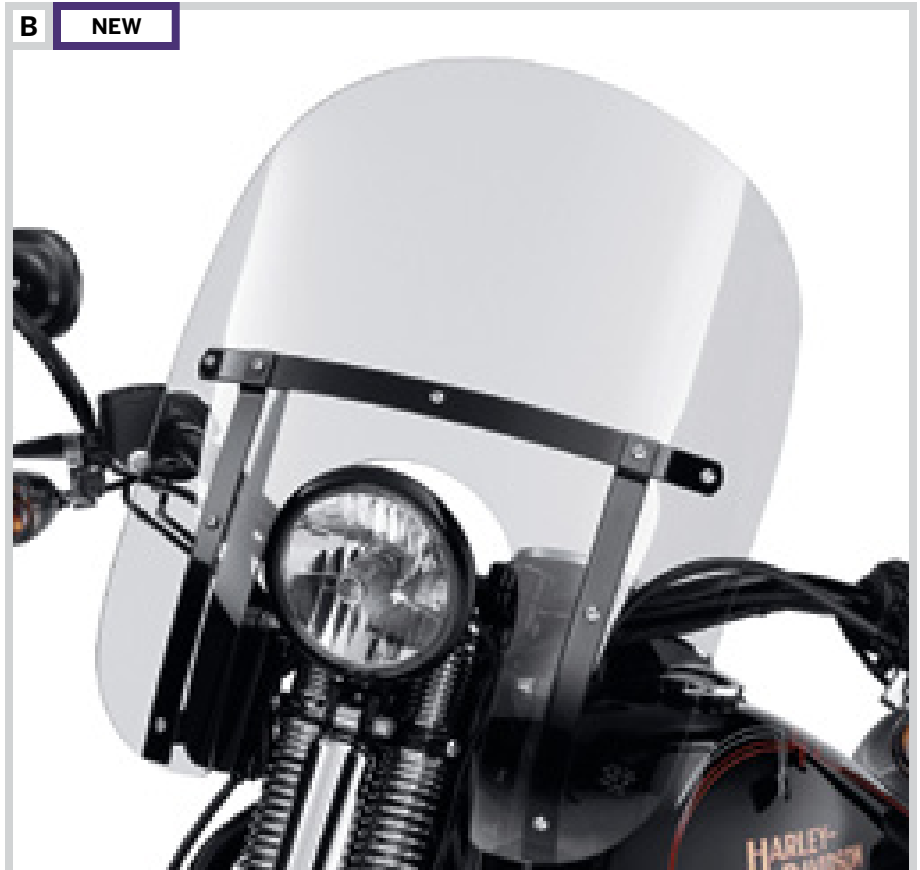

B. DETACHABLE COMPACT WINDSHIELD – GLOSS BLACK (11" LIGHTLY SMOKED SHOWN)

Notice: The prices appearing in this catalog are the manufacturer's suggested retail prices. Actual retail prices may vary.



**C. DETACHABLE COMPACT WINDSHIELD FOR SOFTAIL CROSS BONES MODELS – 15" CLEAR**



**C. DETACHABLE COMPACT WINDSHIELD FOR SOFTAIL CROSS BONES MODELS – 11" LIGHTLY SMOKED**



**C. DETACHABLE COMPACT WINDSHIELD FOR SPRINGER SOFTAIL MODELS – 18" CLEAR**



**C. DETACHABLE COMPACT WINDSHIELD FOR SPRINGER SOFTAIL MODELS – 14" LIGHTLY SMOKED**



**D. DETACHABLE SUPER SPORT WINDSHIELD FOR FX SPRINGER SOFTAIL MODELS – 13" LIGHTLY SMOKED**



**E. COTTON WINDSHIELD STORAGE BAG**

### C. DETACHABLE COMPACT WINDSHIELD FOR SOFTAIL® SPRINGER® MODELS

Get the convenience of Detachables and the traditional Harley-Davidson look in one easy-to-install windshield. This windshield is formed from a hard-coated Lexan® polycarbonate that resists scratching and abrasion. Because it is designed to work with Detachable docking hardware, this windshield comes on or off in less than 60 seconds without tools.

Fits '08-later FLSTSB models. Installation requires separate purchase of Windshield Docking Hardware Kit P/N 58907-96B.

**57701-08** 15" Clear. **\$309.95**  
Windshield dimensions: Overall height – 26.8"; width – 19.7".

**57702-08** 11" Lightly Smoked. **\$324.95**  
Windshield dimensions: Overall height – 22.8"; width – 19.7".

Fits '93-later FXSTS, FXSTSB, and FXSTSSE, '97-'03 FLSTS and '05-'07 FLSTSC models. Installation requires the separate purchase of Windshield Docking Hardware Kit P/N 58907-96B. (Will fit with or without auxiliary lighting.) Will not fit with Chrome Billet Mini Tach Mounts.

**58770-96** 18" Clear. **\$309.95**  
Windshield dimensions: Overall height – 26.8"; width – 19.9".

**58771-96** 14" Lightly Smoked. **\$334.95**  
Windshield dimensions: Overall height – 22.8"; width – 19.9".

### D. DETACHABLE SUPER SPORT WINDSHIELD – FX SPRINGER

Super is an apt description for this do-it-all shield. Detachable convenience. Harley-Davidson sport styling. High-quality, lightly smoked Lexan® polycarbonate that shields you from the elements. The windshield mounts to the fork tubes with Detachable Docking Hardware (*sold separately*) for easy on-and-off convenience and a quick return to a sporting profile.

**57969-97A** 13" Lightly Smoked. **\$219.95**

Fits '93-later FXSTS, FXSTSB, FXSTSSE models.

Use Docking Hardware Kit P/N 58907-96B. Will not fit with Chrome Billet Mini Tach Mounts. Windshield dimensions: Overall height – 22.8"; width – 17.7".

#### Shown with:

#### DOCKING HARDWARE FOR DETACHABLE WINDSHIELDS

**58907-96B** **\$69.95**

Required for installation of Detachable Windshields on '93-later FXSTS, FXSTSSE, FXSTSB, '97-later FLSTS, FLSTSB and FLSTSC models.

### E. COTTON WINDSHIELD STORAGE BAG

This bag is constructed of breathable cotton material and is designed for a scratch-free storage area. The outside of the bag features an embroidered Bar & Shield logo to match the cotton cycle covers.

**95982-98B** **\$69.95**

Fits all Harley-Davidson® windshields.

# SOFTAIL® SEATS

## SEAT OF POWER

*The right seat is equal parts ergonomics and comfort. Its shape anchors your position and determines the reach to the ground and to the controls; and the padding supports your tailbone and hips to relieve stress and pressure. Pick the right one for you...and your passenger.*

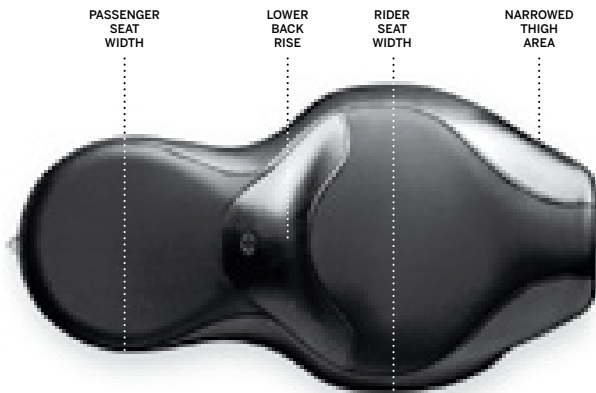

### COMFORT ZONE

A seat is more than just leather and foam. For maximum highway comfort, a broad seating surface distributes weight to reduce pressure points. For a short rider, a narrow, tapered thigh zone provides easier reach to the ground. And a stepped seat profile keeps the rider from sliding back during acceleration.

### SOFTAIL SEAT TYPES

Solo or two-up, comfort or style, check out these seats to get an idea of where you want to sit.

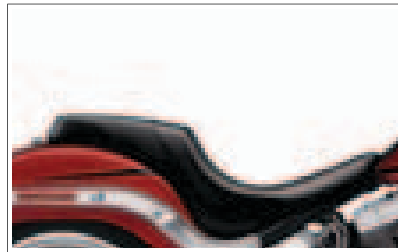

#### LOW-PROFILE SEATS

*These saddles combine radical styling with a “deep in the bike” riding position. Long and lean, Badlander®, Brawler® and Sidekick® seats bring you lower to the ground than most other seats.*



#### POSITION SEATS

*Designed to place the rider in the best relationship to the controls, Reach® and Tallboy® seats position short and tall riders for a comfortable extension of the arms and legs.*



#### TOURING SEATS

*Designed for comfort, Sundowner™ and Signature Series™ seats offer a broad seating surface to reduce pressure points and a dish shape holds you in place and provides additional back support.*

### CHANGING YOUR SEAT



Switching out your seat is simple. And because certain rides call for certain styles, some folks like to have multiple seats to match the occasion. Install a comfortable, supportive touring seat for the longer treks, and swap it out for a low-profile seat for a night on the town. Please see your owner's manual for proper removal and installation of seats.

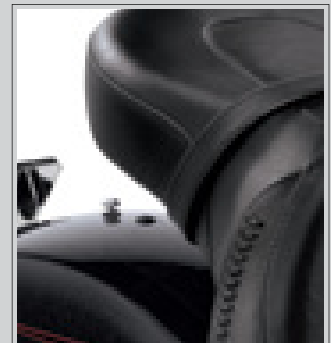





A. BRAWLER SEAT

**A. BRAWLER® SEAT**

When it's time to go it alone, go solo in style. These premium quality cowhide leather saddles are designed to create a subtle and distinctive look. Top-grain leather seating surface and contoured foam padding add long-haul comfort, and the durable hand-laid fiberglass seat pan is carpeted to protect the paint finish.

**51393-06A** **\$299.95**  
 Fits '07-later FLSTF, FLSTFB, FLSTSB and '06-later FXST, FXSTB, FXSTC and FXSTS (except FLSTSE and FXSTSSE/2/3) models. Seat width 12.5". For two-up versatility, you can add the matching detachable Brawler Passenger Pillion P/N 52270-08.

**53359-02** **\$299.95**  
 Fits '00-'07 FLSTC, '06 FLST, '00-'06 FLSTF and '00-'05 FX Softail® models (except FXSTD). Seat width 13".

**B. SIDEKICK® SEAT**

Share your custom ride. The two-up design of this premium cowhide leather seat offers a frame-hugging look, but adds back support for the rider, and additional padding for the passenger. The custom seating surface and the hand-laid fiberglass seat base show attention to detail second to none.

**51387-06A** **\$369.95**  
 Fits '07-later FLSTF, FLSTFB, FLSTSB and '06-later FXST, FXSTB, FXSTC and FXSTS (except FLSTSE and FXSTSSE/2/3) models. FLSTSB models require separate purchase of Passenger Footpeg Mounting Kit P/N 50932-08 and passenger footpegs. Seat width 12.5"; pillion width 6.5".



B. SIDEKICK SEAT

NOTE: Some Harley-Davidson® seats are made of leather. Fine leathers or other natural materials WILL gain "character," such as wrinkles or wear, with age. This is normal. A fine, aged patina and character wrinkles are a sign of the extremely high quality materials used to construct your seat or backrest. The appearance of scars or marks on the leather are a result of using natural leather panels and should not be thought of as an imperfection. Please use Harley-Davidson Leather Dressing P/N 98261-91V to protect your investment.

Notice: The prices appearing in this catalog are the manufacturer's suggested retail prices. Actual retail prices may vary.

THE CUSTOM SEAT PROGRAM  
 ALLOWS YOU TO SELECT THE  
 STITCH PATTERNS, LEATHER  
 INLAYS AND THREAD COLORS  
 TO COMPLEMENT FACTORY OR  
 CUSTOM PAINT.

See pages 706-709 for more information.

SOFTAIL



## 220 SOFTAIL®

### Seating

#### A. BRAWLER® SEAT – VINYL

The Brawler solo seat hugs the frame for a low-profile custom look. The rich black vinyl seating surface stands up to abuse and the weather with minimal care, and the thermo-formed seat pan and premium quality foam padding is contoured for added support. For two-up versatility, you can add the matching detachable Brawler Passenger Pillion P/N 52270-08.

**52269-08 \$199.95**

Fits '07-later FLSTF, FLSTFB, FLSTSB and '06-later FXST, FXSTB, FXSTC and FXSTS (except FLSTSE and FXSTSSE/2/3) models. Seat width 12.5".

#### B. BRAWLER PASSENGER PILLION\*

Add two-up versatility to your custom ride. Designed to complement leather or vinyl-covered Brawler solo seats, this easy-to-install vinyl Passenger Pillion allows you to share your ride at a moment's notice. Kit includes mounting hardware and grab strap.

**52270-08 \$119.95**

Fits Softail models equipped with Brawler Solo Seat P/N 52269-08 or 51393-06A. Pillion width 9.0".

#### C. RALLYRUNNER® SEAT

This Rallyrunner seat combines a sleek frame-hugging contour with added long-haul comfort. The seat features thicker padding for the rider, and a wider passenger pillion for the passenger. The premium cowhide leather seating surface has a rich, luxurious feel, and the carpeted hand-laid fiberglass seat base hugs the fender for a custom look. The foam padding will form to the rider's shape, and provide hours of riding comfort.

**51936-08 \$369.95**

Fits '07-later FLSTF, FLSTFB, FLSTB and '06-later FXST, FXSTB, FXSTC and FXSTS (except FLSTSE and FXSTSSE/2/3) models. FLSTSB models require separate purchase of Passenger Footpeg Mounting Kit P/N 50932-08 and passenger footpegs. Seat width 13.0"; passenger pillion width 11.0".

#### D. RETRO KING/QUEEN SEAT FOR SOFTAIL® MODELS

Take a ride back in time on this 1960s-style King/Queen Seat. Featuring a highly stylized tuck-n-roll pleated surface, this retro-looking seat will bring back memories of riding free. The low and lean two-up seat profile hugs the frame and rear fender like no other. Your passenger will benefit from a longer pillion and a built-in backrest pad.

**51401-07 \$299.95**

Fits '07-later FXSTC models. Also fits '07-later FLSTF, FLSTFB, FLSTSB and '06-later FXST, FXSTB and FXSTS models (except FXSTSSE3) equipped with One-Piece Upright P/N 52729-08 or FXSTC Original Equipment Sissy Bar Upright P/N 51849-07 and screw (4) P/N 4598. FLSTSB models require separate purchase of Passenger Footpeg Mounting Kit P/N 50932-08 and passenger footpegs. Seat width 13.0"; passenger pillion width 7.0".

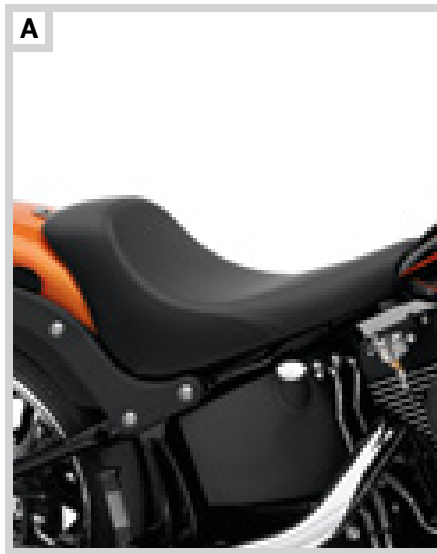

A. BRAWLER SEAT – VINYL

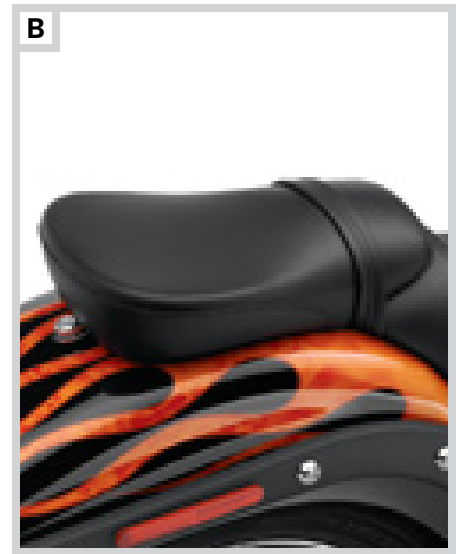

B. BRAWLER PASSENGER PILLION



C. RALLYRUNNER SEAT



D. RETRO KING/QUEEN SEAT FOR SOFTAIL MODELS

NOTE: Some Harley-Davidson® seats are made of leather. Fine leathers or other natural materials WILL gain "character," such as wrinkles or wear, with age. This is normal. A fine, aged patina and character wrinkles are a sign of the extremely high quality materials used to construct your seat or backrest. The appearance of scars or marks on the leather are a result of using natural leather panels and should not be thought of as an imperfection. Please use Harley-Davidson Leather Dressing P/N 98261-91V to protect your investment.



**\*WARNING:** Do not install on models that are not equipped with passenger footpegs. Doing so could result in death or serious injury.

Notice: The prices appearing in this catalog are the manufacturer's suggested retail prices. Actual retail prices may vary.



E

E. BADLANDER SEAT

**E. BADLANDER® SEAT**

Clean smooth covers, subtle top-stitching, and two embroidered "Harley-Davidson" logos add up to a statement only Harley could create. The low, lean look also offers the benefit of a reduced seat height, ideal for riders wanting the lowest possible seat height. Includes all mounting hardware.

**51397-06A** **\$199.95**

Fits '07-later FLSTF, FLSTFB, FLSTSB and '06-later FXST, FXSTB, FXSTC and FXSTS models (except FLSTSE and FXSTSSE3). FLSTSB models require separate purchase of Passenger Footpeg Mounting Kit P/N 50932-08 and passenger footpegs. Does not have embroidered logos. Seat width 12.0"; passenger pillion width 6.5".

**52292-00A** **\$199.95**

Fits '00-later FLST, FLSTC and FLSTSC, '00-'06 FLSTF, '00-'05 FX Softail models (except FXSTD). Also fits FLSTN models with removal of stock luggage rack. Seat width 12.0"; passenger pillion width 6.5".

**52461-00A** **\$199.95**

Fits '00-'07 FXSTD models. Seat width 12.0"; passenger pillion width 6.5".

**52292-94B** **\$219.95**

Fits '84-'99 Softail models (except FLSTS). Seat width 12.0"; passenger pillion width 6.5".

**F. LEATHER BADLANDER® SEAT**

The traditional Badlander® Seat style is enhanced with supple top-grain leather. Includes leather care product, seat, grab strap and mounting hardware.

**52361-00A** **\$239.95**

Fits '00-later FLST, FLSTC and FLSTSC, '00-'06 FLSTF, '00-'05 FX Softail models (except FXSTD). Also fits FLSTN models with removal of stock luggage rack. Seat width 12.0"; passenger pillion width 6.0".

**G. DIAMOND BACK® SEAT FOR SOFTAIL® MODELS**

This minimalist, yet stylish low-profile seat makes you feel like you are part of your machine. Add the Diamond Back Chrome Sections to finish the solo look or convert to two-up riding with the Diamond Back Pillion.

**52629-00** **\$139.95**

Fits '00-'05 FXST, FXSTB, FXSTS, FLSTC and '00-'06 FLSTF (except '06 FLSTFSE2) models. Seat width: 13.8".

**Shown with:****DIAMOND BACK PILLION\***

Adds two-up capability to Diamond Back Seat. This custom-look pillion complements the seats in our Diamond Back Collection and is interchangeable with Diamond Back Tail Sections. Kit includes pillion and passenger grab strap.

**52069-98** **\$89.95**

Fits '83-'03 XL models and '84-'05 Softail models and '84-'06 FLSTF models equipped with Diamond Back seats (except FXSTD, FLSTS, FLSTSC or FLSTN). (Does not work with Detachable Pillion Hardware Kits.) Passenger pillion width 5.0".

**Also shown with:****DIAMOND BACK CHROME TAIL SECTIONS**

A hand-polished chrome-plated steel insert, fitted to a vinyl covered molded base, provides long-lasting good looks. Includes mounting hardware for quick, easy installation. Can only be installed with appropriate Diamond Back Seat.

Fits '82-'03 XL, '93-'03 FXDWG, '82-'94 FXR, '99 FXR models, and '84-'05 Softail models (except FXSTD, FLSTS, FLSTSC or FLSTN) and '84-'06 FLSTF models.

**1. 52053-96** Diamond Accent. **\$79.95**

**2. 52620-95** Solid. **\$79.95**



F

F. LEATHER BADLANDER SEAT



G

G. DIAMOND BACK SEAT FOR SOFTAIL MODELS



**\*WARNING:** Do not install on models that are not equipped with passenger footpegs. Doing so could result in death or serious injury.

## 222 SOFTAIL®

### Seating

#### A. TOURING SOLO SPRING SADDLE

Combine nostalgic spring seat styling with the comfort needed for a long day in the saddle. Featured on the Softail Cross Bones model, this seat offers a deep bucket design and a thick-padded seating surface for maximum support. Textured and laced panels add to the "old school" custom look. Installation requires separate purchase of model-specific Seat Bracket and Spring Kit.

**51481-08** **\$269.95**

Fits '08-later FLSTSB, FXST, FXSTB, FXSTC and FXSTS (except FXSTSSE/2/3) models. Requires separate purchase of Hardware Kit P/N 51902-09 or 52225-89. Seat width 17.0".

#### B. PASSENGER PILLION – CROSS BONES STYLING\*

Bring a passenger along for the ride. This easy-to-install detachable Passenger Pillion features insert panels and decorative lacing styled to match the Softail Cross Bones Original Equipment sprung solo seat. Kit includes mounting hardware and grab strap.

**51787-08** **\$139.95**

Fits '08-later FLSTSB models equipped with Original Equipment solo seat. Installation requires separate purchase of Passenger Footpeg Mounting Kit P/N 50932-08 and passenger footpegs. Pillion width 8".

#### C. DELUXE LEATHER SOLO SPRING SADDLE WITH NOSTALGIC SKIRT

Step back to the late 1940s. Styled to complement the look of the post war Harley models, this deep dished leather solo saddle features a firm but comfortable seating surface. The flexible skirt and chrome concho add a nostalgic touch. Available as a direct replacement for the Softail Cross Bones solo seat, this Deluxe Leather Saddle re-uses the Original Equipment springs and mounting hardware. Installation on other models requires separate purchase of model-specific Seat Bracket and Spring Kit.

**52006-47B** **\$269.95**

Fits '08-later FLSTSB, FXST, FXSTB, FXSTC and FXSTS models (except FXSTSSE/2/3) and '86-'94 Softail models. Requires separate purchases of model-specific Mounting Hardware Kit P/N 51902-09 or 52225-89.

#### D. STANDARD LEATHER SOLO SPRING SADDLE

First offered in 1925, this timeless solo saddle offers a deep dish bucket shape and a firm leather covering. The wide seating surface and the narrow seat nose provide a surprisingly comfortable and supportive ride. Available as a direct replacement for the Softail Cross Bones solo seat, this Leather Saddle re-uses the Original Equipment springs and mounting hardware. Installation on other models requires separate purchase of model-specific Seat Bracket and Spring Kit.

**52004-25** **\$269.95**

Fits '08-later FLSTSB, FXST, FXSTB, FXSTC and FXSTS models (except FXSTSSE/2/3) and '86-'94 Softail models. Requires separate purchases of model-specific Mounting Hardware Kit P/N 51902-09 or 52225-89.

#### SOLO SEAT BRACKET/SPRING KIT *(not shown)*

Allows you to upgrade your Softail model to the nostalgic look of a sprung solo saddle. Complete kit includes front and rear mounting brackets, chrome-plated springs, all necessary hardware, and a frame/battery cover for a clean installation. This kit is required to install Touring Solo Saddle P/N 51481-08, Deluxe Leather Solo Saddle P/N 52006-47B or Leather Solo Saddle P/N 52004-25.

**51902-09** **\$229.95**

Fits '08-later FLSTSB, FXST, FXSTB, FXSTC and FXSTS models (except FXSTSSE2/3).

**52225-89** Fits '86-'94 Softail models. **\$229.95**

NOTE: Some Harley-Davidson® seats are made of leather. Fine leathers or other natural materials WILL gain "character," such as wrinkles or wear, with age. This is normal. A fine, aged patina and character wrinkles are a sign of the extremely high quality materials used to construct your seat or backrest. The appearance of scars or marks on the leather are a result of using natural leather panels and should not be thought of as an imperfection. Please use Harley-Davidson Leather Dressing P/N 98261-91V to protect your investment.



**\*WARNING:** Do not install on models that are not equipped with passenger footpegs. Doing so could result in death or serious injury.



A. TOURING SOLO SPRING SADDLE



B. PASSENGER PILLION – CROSS BONES STYLING



C. DELUXE LEATHER SOLO SPRING SADDLE WITH NOSTALGIC SKIRT



D. STANDARD LEATHER SOLO SPRING SADDLE

Notice: The prices appearing in this catalog are the manufacturer's suggested retail prices. Actual retail prices may vary.





E. SIGNATURE SERIES SEAT WITH RIDER BACKREST – SMOOTH

**E. SIGNATURE SERIES™ SEAT WITH RIDER BACKREST**

A perfect combination of foam density and shape has created our most comfortable seat for long haul touring. Both rider and passenger will be extra comfy riding to Sturgis and back with the wide seating areas. When you reach your destination, city driving will be easier with the narrow nose that helps keep your legs together. Seat features an easily removable, adjustable rider backrest that folds down for easier passenger mounting. Rider backrest has a 5-position height adjustment with 1.5" range, and a wide range of forward/back adjustment with a quick twist of the control knob.

**51985-08** Smooth. **\$499.95**

Fits '07-later FLSTF, FLSTFB, FLSTSB and '06-later FXST, FXSTB, FXSTC and FXSTS models (except FLSTSE and FXSTSSE3). FLSTSB models require separate purchase of Passenger Footpeg Mounting Kit P/N 50932-08 and passenger footpegs. Seat width 16.0"; passenger pillion width 14.0".

**51998-08** Smooth. **\$499.95**

Fits '00-later FLST, FLSTC and FLSTSC, '00-'06 FLSTF and '00-'05 Softail models (except FXSTD). Also fits FLSTN models with removal of stock luggage rack. '00-'06 FLST, FLSTC, FLSTSC, FLSTF and '00-'05 FX Softail models require separate purchase of Seat Bracket P/N 51949-09. Seat width 16.0"; passenger pillion width 14.0".

**51922-09** FLSTC Styling with Chrome Studs. **\$529.95**

Fits '00-later FLST, FLSTC and FLSTSC, '00-'06 FLSTF and '00-'05 Softail models (except FXSTD). Also fits FLSTN models with removal of stock luggage rack. '00-'06 FLST, FLSTC, FLSTSC, FLSTF and '00-'05 FX Softail models require separate purchase of Seat Bracket P/N 51949-09. Seat width 16.0"; passenger pillion width 14.0".



E. SIGNATURE SERIES SEAT WITH RIDER BACKREST – FLSTC STYLING

NOTE: Some Harley-Davidson® seats are made of leather. Fine leathers or other natural materials WILL gain "character," such as wrinkles or wear, with age. This is normal. A fine, aged patina and character wrinkles are a sign of the extremely high quality materials used to construct your seat or backrest. The appearance of scars or marks on the leather are a result of using natural leather panels and should not be thought of as an imperfection. Please use Harley-Davidson Leather Dressing P/N 98261-91V to protect your investment.

Notice: The prices appearing in this catalog are the manufacturer's suggested retail prices. Actual retail prices may vary.

## 224 SOFTAIL®

### Seating

#### SUNDOWNER™ DEEP BUCKET SEATS

The Sundowner Seat provides the maximum in long-riding comfort. The deep-bucket design puts your body in the proper touring position and the generous padding makes it comfortable for both the rider and passenger as the miles are adding up. The dished shape provides added rider back support, and the wide passenger pillion is shaped to minimize pressure points.

#### A. SUNDOWNER™ DEEP BUCKET SEAT – SMOOTH

The smooth vinyl cover features elegant top-stitching to complement most Harley-Davidson® saddlebags and luggage.

**51468-06A** **\$299.95**

Fits '07-later FLSTF, FLSTFB, FLSTSB and '06-later FXST, FXSTB, FXSTC and FXSTS models (except FLSTSE and FXSTSSE3). FLSTSB models require separate purchase of Passenger Footpeg Mounting Kit P/N 50932-08 and passenger footpegs. Seat width 16.5"; passenger pillion width 12.5".

**51764-06** **\$299.95**

Fits '00-later FLST, FLSTC and FLSTSC, '00-'06 FLSTF, '00-'05 FX Softail (except FXSTD). Also fits FLSTN models with removal of stock luggage rack. Seat width 16.5"; passenger pillion width 12.5".



A. SUNDOWNER DEEP BUCKET SEAT – SMOOTH ('06 FX SOFTAIL SHOWN)

#### B. SUNDOWNER™ DEEP BUCKET SEAT FOR SOFTAIL® DELUXE MODELS

Styled to complement the Softail Deluxe model, this Sundowner Seat features a leather valance with an embossed pattern and winged logo.

**51841-06** **\$329.95**

Fits '05-later FLSTN models. Seat width 16.5"; passenger pillion width 12.5".



B. SUNDOWNER DEEP BUCKET SEAT FOR SOFTAIL DELUXE MODELS

#### C. SUNDOWNER DEEP BUCKET SEAT – HERITAGE SOFTAIL® CLASSIC MODELS

This highly stylized seat features a leather valance with decorative chrome spots, along with intricate stitching detail on the seating surface to match the '00-later Heritage Softail Classic model.

**51813-09** **\$329.95**

Fits '00-later FLST, FLSTC and FLSTSC, '00-'06 FLSTF, '00-'05 FX Softail (except FXSTD). Also fits FLSTN models with removal of stock luggage rack. Seat width 16.5"; passenger pillion width 12.5".



C. SUNDOWNER DEEP BUCKET SEAT – HERITAGE SOFTAIL CLASSIC MODELS

NOTE: Some Harley-Davidson® seats are made of leather. Fine leathers or other natural materials WILL gain "character," such as wrinkles or wear, with age. This is normal. A fine, aged patina and character wrinkles are a sign of the extremely high quality materials used to construct your seat or backrest. The appearance of scars or marks on the leather are a result of using natural leather panels and should not be thought of as an imperfection. Please use Harley-Davidson Leather Dressing P/N 98261-91V to protect your investment.

Notice: The prices appearing in this catalog are the manufacturer's suggested retail prices. Actual retail prices may vary.



**D. SUNDOWNER DEEP BUCKET SEAT – FAT BOY MODELS ('00-'06 STYLE)**



**E. SUNDOWNER DEEP BUCKET SEAT – FAT BOY MODELS ('07-LATER STYLE)**



**F. SUNDOWNER DEEP BUCKET SEAT FOR FXSTSSE3 MODELS**

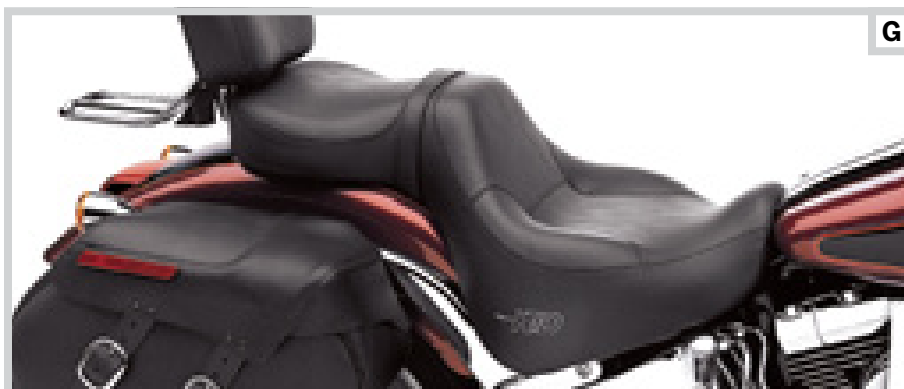

**G. SUNDOWNER DEEP BUCKET SEAT FOR SOFTAIL DEUCE MODELS (SHOWN WITH TOURING PASSENGER BACKREST PAD)**

#### SUNDOWNER™ DEEP BUCKET SEATS

The Sundowner Seat provides the maximum in long-riding comfort. The deep-bucket design puts your body in the proper touring position and the generous padding makes it comfortable for both the rider and passenger as the miles are adding up. The dished shape provides added rider back support, and the wide passenger pillion is shaped to minimize pressure points.

#### D. SUNDOWNER™ DEEP BUCKET SEAT – '00-'06 FAT BOY® MODELS

This highly stylized seat features an embroidered Fat Boy® logo and chrome grommets with leather lacing to match the '00-'06 Fat Boy model.

**51570-00A** **\$329.95**

Fits '00-later FLST, FLSTC and FLSTSC, '00-'06 FLSTF, '00-'05 FX Softail® (except FXSTD) models. Also fits FLSTN models with removal of stock luggage rack. Seat width 16.5"; passenger pillion width 12.5".

#### E. SUNDOWNER DEEP BUCKET SEAT – '07-LATER FAT BOY® MODELS

This highly stylized seat features an embossed leather valance with 3 decorative chrome studs and Spanish lacing to match the '07-later Fat Boy model.

**51801-07** **\$329.95**

Fits '07-later FLSTF, FLSTFB, FLSTSB and '06-later FXST, FXSTB, FXSTC and FXSTS models (except FLSTSE and FXSTSSE3). FLSTSB models require separate purchase of Passenger Footpeg Mounting Kit P/N 50932-08 and passenger footpegs. Seat width 16.5"; passenger pillion width 12.5".

#### F. SUNDOWNER™ DEEP BUCKET SEAT FOR FXSTSSE3 MODELS

The leather cover features an embossed buffalo leather inlay to complement the Custom Vehicle Operations Springer model styling.

**52271-09** **\$399.95**

Fits '09 FXSTSSE3 models. Seat width 16.5"; passenger pillion width 12.5".

#### G. SUNDOWNER™ DEEP BUCKET SEAT FOR SOFTAIL® DEUCE™ MODELS

When you've got the style of a Softail Deuce model, you want to take on the road as much as possible. This Sundowner seat gives you added touring comfort without sacrificing the Deuce style that has heads turning. A wide and deep rider bucket allows for lower back support and comfort for the long haul and the wide passenger pillion allows your passenger to be comfortable as well. Styled to match your Deuce with an embroidered "H-D" logo.

**51112-00B** **\$299.95**

Fits '00-'07 FXSTD models. Seat width 14.0"; passenger pillion width 11.0".

#### Shown with:

#### TOURING PASSENGER BACKREST PAD FOR SOFTAIL DEUCE MODELS

Together with the Sundowner Deep Bucket Seat for Softail Deuce P/N 51112-00B, this backrest passenger pad provides additional support for the long haul with a wide radius backrest.

**52050-00** **\$79.95**

Fits '00-'07 FXSTD models equipped with Passenger Sissy Bar Upright P/N 51114-00.

NOTE: Some Harley-Davidson® seats are made of leather. Fine leathers or other natural materials WILL gain "character," such as wrinkles or wear, with age. This is normal. A fine, aged patina and character wrinkles are a sign of the extremely high quality materials used to construct your seat or backrest. The appearance of scars or marks on the leather are a result of using natural leather panels and should not be thought of as an imperfection. Please use Harley-Davidson Leather Dressing P/N 98261-91V to protect your investment.

Notice: The prices appearing in this catalog are the manufacturer's suggested retail prices. Actual retail prices may vary.

# 226 SOFTAIL®

## Seating

### A. REACH® SEAT

Designed specifically for riders requiring a close to the bar riding position, this seat positions the rider approximately 1" forward, closer to the hand and foot controls. The narrow front profile brings your legs closer together to help you plant your feet firmly on the ground. The seat features a textured vinyl insert and a Bar & Shield logo that shows you are riding in style.

**52442-04A** **\$249.95**

Fits '00-later FLST, FLSTC and FLSTSC, '00-'06 FLSTF, '00-'05 FX Softail® models (except FXSTD). Also fits FLSTN models with removal of stock luggage rack. Seat width 13.5"; passenger pillion width 10".

**51470-06A** **\$249.95**

Fits '07-later FLSTF, FLSTFB, FLSTSB and '06-later FXST, FXSTB, FXSTC and FXSTS models (except FLSTSE and FXSTSSE3). FLSTSB models require separate purchase of Passenger Footpeg Mounting Kit P/N 50932-08 and passenger footpegs. Seat width 13.5"; passenger pillion width 10".



A. REACH SEAT

### B. REACH® SEAT FOR SOFTAIL® DELUXE MODELS

Specially designed to move riders with shorter inseams closer to the controls, the Reach Seat features a low-profile and narrow thigh-zone to bring the legs closer together to minimize leg stretch while stopped. The stepped seat design keeps the rider from sliding back during acceleration. In comparison to the Original Equipment seat, the Reach Seat moves the rider forward 1/2" and narrows the nose by 1-1/2". This seat features a stylish embossed leather valance to complement the Softail Deluxe model.

**51762-06** **\$299.95**

Fits '05-later FLSTN models. Seat width 15.5"; passenger pillion width 11".



B. REACH SEAT FOR SOFTAIL DELUXE MODELS

### C. TALLBOY® SEAT

Stretch your legs in style. The Tallboy Seat moves the rider back 2" and up 3" as compared to the Original Equipment seat. The new position allows additional leg and arm movement for the long-limbed rider, and a comfortable seating space for the open road. The Tallboy Seat also features a wide pillion for added passenger comfort.

**51469-06A** **\$259.95**

Fits '07-later FLSTF, FLSTFB, FLSTSB and '06-later FXST, FXSTB, FXSTC and FXSTS models (except FLSTSE and FXSTSSE3). FLSTSB models require separate purchase of Passenger Footpeg Mounting Kit P/N 50392-08 and passenger footpegs. Seat width 16.5"; passenger pillion width 12.5".



C. TALLBOY SEAT

### D. TALLBOY® SEAT FOR SOFTAIL® DELUXE MODELS

Stretch your legs in style. The Tallboy Seat moves the rider back 1.75" and up 2" as compared to the Original Equipment solo seat on the Softail® Deluxe. The new position allows additional leg and arm movement for the long-limbed rider, and a comfortable seating space for the open road. Stitched and textured to match the nostalgic style of the Softail Deluxe model, the Tallboy Seat also features a wide pillion for added passenger comfort.

**52852-05** **\$299.95**

Fits '05-later FLSTN models. Seat width 15"; passenger pillion width 11".



D. TALLBOY SEAT FOR SOFTAIL DELUXE MODELS

NOTE: Some Harley-Davidson® seats are made of leather. Fine leathers or other natural materials WILL gain "character," such as wrinkles or wear, with age. This is normal. A fine, aged patina and character wrinkles are a sign of the extremely high quality materials used to construct your seat or backrest. The appearance of scars or marks on the leather are a result of using natural leather panels and should not be thought of as an imperfection. Please use Harley-Davidson Leather Dressing P/N 98261-91V to protect your investment.

Notice: The prices appearing in this catalog are the manufacturer's suggested retail prices. Actual retail prices may vary.





**E. TOURING PASSENGER PILLION –  
SMOOTH STYLING**



**F. TOURING PASSENGER PILLION –  
FAT BOY STYLING**



**G. TOURING PASSENGER PILLION –  
SOFTAIL DELUXE STYLING**



**H. TOURING PASSENGER PILLION – HERITAGE  
SOFTAIL CLASSIC STYLING**



**I. PADDED PASSENGER PILLION FOR  
SCREAMIN' EAGLE FAT BOY MODELS**



**J. LOW-PROFILE PASSENGER PILLIONS**



**K. PASSENGER PILLION FOR FXCW MODEL  
(SHOWN WITH SISSY BAR UPRIGHT AND SMOOTH BACKREST PAD)**

### TOURING PASSENGER PILLIONS\*

Styled to match the stitching and texture of the Original Equipment rider seat, this stylish pillion provides an extra comfortable ride for your passenger on those long journeys.

#### E. SMOOTH STYLING

**51898-05A** **\$149.95**  
Fits '07-later FLSTC, FLSTF, FLSTFB and '05-'07 FLST and FLSTSC models. Pillion width 14".

#### F. FAT BOY® STYLING

**52915-07** **\$149.95**  
Fits '07-later FLSTC, FLSTF, FLSTFB and '05-'07 FLST and FLSTSC models. Pillion width 14".

#### G. SOFTAIL® DELUXE STYLING

**52930-05** **\$179.95**  
Fits '05-later FLSTN models with Original Equipment solo seat. Pillion width 12".

#### H. HERITAGE SOFTAIL® CLASSIC STYLING

**51763-07** **\$149.95**  
Fits '07-later FLSTC, FLSTF, FLSTFB and '05-'07 FLST and FLSTSC models. Pillion width 14".

**52912-00** **\$149.95**  
Fits '84-'06 Softail models (except FXSTD, FLSTS, FLSTSC, FLSTN or '05 FLSTFI 15th Anniversary models). Pillion width 14".

#### I. PADDED PASSENGER PILLION FOR SCREAMIN' EAGLE® FAT BOY® MODELS\*

Add two-up capability to the solo-seat equipped Screamin' Eagle Fat Boy model. This custom look pillion complements the Black and Chrome Solo Seat, and is interchangeable with the Original Equipment Chrome Tail Section.

**51830-06** **\$169.95**  
Fits '06 FLSTFSE2 models, '07-later FLSTF and '06-later FXST, FXSTB, FXSTC and FXSTS models (except FXSTSSE/2/3) equipped with Black and Chrome Solo Seat P/N 52279-06A. FLSTFSE2 models require separate purchase of Passenger Footpegs and Passenger Footpeg Mounting Kit P/N 50749-05.

#### J. LOW-PROFILE PASSENGER PILLIONS\*

##### 1. Heritage Softail® Classic Styling

**52533-93A** **\$99.95**  
Fits '00-'06 FL Softail models (except FLSTS, FLSTSC, FLSTN or '05 FLSTFI 15th Anniversary models) with stock seats. Also fits '84-'99 Softail models. Grab strap included. Passenger pillion width 7".

##### 2. Fat Boy® Styling

**52534-93A** **\$99.95**  
Fits '00-'06 FL Softail models (except FLSTS, FLSTSC, FLSTN or '05 FLSTFI 15th Anniversary models) with stock seats. Also fits '84-'99 Softail models (except FLSTS). (Does not include grab strap.)

#### K. PASSENGER PILLION FOR FXCW MODEL\*

Styled to complement the stock seat, this Passenger Pillion delivers maximum passenger comfort for the long haul or around-town riding. The Pillion is easily removable with simple finger-turn clamps.

**52959-08** **\$169.95**  
Fits '08-'09 FXCW model. Installation requires separate purchase of Touring System Strut Kit P/N 53935-08 and Solo Luggage Rack P/N 53957-08. Requires separate purchase of Passenger Footpeg Support Kit P/N 51039-05, (2) Screw P/N 4454, (2) Spring Washer P/N 50912-72 and passenger footpegs. Pad width: 9.5" front, 8" rear.



**\*WARNING:** Do not install on models that are not equipped with passenger footpegs. Doing so could result in death or serious injury.

Notice: The prices appearing in this catalog are the manufacturer's suggested retail prices. Actual retail prices may vary.

# 228 SOFTAIL®

## Seating

### A. CIRCULATOR SEAT PAD

Keep comfortable on your next long ride. These breathable Circulator Seat Pads feature 3D construction that promotes air movement and reduces heat build-up where the rider's body touches the seat. Designed to keep the rider cool by reducing the perspiration build-up between you and the seating surface, the Circulator Pad can be installed and removed in seconds for easy cleaning. The low-profile design minimizes seat-height change compared to inflatable pads, while enhancing comfort with its shock-absorbing construction. Manufactured of UV-stable materials, these seat pads resist fading when exposed to the sun. Elastic under-seat strap and non-slip base provide secure installation, and the available Circulator Passenger Pillion Pad attaches to the rider pad with hook-and-loop tabs.

**51076-10** Large Pad (16.0" width). **\$89.95**

Fits Softail and Touring models with Original Equipment and accessory seats. Will not fit Spring seats and Road Zeppelin seats.

**51078-10** Passenger Pillion Pad (13.0" width). **\$69.95**  
Fits Original Equipment and accessory passenger pillions.



A. CIRCULATOR SEAT PAD

### B. TANK BRA FOR SOFTAIL® MODELS

This tank bra is made with nonabrasive, fleece-backed vinyl material and features an embroidered Bar & Shield logo. It protects your fuel tank from scratches from keys, belt buckles and other objects. Designed for easy installation and a custom fit without disassembly of the tank or seat.

**57799-00** **\$39.95**

Fits '00-later Softail models (except FXCW/C, FXSTD, FXSTSSE3 and FLSTSB) and '93-'03 FXDWG models.

### C. REAR FENDER BIB – SOFTAIL® DELUXE MODELS

Enhance the nostalgic solo look by replacing the Softail Deluxe model's Original Equipment Passenger Pillion and luggage rack with this decorative fender cover. Form-fitted to hug the contour of the rear fender, this decorative fender cover hides the passenger pillion and luggage rack mounting holes that are exposed when riding with a solo seat. Styled to match the Original Equipment solo seat, the Fender Bib features a textured basket weave leather insert to complete the nostalgic look. The molded base is finished with a soft felt under-liner designed to protect the fender's painted surface.

**52018-08** **\$69.95**

Fits '05-later FLSTN models equipped with Original Equipment rider seat.

### D. REAR FENDER BIB – FAT BOY® MODELS

Complete the stripped-down solo look by replacing the Fat Boy model's Original Equipment Passenger Pillion with this decorative fender cover. Form-fitted to hug the contour of the rear fender, this decorative fender cover hides the passenger pillion mounting holes that are exposed when riding with a solo seat. Styled to match the Original Equipment solo seat, the Fender Bib features a textured leather insert to complete the custom look. The molded base is finished with a soft felt under-liner designed to protect the fender's painted surface.

**52038-08** **\$69.95**

Fits '07-later FLSTF and FLSTFB models equipped with Original Equipment rider seat.



A. CIRCULATOR SEAT PADS



B. TANK BRA FOR SOFTAIL MODELS

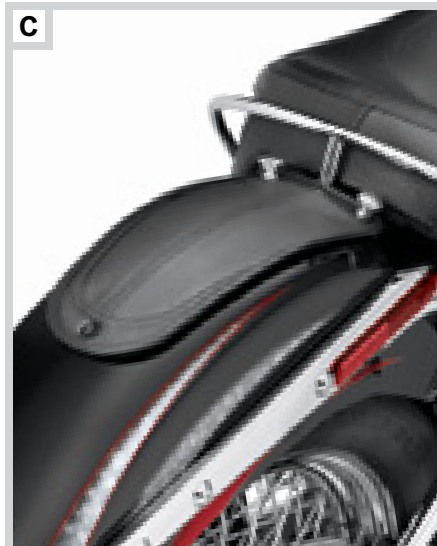

C. REAR FENDER BIB – SOFTAIL DELUXE MODELS

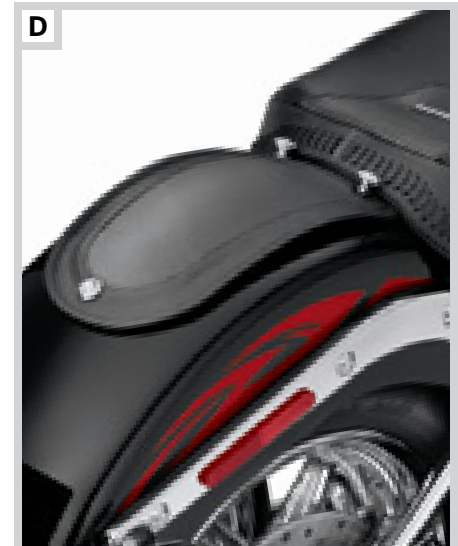

D. REAR FENDER BIB – FAT BOY MODELS



E. PASSENGER GRAB RAIL – FXSTC SHOWN



E. PASSENGER GRAB RAIL – FLSTC SHOWN



F. PASSENGER HANDRAIL COVERS



G. RAIN COVER – TWO-UP SEAT



H. CHROME BILLET SEAT MOUNTING BRACKET



I. DETACHABLE SEAT HARDWARE KIT

**E. PASSENGER GRAB RAIL**

Add comfort and confidence for your riding companion. Chrome-plated handrail provides a convenient hand grip for your passenger, and a secure tie-down point for pillion-mounted touring luggage. For custom look, add Passenger Handrail Covers P/N 91668-05 (*sold separately*).

**97036-09** **\$119.95**

Fits '06-later FXST, FXSTB, FXSTC, FXSTS, and '07-'08 FXSTSSE/2 models.

**97031-09** **\$119.95**

Fits '06 FLSTF and '06-later FLST, FLSTC, and FLSTSC models.

**F. PASSENGER HANDRAIL COVERS**

Beef up the look of the passenger handrail with these easy-to-install chrome-plated grips. The thick diameter offers a firm and comfortable hand hold for your passenger, and features jet black rubber inserts, "ball-milled" grooves and Bar & Shield logo for added style. Kit includes right and left grip and stainless steel mounting hardware.

**91668-05** **\$54.95**

Fits '06-later Dyna®, Softail® and '99-later Touring models equipped with Accessory Passenger Grab Rails.

**G. RAIN COVERS\***

Featuring a handy storage sack, this black nylon, water-resistant, Cordura® cover packs easily and shelters your seat from the storm.

**Two-up Seat**

**51637-97** **\$29.95**

Fits H-D® two-up seats (except XR, FLSTS and Softail Seats with Rider Backrests).

**Solo Seat (not shown)**

**51638-97** **\$29.95**

Fits H-D solo seats (except XR and FLSTS).

**Touring Seat (not shown)**

**51639-97** **\$29.95**

Fits FLSTS and most Touring seats. Does not fit with Rider or Passenger Backrests.

**H. CHROME BILLET SEAT MOUNTING BRACKET**

The highly stylized design of this bracket adds a stunning look to the back of most seats.

**51804-02** **\$19.95**

Replaces bolt-on Seat Brackets P/N 51798-00, 51652-97 and 51652-83B used on most Original Equipment and accessory seats and pillions. See parts catalog or instruction sheet for your application.

**I. DETACHABLE SEAT HARDWARE KIT**

These hardware kits allow the rider to remove one-piece Harley-Davidson® seats quickly and easily.

**51676-97A** **\$19.95**

Fits '97-later XL, Dyna, Softail and Touring models. Does not fit seats equipped with spring-loaded rear seat bracket.

**51676-96** **\$24.95**

Fits '96 XL, FXST, FXSTS and Dyna models with two-up, one-piece seats.



**\*WARNING:** Do not use while riding; could result in death or serious injury.

Notice: The prices appearing in this catalog are the manufacturer's suggested retail prices. Actual retail prices may vary.

# SOFTAIL® BACKRESTS & RACKS

## COMFORT ON THE GO

*With a detachable backrest and luggage rack, your bike can go from a stripped-down after-noon cruiser to a fully loaded two-up touring machine in seconds. Comfort- and convenience-driven accessories make for a less stressful ride.*

### THE RIGHT COMBINATION

#### BUILD YOUR OWN

*A detachable sissy bar upright and backrest pad is the starting point for a complete touring machine. Start by shopping the following pages and selecting all the components required for your particular model.*



#### ALL IN ONE PIECE

*When brought together, the sideplates, upright, pad and luggage rack form a complete assembly that can be installed or removed from your bike in seconds.*

### EQUIPPED FOR THE MILES AHEAD

Solo and stripped down, two-up and fully loaded, or anywhere in between, you can tailor any Harley-Davidson® motorcycle to meet the demands of the byways.

#### SOLO

*Go it alone in style. Saddlebags hold a change of clothes, a rain suit and the basic travel gear. A Solo Rack and soft bag can store any souvenirs you pick up along the way.*

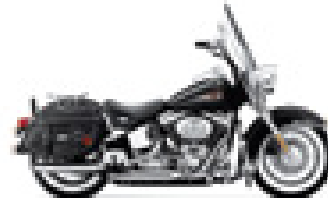

#### TWO-UP

*Take a day's ride on a bike built for two. Saddlebags carry clothes and the essentials, while a Sissy Bar Backrest Pad provides hours of passenger comfort on the open road.*



#### SOLO WITH TOUR-PAK®

*Ride like you're on a mission. The saddlebags and Tour-Pak offer tons of storage space, and the Solo Mounting Rack positions the Tour-Pak Pad for maximum rider back support.*



#### TWO-UP WITH TOUR PAK®

*The ultimate road trip. With all this space and comfort, you and one lucky passenger are fully-equipped to go wherever you want, for as long as you want.*



### CHANGING YOUR BACKREST

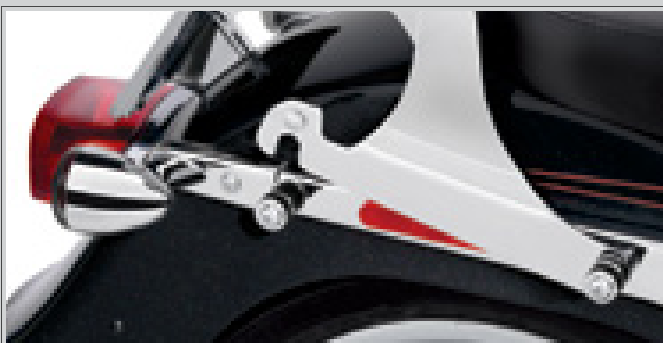

With a Docking Hardware Kit installed, adding or removing a Detachable accessory is a simple "slide and click" proposition. Rotate the cam-lock to release the sissy bar from the rear docking points. Pivot the sissy bar forward, and lift it free from the front docking points.





## Choosing a Backrest

A sissy bar upright and passenger backrest are the starting point to build a complete touring machine. The backrest provides long-range comfort and support, and adds a feeling of control and confidence for the passenger. For permanent installation, choose rigid sideplates and a style of upright that suits your riding style. For added flexibility, choose a detachable sideplate kit and appropriate Docking Hardware to make adding or removing a Detachable accessory a simple "slide and click" proposition.

### GENUINE HARLEY-DAVIDSON® SIDEPLATES

Add your choice of sissy bar uprights, backrest pads and luggage racks when you install rigid or detachable sideplates to your motorcycle. Manufactured and tested to rigorous Harley-Davidson standards, these sideplates are designed to specific model application for exact fit.

#### RIGID MOUNT SIDEPLATES

Fits '00-later FXST, FXSTB, FXSTS, FLSTF, FLSTFB, '05-'06 FLSTN, '06 FLSTFSE2 and '07-later FXSTC and FLSTSB models. '07-later FXSTC models require separate purchase of fender-mounted seat. '00-'02 models require separate purchase of Hardware Kit P/N 53388-03.

<b>53378-03A</b> Chrome.	<b>\$84.95</b>
<b>53387-03A</b> Wrinkle Black.	<b>\$84.95</b>

Fits '00-later FLSTC, '00-'03 FLSTS, '05-'07 FLSTSC, '06 FLST and '07-later FLSTN models. '00-'02 models require separate purchase of Hardware Kit P/N 53388-03.

<b>53374-03</b> Chrome.	<b>\$84.95</b>
-------------------------	----------------

Fits '97-'99 FLSTS, '84-'99 FXSTC, FXSTS and '98-'99 FXSTB models.

<b>1. 52786-84B</b> Chrome.	<b>\$94.95</b>
-----------------------------	----------------

Fits '86-'99 FLSTC, FLSTF, FLSTN models (except FLSTS).

<b>2. 52791-86A</b> Chrome.	<b>\$94.95</b>
-----------------------------	----------------

#### Rigid Sideplate Hardware Kit

Hardware kit is required to install Rigid Sideplates P/N 53378-03A, 53374-03 and 53387-03A on '00-'02 models.

<b>53388-03</b>	<b>\$4.95</b>
-----------------	---------------

#### DETACHABLE SIDEPLATES

Fits '00-later FXST, FXSTB, FXSTS, FXSTSSE/2/3, FLSTFSE2, FLST, FLSTF, FLSTFB, FLSTN, FLSTSB, FLSTSC models with or without saddlebags (except Heritage Saddlebags P/N 90876-05). Requires separate purchase of Docking Hardware Kit and may require Directional Relocation Kit. See chart for your application.

<b>3. 53810-00B</b> Chrome.	<b>\$139.95</b>
<b>4. 53857-00B</b> Wrinkle Black.	<b>\$139.95</b>
<b>5. 54258-10</b> Gloss Black.	<b>\$139.95</b>

Fits '00-later FLSTC and '00-'03 FLSTS models. Also fits '05-later FLST, FLSTSC models with Heritage Saddlebag P/N 90876-05. Requires separate purchase of Docking Hardware Kit and may require Directional Relocation Kit. See chart for your application.

<b>53815-00</b> Chrome.	<b>\$139.95</b>
-------------------------	-----------------

Fits '84-'99 Softail® models (except FLSTS). Requires separate purchase of Docking Hardware Kit and may require Directional Relocation Kit. See chart for your application.

<b>53549-95</b> Chrome.	<b>\$154.95</b>
-------------------------	-----------------

*Notice: The prices appearing in this catalog are the manufacturer's suggested retail prices. Actual retail prices may vary.*

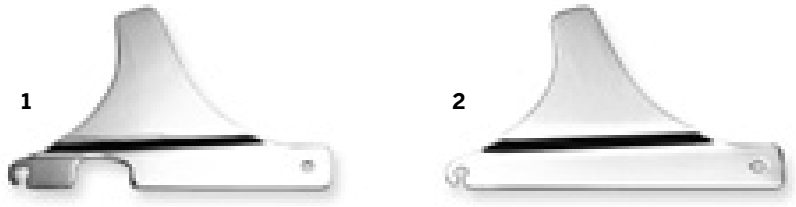

RIGID MOUNT SIDEPLATES



Chrome

Wrinkle Black



Gloss Black

DETACHABLE SIDEPLATES



BUILD YOUR COMPLETE PASSENGER BACKREST SYSTEM

# 232 SOFTAIL®

Backrests & Racks

## Select a Height



Tall



Low

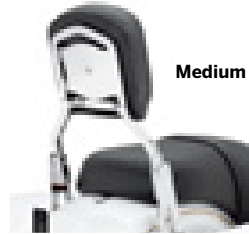

Medium Low



Short



Mini

### Tall Sissy Bar Uprights

Let your passenger ride tall in the saddle with a Tall Sissy Bar Upright. This upright provides maximum upper back support when equipped with your choice of Backrest Pad.

### Low Sissy Bar Uprights

Give your passenger additional back support with a Low Sissy Bar Upright, designed to accept a wide variety of backrest pads.

### Medium Low Sissy Bar Upright

Shaped to complement a thicker passenger pillion, this Sissy Bar Upright stands between the Low and Short Sissy Bar Upright. The ideal match for touring style seats, this upright also offers an additional height option to riders with custom style seats.

### Short Rail Sissy Bar Upright

This Sissy Bar Upright is lower than traditional low uprights and the hidden Backrest Pad Mounting System allows for a sleek look when the pad is removed.

### Mini Rail Sissy Bar Upright

Unique hidden Backrest Pad attachment makes for ultra-clean look with pad removed. NOTE: Must only be installed on models equipped with Badlander®, Stripper®, Sidekick®, Sidekick Custom and Rallyrunner® Style Seats.

## Select a Style



Medallion Style



Insert Style

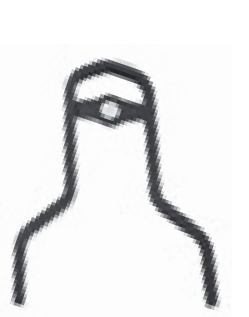

Mini Medallion Style

## Select a Finish

### Square Tube Upright

*Fits '84-'05 Softail® models (except FXSTD) and '06-later FL Softail models (except '06 FLSTFSE2, '07-later FLSTF, FLSTFB, FLSTSE and FLSTS) with appropriate sideplates.*

*Fits '06-later FXST, FXSTB, FXSTS, FLSTFSE2, '07-later FXSTC, FLSTF, FLSTFB, FXSTSSE/2, FLSTSE and FLSTS models with appropriate sideplates. '07-later FXSTC models require separate purchase of Fender Mounted Seat.*

Height	Style	Finish				
Mini		Chrome	52738-94A	\$64.95	—	—
Short		Chrome	52737-94A	\$69.95	—	—
Short		Wrinkle Black	53010-98	\$69.95	—	—
Short		Gloss Black	52706-07	\$69.95	—	—
Medium Low	Medallion	Chrome	52754-04	\$89.95	53282-06 Mini-Medallion	\$79.95
Medium Low	Medallion	Gloss Black	51851-09	\$92.95	—	—
Low	Insert	Chrome	52736-85A	\$89.95	—	—
Low	Medallion	Chrome	52735-85	\$89.95	53281-06 Mini-Medallion	\$89.95
Low	Medallion	Wrinkle Black	53007-98	\$89.95	53407-06 Mini-Medallion	\$89.95
Low	Heritage	Chrome	52731-00	\$84.95	—	—
Tall	Insert	Chrome	53552-81A	\$94.95	—	—
Tall	Medallion	Chrome	52749-85A	\$94.95	—	—

### Round Tube Custom Upright

*Fits '09 FXSTSSE3 models with appropriate detachable sideplates.*

*Fits '06-later FXST, FXSTB, FXSTS, FLSTFSE2, '07-later FXSTC, FLSTF, FLSTFB, FXSTSSE/2, FLSTSE and FLSTS models with appropriate sideplates. '07-later FXSTC models require separate purchase of Fender Mounted Seat.*

Height	Style	Finish				
Medium Low	Mini Medallion	Chrome	52540-09	\$129.95	51477-06	\$99.95
Medium Low	Mini Medallion	Gloss Black	—	—	54256-10	\$99.95

**1984 – 1999 Softail® Docking Hardware for Detachable Racks, Handrails & Sideplates**

Docking hardware fitment is dependent on vehicle model and saddlebag configuration.

Detachable Accessory	Available to fit:	Detachable Sideplate			Docking Hardware		Directional Relocation Kit	
		Chrome	Black	One-Piece				
Detachable Sideplates 53549-95 and Saddlebags: Heritage Style 90835-90C	1984-1999 FLSTC	53549-95	—	—	53371-95A	\$44.95	Not Required	
Detachable Sideplates; 53549-95 and Saddlebags: Fat Boy®, 90381-98	1984-1999 FLSTC 1993-1996 FLSTN	53549-95	—	—	53370-95B	\$44.95	Not Required	
Detachable Sideplates; 53549-95 and Saddlebags: Fat Boy, 90381-98, 90833-90C	1984-1999 FXSTS, FXSTC, FLSTF	53549-95	—	—	53370-95B	\$44.95	53692-96	\$49.95
Detachable Sideplates; 53549-95 only	1984-1999 FLSTC, FXSTS, FXSTC, FLSTF	53549-95	—	—	53531-95A	\$39.95	Not Required	
Detachable Sideplates; 53549-95 only	1984-1999 FXSTSB,	53549-95	—	—	53531-95A	\$39.95	53692-96	\$49.95
Detachable Sideplates and Hard Saddlebags 90224-00xx	1987-1999 FLSTC	53549-95	—	—	53009-03 & 53531-95A	\$ 9.95 \$39.95	Included With Bags	
Detachable Sideplates and Hard Saddlebags 90225-00xx	1987-1999 FXST, FXSTC, FXSTS, FXSTB	53549-95	—	—	53009-03 & 53531-95A	\$ 9.95 \$39.95	Included With Bags	
Detachable Sideplates and Hard Saddlebags 90715-00xx	1990-1999 FLSTF	53549-95	—	—	53009-03 & 53531-95A	\$ 9.95 \$39.95	Included With Bags	

**2000 – later Softail Docking Hardware for Detachable Racks, Handrails, Tour-Pak Racks & Sideplates**

Docking hardware fitment is dependent on vehicle model and saddlebag configuration.

Detachable Accessory	Available to fit:	Detachable Sideplate			Docking Hardware		Directional Relocation Kit	
		Chrome	Black	One-Piece				
<b>No Saddlebags</b> Detachable Sideplates 53810-00B (Chrome), 53857-00B (Black), Solo Detach Rack 53649-05 (Chrome), 53612-08, 53652-05 (Black), One-Piece Detach Sissy Bar Upright P/N 53618-05, Solo Detach Tour-Pak Rack 53559-04A, or Detachable Tour-Pak Rack 53066-00B	2000-2001 FXST, FXSTB, FXSTS, FLSTF	53810-00B	53857-00B	53618-05	53824-00	\$39.95	53820-00	\$39.95
	2002 FXST, FXSTB, FXSTS, FLSTF	53810-00B	53857-00B	53618-05	53824-00	\$39.95	53859-02A	\$39.95
	2003-later FXST, FXSTB, FXSTS, FXSTSSE/2/3, FXSTC, FLSTF, FLSTFB, FLSTFSE2, FLSTSB	53810-00B	53857-00B	53618-05*	53932-03	\$39.95	53959-06 Chrome, 54268-10 Black.	\$39.95
	2005-later FLSTN, FLST	53810-00B	53857-00B	53618-05	53932-03	\$39.95	Not Required	
	2005-2007 FLSTSC	53810-00B	53857-00B	53618-05	53932-03	\$39.95	53959-06 Chrome, 54268-10 Black.	\$39.95
<b>With P&amp;A Saddlebags</b> Detachable Sideplates 53810-00B (Chrome), 53857-00B (Black), Solo Detach Rack 53649-05 (Chrome), 53612-08, 53652-05 (Black), One-Piece Detach Sissy Bar Upright P/N 53618-05, Solo Detach Tour-Pak Rack 53559-04A, Detachable Tour-Pak Rack 53066-00B	2000-2001 FXST, FXSTB, FXSTS, FLSTF	53810-00B	53857-00B	53618-05	53821-00	\$34.95	53820-00	\$39.95
	2002 FXST, FXSTB, FXSTS, FLSTF	53810-00B	53857-00B	53618-05	53821-00	\$34.95	53859-02A	\$39.95
	2003-later FXST, FXSTB, FXSTS, FXSTSSE/2, FXSTC, FLSTF, FLSTFB, FLSTFSE2, FLSTSB	53810-00B	53857-00B	53618-05	53930-03	\$34.95	53959-06 Chrome, 54268-10 Black.	\$39.95
<b>With P&amp;A Saddlebags</b> 53015-05, 53061-00A, 88237-07, 88238-07, 88263-07, 88286-07, 88306-07, 90058-05, 90114-00A, 90119-00A, 90130-00B, 90133-06B, 90320-00B, 90384-04, 90384-06, 90388-04, 90419-08, 91536-00A, 91537-00A, 91555-01A, 92000-00B and 92015-03	2005-later FLSTN, FLST	53810-00B	53857-00B	53618-05	53930-03	\$34.95	Not Required	
	2005-2007 FLSTSC	53810-00B	53857-00B	53618-05	53930-03	\$34.95	53959-06 Chrome, 54268-10 Black.	\$39.95
	2009 FXSTSSE3	53810-00B	53857-00B	—	53821-00	\$34.95	53959-06 Chrome, 54268-10 Black.	\$39.95
<b>With Original Equipment Saddlebags</b> Detachable Sideplates 53815-00 (Chrome), Solo Detach Rack 53649-05 (Chrome), 53652-05 (Black), Solo Detach Tour Pak Rack 53559-04A, or 2-up Detachable Tour Pak Rack 53066-00B with Original Equipment Saddlebags or with P&A Saddlebags P/N 90876-05	2000-2002 FLSTC	53815-00	—	—	53822-00	\$39.95	Not Required	
	2003-later FLSTC	53815-00	—	—	53931-03	\$39.95	Not Required	
	2000-2001 FLSTS	53815-00	—	—	53822-00	\$39.95	53820-00	\$39.95
	2002 FLSTS	53815-00	—	—	53822-00	\$39.95	53859-02A	\$39.95
	2003 FLSTS	53815-00	—	—	53931-03	\$39.95	53959-06 Chrome, 54268-10 Black.	\$39.95
	2005-2007 FLSTSC	53815-00	—	—	53931-03	\$39.95	53959-06 Chrome, 54268-10 Black.	\$39.95
	2006 FLST	53815-00	—	—	53931-03	\$39.95	Not Required	
Detachable Sideplates and Hard Saddlebags 90224-00XX	2000-2002 FLSTC	53810-00B	53857-00B	53618-05	53821-00 & 53009-03	\$34.95 \$ 9.95	Not Required	
	2003-later FLSTC	53810-00B	53857-00B	53618-05	53930-03 & 53075-03	\$34.95 \$24.95	Not Required	
	2005-later FLSTSC, FLST	53810-00B	53857-00B	53618-05	53930-03 & 53075-03	\$34.95 \$24.95	Included with Hard Saddlebags	
Detachable Sideplates and Hard Saddlebags 90225-00XX	2000-2002 FXST/S/B	53810-00B	53857-00B	53618-05	53821-00 & 53009-03	\$34.95 \$ 9.95	Included with Hard Saddlebags	
	2003-later FXST/S/B	53810-00B	53857-00B	53618-05	53930-03 & 53075-03	\$34.95 \$24.95	Included with Hard Saddlebags	
	2005 FLSTSC	53810-00B	53857-00B	53618-05	53930-03 & 53075-03	\$34.95 \$24.95	Included with Hard Saddlebags	
Detachable Sideplates and Hard Saddlebags 90715-00XX	2000-2002 FLSTF	53810-00B	53857-00B	53618-05	53821-00 & 53009-03	\$34.95 \$ 9.95	Included with Hard Saddlebags	
	2003-later FLSTF, FLSTFB,	53810-00B	53857-00B	53618-05	53930-03 & 53075-03	\$34.95 \$24.95	Included with Hard Saddlebags	
Detachable Sideplates and Hard Saddlebags 90725-00XX	2005-later FLSTN	53810-00B	53857-00B	53618-05	53930-03 & 53075-03	\$34.95 \$24.95	Not Required	

\*except FXSTSSE3 \*\*See fitment for Saddlebag Kits P/N 88237-07, 88238-07 or 88306-07

# 234 SOFTAIL®

## Backrests & Racks

### A. MINI RAIL BACKREST PAD – SMOOTH

Innovative mounting system features a brushed stainless steel insert framed with chrome plate and hardware.

**52513-94** Smooth. **\$49.95**

Fits XL, FXR, FXD, and Softail® models (except FXSTD) equipped with Badlander® seats, select low-profile seats and appropriate Mini Rail Sissy Bar Upright.

### B. SHORT RAIL BACKREST PAD

Innovative Backrest Pad Mounting System features a brushed stainless steel insert framed with chrome plate and hardware.

Fits Short Rail Sissy Bar Upright.

**52517-94** Smooth. **\$49.95**

### C. MEDIUM LOW BACKREST PADS

Styled to complement Original Equipment and accessory seats, these pads are sized to match the Medium Low Sissy Bar Upright. Backrest pads include chrome-plated mounting hardware.

Fits Medium Low Medallion Plate-Style Sissy Bar Upright.

**1. 52652-04** Smooth. **\$59.95**

**2. 52626-04** Smooth Top-Stitched. **\$59.95**

**3. 52656-04** Pillow-Look. **\$59.95**

### D. MEDIUM LOW CUSTOM UPRIGHT BACKREST PADS

Matches models with top-stitched seats.

Fits models equipped with Medium Low Round Sissy Bar Upright P/N 51477-06, 52540-09, 52877-10, 51168-10 or 54256-10.

**1. 51640-06** Smooth Bucket. **\$89.95**

**2. 51641-06** Smooth Top-Stitched. **\$59.95**

**3. 51642-06** Smooth French Seam. **\$69.95**

### E. MEDIUM LOW TOURING BACKREST PAD – FAT BOY® STYLING

Features large bucket shape, with a generous radius and ample padding. This backrest pad offers extra comfort for your passenger.

**51622-07** **\$109.95**

Fits models equipped with Medium Low Round Sissy Bar Upright P/N 51477-06, 52540-09, 52877-10, 51168-10 or 54256-10.

### F. Sissy Bar Upright Slip-Over Backrest Pads

Slip-on for passenger comfort. Easily removed to show off chrome sissy bar upright.

**1. 52563-82** Fits Tall Sissy Bar Upright. **\$59.95**

**2. 91819-85** Fits Low Sissy Bar Upright. **\$59.95**



A. MINI RAIL BACKREST PAD – SMOOTH



B. SHORT RAIL BACKREST PAD – SMOOTH

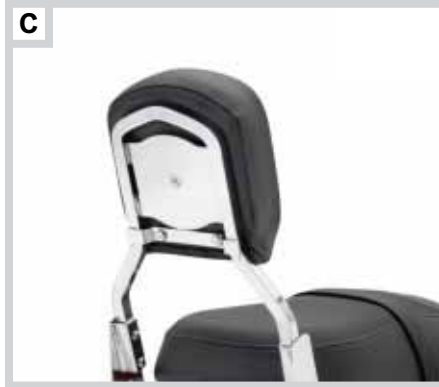

C. MEDIUM LOW BACKREST

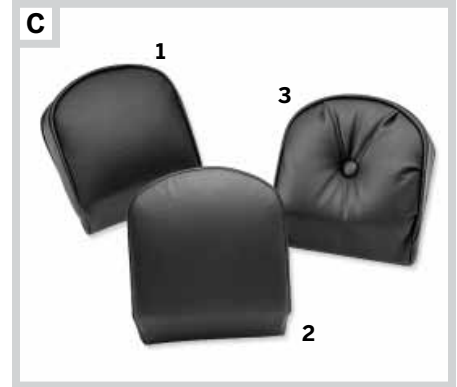

C. MEDIUM LOW BACKREST PADS



D. MEDIUM LOW CUSTOM UPRIGHT



D. MEDIUM LOW CUSTOM UPRIGHT BACKREST PADS



E. MEDIUM LOW TOURING BACKREST PAD – FAT BOY STYLING



F. Sissy Bar Upright Slip-Over Backrest Pads

Notice: The prices appearing in this catalog are the manufacturer's suggested retail prices. Actual retail prices may vary.





**G. LOW BACKREST PAD – TOP-STITCHED**



**H. LOW BACKREST PADS**



**I. LOW BACKREST PADS**

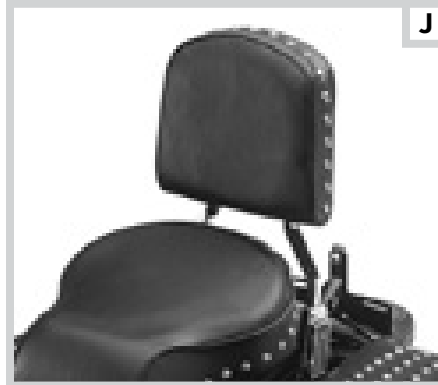

**J. LOW BACKREST PAD – CHROME-STUDED**



**K. LOW BACKREST PAD – SMOOTH BUCKET**



**L. LOW BACKREST PAD – HERITAGE SOFTAIL CLASSIC BUCKET**

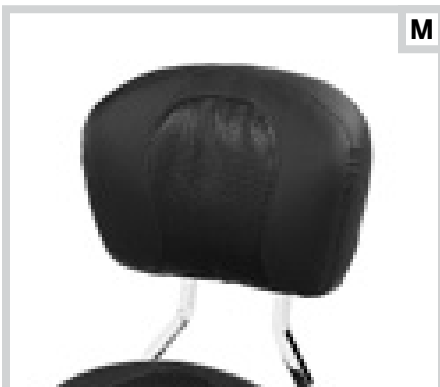

**M. LOW BACKREST PAD – FAT BOY BUCKET**



**N. TALL BACKREST PADS**

**G. LOW BACKREST PAD**

Includes all necessary mounting hardware.

Fits Low Medallion Plate-Style Sissy Bar Upright.

**52612-95** Smooth Top-Stitched. **\$59.95**

**H. LOW BACKREST PADS**

Includes all necessary mounting hardware.

Fits Low Medallion Plate-Style Sissy Bar Upright.

**1. 52412-79A** With Embossed Bar & Shield Logo. **\$59.95**

**2. 52545-84** Pillow-Look. **\$59.95**

**I. LOW BACKREST PAD**

**1. Fat Boy®**

Includes mounting bracket, hardware and installation instructions.

**52532-90** **\$69.95**

Fits Low Medallion Plate-Style Sissy Bar Upright.

**2. FX Softail®**

**52087-98** **\$59.95**

Fits Low Medallion Plate-Style Sissy Bar Upright.

**J. LOW BACKREST PAD – CHROME-STUDED**

Nothing brings out the nostalgic look of Softail models more than a few well-placed chrome studs. Styled to match your stock FLSTC models with Chrome Spots.

**52512-02** **\$69.95**

Fits Low Medallion Plate-Style Sissy Bar Upright.

**K. LOW BACKREST PAD – SMOOTH BUCKET**

Features large bucket shape, with a generous radius and ample padding. This backrest pad offers extra comfort for your passenger.

**51132-98** **\$89.95**

Fits Low Medallion Plate-Style Sissy Bar Upright.

**L. LOW BACKREST PAD – HERITAGE SOFTAIL® CLASSIC BUCKET**

The bucket backrest pad is taller and wider than the stock pad. The foam contours to the lower back to provide added comfort for those long rides. Features chrome spots and includes all mounting hardware.

**52348-97** **\$99.95**

Fits Low Medallion Plate-Style Sissy Bar Upright.

**M. LOW BACKREST PAD – FAT BOY® BUCKET**

This bucket backrest pad is taller and wider than a traditional pad, and the foam contours to the back for added comfort on those long hauls.

**52347-97** **\$99.95**

Fits Low Medallion Plate-Style Sissy Bar Upright.

**N. TALL BACKREST PADS**

Quality backrest pads include chrome-plated mounting brackets and hardware.

Fits Tall Insert-Style or Medallion Plate-Style Sissy Bar Upright.

**1. 52965-98** Smooth Top-Stitched. **\$69.95**

**2. 91770-85** Pillow-Look. **\$69.95**

*Notice: The prices appearing in this catalog are the manufacturer's suggested retail prices. Actual retail prices may vary.*

# 236 SOFTAIL®

Backrests & Racks

## A. ONE-PIECE DETACHABLE PASSENGER SISSY BAR UPRIGHT – GLOSS BLACK

The sweeping shape and gloss black finish of this slim solid bar Passenger Upright complements the classic “bobber” look of the Softail® Cross Bones™ model. The one-piece design eliminates separate sideplates for a clean appearance, and the stylized upper kick angle mimics the old-school sissy bars of the 50s and 60s. Can be used with Passenger Bracket Pad P/N 52631-07.

**52729-08 \$199.95**

Fits '06-later FXST, FXSTB, FXSTC, FXSTS and '07-later FLSTF, FLSTFB, FLSTSB and FLSTSE models. Requires separate purchase of Docking Hardware Kit and may require Turn Signal Relocation Kit. See Docking Hardware Fitment Chart for your application.

## B. PASSENGER BACKREST PAD

Styled to complement available touring and custom seats, this pad fits the Original Equipment FXSTC sissy bar upright.

**52631-07 \$59.95**

Fits models equipped with Sissy Bar Upright P/N 52729-08, 51853-07 or 51849-07.

## C. ONE-PIECE DETACHABLE PASSENGER SISSY BAR UPRIGHT – CHROME

The sweeping shape of this slim solid bar Passenger Upright accents the nostalgic lines of the Softail® Deluxe model, and the one-piece design eliminates separate sideplates for a clean design. The chrome Detachable Upright accepts Backrest Pads P/N 53928-05, 51587-05, and 51687-06, and features a stylized Bar & Shield cross-brace.

**53618-05 \$259.95**

Fits '00-'05 FXST, FXSTB, FXSTS, '00-'06 FLSTF (except FLSTFSE2) and '05-later FLST, FLSTN and FLSTSC models. Fits with or without saddlebags. Does not fit with Heritage Saddlebags P/N 90876-05. Requires separate purchase of appropriate Docking Hardware Kit and may require Directional Relocation Kit.

## D. SHORT BACKREST PAD FOR SOFTAIL ONE-PIECE UPRIGHT

Styled to complement the Softail® Deluxe Original Equipment seat and passenger pillion, this Short Backrest Pad hugs the contour of the one-piece upright.

**53928-05 \$59.95**

Fits models equipped with One-Piece Passenger Upright P/N 53618-05.

## E. TALL BACKREST PAD FOR SOFTAIL® ONE-PIECE UPRIGHT

Styled to complement your Softail model Original Equipment seat and passenger pillion, this Tall Backrest Pad delivers additional passenger support for the run across town or across the country. Combine with a matching Touring Passenger Pillion for maximum comfort.

Fits models equipped with One-Piece Passenger Upright P/N 53618-05.

**51687-06 Smooth. \$79.95**

**51587-05 Softail Deluxe Pattern. \$79.95**



A. ONE-PIECE DETACHABLE PASSENGER SISSY BAR UPRIGHT – GLOSS BLACK



B. PASSENGER BACKREST PAD



C. ONE-PIECE DETACHABLE PASSENGER SISSY BAR UPRIGHT – CHROME



D. SHORT BACKREST PAD FOR SOFTAIL ONE-PIECE UPRIGHT

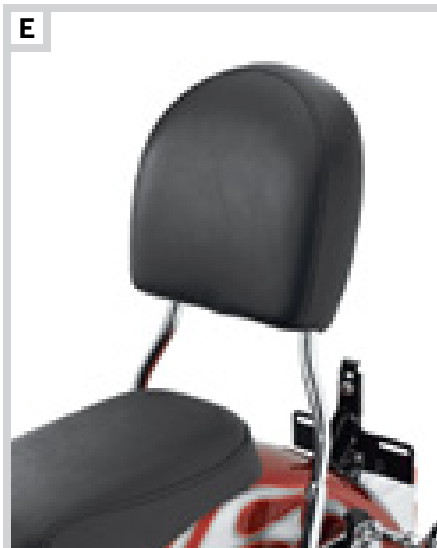

E. TALL BACKREST PAD FOR SOFTAIL ONE-PIECE UPRIGHT – SMOOTH



E. TALL BACKREST PAD FOR SOFTAIL ONE-PIECE UPRIGHT – SOFTAIL DELUXE PATTERN

Notice: The prices appearing in this catalog are the manufacturer's suggested retail prices. Actual retail prices may vary.



F. CUSTOM MEDIUM LOW SISSY BAR UPRIGHT – FXSTSSE3

**F. CUSTOM MEDIUM LOW SISSY BAR UPRIGHT**

Sweeping curves and a brilliant chrome finish add a custom look to this practical Sissy Bar Upright. Designed to complement the fender lines of the wide tire FX Softail models, the solid round bar mini medallion upright features a stylish Bar & Shield logo.

**52540-09** Mini Rail. **\$129.95**

Fits '09 FXSTSSE3 models. Requires separate purchase of Detachable Sideplates P/N 53810-00B. Does not fit with rigid sideplates. See Docking Hardware matrix for additional requirements.

**G. CHROME BACKREST MOUNT**

Chrome-plated backrest mount with hidden fasteners. Allows the mounting of sissy bar medallions or can be used as is for a clean look.

**52527-01** Mini Rail. **\$25.95**

Fits XL, Dyna®, and Softail® models equipped with Harley-Davidson® Mini Sissy Bar Upright and matching Backrest Pad.

**52531-01** Short Rail. **\$25.95**

Fits XL, Dyna, and Softail models equipped with Harley-Davidson Short Sissy Bar Upright and matching Backrest Pad.



G. CHROME BACKREST MOUNT – SHORT RAIL



H. DETACHABLES LOCK

**H. DETACHABLES LOCK**

Now you can have the convenience of Detachables with the security of barrel locks. This unique lock replaces the cam-lock on your Harley-Davidson® Detachable accessories, providing additional security and peace-of-mind when parking your vehicle. Kit includes two extended-reach barrel-style keys for easy access to the lock. Designed exclusively by Harley-Davidson. Key registration\* and replacement service is available.

Fits models equipped with Detachable Sideplates, Racks and Tour-Pak® Luggage Carriers (except '09-later Touring models equipped with Detachable Solo Tour-Pak® Rack).

**46063-98** Single. **\$46.95**

~~**46106-00** Set of Two. **OBSOLETE** **\$89.95**~~

\*Key Registration and Replacement Service: This service is provided by the lock manufacturer. Information is included in the product packaging.

**I. REAR DOCKING HARDWARE COVER KIT**

Disguise the rear docking hardware with these easy-to-install covers. The caps slide over the exposed docking points, and are held in place by a strong magnetic pull. The caps are easy to remove when you wish to reinstall detachable accessories. Covers are available with brilliant Chrome or durable Gloss Black finish to match your bike's attitude (*sold in pairs*).

Fits many accessory docking hardware kits. Refer to the fitment matrix in the P&A Catalog page 543 or the Parts & Accessories section of [www.harley-davidson.com](http://www.harley-davidson.com) for details.

**48218-10** Short Chrome (*pair*). **\$24.95**

**48220-10** Large Chrome (*pair*). **\$24.95**

**48035-09** Small Chrome (*pair*). **\$24.95**

**48221-10** Short Black (*pair*). **\$24.95**

**48223-10** Large Black (*pair*). **\$24.95**

**48225-10** Small Black (*pair*). **\$24.95**



I. REAR DOCKING HARDWARE COVER KIT – CHROME



I. REAR DOCKING HARDWARE COVER KIT – BLACK

# 238 SOFTAIL®

Backrests & Racks

## A. SOFTAIL® DEUCE™ CHROME PASSENGER Sissy BAR UPRIGHTS

The Deuce model was designed to accept this chrome-plated upright without the need for sideplates, providing a clean look. The design allows the upright to be mounted directly to the fender, giving the appearance that the upright comes right out of the seat. Easily removable, the upright offers you an instant option of stock Original Equipment look. Mounting hardware installs in minutes, and is hidden from view by a unique cut-out in the passenger pillion base.

Fits '00-'07 FXSTD models.

<b>51114-00</b>	Standard-Height.	<b>\$79.95</b>
<b>51144-02</b>	Tall.	<b>\$94.95</b>

## B. SHORT BACKREST PAD FOR SOFTAIL® DEUCE™

Styled to complement the Badlander® and Snakeskin seats for Softail Deuce models.

**51534-00** **\$49.95**

Fits '00-'07 FXSTD models equipped with Passenger Sissy Bar Upright P/N 51114-00.

## C. TALL BACKREST PAD FOR SOFTAIL DEUCE

This taller backrest pad is designed to give the passenger more back support for the long haul. Works with the Tall Upright P/N 51144-02.

**51099-02** **\$59.95**

Fits '00-'07 FXSTD models equipped with Deuce Tall Upright P/N 51144-02.

## D. TOURING PASSENGER BACKREST PAD FOR SOFTAIL DEUCE

Together with the Sundowner™ Deep Bucket Seat for Softail Deuce model P/N 51112-00B, this backrest passenger pad provides additional support for the long haul with a wide radius backrest.

**52050-00** **\$79.95**

Fits '00-'07 FXSTD models equipped with Passenger Sissy Bar Upright P/N 51114-00.

## E. SOFTAIL® DEUCE™ CHROME LUGGAGE RACK\*

This chrome-plated luggage rack is styled after the Deuce model's unique console and mounts easily to the passenger upright with two bolts. For convenience, the rack is easily removable using simple tools. Requires installation of Passenger Upright Kit P/N 51114-00 or 51144-02.

**53806-00** **\$149.95**

Fits '00-'07 FXSTD models equipped with Passenger Sissy Bar Upright P/N 51114-00 or 51144-02.



A. SOFTAIL DEUCE CHROME PASSENGER Sissy BAR UPRIGHTS

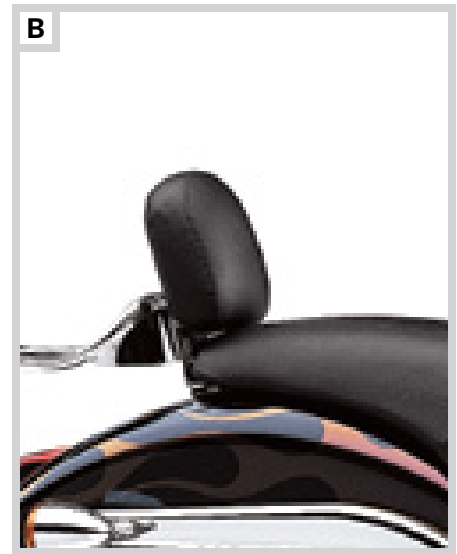

B. SHORT BACKREST PAD FOR SOFTAIL DEUCE

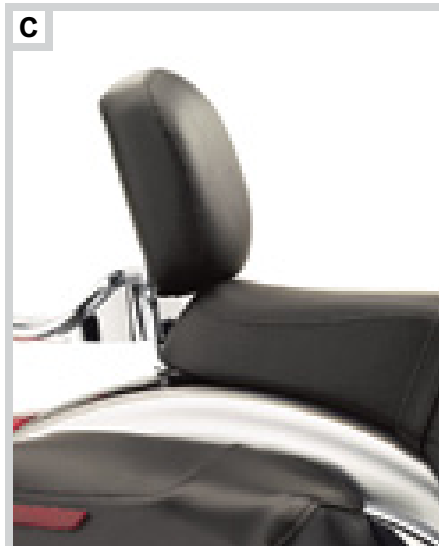

C. TALL BACKREST PAD FOR SOFTAIL DEUCE

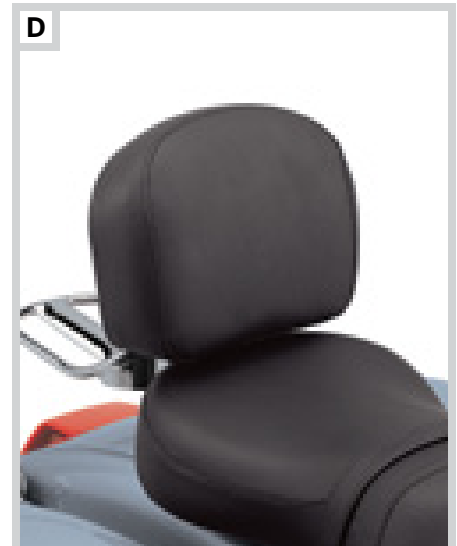

D. TOURING PASSENGER BACKREST PAD FOR SOFTAIL DEUCE



E. SOFTAIL DEUCE CHROME LUGGAGE RACK



**\*WARNING:** Do not use this rack as a seat. Do not exceed the fender rack weight capacity. Using as seat or exceeding this capacity could cause handling problems which could result in loss of control and death or serious injury.

Notice: The prices appearing in this catalog are the manufacturer's suggested retail prices. Actual retail prices may vary.





**F. TOURING SYSTEM STRUT KIT (SHOWN WITH PASSENGER PILLION, UPRIGHT, SOLO LUGGAGE RACK AND PASSENGER BACKREST PAD)**

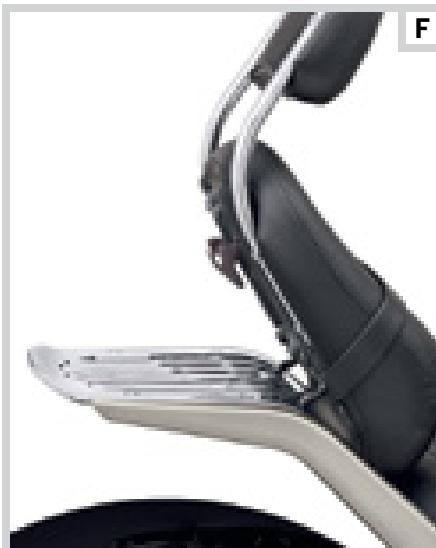

**F. PASSENGER PILLION FOR FXCW MODELS (SHOWN REMOVING THE PASSENGER BACKREST AND PILLION)**



**G. FXCW SOLO LUGGAGE RACK**

F

#### F. TOURING SYSTEM STRUT KIT

Although the Rocker™ model is built for solo riding, it can also make a radical touring machine. This forged steel support structure is designed to accept both the Solo Luggage Rack and the Passenger Pillion System (*sold separately*) for maximum flexibility. The complete structure can be installed or removed in seconds with simple tools, so you can go from stripped-down to two-up whenever the mood strikes.

**53935-08 \$199.95**

Fits '08-'09 FXCW. Requires separate purchase of Solo Rack P/N 53957-08. Can be installed with Saddlebag P/N 90240-08 with additional purchase of Installation Kit P/N 90233-08.

#### Shown with:

##### PASSENGER PILLION FOR FXCW MODELS

Styled to complement the stock seat, this Passenger Pillion delivers maximum passenger comfort for the long haul or around-town riding. The Pillion is easily removable with simple finger-turn clamps.

**52959-08 \$169.95**

Fits '08-'09 FXCW. Installation requires separate purchase of Touring System Strut Kit P/N 53935-08 and Solo Luggage Rack P/N 53957-08. Requires separate purchase of Passenger Footpeg Support Kit P/N 51039-05, (2) Screw P/N 4454, (2) Spring Washer P/N 50912-72 and passenger footpegs. Pad width 9.5" front; 8" rear.

#### Also shown with:

##### FXCW PASSENGER SISSY BAR UPRIGHT

Styled to blend with the sleek look of the Rocker model, this chrome-plated upright attaches directly to the Passenger Pillion for a clean look. Combine with Back Rest Pad P/N 51782-07 for a complete touring system.

**52804-08 \$59.95**

Fits '08-'09 FXCW. Installation requires separate purchase of Passenger Pillion Pad P/N 52959-08.

#### Also shown with:

##### SMOOTH LOOK PASSENGER BACKREST PAD

This backrest sports a smooth, clean finish that looks great with any smooth surface seat.

**51782-07 \$69.95**

Fits '07-later VRSC™ (except VRSCF). '06-'07 VRSCR and '06 VRSCSE2 models equipped with Low Sissy Bar Upright P/N 51162-06 or 51313-07. Also fits FXCW models equipped with Sissy Bar Upright P/N 52804-08, and Dyna models equipped with Sissy Bar Upright P/N 52796-09.

#### G. FXCW SOLO LUGGAGE RACK\*

This Luggage Rack is the ideal option for your ride across town or across the state. Designed for the Rocker model, this chrome-plated luggage rack features slots and beveled edges for a simple but stylish look. The rack is machined from aluminum and formed to match the sweeping contour of the Touring System Strut Kit P/N 53935-08. Rack also accepts the Passenger Pillion P/N 52959-08 and Sissy Bar Upright P/N 52804-08 to form a complete touring system.

**53957-08 \$169.95**

Fits '08-'09 FXCW models. Installation requires separate purchase of Touring System Strut Kit P/N 53935-08.



**\*WARNING:** Do not use this rack as a seat. Do not exceed the fender rack weight capacity. Using as seat or exceeding this capacity could cause handling problems which could result in loss of control and death or serious injury.

*Notice: The prices appearing in this catalog are the manufacturer's suggested retail prices. Actual retail prices may vary.*

# 240 SOFTAIL®

Backrests & Racks

## A. FXCWC DETACHABLE SOLO LUGGAGE RACK\*

This Detachable Solo Luggage Rack is designed to mount in the same location as the Trick-Seat™ of the Rocker™ C model. The convenient Solo Rack is machined from aluminum and features slots and beveled edges to produce a simple but stylish look. The brilliant chrome-plated Solo Rack can be stored in place of the passenger pillion in the pocket under the hinged rider's seat when not in use, and can be installed in seconds without tools.

**53989-08** Fits '08-later FXCWC models. **\$199.95**

## B. TAPERED LUGGAGE RACK\*

Styled to enhance the lines of the motorcycle, this sleek, compact Tapered Rack is an elegant solution for carrying your lunch to work or your luggage across the country.

Fits '04-later XL models equipped with Detachable Sideplates, '06-later Dyna® models (except FXDF, FXDFSE/2 and '10 FXDWG) equipped with Rigid or Detachable Sideplates, '00-'05 Softail® models (except FXSTD and FLSTN) and '06-later FLST, FLSTC and FLSTSC models equipped with Detachable or Rigid Mount Sideplates.

**53718-04** Chrome. **\$119.95**

**53510-07** Gloss Black. **\$119.95**

## C. CUSTOM TAPERED SPORT LUGGAGE RACK\*

Smooth sweeping curves and the brilliant chrome or gloss black finish define the look of this Sport Luggage Rack. Designed to complement the Medium Low Upright P/N 54256-10, 51477-06 or 52540-09, the rack adds a practical and stylish touch to the new wide tire FX Softail models.

Fits '06-later FXST, FXSTB, FXSTS, FLSTFSE2 and '07-later FXSTC, FLSTF, FLSTFB, FXSTSSE/2, FLSTSE and FLSTSB models with Detachable Sideplates or Rigid Mount Sideplates and Sissy Bar Upright. '07-later FXSTC models require separate purchase of Fender Mounted Seat.

**53953-06** Chrome. **\$129.95**

**54263-10** Gloss Black. **\$129.95**

Fits '09 FXSTSSE3 models. Requires separate purchase of Detachable Sideplates, Custom Medium Low Sissy Bar Upright P/N 52540-09.

**54210-09** Chrome. **\$129.95**



A. FXCWC DETACHABLE SOLO LUGGAGE RACK



B. TAPERED LUGGAGE RACK – CHROME

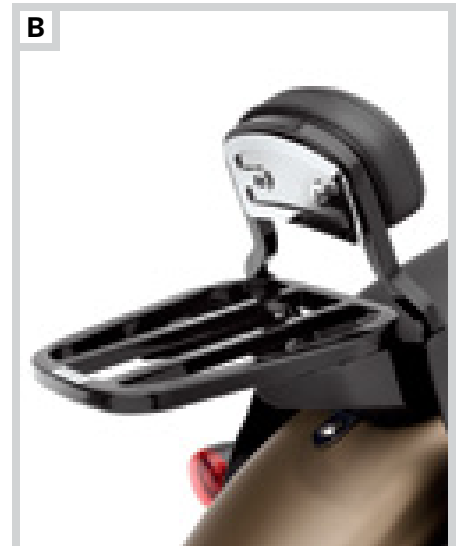

B. TAPERED LUGGAGE RACK – GLOSS BLACK



C. CUSTOM TAPERED SPORT LUGGAGE RACK  
P/N 53953-06 SHOWN



C. CUSTOM TAPERED SPORT LUGGAGE RACK  
P/N 54263-10 SHOWN



**\*WARNING:** Do not use this rack as a seat. Do not exceed the fender rack weight capacity. Using as seat or exceeding this capacity could cause handling problems which could result in loss of control and death or serious injury.

Notice: The prices appearing in this catalog are the manufacturer's suggested retail prices. Actual retail prices may vary.

# SOFTAIL® 241

Backrests & Racks



**D. SPORT LUGGAGE RACK – FIVE BAR, CHROME**  
P/N 53896-06 SHOWN

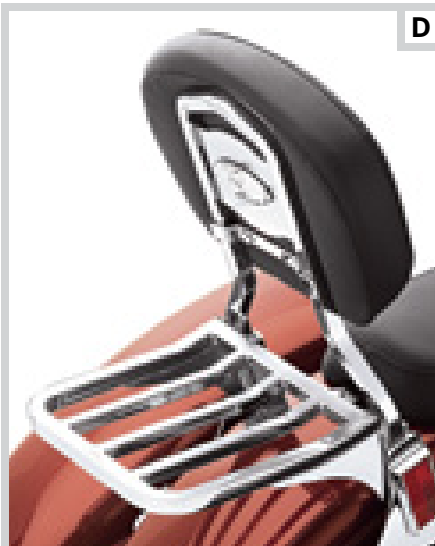

**D. SPORT LUGGAGE RACK – FIVE BAR, CHROME**  
P/N 53862-00 SHOWN



**D. SPORT LUGGAGE RACK – FIVE BAR, WRINKLE BLACK**  
P/N 53939-03 SHOWN



**E. TWO-UP SPORT LUGGAGE RACK – CHROME**



**E. TWO-UP SPORT LUGGAGE RACK – WRINKLE BLACK**

## D. SPORT LUGGAGE RACK – FIVE BAR\*

This rack brings touring flexibility to your motorcycle. Can be used with Detachable or Rigid Mount Sissy Bar Sideplates.

Fits '06-later FXST, FXSTB, FXSTS, FLSTFSE2 and '07-later FXSTC, FLSTF, FLSTFB, FXSTSSE/2, FLTSE and FLSTSB models with Rigid or Detachable Sideplates and Sissy Bar Uprights. '07-later FXSTC models require separate purchase of Fender Mounted Seat.

<b>53896-06</b>	Chrome.	<b>\$134.95</b>
<b>53965-06</b>	Wrinkle Black.	<b>\$134.95</b>

Fits '04-later XL models equipped with Detachable Sideplates, '06-later Dyna® models (except FXDF, FXDFSE/2 and '10 FXDWG) equipped with Rigid or Detachable Sideplates, '00-'05 Softail® models (except FXSTD and FLSTN) and '06-later FLST, FLSTC and FLSTSC models equipped with Detachable or Rigid Mount Sideplates.

<b>53862-00</b>	Chrome.	<b>\$134.95</b>
<b>53939-03</b>	Wrinkle Black.	<b>\$134.95</b>

## E. TWO-UP SPORT LUGGAGE RACK\*

A sleek rack that complements the lines of your motorcycle. Works with both Detachable and Rigid Mount Sideplates.

Fits '04-later XL models equipped with Detachable Sideplates, '00-'05 Softail models (except FXSTD and FLSTN), and '06-'07 FL Softail (except FLSTN, FLSTFSE2 and '07 FLSTF) equipped with Detachable or Rigid-Mount Sideplates. Also fits '08-later FLSTC models with Original Equipment rigid sideplates.

<b>53713-96A</b>	Chrome.	<b>\$149.95</b>
<b>53850-00A</b>	Wrinkle Black.	<b>\$149.95</b>

SOFTAIL



**\*WARNING:** Do not use this rack as a seat. Do not exceed the fender rack weight capacity. Using as seat or exceeding this capacity could cause handling problems which could result in loss of control and death or serious injury.

Notice: The prices appearing in this catalog are the manufacturer's suggested retail prices. Actual retail prices may vary.

# 242 SOFTAIL®

Backrests & Racks

## A. DETACHABLE SOLO RACK\*

Add touring capabilities to your solo seat Softail® model in less than 60 seconds. This Detachable Solo Rack fits over the fender when the passenger pillion is removed. The rack features brazed hand-polished tubing, and the chrome or black finish adds a stylish flair. Requires Docking Hardware. Easily interchangeable with Detachable Passenger Sissy Bar Upright and Sideplates.

Fits '00-'05 Softail® models (except Deuce™). Fits '06 FLST, FLSTF and '06-later FLSTC, FLSTN, FLSTSC. Requires solo seat. Requires separate purchase of appropriate Docking Hardware Kit.

**53652-05** Gloss Black. **\$199.95**  
**53649-05** Chrome. **\$199.95**

Fits '06-later FXST, FXSTB, FXSTC, FXSTS (except FXSTSSE3) and '07-later FLSTF, FLSTFB and FLSTSB models. Requires separate purchase of Docking Hardware Kit and Turn Signal Relocation Kit. See Docking Hardware Fitment Chart for your application.

**53612-08** Gloss Black. **\$199.95**

## B. BOBTAIL FENDER RACKS\*

Not only is it functional, but it's a great way to emphasize the legendary lines of the Bobtail. Designed for easy installation on models with or without Sissy Bar Uprights.

**59931-08** Gloss Black. **\$99.95**  
 Fits '06-later FXST, FXSTB, FXSTC, FXSTS and FLSTSB models. Also fits '07-'08 FXSTSSE/2 with separate purchase of Fender Rack Installation Kit P/N 59320-07. '06 models require separate purchase of Seat Bracket Kit P/N 52030-98 for installation when used with Original Equipment seat. Requires separate purchase of Washer P/N 6397B when used with a solo seat.

**53979-07A** Chrome. **\$99.95**  
 Fits '06-later FXST, FXSTB, FXSTC, FXSTS and FLSTSB models. Also fits '07-'08 FXSTSSE/2 with separate purchase of Fender Rack Installation Kit P/N 59320-07. '06 models require separate purchase of Seat Bracket Kit P/N 52030-98 for installation when used with Original Equipment seat. Requires separate purchase of Washer P/N 6397B when used with a solo seat.

**56481-03** Chrome. **\$99.95**  
 Fits '00-'05 FXST, FXSTB and FXSTS models. Seat Bracket Kit P/N 52030-98 is necessary for installation when used with Original Equipment seat.

**Also available:**

### BOBTAIL FENDER RACK INSTALLATION KIT

Required for installation of Bobtail Fender Rack P/Ns 53979-07A and 56452-07A.

**59320-07** **\$44.95**  
 Fits '07-'08 FXSTSSE/2 models and '06-later Softail models equipped with Tri-Bar LED Tail Light P/N 69817-07A. Required for installation of Bobtail Fender Rack P/Ns 53979-07A, 56452-07A or 59931-08. Does not fit with Bobtail Fender Rack P/Ns 56452-07, 60161-06 or 53979-07.



A. DETACHABLE SOLO RACK – GLOSS BLACK



A. DETACHABLE SOLO RACK – CHROME



A. DETACHABLE SOLO RACK – GLOSS BLACK (FLSTSB SHOWN)



B. CHROME BOBTAIL FENDER RACK – P/N 56481-03 SHOWN



B. GLOSS BLACK BOBTAIL FENDER RACK – P/N 59931-08 SHOWN



B. CHROME BOBTAIL FENDER RACK – P/N 53979-07A SHOWN



**\*WARNING:** Do not use this rack as a seat. Do not exceed the fender rack weight capacity. Using as seat or exceeding this capacity could cause handling problems which could result in loss of control and death or serious injury.

Notice: The prices appearing in this catalog are the manufacturer's suggested retail prices. Actual retail prices may vary.



## LOAD IT UP

*Rain gear, extra clothing and basic supplies are easy to take along when you add soft luggage to your bike. Designed for maximum versatility, this complete collection of saddlebags, soft touring luggage and compact storage pouches makes sure you can pack what you need for your next trip.*

### NEAR OR FAR



#### SADDLEBAGS

*Saddlebags are available in many different styles. Hard saddlebags offer lockable, color-matched storage with a sleek profile. Rigid saddlebags combine the look of leather with the security of hard bags. And leather saddlebags feature classic good looks that were born on the boulevard.*



#### SOFT LUGGAGE (RIGHT)

*Pack for work or a cross-country ride. Available in a variety of sizes, these Touring bags provide convenient and versatile storage.*

#### WINDSHIELD BAGS (LEFT)

*Versatile windshield bags fit most windshields, and offer convenient storage for sunglasses, maps and toll-booth change.*

#### SISSY BAR BAGS

*Compact and convenient, a Sissy Bar Bag fits right behind your seat for quick and easy access. Perfect for phones, maps and sunscreen.*



# 244 SOFTAIL®

## Saddlebags & Luggage

### A. LEATHER SADDLEBAGS FOR ROCKER™ MODELS

Heavy leather saddlebags add a practical twist to this one-of-a-kind custom motorcycle. The bags are removable with the simple "lift and slide" motion, so you can dress your bike up or down depending on your mood, leaving behind the attractive chrome support structure. The tapered "messenger" style bags feature traditional strap and buckle details that conceal quick-release clips for easy access. Designed to complement the lean look of the Rocker motorcycle, the tapered bags sit low on the bike, and wrap the exhaust for a ground-hugging stance. The bags feature rigid back shells to maintain their shape, and an expandable side gusset for added capacity when you need it. Luggage capacity: 1470 cubic inches total (1910 cubic inches expanded).

**90240-08** **\$679.95**

Fits '08-later FXCW and FXCWC models. Requires separate purchase of Saddlebag Support Structure P/N 90222-08, and separate purchase of model-specific Saddlebag Installation Kit.

### B. SADDLEBAG SUPPORT STRUCTURE

Chrome-plated structure is required for installation of Detachable Saddlebags P/N 90240-08 on FXCW and FXCWC models.

**90222-08** **\$189.95**

Fits '08-later FXCW and FXCWC models. Installation requires separate purchase of application-specific Saddlebag Installation Kit.

#### Also available:

#### SADDLEBAG INSTALLATION KITS

**90313-08** **\$49.95**

Fits '08-later FXCWC models with Original Equipment seat. Required when mounting Saddlebags P/N 90240-08 and Saddlebag Support Structure P/N 90222-08 on FXCWC.

**90245-08** **\$119.95**

Fits '08-'09 FXCW models without Touring System P/N 53935-08 installed. Required when mounting Saddlebags P/N 90240-08 and Saddlebag Support Structure P/N 90222-08 on FXCW models without Luggage Rack/Touring System.

**90233-08** **\$49.95**

Fits '08-'09 FXCW models with Touring System P/N 53935-08 installed. Required when mounting Saddlebags P/N 90240-08 and Saddlebag Support Structure P/N 90222-08 on FXCW models equipped with Luggage Rack/Touring System.



A. LEATHER SADDLEBAGS FOR ROCKER MODELS

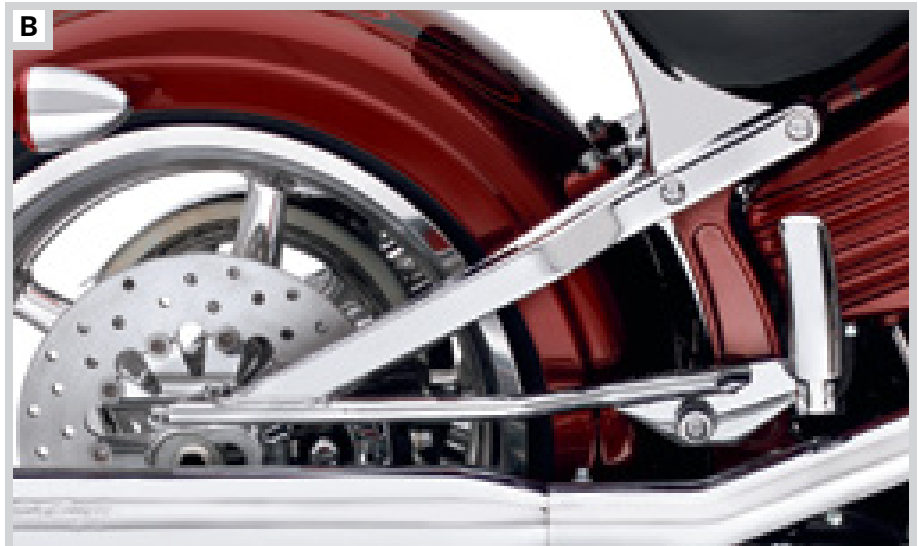

B. SADDLEBAG SUPPORT STRUCTURE

NOTE: Some Harley-Davidson® saddlebags are made of leather. Fine leathers or other natural materials WILL gain "character," such as wrinkles or wear, with age. This is normal. A fine, aged patina and character wrinkles are a sign of the extremely high quality materials used to construct your saddlebags. The appearance of scars or marks on the leather are a result of using natural leather panels and should not be thought of as an imperfection. Please use Harley-Davidson Leather Dressing P/N 98261-91V to protect your investment.

Notice: The prices appearing in this catalog are the manufacturer's suggested retail prices. Actual retail prices may vary.



C. DETACHABLE LEATHER SADDLEBAGS



D. FAT BOY DETACHABLE LEATHER SADDLEBAGS



C &amp; D. DETACHABLE LEATHER SADDLEBAGS – REMOVED, DOCKING HARDWARE SHOWN

**C. DETACHABLE LEATHER SADDLEBAGS**

These large capacity Detachable Saddlebags are completely removable with the simple pull of the internal handle, leaving your bike clean and ready to cruise the boulevard. The handsome leather bags feature hidden quick-release clips behind the traditional strap and buckle. When removed, the large capacity bags leave behind two simple, inconspicuous docking points. The bags are compatible with both rigid and detachable accessories when installed with the appropriate docking hardware kits. Luggage capacity: 2400 cubic inches total.

**88237-07** **\$799.95**

Fits '03-later FLST (except FLSTSE), FLSTC and '03-'05 FX Softail® models (except FXSTD). Models equipped with Detachable Accessories (except Detachable Tour-Pak Racks) require separate purchase of Docking Hardware Kit P/N 88256-07. Models equipped with Detachable Tour-Pak Racks require separate purchase of Docking Hardware Kit P/N 54245-10. Models without Detachable Accessories require separate purchase of Docking Hardware Kit P/N 53932-03. Models equipped with Rigid Accessories require separate purchase of Docking Hardware Kit P/N 88298-07. '03-'05 FX Softail models require separate purchase of Rear Directional Relocation Kit P/N 69857-07. Does not fit with Passenger Floorboards, Rear Saddlebag Guards, Wide Tire Kits, Rear Axle Covers or Flat Lens Turn Signal Kit P/N 68431-95 or 68432-95.

**88238-07** **\$799.95**

Fits '06-later FLSTSE and FX Softail models (except FXSTD, FXCW/C and FXSTSSE/2/3). Models equipped with Detachable Accessories (except Detachable Tour-Pak Racks) require separate purchase of Docking Hardware Kit P/N 88256-07. Models equipped with Detachable Tour-Pak Racks require separate purchase of Docking Hardware Kit P/N 54245-10. Models without Detachable Accessories require separate purchase of Docking Hardware Kit P/N 53932-03. Models equipped with Rigid Accessories also require separate purchase of Docking Hardware Kit P/N 88298-07. FXSTC models also require separate purchase of Docking Hardware Kit P/N 88297-07. All models require separate purchase of Rear Directional Relocation Kit P/N 69857-07. Does not fit with Passenger Floorboards, Rear Saddlebag Guards or Rear Axle Covers.

**D. FAT BOY® DETACHABLE LEATHER SADDLEBAGS**

Styled to complement the '07-later Fat Boy model. These large capacity Detachable Saddlebags are completely removable with the simple pull of the internal handle, leaving your bike clean and ready to cruise the boulevard. The handsome leather bags feature hidden quick-release clips behind the traditional strap and buckle. When removed, the large capacity bags leave behind two simple, inconspicuous docking points. The bags are compatible with both rigid and detachable accessories when installed with the appropriate docking hardware kits. Luggage capacity: 2400 cubic inches total.

**88306-07** **\$849.95**

Fits '07-later FLSTF and FLSTFB models (except HDI Australia/England models). Models equipped with Detachable Accessories require separate purchase of Docking Hardware Kit P/N 88256-07. Models without Detachable Accessories require separate purchase of Docking Hardware Kit P/N 53932-03. Models equipped with Rigid Accessories require separate purchase of Docking Hardware Kit P/N 88298-07. All models require separate purchase of Rear Directional Relocation Kit P/N 69929-07 or 73369-10. Does not fit with Passenger Floorboards or Rear Axle Covers.

**DETACHABLE SADDLEBAG HARDWARE****Docking Hardware Kits**

<b>88256-07</b>	<b>\$29.95</b>
<b>53932-03</b>	<b>\$39.95</b>
<b>88298-07</b>	<b>\$19.95</b>
<b>88297-07</b>	<b>\$19.95</b>

**Rear Turn Signal Relocation Kits**

<b>69857-07</b>	Chrome.	<b>\$69.95</b>
<b>69929-07</b>	Chrome.	<b>\$89.95</b>
<b>73369-10</b>	Black.	<b>\$89.95</b>

NOTE: Some Harley-Davidson® saddlebags are made of leather. Fine leathers or other natural materials WILL gain "character," such as wrinkles or wear, with age. This is normal. A fine, aged patina and character wrinkles are a sign of the extremely high quality materials used to construct your saddlebags. The appearance of scars or marks on the leather are a result of using natural leather panels and should not be thought of as an imperfection. Please use Harley-Davidson Leather Dressing P/N 98261-91V to protect your investment.

# 246 SOFTAIL®

Saddlebags & Luggage

## A. LOCKING LEATHER COVERED RIGID SADDLEBAGS FOR SOFTAIL® MODELS

These saddlebags offer a premium leather look with an extra-durable construction. The blow-molded core keeps the bag rigid and prevents sagging, while the unique lids open outward for added flair. Bags feature locks for additional security. Luggage capacity: 1800 cubic inches total.

**53061-00B** **\$749.95**

Fits '00-later Softail models (except FXCW/C and FXSTD). Also fits '09 FXSTSSE3 models. FXSTC models require separate purchase of Hardware Kit P/N 90573-07. Fits '84-'99 Softail models with separate purchase of Directional Relocation Kit P/N 53692-96. (FLST, FLSTC and FLSTS models do not require this Directional Relocation Kit.) (Does not fit '84-'99 models equipped with Detachables.) Does not fit with Rear Axle Covers or Wide Tire Kit P/N 43684-99 or Flat Lens Turn Signal Kit P/N 68431-95.

NOTE: Installation of these saddlebags with the following seats requires the use of Spacer Kit P/N 90976-01A: seats with rider backrests, Sundowner™ double bucket seats, Diamond Back® seats, stock FLSTF seat, stock FLSTC, FXSTC seat, and any other seats that contact the lid of the saddlebag. Spacer Kit not required if mounting with Harley-Davidson® Detachable Sissy Bar Sideplates.

### DIRECTIONAL RELOCATION KIT (not shown)

Provides clearance for various Harley-Davidson® leather saddlebags and/or luggage racks.

**53692-96** **\$49.95**

Fits '84-'99 FXST, FXSTC, FXSTS, FLSTF and FXSTSB. Required in order to mount Sissy Bar docking hardware on all '84-'99 FXSTSB, FXSTS, FXST, FXSTC and FLSTF models.

## B. LOCKING RIGID SADDLEBAGS FOR SOFTAIL DELUXE MODELS

Styled to complement the nostalgic look of the Softail Deluxe model, these saddlebags with pleated leather panels are anything but traditional. The rigid core allows the bag to retain its shape even after years of use. The hinged locking lid tilts outward for easy access, and the embossed weave pattern, braided edging and chrome concho trim echo the Softail Deluxe seat and pillion for a coordinated look. Luggage capacity: 1900 cubic inches total.

**53015-05B** **\$749.95**

Fits '05-later FLSTN models. Does not fit with Rear Axle Covers.

## C. LEATHER SADDLEBAGS FOR SOFTAIL® MODELS

Shaped to accent the arching rear fender, the rounded profile and rear-swept straps set the style for this traditional saddlebag. Smooth leather flap with embossed Bar & Shield logo features leather straps and chrome buckles that conceal modern quick-release closures for one-handed access. The rigid backing plate and end panels help the bag retain its shape. Luggage capacity: 1800 cubic inches total.

**90133-06B** **\$599.95**

Fits '00-later Softail models (except FXCW/C and FXSTD). Also fits '09 FXSTSSE3 models. FXSTC models require separate purchase of Hardware Kit P/N 90573-07. Also fits '84-'99 FLSTF, FXST, FXSTC and FXSTS models without Detachables when installed with Directional Relocation Kit P/N 53692-96. Does not fit with Rear Axle Covers, Wide Tire Kit P/N 43684-99A or Flat Lens Turn Signal Kit P/N 68431-95.

NOTE: Some Harley-Davidson® saddlebags are made of leather. Fine leathers or other natural materials WILL gain "character," such as wrinkles or wear, with age. This is normal. A fine, aged patina and character wrinkles are a sign of the extremely high quality materials used to construct your saddlebags. The appearance of scars or marks on the leather are a result of using natural leather panels and should not be thought of as an imperfection. Please use Harley-Davidson Leather Dressing P/N 98261-91V to protect your investment.

Notice: The prices appearing in this catalog are the manufacturer's suggested retail prices. Actual retail prices may vary.



A. LOCKING LEATHER COVERED RIGID SADDLEBAGS FOR SOFTAIL MODELS



B. LOCKING RIGID SADDLEBAGS FOR SOFTAIL DELUXE MODELS



C. LEATHER SADDLEBAGS FOR SOFTAIL MODELS





D. LEATHER SADDLEBAGS FOR FAT BOY MODELS

**D. LEATHER SADDLEBAGS FOR FAT BOY® MODELS**

Carry your essentials in style with these premium heavy leather saddlebags. They feature a reinforced tub and lid to retain their shape for the long-haul, leather straps and chrome buckles that hide quick-release clips. They are also highly stylized with a leather embossed lid that features decorative chrome spots and Spanish lacing to match the '07 Fat Boy model. Luggage capacity: 1700 cubic inches total.

**88286-07** **\$649.95**

Fits '00-later Softail models (except FXCW, FXCWC and FXSTD). Also fits '09 FXSTSSE3 models. FXSTC models require separate purchase of Hardware Kit P/N 90573-07. Also fits '84-'99 FLSTF, FXST, FXSTC and FXSTS models without Detachables when installed with Directional Relocation Kit P/N 53692-96. Does not fit with Rear Axle Covers, Wide Tire Kit P/N 43684-99A or Flat Lens Turn Signal Kit P/N 68431-95.

**E. LEATHER SADDLEBAGS FOR CROSS BONES MODELS**

Designed to complement the raw, bare-bones style of the FLSTSB model, these traditional leather saddlebags bring the "bobber" style of an earlier generation back to life. The leather straps and chrome buckles conceal modern quick-release closures for easy access, and the textured lid with embossed Bar & Shield logo opens to reveal generous storage space. The rigid backing plate and end panels help the bag retain its shape. These bags are compatible with both rigid and detachable accessories when installed with the appropriate docking hardware kits. Luggage capacity: 1900 cubic inches total.

**90419-08** **\$599.95**

Fits '08-later FLSTSB and '03-later Softail models (except FLSTC, FLSTF, FLSTFB, FLSTN, FXCW/C, FXSTD and FXSTSSE). Does not fit with Rear Axle Covers.

**F. LEATHER SADDLEBAGS FOR FXSTC MODELS**

Carry your essentials in style with these premium heavy leather saddlebags. They feature a reinforced tub to retain their shape for the long-haul, leather straps that hide quick release clips, and a new chrome buckle to match the FXSTC seat buttons. They are also highly stylized with a smooth leather lid and decorative chrome spots to match the '07 Softail Custom model. Luggage capacity: 1500 cubic inches total.

**88263-07** **\$649.95**

Fits '00-later Softail models (except FLSTF, FLSTFB, FXCW/C, FLSTN, FXSTD, FLSTSB and models equipped with Shotgun-style exhaust). Also fits '09 FXSTSSE3 models. Also fits '84-'99 Softail models (except FLSTF, models equipped with Shotgun-style exhaust, or Detachable accessories) with the separate purchase of Turn Signal Relocation Kit P/N 53692-96 (FLST, FLSTC and FLSTS models do not require this Directional Relocation kit). Does not fit with Rear Axle Covers, Wide Tire Kit P/N 43684-99A or Flat Lens Turn Signal Kit P/N 68431-95.



E. LEATHER SADDLEBAGS FOR CROSS BONES MODELS



F. LEATHER SADDLEBAGS FOR FXSTC MODELS

NOTE: Some Harley-Davidson® saddlebags are made of leather. Fine leathers or other natural materials WILL gain "character," such as wrinkles or wear, with age. This is normal. A fine, aged patina and character wrinkles are a sign of the extremely high quality materials used to construct your saddlebags. The appearance of scars or marks on the leather are a result of using natural leather panels and should not be thought of as an imperfection. Please use Harley-Davidson Leather Dressing P/N 98261-91V to protect your investment.

Notice: The prices appearing in this catalog are the manufacturer's suggested retail prices. Actual retail prices may vary.

# 248 SOFTAIL®

## Saddlebags & Luggage

### A. SYNTHETIC LEATHER SADDLEBAGS FOR SOFTAIL® MODELS

These handsome bags are the perfect accessory for your Softail model. The large interior leaves plenty of room for all of your essentials and an inner pocket allows for quick access to small items such as keys, sunglasses, and wallets. Luggage capacity: 1900 cubic inches total.

**91537-00C \$399.95**

Fits '00-later Softail® models (except FXCW/C, FLSTF, FLSTFB, FXSTD, FLSTN, FLSTSB and models equipped with Shotgun-style exhaust). Also fits '09 FXSTSSE3 models. FXSTC models require separate purchase of Hardware Kit P/N 90573-07. Also fits '84-'99 Softail models (except FLSTF, models equipped with Shotgun-style exhaust or Detachables) with the separate purchase of Turn Signal Relocation Kit P/N 53692-96. Does not fit with Wide Tire Kits, Rear Axle Covers or Flat Lens Turn Signal Kit P/N 68431-95.

### B. SOFTAIL® LEATHER SADDLEBAGS – FAT BOY® STYLING

Styled to complement the '00-'06 Fat Boy motorcycle with the distinctive Fat Boy concho, wider is definitely better when it comes to these bags, the widest available for Softail models. Luggage capacity: 1550 cubic inches total.

**90320-00D \$679.95**

Fits '00-later Softail models (except FXCW, FXCWC and FXSTD). Also fits '09 FXSTSSE3 models. FXSTC models require separate purchase of Hardware Kit P/N 90573-07. Also fits '84-'99 FLSTF, FXST, FXSTC and FXSTS models without Detachables when installed with Directional Relocation Kit P/N 53692-96. Does not fit with Rear Axle Covers, Wide Tire Kit P/N 43684-99A or Flat Lens Turn Signal Kit P/N 68431-95.

### C. LEATHER SADDLEBAGS FOR SOFTAIL® DEUCE™ MODELS

The Softail Deuce model is well on its way to becoming a motorcycle classic – and these leather bags will help complete the journey. Styled to match the Deuce model with chrome buckles, top-grain cowhide and a sleek “Deuce” logo, these bags feature an ingenious mounting mechanism that eliminates all visible hardware. Luggage capacity: 2000 cubic inches total.

**90404-00A \$599.95**

Fits '00-'07 FXSTD models. Requires use of Saddlebag Support Kit P/N 68360-00 and Directional Relocation Kit P/N 90395-00 for installation. '04 FXSTDSE2 models require additional purchase of Hardware Kit P/N 68375-03. See your Dealer for details. Does not fit with Rear Axle Covers.

#### SADDLEBAG SUPPORT KIT FOR SOFTAIL DEUCE MODELS (not shown)

Required for the Deuce bags, this mounting system eliminates all visible hardware, allowing you to profile down the highway in style.

**68360-00 \$199.95**

Fits '00-'07 FXSTD models. Required to install Softail Deuce Saddlebags P/N 90404-00A and 92018-03. Also requires separate purchase of Directional Relocation Kit P/N 90395-00 for installation.

#### SADDLEBAG SUPPORT BRACKET KIT FOR DEUCE™ MODELS (not shown)

Right side bracket required to mount Leather Saddlebags P/N 90404-00A on wide tire-equipped FXSTDSE2 Screamin' Eagle® Deuce models.

**68375-03 \$99.95**

Required to install Leather Saddlebag P/N 90404-00A on '04 FXSTDSE2 models and '00-'07 FXSTD models equipped with Wide Tire Kit.

NOTE: Some Harley-Davidson® saddlebags are made of leather. Fine leathers or other natural materials WILL gain “character,” such as wrinkles or wear, with age. This is normal. A fine, aged patina and character wrinkles are a sign of the extremely high quality materials used to construct your saddlebags. The appearance of scars or marks on the leather are a result of using natural leather panels and should not be thought of as an imperfection. Please use Harley-Davidson Leather Dressing P/N 98261-91V to protect your investment.

Notice: The prices appearing in this catalog are the manufacturer's suggested retail prices. Actual retail prices may vary.



A. SYNTHETIC LEATHER SADDLEBAGS FOR SOFTAIL MODELS



B. SOFTAIL LEATHER SADDLEBAGS – FAT BOY STYLING



C. LEATHER SADDLEBAGS FOR SOFTAIL DEUCE MODELS

# SOFTAIL® 249

Saddlebags & Luggage



D. HERITAGE STYLE SADDLEBAG KIT

## D. HERITAGE STYLE SADDLEBAG KIT

Original Equipment on the '06-'08 Heritage Softail® Classic model, these top grade cowhide saddlebags feature reinforced rim and sides to help maintain their shape. The bags are decorated with chrome studs and a chrome-plated brass medallion coined with the Harley-Davidson logo. Saddlebag tops have rivet-reinforced corners and are secured with heavy leather straps that conceal quick-release hardware. Luggage capacity: 2200 cubic inches total.

**90876-05 \$699.95**  
Fits '00-later FLST (except FLSTSE) and FLSTC models. FLST models require separate purchase of Saddlebag Hardware Kit P/N 79304-06.

## E. LEATHER THROW-OVER SADDLEBAGS

The ideal complement to the '07-later Nightster model, these traditional Leather Throw-Over bags feature large side gussets for increased capacity and full-length straps with hidden quick disconnect clips for easy access.

**91008-82C \$299.95**  
Fits '82-later XL, '08-later Dyna and '84-'99 Softail® models equipped with H-D® Chrome Saddlebag Supports.

## F. SYNTHETIC LEATHER THROW-OVER ADJUSTABLE SADDLEBAGS

Synthetic leather with embossed "Eagle Wing" logo. 11" x 10" x 3-3/4".

**90570-86TA \$99.95**  
Fits '82-'03 XL, '91-'05 Dyna® and '84-'99 Softail models equipped with saddlebag supports.

Also available:

### CHROME SADDLEBAG SUPPORTS

Fit with or without Sissy Bar Uprights, attach easily, and protect bags from contacting brake and swingarm.

**91790-84C \$99.95**  
Fits '84-'06 FL Softail models (except FLSTS) and '84-'05 FX Softail models (except FXSTD). Will not fit with Detachables.

## G. SADDLEBAG LINERS

Water-resistant liners make packing easy. Features inner pockets for extra storage and an embroidered Bar & Shield logo.

**91956-97 \$44.95**  
Fits Saddlebag P/Ns 53061-00A, 88263-07, 88286-07, 90320-00C, 90404-00, 90697-96, 90831-91, 90833-90B, 90975-96, 90975-95, 90973-95, 91536-00B, 91555-01A, 92015-03.

**91957-97 \$44.95**  
Fits Heritage Softail® Classic and Heritage Springer® style saddlebags. Also fits Saddlebag P/Ns 88312-07, 88237-07, 88238-07, 90119-00B, 90130-00C, 90300-98, 90342-98A, 90598-96B, 90835-90C, 90876-05, 91537-00C.

**91958-97 \$44.95**  
Fits Saddlebag P/Ns 90058-05A, 90130-00A, 90133-06B, 90419-08, 90901-95, 90990-95, 91190-97 and VRSC Molded Saddlebags.

**91959-97 \$44.95**  
Fits Saddlebags P/Ns 79078-02, 79300-04B, 79300-06B, 88224-06, 90181-08, 90307-06, 90330-08, 90369-06, 90460-06B, 90564-06A, 90680-97 and 91010-91A.



E. LEATHER THROW-OVER SADDLEBAGS



F. SYNTHETIC LEATHER THROW-OVER ADJUSTABLE SADDLEBAGS



G. SADDLEBAG LINERS FOR LEATHER SADDLEBAGS (91959-97 SHOWN)



G. SADDLEBAG LINERS FOR LEATHER SADDLEBAGS (91957-97 SHOWN)

Notice: The prices appearing in this catalog are the manufacturer's suggested retail prices. Actual retail prices may vary.

SOFTAIL

# 250 SOFTAIL®

Saddlebags & Luggage

## A. COLOR-MATCHED SPORT TOUR-PAK® LUGGAGE\*

Designed to complement the styling of the Softail® and Sportster® Hard Saddlebags, the Color-Matched Sport Tour-Pak Luggage adds increased storage for your ride across town or across the country. The injection molded Tour-Pak Luggage is lockable, and includes an interior rubber mat. Large enough to store most full-faced helmets. Racks and docking kits sold separately. International models may require separate purchase of License Plate Relocation Kit P/N 60095-00A. Luggage capacity: 2245 cubic inches.

Fits '00-later Softail models (except Deuce, Rocker and FXSTSSE3) equipped with Detachable Solo or Two-Up Tour-Pak Rack. Fits '97-later Touring models (except Trike) equipped with Detachable Two-Up or Solo Tour-Pak Racks. Fits '04-later XL models equipped with Solo Tour-Pak Rack.

<b>53929-09CWR</b>	Big Purple Flake.	<b>\$674.95</b>
<b>53929-06AV</b>	Birch White.	<b>\$674.95</b>
<b>53929-06BPS</b>	Black Cherry.	<b>\$674.95</b>
<b>53929-09CWL</b>	Black Ice.	<b>\$674.95</b>
<del><b>53929-10DBP</b></del>	<del>Black Ice Denim.</del> <b>OBSOLETE</b>	<del><b>\$674.95</b></del>
<b>53929-06BPY</b>	Black Pearl.	<b>\$674.95</b>
<b>53929-08COV</b>	Brilliant Silver Denim.	<b>\$674.95</b>
<b>53929-10BHT</b>	Brilliant Silver Pearl.	<b>\$674.95</b>
<b>53929-08CPF</b>	Candy Red Sunglo.	<b>\$674.95</b>
<b>53929-06BPO</b>	Chopper Blue.	<b>\$674.95</b>
<b>53929-08CPL</b>	Copperhead Pearl.	<b>\$674.95</b>
<b>53929-08CPH</b>	Copper Pearl.	<b>\$674.95</b>
<b>53929-08COZ</b>	Crimson Red Sunglo.	<b>\$674.95</b>
<b>53929-08CPC</b>	Dark Blue Pearl.	<b>\$674.95</b>
<b>53929-06BXT</b>	Deep Cobalt.	<b>\$674.95</b>
<b>53929-09CWN</b>	Deep Turquoise.	<b>\$674.95</b>
<b>53929-09CWA</b>	Flame Blue Pearl.	<b>\$674.95</b>
<b>53929-06BHX</b>	Glacier White Pearl.	<b>\$674.95</b>
<b>53929-08CPJ</b>	Golden Glow.	<b>\$674.95</b>
<b>53929-09CWT</b>	Light Candy Root Beer.	<b>\$674.95</b>
<b>53929-06BNR</b>	Mirage Orange.	<b>\$674.95</b>
<b>53929-08COS</b>	Olive Pearl Denim.	<b>\$674.95</b>
<b>53929-08CPK</b>	Purple Haze.	<b>\$674.95</b>
<b>53929-09CYS</b>	Red Hot Sunglo.	<b>\$674.95</b>
<b>53929-10DBJ</b>	Scarlet Red.	<b>\$674.95</b>
<b>53929-06BHS</b>	Sierra Red.	<b>\$674.95</b>
<b>53929-08CGT</b>	Suede Blue Pearl.	<b>\$674.95</b>
<del><b>53929-08CPE</b></del>	<del>Sunset Yellow Pearl.</del> <b>OBSOLETE</b>	<del><b>\$674.95</b></del>
<b>53929-06DH</b>	Vivid Black.	<b>\$674.95</b>
<b>53929-07CGS</b>	White Gold Pearl.	<b>\$674.95</b>
<b>53929-06BPZ</b>	Yellow Pearl.	<b>\$674.95</b>

Shown with:

### PASSENGER BACKREST PAD FOR SPORT TOUR-PAK LUGGAGE

This Sport Tour-Pak Backrest Pad is styled to complement a wide variety of Original Equipment or custom seats, and provides comfortable support for your passenger.

**52872-01** **\$89.95**

Fits models equipped with Sport Tour-Pak Luggage P/N 53929-0XXXX.

A

NEW



A. COLOR-MATCHED SPORT TOUR-PAK LUGGAGE (SHOWN WITH DETACHABLE TOUR-PAK RACK AND PASSENGER BACKREST PAD)

A



A. COLOR-MATCHED SPORT TOUR-PAK LUGGAGE (SHOWN WITH DETACHABLE TOUR-PAK RACK AND PASSENGER BACKREST PAD)

\*NOTE: This product is a "Paint to Order" accessory. Please allow for an average of 5 weeks delivery for this item.

Notice: The prices appearing in this catalog are the manufacturer's suggested retail prices. Actual retail prices may vary.





NEW

B

## SOFTAIL® 251

Saddlebags & Luggage

### B. COLOR-MATCHED HARD SADDLEBAGS\*

These hard saddlebags offer not only lockable storage convenience, but they provide style with flowing lines worthy of the Softail® model family. They are injection-molded from high-impact composite materials, painted-to-match the factory colors and have approximately 20% more total capacity than the Original Equipment saddlebags used on the Heritage Softail® when used with Saddlebag Liners P/N 91778-00. Luggage Capacity: 2500 cubic inches total.

#### SOFTAIL® HARD SADDLEBAG HARDWARE KIT (not shown)

**90299-00** **\$39.95**

Required to install Color-Matched Softail Saddlebags on Softail models equipped with Softail Wide Tire Kit P/N 43685-00A, 44490-00, 43684-99A.

**53075-03** **\$24.95**

Required on '03-later Softail models equipped with Detachables (except FXSTD).

**53009-03** **\$9.95**

Required on '87-'02 Softail models equipped with Detachables (except FXSTD).

#### Shown with:

#### SADDLEBAG LINERS FOR SOFTAIL® HARD SADDLEBAGS

Custom fit to the Softail® Hard Saddlebags, these liners make packing easier and more efficient and allow you to take advantage of the 20% larger capacity of the hard bag. These well constructed, water-resistant bags are designed to fit right into your saddlebags and include handy inner storage pockets. They feature convenient carrying straps and an embroidered Bar & Shield logo (sold in pairs).

**91778-00** **\$44.95**

Fits '00-later Softail models equipped with Softail Hard Saddlebags.

SOFTAIL

B. SOFTAIL HARD SADDLEBAGS



B

B. SOFTAIL HARD SADDLEBAGS –  
SHOWN OPEN WITH OPTIONAL SADDLEBAG LINERS

\*NOTE: This product is a "Paint to Order" accessory. Please allow for an average of 5 weeks delivery for this item.

Notice: The prices appearing in this catalog are the manufacturer's suggested retail prices. Actual retail prices may vary.

# 252 SOFTAIL®

Saddlebags & Luggage



SOFTAIL DEUCE HARD SADDLEBAGS



FX SOFTAIL HARD SADDLEBAG – FXSTB SHOWN



FAT BOY HARD SADDLEBAG – FLSTF SHOWN

**COLOR-MATCHED HARD SADDLEBAGS\***

These hard saddlesbags offer not only lockable storage convenience, but they provide style with flowing lines worthy of the Softail® model family. They are injection-molded from high-impact composite materials, painted-to-match the factory colors and have approximately 20% more total capacity than the Original Equipment saddlesbags used on the Heritage Softail® when used with Saddlesbag Liners P/N 91778-00. Luggage Capacity: 2500 cubic inches total.

**SOFTAIL® DEUCE™ HARD SADDLEBAGS\***

Fits '00-'07 FXSTD models (except '04 FXSTDSE2 and models equipped with Wide Tire Kit P/N 44075-04). Cannot be used with Turn Signal Module Kit P/N 68216-00.

<b>90394-00</b>	Primed.	<b>\$1,149.95</b>
<b>90394-00DH</b>	Vivid Black.	<b>\$1,399.95</b>

**SOFTAIL® HARD SADDLEBAGS\***

Fits '87-'99 FXSTC, '87-'05 FXST, FXSTS, FXSTB and '05-'07 FLSTSC models. Fits with Detachable Sissy Bars and Luggage Racks or with Rigid-Mounted Sissy Bar. Use Hardware Kit P/N 53075-03 to install saddlesbags on '03-later Softail models equipped with Detachables. Use Hardware Kit P/N 53009-03 to install saddlesbags on '87-'02 Softail models equipped with Detachables. Will also fit FLSTF models if exhaust system is changed to Staggered Duals. Installation on a Softail model equipped with wide tire requires the additional purchase of Hardware Kit P/N 90299-00. (Will not fit with Chrome Rear Saddlesbag Guards P/N 49261-00A.) Includes Turn Relocation Kit.

<b>90225-03BDK</b>	Primed.	<b>\$1,149.95</b>
<b>90225-05BPS</b>	Black Cherry Pearl.	<b>\$1,399.95</b>
<b>90225-05BPY</b>	Black Pearl.	<b>\$1,399.95</b>
<b>90225-03BDT</b>	Gunmetal Pearl.	<b>\$1,399.95</b>
<b>90225-03BBP</b>	Impact Blue.	<b>\$1,399.95</b>
<b>90225-03XE</b>	Luxury Blue.	<b>\$1,399.95</b>
<b>90225-03ZQ</b>	Luxury Rich Red.	<b>\$1,399.95</b>
<b>90225-04BHS</b>	Sierra Red.	<b>\$1,399.95</b>
<b>90225-03DH</b>	Vivid Black.	<b>\$1,399.95</b>

**HERITAGE SOFTAIL AND HERITAGE SOFTAIL CLASSIC HARD SADDLEBAGS**

Fits '87-'07 FLSTC and '06 FLST models. Fits with Detachable Sissy Bars and Luggage Racks or with Rigid-Mounted Sissy Bar. Use Hardware Kit P/N 53075-03 to install saddlesbags on '03-'07 Softail models equipped with Detachables. Use Hardware Kit P/N 53009-03 to install saddlesbags on '87-'02 Softail models equipped with Detachables. Installation requires the use of Narrow Chrome Directional Bar P/N 68611-98 to provide access to the locks. If equipped with Detachable Sissy Bar or Luggage Rack, the Narrow Chrome Directional Bar is not required. Installation on a Softail model equipped with wide tire requires the purchase of Hardware Kit P/N 90299-00.

<b>90224-03BDK</b>	Primed.	<b>\$1,149.95</b>
<b>90224-03DH</b>	Vivid Black.	<b>\$1,399.95</b>
<b>90224-07CGR</b>	Pewter Pearl.	<b>\$1,399.95</b>

**'05-'07 FLSTN HARD SADDLEBAGS**

Fits '05-'07 FLSTN models. Saddlesbag lid is removable for ease of loading. Use Hardware Kit P/N 53075-03 to install Hard Saddlesbags on models equipped with Detachables.

<b>90725-05BDK</b>	Primed.	<b>\$1,149.95</b>
<b>90725-05BPS</b>	Black Cherry Pearl.	<b>\$1,399.95</b>
<b>90725-05BPY</b>	Black Pearl.	<b>\$1,399.95</b>
<b>90725-06BXT</b>	Deep Cobalt.	<b>\$1,399.95</b>
<b>90725-05BHX</b>	Glacier White Pearl.	<b>\$1,399.95</b>
<b>90725-05BJK</b>	Lava Red Sunglo.	<b>\$1,399.95</b>
<b>90725-07CGV</b>	Olive Pearl.	<b>\$1,399.95</b>
<b>90725-05DH</b>	Vivid Black.	<b>\$1,399.95</b>
<b>90725-07CGS</b>	White Gold Pearl.	<b>\$1,399.95</b>

**'08-LATER FLSTN HARD SADDLEBAGS**

Fits '08-later FLSTN models. Use Hardware Kit P/N 53075-03 to install Hard Saddlesbags on models equipped with Detachables.

<b>90725-08BDK</b>	Primed.	<b>\$1,149.95</b>
<b>90725-09CWR</b>	Big Purple Flake.	<b>\$1,399.95</b>
<b>90725-08BPS</b>	Black Cherry Pearl.	<b>\$1,399.95</b>
<b>90725-09CWL</b>	Black Ice.	<b>\$1,399.95</b>
<b>90725-08BPY</b>	Black Pearl.	<b>\$1,399.95</b>
<b>90725-08CPF</b>	Candy Red Sunglo.	<b>\$1,399.95</b>
<b>90725-08CPH</b>	Copper Pearl.	<b>\$1,399.95</b>
<b>90725-08CPL</b>	Copperhead Pearl.	<b>\$1,399.95</b>
<b>90725-08COZ</b>	Crimson Red Sunglo.	<b>\$1,399.95</b>
<b>90725-08CPC</b>	Dark Blue Pearl.	<b>\$1,399.95</b>
<b>90725-08BXT</b>	Deep Cobalt Pearl.	<b>\$1,399.95</b>
<b>90725-09CWN</b>	Deep Turquoise.	<b>\$1,399.95</b>
<b>90725-09CWA</b>	Flame Blue Pearl.	<b>\$1,399.95</b>
<b>90725-08BHX</b>	Glacier White Pearl.	<b>\$1,399.95</b>
<b>90725-08CPJ</b>	Golden Glow.	<b>\$1,399.95</b>
<b>90725-08BJK</b>	Lava Red Sunglo.	<b>\$1,399.95</b>
<b>90725-09CWT</b>	Light Candy Root Beer.	<b>\$1,399.95</b>
<b>90725-08CGV</b>	Olive Pearl.	<b>\$1,399.95</b>
<b>90725-08CPK</b>	Purple Haze.	<b>\$1,399.95</b>
<b>90725-09CYS</b>	Red Hot Sunglo.	<b>\$1,399.95</b>
<b>90725-10DBJ</b>	Scarlet Red.	<b>\$1,399.95</b>
<b>90725-08CGT</b>	Suede Blue Pearl.	<b>\$1,399.95</b>
<b>90725-08DH</b>	Vivid Black.	<b>\$1,399.95</b>
<b>90725-08CGS</b>	White Gold Pearl.	<b>\$1,399.95</b>

**'06-'07 FXST/B/S HARD SADDLEBAGS**

Fits '06-'07 FXST, FXSTB and FXSTS models. Includes Turn Signal Relocation Kit. Fits with Detachable Sissy Bars and Luggage Racks or with Rigid-Mounted Sissy Bar.

<b>90225-06BDK</b>	Primed.	<b>\$1,149.95</b>
<b>90225-07BYM</b>	Black Denim.	<b>\$1,399.95</b>
<b>90225-06BHT</b>	Brilliant Silver.	<b>\$1,399.95</b>
<b>90225-06BXY</b>	Fire Red Pearl.	<b>\$1,399.95</b>
<b>90225-07CHG</b>	Pacific Blue Denim.	<b>\$1,399.95</b>
<b>90225-07CHH</b>	Pewter Denim.	<b>\$1,399.95</b>
<b>90225-06DH</b>	Vivid Black.	<b>\$1,399.95</b>
<b>90225-07CGS</b>	White Gold Pearl.	<b>\$1,399.95</b>

**'08-LATER FXST/B/S HARD SADDLEBAGS**

Fits '08-later FXST, FXSTB, FXSTC and FXSTS models. Includes Turn Signal Relocation Kit. Fits with Detachable Sissy Bars and Luggage Racks or with Rigid-Mounted Sissy Bar. Does not fit '08-later models equipped with Profile® Low Rear Suspension P/N 54651-05, 54652-05 or 54001-04.

<b>90225-09BDK</b>	Primed.	<b>\$1,149.95</b>
<b>90225-09CWR</b>	Big Purple Flake.	<b>\$1,399.95</b>
<b>90225-08BYM</b>	Black Denim.	<b>\$1,399.95</b>
<b>90225-09CWL</b>	Black Ice.	<b>\$1,399.95</b>
<b>90225-08BPY</b>	Black Pearl.	<b>\$1,399.95</b>
<b>90225-10BHT</b>	Brilliant Silver Pearl.	<b>\$1,399.95</b>
<b>90225-08CPH</b>	Copper Pearl.	<b>\$1,399.95</b>
<b>90225-08CPD</b>	Crimson Red Denim.	<b>\$1,399.95</b>
<b>90225-08CPC</b>	Dark Blue Pearl.	<b>\$1,399.95</b>
<b>90225-09CWN</b>	Deep Turquoise.	<b>\$1,399.95</b>
<b>90225-09CWA</b>	Flame Blue Pearl.	<b>\$1,399.95</b>
<b>90225-08CPJ</b>	Golden Glow.	<b>\$1,399.95</b>
<b>90225-09CWT</b>	Light Candy Root Beer.	<b>\$1,399.95</b>
<b>90225-08CHH</b>	Pewter Denim.	<b>\$1,399.95</b>
<b>90225-09CYS</b>	Red Hot Sunglo.	<b>\$1,399.95</b>
<b>90225-10DBJ</b>	Scarlet Red.	<b>\$1,399.95</b>
<b>90225-08DH</b>	Vivid Black.	<b>\$1,399.95</b>

**'90-'06 FAT BOY HARD SADDLEBAGS**

Fits '90-'06 FLSTF and '93-'96 FLSTN models. Includes Turn Signal Relocation Kit. Use Hardware Kit P/N 53075-03 to install saddlesbags on '03-'06 FLSTF models equipped with Detachables. Use Hardware Kit P/N 53009-03 to install saddlesbags on '87-'02 Softail models equipped with Detachables.

<b>90715-03BDK</b>	Primed.	<b>\$1,149.95</b>
<b>90715-05BPS</b>	Black Cherry Pearl.	<b>\$1,399.95</b>
<b>90715-05BPY</b>	Black Pearl.	<b>\$1,399.95</b>
<b>90715-04BHT</b>	Brilliant Silver.	<b>\$1,399.95</b>
<b>90715-05BPO</b>	Chopper Blue.	<b>\$1,399.95</b>
<b>90715-06BXT</b>	Deep Cobalt.	<b>\$1,399.95</b>
<b>90715-03ZL</b>	Diamond Ice Pearl.	<b>\$1,399.95</b>
<b>90715-04BHX</b>	Glacier White Pearl.	<b>\$1,399.95</b>
<b>90715-03BDT</b>	Gunmetal Pearl.	<b>\$1,399.95</b>
<b>90715-03BBP</b>	Impact Blue.	<b>\$1,399.95</b>
<b>90715-03XF</b>	Jade Sunglo.	<b>\$1,399.95</b>
<b>90715-04BJK</b>	Lava Red Sunglo.	<b>\$1,399.95</b>
<b>90715-03XE</b>	Luxury Blue.	<b>\$1,399.95</b>
<b>90715-03ZQ</b>	Luxury Rich Red.	<b>\$1,399.95</b>
<b>90715-03BBN</b>	Real Red.	<b>\$1,399.95</b>
<b>90715-03XG</b>	Real Teal.	<b>\$1,399.95</b>
<b>90715-05BPV</b>	Rich Sunglo Blue.	<b>\$1,399.95</b>
<b>90715-04BHS</b>	Sierra Red.	<b>\$1,399.95</b>
<b>90715-04BJL</b>	Smokey Gold.	<b>\$1,399.95</b>
<b>90715-03BDP</b>	Sterling Silver.	<b>\$1,399.95</b>
<b>90715-03DH</b>	Vivid Black.	<b>\$1,399.95</b>
<b>90715-03ZB</b>	White Pearl.	<b>\$1,399.95</b>

**'07 FAT BOY HARD SADDLEBAGS**

Fits '07 FLSTF models. Includes Turn Signal Relocation Kit. Use Hardware Kit P/N 53075-03 to install Hard Saddlesbags on models equipped with Detachables.

<b>90715-07BDK</b>	Primed.	<b>\$1,149.95</b>
<b>90715-07BPS</b>	Black Cherry Pearl.	<b>\$1,399.95</b>
<b>90715-07BPY</b>	Black Pearl.	<b>\$1,399.95</b>
<b>90715-07BXT</b>	Deep Cobalt.	<b>\$1,399.95</b>
<b>90715-07BXY</b>	Fire Red Pearl.	<b>\$1,399.95</b>
<b>90715-07CGV</b>	Olive Pearl.	<b>\$1,399.95</b>
<b>90715-07CGP</b>	Pacific Blue Pearl.	<b>\$1,399.95</b>
<b>90715-07CGR</b>	Pewter Pearl.	<b>\$1,399.95</b>
<b>90715-07CGT</b>	Suede Blue Pearl.	<b>\$1,399.95</b>
<b>90715-07DH</b>	Vivid Black.	<b>\$1,399.95</b>
<b>90715-07CGS</b>	White Gold Pearl.	<b>\$1,399.95</b>
<b>90715-07BPZ</b>	Yellow Pearl.	<b>\$1,399.95</b>

**'08-LATER FAT BOY HARD SADDLEBAGS**

Fits '08-later FLSTF models. Includes Turn Signal Relocation Kit. Does not fit FLSTFB or '08-later models equipped with Profile® Low Rear Suspension P/N 54651-05, 54652-05 or 54001-04. Use Hardware Kit P/N 53075-03 to install Hard Saddlesbags on models equipped with Detachables.

<b>90715-08BDK</b>	Primed.	<b>\$1,149.95</b>
<b>90715-09CWR</b>	Big Purple Flake.	<b>\$1,399.95</b>
<b>90715-09BYM</b>	Black Denim.	<b>\$1,399.95</b>
<b>90715-09CWL</b>	Black Ice.	<b>\$1,399.95</b>
<b>90715-08BPY</b>	Black Pearl.	<b>\$1,399.95</b>
<b>90715-10BHT</b>	Brilliant Silver Pearl.	<b>\$1,399.95</b>
<b>90715-08CPF</b>	Candy Red Sunglo.	<b>\$1,399.95</b>
<b>90715-08CPH</b>	Copper Pearl.	<b>\$1,399.95</b>
<b>90715-08CPL</b>	Copperhead Pearl.	<b>\$1,399.95</b>
<b>90715-09CWA</b>	Flame Blue Pearl.	<b>\$1,399.95</b>
<b>90715-08CPJ</b>	Golden Glow.	<b>\$1,399.95</b>
<b>90715-09CWT</b>	Light Candy Root Beer.	<b>\$1,399.95</b>
<b>90715-08CGP</b>	Pacific Blue Pearl.	<b>\$1,399.95</b>
<b>90715-08CGR</b>	Pewter Pearl.	<b>\$1,399.95</b>
<b>90715-08CPK</b>	Purple Haze.	<b>\$1,399.95</b>
<b>90715-09CYS</b>	Red Hot Sunglo.	<b>\$1,399.95</b>
<b>90715-10DBJ</b>	Scarlet Red.	<b>\$1,399.95</b>
<b>90715-08DH</b>	Vivid Black.	<b>\$1,399.95</b>

\*NOTE: This product is a "Paint to Order" accessory. Please allow for an average of 5 weeks delivery for this item.

Notice: The prices appearing in this catalog are the manufacturer's suggested retail prices. Actual retail prices may vary.

# 254 SOFTAIL®

## Saddlebags & Luggage

### A. DETACHABLE TWO-UP TOUR-PAK® MOUNTING RACK

Designed to be installed and removed in less than 60 seconds, this Tour-Pak Rack makes the convenience and protection of leather an easy on/off proposition. The ultimate accessory in touring flexibility, this rack is designed to work with all Harley-Davidson® Leather or Sport Tour-Pak luggage systems.

**53066-00C** **\$224.95**

Fits '00-'05 Softail® models (except Deuce™). Fits '06 FLST, FLSTF and '06-later FLSTC, FLSTN, FLSTSC models. Designed to accept Color-Matched Sport Tour-Pak or Leather Tour-Pak Luggage System. Requires separate purchase of appropriate Docking Hardware. Some models require the separate purchase of Directional Relocation Kit. Refer to Detachable Docking Hardware Chart for specific application. Some EU registration plates may interfere with Tour-Pak Rack. Models with rear fender tip trim can be adapted with the separate purchase of License Plate Relocation Kit P/N-60095-00A. Models equipped with Detachable Saddlebag Kit P/N 88237-07 also require separate purchase of Docking Hardware Kit P/N 54245-10.

**54051-08** **\$224.95**

Fits '06-later FXST, FXSTB, FXSTS, FLSTFSE2 and '07-later FXSTC, FXSTSSE/2, FLSTF, FLSTFB, FLSTSE and FLSTSB models. FXSTC models require removal of Original Equipment Sissy Bar and separate purchase of a fender-mounted seat. Requires separate purchase of appropriate docking hardware kit. '10 FLSTSE models and models equipped with Detachable Saddlebag Kit P/N 88237-07 also require separate purchase of Docking Hardware Kit P/N 54245-10.

### B. DETACHABLE SOLO TOUR-PAK MOUNTING RACK\*

Install the Sport or Leather Tour-Pak in a comfortable back-supporting position. The rack is designed to position the Tour-Pak Luggage for solo riding and is adjustable over a 3/4" range. Simply remove the Tour-Pak Luggage from the convenient detachable hardware, add a Passenger Pillion, and the bike is ready for two-up riding. Tour-Pak, Passenger Backrest Pad and Docking Hardware sold separately.

**53559-04A** **\$139.95**

Fits '00-'05 Softail models (except FXSTD). Fits '06 FLST, FLSTF and '06-later FLSTC, FLSTN, FLSTSC models. Designed to accept Color-Matched Sport Tour-Pak or Leather Tour-Pak Luggage System. Requires separate purchase of appropriate Docking Hardware. Some models require separate purchase of Directional Relocation Kit. See matrix for specific application. Some EU registration plates may interfere with the Tour-Pak Rack. Models with rear fender tip trim can be adapted with the separate purchase of License Plate Relocation Kit P/N 60095-00A.

### C. LEATHER TOUR-PAK LOCK SET

Designed to discourage grab-and-run theft, this Lock Set provides a level of security that leather straps alone can't match. The complete kit includes external locking push-button latch release, locking mechanism, release cable, two keys, steel Tour-Pak lid mounting plate, and all required installation hardware. Special order keyed-to-match lock sets are available for models with barrel-type keys. Contact your Dealer with your vehicle key code.

**54360-05** **\$169.95**

Fits models equipped with Leather or Synthetic Leather Tour-Pak Luggage (except P/N 79189-06).



A. DETACHABLE TWO-UP TOUR-PAK MOUNTING RACK (FLSTC SHOWN)



B. DETACHABLE SOLO TOUR-PAK MOUNTING RACK



C. LEATHER TOUR-PAK LOCK SET



**\*WARNING:** Do not use this rack as a seat. Do not exceed the fender rack weight capacity. Using as seat or exceeding this capacity could cause handling problems which could result in loss of control and death or serious injury.

Notice: The prices appearing in this catalog are the manufacturer's suggested retail prices. Actual retail prices may vary.



# SOFTAIL® 255

Saddlebags & Luggage



**D. LEATHER TOUR-PAK LUGGAGE – HERITAGE SOFTAIL CLASSIC STYLING**

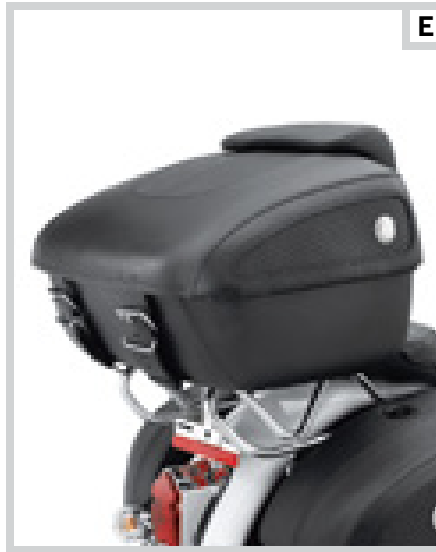

**E. LEATHER TOUR-PAK LUGGAGE – SOFTAIL DELUXE STYLING**



**F. TOUR-PAK LUGGAGE – SMOOTH STYLING**

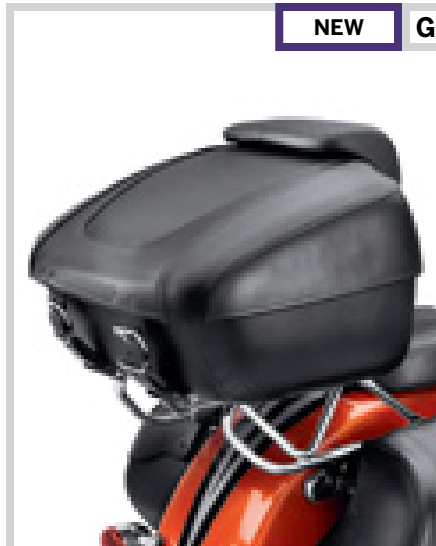

**G. LEATHER TOUR-PAK LUGGAGE – CONVERTIBLE STYLING WITH BUFFALO INSERTS**



**H. TOUR-PAK LID ORGANIZER**



**I. LINER FOR LEATHER TOUR-PAK LUGGAGE**

## TOUR-PAK® LUGGAGE

Add cross-country luggage capacity to your ride with accessory Tour-Pak Luggage. A cavernous interior will hold one full face helmet or two half helmets. Kit includes backrest pad, interior rubber mat, hardware and instructions. Luggage Capacity: 2500 cubic inches. Dimensions: 18.5" W x 17" D x 13" H. Racks and docking kits sold separately. International models may require separate purchase of License Plate Relocation Kit P/N 60095-00A.

Fits '00-later Softail® models (except Deuce, Rocker and FXSTSSE3) equipped with Detachable Solo or Two-Up Tour-Pak Rack. Fits '97-later Touring models (except Trike) equipped with Detachable Two-Up or Solo Tour-Pak Racks. Fits '04-later XL models equipped with Solo Tour-Pak Rack. '10 FLSTSE models require separate purchase of Mounting Hardware Kit P/N 54245-10.

<b>D. 53209-09</b> Leather Heritage Softail® Classic Styling.	<b>\$649.95</b>
<b>E. 53055-05A</b> Leather Softail Deluxe Styling.	<b>\$649.95</b>
<b>F. 53690-06A</b> Smooth Styling.	<b>\$499.95</b>
<b>G. 54114-10</b> CVO® Softail. Convertible Styling – Leather with Buffalo Inserts.	<b>\$649.95</b>

## H. TOUR-PAK® LID ORGANIZER

A true innovation in storage convenience and efficiency, this ingenious lid organizer helps keep smaller items conveniently located under your Tour-Pak lid for easy access. The organizer features five different-sized nylon-meshed pockets, as well as two flaps for additional storage. A great way to keep keys, cell phones, glasses, and papers handy.

<b>54011-04</b> Fits models equipped with Leather or Synthetic Leather Tour-Pak Luggage (except P/N 79189-06). Does not fit with Tour-Pak Luggage Racks, Interior Light Kits or Lock Kits.	<b>\$89.95</b>
---	----------------

## I. LINER FOR LEATHER TOUR-PAK LUGGAGE

This liner features a dual-direction zipper, map pocket and convenient carrying straps. The liner is constructed of water-resistant nylon, and features an embroidered Bar & Shield logo. Designed specifically to fit Leather Tour-Pak Luggage.

<b>53621-98</b> Fits Harley-Davidson® Leather Tour-Pak Luggage.	<b>\$39.95</b>
--	----------------

# 256 SOFTAIL®

## Saddlebags & Luggage

### A. HERITAGE LEATHER TOURING BAG

Styled to match Heritage Softail® Classic models, this bag features chrome spots, buckles, and heavy-duty wide leather straps. With quick-disconnect clips for easy removal and 720 cubic inches of storage space, this bag is as convenient as it is cavernous.

**98864-97 \$299.95**

Fits Softail models equipped with Luggage Rack P/N 53465-87B, 56465-86A or 53713-96.

### B. MESSENGER BAG SISSY BAR LUGGAGE

Tapered "messenger" style bag easily mounts to the sissy bar, and adds needed storage space to your custom ride. The heavy leather lid with embossed Bar & Shield logo features a traditional strap and buckle look, but conceals quick-disconnect clips for easier access. The rigid back shell helps the bag maintain its shape, and the built-in water-resistant polyester liner with drawstring closure keeps items dry inside. Dimensions: 10" W x 12" T x 9.5" D; Luggage capacity: 925 cubic inches. Installation requires a sissy bar upright, backrest pad, and bobtail luggage rack.

**94792-08 \$159.95**

Fits FLSTSB and FX Softail models (except FXCW/C FXSTD and FXSTSSE3) equipped with Bobtail Luggage Rack, Passenger Backrest Pad, and One-Piece Sissy Bar Upright P/N 52729-08, 51853-07, or Original Equipment FXSTC Upright.

### C. FORK BAG

Add a touch of leather up front with this functional fork bag. Styled to complement the Softail® Rocker™ model's fuel tank badge and accessory saddlebags, the embossed Bar & Shield logo makes a simple statement. The durable mounting bracket helps keep the bag in place, and the heavyweight leather will last for years to come.

**92352-08 \$79.95**

Fits '08-later FXCW and FXCWC models.

### D. RACK BAGS FOR SOFTAIL® DEUCE™

The perfect accessory for cruising around town or taking short trips on your Softail Deuce model. Constructed with a polyethylene liner to keep out water and help it retain its shape, this bag carries like a suitcase for your convenience. Custom designed to fit the Softail Deuce Passenger Upright and Rack. The Bar & Shield logo and build-in raincover add reflective surfaces for maximum visibility. Dimensions: 16" W x 10.5" D x 12" T, Luggage Capacity: 1700 cubic inches.

**98870-00B \$149.95**

Fits '00-'07 FXSTD models equipped with Passenger Sissy Bar Upright P/N 51114-00 and Luggage Rack P/N 53806-00, and Passenger Backrest P/Ns 52549-00 and 51534-00.

### E. FAT BOY® LEATHER TOOLBOX – LEFT HAND

Braided leather valance, chrome eyelets and Fat Boy styling with the convenience and durability of leather construction.

**64219-96 \$104.95**

Fits '84-'07 Softail® models (except FLSTC, FLSTS, FXSTD, '05-later FLSTN and FLSTSC models, '06-'07 FXST, FXSTB, FXSTC, FXSTS, or models equipped with Harley-Davidson® Dual Fishtail Exhaust System P/N 65281-92B or Dual Exhaust P/N 65281-96). '00-'07 Softail models require use of footboards or Footpeg Extension Kit P/N 49352-00. Does not fit with saddlebags.



A. HERITAGE LEATHER TOURING BAG



B. MESSENGER BAG SISSY BAR LUGGAGE



C. FORK BAG



D. RACK BAG FOR SOFTAIL DEUCE



E. FAT BOY LEATHER TOOLBOX – LEFT HAND

Notice: The prices appearing in this catalog are the manufacturer's suggested retail prices. Actual retail prices may vary.



F. SOFTAIL TOOLBOX – GLOSS BLACK



F. SOFTAIL TOOLBOX – CHROME



F. SOFTAIL CHROME TOOLBOXES



G. SOFTAIL TOOLBOX LINER

**F. SOFTAIL® TOOLBOX**

Add a traditional touch to your modern classic. Mirror-chrome and gloss black teardrop-shaped Toolbox with latch provides just enough convenient storage space for your personal items. Kit includes chrome-plated mounting brackets and universal barrel-style locks with keys. Top-hinged toolbox accepts nylon Toolbox Liner P/N 91838-92 (*sold separately*) for packing ease.

**64227-08** Right Hand, Chrome. **\$89.95**

Fits '08-later FXST, FXSTB and FXSTC models. All models require Spacer Kit P/N 49352-00 if used with Original Equipment passenger footpegs. Spacer kit not required with Passenger Footboard Kit P/N 50602-00.

**64216-09** Left Hand, Gloss Black. **\$89.95**

Fits '08-later FXST, FXSTB, FXSTC, FLSTF, FLSTFB and FLSTSB models. All models require Spacer Kit P/N 49352-00 if used with Original Equipment passenger footpegs. Spacer kit not required with Passenger Footboard Kit P/N 50602-00. FLSTSB models require separate purchase of Screw P/N 94399-92T and Washer P/N 6595HB.

**64230-08** Left Hand, Chrome. **\$89.95**

Fits '08-later FXST, FXSTB, FXSTC, FLSTF, FLSTFB and FLSTSB models. All models require Spacer Kit P/N 49352-00 if used with Original Equipment passenger footpegs. Spacer kit not required with Passenger Footboard Kit P/N 50602-00. FLSTSB models require separate purchase of Screw P/N 94399-92T and Washer P/N 6595HB.

**64982-07** Right Hand, Chrome. **\$89.95**

Fits '06-'07 FXST, FXSTB, FXSTC, and FXSTS models. Fits with all H-D Passenger Footboard Kits. All models require Spacer Kit P/N 49352-00 if used with Original Equipment passenger footpegs. Spacer kit not required with Passenger Footboard Kits.

**64983-07** Left Hand, Chrome. **\$89.95**

Fits '06-'07 FXST, FXSTB, FXSTC, FXSTS and '07 FLSTF, FXSTSE models. Fits with all H-D Passenger Footboard Kits. All models require Spacer Kit P/N 49352-00 if used with Original Equipment passenger footpegs. Spacer Kit not required with Passenger Footboard Kits.

**64938-00** Left Hand, Chrome. **\$89.95**

Fits '00-'06 FLSTF (except '06 FLSTFSE2), '00-'05 FXST, FXSTB, FXSTS and '05-'07 FLST and FLSTN models. All models (except FLSTN) require Spacer Kit P/N 49352-00 if used with Original Equipment passenger footpegs. Not required with Passenger Footboards P/N 50602-00.

**64937-00A** Right Hand, Chrome. **\$89.95**

Fits '00-'05 FXST, FXSTB, FXSTS, '00-'07 FLST, FLSTN, FLSTC, FLSTS and FLSTSC models. All models (except FLSTN) require Spacer Kit P/N 49352-00 if used with Original Equipment passenger footpegs. Not required with Passenger Footboards P/Ns 50955-00 and 50602-00. '00-'07 FLSTC models require Saddlebag Relocation Kit P/N 90238-00 with Original Equipment footpegs or footboards.

**64207-89B** Left Hand, Chrome. **\$89.95**

Fits all '84-'99 Softail models including '90-'99 FLSTC/FLSTN models. (Does not fit FLSTS or FLSTSC.) (Will not work with Dual Fishtail Exhaust P/N 65281-92B or Dual Exhaust P/N 65281-96.) Replacement Key P/N 64204-96.

**64201-85C** Right Hand, Chrome. **\$89.95**

Fits '84-'99 Softail models (except FLSTF, FLSTN and FLSTS models). This right side toolbox will work with Dual Fishtail Exhaust. ('90-'99 FLSTC models require Toolbox Relocation Kit P/N 64210-90A.) Replacement Key P/N 64204-96.

**G. SOFTAIL TOOLBOX LINER**

Made of tough 1000 denier nylon with silkscreened Bar & Shield logo. Features a full-length zipper and two elastic straps to secure several tools.

**91838-92** **\$19.95**

Fits both left and right side toolboxes.

# SOFTAIL® SUSPENSION

## NEVER IN A TIGHT SPOT

*On the road, you've got to feel good in the saddle. Whether you're cruising around town or out for the long haul, your bike should welcome you like an old friend and feel like an extension of yourself. Once you've picked the bike, it's time to choose the suspension that best equips your ride to your personal dimensions.*

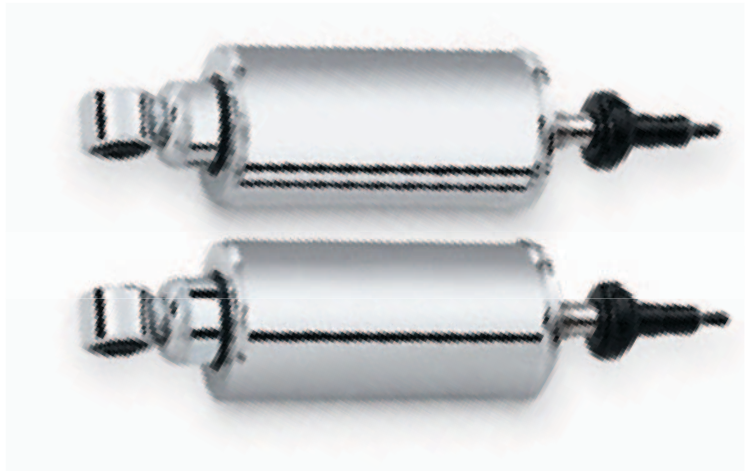

### A STRONG FOUNDATION



Being sure-footed at a stop or when parking your bike enhances your feeling of control and confidence. Adjusting the ride height by lowering the suspension may be the first step in fitting the bike to your inseam length. Combining a low-profile suspension and a narrow seat is the easiest way for a shorter rider to fit comfortably on a larger bike.

### THE FIT SHOP LIST



Here are a few options to consider when outfitting your bike to fit you. Find your model, and flip to the pages for more information.

2010	SUSPENSION	SEATS	HAND CONTROLS	FOOT CONTROLS
FXCWC	N/A	N/A	Drag Handlebar (pg. 589) Mini-Ape Bar (pg. 582)	Extended Reach Forward Control Kit (pg. 293)
FXST/ FXSTC	Profile® Low Front Suspension Profile Low Rear Suspension Rear Lowering Kit (pg. 259)	Reach® Seat Brawler® / Sidekick® Seat Badlander® Seat Tallboy® Seat (pg. 219-226)	Various handlebar and / or riser options (pg. 576-597)	Extended Reach Forward Control Kit (pg. 293)
FLSTF	Same as above (pg. 259)	Same as above (pg. 219-226)	Same as above (pg. 576-597)	Forward Control Kit (pg. 293)
FLSTFB	Profile Low Front Suspension (pg. 259)	Same as above (pg. 219-226)	Same as above (pg. 576-597)	N/A
FLSTC	Profile Low Front Suspension Profile Low Rear Suspension Rear Lowering Kit (pg. 259)	Reach Seat Tallboy Seat (pg. 226)	Same as above (pg. 576-597)	Forward Control Kit (pg. 293)
FLSTN	Profile Low Front Suspension (pg. 259)	Same as above (pg. 226)	Same as above (pg. 576-597)	Forward Control Kit (pg. 293)
FLSTSB	N/A	Leather Spring Solo Seat Reach Seat / Badlander Seat Brawler / Sidekick Seat Tallboy Seat (pg. 219-226)	Same as above (pg. 576-597)	Forward Control Kit (pg. 293)





**A. PROFILE LOW FRONT SUSPENSION – FL SOFTAIL ('07-LATER MODELS)**



**A. PROFILE LOW FRONT SUSPENSION – FL SOFTAIL ('89-'06 MODELS)**



**B. PROFILE LOW FRONT SUSPENSION – FX SOFTAIL**



**C. REAR LOWERING KIT**



**D. PROFILE LOW REAR SUSPENSION – CHROME**

**A. PROFILE® LOW FRONT SUSPENSION\***

Designed by Harley-Davidson to lower the front fork approximately 1" while preserving ride quality. Springs are wound to allow a compliant, yet controlled ride.

**54758-07** **\$99.95**

Fits '07-later FLSTC, FLSTN and '08-later FLSTF and FLSTFB models. Heritage, Fat Boy® and Fat Boy Special (Europe/UK) models must also be equipped with Profile Low Rear Suspension Kit P/N 54651-05, 54652-05 or 54001-04A.

**54596-94** **\$139.95**

Fits '89-'06 FLST, FLSTC, FLSTF and FLSTN Softail® models. Must only be installed on vehicles equipped with Profile Low Rear Suspension P/Ns 54588-94, 54665-03, 54648-00A, 54651-05, 54652-05 or 54001-04A.

**B. PROFILE LOW FRONT SUSPENSION\***

Designed by Harley-Davidson to lower the front fork approximately 1" while preserving ride quality. Springs are progressively wound for a compliant, yet controlled ride. Must only be installed on vehicles equipped with low-profile rear suspension.

**54621-05** **\$99.95**

Fits '00-later FXST, FXSTB and FXSTC models equipped with Profile Low Rear Suspension P/N 54648-00A, 54665-03, 54651-05, 54652-05 or Rear Lowering Kit P/N 54001-04A. Also fits '00-'05 FXDWG models equipped with Low Rear Shock Kit P/N 54594-03 or Premium Billet Profile Low Rear Suspension P/N 54592-03.

**C. REAR LOWERING KIT\***

Provides low cost alternative to buying complete shocks. This kit is for the rider that simply wants to lower their bike inexpensively, and have some ride height adjustability. Kit will lower seat height up to 1".

**54001-04A** **\$99.95**

Fits '00-later Softail® models (except FXSTD, FXCW, FXCWC, FLSTFB, FLSTN, FLSTSB, FXSTSSE/2/3 and FLSTFSE/2). Does not fit models equipped with Profile Lowering Kits P/N 54651-05, 54588-94 or 54652-05.

**D. PROFILE® LOW REAR SUSPENSION\***

This suspension lowers the seat height approximately 1" (P/N 54588-94) or 3/4" (P/N 54651-05 and 54652-05) while preserving ride quality. Spring and damping rates are tailored for Softail models to ensure a controlled ride. Shocks feature multi-staged damping to ensure optimal performance under varying conditions. Kit includes a pair of rear shock absorbers and a Softail® shock spring preload adjustment wrench. Compatible with Profile Low Front Suspension.

Fits '00-later Softail® models (except FXSTD, FLSTFB, FLSTSE and FXCW/C). Does not lower '05-later FLSTN, FLSTSB, FLSTFB, FLSTSE, '07 FXSTD and FXSTSSE/2/3 models. Also fits '10 Fat Boy Special model in UK, Europe, Brazil, and select international markets that are factory-equipped with standard-height rear suspension.

**54651-05** Chrome. **\$349.95**

**54652-05** Black. **\$284.95**

Fits '89-'99 Softail models, including '97-'99 FLSTS.

**54588-94** Chrome. **\$369.95**



**\*WARNING:** The Profile® Low Front Spring Kit cannot be used independently and must be used with the appropriate Profile Rear Shock Lowering Kit. Installation of any accessory suspension components may affect cornering clearance and jiffy stand operation. This could distract the rider, causing loss of control and death or serious injury.



**\*WARNING:** The Jiffy Stand included in the Front Suspension Kit is designed solely for use with this Harley-Davidson® Profile Suspension Kit and must be installed. This Jiffy Stand is not designed or intended for use in other applications. Improper application may affect jiffy stand operation. This could distract the rider, causing loss of control, resulting in death or serious injury.



**\*WARNING:** Installation of any accessory suspension components may affect cornering clearance and jiffy stand operation. This could distract the rider, causing loss of control and death or serious injury.

## DEFINE YOUR LOOK

*Customizing your motorcycle is about selecting accessories that work together to reflect your personality. Envision your bike as a whole and choose the options that will make that vision a reality. Developing a “look” for your bike doesn’t have to be difficult; before you start, just decide on a direction and stick with it.*



### BLACK & CHROME

Genuine H-D® Accessories are developed by the same folks that built your bike, so you can be assured that plated or painted parts will match the Original Equipment finishes for a unified look.

## FOCUS ON THE PROFILE

### FRONT END TRIM

Custom fork sliders, wheels and rotors put your sense of style front and center. And simple additions like custom axle covers and hardware finish the look.

### REAR END TRIM

A chrome swingarm and custom wheels make a major visual impact, and easy-to-install axle covers, belt guards and custom hardware give a unified look.

### WHEELS & BRAKES

Custom calipers, wheels and rotors can have a radical impact on the look, but small additions like caliper trim and chrome hardware can provide subtle style.

### CHASSIS TRIM

One of the easiest ways to customize your motorcycle is adding decorative covers. Fender trim, component covers and custom hardware all grab your attention.

### HAND CONTROLS

Adding mirrors, grips and a little chrome puts style in full view of the rider. A custom master cylinder, switch covers and hand levers give instant gratification.

### FOOT CONTROLS

Custom foot pegs, foot levers and shift linkages offer exceptional function and style, and highway pegs and engine guards add comfort and engine protection.

### CONSOLES & GAUGES

The link between your brain and the bike. Auxiliary gauges help you monitor your engine's vital signs, and a custom console says a lot beyond the numbers.

### ENGINE TRIM & HARDWARE

The V-Twin engine is the heart of the bike. Adding well-chosen covers, a custom air cleaner and a decorative collection instantly sets your bike apart from stock.

### LIGHTING

Lighting adds distinctive style and aids visibility. Choose from a variety of auxiliary lamps, headlamp trim and LED lighting to grab maximum attention.

### PERFORMANCE

Performance options make a styling statement as well. Screamin' Eagle® high-flow air cleaners and custom exhaust systems show that you mean business.

# 262 SOFTAIL®

Chassis Trim – Front End

## A. CHROME FRONT END KITS\*

The front forks on a Harley-Davidson® motorcycle set the tone for the bike, and can lead the way to a full-bore custom statement. So start customizing by adding chrome where it will have the most noticeable impact on the overall look of the bike, your front end. This package includes components necessary to completely chrome the front forks and includes some or all of the following (Kit components vary depending on your model): Chrome Fork Sliders, Chrome Fork Axle Retainer Nut Kit, Chrome Fork Slider Drain Screw Kit, Chrome Front Wheel Spacers, Classic Chrome Front Axle Nut Cover Kit, and Chrome Upper Fork Nut Covers.

**1. 46501-08A** **\$559.95**

Fits '08-later FLSTF and FLSTFB models.

**2. 46334-07B** **\$559.95**

Fits '07-'08 FLSTC models.

**3. 46536-07B** **\$529.95**

Fits '07-later FLSTN and '09-later FLSTC models.

**4. 46333-07B** **\$464.95**

Fits '07-later FXST, FXSTB and FXSTC models.

\*Chrome Front End Package price does not include labor or supplies.



A. CHROME FRONT END KIT – FAT BOY SHOWN



A. CHROME FRONT END KITS

Notice: The prices appearing in this catalog are the manufacturer's suggested retail prices. Actual retail prices may vary.





B

**B. CHROME LOWER FORK SLIDERS FOR FL SOFTAIL MODELS**



C

**C. CHROME UPPER FORK SLIDER COVERS**



NEW

D

**D. GLOSS BLACK LOWER FORK SLIDERS**



E

**E. GLOSS BLACK UPPER FORK SLIDER COVERS**



F

**F. CHROME LOWER FORK SLIDERS FOR FX SOFTAIL MODELS**



G

**G. GLOSS BLACK LOWER FORK SLIDERS – FX SOFTAIL**

**B. CHROME LOWER FORK SLIDERS FOR FL SOFTAIL® MODELS**

Competitively-priced, these chrome-plated Lower Fork Sliders give your bike upfront style. To ensure proper fitment and function, these sliders are manufactured from Original Equipment components. Form follows function, with polished, triple chrome-plating and a stamped "Harley-Davidson" logo for product identification. Kit includes right and left slider and the bottom axle retainer. '07-later model kits also include chrome drain screws, chrome axle retainer nuts, and oil seals.

**46482-07B** **\$299.95**

Fits '07-later FLSTC, FLSTN and '08-later FLSTF and FLSTFB models.

**46482-00** **\$299.95**

Fits '00-'06 FLST, FLSTC, FLSTF, and FLSTN models.

**45310-98** **\$329.95**

Fits '86-'99 FLSTC, FLSTF and FLSTN models.

**C. CHROME UPPER FORK SLIDER COVERS**

Brilliant chrome accents for the upper fork legs. Perfect for finishing off that chromed front end look. When used with H-D® Genuine Motor Accessory Chrome Lower Fork Sliders, you've got a front end that's completely chromed and an appearance that's utterly impressive.

**45963-97** **\$69.95**

Fits '49-'84 FL, '80-later Touring models (except Trike) and '86-later FLST, FLSTC, FLSTF (except '07), FLSTFB, FLSTSE and FLSTN models. (pair)

**48752-07** Left. Fits '07 FLSTF models only. **\$42.75**

**48753-07** Right. Fits '07 FLSTF models only. **\$42.75**

**D. GLOSS BLACK LOWER FORK SLIDERS**

These gloss black coated sliders are the ultimate extension of your bike's "dark side" and make a perfect custom addition to your blacked-out FL Softail model. Manufactured to Original Equipment specifications, the durable black coating is a great match to other H-D® black components. Add matching Gloss Black Upper Fork Slider Covers P/N 45591-02 for a complete look.

**48645-09** **\$299.95**

Fits '07-later FLSTC, FLSTN, '08-later FLSTF and FLSTFB models. '07 models require separate purchase of Screw P/N 4042 (Qty 2) and Washer P/N 7062 (Qty 2).

**E. GLOSS BLACK UPPER FORK SLIDER COVERS**

The classic Harley-Davidson motorcycle color is black. It shows your attitude, your feelings and your desire to be different from the rest. These gloss black accessories are the ultimate extension of the Harley-Davidson philosophy. Manufactured from Original Equipment components, these parts provide superior fit and finish.

**45591-02** **\$59.95**

Fits '49-'84 FL, '80-later Touring models (except Trike) and '86-later FLST, FLSTC, FLSTF (except '07) FLSTFB, FLSTSE and FLSTN models.

**F. CHROME LOWER FORK SLIDERS FOR FX SOFTAIL MODELS**

Competitively-priced, these chrome-plated Lower Fork Sliders give your bike upfront style. To ensure proper fitment and function, these sliders are manufactured from Original Equipment components. Form follows function, with polished, triple chrome-plating and a stamped "Harley-Davidson" logo for product identification. Kit includes right and left slider and the bottom axle retainer. '07-later model kits also include chrome drain screws, chrome axle retainer hardware, and oil seals.

**46477-07B** **OBSOLETE** **\$299.95**

Fits '07-later FXST and FXSTB models.

**48660-07** Fits '07-later FXSTC models. **\$299.95**

**46477-00** **\$299.95**

Fits '00-'05 FXDWG and '00-'06 FXST and FXSTB models.

**45305-98** **\$329.95**

Fits '91-'99 FXDWG, FXST, FXSTB and FXSTC models.

**G. GLOSS BLACK LOWER FORK SLIDERS**

These gloss black coated sliders are the ultimate extension of the FXSTB Night Train® model's "dark side" and make a perfect custom addition to any Softail® Night Train or Softail Standard. The sliders are built to Original Equipment specifications and the durable black coating is applied to H-D standards.

**45719-02** **\$249.95**

Fits '00-'05 FXDWG and '00-'06 FXST and FXSTB models.



# 264 SOFTAIL®

Chassis Trim – Front End

## A. CUSTOM INVERTED FRONT FORK KIT

Add a whole new dimension to your motorcycle's front end. Dressed in chrome or gloss black, these big, beefy forks lead your bike in a new custom direction. Featuring leading-edge cartridge damping technology, this 52mm Inverted Front Fork Kit provides a comfortable ride that complements the show-winning looks. From the hidden axle mount to the forged aluminum triple tree, the highly polished fork assembly is loaded with custom details. The forged aluminum axle holder features integrated mounting points that accept Original Equipment fenders and brake calipers without the need for additional brackets. This clean look continues to the billet aluminum outer fork tubes, and to the chrome pinch bolts on the triple tree. Top off the custom look with the smooth contour upper triple tree that accepts Original Equipment or accessory handlebars. Manufactured to Harley-Davidson specifications by Marzocchi, this complete fork kit can be used with Original Equipment fork lock. Kit includes chrome-plated installation hardware. Kit requires separate purchase of Axle Kit, Steering Head Bearings, Dust Seals, and Braided Brake Lines. FXSTB models require separate purchase of Front Directional Mounting Kit. See your Dealer for details.

Fits '00-later FXST, FXSTB and FXSTC models. Does not fit with Styled Chrome Front Caliper Kit P/N 44910-05, Front Caliper Cover P/N 43759-00 or Chrome Front Wheel Spacer Kit P/N 41580-03A. All models require separate purchase of model-specific axle kit and additional components.

<b>46321-05B</b>	Chrome.	<b>\$1,299.95</b>
<b>48646-06A</b>	Gloss Black.	<b>\$1,299.95</b>

### Requires separate purchase of:

Axle Kit, 3/4"	<b>42134-06</b>	('00-'06 models)
Axle Kit, 25mm	<b>42136-07</b>	('07-later models)

### Braided Brake Line\*

FXST:	<b>42366-07</b>	(lower) and <b>42772-07</b>	(upper)
FXSTB:	<b>42366-07</b>	(lower) and <b>42385-07</b>	(upper)
FXSTC:	<b>42366-07</b>	(lower) and <b>42752-07</b>	(upper)
Upper Dust Shield	<b>48361-80</b>		
Lower Dust Shield	<b>48365-48A</b>		
Roller Bearing (quantity 2)	<b>48300-60</b>		

### FXSTB requires additional purchase of:

Front Directional Mounting Kit	<b>68266-03</b>
Ball Stud (quantity 2)	<b>67822-88</b>

\*For Original Equipment handlebars. See your dealer for appropriate brake Lines if used with other handlebars.

### Also available:

#### INVERTED FRONT FORK AXLE KIT

Required for installation of Custom Inverted Front Fork Kit P/N 46321-05B or 48646-06A. Kit includes axle and set screw.

<b>42134-06</b>	3/4" Axle.	<b>\$49.95</b>
Fits '00-'06 FXST and FXSTB models equipped with Custom Inverted Fork Kit P/N 46321-05B or 48646-06A.		
<b>42136-07</b>	25mm Axle.	<b>\$49.95</b>
Fits '07-later FXST, FXSTB and FXSTC models equipped with Custom Inverted Fork Kit P/N 46321-05B or 48646-06A.		



A. CUSTOM INVERTED FRONT FORK KIT – CHROME



A. CUSTOM INVERTED FRONT FORK KIT – GLOSS BLACK

Notice: The prices appearing in this catalog are the manufacturer's suggested retail prices. Actual retail prices may vary.

**B. CHROME LOWER FRONT FORK DUST COVER****C. DECORATIVE CHROME FORK JOINT COVERS****D. FORK BRACE****E. CHROME FRONT FENDER HARDWARE KIT****F. CHROME FORK AXLE RETAINER NUT KIT****G. CHROME FORK SLIDER DRAIN SCREW KIT****B. CHROME LOWER FRONT FORK DUST COVER**

Replace your stock black rubber fork slider seal with this beautiful chrome billet aluminum 6061-T6 dust cover.

**45243-00** **\$59.95**

Fits '84-'89 FXSTC, '84-later FXST, FXSTB, '91-'05 FXDWG and '80-'86 FXWG models.

**C. DECORATIVE CHROME FORK JOINT COVERS**

Easy-to-install and requires no tools.

**45415-82** **\$59.95**

Fits '84-'89 FXSTC, '84-later FXST, FXSTB, '93-'05 FXDWG and '80-'86 FXWG models.

**D. FORK BRACE**

This chrome-plated Fork Brace adds style to the front end. The cross-brace open web style reflects a performance heritage, and the multi-piece design allows easy installation.

**46097-98** 41mm. **\$134.95**

Fits '93-'05 FXDWG and '84-later FX Softail models (except Springer®, FXCW/C and FXSTD). (Will not fit with Chrome Lower Fork Sliders.)

**E. CHROME FRONT FENDER HARDWARE KIT**

Finish the show-winning look with brilliant chrome hardware. Manufactured to Original Equipment specifications, this kit replaces the zinc-plated exposed front fender mounting bolts with chrome-plated socket head cap screws.

**94415-05** **\$8.95**

Fits '91-later Softail® models (except FXCW/C, FXSTD and Springer®), and '93-'05 FXDWG models. Does not fit with Billet Fork Slider Kit or Inverted Front End Kit.

**F. CHROME FORK AXLE RETAINER NUT KIT**

It's the details that count. Complete the chrome transformation by adding this finishing touch to your chrome fork sliders. This Axle Retainer Nut Kit includes the stylish chrome-plated nuts and chrome lockwashers necessary to replace the stock hardware.

**45813-03** **\$7.95**

Fits '84-later Touring, '86-'07 FLST, FLSTC, FLSTF, FLSTN '91-'07 FXST and FXSTB, '07 FXSTC, and '91-'05 FXDWG models.

**G. CHROME FORK SLIDER DRAIN SCREW KIT**

It's the details that count. Complete the chrome transformation by adding this finishing touch to your chrome fork sliders. This Fork Slider Drain Screw Kit includes two chrome-plated drain screws and the seals required to replace the stock hardware.

**45848-03** **\$3.95**

Fits '87-later Softail® (except Springer, FXCW/C and FXSTD), '87-later Touring models, and '93-'05 FXDWG models.

**45815-03** **\$3.95**

Fits '73-later XL models (except XL Sport), '78-'86 FX models, '94-'05 Dyna® FXD/DL/DS-CONV., '99-'00 FXR2/3/4 models, and '00-'07 FXSTD models.

# 266 SOFTAIL®

Chassis Trim – Front End

## A. CLASSIC CHROME FRONT AXLE NUT COVER KIT

Covers are polished and chrome-plated. Includes set screws and Allen wrench for easy installation.

Fits '02-later VRSC™ models (except VRSCR and VRSCF), '08-later XL, '07-later Softail® (except Springer®, FXCW, FXCWC and FXSTD), '08-later Dyna® and '08-later Touring models.

<b>44116-07A</b>	Billet.	<b>\$41.95</b>
<b>44117-07A</b>	Die Cast.	<b>\$26.95</b>

Fits '84-'06 Softail (except Springer and FXSTD); '91-'03 FXD, FXDX, FXDXT, FXDL, FXDS-CONV.; '93-'05 FXDWG; '80-'99 Touring; '88-'07 XL, FXR and '87-later FLXR/FXRS-SP, FXWG models.

<b>43899-86A</b>	Die Cast.	<b>\$26.95</b>
------------------	-----------	----------------

Fits '88-'06 FXSTS Springer® models. (Does not fit FLSTS.)

<b>43894-90</b>	Die Cast.	<b>\$26.95</b>
-----------------	-----------	----------------

## B. GLOSS BLACK FRONT AXLE NUT COVER KIT

Gloss black covers conceal the front axle hardware for a clean, custom look. Kit includes set screws and Allen wrench for easy installation.

<b>43428-09</b>		<b>\$41.95</b>
-----------------	--	----------------

Fits '02-later VRSC models (except VRSCR and VRSCF), '08-later XL, '07-later Softail (except Springer, FXCW, FXCWC and FXSTD), '08-later Dyna and '08-later Touring models.

<b>41088-09</b>		<b>\$64.95</b>
-----------------	--	----------------

Fits '08-later FLSTSB models.

## C. "H-D MOTOR CO." LOGO FRONT AXLE NUT COVER KIT

Die-cast, chrome-plated covers feature the "Harley-Davidson Motor Co." logo in black. Includes set screws and Allen wrench for easy installation.

<b>44148-07A</b>		<b>\$26.95</b>
------------------	--	----------------

Fits '02-later VRSC models (except VRSCR and VRSCF), '08-later XL, '07-later Softail (except Springer, FXCW, FXCWC and FXSTD), '08-later Dyna and '08-later Touring models.

<b>43864-96</b>		<b>\$28.95</b>
-----------------	--	----------------

Fits '84-'06 Softail (except Springer and FXSTD); '91-'03 FXD, FXDX, FXDXT, FXDL, FXDS-CONV.; '93-'05 FXDWG; '80-'99 Touring; '88-'07 XL, FXR and '87-later FLXR/FXRS-SP, FXWG models.

## D. WILLIE G.® SKULL COLLECTION FRONT AXLE NUT COVER KIT

Add a little attitude to your ride. Styled to complement Harley-Davidson® Skull accessory items, the menacing raised skull with black-filled eyes leaps from a field of chrome. The surrounding "Harley-Davidson Motorcycles" script is the perfect finishing touch. The Axle Nut Covers are easy-to-install, and include all necessary mounting hardware (*sold in pairs*).

<b>43163-08A</b>		<b>\$28.95</b>
------------------	--	----------------

Fits '88-later XL, '84-later Softail (except Springer, FXCW, FXCWC and FXSTD), '02-later VRSC (except VRSCR and VRSCF), '91-later Dyna, and '99-later Touring models.



A. CLASSIC CHROME FRONT AXLE NUT COVER KIT – BILLET



A. CLASSIC CHROME FRONT AXLE NUT COVER KIT – DIE CAST



B. GLOSS BLACK FRONT AXLE NUT COVER KIT

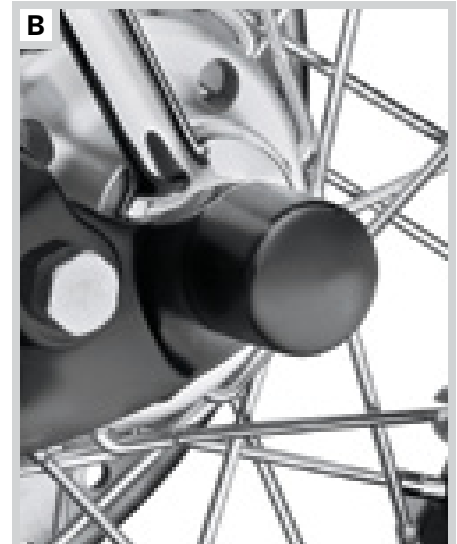

B. GLOSS BLACK FRONT AXLE NUT COVER KIT – SPRINGER



C. "H-D MOTOR CO." LOGO FRONT AXLE NUT COVER KIT



D. WILLIE G. SKULL COLLECTION FRONT AXLE NUT COVER KIT

Notice: The prices appearing in this catalog are the manufacturer's suggested retail prices. Actual retail prices may vary.



E

**E. ALUMINATOR CHROME BILLET FRONT AXLE NUT COVER KIT**



F

**F. TAPERED FRONT AXLE NUT COVER KIT**



G

**G. CHROME FRONT WHEEL SPACER KIT – STRAIGHT**



H

**H. CHROME FRONT WHEEL SPACER KIT – DOME**



I

**I. CHROME FRONT WHEEL SPACERS – TAPERED**



J

**J. TEARDROP FRONT FORK ROCKER COVER KIT**

**E. ALUMINATOR® CHROME BILLET FRONT AXLE NUT COVER KIT**

Chrome-plated aluminum Billet Axle Cover Kit with the classic styling of the Aluminator Collection. Includes mounting hardware and wrench for easy installation.

**44114-07** **\$41.95**

Fits '07-later Softail® models (except Springer®, FXCW, FXCWC and FXSTD), '08-later Dyna® and Touring (except Trike) and '02-later VRSC™ models (except VRSCR and VRSCF).

**43907-94** **\$41.95**

Fits '84-'06 Softail® (except Springer and FXSTD); '91-'03 FXD, FXDX, FXDXT, FXDL, FXDS-CONV.; '93-'05 FXDWG; '80-'99 Touring; '88-'07 XL, FXR and '87-later FLXR/FXRS-SP, FXWG models.

**F. TAPERED FRONT AXLE NUT COVER KIT**

Thanks to an exclusive contoured profile, these unique chrome die-cast Front Axle Nut Covers appear smaller than others when installed.

**44109-07** **\$26.95**

Fits '07-later Softail® models (except Springer®, FXCW, FXCWC and FXSTD), '08-later Dyna and Touring (except Trike) and '02-later VRSC™ models (except VRSCR and VRSCF).

**G. CHROME FRONT WHEEL SPACER KIT – STRAIGHT**

There's always more room for chrome with these highly-polished Chrome Wheel Spacer Kits. They're manufactured to the Original Equipment tolerances, so you get exact product fitment and quality.

**41597-07** **\$29.95**

Fits '07-later FXST, FXSTB, FXSTC and FXSTD models. Also fits Softail® models equipped with Inverted Front Fork Kit and 25mm Axle Kit P/N 42136-07.

**41583-07** **\$29.95**

Fits '07-later FLSTF, FLSTFB, FLSTC and FLSTN models. FLSTC and FLSTN models require removal of Original Equipment hub cap.

**41597-00** **\$29.95**

Fits '00-'06 FXST, FXSTB, FXSTD and '00-'05 FXDWG models. Also fits models equipped with Inverted Front Fork Kit and 3/4" Axle Kit P/N 42134-06 or Billet Fork Sliders P/N 46280-03. (Does not fit '03-'04 FXSTDSE.)

**41583-03** **\$29.95**

Fits '00-'06 FLST, FLSTF, FLSTC and FLSTN models. FLSTC and FLSTN models require removal of Original Equipment hub cap.

**H. CHROME FRONT WHEEL SPACER KIT – DOME**

Fill the gap between the wheel and the fork slider with this unique Spacer Kit. The rounded design complements any wheel and rotor combination, and looks great with chrome fork sliders. Kit includes left and right side spacers.

**41625-04** **\$39.95**

Fits '00-'06 FLST, FLSTF, FLSTC and FLSTN models. FLSTC and FLSTN models require removal of Original Equipment hub cap.

**41580-03A** **\$39.95**

Fits '00-'06 FXST, FXSTB, FXSTD and '00-'05 FXDWG models. (Does not fit '03-'04 FXSTDSE or models equipped with Inverted Front Fork Kit and 3/4" Axle Kit P/N 42134-06 or Billet Fork Sliders P/N 46280-03.)

**I. CHROME FRONT WHEEL SPACERS – TAPERED**

Complete your total front end with these highly polished chrome-plated Wheel Spacers. Manufactured to the Original Equipment tolerances, they deliver exact fitment and custom shine.

**41522-08** **\$29.95**

Fits '08-later FXCW and FXCWC models. Does not fit with Road Winder Custom Wheel P/N 44659-07.

**J. TEARDROP FRONT FORK ROCKER COVER KIT**

Nostalgic chrome-plated styling that seems to be in constant motion. Easily installs on Heritage Springer® models without removing wheel.

**43161-97** **\$69.95**

Fits '97-'03 FLSTS and '05-'07 FLSTSC models.



# 268 SOFTAIL®

Chassis Trim – Front End

## A. FREIGHT TRAIN CHROME HEADLIGHT NACELLE

If the chrome from this nacelle seems to reflect the image of the 1960s FL models, that's because the spirit of the past is built right in. Bold locomotive styling adds visual strength to the bike's profile, and stretches the rider's view to the horizon when looking over the headlamp. Coupled with the separate purchase of the Chrome Nacelle Hardware Kit P/N 67897-96B, the nacelle fits with an existing H-D® windshield and/or passing lamps. Kit includes hardware required for installation of the nacelle with a detachable windshield without passing lamps. Separate Hardware Kit is required when installing nacelle with passing lamps or rigid mount windshield. For an even bolder look, add a Headlamp Trim Ring P/N 69627-99 or 69733-05.

**67907-96C** **\$399.95**

Fits '86-later FLST, FLSTF, FLSTFB and FLSTC models. '07-later FLSTF and FLSTFB require separate purchase of Riser Kit P/N 56789-05. '09-later FLSTC requires separate purchase of Riser Kit P/N 46809-09.

### Also available:

#### RISER KIT FOR FREIGHT TRAIN HEADLIGHT NACELLE

Required for installation of Freight Train Headlamp Nacelle.

**46809-09** **\$59.95**

Fits '09-later FLSTC models equipped with Freight Train Headlight Nacelle Kit P/N 67907-96C.

**56789-05** **\$119.95**

Fits '07-later FLSTF and FLSTFB models equipped with Freight Train Headlight Nacelle Kit P/N 67907-96C.

## B. GLOSS BLACK FORK COVER KIT

Replace the factory-original satin finished fork covers with these rich gloss black editions for a sinister blacked-out look. Originally featured on the '10 FLSTFB Fat Boy Lo, this three-piece kit includes the ribbed front panel and the matching left and right side panels that wrap around the triple tree for a solid, no-nonsense appearance. Finish the look with Gloss Black Side Accent Strips P/N 68055-10BHP (2) and Black Headlamp Shell P/N 73294-10.

**48608-09** **\$139.95**

Fits '86-later FLST, FLSTC, FLSTF and '93-'96 FLSTN models. Does not fit '05-later FLSTN unless Original Equipment light bar is removed and front turn signals are installed. Stock on '10 FLSTFB models.

### Shown with:

#### GLOSS BLACK FORK COVER ACCENT STRIPS

These strips are designed to add the ultimate complement to the Gloss Black Fork Cover Kit. Finished in matching rich black, these extruded aluminum pieces fill the gap between the front and rear covers that is created when the passing lamps are removed. Strips are sold individually, and two are required for a complete installation.

**68055-10BHP** **\$8.95**

Fits '86-later FLST, FLSTC, FLSTF, '93-'96 FLSTN models with Gloss Black Fork Cover Kit P/N 48608-09. (Does not fit with passing lamps or windshields.)

### Also shown with:

#### GLOSS BLACK HEADLAMP SHELL

Add to the sinister look of your blacked-out Softail motorcycle. Manufactured from Original Equipment components, this gloss black headlamp housing replaces the chrome headlamp shell for a custom look. Shell includes wiring harness and connector, and accepts the Original Equipment headlamp, trim ring and mounting hardware.

**73294-10** Domestic. **\$134.95**

Fits '86-later FLST, FLSTC, FLSTF and FLSTN models in domestic and right-hand drive markets.

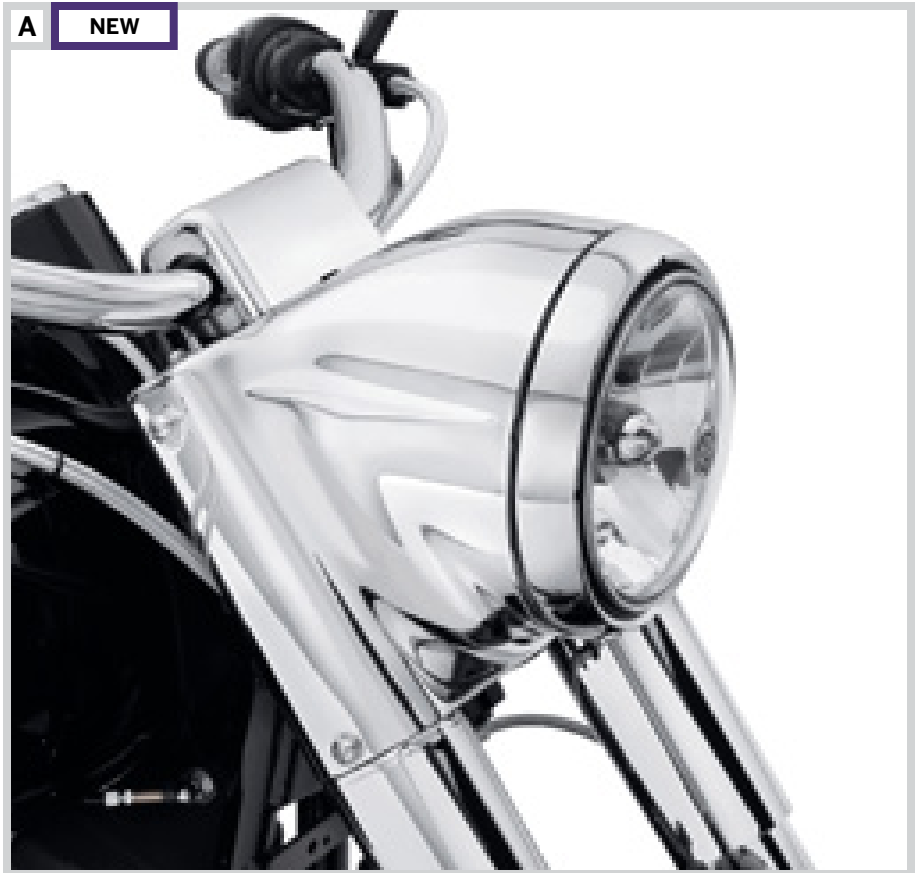

A. FREIGHT TRAIN CHROME HEADLIGHT NACELLE



B. GLOSS BLACK FORK COVER KIT – SHOWN WITH ACCENT STRIPS AND HEADLAMP SHELL

Notice: The prices appearing in this catalog are the manufacturer's suggested retail prices. Actual retail prices may vary.



C

C. CHROME FORK COVER KIT (SHOWN WITH CHROME FORK COVER ACCENT STRIP KIT)

**C. CHROME FORK COVER KIT**

Replace your factory-original satin fork covers with these brilliant, triple chrome-plated versions for a custom mirror-like shine.

**67890-91B** **\$139.95**

Fits '86-'08 FLST, FLSTC, FLSTF, and '93-'96 FLSTN models. Does not fit '05-later FLSTN unless Original Equipment light bar is removed.

**D. SMOOTH CHROME FORK COVER KIT**

Bring the smooth look of the Softail® Deluxe model to your Fat Boy® or Heritage Softail® Classic model. Mirror-finish chrome flows over the surface, and wraps around the triple tree for a custom fit. This three-piece kit includes smooth front panel and matching left and right side panels.

**66440-05** **\$109.95**

Fits '00-'08 FLST, FLSTF and FLSTC models. Does not fit with Auxiliary Lighting Kit P/N 69287-05. Will only fit with Deluxe Auxiliary Lighting Kit P/N 68669-05 or 68670-05.

**E. CHROME FORK COVER SIDE PANELS**

Complete the chrome finish of the Softail® Deluxe model Fork Cover. These side panels replace the polished panels that wrap around the rear of the triple tree. Easy-to-install, this kit includes left and right side panels.

**66441-05** **\$59.95**

Fits '05-later FLSTN, '07-later FLSTF, FLSTFB and '09-later FLSTC models.

**F. CHROME FORK COVER ACCENT STRIP KIT**

Sometimes the best ideas come from you, our fellow riders, like this chrome accent strip. This kit is designed to add the ultimate complement to the already popular Chrome Fork Cover Kit by accenting the sides with beautiful chrome-extruded aluminum strips. Kit includes chrome hardware.

**67891-99** **\$29.95**

Fits '86-later FLST, FLSTC, FLSTF, FLSTFB, '93-'96 FLSTN models with Chrome Fork Cover Kit P/N 67890-91A or 66440-05. (Does not fit with passing lamps and windshields.)



D

D. SMOOTH CHROME FORK COVER KIT



E

E. CHROME FORK COVER SIDE PANELS



F

F. CHROME FORK COVER ACCENT STRIP KIT

*Notice: The prices appearing in this catalog are the manufacturer's suggested retail prices. Actual retail prices may vary.*

# 270 SOFTAIL®

Chassis Trim – Front End

## A. CHROME LOWER TRIPLE TREE COVER

This Lower Triple Tree Cover dresses up the unfinished underside of the triple tree for a complete custom look. The chrome-plated steel cover installs easily, concealing the brake splitter fitting. All mounting hardware is included.

**66053-01** **\$38.95**

Fits '00-later FL Softail® models (except Springer® and FLSTN).

## B. CHROME LOWER TRIPLE TREE COVER

This Lower Triple Tree Cover dresses up the unfinished underside of the triple tree for a complete custom look. The chrome-plated steel cover installs easily on the underside of the triple tree, and all mounting hardware is included.

**66021-00** Fits '00-'07 FXSTD models. **\$38.95**

## C. CHROME UPPER FORK NUT COVERS

Highlighted with a unique Bar & Shield logo, these polished triple chrome-plated covers add an additional clean looking appearance to your upper fork. Kit comes complete with three covers, mounting hardware and wrench for easy, on-the-spot installation.

**46129-98B** **\$48.95**

Fits '86-later FLSTC, '90-later FLSTF, FLSTFB, '95-'05 FXD, '93-'05 FXDL, '94-'05 FXDS, and '88-later XL models (except XL Custom and 1200S models).

**45002-98** **\$49.95**

Fits '00-later FXST, FXSTB, FXSTD, and '86-later FXSTC models and '93-'05 FXDWG models.

## D. SOFTAIL® CHROME WIND DEFLECTORS

Add the fully-dressed look to Heritage Softail® Classic models.

**58125-90B** **\$69.95**

Fits '86-later FLST, FLSTC, FLSTF, FLSTFB, FLSTSE and '93-'96 FLSTN models equipped with Harley-Davidson® King-Size Windshield and/or Passing Lamp Kits. Does not fit Springer models.



A. CHROME LOWER TRIPLE TREE COVER



B. CHROME LOWER TRIPLE TREE COVER



C. CHROME UPPER FORK NUT COVERS

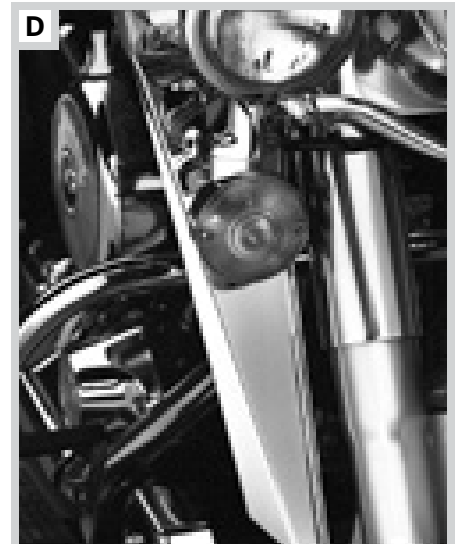

D. SOFTAIL CHROME WIND DEFLECTORS

Notice: The prices appearing in this catalog are the manufacturer's suggested retail prices. Actual retail prices may vary.



E. CHROME SWINGARM (SHOWN WITH CHROME UPPER BELT GUARD)

**E. CHROME SWINGARM**

The ultimate chrome accessory, mirror-polished to the highest standard using bright chrome-plating. Affordable and convenient with no troublesome exchanges necessary. Factory specifications guarantee exact fitment, unparalleled quality and an affordable price. Stamped with the Harley-Davidson Bar & Shield logo.

**48607-08** **\$549.95**  
Fits '08-later Softail® models (except FXCW and FXCWC).

**48663-08** **\$549.95**  
Fits '08-later FXCW and FXCWC models.

**48607-06** **\$549.95**  
Fits '06-'07 FXST, FXSTB, FXSTS and '07 FXSTC, FXSTSSE and FLSTF models.

**F. POLISHED STAINLESS STEEL REAR FENDER EXTENSION**

Polished to a mirror-finish that nearly looks like chrome, this extension adds additional beauty in an area that's usually overlooked. A great addition to any Softail model.

**60476-00A** Fits '00-'07 Softail models. **\$44.95**

**G. POLISHED STAINLESS STEEL REAR FENDER EXTENSION**

Designed to replace the black plastic rear fender splash guard, this stainless steel shield is formed to match the contour of the swingarm arc. Polished to a mirror-finish, this fender extension adds depth and dimension by reflecting light into a usually dark and hidden area. A great finishing touch to a chrome swingarm and custom wheel installation. Kit includes form-fitted stainless steel splash guard, attachment clips and chrome hardware.

**60197-08** **\$69.95**  
Fits '08-later Softail models (except FXCW, FXCWC and FXSTSSE3).



F. POLISHED STAINLESS STEEL REAR FENDER EXTENSION



G. POLISHED STAINLESS STEEL REAR FENDER EXTENSION



# 272 SOFTAIL®

Chassis Trim – Rear End

## A. CHROME UPPER BELT GUARD

Hand-polished and chrome-plated to replace your factory-equipped painted upper belt guard.

**60867-08** **\$105.00**

Fits '07-later FXST, FXSTB, FXCW, FLSTFB, FLSTSB and FLSTSC models. Stock on many '07-later Softail® models.

## B. SHOR'TEE CHROME UPPER BELT GUARD

Give your Softail® model a unique stylish look. Designed as a direct replacement for the Original Equipment upper belt guard, this mirror-finished, chrome-plated, slotted steel guard adds a "bobbed" look to the bike's profile. Kit includes chrome mounting hardware.

**60490-08** Fits '08-later Softail® models. **\$109.95**

**60649-07** **\$109.95**

Fits '07 FXST, FXSTB, FXSTC, and FLSTF models.

**60610-07** **\$109.95**

Fits '07 FXSTD, FLSTC, FLSTN, and FLSTSC models.

**60610-02A** Fits '00-'06 Softail models. **\$109.95**

## C. CHROME LOWER BELT GUARD

Replaces the Original Equipment black lower belt guards, providing exceptional chrome-plated detail to the rear drive system. Includes all mounting hardware.

**60654-07A** **\$84.95**

Fits '07-later FXSTD, FLSTC, FLSTN, and FLSTSC models.

**60655-07A** **\$84.95**

Fits '07-later FXST, FXSTB, FXSTC, FLSTF, FLSTFB and FLSTSB. Stock on FXSTSSE/2 and FLSTSE models.

**60345-08** **\$124.95**

Fits '08-later FXCW and FXCWC models.

**60317-06** **\$84.95**

Fits '06 FXST, FXSTB, and FXSTS models.

**60316-00A** **\$84.95**

Fits '00-'06 Softail® models (except '06 FXST, FXSTB and FXSTS).

**60389-97A** **\$94.95**

Fits '95-'99 U.S. and International Softail models and '94-'99 International models equipped with a 65-tooth rear sprocket.

### Shown with:

#### CHROME SWINGARM AXLE COVER

Unique styling includes recessed brushed aluminum trim discs. These covers are hand-polished and include copper, nickel and chrome finishing processes. Includes a pair of axle mounting brackets, cotter pin, muffler spacers (required on FLSTN models only) and installation instructions. Replacement Medallion P/N 47604-91.

**47596-91B** **\$89.95**

Fits '87-'07 Softail models (except FLSTS). Will not fit with saddlebags.



A. CHROME UPPER BELT GUARD



B. SHOR'TEE CHROME UPPER BELT GUARD



C. CHROME LOWER BELT GUARD (SHOWN WITH CHROME SWINGARM AXLE COVER)

Notice: The prices appearing in this catalog are the manufacturer's suggested retail prices. Actual retail prices may vary.



D. CHROME UPPER SWINGARM COVER KIT FOR SOFTAIL MODELS

**D. CHROME UPPER SWINGARM COVER KIT FOR SOFTAIL® MODELS**

Give chrome the upper hand with this chrome die-cast cover for your upper swingarm. Mounts easily with all necessary hardware included. Then continue your rear end chrome with a rear axle cover.

**47059-01** \$74.95  
Fits '00-'07 Softail models (except FXSTD and FLSTFSE2).

**E. CHROME REAR WHEEL SPACER KIT**

Add some chrome detail to an often overlooked area of the bike with this highly-polished Chrome Wheel Spacer Kit. Manufactured to the Original Equipment tolerances, they ensure product fitment and quality.

**41221-08** Tapered. \$29.95  
Fits '08-later Softail models (except FXCW and FXCWC).

**41378-08** Tapered. \$29.95  
Fits '08-later FXCW and FXCWC models.

**41596-00A** Straight. \$29.95  
Fits '00-'07 Softail® models (except '06 FXST, FXSTB, FXSTS and FLSTFSE2). Does not fit with Wide Tire Kit P/N 43685-00 and 44490-00.

**F. CHROME REAR WHEEL SPACER KIT – DOMED**

This nicely polished and plated spacer fills the area between the rear wheel and the swingarm, adding a custom detail most riders miss. The rounded design complements both stock and custom wheels, and is a great match with a chrome swingarm. Kit includes left and right side spacers.

**41581-03A** \$39.95  
Fits '00-'07 Softail models (except '06 FXST, FXSTB, FXSTS and FLSTFSE2). Stock on '03 FXSTDSE. Does not fit with Wide Tire Kit P/N 43685-00 or 44490-00.



E. CHROME REAR WHEEL SPACER KIT – STRAIGHT



E. CHROME REAR WHEEL SPACER KIT – TAPERED



F. CHROME REAR WHEEL SPACER KIT – DOMED



F. CHROME REAR WHEEL SPACER KIT – DOMED

Notice: The prices appearing in this catalog are the manufacturer's suggested retail prices. Actual retail prices may vary.

# 274 SOFTAIL®

Chassis Trim – Rear End

## A. CONTOURED FRAME INSERTS

Add a custom “filled and molded” look to the Softail® frame. These Contoured Frame Inserts are shaped to fill the frame recesses that surround the swingarm pivot bolt. The smooth teardrop shape blends with the frame for maximum impact. These inserts complement both a black-painted or chrome-plated swingarm installation. Adhesive backed for easy installation.

**47442-04** Polished Aluminum. **\$36.95**  
Fits '00-'07 FXSTD, FLSTN and FLSTF models.

**48211-08** Chrome. **\$49.95**  
Fits '08-later Softail models (except FXCW and FXCWC).

**48212-08** Chrome. **\$49.95**  
Fits '08-later FXCW and FXCWC models.

## B. SOFTAIL FRAME TRIM SET

Easy-to-install chrome-plated trim plates fit into recesses on rear of Softail frame near swingarm pivot. Comes with double-sided adhesive tape. Adds a finishing touch. (Shown with Chrome Swingarm Pivot Cover P/N 43897-86B, sold separately.)

**47300-88T** **\$21.95**  
Fits '84-later Softail models (except '00-later FLSTF, FLSTFB, FLSTN, FLSTSB and FXSTD models equipped with shotgun exhaust).

## C. SOFTAIL FRAME INSERT AND PIVOT BOLT KIT

Chrome rear frame inserts get you going on the road toward the perfect Softail. Kit includes Swingarm Pivot Bolt Covers and Frame Inserts. Easy installation kit.

**48452-00** **\$38.95**  
Fits '00-'07 FLSTF, FLSTN and FXSTD (except FXSTDSE) models.

## D. SWINGARM FRAME COVER KIT

This easy-to-install Swingarm Frame Cover Kit adds a flash of chrome around the swingarm pivot. The frame cover is mounted with a self-adhesive custom molded rubber backing that hugs the contour of the frame for a snug, custom fit. Kit includes chrome pivot bolt covers to complete the look.

**48494-03** **\$64.95**  
Fits '00-'06 FXSTD and FLSTF models with stock shotgun exhaust.

**48490-00** **\$64.95**  
Fits '00-'06 Softail® models (except FXSTD, FLSTF, FLSTS, FLSTSC and models equipped with Passenger Footboard Kits).

## E. SWINGARM PIVOT AXLE KIT

Designed to replace the Original Equipment swingarm pivot axle. This styled axle looks great by itself, or is a great addition when installing a chrome swingarm.

**47119-02** **\$89.95**  
Fits '00-'07 Softail models. Will not fit with Passenger Footboard Kit.



A. CONTOURED FRAME INSERTS – POLISHED ALUMINUM SHOWN



A. CONTOURED FRAME INSERTS – POLISHED ALUMINUM SHOWN



B. SOFTAIL FRAME TRIM SET



C. SOFTAIL FRAME INSERT AND PIVOT BOLT KIT



D. SWINGARM FRAME COVER KIT – DEUCE AND FAT BOY



E. SWINGARM PIVOT AXLE KIT

Notice: The prices appearing in this catalog are the manufacturer's suggested retail prices. Actual retail prices may vary.



**F. SWINGARM PIVOT BOLT COVER KITS – CHROME BILLET**



**G. SWINGARM PIVOT BOLT COVER KITS – GLOSS BLACK**



**H. SWINGARM PIVOT BOLT COVER KITS – ALUMINATOR CHROME BILLET**



**I. SWINGARM PIVOT BOLT COVER KITS – CLASSIC CHROME**



**J. SWINGARM PIVOT BOLT COVER KITS – “HARLEY-DAVIDSON MOTOR CO.” LOGO**



**K. SWINGARM PIVOT BOLT COVER KITS – THE WILLIE G. SKULL COLLECTION**

**F. SWINGARM PIVOT BOLT COVER KITS – CHROME BILLET**

Cover your swingarm pivot bolt with distinctive styling. Kit includes set screws and Allen wrench for easy installation (*sold in pairs*).

**47612-08** **\$41.95**  
Fits '08-later Softail® models (except FXCW and FXCWC).

**G. SWINGARM PIVOT BOLT COVER KITS – GLOSS BLACK**

Cover your swingarm pivot bolt with distinctive styling. Kit includes set screws and Allen wrench for easy installation (*sold in pairs*).

**47649-09** **\$41.95**  
Fits '08-later Softail models (except FXCW and FXCWC).

**H. SWINGARM PIVOT BOLT COVER KITS – ALUMINATOR® CHROME BILLET**

Cover your swingarm pivot bolt with the distinctive styling of the Aluminator Collection. These covers are made from chrome-plated billet aluminum and engraved with the Bar & Shield emblem. Hex wrench included for easy installation (*sold in pairs*).

**43314-01** **\$45.95**  
Fits '00-'07 Softail models (except FLSTF, FXSTD and models with Passenger Footboard Kit).

**I. SWINGARM PIVOT BOLT COVER KITS – CLASSIC CHROME**

Includes set screws and Allen wrench for easy installation (*sold in pairs*).

**47660-09** **\$26.95**  
Fits '08-later Softail models (except FXCW and FXCWC).

**43462-00** **\$29.95**  
Fits '00-'07 Softail models (except FLSTF, FXSTD and models with Passenger Footboard Kit).

**43897-86B** **\$29.95**  
Fits '84-'99 Softail models (except FLSTS).

**J. SWINGARM PIVOT BOLT COVER KITS – “HARLEY-DAVIDSON MOTOR CO.” LOGO**

Die-cast, chrome-plated with black “Harley-Davidson Motor Co.” logo. Includes set screws and Allen wrench for easy installation. (*sold in pairs*).

**47630-09** **\$26.95**  
Fits '08-later Softail models (except FXCW and FXCWC).

**43468-00** **\$29.95**  
Fits '00-'07 Softail models (except FLSTF, FXSTD and models with Passenger Footboard Kit).

**43830-96** **\$29.95**  
Fits '84-'99 Softail models. (Does not fit FLSTS.)

**K. SWINGARM PIVOT BOLT COVER KITS – THE WILLIE G.® SKULL COLLECTION**

Add a little attitude to your ride. Styled to complement Harley-Davidson Skull accessory items, the menacing raised skull with black-filled eyes leaps from a field of chrome. The surrounding “Harley-Davidson Motorcycles” script is the perfect finishing touch. This easy-to-install kit includes left and right pivot bolt covers and necessary mounting hardware.

**47663-09** **\$26.95**  
Fits '08-later Softail models (except FXCW and FXCWC).

**43235-08** **\$29.95**  
Fits '00-'07 Softail models (except FLSTF, FXSTD and models with Passenger Footboard Kit).



# 276 SOFTAIL®

Chassis Trim – Rear End

## A. REAR AXLE NUT COVER KITS – CLASSIC CHROME COLLECTION

Cover your rear axle nut in the most traditional way. This Rear Axle Cover Kit complements the matching Front Axle Nut covers. Easy-to-install, these cover kits include necessary mounting hardware (*sold in pairs*).

**43132-08** Billet. **\$41.95**  
Fits '08-later Dyna® and Softail® models (except FXCW/C).

**41705-09** Die Cast. **\$24.95**  
Fits '08-later Dyna and Softail models (except FXCW/C).

**44256-01** Die Cast. **\$26.95**  
Fits '00-'07 Softail® models (except FLSTS and FLSTSC).  
(Will not fit with saddlebags.)



A. REAR AXLE NUT COVER KIT – CLASSIC CHROME



B. REAR AXLE NUT COVER KIT – GLOSS BLACK

## B. REAR AXLE NUT COVER KIT – GLOSS BLACK

Cover your rear axle nut in the most traditional way. This Rear Axle Cover Kit complements the matching Front Axle Nut covers. Easy-to-install, these cover kits include necessary mounting hardware (*sold in pairs*).

**43422-09** **\$41.95**  
Fits '08-later Dyna and Softail models (except FXCW/C).

## C. REAR AXLE NUT COVER KITS – “H-D MOTOR CO.” LOGO COLLECTION

Cover your rear axle nut in the most traditional way. This Rear Axle Cover Kit complements the matching Front Axle Nut covers. Easy-to-install, these cover kits include necessary mounting hardware (*sold in pairs*).

**41704-09** **\$26.95**  
Fits '08-later Dyna and Softail models (except FXCW/C).

**44254-01** **\$28.95**  
Fits '00-'07 Softail models (except FLSTS and FLSTSC).  
(Will not fit with saddlebags.)



C. REAR AXLE NUT COVER KIT – H-D MOTOR CO. LOGO



D. REAR AXLE NUT COVER KIT – THE WILLIE G. SKULL

## D. REAR AXLE NUT COVER KITS – WILLIE G.® SKULL COLLECTION

Cover your rear axle nut in the most traditional way. This Rear Axle Cover Kit complements the matching Front Axle Nut covers. Easy-to-install, these cover kits include necessary mounting hardware (*sold in pairs*).

**41706-09** **\$26.95**  
Fits '08-later Dyna and Softail models (except FXCW/C).

**43221-08** '00-'07 later Softail models. **\$28.95**

## E. SIX-SHOOTER REAR AXLE COVER AND ADJUSTER

Shoot for the custom look with this chrome revolver-styled axle adjuster cover. Machined from billet aluminum for maximum style.

**48179-98A** **\$69.95**  
Fits '86-'07 Softail models (except '06-'07 FXST, FXSTB, FXSTS, FLSTFSE2 and '07 FLSTF).

(Will not fit with saddlebags.)



E. SIX-SHOOTER REAR AXLE COVER AND ADJUSTER

## F. PISTON REAR AXLE COVER AND ADJUSTER

Simple, clean chrome-plated styling to add brilliance to your rear axle adjuster.

**48180-98B** **\$69.95**  
Fits '86-'07 Softail models (except '06-'07 FXST, FXSTB, FXSTS, FLSTFSE2 and '07 FLSTF).

(Will not fit with saddlebags.)



F. PISTON REAR AXLE COVER AND ADJUSTER

## G. CUSTOM REAR AXLE ADJUSTER AND AXLE NUT KIT

Show-stopping style and function in one. This Custom Rear Axle Adjuster Kit replaces the Original Equipment black hardware with brilliant chrome, and hides the silver axle nut with styled chrome covers. The complete kit adds a finishing touch to a black or chrome-plated swingarm.

**43429-02** **\$84.95**  
Fits '00-'07 Softail models. (Will not fit with saddlebags.)



G. CUSTOM REAR AXLE ADJUSTER AND AXLE NUT KIT

## H. CHROME REAR AXLE ADJUSTER HARDWARE

Highly polished and chrome-plated hex head bolts replace the standard hardware for a custom look. Manufactured to Original Equipment specifications to ensure fit and performance, this kit is the perfect addition to a chrome or painted swingarm.

**41202-08** Fits '08-later Softail models. **\$15.95**



H. CHROME REAR AXLE ADJUSTER HARDWARE

*Notice: The prices appearing in this catalog are the manufacturer's suggested retail prices. Actual retail prices may vary.*



I. SOFTAIL SWINGARM AXLE COVER



I. SOFTAIL SWINGARM AXLE COVER – FXCW



J. HARLEY-DAVIDSON SCRIPT SWINGARM AXLE COVER KIT – '08-LATER MODELS



J. HARLEY-DAVIDSON SCRIPT SWINGARM AXLE COVER KIT – '87-'07 MODELS



K. BLACK SOFTAIL SWINGARM AXLE COVER



L. CHROME SWINGARM AXLE COVER FOR SOFTAIL MODELS



M. SOFTAIL SWINGARM AXLE COVER

**I. SOFTAIL® SWINGARM AXLE COVER**

Add a sweep of chrome to the rear of the swingarm. This mirror-finished cover hides the axle head and the rear of the swingarm. (sold in pairs).

**42069-08** **\$94.95**

Fits '08-later Softail® models (except FXCW and FXCWC).

Will not fit with saddlebags.

**44345-09** **\$94.95**

Fits '08-later FXCW and FXCWC models.

Will not fit with saddlebags.

**J. "HARLEY-DAVIDSON" SCRIPT SWINGARM AXLE COVER KIT**

Add a sweep of chrome over the rear axle nut with this stylish rear axle cover. This mirror-finish kit covers the axle nut and adjuster screw, without hiding the swingarm tail. The distinctive shape and the debossed "Harley-Davidson" script combine to complement a painted or chrome-plated swingarm. Kit includes all necessary mounting hardware.

**41575-08** **\$204.95**

Fits '08-later Softail® models (except FXCW and FXCWC models). Will not fit with saddlebags.

**41661-06** **\$204.95**

Fits '06-'07 FXST, FXSTB, FXSTS and FLSTFSE2 models.

Will not fit with saddlebags. (not shown)

**48109-03A** **\$204.95**

Fits '87-'07 Softail models (except '06-'07 FXST, FXSTB, FXSTS and FLSTFSE2). Will not fit with saddlebags.

**K. BLACK SOFTAIL SWINGARM AXLE COVER**

Our traditional Softail Axle Covers are available with an elegant black painted finish. They are accented with a dark aluminum emblem and a bright "Harley-Davidson" script. Chrome hardware included.

**47615-95B** **\$89.95**

Fits '87-'07 Softail models (except FLSTS).

Will not fit with saddlebags.

**L. CHROME SWINGARM AXLE COVER FOR SOFTAIL MODELS**

Unique styling includes recessed brushed aluminum trim discs. These covers are hand-polished and include copper, nickel, and chrome finishing processes. Includes a pair of axle mounting brackets, cotter pin, muffler spacers (required on FLSTN models only), and installation instructions. Replacement Medallion P/N 47604-91.

**47596-91B** **\$89.95**

Fits '87-'07 Softail models (except FLSTS).

Will not fit with saddlebags.

**M. SOFTAIL® SWINGARM AXLE COVER**

Chrome-plated die-cast cover, accented with textured recesses and an engraved Bar & Shield emblem.

**48112-00** **\$119.95**

Fits '90-'07 FLSTF and '00-'07 FXSTD and FLSTN models.

(Will not fit with saddlebags.)

**48056-97B** **\$119.95**

Fits '87-'07 Softail models (except FLSTF, FLSTN and FXSTD models with stock shotgun exhaust).

(Will not fit with saddlebags.)

# 278 SOFTAIL®

Chassis Trim – Rear End

## A. MAGNUM 5 SPROCKET COVER

Styled to match the distinctive Magnum 5 Custom Wheel. Available in mirror chrome or satin black, this Sprocket Cover gives the appearance of having a custom sprocket at a fraction of the cost. Cover is easy-to-install with Original Equipment hardware, or add the Chrome Hardware Kit P/N 94773-07 (sold separately) to your Softail model for a finished look.

Fits '07-later Softail® and '07 Touring models.

<b>40123-10</b>	Satin Black.	<b>\$54.95</b>
<b>40121-09</b>	Chrome.	<b>\$54.95</b>

## B. TYPHOON SPROCKET COVER

Styled to match the distinctive Typhoon Custom Wheel. Available in mirror chrome or satin black, this Sprocket Cover gives the appearance of having a custom sprocket at a fraction of the cost. Cover easily bolts on using the stock hardware, or for a finished look, add the Chrome Hardware Kit P/N 94773-07 (sold separately).

Fits '07-later Softail® models.

<b>40155-08</b>	Satin Black.	<b>\$49.95</b>
<b>40150-08</b>	Chrome.	<b>\$49.95</b>

## C. CHROME SPROCKET COVER

This Sprocket Cover gives the appearance of having a chrome sprocket at a fraction of the cost. It matches the styling of the Original Equipment sprocket, and bolts on using the stock hardware.

**37757-07** **\$49.95**

Fits '07-later Softail (except FXCW/C) and '07 Touring models.

**91347-00** Fits '00-'06 Softail models. **\$49.95**

## D. CHROME BELT SPROCKET COVERS

### 65-Tooth Sprocket Cover

Fits '95-'99 Softail® models and '94-later Evolution® 1340-equipped Swiss models with holes.

**40317-94** **\$54.95**

### 70-Tooth Sprocket Cover

Fits '91-'99 Dyna® models. Also fits '80-later U.S. 1340 models except '93 and '95-later Softail models. '94 U.S. Softails are equipped with 70-tooth rear sprockets. Also fits '94-later International 1340 models (except International Softail and Swiss 1340 models).

**91733-85A** **\$54.95**



A. MAGNUM 5 SPROCKET COVER – CHROME

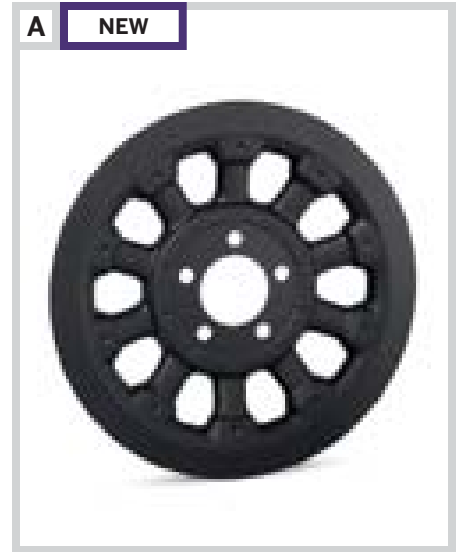

A. MAGNUM 5 SPROCKET COVER – SATIN BLACK



B. TYPHOON SPROCKET COVER – CHROME



B. TYPHOON SPROCKET COVER – SATIN BLACK



C. CHROME SPROCKET COVER



D. CHROME BELT SPROCKET COVER

Notice: The prices appearing in this catalog are the manufacturer's suggested retail prices. Actual retail prices may vary.



E

E. REAR SPROCKET BOLT COVER KIT



E

E. REAR SPROCKET BOLT COVER KIT

**E. REAR SPROCKET BOLT COVER KIT**

These chrome-plated covers with internal spring clips hide the Original Equipment sprocket bolts for a clean, custom look. Set of 5 covers.

**43876-04** **\$38.95**

Fits '93-later Softail®, '99-later Touring (except Trike) and '04-later XL models with Original Equipment 7/16" hex head sprocket mounting bolts (5/8" hex across the flats).

**F. CHROME HARDWARE KIT FOR REAR BELT SPROCKET – HEX HEAD**

This kit includes highly-polished, chrome-plated, grade 8 hex-head screws with chrome-plated washers, providing an extra custom accent. The perfect addition to the new chrome sprocket. Made from the same Original Equipment bolts to ensure product integrity. Also works with chrome belt sprocket covers and Original Equipment sprockets.

**94773-07** **\$29.95**

Fits '07-later Dyna® and Softail models.

**94773-00A** **\$29.95**

Fits '00-'06 Softail and '00-'05 Dyna® models.

**94708-98** **\$29.95**

Fits '93-'99 Softail, '93-'99 Dyna, '91-later XL models.

**G. CHROME SOCKET HEAD CAP SCREW HARDWARE KIT FOR REAR BELT SPROCKET**

It's the details, like this chrome hardware kit, that really get your bike noticed. These Socket Head Cap Screws offer a unique, chrome-plated look to the rear belt sprocket. Includes chrome-plated washers and grade 8 hardware to ensure product integrity.

**43245-07** **\$29.95**

Fits '07-later Softail models.

**43245-00A** **\$29.95**

Fits '00-'06 Softail models (except FXSTDSE and FXSTDSE2).

**H. CHROME BRAKE DISC HARDWARE KIT**

It's the details, like this Chrome Hardware Kit, that really get your bike noticed. These button head screws add a unique, chrome-plated finish to the Original Equipment or accessory floating brake rotors. Kit includes 5 chrome-plated bolts manufactured to factory specifications to ensure fit and performance.

**Front**

**46646-05** **\$12.95**

Fits '90-later models (except VRSC™, XR, '06-later Dyna models with cast wheel option and '07-later FLHRSE3/4). Dual disc models require purchase of two kits.

**Rear**

**46647-05** **\$13.95**

Fits '92-later models (except XR and Trike).



F

F. CHROME HARDWARE KIT FOR REAR BELT SPROCKET – HEX HEAD



G

G. CHROME SOCKET HEAD CAP SCREW HARDWARE KIT FOR REAR BELT SPROCKET



H

H. CHROME BRAKE DISC HARDWARE KIT



H

H. CHROME BRAKE DISC HARDWARE KIT

Notice: The prices appearing in this catalog are the manufacturer's suggested retail prices. Actual retail prices may vary.



# 280 SOFTAIL®

## Brakes

### A. CHROME FRONT CALIPER KIT

Add the shine of chrome to your front end with this highly polished Chrome Front Brake Caliper Kit. Manufactured from Original Equipment components for proven performance, these calipers are a great addition to the stock front end or add the finishing touch to a complete custom with chrome wheels, rotors and chrome fork sliders. (Brake pads and pad pins not included.)

**44395-08** **\$359.95**  
Fits '08-later Dyna® and Softail® models (except Springer®) equipped with single disc front brakes.

**44395-00A** **\$359.95**  
Fits '00-'03 XL and '00-'07 Dyna and Softail (except Springer) models equipped with single disc front brakes.

**44392-00A** **\$789.95**  
Fits '00-'03 XL, '02-'05 VRSC™, and '00-'07 Dyna, Softail and Touring models equipped with dual disc front brakes.

### B. CHROME REAR CALIPER KIT

With H-D® chrome behind you, you're cruising with confidence. This Rear Caliper Kit offers a brilliant, long-lasting chrome finish while delivering Original Equipment performance and fitment. Bolts right to existing mounting holes. (Brake pads and pad pins not included.)

**42047-08** **\$319.95**  
Fits '08-later Dyna and Softail models.

**44539-02A** **\$399.95**  
Fits '00-'07 FL Softail, (except '07 FLSTF), '00-'05 FX Softail (except FXSTD) and '02-'04 VRSC models. Not compatible with accessory Wide Tire Kits.

**42047-06** **\$319.95**  
Fits '06-'07 FXST, FXSTB, FXSTC, FXSTS, FLSTFSE2 and '07 FLSTF models.

#### Shown with:

#### CHROME REAR CALIPER BRACKET

Complete a chrome rear brake conversion. This Rear Caliper Bracket sets your ride apart from the others by replacing the painted black mount with brilliant chrome. Manufactured from the Original Equipment components for exact fit, this mount will bolt to the existing mounting location.

**42048-08** Fits '08-later Softail models. **\$109.95**

**42048-06** **\$109.95**  
Fits '06-'07 FXST, FXSTB, FXSTC, FXSTS, FLSTFSE2 and '07 FLSTF models.



A. CHROME FRONT CALIPER KIT



B. CHROME REAR CALIPER KIT – (SHOWN WITH CHROME REAR CALIPER BRACKET)



B. CHROME REAR CALIPER KIT – '00-'07 MODELS

Notice: The prices appearing in this catalog are the manufacturer's suggested retail prices. Actual retail prices may vary.



C. CUSTOM CALIPER BOLT COVER KIT



D. CHROME CALIPER HARDWARE KIT



E. CHROME BANJO BOLT KIT



E. CHROME BANJO BOLT KIT



F. DEEP DISH BRAKE CALIPER INSERT

G. BRAKE CALIPER INSERTS AND  
BRAKE CALIPER TRIM DISCS**C. CUSTOM CALIPER BOLT COVER KIT**

Complete the custom transformation. This complete kit hides the exposed Original Equipment caliper hardware with machined brass chrome-plated covers. Held firmly in place with an internal retention clip, this easy-to-install kit includes the large and small 12-point bolt covers required to customize a single caliper.

**40955-05** Four Large and Two Small Covers. Fits '00-later front brake calipers (except Springer® models, '04-later XL models, '08-later Touring, '06-later VRSC™ models and models equipped with caliper covers). Also fits rear calipers on '06-later FXST, FXSTB, FXSTS and FLSTSB models. **\$27.95**

**40959-05** Three Large and Two Small Covers. Fits '00-later rear brake calipers (except '04-later XL models, '08-later Touring, '06-later FXST, FXSTB, FXSTS and FLSTSB, '06-later VRSC models and models equipped with caliper covers). **\$22.95**

**D. CHROME CALIPER HARDWARE KIT**

Chrome-plated hardware is a great finishing touch to Chrome Brake Calipers. This kit replaces the Original Equipment black 12-point bolts on a single caliper.

**44473-02A** Fits '00-'07 models (except Springer® front caliper, '04-later XL, '06-later FX Softail® rear calipers and '06-later VRSC models). **\$39.95**

**E. CHROME BANJO BOLT KIT**

Replace the Original Equipment 12-point zinc finish brake line hardware with brilliant chrome custom tapered banjo bolts.

**41842-06** Fits '91-'03 XL, '91-later Dyna® (except FXDF), '95-later Softail, and '99-'00 FXR models equipped with single front brake. Does not fit with Banjo Bolt Cover P/N 32715-98. Kit includes one 7/16" banjo bolt, three 3/8" banjo bolts and eight sealing washers. **\$27.95**

**F. DEEP DISH BRAKE CALIPER INSERT**

This chrome-plated caliper insert features a dished-out center profile for added "flash". Includes self-adhesive backing for easy installation.

**44542-03** Fits '00-later front and rear brake calipers on all models (except Springer® front, '08-later Touring, '04-later XL and '06-later VRSC models). **\$13.95**

**G. BRAKE CALIPER INSERTS**

Easy to install inserts add a finishing touch to the front and rear brake calipers. Select a style that follows your custom direction. Self-adhesive backing.

Fits '00-later front and rear brake calipers on all models (except Springer front, '08-later Touring, '04-later XL and '06-later VRSC™ models).

**1. 44477-99** Classic Chrome. **\$13.95**

**2. 44476-99** "Harley-Davidson" Script. **\$13.95**

**3. 44474-99** Flames. **\$13.95**

**BRAKE CALIPER TRIM DISCS**

Available in 1-3/8" and 1-3/4" diameters to accommodate front and rear calipers on most '99-earlier models, and front calipers on '00-later Springer® models. Easy-to-install.

**4. 44095-96** "H-D Motor Co." – 1-3/8" Diameter. **\$13.95**

**44093-96** "H-D Motor Co." – 1-3/4" Diameter. **\$13.95**

**99661-92T** Gold Live to Ride – 1-3/8" Diameter. **\$13.95**

**99663-92T** Gold Live to Ride – 1-3/4" Diameter. **\$13.95**

**5. 99660-92T** Chrome Live to Ride – 1-3/8" Diameter. **\$13.95**

**99662-92T** Chrome Live to Ride – 1-3/4" Diameter. **\$13.95**

**6. 99679-98** Flames – 1-3/8" Diameter. **\$9.95**

**99684-98** Flames – 1-3/4" Diameter. **\$13.95**

# 282 SOFTAIL®

## Brakes

### A. CHROME CALIPER ROTOR COVER

Add clean, chrome style to your front end with this cover, which features high-quality, chrome-plating that complements the lines of your bike.

**43367-00** **\$119.95**  
Fits '00-later FLST, FLSTC, FLSTF, FLSTFB and FLSTN models.

### B. FRONT CALIPER COVER

Chrome-plated caliper cover styled with stepped contours and textured recess for a distinctive look. Split cover design does not require brake line removal.

**43759-00** **\$41.95**  
Fits left hand calipers on '00-'07 FXDWG and '00-later Softail® models (except Springer® and FXSTD models). (Will not fit with braided brake lines.)

### C. REAR CALIPER COVER

Chrome-plated caliper covers styled with stepped contours and textured recess for a distinctive look. Does not require brake line removal.

**43553-00** **\$37.95**  
Fits '00-'05 Dyna® and '00-'07 Softail models (except '06-'07 FXST, FXSTB, FXSTS, FLSTFSE2, and '07 FLSTF). (Will not fit with braided brake lines.)

### D. SMOOTH FULL COVERAGE CALIPER COVER

These covers provide the easiest and least expensive way to add chrome to the flat black finish of stock brake calipers. They install in minutes without tools.

**43260-98** Front. **\$29.95**  
Fits '84-'99 models.

#### Shown with:

#### 1. BRAKE BLEEDER SCREW COVER

This cover adds chrome to the unfinished bleeder valve on all stock H-D® calipers. Package of two.

**43834-98** **\$21.95**  
Fits '84-later stock calipers (except XR models).

#### 2. CHROME BANJO BOLT COVER

Die-cast chrome cover provides a custom look to your stock banjo bolts. Fits banjo bolts on front and rear brake master cylinders and front and rear calipers. Installs in seconds.

**32715-98** **\$19.95**  
Fits '84-later models with stock master cylinders and calipers. (Does not fit VRSC™ Rear Master Cylinder, '06-later VRSC calipers, '08-later Touring or '04-later XL models.)

### E. CHROME SEAT POST

Finish your bike to the last detail. This mirror-polished and chrome-plated seat post replaces the Original Equipment black painted post, and adds a dash of chrome from the seat base to the engine. Kit includes chrome mounting hardware.

**48875-07** **\$79.95**  
Fits '07-later Softail® models (except FXCW, FXCWC and FXSTSSE3).



A. CHROME CALIPER ROTOR COVER



B. FRONT CALIPER COVER



C. REAR CALIPER COVER



D. SMOOTH FULL COVERAGE CALIPER COVER – (SHOWN WITH BRAKE BLEEDER AND CHROME BANJO BOLT COVERS)

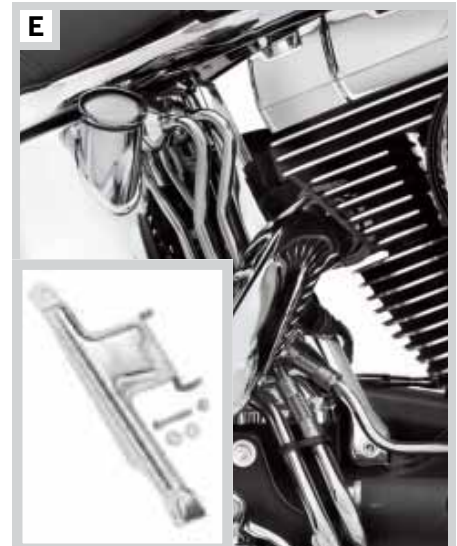

E. CHROME SEAT POST

Notice: The prices appearing in this catalog are the manufacturer's suggested retail prices. Actual retail prices may vary.



F. CLASSIC COVERS KIT

F. CLASSIC COVERS KIT – SOFTAIL BIKE KIT  
(NOT ALL COMPONENTS SHOWN)**F. CLASSIC COVERS KIT**

Customize your bike down to the last detail. These hardware Cover Kits include the chrome-plated ABS caps and plugs in the sizes and styles required to dress the viewable hardware on the motorcycle. Classic Covers are available as complete "Bike Kits" with the covers for both engine and chassis hardware, or as "Engine-only" kits to dress the Twin Cam or XL engine. The kits are easy-to-install, with no tools required.

**94923-09** Bike Kit. **\$259.95**  
Fits '09-later Softail® models  
(except FXCW, FXCWC and FLSTSB).

**94921-09** Bike Kit. **\$249.95**  
Fits '09-later FXCW and FXCWC models.

**94922-09** Bike Kit. **\$259.95**  
Fits '09-later FLSTSB models.

**94948-07** Bike Kit. **\$279.95**  
Fits '00-'08 Softail models.

**94943-07** Engine Kit. **\$109.95**  
Fits Twin Cam-equipped models.

**G. CHROME REAR FENDER STRUT HARDWARE KIT**

Finish the show-winning look with brilliant chrome hardware. Manufactured to Original Equipment specifications, these kits replace the zinc-plated exposed fender strut hardware with chrome-plated button head screws and custom machined washers.

**94691-08** Fits '08-later FLSTC models. **\$29.95**

**94692-08** **\$39.95**  
Fits '08-later FXST, FXSTB, FLSTF, FLSTFB,  
FLSTSB and FXSTSSE2/3 models.

**94693-08** Fits '08-later FLSTN models. **\$49.95**

**94694-08** Fits '08-later FXSTC models. **\$39.95**

**94560-07** Fits '07 FLSTC models. **\$29.95**

**94561-07** **\$39.95**  
Fits '06-'07 FXST, FXSTB, FXSTS, FLSTFSE2 and  
'07 FLSTF, FXSTSSE models.

**94562-07** **\$49.95**  
Fits '05-'07 FLSTSC, '06 FLST, and '07 FLSTN models.

**94563-07** Fits '07 FXSTC models. **\$39.95**

**94416-05** **\$39.95**  
Fits '03-'05 FXST, FXSTB and FXSTS models, '03-'06 FLSTF  
and '05-'06 FLSTN models (*shown*).

**H. MID-FRAME COVER KIT**

Chrome-plated Mid-Frame Cover stretches from the fuel tank to the fender strut to conceal the painted frame rails. This easy-to-install bolt-on kit includes left and right side covers and all necessary mounting hardware.

**47244-05** **\$94.95**  
Fits '00-'07 Softail® models (except FLSTC, FLSTF, FXSTD  
and '06-later FXST, FXSTB, FXSTC and FXSTS).

**47245-05** **\$94.95**  
Fits '00-'07 FXSTD, FLSTC and FLSTF models.



G. CHROME REAR FENDER STRUT HARDWARE KIT



H. MID-FRAME COVER KIT

Notice: The prices appearing in this catalog are the manufacturer's suggested retail prices. Actual retail prices may vary.



# 284 SOFTAIL®

## Chassis Trim

### A. HERITAGE CHROME FRONT FENDER RAIL\*

A stylish re-creation of a popular Hydra Glide™ model accessory direct from the Harley-Davidson® 1959 accessories catalog. Ornate, jet, twin-tube design sweeps smartly back along the front fender. Sparkling chrome-plating and years-ahead styling make it a hit for all Heritage and FLSTN owners.

**91080-93** **\$99.95**

Fits '87-later FLST, FLSTC, and '93-'96 FLSTN models. (Does not fit Springer® models.)



A. HERITAGE CHROME FRONT FENDER RAIL

### B. HERITAGE CHROME REAR FENDER RAIL\*

A perfect match to Heritage Chrome Front Fender Rail P/N 91080-93. Designed to fit with stock FLSTC, FLSTN saddlebags or Genuine Harley-Davidson® Fat Boy® leather saddlebags.

**91402-00** **\$99.95**

Fits '00-later FLST and FLSTC models.



B. HERITAGE CHROME REAR FENDER RAIL

### C. CHROME FRONT FENDER TRIM KIT

Replace the Original Equipment stainless steel fender trim with a splash of chrome. Kit includes left and right side trim strip.

**59209-91T** **\$26.95**

Fits '82-later Touring models (except Road Glide® and Road King® Custom), FLHTCUTG and '86-later FLST, FLSTN and FLSTC models. Does not fit models equipped with clean front fender.



C. CHROME FRONT FENDER TRIM KIT

### D. FRONT FENDER RAIL AND STANCHION KIT\*

Chrome-plated accents straight from our 1947 catalog. Includes template for easy installation.

**91117-97** **\$69.95**

Fits '84-later FL Softail (except FLSTF, FLSTFB, FLSTSE and FLSTSB) and Touring models.



D. FRONT FENDER RAIL AND STANCHION KIT

### E. BAR & SHIELD LOGO FRONT FENDER SPEAR

This chrome-plated trim spear adds a sweeping dash of chrome to the front fender. Featuring a raised Bar & Shield logo set against a textured black field, this self-adhesive medallion is easy-to-install.

**91195-04** Large. **\$39.95**

Fits Touring and FL Softail® models (except FLSTSB).

**91194-04** Small. **\$34.95**

Fits XL, XR, Dyna® and FX Softail models.



E. BAR & SHIELD LOGO FRONT FENDER SPEAR – LARGE



E. BAR & SHIELD LOGO FRONT FENDER SPEAR – SMALL

### F. CHROME FRONT FENDER EXTENSION

Dress your front fender in chrome. This chrome-plated tapered Fender Extension is shaped to follow the curve of the fender for style and function. Using the Original Equipment fender hole, the extension mounts below the trailing edge of the fender to help control road dirt and spray.

**59664-03** **\$47.95**

Fits '91-'08 Dyna® and '84-'07 FX Softail® models. (Will not fit FXD, FXDX or FXDXT models equipped with Voltage Regulator Covers.)

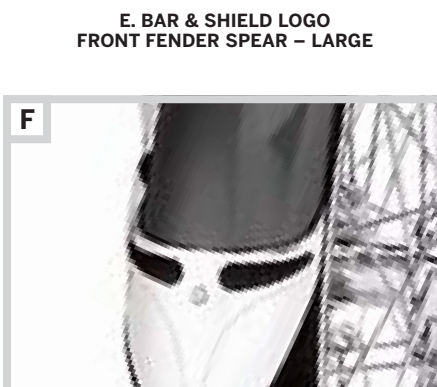

F. CHROME FRONT FENDER EXTENSION

### G. NARROW FRONT FENDER MUD FLAP

Finish your narrow front fender with a splash of black and chrome. This black mud flap is formed to the fender contour for superior fit, and the rigid construction helps control road debris to keep your frame and engine clean. Styled chrome mount with Bar & Shield logo utilizes Original Equipment fender hole for no-drill installation.

**59217-03** **\$69.95**

Fits '95-'07 FX Softail models, and '95-'08 Dyna models (except FXDF). (Will not fit FXD, FXDX or FXDXT models equipped with Voltage Regulator Covers.)



G. NARROW FRONT FENDER MUD FLAP



**\*WARNING:** Fender rails are decorative items only. Do not strap anything to the rails. Adding any additional weight to the front fender could adversely affect vehicle handling, causing loss of control and death or serious injury.

Notice: The prices appearing in this catalog are the manufacturer's suggested retail prices. Actual retail prices may vary.

**H. FLAMES FENDER SKIRT****I. SKULL FENDER SKIRT****J. CONCHO FENDER SKIRT****K. V-LOGO FENDER SKIRT****L. CHROME FENDER SKIRT****M. HERITAGE SPRINGER  
LEATHER MUD FLAP WITH FRINGE****N. HERITAGE SOFTAIL CLASSIC  
REAR FENDER LEATHER MUD FLAP****O. STUDED REAR FENDER MUD FLAP****H. FLAMES FENDER SKIRT**

Designed as an easy-to-install replacement for the Original Equipment fender skirt, this chrome steel fender skirt features an embossed 3-D flame design. Kit includes mounting hardware.

**60179-06** **\$54.95**

Fits '80-later Touring models, '86-'08 FLSTC, '06 FLST and '93-'96 FLSTN models equipped with Original Equipment fender skirt.

**I. SKULL FENDER SKIRT**

This decorative chrome-plated fender skirt is a direct replacement for stock fender skirt. Features a three-dimensional sculptured concho with skull design set off with black accents. Mounting hardware included.

**59582-02A** **\$54.95**

Fits '80-later Touring models, '86-'08 FLSTC, '06 FLST and '93-'96 FLSTN models equipped with Original Equipment fender skirt.

**J. CONCHO FENDER SKIRT**

This decorative fender skirt features conchos inspired by the Heritage Softail® Classic.

**59147-96** **\$54.95**

Fits '80-later Touring models, '86-'08 FLSTC, '06 FLST and '93-'96 FLSTN models equipped with Original Equipment fender skirt.

**K. V-LOGO FENDER SKIRT**

V-Logos are die-cast aluminum integrated with the fender skirt, then chrome-plated for a desirable shine. Includes all mounting hardware.

**59146-96** **\$54.95**

Fits '80-later Touring models, '86-'08 FLSTC, '06 FLST and '93-'96 FLSTN models equipped with Original Equipment fender skirt.

**L. CHROME FENDER SKIRT**

This rigid-steel fender skirt, designed to replace the original factory-equipped aluminum trim, is formed, polished and chrome-plated. Its ribbed pattern offers a unique styling element and adds rigidity. Subtle but distinctive brushed aluminum Bar & Shield logos are framed by a stamped-in ribbed outline on both sides.

**59228-91** **\$54.95**

Fits '80-later Touring models, '86-'08 FLSTC, '06 FLST and '93-'96 FLSTN models equipped with Original Equipment fender skirt.

**M. HERITAGE SPRINGER® LEATHER MUD FLAP WITH FRINGE**

Made from premium, plated leather with black trim, these flaps have fringe and an '97-'03 FLSTS concho and black trim. Includes chrome hardware, support bracket and fender mounting template.

**59027-99** **\$49.95**

Fits '97-'03 FLSTS models front or rear fender. Also fits '86-later FLSTC, '86-'06 FLSTF and '93-'96 FLSTN models.

**N. HERITAGE SOFTAIL® CLASSIC REAR FENDER LEATHER MUD FLAP**

Get nostalgic with top-grain cowhide decorated with bright spots and a Heritage-style concho. A perfect match with your Heritage saddlebags. Kit includes installation hardware and template.

**59071-98** Fits '86-later FLSTC models. **\$49.95**

**O. STUDED REAR FENDER MUD FLAP**

Black mud flap with accenting decorative studs.

**59230-88** **\$29.95**

Fits '08-earlier FLHT, FLHS, FLHRC, FLT, FLTR, '86-'90 FLST, '86-'06 FLSTF and '93-'96 FLSTN models. (Does not fit '09-later Touring or models with rear bumper rail.)

# 286 SOFTAIL®

## Chassis Trim

### A. BAR & SHIELD LOGO CHROME FENDER TIP LENS KIT

Chrome-plated polycarbonate construction features translucent Bar & Shield emblems. The kit includes front and rear lenses. Front lens features an amber Bar & Shield logo, rear lens features a red Bar & Shield logo. Quick and easy installation.

**59081-96** Front and Rear **\$27.95**  
Fits '80-'08 FLHT, FLT, FLHS, FLHR models and '86-later FLSTC, '93-'96 FLSTN models. (Does not fit FLHRS, Springer or FLTR.)

### B. FENDER TIP LENS KIT WITH SKULL LOGO

This chrome-plated fender tip lens kit adds a little attitude to your ride. The kit features front and rear lenses with a translucent illuminated skull silhouette. The easy-to-install kit includes an amber front lens and red rear lens.

**59651-01** **\$27.95**  
Fits '80-'08 Electra Glide®, Tour Glide™, FLHS, Road King® (except Road King Classic and FLHRS), '86-'08 FLSTC and '93-'96 FLSTN models.

### C. HARLEY-DAVIDSON "LIVE TO RIDE" LOGO FENDER TIPS

Made of durable ABS plastic. Includes mounting hardware and installation instructions.

**59068-96** Front. **\$31.95**  
Fits '80-later FLT, FLHTCUTG, FLHR, FLSTC and '93-'96 FLSTN models (replaces fender lamp assembly). (Does not fit Springer, FLHRS and FLTR models.)

**59069-96** Rear. **\$31.95**  
Fits '80-'08 FLT, FLHR, FLSTC and '93-'96 FLSTN models (replaces fender lamp assembly). (Does not fit Springer, FLHRS and FLTR models.)

### D. FLAMES FENDER TIP

Made of durable ABS plastic. Includes mounting hardware and installation instructions.

~~**59348-98** Front. **OBSOLETE** **\$31.95**  
Fits '80-later FLT, FLHTCUTG, FLHR, FLSTC and '93-'96 FLSTN models (replaces fender lamp assembly). (Does not fit Springer, FLHRS and FLTR models).~~

~~**59315-98** Rear. (not shown) **OBSOLETE** **\$31.95**  
Fits '80-'08 FLT, FLHR, FLSTC and '93-'96 FLSTN models (replaces fender lamp assembly). (Does not fit Springer, FLHRS and FLTR models.)~~

### E. EAGLE WING FENDER TRIM FOR FAT BOY® MODELS

Classic Eagle Wing logo available in chrome or two-tone chrome and gold with black accent. Matches Eagle Wing headlamp, taillamp and turn signal visors.

Fits '90-'06 FLSTF models.

**1. 59369-97** Rear. Gold Two-Tone. **\$31.95**  
**59368-97** Rear. Chrome. **\$25.95**

Fits '90-later FLSTF and FLSTFB models.

**2. 59367-97** Front. Gold Two-Tone. **\$31.95**  
**59366-97** Front. Chrome. **\$25.95**

### F. EAGLE WING FENDER TRIM FOR FAT BOY® MODELS

This solid brass fender trim is hand-polished and features finely detailed Eagle and "Harley-Davidson" graphics. Includes mounting hardware and foam pad attached to underside of trim to resist scratches when installing.

Fits '90-'06 FLSTF models.

**1. 59286-90** Rear. Chrome. **\$25.95**

Fits '90-later FLSTF and FLSTFB models.

**2. 59285-90** Front. Chrome. **\$25.95**



A. BAR & SHIELD LOGO CHROME FENDER TIP LENS KIT



B. FENDER TIP LENS KIT WITH SKULL LOGO



C. HARLEY-DAVIDSON "LIVE TO RIDE" LOGO FENDER TIP



D. FLAMES FENDER TIP



E. EAGLE WING FENDER TRIM FOR FAT BOY MODELS



F. EAGLE FENDER TRIM FOR FAT BOY MODELS





G

**G. CHROME FRONT FUEL TANK MOUNTING HARDWARE KIT**



H

**H. BAR & SHIELD LOGO COIL COVER**

**G. CHROME FRONT FUEL TANK MOUNTING HARDWARE KIT**

Beauty lies in the details. And this chrome-plated Fuel Tank Mounting Hardware Kit ensures you won't leave this one overlooked. The perfect finishing touch to your fuel tank, the kit includes the machined washers and custom nuts required for your model.

**62965-01** **\$29.95**  
Fits '00-later Softail® models (except FLSTSE).

**H. BAR & SHIELD LOGO COIL COVER**

Featuring a radical open-face design with a Bar & Shield logo silhouette, this chrome coil cover matches Chrome Voltage Regulator Cover P/Ns 74597-01, 74582-00 and 74578-97 for an integrated custom look. Includes all mounting hardware.

**74616-04** **\$37.95**  
Fits '01-later EFI equipped Softail models (except FXCW/C) and '04-later EFI equipped Dyna® models.

**I. CHROME VOLTAGE REGULATOR**

We've taken the stock regulator and chromed it with our superior process. It fits and works exactly like the stock part, but adds a custom shine to an otherwise dark area.

**74610-08** Fits '08-later Softail models. **\$139.95**

**74610-07** — Fits '07 Softail models. ~~OBSOLETE~~ **\$139.95**

**74610-01** Fits '01-'06 Softail® models. **\$139.95**

**74537-93A** **\$109.95**

Fits '89-'95 1340 models, '96 FLT, FLHT, and FLHR models (except fuel injected), '96-'99 Softail® and '96-'98 Dyna models.

**J. CHROME VOLTAGE REGULATOR COVER**

With a look that creates its own electricity, this chrome-plated cover features an embossed Bar & Shield logo and an open-center grill that allows air to flow right through for regulator cooling. Designed for easy installation. Chrome mounting hardware included.

**74597-01** **\$38.95**

Fits '01-later Softail models. Will fit models equipped with Bullet Front Spoiler P/N 57039-XX. Will not fit with other Softail front spoilers.

**74582-00** **\$38.95**

Fits '00 Softail models. (Will not fit with front spoiler.)

**74578-97** Fits '89-'99 Softail models. **\$43.95**

**K. SOFTAIL CHROME FRONT SPOILER**

This spoiler is manufactured from injection-molded, high impact materials, and finished with bright, mirror-polished chrome. The kit includes all hardware for installation.

**57101-07** **\$184.95**

Fits '07 FX Softail and FLSTF models with oval voltage regulator. Will not fit with Premium Oil Cooler Kit P/N 26157-07 or Chrome Voltage Regulator Cover. Will not fit with engine guards.

**57101-01** **\$184.95**

Fits '01-'06 FX Softails and FLSTF models. Will not fit with Premium Oil Cooler P/N 26136-05, 26157-07 or Chrome Voltage Regulator Covers. Will not fit with engine guards.

**L. CHROME BULLET FRONT SPOILER KIT**

Finished in bright, mirror-polished chrome, this Bullet Front Spoiler adds a long, stretched look without modifying the frame. The deep chin spoiler flows into side rails that cover the frame tubes all the way back to the swingarm. Easy-to-install, this kit contains all necessary mounting hardware.

**57006-03** **\$359.95**

Fits '01-'06 FX Softail models. Will not fit with Engine Guards or Premium Oil Cooler Kit P/N 26136-05 or 26157-07.



I

**I. CHROME VOLTAGE REGULATOR**



J

**J. CHROME VOLTAGE REGULATOR COVER**



K

**K. SOFTAIL CHROME FRONT SPOILER**



L

**L. CHROME BULLET FRONT SPOILER KIT**



# 288 SOFTAIL®

## Hand Controls

### CHROME HAND CONTROL COMPONENTS

The flash of chrome. It's the first thing that everyone sees. And the one thing that everyone remembers. Dressing your bike's hand controls in chrome is one of the first steps in building a complete custom ride. After all, the hand controls are the one visual and physical connection you have with your bike every minute you are in the saddle. Harley-Davidson offers all the components you need to make the custom conversion.

A complete Chrome Hand Control makeover would include:

- Chrome Clutch Bracket and Master Cylinder Reservoir Kit
- Chrome Switch Housing Kit
- Chrome Switch Cap Kit
- Chrome Hand Control Levers
- Custom Hand Grips
- Custom Brake Lines and Control Cables

### A. CHROME CLUTCH BRACKET AND MASTER CYLINDER RESERVOIR KIT

Replace your stock painted aluminum controls with brilliant chrome, without compromising on quality. This kit is manufactured from the Original Equipment components, and includes Chrome Master Cylinder Cover. When combined with Chrome Switch Housing Kit, Chrome Switch Cap Kit and other Genuine Motor Accessories, this front brake control kit provides a look that does more than stop your bike – it'll stop traffic.

**45355-08** **\$329.95**  
Fits '08-later Dyna and Softail models equipped with single disc front brakes.

**45355-06A** **\$329.95**  
Fits '06-'07 Dyna and Softail models equipped with single disc front brakes. (Does not fit models equipped with hydraulic clutch.)

**46418-05A** **\$329.95**  
Fits '05-'07 Touring and '06 Dyna and Softail models with dual disc front brakes. (Does not fit models equipped with hydraulic clutch.)

**45284-99D** **\$329.95**  
Fits '96-'03 XL, '96-'05 Dyna and Softail models with single disc front brakes. (Does not fit models equipped with hydraulic clutch.)

**45281-99D** **\$329.95**  
Fits '96-'03 XL, '96-'05 Dyna, Softail and '96-'04 Touring models with dual disc front brakes. (Does not fit models equipped with hydraulic clutch.)

**46112-02D** **\$399.95**  
Fits '02-'05 VRSC™ models. Also fits hydraulic clutch equipped '96-'05 Dyna, Softail, and '96-'04 Touring models with dual disc front brakes.

### B. CHROME SWITCH HOUSING KIT

Convert your housings from black to chrome with this complete kit. Includes left, right, upper and lower housings. No switches or wiring required. Installation instructions included.

**70222-96B** **\$139.95**  
Fits '96-later VRSC, XL, XR, Dyna, Softail and FLHR Road King® models. Does not fit FXSTDSE and FLHRSE12 models.

### C. CHROME MASTER CYLINDER COVER

Includes one chrome-plated cover, gasket, and decal. Easily installed with included stainless steel screws.

**46424-05B** **\$34.95**  
Fits '05-'07 Touring and '06-later Dyna and Softail models.

**45078-96D** **\$34.95**  
Fits '96-'03 XL, '02-'05 VRSC, '96-'05 Dyna, Softail and '96-'04 Touring models.

### D. CHROME SWITCH CAP KIT

Shaped for the same ergonomic feel as the Original Equipment hand control switches, these caps replace the stock black caps without re-wiring.

**71804-03** **\$18.95**  
Fits '96-later XL, XR, Dyna, Softail and FLHR models, '02-later VRSC models, and '98-01 FLHRC models. FLHR models with cruise control use Kit P/N 71808-03.



CHROME HAND CONTROLS COMPONENTS



A. CHROME CLUTCH BRACKET AND MASTER CYLINDER RESERVOIR KIT (SHOWN WITH CHROME SWITCH HOUSING)

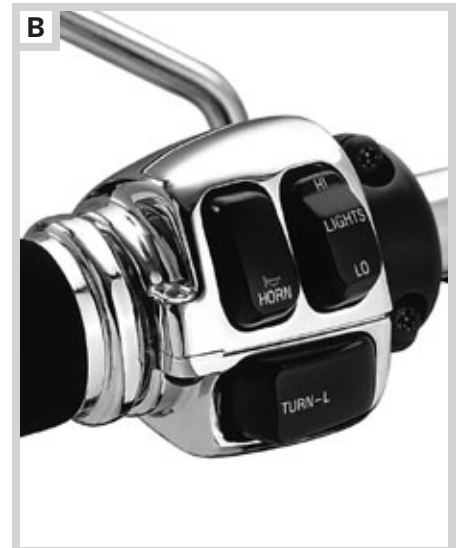

B. CHROME SWITCH HOUSING KIT



C. CHROME MASTER CYLINDER COVER

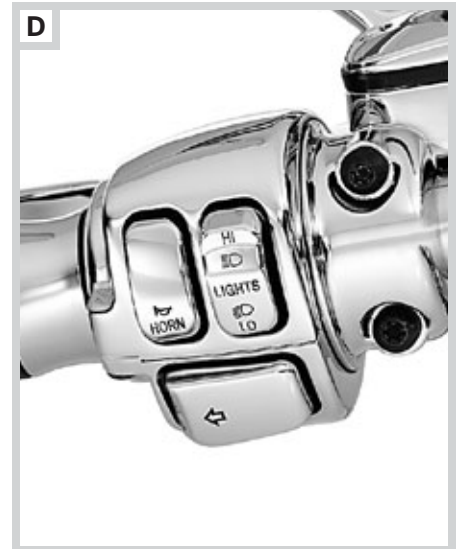

D. CHROME SWITCH CAP KIT (SHOWN WITH CHROME SWITCH HOUSING)

*Notice: The prices appearing in this catalog are the manufacturer's suggested retail prices. Actual retail prices may vary.*



E. CHROME HAND CONTROL LEVER KIT



F. BLACK HAND CONTROL LEVER KIT



G. CUSTOM BRAIDED CONTROL CABLES – DIAMONDBACK SHOWN



H. CUSTOM BRAIDED BRAKE LINE KIT – DIAMONDBACK SHOWN



I. REDUCED EFFORT CLUTCH KIT

**E. CHROME HAND CONTROL LEVER KIT**

Continue the chrome theme with these Hand Control Levers. Cast from aluminum, these levers feature a custom finish designed to match the accessory chrome hand controls or complement Original Equipment-style black components. Clutch anti-rattle clip and new pivot bushings included.

**45075-08** **\$99.95**  
Fits '08-later Dyna® and Softail® models.

**45075-07** **\$99.95**  
Fits '96-'03 XL models and '96-'07 Dyna, Softail and Touring models. (Does not fit police models, VRSC™ models, or models equipped with hydraulic clutch.)

**46114-07** **\$85.95**  
Fits '02-'05 VRSC models and '96-'06 Dyna, Softail and Touring models equipped with a hydraulic clutch.

**F. BLACK HAND CONTROL LEVER KIT**

Grab some black with these levers – a natural fit for black accessory handlebars or to further the blacked-out look of your motorcycle. A clutch anti-rattle clip and new pivot bushings are included.

**44994-08** **\$99.95**  
Fits '08-later Dyna and Softail models.

**44994-07** **\$99.95**  
Fits '96-'03 XL models and '96-'07 Dyna, Softail and Touring models. (Does not fit police models, VRSC models, or models equipped with hydraulic clutch.)

**46157-03** **\$99.95**  
Fits '02-'05 VRSC models and '96-'06 Dyna, Softail and Touring models equipped with hydraulic clutch.

**G. CUSTOM BRAIDED CONTROL CABLES**

Dress your bike for maximum custom impact. Harley-Davidson offers a choice of three braided cable finishes to match your customizing style.

Throttle and idle cable kits offer great looks and a smooth, precise action. Internal anti-friction inserts and cable pre-lubrication ensure long life and consistent performance. Kit includes throttle cable, idle cable and any necessary installation hardware.

Clutch cable kits feature anti-friction inserts and factory pre-lubrication to ensure smooth, long lasting cable operation. The internal cable seal eliminates the possibility of transmission fluid leaks, and the exclusive silicone boot attractively and effectively protects the cable adjuster components from moisture. Kit includes clutch cable, adjuster boot, and any necessary installation hardware.

*Refer to the Multi-Fit section pages 607-611 for specific model requirements.*

**H. CUSTOM BRAIDED BRAKE LINE KITS**

Dress your bike for maximum custom impact. Harley-Davidson offers a choice of three braided brake line finishes to match your customizing style. Kits for dual disc models consist of three brake lines with a chrome-plated junction tee, while kits for single disc models consist of a single line.

*Refer to the Multi-Fit section pages 612-615 for specific model requirements.*

**I. REDUCED EFFORT CLUTCH KIT**

Kit includes a new clutch spring and inner/outer ramps that significantly reduce clutch lever effort. Original Equipment on '06-later Twin Cam-equipped models.

**36808-05** **\$44.95**  
Fits '99-'05 Twin Cam-equipped models. Stock on '06-later Twin Cam-equipped models. This kit is not compatible with Screamin' Eagle® Performance Parts.

# 290 SOFTAIL®

## Hand Controls

### A. CHROME HANDLEBAR CLAMP HARDWARE KIT

Finish the show-winning look with brilliant chrome hardware. Manufactured to Original Equipment specifications, this kit replaces the zinc-plated exposed handlebar clamp bolts with chrome-plated socket head cap screws.

**94451-05** **\$8.95**

Fits '94-later FXSTS, FXSTSB, FXSTD, FXSTDSE, FLSTS, FLSTSC, FLSTSB and '05-later FLSTN and FXSTSSE/2 models.

**94452-05** **\$8.95**

Fits '94-'06 FXDL, '06 FXD, FXDB, FXDC, and FXD35, '94-'05 FXDWG, FXDWG2/3, FXR2/3, '94-later FXST, FXSTB, FXSTC, FLST, FLSTC, '94-'06 FLSTF, and '93-'96 FLSTN models.

**94454-05** **\$8.95**

Fits XL1200L, XL1200N, '96-'06 XL883C and XL1200C, '07-later Dyna®, '00 FXR4, FLTSE, and FLSTFSE/2 models.

### B. HANDLEBAR CLAMP BOLT COVERS

Complete the chrome hand control conversion. These thin-wall bolt covers are designed for easy installation over handlebar clamp bolts. The machined brass and chrome-plated covers are corrosion resistant, and the internal spring steel retention clip resists vibration and thermal cycling to securely hold the covers in place. Kit includes 4 covers.

**94413-04** **\$17.95**

Fits 5/16" socket head handlebar clamp bolts. (Does not fit Touring models.)

### C. CHROME HANDLEBAR RISER HARDWARE KIT

Finish the show-winning look with brilliant chrome hardware. Manufactured to Original Equipment specifications, this kit replaces the zinc-plated exposed handlebar riser hardware with chrome-plated bolts and chrome lock washers.

**63027-05** **\$9.95**

Fits '91-later Dyna® (except '08-later FXDB, FXDF and FXDSE/2) and '97-later FXST, FXSTB, FXSTC and FXSTD models. Also fits '93-'00 FXR models.

### D. BILLET HANDLEBAR RISER HARDWARE

Looks great with Original Equipment or billet triple trees. Provides a highly polished and plated, machined steel conical shaped washer. Chrome socket head screw is countersunk into the washer for a very clean look. Screws are chrome-plated.

**63026-05** **\$39.95**

Fits '91-later Dyna models (except '08-later FXDB) and '97-later FXST, FXSTB, FXSTC and FXSTD models. Also fits '93-'00 FXR models.

### E. CHROME RISER CUP WASHER KIT

Add a finishing touch to the riser on your bike. This kit includes two styled and chrome-plated washers that replace the standard metal washers below the handlebar risers. Replaces Original Equipment P/N 56159-73.

**56486-01** **\$23.95**

Fits many XL (except '04-later XL models), Dyna and Softail models. See your Dealer for specific model application. Does not fit with Polyurethane Handlebar Bushing P/N 56165-03.

### F. POLYURETHANE HANDLEBAR RISER BUSHINGS

These Handlebar Riser Bushings replace the Original Equipment stacked rubber and zinc washer combination with a molded one-piece polyurethane bushing and chrome cover. The long-lasting bushing can reduce handlebar vibration, and the chrome cover adds a bright finishing touch.

**56165-03** **\$39.95**

Fits '97-'03 XL, '86-later Dyna (except FXDB) and Softail (except Springer models and FXSTD) models. '86-'93 FL Softail models require use of '94-later Riser Bolts. Will not fit with Chrome Riser Cup Washer Kit P/N 56486-01.



A. CHROME HANDLEBAR CLAMP HARDWARE KIT



B. HANDLEBAR CLAMP BOLT COVERS



C. CHROME HANDLEBAR RISER HARDWARE KIT



D. BILLET HANDLEBAR RISER HARDWARE



E. CHROME RISER CUP WASHER KIT



F. POLYURETHANE HANDLEBAR RISER BUSHINGS



**G. CHROME THROTTLE AND IDLE CABLE ADJUSTER COVERS**



**H. CHROME THROTTLE CABLE CLIP**



**I. CHROME CLUTCH CABLE CLIP**



**J. CHROME BILLET CLUTCH CABLE CLAMP**



**K. BILLET CLUTCH CABLE ADJUSTER DUST COVER**



**L. BILLET BRAKE LINE CLIP**

**G. CHROME THROTTLE AND IDLE CABLE ADJUSTER COVERS**

Replace the black rubber throttle and idle cable boots with brilliant chrome. This two-piece "ball-milled" dust cover offers a striking contrast to Original Equipment black cables, and a natural finishing touch when installing braided cables. Easy-to-install with included hardware.

**64115-04** **\$59.95**

Fits '96-'07 Touring models (except FLHRS with Original Equipment handlebar) and '96-later FXSTB, FLSTS and '05-later FLSTN models. Will fit '05-later Softail® models equipped with a separate purchase of a Front Turn Signal Relocation Kit.

**H. CHROME THROTTLE CABLE CLIP**

Tie up the loose ends to complete your custom ride. When matched to Original Equipment black cables or available braided cables, these chrome-plated clips link the throttle/idle cables with brilliant chrome.

**91274-04** **\$29.95**

Fits '84-later models (except '08-later Touring).

**I. CHROME CLUTCH CABLE CLIP**

It's all in the details. This high-polish chrome-plated clip replaces the plastic clutch cable clip on the frame tube, and locks the cable in place for a custom look. Kit includes chrome cable clip, chrome backing plate, and chrome hardware for easy installation.

**91360-03** **\$29.95**

Fits '00-later Softail® models (except FXCW/C and FXSTSSE3).

**J. CHROME BILLET CLUTCH CABLE CLAMP**

The perfect addition to braided or stock black clutch cables. This Clutch Cable Clamp is machined from aluminum billet, and polished and plated for a lasting shine. The clamp is designed to grip the cable and the frame down tube, adding a custom look to the front of your cycle.

**91147-02** **\$39.95**

Fits models with 1-1/4" diameter front frame down tube (except Touring, '04-later XL, XR, and '06-later Dyna® models).

**91250-03** **\$39.95**

Fits models with 1-1/8" diameter front frame down tube. Fits '84-'08 Touring and '84-'99 Softail models.

**K. BILLET CLUTCH CABLE ADJUSTER DUST COVER**

Replace the black rubber clutch cable boot with brilliant chrome. Machined from billet aluminum, this two-piece "ball-milled" dust cover offers a striking contrast to Original Equipment black cables, and a natural finishing touch when installing a braided clutch cable. Easy-to-install with included hardware.

**64108-03** **\$49.95**

Fits '00-later XL, Dyna® and Softail (except FLSTSE) models. '00-'03 XL models require installation of Clutch Cable Clamp P/N 91147-02, and '04-later XL models require installation of Clutch Cable Clamp P/N 91249-04 (sold separately).

**L. BILLET BRAKE LINE CLIP**

It's the details that count. Replace the Original Equipment black brake line clamp with this beautifully chrome-plated billet aluminum clip. Sized for Original Equipment or accessory braided brake lines, these "ball-milled" clips mount in the factory position for easy installation. Kit includes chrome-plated mounting hardware.

**91336-03** **\$21.95**

For Original Equipment Brake Lines. Fits '00-'07 FXST, FXSTB, FXSTC, FXSTD, and FXDWG models equipped with Original Equipment Brake Lines.

**91364-03** **\$21.95**

Fits '00-later FXST, FXSTB, FXSTC, FXSTD, and FXDWG models equipped with Braided Brake Lines. Also fits '08-later FXST, FXSTB, FXSTC and FXDWG with Original Equipment Brake Lines.

**92006-05** **\$38.95**

For Original Equipment Brake Lines. Fits '97-'07 FLST, FLSTC, FLSTF, and FLSTN models. (two per kit)



# 292 SOFTAIL®

## Foot Controls

### A. CHROME REAR MASTER CYLINDER KIT

Dress your foot controls in brilliant chrome. This kit replaces the black painted rear master cylinder with a polished and plated version, manufactured from Original Equipment components for proper fit and function. The kit includes the mirror-finish master cylinder body, matching chrome master cylinder cover and polished cover hardware.

**41777-05A** **\$164.95**

Fits '05-'07 Touring and '06-later Softail® models.

**41775-04B** **\$164.95**

Fits '99-'04 Touring models and '00-'05 Softail® models.

### B. CHROME REAR MASTER CYLINDER COVER

An easy way to add chrome to your bike is with this chrome-plated version of the stock master cylinder cover.

**46425-05A** **\$29.95**

Fits '05-'07 Touring and '06-later Softail models.

**45149-99C** **\$29.95**

Fits '00-'05 Softail and '99-'04 Touring models.

### C. FL SOFTAIL REAR MASTER CYLINDER COVER

The distinctive styling of our Gear Shift Control Cover P/N 33825-00 is carried over to this chrome-plated Rear Master Cylinder Cover. Designed for easy installation.

**41815-00** **\$64.95**

Fits '00-'06 FL Softail models. Does not fit with Billet Brake Lever P/N 42640-03.

### D. FL SOFTAIL® GEAR SHIFT CONTROL COVER KIT

Sweeping radius lines and chrome-plating give this gear shift control cover distinctive styling. Designed for easy installation. (Shown without toe-shift lever for clarity.)

**33825-00** Fits '00-'06 FL Softail models. **\$64.95**

### E. BILLET FORWARD CONTROL KIT\*

Add a clean, custom look with mirror-finish chrome Billet Forward Controls. Styled to accent the long and lean lines of the Softail frame, this control kit features machined billet mounting plates, billet rear master cylinder, and window-style shift and brake levers. Designed to use the Original Equipment jiffy stand, this kit includes chrome-plated mounting hardware and braided stainless steel rear brake line. Billet plates are drilled to accept Engine Guard mounts.

**33907-01** **\$659.95**

Fits '00-'05 FX Softail® models. Requires separate purchase of Shift, Brake and Footpeg Kit P/N 50346-03 or 50347-03. FXSTD models require separate purchase of Footpeg Spacer Kit P/N 42802-03. Does not fit with 16 Gauge Double Barrel Exhaust System P/N 64901-02.

### F. CHROME AND RUBBER PEG KIT FOR BILLET FORWARD CONTROLS

Kit includes Chrome and Rubber-style Footpegs, Shifter Peg and Brake Pedal Pad to complete the installation of the Billet Forward Control Kit P/N 33907-01.

**50347-03** **\$79.95**

Fits FX Softail models equipped with Billet Forward Control Kit P/N 33907-01.



A. CHROME REAR MASTER CYLINDER KIT



B. CHROME REAR MASTER CYLINDER COVER



C. FL SOFTAIL REAR MASTER CYLINDER COVER



D. FL SOFTAIL GEAR SHIFT CONTROL COVER KIT

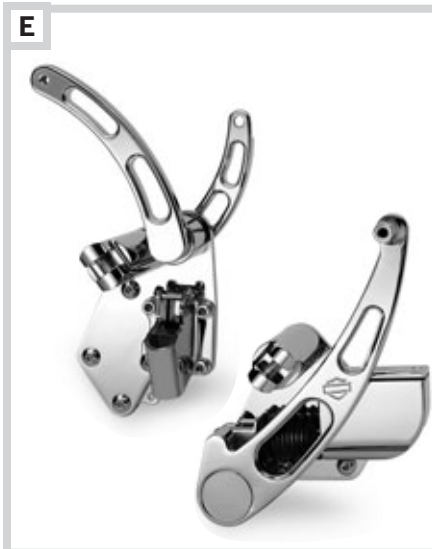

E. BILLET FORWARD CONTROL KIT



F. CHROME AND RUBBER PEG KIT FOR BILLET FORWARD CONTROLS



**\*WARNING:** Installation of this kit may affect cornering clearance. This could distract the rider, causing loss of control, resulting in death or serious injury.

Notice: The prices appearing in this catalog are the manufacturer's suggested retail prices. Actual retail prices may vary.



G

G. FORWARD CONTROL KIT FOR FL SOFTAIL MODELS



G

**G. FORWARD CONTROL KIT FOR FL SOFTAIL MODELS\***

Stretch out and put your feet in the wind. Ideal for taller riders, this kit converts the standard FL Softail footboard controls to Original Equipment FX Softail forward controls. The resulting foot-forward riding position takes the long-limbed rider out of the upright flat-foot, knees-up stance, and puts them in a relaxed laid-back posture. Kit includes left and right brackets, shift lever, brake lever, and all necessary mounting hardware. Footpegs and brake pedal pad sold separately.

**33909-08** **\$319.95**

Fits '07-later FLSTC, FLSTF (except FLSTFB), FLSTN, FLSTSB, and FLSTSC models. Requires separate purchase of appropriate footpeg kit. Compatible footpeg kits for FLSTC and FLSTF are P/N 50305-02, 50359-04, 50370-04, 50474-03, 50500-03, 50506-03, 50576-05, 50695-08, or 50935-07. FLSTN, FLSTSB, FLSTSC and models with Profile® Low suspension require separate purchase of stock FXCW footpegs with wear pegs (51327-08 Left Peg, 51323-08 Right Peg, and 33130-07A Wear Peg (qty 2)).

**H. EXTENDED REACH FORWARD CONTROL KIT\***

This kit extends the rider foot controls a full 3" forward of the stock location, providing the tall rider a comfortable riding position. This comprehensive kit includes everything necessary for installation. The chrome kit includes new chrome brake and shifter mounting assemblies, chrome shift rod, and all necessary hardware. Black kit includes new black painted brake and shifter mounting assemblies, chrome shift rod, and all necessary hardware. The kit is compatible with Original Equipment or accessory footpegs, brake and shift lever, and brake pedal and shifter peg.

Fits '07-later FX Softail® models (except FXSTD). FXCW/C models must reuse Original Equipment footpegs. Not compatible with accessory Shift Linkages. Separate purchase of model-specific rear brake line is required. NOTE: Extended Forward Control Kit is compatible with Engine Guard P/N 49078-04A only.

**49171-08** Chrome. **\$449.95**

**49223-08** Black. **\$449.95**

**Also available:**

**EXTENDED REACH FORWARD CONTROL REAR BRAKE LINE**

Required for installation of Extended Reach Forward Control Kit P/N 49171-08 or 49223-08.

**44970-07** **\$74.95**

Fits '07 FX Softail models (except FXSTD) equipped with Extended Reach Forward Control Kit P/N 49171-08 or 49223-08.

**44972-08** **\$74.95**

Fits '08-later FX Softail models equipped with Extended Reach Forward Control Kit P/N 49171-08 or 49223-08.



H

H. EXTENDED REACH FORWARD CONTROL KIT - LEFT



H

H. EXTENDED REACH FORWARD CONTROL KIT - RIGHT



H

H. EXTENDED REACH FORWARD CONTROL KIT - CHROME



H

H. EXTENDED REACH FORWARD CONTROL KIT - BLACK



**\*WARNING:** Installation of this kit may affect cornering clearance. This could distract the rider, causing loss of control, resulting in death or serious injury.

Notice: The prices appearing in this catalog are the manufacturer's suggested retail prices. Actual retail prices may vary.

# 294 SOFTAIL®

## Foot Controls

### A. HEEL RAISER FOOTPEG KIT

Comfort and cool, clean looks in one. Heel Raiser Chrome and Rubber Footpegs provide a large surface area that lets you change foot position for maximum comfort, and the fold-out heel rest provides floorboard-style support that relieves calf and thigh tension on the highway. The heel rest can be deployed or retracted with your boot while riding. The sole-gripping horizontal black rubber bands complement the mirror-chrome finish, and add vibration isolation and a rich appearance to the pegs. Complete the look with Shifter Pegs and Brake Pedal Pads from the Chrome and Rubber Collection. Heel Raiser mounts to the standard H-D style footpeg support, so it can be used in many rider and passenger applications.

**50178-09 \$189.95**

Fits H-D® male mount style footpeg supports (except the rider position on '02-later VRSCD/DX/F/R/X, '07-later XL883L, XL883N, XL1200N, '08-later XR, '08-later FXCW/C, and passenger position on Softail® models). Fits mid-control equipped XL with engine guards and Highway Peg Mount P/N 50964-98 or 50957-02B. Does not fit with Adjustable Passenger Footpeg Support P/N 50763-09 or 50787-09, or Whiskers Adjustable Highway Bar P/N 50855-09 and 50865-09. Does not fit mid-control position.



A. HEEL RAISER FOOTPEG KIT

### B. MINI FOOTBOARD KIT

This Mini Footboard Kit can be installed in place of traditional footpegs and provides a little additional leg support and more options to move your feet around on a long run. Mini Footboards mount to standard H-D style footpeg supports, and can be used in many rider and passenger applications. A little larger than a bicycle pedal, Footboards can be pivoted to the proper angle for maximum riding comfort. The sole-gripping horizontal black rubber bands complement the mirror-chrome finish, and add vibration isolation and a rich appearance to the pegs. Complete the look with Shifter Pegs and Brake Pedal Pads from the Chrome and Rubber Collection.

**50451-09 \$109.95**

Fits models with forward controls (except FXCW/C, VRSCDX and VRSCF). Does not fit with mid-controls or with Frame Mounted Highway Pegs P/N 50855-09 and 50865-09. Fits passenger male mount style footpeg supports on most models (except '03-earlier XL, '06-earlier VRSC™, '05-earlier Dyna® models, and FXSTD, FLSTSB, FLSTF, FLSTFB, FLSTN, and Softail models with shotgun exhaust). Softail passenger position also requires Support Kit P/N 50454-09.



B. MINI FOOTBOARD KIT

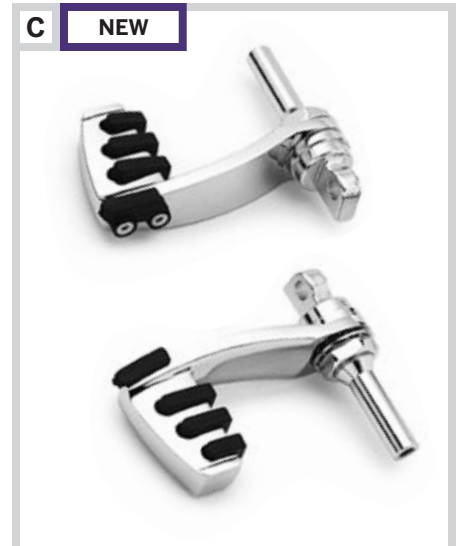

C. AIRFOIL HEEL RESTS

### C. AIRFOIL HEEL RESTS

Designed to complement H-D Airfoil Footpegs, these Airfoil Heel Rests help reduce rider fatigue on a long trip, and add a touch of style around town.

**50281-01 \$119.95**

Fits '89-later FX Softail models (except FXCW/C) and '90-later Dyna models (except '03-later FXDWG and Dyna models with forward controls).

### D. RIDER FOOTPEG HEEL RESTS FOR FORWARD CONTROLS

Give your feet a rest while you're stretching out on your forward controls. These adjustable billet-style Rider Footpeg Heel Rests reduce fatigue and make you look as good as you feel. Just add a pair of matching shifter pegs to complete the custom look (sold separately).

**50227-01 \$119.95**

Fits '93-'02 FXDWG and '89-later FX Softail® models. Also fits Dyna models equipped with Forward Control Kit P/N 49080-93 and late '87-'99 FXSTS and FXSTC models equipped with Extended Reach Forward Control Kit P/N 49163-91.



D. RIDER FOOTPEG HEEL RESTS FOR FORWARD CONTROLS

### E. CHROME FORWARD CONTROL BRACKETS

Check out these Forward Control Brackets. We've taken the Original Equipment black painted components to ensure product quality, and polished and chrome-plated them for a great look. Kit includes new bushings.

**33920-07 \$299.95**

Fits '07-later FXST, FXSTB, FXSTC, FXCW/C and FXSTD models. Stock on FXSTSSE/2/3 models.

**33920-00 \$229.95**

Fits '00-'06 FX Softail models.



E. CHROME FORWARD CONTROL BRACKETS

Notice: The prices appearing in this catalog are the manufacturer's suggested retail prices. Actual retail prices may vary.





F. BILLET STYLE SHIFT LEVER – CHROME



G. BILLET STYLE REAR BRAKE LEVER – CHROME



H. BILLET STYLE SHIFT LEVER – SATIN BLACK



I. BILLET STYLE REAR BRAKE LEVER – SATIN BLACK



J. BULLET SHIFT LEVER



K. AILERON BRAKE LEVER KIT

**F. BILLET STYLE SHIFT LEVER – CHROME**

Styled to complement our billet style mirror stems, these Billet Style Shift Levers are forged from 6061-T6 aluminum, then machined and chrome-plated for a beautiful, custom look. Includes chrome hardware.

**34539-00** **\$79.95**

Fits '91-later Dyna® and '90-later FX Softail® models.

**G. BILLET STYLE REAR BRAKE LEVER – CHROME**

Styled to complement our billet style mirror stems and shift levers, this Billet Style Rear Brake Lever is forged from 2014-T6 aluminum, then machined and chrome-plated for a beautiful, custom look. Brake Pedal Pads sold separately.

**42632-07** **\$159.95**

Fits '07-later FX Softail models.

**H. BILLET STYLE SHIFT LEVER – SATIN BLACK**

Styled to complement our billet style mirror stems, these Billet Style Shift Levers are forged from 6061-T6 aluminum, then machined and black satin powder-coated for a beautiful, custom look. Includes chrome hardware.

**34016-08** **\$79.95**

Fits '91-later Dyna® and '90-later FX Softail models equipped with forward controls.

**I. BILLET STYLE REAR BRAKE LEVER – SATIN BLACK**

Styled to complement billet style mirror stems and shift levers, this Billet Style Rear Brake Lever is forged from 2014-T6 aluminum, then machined and satin black powder-coated for a beautiful, custom look. Brake Pedal Pads sold separately.

**41805-08** **\$159.95**

Fits '07-later FX Softail models.

**J. BULLET SHIFT LEVER**

The “bullet grooved” sweep of this forward curving shift lever accents the style of your low and lean FX Softail model. Designed to complement the “Bullet” shift linkage and mirrors, this beautifully chromed lever also looks great with Original Equipment brake levers and linkages.

**34616-02** **\$89.95**

Fits '91-later Dyna and '90-later FX Softail models.

**K. AILERON BRAKE LEVER KIT**

The “bullet grooved” sweep of this forward curving brake lever accents the style of your low and lean FX Softail model. Designed to complement the Bullet shift linkage and mirrors, this beautifully forged and chromed lever kit includes a matching brake pedal pad. Styled like a fighter plane wing, the Aileron Brake Pedal Pad features curving chrome surrounding a deep black rubber pad, accented with a deeply embossed Bar & Shield logo. Complete the custom look with Aileron Footpegs, Shifter Peg, and Hand Grips.

**42683-02** **\$269.95**

Fits '00-later FXST, FXSTB, FXSTD, and FXSTS models.



# 296 SOFTAIL®

## Foot Controls

### A. BILLET STYLE HEEL/TOE SHIFT LEVER

Styled to complement our billet style mirror stems, these Billet Style Shift Levers are forged from 6061-T6 aluminum, then machined and chrome-plated for a beautiful, custom look. Kit includes a front and rear lever and chrome hardware.

**34535-00B** **\$139.95**

Fits '86-later FL Softail® and '88-later Touring models.

### B. BILLET STYLE REAR BRAKE LEVER

Styled to complement our Billet Style mirror stems and shift levers, these billet style Rear Brake Levers are forged from billet aluminum, then machine-finished and chrome-plated for a beautiful, custom look. Lever matches the length of the Original Equipment extended length lever found on late-model FL Softail motorcycles. Brake pedal pads sold separately.

**42640-03** **\$164.95**

Fits '00-later FL Softail models. Will not fit with Rear Master Cylinder Cover P/N 41815-00.

### C. BILLET STYLE HEEL/TOE SHIFT LEVER – SATIN BLACK

Styled to complement our billet style mirror stems, these Billet Style Shift Levers are forged from 6061-T6 aluminum, then machined and black satin powder-coated for a beautiful, custom look. Kit includes a front and rear lever and chrome hardware.

**34023-08** **\$139.95**

Fits '86-later FL Softail® and '88-later Touring models.

### D. BILLET STYLE REAR BRAKE LEVER – SATIN BLACK

Styled to complement our billet style mirror stems and shift levers, these Billet Style Rear Brake Levers are forged from billet aluminum, then machine-finished and black satin powder-coated for a beautiful, custom look. Brake pedal pads sold separately.

**41800-08** **\$164.95**

Fits '00-later FL Softail models. Will not fit with Rear Master Cylinder Cover P/N 41815-00.

### E. BUCKSHOT HEEL/TOE SHIFT LEVER

Styled to complement the Buckshot hand and foot control collection, this forged billet aluminum shift lever lends a custom look to your bike. The chrome lever features a deep groove perforated with counter-bored holes to catch the light and draw the eye. Kit includes front and rear shift lever and installation hardware.

**34558-05A** **\$139.95**

Fits '86-later FL Softail® and '88-later Touring models.

### F. BUCKSHOT REAR BRAKE LEVER

Forged from billet aluminum for added strength, this extended reach brake lever makes its own custom statement. Featuring a deep groove that runs the length of the arm, the drilled and counter-bored holes add visual interest. Styled to match the Buckshot Hand and Shift Levers, this brake lever complements any grip and footpeg collection.

**42677-05** **\$174.95**

Fits '00-later FL Softail models. Will not fit with Rear Master Cylinder Cover P/N 41815-00.



A. BILLET STYLE HEEL/TOE SHIFT LEVER



B. BILLET STYLE REAR BRAKE LEVER



C. BILLET STYLE HEEL/TOE SHIFT LEVER – SATIN BLACK



D. BILLET STYLE REAR BRAKE LEVER – SATIN BLACK



E. BUCKSHOT HEEL/TOE SHIFT LEVER



F. BUCKSHOT REAR BRAKE LEVER

*Notice: The prices appearing in this catalog are the manufacturer's suggested retail prices. Actual retail prices may vary.*



G. BILLET STYLE REAR BRAKE LEVER



H. CHROME RIDER FOOTBOARD BRACKETS

I. FOLDING HEEL SHIFTER –  
STANDARD POSITIONI. FOLDING HEEL SHIFTER –  
RETRACTED POSITION

J. HEEL/TOE SHIFTER SHAFT COVER

K. HEEL/TOE SHIFTER SHAFT COVER  
WITH INSERT**G. BILLET STYLE REAR BRAKE LEVER**

Styled to complement our billet style mirror stems and shift levers, this Billet Style Rear Brake Lever is forged from 2014-T6 aluminum, then machined and chrome-plated for a beautiful, custom look. Lever matches the length of the Original Equipment standard length lever found on early-model FL Softail motorcycles. Brake Pedal Pads sold separately.

**42640-00** **\$159.95**  
Fits '00-later FL Softail® models.

**42638-00A** **\$159.95**

Fits '87-'99 FLSTC, FLSTS, FLSTF and FLSTN models, and '97-'07 FLHT, FLHTC/I, FLHTCUI, FLHR/I, FLHRCI, FLTR/I models.

**H. CHROME RIDER FOOTBOARD BRACKETS**

Complete the custom transformation by replacing the stock painted footboard brackets with brilliant chrome. This kit is manufactured with Original Equipment components for proper fit, and polished and plated for a finished look. Kit includes chrome mounting hardware.

**33698-07** **\$299.95**

Fits '07-later FLSTC, FLSTF, FLSTFB, FLSTN, FLSTSC and FLSTSB models.

**I. FOLDING HEEL SHIFTER**

Give your left foot a little extra room. Folding Heel Shifter permits the rider to move the rear shift peg out of the way when on the open road, while retaining heel/toe shift functionality around town. Positive detent holds the peg in the selected position, and can be adjusted while riding. Easy-to-install, the replacement rear lever is chrome-plated, and shaped to match the Original Equipment toe shift lever. Lever accepts stock or accessory shifter peg.

**33876-07** **\$69.95**

Fits '86-later FL Softail and '88-later Touring models.

**J. HEEL/TOE SHIFTER SHAFT COVER**

Conceal the splined end of the shifter shaft when you remove the heel shift lever. The easy-to-install chrome-plated aluminum billet cap is held in place with a flush Allen screw for a clean look.

**35471-05** **\$14.95**

Fits '82-later Touring and FL Softail® models equipped with heel/toe shift levers. Installation requires removal of heel shift lever.

**K. HEEL/TOE SHIFTER SHAFT COVER WITH INSERT**

Conceal the splined shifter shaft when you remove the heel shift lever. The kit includes a cover for the shaft end and an insert that conceals the casting and nylon spacer inboard of the shift lever. Manufactured from billet aluminum, these easy-to-install chrome-plated covers are held in place with flush Allen screws for a clean appearance.

**35495-06** **\$26.95**

Fits '00-later FL Softail models equipped with heel/toe shift levers. Installation requires removal of heel shift lever.

# 298 SOFTAIL®

Foot Controls

## A. CUSTOM GEAR SHIFT LINKAGES

Kick your custom into gear with this collection of high quality custom shift linkages. Available in a variety of designs to match your bike's style, these aluminum linkages feature aircraft-quality rod ends for easy adjustment and smooth operation. The easy-to-install linkage kit includes a transmission lever cover and decorative acorn nuts and bolts for a complete custom look. Easy-to-install.

Fits '86-later Softail® and Touring models. (Does not fit '97-'99 FLSTS models, or models equipped with Softail Extended Reach Forward Controls.)

<b>1. 33915-09</b>	Diamond Black.	<b>\$129.95</b>
<b>2. 34018-08</b>	Slotted Black Anodized.	<b>\$129.95</b>
<b>3. 34604-09</b>	Bullet.	<b>\$129.95</b>
<b>4. 34850-09</b>	Skull.	<b>\$129.95</b>
<b>5. 33854-09</b>	Fat Boy Scripted.	<b>\$129.95</b>
<b>6. 33840-09</b>	Flame.	<b>\$149.95</b>
<b>7. 33801-09</b>	Harley-Davidson Scripted.	<b>\$129.95</b>
<b>8. 33762-09</b>	Ball-Milled with Bar & Shield Logo.	<b>\$129.95</b>
<b>9. 33760-09</b>	Slotted with Bar & Shield Logo.	<b>\$129.95</b>
<b>10. 33884-09</b>	Smooth with Bar & Shield Logo.	<b>\$109.95</b>
<b>11. 33807-09</b>	Buckshot.	<b>\$129.95</b>
<b>12. 33823-09</b>	Tribal.	<b>\$149.95</b>



A. CUSTOM GEAR SHIFT LINKAGES – SLOTTED BLACK ANODIZED



A. CUSTOM GEAR SHIFT LINKAGES

Notice: The prices appearing in this catalog are the manufacturer's suggested retail prices. Actual retail prices may vary.

# SOFTAIL® 299

Foot Controls

**B**

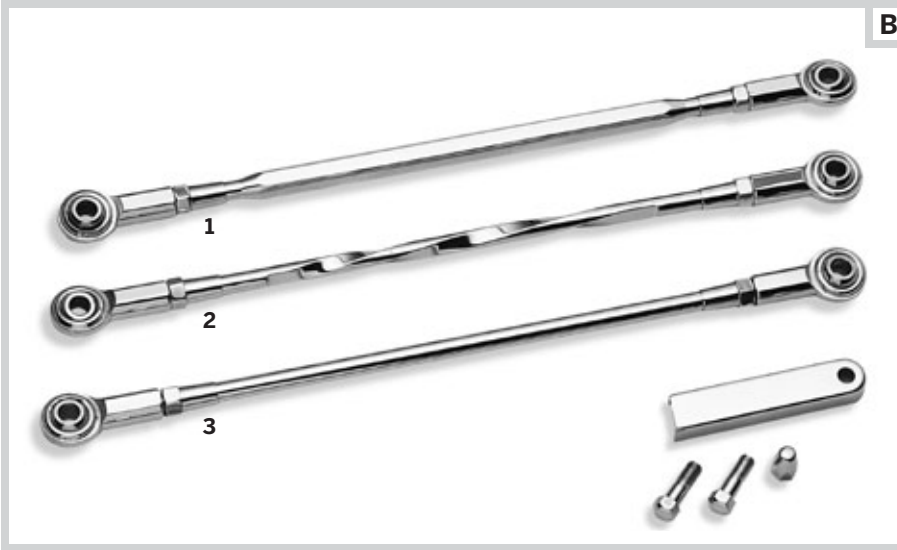

**B. POLISHED STAINLESS STEEL GEAR SHIFT LINKAGES**

**B. POLISHED STAINLESS STEEL GEAR SHIFT LINKAGES**

Kick your customizing into gear with this collection of high quality, polished stainless steel shift linkages. Available in a variety of designs, the linkages feature aircraft-quality rod ends, a stainless steel transmission lever cover and decorative acorn nuts and bolts for a complete custom look. The polished, stainless steel finish will last without chipping, peeling or discoloring. Easy-to-install.

Fits '86-later Softail® and Touring models. (Does not fit '97-'99 FLSTS models, or models equipped with Softail Extended Reach Forward Controls.)

<b>1. 33819-98A</b> Hex.	<b>\$129.95</b>
<b>2. 33817-98A</b> Twisted.	<b>\$109.95</b>
<b>3. 33814-98A</b> Round.	<b>\$89.95</b>

**C. CHROME GEAR SHIFTER LINKAGE COVERS**

A simple and inexpensive way to detail your Softail® model. These easy-to-install chrome-plated covers conceal the stock shifter linkage for a brilliant finish. Kit includes all necessary mounting hardware.

Fits '99-later Softail models with stock shifter linkage.

<b>1. 46300-01</b> Diamond.	<b>\$41.95</b>
<b>2. 46302-01</b> "Harley-Davidson" Script.	<b>\$41.95</b>
<b>3. 46304-01</b> Engraved "Harley-Davidson".	<b>\$41.95</b>

**C**



**C. CHROME GEAR SHIFTER LINKAGE COVER – "HARLEY-DAVIDSON" SCRIPT**

**C**



**C. CHROME GEAR SHIFTER LINKAGE COVERS**

SOFTAIL

*Notice: The prices appearing in this catalog are the manufacturer's suggested retail prices. Actual retail prices may vary.*



# 300 SOFTAIL®

## Engine Guards

### A. MUSTACHE ENGINE GUARD\*

Combine classic shape and modern function for a unique twist on engine protection. The flow of this engine guard complements the traditional style of FL Softail® models, while the gracefully curved upper section incorporates highway pegs into the shape. The integrated rubber pads offer a comfortable and slip-resistant cushion for your feet while traveling the open road. One-piece engine guard kit includes all required mounting hardware.

**49140-05B** **\$249.95**

Fits '00-later FL Softail® models.

### B. NOSTALGIC CURVED CHROME ENGINE GUARD\*

The nostalgic curved shape adds classic style to functionality. Reminiscent of the vintage 1940s style, the one-piece chrome Engine Guard complements the lines of the classic style Softail® Deluxe, Heritage Softail® Classic and FL Springer® models.

**49037-05A** **\$209.95**

Fits '00-later FL Softail models. Accepts Engine Footpeg Mount Kit P/Ns 49102-86T, 49144-86 or 49132-79A.

### C. CHROME FRONT ENGINE GUARD KIT\*

Protect your bike without sacrificing ground clearance or style. The one-piece engine guard is designed to complement the lines of the motorcycle, and the bright chrome finish adds the perfect finishing touch.

**49004-00A** **\$209.95**

Fits '00-later FL Softail models.

**49200-07A** **\$209.95**

Fits '00-later FXST, FXSTB, FXSTC, FXSTD, FXSTS, FXSTSSE/2/3 and FXCW/C models (except models equipped with Extended Reach Forward Control Kit P/N 49171-04 or 49223-04).

**49004-90** **\$234.95**

Fits '86-'99 FL Softail models.

**49016-72D** **\$234.95**

Fits '84-'99 FXST, FXSTC, FXSTS, FXSTSB '80-'86 FXWG, and '72-'85 FX models (except models equipped with Harley-Davidson® Extended Reach Forward Controls). (Does not fit FLSTS.)

**49078-04A** **\$199.95**

Fits '00-later FX Softail models equipped with Extended Reach Forward Control Kit P/N 49171-04, 49223-04, 49171-08 or 49223-08.

### D. GLOSS BLACK ENGINE GUARD KIT\*

A serious finish for serious riders. Before a black powder coat, these engine guards get an extra layer of protection from an E-Coat dip. So go on and install Engine Guard Mount Footpegs, because this finish will go the distance.

**49023-02A** **\$209.95**

Fits '00-later FL Softail models.



A. MUSTACHE ENGINE GUARD



B. NOSTALGIC CURVED CHROME ENGINE GUARD



C. CHROME FRONT ENGINE GUARD KIT



D. GLOSS BLACK ENGINE GUARD KIT



**\*WARNING:** Engine guards may provide limited leg and cosmetic vehicle protection under unique circumstances (fall over while stopped, very low speed slide). They are not made nor intended to provide protection from bodily injury in a collision with another vehicle or any other object.



**\*WARNING:** Do not use engine guard footpegs under normal stop and go operating conditions. Doing so could result in death or serious injury.

Notice: The prices appearing in this catalog are the manufacturer's suggested retail prices. Actual retail prices may vary.



E. WHISKERS ADJUSTABLE HIGHWAY BAR

**E. WHISKERS ADJUSTABLE HIGHWAY BAR\***

Stretch your legs and change riding position while you rack up the miles. Frame-mounted bar can be pivoted fore and aft to accommodate your inseam length, and locks in place with a common Allen wrench. The easy-to-install bar features a three-point mounting system that grips both down tubes. Highway Bar accepts your choice of H-D style male-mount footpegs (*sold separately*). Available in mirror-chrome or gloss black finish.

Fits '00-later Softail models. Does not fit with Heel Raiser Footpeg Kit P/N 50178-09 or Mini Floorboard Kit P/N 50451-09.

<b>50855-09</b>	Chrome.	<b>\$199.95</b>
<b>50865-09</b>	Gloss Black.	<b>\$199.95</b>

**F. BAR & SHIELD LOGO SOFT LOWERS**

Sturdy front engine guard soft lowers feature a durable quick-release buckle attachment for added convenience.

**58562-96A** **\$59.95**

Fits '86-'01 FL Softail® models equipped with Engine Guard P/N 49004-90 or 49004-00A. (Cannot be used with Extended Reach Brake Pedal Kits P/N 42676-02 and 42640-03.)

**G. CHROME BILLET ENGINE GUARD FOOTPEG MOUNTING KIT\***

Here's a stylish way to get your feet into the wind. This beautifully polished and chrome-plated billet aluminum footpeg mount kit installs easily on your engine guard, and lets you stretch your legs on cross-country rides. Works with all H-D style male-mount footpegs.

**50957-02B** **\$99.95**

Fits front engine guards with 1-1/4" diameter tubing (except VRSC Guard P/N 49267-01A, 49388-09, XL Engine Guard P/N 49060-04A, 49215-07 or Softail® Nostalgic Engine Guard P/N 49037-05). Requires separate purchase of Chrome Bullet Tip Footpeg Bolt Kit P/N 94133-01.



E. WHISKERS ADJUSTABLE HIGHWAY BAR



F. BAR &amp; SHIELD LOGO SOFT LOWERS



G. CHROME BILLET ENGINE GUARD FOOTPEG MOUNTING KIT



**\*WARNING:** Engine guards may provide limited leg and cosmetic vehicle protection under unique circumstances (fall over while stopped, very low speed slide). They are not made nor intended to provide protection from bodily injury in a collision with another vehicle or any other object.



**\*WARNING:** Do not use engine guard footpegs under normal stop and go operating conditions. Doing so could result in death or serious injury.



**\*WARNING:** Do not use highway pegs under normal stop and go operating conditions. Doing so could result in death or serious injury.

Notice: The prices appearing in this catalog are the manufacturer's suggested retail prices. Actual retail prices may vary.

# 302 SOFTAIL®

## Engine Guards

### A. CHROME REAR SADDLEBAG GUARDS\*

Saddlebag guards provide a style borrowed from the past that makes a unique statement here and now. Includes mounting hardware and instructions.

**49360-08** **\$209.95**

Fits '05-later FLSTN models. Fits with Saddlebag Kits P/N 88286-07 and 53015-05B. Does not fit with Passenger Footboard Kits. Does not fit with Tool Box Kit P/N 64937-00A or 64938-00.

### B. HERITAGE SPRINGER® REAR SADDLEBAG GUARD KIT\*

Inspired by the nostalgic look of the 50s, these classic-looking touring bars capture the magic of an era gone by. Take a ride back in time with these unique bars, styled exclusively for the Heritage Springer® models. Bars are entirely chrome-plated. Includes mounting hardware.

**49258-00A** **\$179.95**

Fits '00-'03 FLSTS models. Requires the separate purchase of Saddlebag Relocation Kit P/N 90238-00.

### C. CHROME REAR SADDLEBAG GUARDS\*

Saddlebag guards provide a style borrowed from the past that makes a unique statement here and now. Includes mounting hardware and instructions.

**49261-00A** **\$209.95**

Fits '00-later FLST, FLSTC and '00-'05 FXST, FXSTB and FXSTS models. FLSTC models require Saddlebag Relocation Kit P/N 90238-00.

#### Also available:

#### SADDLEBAG BRACKET RELOCATION KIT (not shown)

Required for installation of FLSTS Rear Saddlebag Guards P/N 49258-00A and FLSTC Rear Saddlebag Guard P/N 49261-00.

**90238-00** **\$14.95**

Fits '00-later FLSTS and FLSTC models.

**90345-90A** Fits '97-'99 FLSTS models. **\$14.95**

### D. CHROME CENTER STAND

Lifting your bike upright and off the side stand is ideal for cleaning and servicing, and reduces the space required for parking – handy where space is at a premium in a crowded garage, a small parking spot, or at a ride-in bike show. The robust Chrome Center Stand attaches directly to the frame and does not reduce the lean angle. Designed to work with all Original Equipment suspension configurations and with Profile suspension lowering kits, the adjustable feet can be set to lift the rear tire clear of the pavement, or to keep the rear tire on the ground for reduced lifting effort. The lifting lever is inconspicuously tucked away, and fits with all Harley-Davidson® Original Equipment and accessory footboards. Kit includes chrome stand, black mounting brackets, and all necessary installation hardware.

**98955-07** **\$329.95**

Fits '00-'07 Softail® models (except FLSTS and FLSTSC) with Original Equipment or Profile® Low suspension.

**98959-08** **\$329.95**

Fits '08-later Softail models (except FXCW, FXCWC, and FXSTSSE3) with Original Equipment or Profile Low suspension.



A. CHROME REAR SADDLEBAG GUARDS



B. HERITAGE SPRINGER REAR SADDLEBAG GUARD KIT



C. CHROME REAR SADDLEBAG GUARDS



D. CHROME CENTER STAND



**\*WARNING:** Engine guards may provide limited leg and cosmetic vehicle protection under unique circumstances (fall over while stopped, very low speed slide). They are not made nor intended to provide protection from bodily injury in a collision with another vehicle or any other object.

Notice: The prices appearing in this catalog are the manufacturer's suggested retail prices. Actual retail prices may vary.



E. JIFFY STAND EXTENSION KIT



F. EXTENDED JIFFY STAND KIT

**E. JIFFY STAND EXTENSION KIT**

This kit has been redesigned to add convenience and style to our existing jiffy stand. Polished and chrome-plated, it installs easily and includes all chrome hardware.

**50233-00** **\$39.95**

Fits '84-later Touring (except Trike) and '86-'06 Softail® models (except '05-'06 FLSTN).

**F. EXTENDED JIFFY STAND KIT**

*Original Equipment on the Softail® Deluxe model, this chrome-plated jiffy stand incorporates a ball-tipped extension arm that makes the stand easier to deploy. The extension is easy to find with your boot, and adds confidence when parking the motorcycle.*

~~**50249-05** **\$79.95**~~

~~Fits '89-'06 Softail models.~~

**G. ADJUSTABLE PASSENGER FOOTPEG MOUNT KIT**

Maximize your passenger's riding comfort. Proper foot position reduces the cramped or stretched-out feeling, and relieves pressure on the knees and the tail bone. These Adjustable Mounts raise and lower the passenger footpeg to accommodate taller and shorter passengers. Easy to adjust with common tools, the mount adjusts through a 360° range (depending on model), allowing both fore and aft and up and down height adjustment. Kit includes left and right adjustable support assembly and all required mounting hardware. Footpegs sold separately.

**50787-09** **\$169.95**

Fits passenger position on '00-later Softail models (except FXSTD, FLSTS, FLSTF, FLSTFB, FLSTN and Softail models with shotgun exhaust). Does not fit the rider position. FLSTC and FLSTS models require the separate purchase of Saddlebag Bracket Relocation Kit P/N 90238-00. Does not fit with Heel Raiser Footpeg Kit P/N 50178-09 or Saddlebag Guards P/N 49261-00A or 49258-00A.

**H. CHROME PASSENGER FOOTPEG SUPPORTS**

Polished and plated to a mirror-finish, this chrome version of the Softail® Deluxe Original Equipment black passenger footpeg support complements any of the available passenger footpeg kits. When added to Softail® Deuce™ and Fat Boy® models, this kit extends the passenger footpegs to allow folding without contacting the exhaust system.

**51039-05** **\$89.95**

Fits '07-later Softail models (except FLSTSC), '05-later FLSTN models and '00-'06 FXSTD and FLSTF models with the separate purchase of (1) Screw P/N 4032A and (1) Screw P/N 4519. Also fits FCW models with the additional purchase of (2) Screw P/N 4454 and (2) Spring Washer P/N 50912-72.

**I. PASSENGER FOOTPEG MOUNT KIT**

A necessary addition when converting your solo seat FLSTSB Cross Bones model to a two-up passenger-carrying ride. Kit includes black mounting brackets and all necessary mounting hardware. Footpegs sold separately.

**50932-08** **\$44.95**

Fits '08-later FLSTSB models.



G. ADJUSTABLE PASSENGER FOOTPEG MOUNT KIT



H. CHROME PASSENGER FOOTPEG SUPPORTS



I. PASSENGER FOOTPEG MOUNT KIT

*Notice: The prices appearing in this catalog are the manufacturer's suggested retail prices. Actual retail prices may vary.*



# 304 SOFTAIL®

## Foot Controls

### A. MINI FOOTBOARD KIT

This Mini Footboard Kit can be installed in place of traditional footpegs and provides a little additional leg support and more options to move your feet around on a long run. Mini Footboards mount to standard H-D style footpeg supports, and can be used in many rider and passenger applications. A little larger than a bicycle pedal, Footboards can be pivoted to the proper angle for maximum riding comfort. The sole-gripping horizontal black rubber bands complement the mirror-chrome finish, and add vibration isolation and a rich appearance to the pegs. Complete the look with Shifter Pegs and Brake Pedal Pads from the Chrome and Rubber Collection.

**50451-09 \$109.95**

Fits models with forward controls (except FXCW/C, VRSCDX and VRSCF). Does not fit with mid-controls or with Frame Mounted Highway Pegs P/N 50855-09 and 50865-09. Fits passenger male mount style footpeg supports on most models (except '03-earlier XL, '06-earlier VRSC™, '05-earlier Dyna® models, and FXSTD, FLSTSB, FLSTF, FLSTFB, FLSTN, and Softail® models with shotgun exhaust). Softail passenger position also requires Support Kit P/N 50454-09.

### B. PASSENGER FOOTBOARD SUPPORT KIT

Required for installation of Mini Footboards P/N 50451-09 in the passenger position on many Softail motorcycles.

**50454-09 \$49.95**

Required for installation of Mini Footboards P/N 50451-09 on '00-later Softail models. Does not fit FXSTD, FLSTSB, FLSTF, FLSTFB, FLSTN, and Softail models with shotgun exhaust. FLSTC and FLSTS models require the separate purchase of Saddlebag Bracket Relocation Kit P/N 90238-00.

### C. HALF-MOON RIDER FOOTBOARDS

Combine the style of the 40s with the comfort of today. The classic half moon-shaped rider footboards are available in polished stainless steel or gloss black finish to complement your styling direction. The traditional "Harley-Davidson" rubber insert features a vibration-isolation design for a long, comfortable ride. Kit includes left and right footboard pans and matching rubber inserts.

Fits '86-later FL Softail models.

**51345-08 Polished Stainless. \$149.95**

**51400-08 Gloss Black. \$149.95**

### D. HALF-MOON PASSENGER FOOTBOARDS

Styled to match the Half Moon Rider Footboards, these classic passenger footboards add both style and comfort to your nostalgic ride. Available in mirror-finish chrome or gloss black finish, the kit includes left and right footboard pan and vibration-isolation footboard inserts. Model-specific footboard mounts are sold separately.

Fits '86-later Touring (except Trike), '00-later Softail® and '06-later Dyna models equipped with passenger footboard supports.

**50807-08 Chrome. \$179.95**

**50810-08 Gloss Black. \$179.95**



A. MINI FOOTBOARD KIT



B. PASSENGER FOOTBOARD SUPPORT KIT



C. HALF-MOON RIDER FOOTBOARDS – POLISHED STAINLESS



C. HALF-MOON BLACK RIDER FOOTBOARDS – GLOSS BLACK



D. HALF-MOON PASSENGER FOOTBOARDS – CHROME



D. HALF-MOON PASSENGER FOOTBOARDS – GLOSS BLACK

Notice: The prices appearing in this catalog are the manufacturer's suggested retail prices. Actual retail prices may vary.



**E. TAPERED RIDER FOOTBOARDS WITH  
CRESTED BAR & SHIELD LOGO INSERTS**



**F. TAPERED PASSENGER FOOTBOARDS WITH  
CRESTED BAR & SHIELD LOGO INSERTS**



**G. CRESTED BAR & SHIELD PASSENGER  
FOOTBOARD AND MOUNT KIT – OPEN**



**G. CRESTED BAR & SHIELD PASSENGER  
FOOTBOARD AND MOUNT KIT – FOLDED**



**H. AILERON RIDER FOOTBOARD INSERTS**



**I. OLD-STYLE RIDER FOOTBOARD ASSEMBLY**

**E. TAPERED RIDER FOOTBOARDS WITH CRESTED  
BAR & SHIELD LOGO INSERTS**

Long and lean, the tapered design of these footboards allow maximum flexibility in foot placement for added comfort on long rides. Kit includes left and right tapered footboard pans and rubber isolated deluxe inserts with smooth chrome surround. The inserts feature a slotted rubber design with embossed Bar & Shield logo. Original Equipment on Softail® Deluxe models.

**50634-05** Fits '86-later FL Softail® models. **\$149.95**

**F. TAPERED PASSENGER FOOTBOARDS WITH  
CRESTED BAR & SHIELD LOGO INSERTS**

Styled to match the rider footboards on the Softail Deluxe model, these Tapered Passenger Footboards feature a crested Bar & Shield logo rubber pad surrounded by a chrome accent. The footboard pan is chrome-plated throughout to add a custom touch, even in the folded position.

**50396-05** **\$219.95**

*Fits '86-later Touring (except Trike), Softail and '06-later Dyna models equipped with passenger footboards. Installation on models equipped with passenger footpegs require separate purchase of additional hardware.*

**G. CRESTED BAR & SHIELD PASSENGER FOOTBOARD  
AND MOUNT KIT**

Styled to match the rider footboards on the Softail Deluxe model, these Tapered Passenger Footboards feature a crested Bar & Shield logo rubber pad surrounded by a chrome accent. The footboard pan is chrome-plated throughout to add a custom touch, even in the folded position. Designed for convenient bolt-on installation, the complete kit includes aluminum footboards, rubber pads, mounting hardware and installation instruction.

**50377-07A** **\$329.95**

*Fits '07-later FLSTN models and '08-later FLSTSB models. Passenger Footboard Kits cannot be installed with Pivot Bolt Covers. Does not fit with Chrome Rear Saddlebag Guards P/N 49360-08.*

**H. AILERON RIDER FOOTBOARD INSERTS**

Comfortable and stylish, the Aileron Rider Footboard Inserts lend a custom touch to the Softail Deluxe. Surrounded by a brilliant chrome border, the smooth rubber traction strips are divided by a deep perforated groove. A large Bar & Shield logo completes the custom look. Easy-to-install, the footboard inserts retain cast-in vibration isolation for a fatigue-free ride. Kit includes left and right insert.

**50363-05** **\$199.95**

*Fits '05-later FLSTN models and models equipped with Tapered Rider Footboard Kit P/N 50634-05.*

**I. OLD-STYLE RIDER FOOTBOARD ASSEMBLY**

This rubber-mounted Footboard Assembly brings together classic styling of the Forties with the comfort of today. Footboards are sold individually, and fit left or right side.

**50599-89T** **\$49.95**

*Fits '80-later FLT, FLHT, FLTR and '86-later FLST, FLSTN, FLSTF, FLSTS models. (each)*

# 306 SOFTAIL®

## Foot Controls

### A. BLACK RIDER FOOTBOARD PANS

Complete the blacked-out transformation. Replace the Original Equipment chrome footboard pans with sinister gloss black. Kit includes both the right and left pan, and is installed using the Original Equipment hardware and insert pad. Custom footboard inserts are sold separately.

Fits '86-later Touring models and '86-later FL Softail® models (except FLSTFB).

<b>51322-08</b>	Traditional Shape.	<b>\$79.95</b>
<b>51060-08</b>	Swept Wing Shape.	<b>\$79.95</b>

### B. SOFTAIL® PASSENGER FOOTBOARD AND MOUNT KITS

Convenient bolt-on installation. Includes specially designed mounting stud/brackets for proper installation. Footboards fold up when not in use. Kit includes aluminum footboards, rubber pads, mounting hardware and installation instruction. NOTE: Passenger Footboard Kits cannot be used with Pivot Bolt Covers.

**50602-00A** **\$249.95**

Fits '00-later Softail models (except FLSTS, FLSTSB, FLSTSC, FLSTN, FLSTF, FLSTFB, FXCW, FXCWC and FXSTD). FLSTC models require Saddlebag Bracket Relocation Kit P/N 90238-00.

**50602-89B** **\$249.95**

Fits '86-'99 Softail models (except FLSTS, FLSTF and FLSTN). NOTE: '90-'99 FLSTC models require Saddlebag Bracket Relocation Kit P/N 90345-90A.

### C. CHROME SOFTAIL PASSENGER FOOTBOARD AND MOUNT KIT

Add the custom look of chrome. The complete kit includes specially designed mounting stud/brackets for convenient bolt-on installation. Footboards fold up when not in use. Kit includes chrome footboards, chrome supports, rubber pads, mounting hardware and installation instructions. NOTE: Passenger footboard kits cannot be used with Pivot Bolt Covers.

**52715-04A** **\$399.95**

Fits '00-later Softail® models (except FLSTS, FLSTSB, FLSTSC, FLSTN, FLSTF, FLSTFB, FXCW, FXCWC and FXSTD). FLSTC models require Saddlebag Bracket Relocation Kit P/N 90238-00.

### D. PASSENGER FOOTBOARD SUPPORT KITS

Add the comfort and convenience of passenger footboards to your Softail® motorcycle. These support kits are designed to allow installation of traditional D-shaped, Swept Wing, Tapered or Old-Style Passenger Footboards (*sold separately*) on Softail models. Kit includes left and right supports, footboard mount hinge pins, and installation hardware.

**50460-06** Chrome. **\$249.95**

Fits '00-later Softail models (except FLSTS, FLSTSB, FLSTSC, FLSTN, FLSTF, FLSTFB, FXCW, FXCWC and FXSTD). FLSTC models require Saddlebag Bracket Relocation Kit P/N 90238-00.

**50459-06** Black. **\$139.95**

Fits '00-later Softail® models (except FLSTS, FLSTSB, FLSTSC, FLSTN, FLSTF, FLSTFB, FXCW, FXCWC and FXSTD). FLSTC models require Saddlebag Bracket Relocation Kit P/N 90238-00.

**50400-05** Black. **\$159.95**

Fits '05-'06 FLSTN models. Does not fit with Chrome Rear Saddlebag Guards P/N 49360-08.

**50399-05** Black. **\$159.95**

Fits '00-'06 FLSTF and FXSTD models.

**50399-07A** Black. **\$139.95**

Fits '07-later FLSTF, FLSTFB and FXSTD models.

**50400-07A** Black. **\$139.95**

Fits '07-later FLSTN and '08-later FLSTSB models. Does not fit with Chrome Rear Saddlebag Guards P/N 49360-08.



**A. BLACK RIDER FOOTBOARD PANS – TRADITIONAL SHAPE (SHOWN WITH ORIGINAL EQUIPMENT INSERT)**



**A. BLACK RIDER FOOTBOARD PANS – SWEEP WING SHAPE (SHOWN WITH STREAMLINER INSERT)**



**B. SOFTAIL PASSENGER FOOTBOARD AND MOUNT KITS**



**C. CHROME SOFTAIL PASSENGER FOOTBOARD AND MOUNT KIT**



**D. PASSENGER FOOTBOARD SUPPORT KIT – BLACK**



**D. PASSENGER FOOTBOARD SUPPORT KIT – CHROME**

Notice: The prices appearing in this catalog are the manufacturer's suggested retail prices. Actual retail prices may vary.





**E. SWEPT WING PASSENGER FOOTBOARD PANS – SMOOTH**



**E. SWEPT WING PASSENGER FOOTBOARD PANS – GROOVED**

#### **E. SWEPT WING PASSENGER FOOTBOARD PANS**

These unique Swept Wing Passenger Footboard pans complement the Swept Wing Rider Footboard shape, and allows you to replace the Original Equipment passenger footpegs on certain models with footboards. When folded, the footboard displays a mirror-chrome surface in your choice of Smooth or ball-milled Grooved design. Footboard inserts and footboard supports sold separately.

Fits '86-later Touring models (except Trike), '00-later Softail® models and '06-later Dyna® models equipped with passenger footboard supports.

<b>50716-04</b>	Smooth.	<b>\$139.95</b>
<b>50357-04</b>	Grooved.	<b>\$169.95</b>

#### **F. CHROME PASSENGER FOOTBOARD PAN**

Replace the factory black painted passenger footboard with the custom look of smooth chrome. The kit includes left- and right-hand traditional D-shaped footboard pans, chrome-plated, and ready to install with your Original Equipment hardware. Just add your choice of footboard insert for the finishing touch.

**50752-04** **\$169.95**

Fits '86-later Touring models, '00-later Softail® models and '06-later Dyna® models equipped with passenger footboard supports.

#### **G. SKULL PASSENGER FOOTBOARD COVERS**

Chrome-plated steel footboard cover disguises the Original Equipment passenger footboard, and features a three-dimensional sculptured medallion with the "Harley-Davidson" skull logo. This easy-to-install kit includes all required mounting hardware.

**50836-07** **\$74.95**

Fits '87-later Touring models, '86-later FL Softail models, and '06-later Dyna models equipped with traditional D-shaped aluminum passenger footboards.

#### **H. CHROME PASSENGER FOOTBOARD COVERS**

Easy installation using chrome hardware.

**50782-91** **\$64.95**

Fits '87-later Touring models, '86-later FL Softail models, and '06-later Dyna models equipped with traditional D-shaped aluminum passenger footboards.

#### **I. V-LOGO PASSENGER FOOTBOARD COVERS**

V-Logos are die-cast aluminum integrated with the cover, then chrome-plated for a desirable shine. Includes all mounting hardware.

**50194-96** **\$64.95**

Fits '87-later Touring models, '86-later FL Softail models, and '06-later Dyna models equipped with traditional D-shaped aluminum passenger footboards.

#### **J. ROAD KING® CLASSIC PASSENGER FOOTBOARD COVERS**

The latest in the family of Road King® Classic inspired accessories, this chrome-plated steel footboard cover features a chrome die-cast Road King Classic medallion with black accents and a stylish leather accent piece. Mounting hardware included.

**50246-00** **\$74.95**

Fits '87-later Touring models, '86-later FL Softail models, and '06-later Dyna models equipped with traditional D-shaped aluminum passenger footboards.

#### **K. CONCHO PASSENGER FOOTBOARD COVERS**

Heritage Softail® Classic-inspired conchos make these covers look great whether footboards are up or down.

**50193-96** **\$74.95**

Fits '87-later Touring models, '86-later FL Softail models, and '06-later Dyna models equipped with traditional D-shaped aluminum passenger footboards.

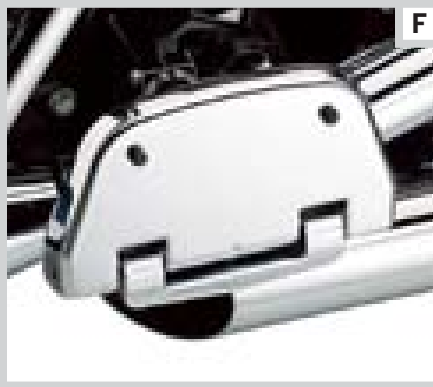

**F. CHROME PASSENGER FOOTBOARD PAN**



**G. SKULL PASSENGER FOOTBOARD COVER**



**H. CHROME PASSENGER FOOTBOARD COVER**



**I. V-LOGO PASSENGER FOOTBOARD COVER**



**J. ROAD KING CLASSIC PASSENGER FOOTBOARD COVER**

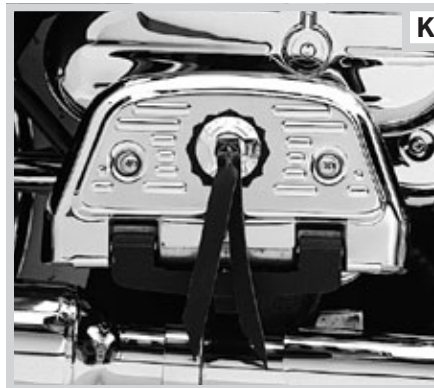

**K. CONCHO PASSENGER FOOTBOARD COVER**

*Notice: The prices appearing in this catalog are the manufacturer's suggested retail prices. Actual retail prices may vary.*



# SOFTAIL® CONSOLES & GAUGES

## SEEING THE WHOLE PICTURE.

*From the rider's perspective, the most visible portion of the bike is the fuel tank and dash panel. Take your time and make wise choices here, because you will look at this view every time you ride.*

---

### LOOK TO THE HORIZON

Sitting high on the tank, the console and tank panel stretch from the seat to the handlebar and dominate your view. Adding a leather pouch provides fingertip storage, and a Personal Accents console insert lets you trim the tank in your custom image.

---

### GET A READING

#### FUEL CAP & GAUGE

*A Flush-Mount Fuel Cap and Gauge emphasizes the long and lean look of the fuel tank. The pop-up filler provides easy access, and the LED gauge disappears when the ignition is off.*

#### SPEEDOMETER / TACHOMETER

*Monitor your engine speed without adding a separate tachometer. This combination gauge offers plug-in installation, and the adjustable multi-color backlighting adds a custom touch.*

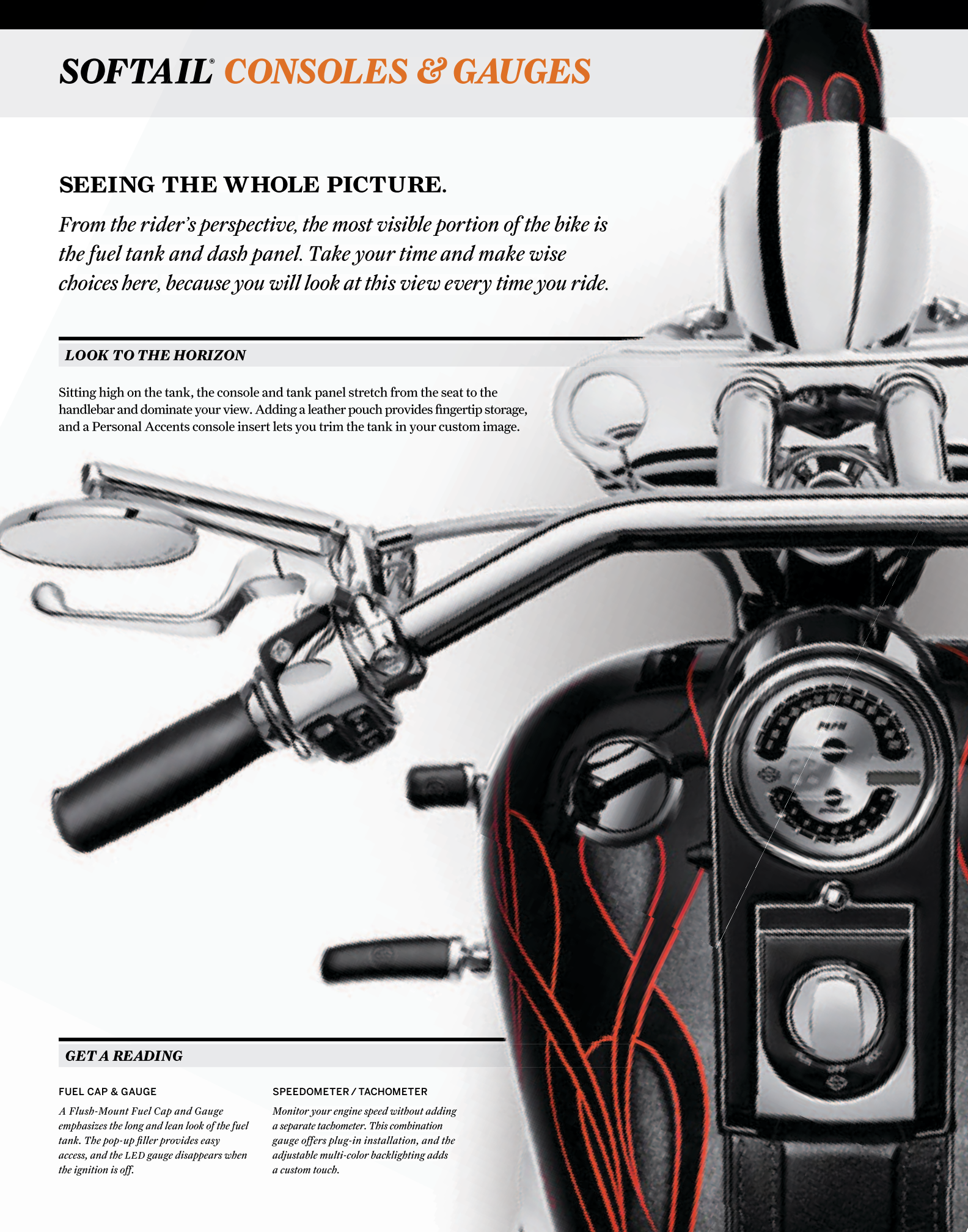

# SOFTAIL® 309

Gauges & Consoles



A

A. LOW-PROFILE CHROME FUEL TANK CONSOLE

## A. LOW-PROFILE CHROME FUEL TANK CONSOLE

Visually stretch the look of your Softail® model's fuel tank. The custom console brings sweeping bands of chrome that run the length of the tank to add a contemporary low-profile look. The speedometer housing features aircraft-style "bolt-on" trim ring, and the ignition switch, turn signal and indicator lights are set into a smooth mirror-chrome field. The console accepts Original Equipment gauges, speedometer switch and wiring harness.

**71208-07** **\$279.95**

Fits '00-later Softail models (except FXSTD, FXCW/C, FLSTSB and models equipped with a Color Shop Stretched Fuel Tank). Will not fit with Combination Speedometer/Tachometer kits. Will not fit with Brawler®, Stripper®, Sidekick®, Sidekick Custom or Rallyrunner® seats or with Skull Fuel Cap P/N 75097-05.

## B. CHROME CONSOLE KIT FOR SOFTAIL® MODELS

Stretch out your Softail tank with this full-length tank console. Die-cast and chrome-plated for custom attitude, the console makes use of the Original Equipment speedometer, ignition switch, indicator lights and wiring harness – so all you have to do is bolt it on and ride. Kit includes hardware and gaskets necessary for installation.

**71202-03** **\$199.95**

Fits '00-later Softail models (except FXSTD, FXCW/C, FLSTSB and models equipped with Color Shop Stretched Fuel Tank).

## C. CHROME CONSOLE KIT WITH LEATHER TANK PANEL

First introduced on the '05 Custom Vehicle Operations Fat Boy® model, this Custom Console features a thick, beefy trim ring surrounding the speedometer for an eye-catching look. The chrome console tapers rearward to blend with the belt-loop leather tank panel. The die-cast and chrome-plated console accepts the Original Equipment speedometer, ignition switch, indicator lamps and wiring harness for simple installation. Kit includes console, leather tank panel with Bar & Shield logo button, hardware and gaskets.

**67575-04** **\$289.95**

Fits '04-later Softail models (except FXCW/C, FXSTD, FLSTN, FLSTSB and models equipped with Color Shop Stretched Fuel Tank).

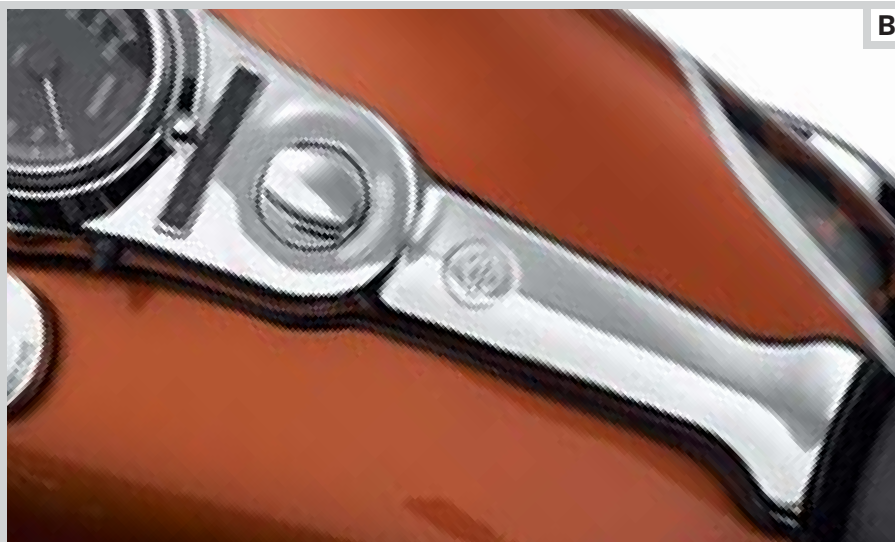

B

B. CHROME CONSOLE KIT FOR SOFTAIL MODELS



C

C. CHROME CONSOLE KIT WITH LEATHER TANK PANEL

SOFTAIL

Notice: The prices appearing in this catalog are the manufacturer's suggested retail prices. Actual retail prices may vary.



# 310 SOFTAIL®

Gauges & Consoles

## A. CHROME BILLET DASH PANEL EXTENSION

Chrome-plated billet aluminum trim kit adds a dash of chrome from console to the front of the seat, adding a custom touch without the expense of a custom tank. Easy-to-install, the dash panel kit includes a formed gasket to protect the tank's surface.

**71296-07** **\$74.95**

Fits '00-later Softail® models (except FXSTD, FXCW/C, FLSTSB, FLSTFSE2, FXSTSSE/2, '09-later FLSTC and FLSTSE models).

## B. CHROME DASH PANEL EXTENSION FOR SOFTAIL® MODELS

Stretch the lines of your chrome dash panel the full length of the fuel tank. This chrome-plated trim kit continues the lines and finishes of your standard tank panel to the front of the seat, adding a custom touch without the expense of a custom tank.

**71283-01** **\$41.95**

Fits '00-later Softail® models (except FXSTD, FXCW/C, FLSTSB, FLSTFSE2, FXSTSSE/2, '09-later FLSTC and FLSTSE models).

## C. CAT'S EYE CONSOLE TANK PANEL WITH POUCH

Trim your fuel tank with high-quality, durable genuine leather. The tank panel features a convenient leather-covered hard-shell storage pouch that retains its shape, and a fingertip turn-buckle to secure the flap for easy access. The embossed Bar & Shield logo adds a classic finishing touch, and is styled to complement Bar & Shield Embossed Windshield Bag P/N 58308-95.

**91643-09** **\$79.95**

Fits '09-later FLSTC with Original Equipment console. Also fits '08-later FLSTSB models equipped with two-up seat.

## D. LEATHER TANK PANEL WITH FAT BOY® CONCHO

Give your Softail® model additional attitude with this leather tank panel featuring an authentic Fat Boy concho.

**91134-01** **\$59.95**

Fits '00-later Softail® models (except FXCW/C, FXSTD, FLSTSB, FLSTFSE2, FXSTSSE/2/3, '09-later FLSTC and FLSTSE) and '93-'03 FXDWG models.

## E. LEATHER TANK PANEL WITH CHROME SPOTS

Replace your Original Equipment tank strip with this leather panel, spotted in shimmering chrome. The chrome spots and concho are styled to match your Heritage Softail® Classic.

**91129-01** **\$59.95**

Fits '00-later Softail models (except FXCW/C, FXSTD, FLSTSB, FLSTFSE2, FXSTSSE/2/3, '09-later FLSTC and FLSTSE) and '93-'03 FXDWG models.

## F. LEATHER TANK PANEL WITH EMBOSSED SKULL LOGO

Add a little menace to your bike with this skull-embossed leather tank panel.

**91001-01** **\$49.95**

Fits '00-later Softail models (except FXCW/C, FXSTD, FLSTSB, FLSTFSE2, FXSTSSE/2/3, '09-later FLSTC and FLSTSE) and '93-'03 FXDWG models.



A. CHROME BILLET DASH PANEL EXTENSION



B. CHROME DASH PANEL EXTENSION FOR SOFTAIL MODELS



C. CAT'S EYE CONSOLE TANK PANEL WITH POUCH



D. LEATHER TANK PANEL WITH FAT BOY CONCHO



E. LEATHER TANK PANEL WITH CHROME SPOTS



F. LEATHER TANK PANEL WITH EMBOSSED SKULL LOGO

Notice: The prices appearing in this catalog are the manufacturer's suggested retail prices. Actual retail prices may vary.

**G. PREMIUM TANK PANEL WITH POUCH****G. PREMIUM TANK PANEL WITH POUCH**

This leather tank panel features an over-sized pouch for convenient "at your fingertips" storage. The heavy duty leather pouch will maintain its shape for miles to come while the bold chrome Bar & Shield medallion sits proudly on the flap for all to admire.

**91135-09** Fits '00-later Softail® models (except FXCW/C, FXSTD, FLSTSB, FLSTFSE2, FXSTSSE/2/3, '09-later FLSTC and FLSTSE) and '93-later FXDWG, '06 FXD35 and '07-later FXDF and FXDC models. '93-'03 FXDWG models require the separate purchase of Clip P/N 10102 and O-Ring P/N 11174. **\$99.95**

**H. LEATHER TANK PANEL WITH POUCH FOR SOFTAIL® CUSTOM MODELS**

This durable leather panel features an integrated storage pouch, perfect for the small items you need to keep handy. Constructed of tough steerhide over a rigid molded base, the panel and chrome button are styled to complement the Softail Custom seat and saddlebags.

**91758-07** Fits '00-later Softail® models (except FXCW/C, FXSTD, FLSTSB, FLSTFSE2, FXSTSSE/2/3, '09-later FLSTC and FLSTSE) and '93-later FXDWG, '06 FXD35 and '07-later FXDF and FXDC models. '93-'03 FXDWG models require the separate purchase of Clip P/N 10102 and O-Ring P/N 11174. **\$79.95**

**I. LEATHER TANK PANEL WITH POUCH FOR FAT BOY® MODELS**

This durable leather panel features an integrated storage pouch, perfect for the small items you need to keep handy. Constructed of tough steerhide over a rigid molded base, and decorated with Spanish lacing to match the '07-later Fat Boy model.

**91621-07** Fits '00-later Softail® models (except FXCW/C, FXSTD, FLSTSB, FLSTFSE2, FXSTSSE/2/3, '09-later FLSTC and FLSTSE) and '93-later FXDWG, '06 FXD35 and '07-later FXDF and FXDC models. '93-'03 FXDWG models require the separate purchase of Clip P/N 10102 and O-Ring P/N 11174. **\$79.95**

**J. LEATHER TANK PANEL WITH TEARDROP CONCHO AND POUCH**

Stylish leather tank panel puts a convenient storage pouch right at your fingertips. Embossed basket-weave pattern and bright chrome teardrop concho matches the Softail® Springer® Classic trim, and complements other smooth leather and vinyl seats and bags.

**91469-06** Fits '00-later Softail® models (except FXCW/C, FXSTD, FLSTSB, FLSTFSE2, FXSTSSE/2/3, '09-later FLSTC and FLSTSE) and '93-later FXDWG, '06 FXD35 and '07-later FXDF and FXDC models. '93-'03 FXDWG models require the separate purchase of Clip P/N 10102 and O-Ring P/N 11174. **\$79.95**

**K. LEATHER TANK PANEL WITH POUCH, CONCHO AND CHROME STUDS**

**91407-00** Fits '00-later Softail models (except FXCW/C, FXSTD, FLSTSB, FLSTFSE2, FXSTSSE/2/3, '09-later FLSTC and FLSTSE) and '93-'03 FXDWG models. **\$79.95**

**91177-97** Fits '84-'99 Softail models. **\$89.95**

**L. LEATHER TANK PANEL WITH POUCH AND BRAIDED TRIM**

This decorative, yet durable leather panel has an integrated storage pouch, perfect for those small items you like to keep handy. Constructed of tough steerhide over a rigid, molded base and decorated with H-D® concho and braided leather lacing.

**91409-00** Fits '00-later Softail models (except FXCW/C, FXSTD, FLSTSB, FLSTFSE2, FXSTSSE/2/3, '09-later FLSTC and FLSTSE) and '93-'03 FXDWG models. **\$79.95**

**91026-94A** Fits '84-'99 Softail models. **\$89.95**

**M. LEATHER TANK PANEL WITH POUCH, CONCHO AND BRAIDED FLAP**

**91408-00** Fits '00-later Softail models (except FXCW/C, FXSTD, FLSTSB, FLSTFSE2, FXSTSSE/2/3, '09-later FLSTC and FLSTSE) and '93-'03 FXDWG models. **\$79.95**

Fits '00-later Softail models (except FXCW/C, FXSTD, FLSTSB, FLSTFSE2, FXSTSSE/2/3, '09-later FLSTC and FLSTSE) and '93-'03 FXDWG models.

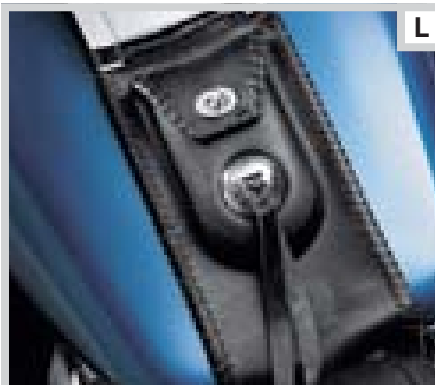
**H. LEATHER TANK PANEL WITH POUCH FOR SOFTAIL CUSTOM MODELS****I. LEATHER TANK PANEL WITH POUCH FOR FAT BOY MODELS****J. LEATHER TANK PANEL WITH TEARDROP CONCHO AND POUCH****K. LEATHER TANK PANEL WITH POUCH, CONCHO AND CHROME STUDS****L. LEATHER TANK PANEL WITH POUCH AND BRAIDED TRIM****M. LEATHER TANK PANEL WITH POUCH, CONCHO AND BRAIDED FLAP**



# 312 SOFTAIL®

## Gauges & Consoles

### COMBINATION SPEEDOMETER/TACHOMETERS

Maintain the clean view over the handlebar. This unique Combination Speedometer/Tachometer allows you to monitor engine speed without adding a handlebar-mounted tach. The unit mounts in the stock dash opening and is a direct plug-in installation.

#### A. COMBINATION SPEEDOMETER/TACHOMETER – COLOR-MATCHED LIGHTING

Utilizing the trip reset push-button, the multi-color LED lighting system allows the rider to adjust the backlighting of the gauge to the color of choice. With over 600 color tone options, the gauge lighting can be matched to any paint scheme or viewing preference. The gauge features an easy-to-read LCD odometer/tripmeter. Mileage reinstatement is available through your Dealer.

Fits '08-later Softail® models with 5" dash-mounted speedometer.

<b>74744-08</b>	MPH.	<b>\$499.95</b>
<b>74746-08</b>	KPH.	<b>\$499.95</b>

Fits '07 Dyna® FXDC, FXDWG, Softail®, and Road King® models.

<b>74676-07</b>	MPH.	<b>\$499.95</b>
<b>74677-07</b>	KPH.	<b>\$499.95</b>



A. COMBINATION SPEEDOMETER/TACHOMETER – COLOR-MATCHED LIGHTING

#### B. 4" COMBINATION SPEEDOMETER/TACHOMETER – COLOR-MATCHED LIGHTING

This unique Combination Speedometer/Tachometer allows you to monitor engine speed without adding a handlebar-mounted tach. The unit mounts in the stock 4" gauge opening and is a direct plug-in installation. Utilizing the trip reset push-button, the multi-color LED lighting system allows the rider to adjust the backlighting of the gauge to the color of choice. With over 600 color tone options, the gauge lighting can be matched to any paint scheme or viewing preference. The gauge features an easy-to-read LCD odometer/tripmeter. Mileage reinstatement is available through your Dealer.

**74734-08** \$499.95

Fits '08-later FXCW and FXCWC models.



COLOR-MATCHED LIGHTING



B. 4" COMBINATION SPEEDOMETER/TACHOMETER – COLOR-MATCHED LIGHTING

#### C. COMBINATION SPEEDOMETER/TACHOMETER – NOSTALGIC FACE

Styled to match the Nostalgic Face gauges. The backlit face aids night viewing, and the gauge features an easy-to-read LCD odometer/tripmeter. '08-later fitments include color-matched adjustable backlighting with over 600 color tone options. Mileage reinstatement is available through your Dealer.

Fits '08-later Softail models with 5" dash-mounted speedometer.

<b>74748-08</b>	MPH.	<b>\$499.95</b>
<b>74750-08</b>	KPH.	<b>\$499.95</b>

Fits '07 Dyna FXDC, FXDWG, Softail, and Road King models.

<b>74556-07</b>	MPH.	<b>\$449.95</b>
<b>74557-07</b>	KPH.	<b>\$449.95</b>

Fits '04-'06 Dyna FXDC, FXDWG, Softail and Road King models.

<b>74556-04</b>	MPH.	<b>\$449.95</b>
<b>74557-04</b>	KPH.	<b>\$449.95</b>



C. COMBINATION SPEEDOMETER/TACHOMETER – NOSTALGIC FACE



D. COMBINATION SPEEDOMETER/TACHOMETER – SPUN ALUMINUM FACE

#### D. COMBINATION SPEEDOMETER/TACHOMETER – SPUN ALUMINUM FACE

The backlit face aids night viewing and the gauge features an easy-to-read LCD odometer/tripmeter. Mileage reinstatement available through your Dealer.

Fits '08-later Softail models with 5" dash-mounted speedometer.

<b>74752-08</b>	MPH.	<b>\$499.95</b>
<b>74754-08</b>	KPH.	<b>\$499.95</b>

Fits '07 Dyna FXDC, FXDWG, Softail, and Road King models.

<b>74718-07</b>	MPH.	<b>\$499.95</b>
<b>74719-07</b>	KPH.	<b>\$499.95</b>



E

E. COMBINATION SPEEDOMETER/TACHOMETER – BLACK FACE ('03 MODEL SHOWN)

**E. COMBINATION SPEEDOMETER/TACHOMETER – BLACK FACE**

Maintain the clean view over the handlebar. This unique Combination Speedometer/Tachometer allows you to monitor engine speed without adding a handlebar-mounted tach. The unit mounts in the stock dash opening and is a direct plug-in installation. The backlit face aids night viewing and the gauge features an easy-to-read LCD odometer/tripmeter. Mileage reinstatement available through your Dealer.

Fits '07 Dyna® FXDC, FXDWG, Softail®, and Road King® models.

**74549-07** MPH. **\$499.95**

**74555-07** KPH. **\$499.95**

Fits '04-'06 Dyna FXD35, FXDWG, Softail, and Road King models.

**74549-04** MPH. **\$499.95**

**74555-04** KPH. **\$499.95**

Fits '95-'03 FLHR models and '00-'03 Softail® models (except FXSTD). '95-'98 FLHR models require Speedo/Tach Installation Kit P/N 74468-03.

**74461-03A** MPH. **\$449.95**

**74471-03A** KPH. **\$449.95**

Fits '96-'99 Softail models. '95-'98 Softail models require Speedo/Tach Retrofit Kit P/N 74468-03.

**74473-03A** MPH. **\$449.95**

**74475-03A** KPH. **\$449.95**

**SPEEDOMETER/TACHOMETER INSTALLATION KIT (not shown)**

Allows the installation of the Harley-Davidson® Combination Speedometer/Tachometer on older models.

**74468-03** **\$59.95**

Required to install Speedometer/Tachometer Kit on '95-'98 FLHR, FXDWG, and '96-'98 Softail models.

**F. SPUN ALUMINUM FACE SPEEDOMETER**

Add a touch of luxury and style to your dash. First featured on the '04 Screamin' Eagle® Deuce™ and Electra Glide® motorcycles, these spun aluminum metal-faced gauges offer a rich contrast to a chrome console or black inner fairing surface. The gauges feature subtle Harley-Davidson racing orange back lighting for a unique night-time look. Mileage reinstatement is available through your Dealer.

Fits '04-'06 Dyna® FXDWG, Softail®, and Road King® models, and '06 Dyna FXD35 and '07 FXDC models.

**67313-05A** 5" Speedometer – MPH. **\$199.95**

**67315-05A** 5" Speedometer – KPH. **\$199.95**

**G. NOSTALGIC FACE SPEEDOMETER**

The single numbers and pearl white sweep are the modern interpretation of a classic era speedometer face. This retro style gauge features subtle back lighting for easy night viewing, and an easy-to-read LCD odometer/tripmeter. Original Equipment on the Softail Deluxe, this speedometer mounts in the stock dash opening, and is a direct plug-in replacement. Mileage reinstatement is available through your Dealer.

**67566-05A** MPH. **\$199.95**

Fits '04-'06 FXDWG and Softail, '06 FXD35, '07 FXDC, and '04-'06 non-cruise control equipped Road King models.

**H. GAUGE VISOR RING**

A touch of chrome makes all the difference. These easy-to-install trim rings feature an integrated eyebrow visor to shield the gauge face from the sun's glare. Self-adhesive backing for secure mount.

**74661-04** 4-5/8" Gauge. **\$24.95**

Fits '99-'08 FXDWG, '99-'07 Road King and '99-later Softail models (except FXSTD, FXCW/C, FLSTFSE and Softail models equipped with Chrome Console P/N 67575-04).



F

F. SPUN ALUMINUM FACE SPEEDOMETER



G

G. NOSTALGIC FACE SPEEDOMETER



H

H. GAUGE VISOR RING

# 314 SOFTAIL®

Gauges & Consoles

## A. CLUTCH LEVER BRACKET CLAMP CLOCK

The freedom of the open road dictates the final destination, but sometimes you need to be there on time. Designed to mount to your Clutch Lever Bracket Clamp, this polished stainless steel clock will keep you on schedule. Styled to match Original Equipment gauge design, the clock is available with black or silver face. Waterproof to 3 atmospheres so you don't have to worry when the weather turns bad.

Fits all models. Not compatible with Auxiliary Accessory Switch Housing Kits.

**75041-03** Black Face. **\$59.95**

**75042-03** Silver Face. **\$59.95**

## B. MASTER CYLINDER CLAMP THERMOMETER

Designed to mount to the Brake Master Cylinder Clamp, this polished stainless steel temperature gauge will keep you in touch with the outside air temperature. Styled to match the Original Equipment gauge design and the Clutch Lever Bracket Clamp Clock, the thermometer is available with black or silver face. This waterproof gauge is simple to install.

Fits all models. Not compatible with Auxiliary Accessory Switch Housing Kits.

**75102-04** Black Face, Fahrenheit. **\$59.95**

**75104-04** Silver Face, Fahrenheit. **\$59.95**

**75108-06** Black Face, Celsius. **\$69.95**

**75115-06** Silver Face, Celsius. **\$69.95**

## C. BILLET ANALOG CLOCK

Housed in a billet aluminum case, this unique Analog Clock provides a simple solution to telling time on the road. Strong double-sided tape attaches this water-resistant clock to your master cylinder housing. The available chrome or black finish complements the controls on your bike.

Fits all models. Not compatible with Auxiliary Accessory Switch Housing Kits.

**75055-03** Chrome Finish. **\$54.95**

**75054-03** Black Finish. **\$54.95**

## D. ELECTRICAL ACCESSORY ADAPTER\*

Harness accommodates the addition of multiple electrical accessories to the main battery power circuit on '04-later models.

**70270-04** **\$15.95**

Fits '04-later XL, XR, Dyna®, Softail® and Touring models.



**A. CLUTCH LEVER BRACKET CLAMP CLOCK – BLACK FACE**



**A. CLUTCH LEVER BRACKET CLAMP CLOCK – SILVER FACE**



**B. MASTER CYLINDER CLAMP THERMOMETER – BLACK FACE**



**B. MASTER CYLINDER CLAMP THERMOMETER – SILVER FACE**



**C. BILLET ANALOG CLOCK**



**D. ELECTRICAL ACCESSORY ADAPTER**

\*NOTE: It is possible to overload your motorcycle's charging system by adding too many electrical accessories. If your combined electrical accessories operating at any one time consume more electrical current than your vehicle's charging system can produce, the electrical consumption can discharge the battery and cause vehicle electrical system damage. Ask your dealer for advice about the amount of current consumed by additional electrical accessories.

Notice: The prices appearing in this catalog are the manufacturer's suggested retail prices. Actual retail prices may vary.



E

E. OIL PRESSURE GAUGE KIT



F

F. LIQUID-FILLED OIL PRESSURE GAUGE

**E. OIL PRESSURE GAUGE KIT**

Check your oil pressure at a glance with this oil-filled Pressure Gauge Kit, specifically designed to look good, fit right, and perform properly on your Twin Cam-equipped motorcycle. The custom mounting brackets have been polished and chrome-plated to rigid Harley-Davidson standards and the gauge offers premium reliability. The kit includes all necessary hardware and mounting brackets for quick and clean installation.

**75133-99** **\$84.95**

Fits '99-'05 Dyna® models, '00-later Softail® models, and '99-later FLHT and FLHR models. Does not fit with Billet Rocker Box Covers P/N 17658-03.

**F. LIQUID-FILLED OIL PRESSURE GAUGE**

Contains special non-yellowing fluid that dampens the internal movement for improved gauge reliability. Incorporates corrosion-resistant stainless steel bezel and includes Harley-Davidson Bar & Shield graphics that match various late model instruments. Complete with chrome-plated steel fittings and O-rings for crankcase installation. New mounting design prevents damage from improper installation.

**75012-82D** **\$54.95**

Fits '82-'84 Shovelhead and '84-later Evolution® 1340-equipped models.



NEW

G

G. OIL LEVEL AND TEMPERATURE DIPSTICK WITH LIGHTED LCD READOUT – CHROME



NEW

G

G. OIL LEVEL AND TEMPERATURE DIPSTICK WITH LIGHTED LCD READOUT – BLACK

**G. OIL LEVEL AND TEMPERATURE DIPSTICK WITH LIGHTED LCD READOUT**

New and improved "capacitive" level sensing technology provides the highest degree of accuracy and durability. Now available in chrome and black, these dipsticks allow you to check your oil level and oil temperature with the push of a button. Add function and style by replacing your stock dipstick with this hard working version. No more grabbing a rag to pull your hot dipstick. No more oil drips on your pipes and on the garage floor. Simply push the button and this dipstick lights up with a brilliant backlight. Oil level is indicated by a four-segment readout – it even reminds you to check your oil when it is hot. Designed to be waterproof, the LCD display operates on a long-lasting, replaceable Lithium coin-type battery (CR2032 3V, P/N 66373-06). Display features a low battery indicator, and press-and-hold feature to toggle between Fahrenheit and Celsius.

Fits '00-later Softail® models (except FXCW, FXCWC and FXSTSSE3).

**62955-09** Chrome. **\$139.95**

**63055-09** Black. **\$139.95**

Fits '08-later FXCW, FXCWC and FXSTSSE3 models.

**63002-09** Chrome. **\$139.95**

**Also available:**

**66373-06** **\$1.95**

CR2032 3V Lithium Replacement Battery.

**H. OIL DIPSTICK WITH TEMPERATURE GAUGE**

Replace your Original Equipment oil dipstick with this custom-styled version featuring an easy-to-see mechanical temperature readout with "Harley-Davidson" logo. A chrome-plated cap completes the styling and provides an easy grip for removal.

**62896-00B** **\$29.95**

Fits '00-later Softail® models (except FXCW, FXCWC and FXSTSSE3).

**62668-87TA** Fits '84-'99 Softail models. **\$34.95**



G

G. OIL LEVEL AND TEMPERATURE DIPSTICK WITH LIGHTED LCD READOUT – CHROME (ROCKER SHOWN)



H

H. OIL DIPSTICK WITH TEMPERATURE GAUGE

Notice: The prices appearing in this catalog are the manufacturer's suggested retail prices. Actual retail prices may vary.



# 316 SOFTAIL®

Gauges & Consoles

## HANDLEBAR MOUNTED GAUGES

A wide selection of Auxiliary Gauges are available for your Harley-Davidson® model. Separate purchase of Gauge, Gauge Bracket, and Gauge Housing is required.

### A. 2-5/8" MINI TACH KITS WITH SHIFT LIGHT

Now available with an attention-grabbing rider-selectable shift light, these chrome-plated, 0-8,000 RPM mini tachometers add style and function. Measuring 2-5/8 inches in diameter, these chrome-plated tachs boast superior illumination and high-quality construction. The hard-coated lens is both fog and scratch-resistant and is ultrasonically welded to the case, resulting in a strong, reliable seal. These tach kits deliver impressive accuracy and response. Our exclusive, balanced pointer design allows for a quick, precise needle sweep and minimal low idle flutter. Plus, reverse polarity and over-voltage protection ensures these quality tachs are immune to voltage surges, low-voltage interference and ignition coil inductive kick-back. Tested to the highest industry standards, each kit is specifically designed for each model, with styling that matches current speedometer graphics, including a lighted pointer. Complete wiring, hardware, and installation instructions are included. (NOTE: Mini Tach Kits are not compatible with Windshield Bags.)

Fits '96-'03 and '07-later XL Custom, '96-later FXDWG, '06 FXD35, '07-later FXDC, '08-later FXDF, '84-later FX Softail® (except FXCW/C), '86-later FL Softail (except '07-later FLSTF and FLSTFB), and '94-later Road King® models equipped with Mini Tach Mounting Bracket. Separate purchase of application-specific Mounting Brackets and Gauge Housing is required.

<b>69828-06</b>	Spun Aluminum Face.	<b>\$229.95</b>
<b>69829-06</b>	Black Face.	<b>\$229.95</b>

### B. 2-5/8" MINI TACH KIT

Add style and function with this chrome-plated, 0-8,000 RPM mini tachometer. Measuring 2-5/8 inches in diameter, this chrome-plated tach boasts superior illumination and high-quality construction. Complete wiring, hardware, and installation instructions are included. (NOTE: Mini Tach Kit is not compatible with Windshield Bags.)

**68953-04** Black Face. **\$209.95**

Fits '96-'03 and '07-later XL Custom, '96-later FXDWG, '06 FXD35, '07-later FXDC, '08-later FXDF, '84-later FX Softail® (except FXCW/C), '86-later FL Softail (except '07-later FLSTF and FLSTFB), and '94-later Road King® models equipped with Mini Tach Mounting Bracket. Separate purchase of application-specific Mounting Brackets and Gauge Housing is required.

### C. MINI TACH CYLINDRICAL GAUGE HOUSING

Finish your gauge installation in style. Chrome-plated steel housing features a flat bottom and cylindrical shape for a traditional appearance.

**67523-04** **\$59.95**

Fits models equipped with 2-5/8" Mini Tach and appropriate mounting bracket.

### D. MINI TACH TAPERED GAUGE HOUSING

Housing features a "tapered look" to dress up the Mini Tach for a sleek appearance. Easy replacement for the original Mini Tach gauge housing.

**67524-04** **\$24.95**

Fits models equipped with 2-5/8" Mini Tach and appropriate mounting bracket.



**A. 2-5/8" MINI TACH KIT WITH SHIFT LIGHT – BLACK FACE**



**A. 2-5/8" MINI TACH KIT WITH SHIFT LIGHT – SPUN ALUMINUM FACE**



**B. 2-5/8" MINI TACH KIT – BLACK FACE**



**C. MINI TACH CYLINDRICAL GAUGE HOUSING**



**D. MINI TACH TAPERED GAUGE HOUSING**

Notice: The prices appearing in this catalog are the manufacturer's suggested retail prices. Actual retail prices may vary.



**E. CHROME BILLET MINI TACH MOUNT – FL NACELLE**



**F. CHROME BILLET MINI TACH MOUNTS AND HANDLEBAR CLAMPS**

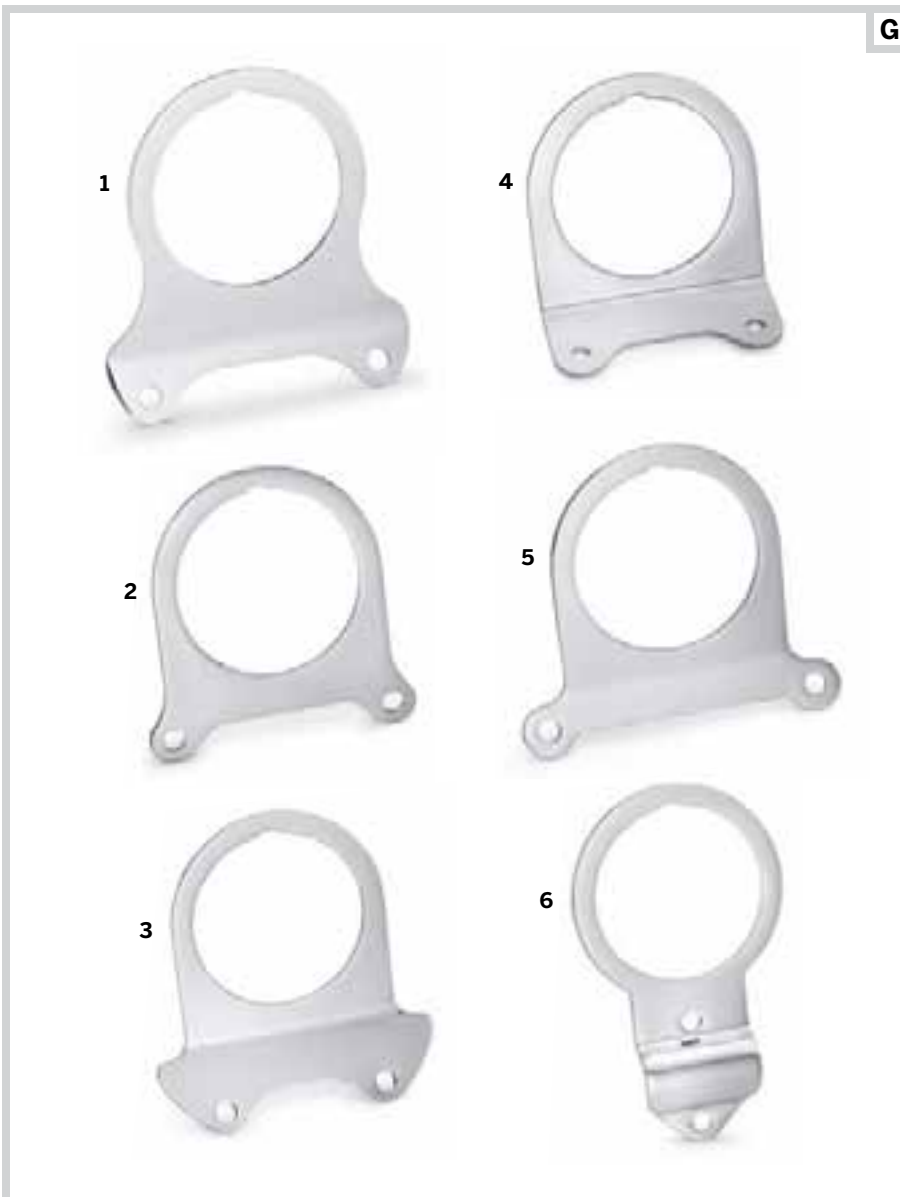

**G. 2-5/8" MINI TACH MOUNTING BRACKETS**

**E. CHROME BILLET MINI TACH MOUNT – FL NACELLE**

Chrome-plated aircraft quality aluminum Mini Tach Mount adds a custom addition to your Road King® model. Scalloped lower edge assembles directly to your stock handlebar clamp cover, for a one-piece look. Add the appropriate 2-5/8" Mini Gauge and gauge housing (*sold separately*) to complete the custom look.

**68961-98A** **\$119.95**

Fits '94-later FLHR models (except FLHRSEI or FLHRS) with H-D Mini Tach Kit (Mini Tach sold separately). Also fits '86-later FL Softail® models equipped with Chrome Headlight Nacelle P/N 67907-96B. (Does not fit with Fat Handlebars and Beach Bars.)

**F. CHROME BILLET MINI TACH MOUNTS AND HANDLEBAR CLAMPS**

Precision-machined chrome-plated aircraft quality aluminum Mini Tach Mount incorporates a "ball-milled" handlebar clamp to add a custom touch to your Softail® or Dyna® Wide Glide® model. Add the appropriate 2-5/8" Mini Gauge and gauge housing (*sold separately*) to complete the custom look.

**1. 68960-98A** **\$159.95**

Fits '93-'05 FXDWG, '86-'06 FLSTF, and '86-later FLST, '86-'08 FLSTC, FLSTN and '99-later FXSTB models with Mini Tach. Does not fit FXDWG models equipped with windshields or FL Softail models with Chrome Headlamp Nacelle. (Does not work with Windshield P/Ns 91820-85A, 57965-97A or '00-later FLSTC models equipped with stock detachable windshield.) '99-earlier FLSTC models require Windshield Bracket Kit P/N 58155-90 for stock windshield to fit.

**2. 68962-98A** **\$119.95**

Fits '84-later FXST and '84-'99 FXSTC models (except FXSTB) with a Mini Tach Kit.

**G. 2-5/8" MINI TACH MOUNTING BRACKETS**

Polished and plated to a brilliant shine, these steel brackets are designed to mount a 2-5/8" Mini Gauge at the ideal viewing angle. Designed for specific applications, these brackets are easy-to-install, and do not interfere with hand controls or indicator lights. Gauge installation requires separate purchase of Gauge Housing.

**1. 67268-06B** **\$64.95**

Fits '06-later FXDWG, '08-later FXDF, '07-later FXSTC and '09-later FLSTC models. Will not fit models equipped with one-piece handlebar with integrated risers, models equipped with Headlamp Nacelle Kit, models equipped with Handlebar Mount Micro Gauges, Road Tech Electronic Compass or Road Tech Radio.

**2. 68150-05** **\$49.95**

Fits '05-later FLSTN and '08-later FXDB models.

**3. 67206-04** **\$54.95**

Fits '96-'05 FXDWG, '06-'07 FXDB, '06 FXD35, '07-later FXDC, '86-later FLSTF, FLSTFB, '86-'08 FLSTC, '93-'96 FLSTN and '00-later FXSTB models. Will not fit models equipped with one-piece handlebar with integrated risers, models equipped with Headlamp Nacelle Kit, models equipped with Handlebar Mount Micro Gauges, Road Tech Electronic Compass or Road Tech Radio.

**4. 67231-04A** **\$54.95**

Fits '94-later FLHR models (except FLHRSEI or FLHRS) with H-D® Mini Tach Kit (Mini Tach sold separately). Also fits '86-later FL Softail® models equipped with Chrome Headlight Nacelle P/N 67907-96B. (Does not fit with Fat Handlebars and Beach Bars.)

**5. 67207-04** **\$54.95**

Fits '84-later FXST (except '06-'09 FXSTSSE) and '96-'99 FXSTC models.

**6. 67218-04** **\$104.95**

Fits '00-later FXSTD and '88-later Softail® Springer® (except '06-'09 FXSTSSE) models. Not compatible with Springer models equipped with Detachable Windshields.

# 318 SOFTAIL®

Gauges & Consoles

## A. FLUSH-MOUNT FUEL CAP AND GAUGE KITS\*

Emphasize the long and lean look of the fuel tank. These flush-mount fuel cap and fuel gauge kits offer a pop-up filler design that when installed and sealed looks identical to the flush gauge. A simple push, and the fuel filler cap pops up to provide ample grip, even while wearing gloves. The flush fuel gauge features individual LED lamps that shine through a mirror-coated glass that glows when the ignition is switched on. Bright, easy-to-view LED lamps automatically dim at night to avoid distraction. Complete kit includes fuel cap, fuel gauge, trim ring, and plug-in wiring harness.

Fits '08-later Softail® models (except FXCW and FXCWC).

<b>62818-08A</b>	Chrome.	<b>\$199.95</b>
<b>75014-08A</b>	Gloss Black.	<b>\$199.95</b>

Fits '08-later FXCW and FXCWC models.

<b>62811-08A</b>	Chrome.	<b>\$199.95</b>
<b>75020-08A</b>	Gloss Black.	<b>\$199.95</b>

Fits '04-'06 carbureted and '01-'07 fuel injected Softail models (except FXSTD/I).

<b>62818-06D</b>	Chrome.	<b>\$199.95</b>
<b>75014-06A</b>	Gloss Black.	<b>\$199.95</b>

\*Some local regulations prohibit using colored lights during vehicle operation on public streets. May not conform to local lighting regulations.



A. FLUSH-MOUNT FUEL CAP AND GAUGE KIT – CHROME

## B. PERSONAL ACCENTS CONSOLE INSERT COLLECTIONS

As a rider, there is probably no part of your bike you see more than your dash and tank console. And thanks to Personal Accents Inserts, it's also the easiest part of your bike to customize. Console inserts are available in a stylish assortment of finishes that blend with your personal direction. Matching Tour-Pak® Inserts are also available to complete the custom transformation.

Fits '00-later Softail® (except FXSTD, FXCW/C, FLSTSB and '09 FLSTC) and '99-'03 FXDWG models.

<b>1. 71337-05</b>	Vivid Black.	<b>\$74.95</b>
<b>2. 71129-05</b>	Bar & Shield.	<b>\$54.95</b>
<b>3. 71172-05</b>	Flamed.	<b>\$54.95</b>
<b>4. 70928-07</b>	Stacked Skulls.	<b>\$54.95</b>

Fits '08-later FXCW and FXCWC models.

<b>2. 71982-08</b>	Bar & Shield.	<b>\$54.95</b>
<b>3. 71986-08</b>	Flamed.	<b>\$54.95</b>
<b>4. 71984-08</b>	Stacked Skulls.	<b>\$54.95</b>
<b>5. 71985-08</b>	Raised Skull.	<b>\$54.95</b>

Fits '00-'07 FXSTD models.

<b>1. 71228-05</b>	Vivid Black.	<b>\$44.95</b>
<b>3. 71149-05</b>	Flamed.	<b>\$29.95</b>
<b>4. 71097-07</b>	Stacked Skull.	<b>\$29.95</b>
<b>5. 71369-05</b>	Raised Skull.	<b>\$29.95</b>



A. FLUSH-MOUNT FUEL CAP AND GAUGE KIT – GLOSS BLACK

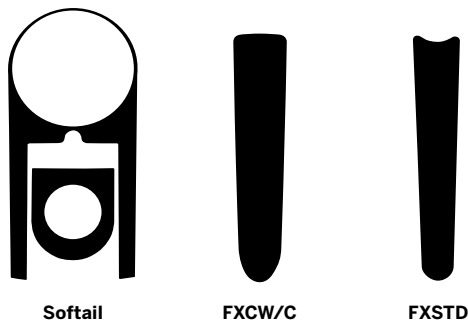

B. PERSONAL ACCENTS CONSOLE INSERT COLLECTIONS

Notice: The prices appearing in this catalog are the manufacturer's suggested retail prices. Actual retail prices may vary.





**C. LED FUEL GAUGE – DIAMOND BLACK COLLECTION**



**D. LED FUEL GAUGE – SKULL COLLECTION**



**E. LED FUEL GAUGE – BAR & SHIELD LOGO**



**F. LED FUEL GAUGE – FLAMES COLLECTION**



**G. LED FUEL GAUGE – SMOOTH (FULL READING SHOWN)**

#### LED FUEL GAUGES\*

This low-profile fuel gauge replaces the analog readout with bright LED lamps. The six edge-mounted LED lamps glow blue when the tank is full, and extinguish one by one as fuel is consumed. Plug-in installation without splicing. Available in seven styles to match Original Equipment and accessory fuel caps.

#### C. LED FUEL GAUGE – DIAMOND BLACK COLLECTION\*

This matte-black gauge features a machined Bar & Shield logo and knurled edges for a raw look. The design complements the Diamond Black Fuel Cap P/N 62778-10, and is the perfect addition to a "blacked-out" custom ride. Photocell automatically adjusts LED brightness for improved visibility in direct sunlight, and dims at night to avoid distraction.

**75358-10** **\$149.95**

Fits '08-later Softail®, Road King® and '09-later Dyna models (except FXD).

**75357-10** **\$149.95**

Fits '04-'08 FXDB, FXDL, FXD35, FXDWG and FXDF models, '07-'08 FXDC models, '04-'07 Softail® models, '01-'03 EFI Softail® models (except FXSTDI), '03-'07 Road King® and '01-'02 EFI Road King® models.

#### D. LED FUEL GAUGE – SKULL COLLECTION\*

Complements the Skull Collection Billet Fuel Cap P/N 75097-05. Photocell automatically adjusts LED brightness for improved visibility in direct sunlight, and dims at night to avoid distraction.

**75098-08** **\$159.95**

Fits '08-later Softail, Road King and '09-later Dyna models (except FXD).

**75095-05A** **\$159.95**

Fits '04-'08 FXDB, FXDL, FXD35, FXDF and FXDWG models, '07-'08 FXDC models, '04-'07 Softail models, '01-'03 EFI Softail models (except FXSTDI), '03-'07 Road King® models, and '01-'02 EFI Road King models.

#### E. LED FUEL GAUGE – BAR & SHIELD LOGO\*

This low-profile fuel gauge matches the Harley-Davidson Bar & Shield logo medallion style of the accessory Self-Locking Fuel Cap.

**75051-08** **\$139.95**

Fits '08-later Softail, Road King and '09-later Dyna models (except FXD).

**75084-04B** **\$139.95**

Fits '04-'08 FXDB, FXDL, FXD35, FXDF and FXDWG models, '07-'08 FXDC models, '04-'07 Softail models, '01-'03 EFI Softail models (except FXSTDI), '03-'07 Road King® models, and '01-'02 EFI Road King models.

#### F. LED FUEL GAUGE – FLAMES COLLECTION\*

This cap complements the Flames Collection Fuel Cap P/N 75176-08. Photocell automatically adjusts LED brightness for improved visibility in direct sunlight, and dims at night to avoid distraction.

**75231-08** **\$149.95**

Fits '08-later Softail, Road King and '09-later Dyna models (except FXD).

**75311-08** **\$149.95**

Fits '04-'08 FXDB, FXDL, FXD35, FXDWG and FXDF models, '07-'08 FXDC models, '04-'07 Softail models, '01-'03 EFI Softail models (except FXSTDI), '03-'07 Road King and '01-'02 EFI Road King models.

#### G. LED FUEL GAUGE – SMOOTH\*

This low-profile fuel gauge matches the profile of the Original Equipment fuel cap.

**75242-08** **\$139.95**

Fits '08-later Softail®, Road King® and '09-later Dyna models (except FXD).

**75237-03B** **\$139.95**

Fits '04-'08 FXDB, FXDL, FXD35, FXDF and FXDWG models, '07-'08 FXDC models, '04-'07 Softail models, '01-'03 EFI Softail models (except FXSTDI), '03-'07 Road King® models, and '01-'02 EFI Road King models.

\*Some local regulations prohibit using colored lights during vehicle operation on public streets. May not conform to local lighting regulations.

Notice: The prices appearing in this catalog are the manufacturer's suggested retail prices. Actual retail prices may vary.



# 320 SOFTAIL®

Gauges & Consoles

## A. FUEL CAP – DIAMOND BLACK COLLECTION

Drift over to the dark side. This matte-black fuel cap features a machined Bar & Shield logo and knurled edges for a raw look and easy grip. The design complements the Diamond Black Fuel Gauge, and is the perfect addition to a “blacked-out” custom ride.

**62778-10** **\$49.95**

Fits '92-later XL and Dyna® (except '04-later FXD, FXDX, '05-'06 FXDC and '07 FXDSE), '00-later Softail® models, and '94-later Road King® models.

## B. FUEL CAP – SKULL COLLECTION

Add a little attitude to your ride. Styled to complement Harley-Davidson® Skull accessory items, the menacing raised skull with black-filled eyes features a rich chrome-plated finish and a styled shape that is easy to grip, even while wearing gloves.

**75097-05** **\$49.95**

Fits '92-later XL and Dyna® (except '04-later FXD, FXDX, '05-'06 FXDC and '07 FXDSE), '00-later Softail® models (except FXSTD, FXSTSSE/2) and '94-later Road King® models. Does not fit with Low-Profile Chrome Fuel Tank Console P/N 71208-07.

## C. BAR & SHIELD LOGO SELF-LOCKING FUEL CAP

Functional and stylish, these polished, chrome-plated caps feature a convenient self-locking mechanism and a stamped Harley-Davidson Bar & Shield logo on the key hole cover. Maintains the same features as the Original Equipment fuel cap. The kits come complete with two keys.

**62803-97A** **\$49.95**

Fits '92-later XL and Dyna® (except '04-later FXD, FXDX, '05-'06 FXDC and '07 FXDSE), '00-later Softail models, and '94-later Road King models. Also fits '99-'00 FXR models.

## D. FUEL CAP – FLAMES COLLECTION

Set your gas tank apart from the rest. These Fuel Caps feature a rich chrome-plated finish and a styled shape that is easy to grip, even while wearing gloves.

**75176-08** **\$49.95**

Fits '92-later XL and Dyna (except '04-later FXD, FXDX, '05-'06 FXDC, and '07 FXDSE), '00-later Softail models (except Deuce), and '94-later Road King models.

## E. BILLET FUEL CAPS

Set your gas tank apart from the rest. These machined Billet Fuel Caps feature a rich chrome-plated finish and a styled shape that is easy to grip, even while wearing gloves.

Fits '92-later XL and Dyna (except '04-later FXD, FXDX, '05-'06 FXDC and '07 FXDSE), '00-later Softail models, and '94-later Road King models.

**62816-03** Cross Design. **\$49.95**

**62819-03** Six Shooter Design. **\$49.95**



A. FUEL CAP – DIAMOND BLACK COLLECTION



B. FUEL CAP – SKULL COLLECTION



C. BAR & SHIELD LOGO SELF-LOCKING FUEL CAP



D. FUEL CAP – FLAMES COLLECTION



E. BILLET FUEL CAP – CROSS



E. BILLET FUEL CAP – SIX SHOOTER

Notice: The prices appearing in this catalog are the manufacturer's suggested retail prices. Actual retail prices may vary.



F. CLOISSONÉ FUEL CAP MEDALLION – SILVER

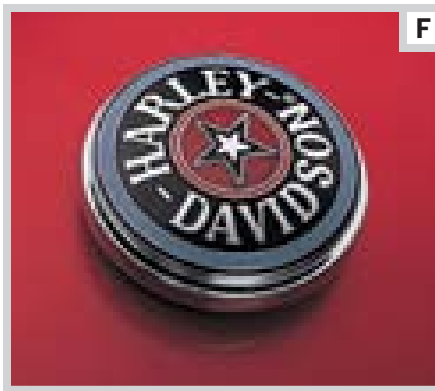

F. CLOISSONÉ FUEL CAP MEDALLION – BLACK



G. FUEL CAP MEDALLION – NUMBER ONE SKULL COLLECTION



H. FUEL CAP MEDALLION – WILLIE G. SKULL COLLECTION



I. FUEL CAP MEDALLION – “LIVE TO RIDE” LOGO – GOLD

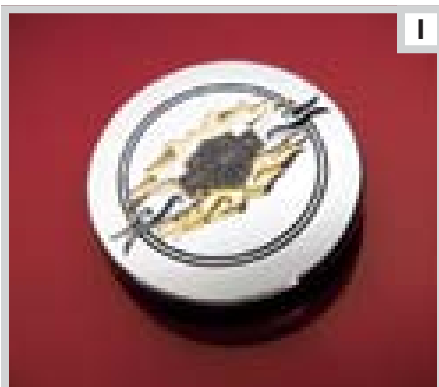

I. FUEL CAP MEDALLION – THE FLAMES COLLECTION

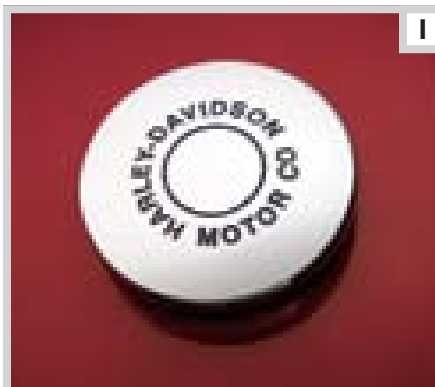

I. FUEL CAP MEDALLION – CHROME “H-D MOTOR CO.” LOGO

**F. CLOISSONÉ FUEL CAP MEDALLION**

Get decorated with this multi-colored cloisonné medallion featuring chrome-plated graphics. Easy installation with self-adhesive backing.

Fits '83-later models (except '05-'06 FXDC, '04-later XL Customs and FXDX models, FXR with plastic fuel cap, Electra Glide®, Tour Glide™, Road Glide®, VRSC™ and fuel caps with fuel gauges).

<b>95741-01</b>	Silver.	<b>\$22.95</b>
<b>99537-96</b>	Black.	<b>\$22.95</b>

**G. FUEL CAP MEDALLION – NUMBER ONE SKULL COLLECTION**

Decorative steel stamping with #1 skull emblem. Contoured to the original Equipment fuel cap. Easy adhesive back installation. (Available September 2009)

Fits '83-later models (except '04-later XL883C, XL1200L and 1200C models, FXD and FXDX models, '05-'06 FXDC, all FXR with plastic fuel cap, Electra Glide, Road Glide, Tour Glide, Trike and VRSC™ models, and all fuel caps with gauges).

<b>99673-10</b>	Chrome.	<b>\$19.95</b>
<b>99688-10</b>	Black.	<b>\$19.95</b>

**H. FUEL CAP MEDALLION – WILLIE G. SKULL COLLECTION**

**99670-04** **\$16.95**

Fits '83-later models (except '04-later XL883C, XL1200L, and XL1200C models, FXD and FXDX models, '05-'06 FXDC, all FXR with plastic fuel cap; Electra Glide, Road Glide, Tour Glide, and VRSC™ models; and all fuel caps with gauges).

**99669-04** **\$16.95**

Fits '04-later XL Custom and XL1200L models.

**I. FUEL CAP MEDALLIONS**

Top off your Original Equipment fuel cap. Adhesive backing for easy installation.

**“Live To Ride” Logo**

Fits '83-later models (except '04-later XL Custom and XL1200L, FXD and FXDX models, '05-'06 FXDC models, all FXR with plastic fuel cap, Electra Glide, Tour Glide, Road Glide, VRSC™ and fuel caps with gauges).

**99020-86T** Chrome. **\$16.95**

**99020-90T** Gold. **\$22.95**

**The Flames Collection**

Fits '83-later models (except '04-later XL Custom and XL1200L, FXD and FXDX models, '05-'06 FXDC models, all FXR with plastic fuel cap, Electra Glide®, Tour Glide™, Road Glide®, VRSC™ and fuel caps with fuel gauges).

**99686-98** **\$22.95**

**Chrome “H-D Motor Co.” Logo**

Fits '83-later models (except '04-later XL883C, XL1200L and 1200C models, FXD and FXDX models, '05-'06 FXDC, all FXR with plastic fuel cap; Electra Glide, Road Glide, Tour Glide and VRSC™ models; and all fuel caps with gauges).

**99539-97** **\$13.95**



## TOURING

*When it comes down to it, nothing compares to the freedom of the open road. Built with a passion for the horizon, the Touring models provide plenty of options to mold your ride into an extension of your body and personal style.*

*For the complete list of Genuine Motor Accessories that appear on these motorcycles or any other Touring motorcycles shown, visit: [www.harley-davidson.com/gallery](http://www.harley-davidson.com/gallery).*

LEFT	FLHTCU Ultra Classic® Electra Glide® Vivid Black
RIGHT	FLHTC Electra Glide® Classic Flame Blue Pearl / Silver
LOCATION	COUNTY ROAD F, STOCKBRIDGE, WI
GPS	N 44° 02.100' - W 88° 17.586'

## ONLY YOU CAN DECIDE HOW YOU RIDE.

*Fit and function are the bare essentials of customizing. If you do nothing else to your motorcycle, make sure your bike fits your body properly and accommodates the type of riding you plan to do.*

*Having the right accessories makes all the difference in the comfort and control you feel on the road. Take the time to learn how your Touring model can be personalized so you can get the most out of your riding experience.*



DASH, CONSOLES & GAUGES  
PG : 439

WINDSHIELDS  
PG : 338

SEATING & BACKRESTS  
PG : 354, 368

HAND CONTROLS  
PG : 424

SADDLEBAGS, TOUR-PAK® & LUGGAGE  
PG : 376

SUSPENSION  
PG : 406

PG : 428  
FOOT CONTROLS

### FINDING YOUR FIT AND FUNCTION

To make your Touring motorcycle fit you like a well-worn pair of jeans, your inspiration is only a few pages away. The page numbers listed at the right will help you quickly navigate to the section of the Catalog that most interests you. Turn the pages, and mark your trail with bent-over corners and scribbled notes in the margins. Customizing is a journey...travel well.

*For the complete list of Genuine Motor Accessories that appear on this motorcycle visit: [www.harley-davidson.com/gallery](http://www.harley-davidson.com/gallery).*

### STOPPING BY THE FIT SHOP



#### A. SEATS

*Where the seat positions your waist relative to the foot controls, hand controls and the ground will impact your riding comfort, so test-sit a variety of seats to get it right.*

#### B. FOOT CONTROLS

*Where your feet meet the controls is equal parts riding style and physical necessity; it also determines the angle of your hip, knee and ankle, so keep it comfortable.*

#### C. HANDLEBAR & CONTROLS

*Each bar has a unique combination of rise, width and pullback—putting your hands, wrists, arms and shoulders in different configurations. See what feels natural and stick with it.*

#### D. RIDE HEIGHT

*Suspension components and seat shape combine to determine your riding position. Finding the right combination is the easiest way for a shorter rider to fit comfortably on a larger bike.*

### GEARING UP WITH RIDER ESSENTIALS

Selecting even the basic accessories can be daunting. Start by adding versatility and long-haul comfort. These windshields, backrests and luggage racks are designed to fit your specific Touring model and will get you ready for the open road.

#### FOR '09–LATER FLHR, FLHRC, FLTR, & FLHT

Standard Height Detachable Sissy Bar Upright .....	52627-09
Smooth Backrest Pad .....	52886-98C
Detachable Two-Up Luggage Rack .....	54215-09
4-Point Detachable Docking Hardware Kit .....	54205-09

#### FOR '09–LATER FLHX

Standard Height Detachable Sissy Bar Upright .....	52627-09
Street Glide® Backrest Pad .....	51663-06
Detachable Two-Up Luggage Rack .....	54215-09
4-Point Detachable Docking Hardware Kit .....	54205-09

#### FOR '09–LATER FLHTC & FLHTCU

Comfort Stitch Rider Backrest .....	52572-09
Air-Wing Tour-Pak Rack .....	79179-08
Tour-Pak® Wall Organizer .....	54014-05
Three Pocket Windshield Pouch .....	58900-98B



# TOURING STYLE

## SHOW OFF THE STYLE YOU WERE BORN WITH.

*This is where your ride becomes a true individual. Where leather and steel become a reflection of your passion, commitment and character. Think about styling your bike as a whole, and what look you are after. Even though your style and taste may change over time, there's only one opinion that matters here, and that's yours.*

### FINDING YOUR STYLE

This Catalog is packed with options that will let you establish your own sense of style. Flip through for inspiration, or use the page numbers below to help you quickly navigate to the pages that cover the areas you would like to customize.



GPS & AUDIO  
PG 616

CUSTOM SEAT PROGRAM  
PG 706

SECURITY & STORAGE  
PG 748

CLEANING & MAINTENANCE  
PG 760

LUGGAGE  
PG 691

### DEFINING YOUR STYLE

The possibilities are endless, so it pays to have an overall plan. Think through your customizing efforts to manage installation costs and minimize your time off the road.

#### A. FRONT & REAR END

*The front forks and rear swingarm are some of the most striking elements on your motorcycle. Custom sliders, axle covers and hardware maximize the visual impression.*

#### B. PAINT

*Your bike's paint sets the tone for the rest of your ride. From the classic and understated to the modern and brash, we have the options to help you find exactly what you want.*

#### C. CUSTOM DETAILS

*Your bike really comes alive in the details. Chrome, stylized or black components will help set your bike apart from the crowd and pull your vision together.*

#### D. WHEELS

*Your wheels, sprocket and rotors take up a lot of visual real estate and are a great way to complement or instantly overhaul the look of your ride.*

# WHAT'S HOT

*We're always pushing our design teams to come up with new, innovative, functional and stylish components to reflect your personal needs. Take a minute to see what we've cooked up, and you'll find the right additions to help you accelerate your riding experience.*



PG 489  
FATSHOTZ  
SLIP-ON MUFFLERS

THE BLACK FIN  
COLLECTION  
PG 518



PG 624  
STEREO HEADSET  
WITH MICROPHONE



AGITATOR  
CUSTOM WHEEL  
PG 670



ROAD TECH™ ZÜMO® 660 GPS NAVIGATOR  
PG 617



PG 472  
SCREAMIN' EAGLE™  
"HEAVY BREATHER"  
PERFORMANCE  
AIR CLEANER



PG 362  
ROAD ZEPPELIN™  
TOURING SEAT



AIRWING SADDLEBAG LID RAIL LED LIGHT KIT  
PG 394



PG 381  
COLOR-MATCHED  
RAZOR-PAK LUGGAGE



**FLHRC**  
**ROAD KING® CLASSIC**

 Color Shop Custom Paint: *Limited Series – Night*

**About This Bike** That slammed, laid-back look isn't just for cruisers. Even this bold and beefy Road King Classic can be lowered to fit your inseam or your personal style.

**COLOR SHOP CUSTOM PAINT**
**NEW** Limited Series Paint Set – *Night* ..... 95716-10DDK

**ACCESSORIES FOR FIT**

Profile® Low Front Suspension ..... 46875-09

Brawler® Solo Seat ..... 51525-09

Profile Low Rear Shocks ..... 54635-09

**HANDLEBAR**

Fat Handlebar ..... 56032-08

Riser Kit ..... 56789-05

Handlebar Cover Kit ..... 67893-02

**ACCESSORIES FOR FUNCTION**

Mustache Engine Guard ..... 49155-09

 4-Point Docking Kit – *Chrome* ..... 54205-09

Saddlebag Hinge Stop Kit ..... 90580-09

**ACCESSORIES FOR STYLE**
**WHEELS & ROTORS**

 Teardrop Brake Rotors – *Front (2)* ..... 44942-08

**FRONT END**

Chrome Front End Kit ..... 46335-08

 Brake Caliper Kit – *Chrome* ..... 42012-06A

**LIGHTING & HORN**

 Visor Trim Ring – *Headlamp* ..... 69733-05

 Visor Trim Ring – *Passing Lamp* ..... 69732-05

 Visor Trim Ring – *Turn Signal (2)* ..... 69749-05

Premium Air Horn Kit ..... 69423-05

**HAND CONTROLS**

 Hand Levers – *Chrome* ..... 38843-08

 Clutch and Master Cylinder Kit – *Chrome* ..... 42117-08

 Hand Grips – *Nostalgic* ..... 56275-08

 Switch Housing Kit – *Chrome* ..... 70228-96C

Split Vision Mirrors ..... 92190-06

**ENGINE & CHASSIS TRIM**

Oil Level &amp; Temp Dipstick ..... 63004-09

Fuel Tank Fitting Cover ..... 62809-06

 Headbolt Bridge – *Chrome* ..... 43858-00

 Domed Timer Cover – *Chrome* ..... 32679-99A

Harley-Davidson® Air Cleaner Cover ..... 29754-01

**FOOT CONTROLS**

Old-Style Rider Footboard – (2) ..... 50599-89T

 Half-Moon Passenger Footboards – *Black* ..... 50810-08

 Shift Linkage – *Road King* ..... 33851-09

 Shifter Peg – *Crested Bar & Shield (2)* ..... 33946-05

 Brake Pedal Pad – *Crested Bar & Shield* ..... 42700-05

For the complete list of Genuine Motor Accessories that appear on this motorcycle visit: [www.harley-davidson.com/gallery](http://www.harley-davidson.com/gallery).

LOCATION ..... DOLLS: KENOSHA, WI

GPS ..... N 42° 34.300' – W 87° 50.749'







**FLHR  
ROAD KING®**

Color Shop Custom Paint: *Spectrum Program – Vivid Black*

**About These Bikes** These custom baggers prove you can ride comfortably, and still turn heads. This Road King and Street Glide® take advantage of their size for a full-out custom look.

**COLOR SHOP CUSTOM PAINT**

- Spectrum Custom Paint – *Vivid Black* ..... 94026A
- Street Stalker Fender – *Vivid Black* ..... 59397-03DH
- NEW** Extended Saddlebags – *Vivid Black* ..... 92003-10DH
- NEW** Razor-Pak Luggage – *Vivid Black* ..... 79175-10DH

**ACCESSORIES FOR FIT & FUNCTION**

- Profile® Low Front Suspension ..... 46875-09
- Rallyrunner® Seat ..... 51527-09
- Profile Low Touring Shocks ..... 54635-09
- NEW** Street Slammer Handlebar – *Black* ..... 55985-10
- Engine Guard – *Black* ..... 49050-09
- Saddlebag Guard – *Black* ..... 49283-09
- Wind Deflector – 11" ..... 58163-02

**ACCESSORIES FOR STYLE**

- WHEELS & ROTORS**
- NEW** Agitator Contrast Chrome Wheel – 18" *Front* ..... 40268-10
- NEW** Agitator Contrast Chrome Wheel – 18" *Rear* ..... 40225-10

**FRONT END**

- Fork Sliders – *Lower, Black* ..... 46546-03
- Fork Slider Covers – *Upper, Black* ..... 45591-02
- Headlamp Nacelle – *Black* ..... 46547-03A

**HAND & FOOT CONTROLS**

- Buckshot Mirrors – *Black* ..... 92416-08
- Hand Grips – *Diamond Black* ..... 56746-08
- Hand Levers – *Black* ..... 38845-08
- Brake Pedal Pad – *Diamond Black* ..... 46718-08
- Rider Footboard Insert – *Diamond Black* ..... 50549-08
- Footpegs – *Diamond Black* ..... 50911-08
- Shifter Pegs – *Diamond Black (2)* ..... 34690-08

**ENGINE & CHASSIS TRIM**

- Engine Covers – *Wrinkle Black* ..... VARIOUS
- Timer Cover – *Black Fin* ..... 32677-01
- Derby Cover – *Black Fin* ..... 25454-01

**SCREAMIN' EAGLE® PERFORMANCE**

- Heavy Breather Air Cleaner – *Black* ..... 29006-09A
- Street Performance Mufflers – *Black* ..... 80742-09
- Exhaust Shield Kit – *Black* ..... 64981-09

**FLHX  
STREET GLIDE®**

Color Shop Custom Paint: *Limited Series – Flow*

**COLOR SHOP CUSTOM PAINT**

- NEW** Limited Series Paint Set – *Flow* ..... 95756-10CZU

**ACCESSORIES FOR FIT**

- Profile® Low Front Suspension ..... 54564-09
- Brawler® Seat ..... 51525-09

**ACCESSORIES FOR FUNCTION**

- Wind Deflector – *Dark Smoked* ..... 57185-05
- Mustache Engine Guard ..... 49155-09

**ACCESSORIES FOR STYLE**

**WHEELS & ROTORS**

- Blade Custom Wheel – 18" *Front* ..... 40818-08
- Blade Custom Wheel – 18" *Rear* ..... 42091-09
- Brake Rotor – *Front (2)* ..... 44553-06A

**FRONT END**

- Windshield Molding – *Bar & Shield* ..... 59133-99
- Chrome Front End Kit ..... 46335-08

**LIGHTING & HORN**

- NEW** Illuminated Mirror Cover – *Chrome* ..... 92600-10
- Dual Bulb Halogen Headlamp Kit ..... 67864-04A

**HAND & FOOT CONTROLS**

- Hand Grips – *Stealth* ..... 56729-08
- Hand Levers – *Chrome* ..... 38843-08
- NEW** Oil Level & Temp Dipstick – *Black* ..... 63030-09

- Billet Brake Lever ..... 42638-08A
- Billet Heel/Toe Shift Lever ..... 34535-00B
- Rider Footboard Inserts – *Stealth* ..... 50202-04
- Footpegs – *Stealth* ..... 50359-04
- Brake Pedal Pad – *Stealth* ..... 42555-04
- Shifter Peg – *Stealth (2)* ..... 34664-04

**SCREAMIN' EAGLE® PERFORMANCE**

- NEW** Ventilator Air Cleaner Kit – *Chrome* ..... 29490-09
- NEW** Nightstick 2-into-1 Muffler ..... 80881-10

For the complete list of Genuine Motor Accessories that appear on these motorcycles visit: [www.harley-davidson.com/gallery](http://www.harley-davidson.com/gallery).

LOCATION SOUTH BOUND PUB & GRILL; MILWAUKEE, WI  
GPS N 42° 52.283' – W 87° 51.522'



**FLTRX**  
**ROAD GLIDE® CUSTOM**

Color Shop Custom Paint: *Limited Series – Primo*

**About This Bike** Taking an aggressive solo approach, this Road Glide Custom is a true hot-rod bagger. Chromed-out and covered in piercing paint, this look is at the core of West Coast custom.

**COLOR SHOP CUSTOM PAINT**

<b>NEW</b> Limited Series Paint Set – <i>Primo</i> .....	95722-10DDJ
Inner Faring Kit – <i>Vivid Black</i> .....	58722-09DH

**ACCESSORIES FOR FIT**

Profile® Low Front Suspension .....	54564-09
Brawler® Seat – <i>Custom</i> .....	51525-09
Adjustable Passenger Footpeg Mount .....	50763-09

**ACCESSORIES FOR FUNCTION**

Wind Deflector .....	57988-09
Engine Guard – <i>Black</i> .....	49050-09
Shorty AM/FM Antenna .....	76388-08
4-Point Docking Hardware – <i>Chrome</i> .....	54205-09

**ACCESSORIES FOR STYLE**

**WHEELS & ROTORS**

<b>NEW</b> Agitator Mirror Chrome Wheel – 18" <i>Front</i> .....	47957-10
<b>NEW</b> Agitator Mirror Chrome Wheel – 18" <i>Rear</i> .....	47951-10
<b>NEW</b> Agitator Brake Rotor – <i>Right Front</i> .....	48981-10
<b>NEW</b> Agitator Brake Rotor – <i>Left Front</i> .....	49000-10

**FRONT END**

Chrome Front End Kit .....	46335-08
----------------------------	----------

**HAND CONTROLS & GAUGES**

Mirrors – <i>Tribal, Chrome</i> .....	92410-09
Hand Grip – <i>Contoured</i> .....	56459-08
Hand Levers – <i>Chrome</i> .....	38843-08
Clutch and Master Cylinder Kit – <i>Chrome</i> .....	42117-08
Switch Housing Kit – <i>Chrome</i> .....	70228-96C
Switch Cap Kit – <i>Chrome</i> .....	71802-03

**ENGINE & CHASSIS TRIM**

Oil Level and Temperature Dipstick .....	63004-09
Transmission Dipstick – <i>Chrome</i> .....	37103-08
Headbolt Bridge – <i>Finned Black</i> .....	43859-00
Billet Air Cleaner Cover – <i>Chrome</i> .....	29745-00A
Air Cleaner Medallion – <i>Screamin' Eagle® 96 CI</i> .....	29929-07
Voltage Regulator Cover – <i>Chrome</i> .....	74538-09

**FOOT CONTROLS**

Billet Brake Lever – <i>Chrome</i> .....	42638-08A
Billet Shift Lever – <i>Chrome</i> .....	34535-00B
Shift Linkage – <i>Chrome Slotted</i> .....	33760-09
Footpegs – <i>Streamliner</i> .....	50211-04
Shifter Peg – <i>Streamliner (2)</i> .....	34967-04

**SCREAMIN' EAGLE® PERFORMANCE**

Stage I Air Cleaner Kit .....	29260-08
Air Cleaner Back Plate – <i>Chrome</i> .....	29624-08

For the complete list of Genuine Motor Accessories that appear on this motorcycle visit: [www.harley-davidson.com/gallery](http://www.harley-davidson.com/gallery).

LOCATION ..... BRADFORD BEACH, MILWAUKEE, WI  
 GPS ..... N 43° 03.387' – W 87° 52.303'



**FLHTK**  
**ELECTRA GLIDE®**  
**ULTRA LIMITED**

Production Color: *Flame Blue Candy/Black Candy*

**About This Bike** This Ultra Limited is equipped to handle that extra long haul. From the heated seat to the Road Tech™ zūmo® GPS navigation system, this ride is ready to take on any weather or road conditions.

**ACCESSORIES FOR FIT**

Profile® Low Front Suspension.....	54564-09
Sun Ray® Heated Touring Seat.....	52633-08
Adjustable Comfort Stitch Rider Backrest.....	52423-09A
Profile Low Rear Shocks.....	54635-09

**ACCESSORIES FOR FUNCTION**

Low Windshield – <i>Lightly Smoked</i> .....	58303-96
<b>NEW</b> Road Tech™ zūmo® 660 GPS Navigator.....	92115-09
Locking Glove Box Doors.....	57411-08
Passenger Grab Rail.....	97026-09
Passenger Handrail Cover.....	91668-05
Detachable Tour-Pak® Mount Kit.....	53246-09A
Chrome Center Stand.....	91573-09

**ACCESSORIES FOR STYLE**

**WHEELS & ROTORS**

Polished Brake Rotors – <i>Front Left</i> .....	44950-08
Polished Brake Rotors – <i>Front Right</i> .....	44959-08

**FRONT & REAR END**

Chrome Front End Package.....	46371-08
Chrome Fender Skirt.....	59228-91
Ultra Classic Tour-Pak Chrome Accent Rail.....	53667-89A

**LIGHTING & HORN**

Tour-Pak Side Marker Light Kit – <i>Smoked</i> .....	54352-09
Auxiliary Turn Signal/Brake Lamp Kit.....	69461-06A

**HAND CONTROLS & GAUGES**

Mirror with Turn Signal – <i>Chrome</i> .....	92059-07
Hand Levers – <i>Chrome</i> .....	38843-08
Clutch and Master Cylinder Kit – <i>Chrome</i> .....	42117-08
Switch Housing Kit – <i>Chrome</i> .....	70228-96C

**ENGINE & CHASSIS TRIM**

<b>NEW</b> Chrome Inner Primary Trim.....	60869-10
Lifter Block Cover – <i>Chrome</i> .....	18278-06
Harley-Davidson® Air Cleaner Cover.....	29754-01

**FOOT CONTROLS**

Rider Footboard Inserts – <i>Chrome &amp; Rubber</i> .....	50176-95
Passenger Footboard Inserts – <i>Chrome &amp; Rubber</i> .....	50177-95
Brake Pedal Pad – <i>Chrome &amp; Rubber</i> .....	42478-95
Footpegs – <i>Chrome &amp; Rubber</i> .....	50131-95A
Chrome Passenger Footboard Pan Kit.....	50752-04
Adjustable Highway Peg – <i>Short Angled</i> .....	50830-07A

**SCREAMIN' EAGLE® PERFORMANCE**

Street Performance Mufflers.....	64985-07A
End Caps – <i>Billet Tapered Slash (2)</i> .....	80623-07
Chrome Muffler Bracket Cover Kit.....	80716-08

For the complete list of Genuine Motor Accessories that appear on this motorcycle visit: [www.harley-davidson.com/gallery](http://www.harley-davidson.com/gallery).

.....  
 LOCATION HWY 106, JEFFERSON, WI  
 .....  
 GPS N 42° 56.001' – W 88° 38.742'





**FLHTCUTG  
TRI GLIDE™  
ULTRA CLASSIC®**

Production Color: *Red Hot Sunglo*

**About These Bikes** Make your three-wheel statement. Loaded up or stripped down, you can choose from hundreds of Touring and Trike accessories that let you define your ride.

**ACCESSORIES FOR FIT**

- NEW Road Zeppelin™ Seat ..... 51072-09
- Adjustable Rider Backrest Kit – *Smooth* ..... 52501-09A

**ACCESSORIES FOR FUNCTION**

- Low Windshield – *Lightly Smoked* ..... 58303-96
- NEW Road Tech™ zūmo® 660 GPS Navigator..... 92115-09
- Air Wing Luggage Rack..... 79179-08
- Rear Guard – *Chrome* ..... 83825-09

**ACCESSORIES FOR STYLE**

**FRONT END**

- Fork Sliders – *Chrome* ..... 83819-09
- Upper Slider Covers – *Chrome* ..... 45963-97
- Front Axle Covers – *Chrome* ..... 44116-07A
- Road King® Classic Fender Skirt..... 59005-98

**LIGHTING**

- LED Windshield Molding Kit ..... 57335-08
- Illuminated Fairing Accent Trim ..... 69290-09
- Tour-Pak® Side Marker Light – *Smoked* ..... 54352-09

**HAND & FOOT CONTROLS**

- Hand Grips – *Nostalgic* ..... 56275-08
- Hand Levers – *Chrome* ..... 38843-08
- Clutch and Master Cylinder Kit – *Chrome* ..... 42117-08
- Switch Housing Kit – *Chrome* ..... 70228-96C
- Rider Footboard Inserts – *Chrome & Rubber* ..... 50176-95
- Passenger Footboard Inserts – *Chrome & Rubber* ..... 50177-95
- Brake Pedal Pad – *Chrome & Rubber*..... 42478-95
- Shifter Peg – *Chrome & Rubber (2)* ..... 34608-95
- Passenger Footboard Covers – *Chrome*..... 50782-91

**ENGINE & CHASSIS TRIM**

- Timer Cover – *H-D® Motor Co* ..... 32047-99A
- Harley-Davidson® Air Cleaner Cover..... 29754-01

**REAR END**

- Fender Trim – *Chrome*..... 83812-09
- Wheel Center Cover Kit..... 83841-09

**FLHXXX  
STREET GLIDE®  
TRIKE**

Production Color: *Vivid Black*

**ACCESSORIES FOR FUNCTION**

- Black Wind Deflector ..... 58204-98
- NEW Chrome Sissy Bar ..... 83921-10
- Passenger Backrest Pad ..... 52920-98A
- NEW Chrome Luggage Rack ..... 83954-10
- NEW Boom! Audio™ Premium Speaker Kit..... 77181-10
- Shorty AM/FM Antenna ..... 76388-08
- Trunk Door Organizer ..... 83928-09

**ACCESSORIES FOR STYLE**

**FRONT END**

- Fork Sliders – *Chrome* ..... 83819-09
- Front Axle Covers – *Chrome* ..... 44116-07A

**HAND & FOOT CONTROLS**

- Hand Grips – *Diamond Black* ..... 56746-08
- Hand Levers – *Black* ..... 38845-08
- Rider Footboard Inserts – *Diamond Black* ..... 50549-08
- Passenger Footboard Inserts – *Diamond Black* ..... 50627-08
- Brake Pedal Pad – *Diamond Black* ..... 46718-08
- Shifter Peg – *Diamond Black (2)* ..... 34690-08
- Billet Brake Lever – *Black* ..... 46883-09
- Billet Heel/Toe Shift Lever – *Black* ..... 34023-08

**ENGINE & CHASSIS TRIM**

- Primary Cover – *Wrinkle Black* ..... 60705-09

- Cam Cover – *Wrinkle Black* ..... 25364-01B
- Rocker Covers – *Wrinkle Black (2)* ..... 17620-99
- Timer Cover – *Dark Custom*..... 32414-09
- Derby Cover – *Dark Custom* ..... 25562-09
- Exhaust Trim ..... 83843-09

**SCREAMIN' EAGLE® PERFORMANCE**

- Heavy Breather Air Cleaner – *Black* ..... 29006-09A
- Street Performance Mufflers – *Black*..... 80742-09
- Exhaust Shields – *Black* ..... 64981-09

For the complete list of Genuine Motor Accessories that appear on these motorcycles visit: [www.harley-davidson.com/gallery](http://www.harley-davidson.com/gallery).

LOCATION ..... KENOSHA HARBOR, KENOSHA, WI  
GPS ..... N 42° 35.344' – W 87° 48.775'



# TOURING WINDSHIELDS

## SPLIT THE WIND.

*At highway speed, you take the wind full-force in the chest, causing fatigue in your arms, neck and shoulders. Take the pressure off with an easy-to-install detachable windshield. Shaped to divert air, rain and road debris around the rider, a windshield can add hours of riding comfort.*

### TOURING WINDSHIELD TYPES

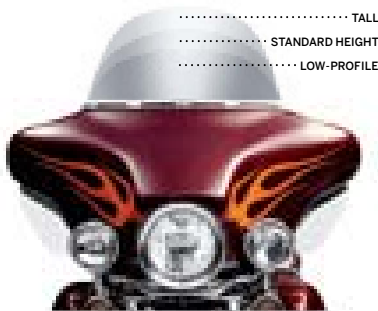

#### FAIRING WINDSHIELD

*Selecting a windshield that tops out just below your line of sight eliminates having to look through bug spots, condensation and road grime. An unobstructed view makes for safe and enjoyable riding.*



#### KING WINDSHIELD

*Maximum protection from the elements. Available in low-profile, standard and tall sizes, the King windshield manages airflow and visibility for almost any size rider. Bugs, wind and rain don't stand a chance.*



#### THE SELECTION GUIDE

*For maximum wind protection, and the best view down the road, select a windshield that tops out just below your line of sight. Your dealer has the tools to make the selection simple.*

### CHANGING YOUR WINDSHIELD

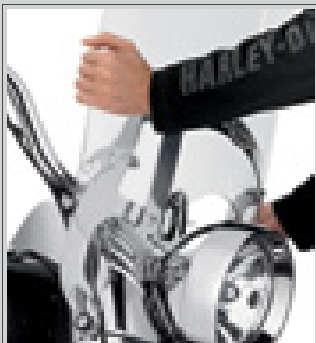

Designed to be installed or removed without tools in seconds, a Detachable Windshield gives you the freedom to define your ride at the drop of a hat. Ride across the country protected from the elements, then quickly remove the windshield to hit the streets in style.







A. ROAD KING 22" KING-SIZE WINDSHIELD – CLEAR

**WINDSHIELDS**

Whether it's for keeping bugs off your face or warmth in your body, a windshield has a huge impact on rider and passenger comfort. By diverting air pressure past your chest and over your helmet, a windshield can add hours of riding comfort. For maximum protection from wind and weather, select a windshield that tops out just below your line of sight. You avoid looking through rain drops, bug spots and road grime to get a clear view of the highway ahead.

**A. ROAD KING® 22" KING-SIZE WINDSHIELD**

Get maximum protection from the wind. This clear Lexan® windshield is 2" taller than the standard-height windshield to improve air-flow for taller riders. The Detachable shield can be removed and re-installed in seconds to tailor your bike to different riding conditions. Windshield dimensions: Overall height 29.0"; overall width 23.1".

**57995-96** 22" Clear. **\$314.95**

Fits '94-later Road King models. Will fit '04-later FLHR models with the additional purchase of Mounting Hardware Kit P/N 58221-04.

**B. ROAD KING 18" KING-SIZE WINDSHIELD**

This Mid-Low Profile Windshield combines the traditional "King" style with a 2" decrease in height. This drops the windshield edge below the line of sight, while maintaining the envelope of clean air around the rider. Complete assembly features a durable Lexan shield and the stainless steel brackets that mount to the Original Equipment docking points for ease of installation and removal. Windshield dimensions: Overall height 25.0"; overall width 23.1".

**58325-06** 18" Clear. **\$334.95**

Fits '94-later Road King models. (Stock on '06-later International FLHR models.) Will fit FLHR models with separate purchase of Mounting Hardware Kit P/N 58221-04.

**C. ROAD KING® 16" KING-SIZE WINDSHIELD**

Give your Road King® model a royal case of attitude by installing a Low-Profile Lightly Smoked Windshield Assembly. Made from durable Lexan® material, this windshield is 4" shorter than stock and features polished stainless steel mounting brackets providing the same ease of installation as the stock Road King Windshield. Dimensions: Overall height 23.0"; overall width 23.1".

Fits '94-later Road King models. Will fit FLHR models with the additional purchase of Mounting Hardware Kit P/N 58221-04.

**57981-97** 16" Lightly Smoked. **\$349.95**

**57767-00** 16" Clear. **\$289.95**



B. ROAD KING 18" KING-SIZE WINDSHIELD – CLEAR



C. ROAD KING 16" KING-SIZE WINDSHIELD – LIGHTLY SMOKED

## 340 TOURING

Windshields – Road King

### A. ROAD KING 14" WIND DEFLECTOR

Maintain the same low-down mini-shield styling of the Road King Smoked Wind Deflector with a little extra wind protection. This 3" taller oversized dark smoked screen features polished stainless steel mounting brackets to provide the same ease of installation as the stock Road King windshield. Windshield dimensions: Overall height 21.0"; overall width 21.4".

**57357-07** 14" Dark Smoked. **\$319.95**  
Fits '94-later Road King models. Will fit FLHRS models with the additional purchase of Mounting Hardware Kit P/N 58221-04. Stock on '07 FLHRSE models.

#### Also available:

### REPLACEMENT 14" WINDSHIELD (not shown)

Customize the wind deflector height on your Custom Vehicle Operations Road King motorcycle to match your riding style, without compromising the low-down look. Kit includes 3" taller dark smoked windshield, cushion cross brace tape, and installation instructions. Requires reuse of Wind Deflector windshield brackets. Windshield dimensions: Overall height 21.0"; overall width 21.4".

**58799-02** 14" Dark Smoked. **\$134.95**  
Fits '02 FLHRSE models, or Road King models equipped with Smoked Wind Deflector P/N 58163-02. Stock on '02 FLHRSE models.

### B. ROAD KING 11" WIND DEFLECTOR

Keep the wind and glare out of your eyes with this Smoked Wind Deflector. This dark smoked Lexan® detachable mini-shield follows the form of a traditional Harley-Davidson® Road King windshield, but its much smaller size adds a touch of low-down attitude. Windshield dimensions: Overall height 18.0"; overall width 19.4".

**58163-02** 11" Dark Smoked. **\$299.95**  
Fits '94-later Road King models. Will fit FLHRS models with the additional purchase of Mounting Hardware Kit P/N 58221-04. Stock on '08 FLHRSE2 models.



A. ROAD KING 14" WIND DEFLECTOR



B. ROAD KING 11" WIND DEFLECTOR

Notice: The prices appearing in this catalog are the manufacturer's suggested retail prices. Actual retail prices may vary.



**C. FLAMED WINDSHIELD FOR ROAD KING MODELS – 20" CLEAR**



**D. REPLACEMENT WINDSHIELD LEXAN**



**E. ROAD KING CUSTOM WINDSHIELD DOCKING HARDWARE KIT (SHOWN WITH LOW-PROFILE WINDSHIELD)**



**F. SKULL WITH WINGS WINDSHIELD TRIM KIT**



**G. CHROME WIND DEFLECTOR**



**H. COTTON WINDSHIELD STORAGE BAG**

### C. FLAMED WINDSHIELD FOR ROAD KING® MODELS

Add a touch of attitude to your cross-country motorcycle. The 3-D look tone-on-tone flames are screenprinted directly on the inside of the clear shield for maximum effect. This Detachable Windshield allows you to dress your bike for the open road, or strip it down for around-town cruising. Windshield dimensions: Overall height 27.0"; overall width 23.1".

**57807-04** 20" Clear. **\$354.95**

Fits '94-later Road King models. Will fit FLHRS models with the additional purchase of Mounting Hardware Kit P/N 58221-04. Cannot be used with windshield bags. Damage may occur to the graphics.

### D. REPLACEMENT WINDSHIELD LEXAN (not shown)

Formed of Lexan® polycarbonate and available in a size that suits your riding needs. Kit includes Lexan screen, cross brace tape and instructions.

Fits '94-later Road King models (except FLHRSEI models).

#### Clear

**57768-00** 16". **\$139.95**

**58433-96** 22". **\$159.95**

#### Lightly Smoked

**58195-94** 16". **\$154.95**

**58135-94** 20". **\$159.95**

**58194-94** 22". **\$164.95**

### E. ROAD KING® CUSTOM WINDSHIELD DOCKING HARDWARE KIT

Kit includes the hardware required to install a Detachable Road King Windshield on the Road King Custom model.

**58221-04** Fits '04-later FLHRS models. **\$29.95**

### F. SKULL WITH WINGS WINDSHIELD TRIM KIT

This Trim Kit replaces the horizontal inner and outer trim strips of your current windshield with a new bar featuring a cast "Skull with Wings" logo. Kit includes inner and outer trim and mounting tape for easy installation.

**58691-04** **\$89.95**

Fits '86-later FLSTC, FLSTF, '06 FLST and '94-later FLHR models equipped with King-Size Windshields.

### G. CHROME WIND DEFLECTOR

Easily attaches to fork brackets for protection from the elements. Accent the full dress look.

**58121-85B** **\$69.95**

Fits '83-later FLHT, FLHS, and FLHR models.

(Does not fit models equipped with fairing lowers or lighted fork slider kit.) Does not fit FLHX models or models equipped with Custom Front Bullet Turn Signal Kits P/N 69577-06 and 69492-05.

### H. COTTON WINDSHIELD STORAGE BAG

This bag is constructed of breathable cotton material and is designed for a scratch-free storage area. The outside of the bag features an embroidered Bar & Shield logo to match the cotton cycle covers.

**95982-98B** **\$69.95**

Fits all Harley-Davidson® windshields.

## 342 TOURING

Windshields – Road Glide

### ROAD GLIDE® WINDSHIELDS

Formed of Lexan® polycarbonate and available in a variety of heights to suit your riding needs.

#### A. ROAD GLIDE® 19" WINDSHIELD – CLEAR

The tall windshield is approximately 3" taller than stock and is hard-coated for durability.

**58283-04B** Fits '04-later Road Glide models. **\$169.95**

#### B. ROAD GLIDE® 10" WINDSHIELD – LIGHTLY SMOKED

This low-profile windshield option is approximately 6" shorter than stock and lightly smoked for a tinted look. The windshield is hard-coated for durability.

**58284-04A** Fits '04-later Road Glide models. **\$149.95**

#### C. ROAD GLIDE 7" CONTOURED WIND DEFLECTOR – LIGHTLY SMOKED

Go low with this lightly smoked Road Glide® model windshield that is contoured for a unique style. Stock on FLTRSE12 models.

**58753-01B** Fits '98-later Road Glide models. **\$139.95**



A. ROAD GLIDE 19" WINDSHIELD – CLEAR (SHOWN WITH ROAD GLIDE WINDSHIELD TRIM)



B. ROAD GLIDE 10" WINDSHIELD – LIGHTLY SMOKED (SHOWN WITH ROAD GLIDE WINDSHIELD TRIM)



C. ROAD GLIDE 7" CONTOURED WIND DEFLECTOR – LIGHTLY SMOKED

Notice: The prices appearing in this catalog are the manufacturer's suggested retail prices. Actual retail prices may vary.



# TOURING 343

Windshields – Road Glide



D

**D. ROAD GLIDE 7" CONTOURED WIND DEFLECTOR – BLACK**



E

**E. ROAD GLIDE 5" WIND DEFLECTOR – BLACK**

**D. ROAD GLIDE® 7" CONTOURED WIND DEFLECTOR – BLACK**

Go low with this Road Glide model windshield that is contoured for a unique style. Stock on FLTRSE3 models.

**57988-09** **\$124.95**

Fits '98-later Road Glide models. Will not fit with Road Glide Windshield Trim P/N 58519-07.

**E. ROAD GLIDE 5" WIND DEFLECTOR – BLACK**

Opaque black Lexan® deflector provides radical styling for the ultimate custom cruiser.

**57957-98** **\$114.95**

Fits '98-later Road Glide models. Will fit with Road Glide Windshield Trim P/N 58519-07.

**F. ROAD GLIDE WINDSHIELD TRIM**

Sweeping chrome-plated trim conceals the base of windshield and hugs the curvature of the fairing. Kit includes chrome mounting hardware and "Road Glide" medallion.

**58519-07A** Fits '04-later Road Glide models. **\$139.95**

**G. FAIRING BRA FOR ROAD GLIDE MODELS**

With a custom fit and an embossed Bar & Shield logo, this fleece-lined vinyl Fairing Bra protects your Road Glide fairing from the elements with a touch of style. Designed for easy installation, this one-piece Fairing Bra helps protect your paint from stone chips and bug residue.

**57846-01** Fits '98-later Road Glide models. **\$99.95**



F

**F. ROAD GLIDE WINDSHIELD TRIM**



G

**G. FAIRING BRA FOR ROAD GLIDE MODELS**

TOURING

*Notice: The prices appearing in this catalog are the manufacturer's suggested retail prices. Actual retail prices may vary.*

# 344 TOURING

Windshields – Electra Glide

## A. FLHT AND FLHX WINDSHIELDS

Tailor your bike to your size and riding style. For the best compromise between adequate protection from the elements and a clear view of the road ahead, select a windshield that tops out just below eye level. This reduces helmet buffeting while allowing a view unobstructed by dirt, bugs, and rain drops. Harley-Davidson windshields are formed of Lexan® polycarbonate for strength and scratch resistance, and are available in a variety of heights and tints to suit your riding needs. NOTE: FLHT and FLHX windshields do not have trim decals.

Fits '96-later Electra Glide®, Street Glide® and Trike models.

<b>58314-97</b>	15" Clear.	<b>\$134.95</b>
<b>58187-96</b>	12" Clear.	<b>\$124.95</b>
<b>58302-96</b>	12" Lightly Smoked.	<b>\$134.95</b>
<b>58301-96</b>	10" Clear.	<b>\$114.95</b>
<b>58303-96</b>	10" Lightly Smoked.	<b>\$124.95</b>

Fits '86-'95 FLHT models. (not shown)

<b>58187-86</b>	12" Clear.	<b>\$139.95</b>
-----------------	------------	-----------------

Fits '83-'85 FLHT models. (not shown)

<b>58181-78</b>	18-1/2" Clear.	<b>\$139.95</b>
-----------------	----------------	-----------------



A. ELECTRA GLIDE 15" WINDSHIELD (SHOWN WITH BAR & SHIELD LOGO WINDSHIELD MOLDING)



A. ELECTRA GLIDE 12" WINDSHIELD (SHOWN WITH BAR & SHIELD LOGO WINDSHIELD MOLDING)



A. ELECTRA GLIDE 10" WINDSHIELD (SHOWN WITH BAR & SHIELD LOGO WINDSHIELD MOLDING)

Notice: The prices appearing in this catalog are the manufacturer's suggested retail prices. Actual retail prices may vary.

# TOURING 345

Windshields – Electra Glide®



**B. ELECTRA GLIDE 7" DARK SMOKED WIND DEFLECTOR**



**C. ELECTRA GLIDE 4" DARK SMOKED WIND DEFLECTOR (SHOWN WITH BAR & SHIELD LOGO WINDSHIELD MOLDING)**



**D. ELECTRA GLIDE 4" BLACK WIND DEFLECTOR (SHOWN WITH CHROME WINDSHIELD MOLDING)**



**E. FLT WINDSHIELDS – CLEAR**



**F. FAIRING BRA FOR ELECTRA GLIDE MODELS**

**B. ELECTRA GLIDE® 7" DARK SMOKED WIND DEFLECTOR**  
Style meets function. This 6-1/2" tall Lexan® Wind Deflector splits the difference between the wind deflector and a low windshield, offering sport styling with a little greater wind protection.

**57185-05** **\$119.95**

Fits '96-later Electra Glide®, Street Glide® and Trike models.  
Stock on '05 FLHTCSE models.

**C. ELECTRA GLIDE 4" DARK SMOKED WIND DEFLECTOR**  
Maintain your forward view with this low-profile wind deflector. The 4" tall Lexan shield shares the radical shape of the Black Wind Deflector P/N 58204-98, and the dark smoked tint complements any paint color.

**58207-04** **\$114.95**

Fits '96-later Electra Glide, Street Glide and Trike models.  
Stock on '04 FLHTCSE models.

**D. ELECTRA GLIDE® 4" BLACK WIND DEFLECTOR**  
Opaque black 4" tall Lexan deflector provides radical styling for the ultimate custom cruiser.

**58204-98** **\$114.95**

Fits '96-later Electra Glide, Street Glide and Trike models.

**E. FLT WINDSHIELDS – CLEAR**

**58016-89A** Standard 19" height. **\$184.95**

Fits '84-'96 FLT models.

**F. FAIRING BRA FOR ELECTRA GLIDE® MODELS**

Offering a custom look and protection for your fairing from the elements, this Fairing Bra is made with non-abrasive, fleece-backed vinyl material and features a Bar & Shield logo. It is designed for easy installation and a custom fit. Requires separate purchase of Chrome Windshield Molding P/N 59213-96.

**57800-00** **\$89.95**

Fits '96-later Electra Glide, Street Glide and Trike models.

# 346 TOURING

Windshields – Electra Glide®

## A. ILLUMINATED FAIRING ACCENT TRIM

Sweeping chrome trim dresses the Electra Glide fairing for a distinctive, yet functional look. Smoked lenses hide amber LED lamps that glow as running lamps when the ignition is on, and function as auxiliary directional indicators when the turn signals are activated. Fairing Accent Trim looks great by itself, and is styled to complement the available Illuminated Windshield Trim and Illuminated Mirrors. The wiring is concealed inside the fairing for a clean, custom appearance. Complete kit includes all necessary installation hardware. Trim may cover pinstripes or two-tone paint lines on some vehicles. Check appearance prior to installation.

**69290-09** **\$199.95**  
Fits '97-later Electra Glide®, Street Glide® and Trike models.

### Shown with:

#### ILLUMINATED LED WINDSHIELD MOLDING KIT

Smoked lenses hide bands of four amber LED lamps that glow as running lamps when the ignition is on, and the two outer clusters function as auxiliary directional indicators when the turn signals are activated. The wiring is concealed inside the fairing for a clean, custom appearance. Complete kit includes all necessary mounting hardware.

**57335-08** **\$189.95**  
Fits '97-later Electra Glide®, Street Glide™ and Trike models.

## B. BAR & SHIELD LOGO WINDSHIELD MOLDING

This highly polished stainless steel windshield trim is accented by four slots that allow the color of the outer fairing to show through. This unique trim piece is highlighted with two Bar & Shield logos machined into the surface. Kit includes stainless steel mounting hardware.

**59133-99** **\$79.95**  
Fits '96-later Electra Glide®, Street Glide and Trike models.

## C. CHROME WINDSHIELD MOLDING FOR ELECTRA GLIDE® MODELS

Chrome Windshield Molding accents the outer fairing on Electra Glide® models. Easily installed, including all necessary hardware and instructions.

**59213-96** **\$41.95**  
Fits '96-later Electra Glide, Street Glide and Trike models.



A. ILLUMINATED FAIRING ACCENT TRIM (SHOWN WITH LED WINDSHIELD MOLDING)

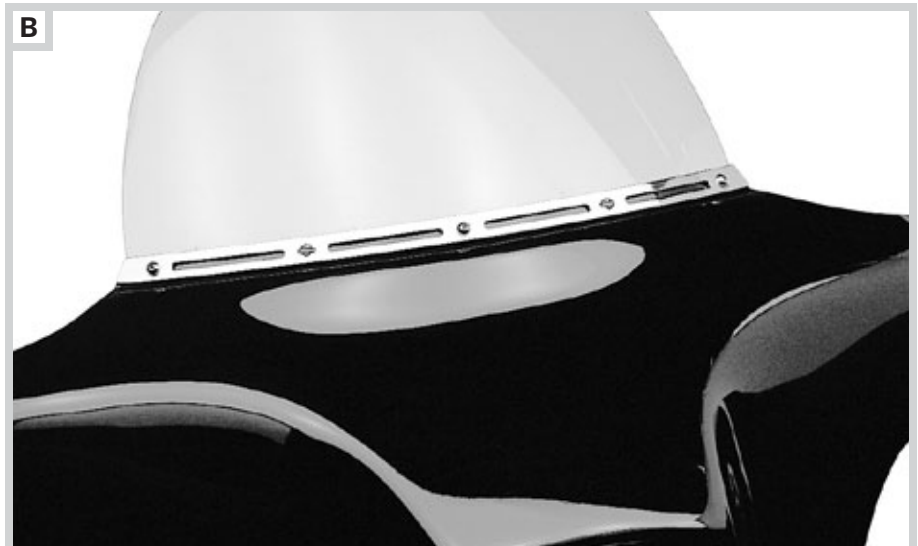

B. BAR & SHIELD LOGO WINDSHIELD MOLDING



C. CHROME WINDSHIELD MOLDING FOR ELECTRA GLIDE MODELS

Notice: The prices appearing in this catalog are the manufacturer's suggested retail prices. Actual retail prices may vary.



# TOURING 347

Windshields – Electra Glide®



NEW

D

D. ILLUMINATED CHROME MIRROR COVER



NEW

E

E. CHROME FAIRING MOUNT MIRROR COVERS

## D. ILLUMINATED CHROME MIRROR COVERS

Add auxiliary LED turn signals and a splash of chrome to the inner fairing. The perfect finishing touch to a fully dressed inner fairing, these chrome-plated mirror housings feature fast-acting amber LED turn signals at the outer edge. Side turn signals attract attention from the drivers around you, and the plug-in, no splice design simplifies installation.

**92600-10** **\$129.95**

Fits '06-later FLHX, FLHXSE and FLHXXX models, and other Electra Glide® models equipped with Fairing Mount Mirrors P/N 91945-98B.

## E. CHROME FAIRING MOUNT MIRROR COVERS

Add a splash of chrome to the inner fairing. The chrome-plated housings wrap around the back and side of the fairing mount mirrors, presenting a clean, uncluttered profile. The perfect finishing touch to a fully dressed inner fairing.

**91924-09** **\$69.95**

Fits '06-later FLHX, FLHXSE and FLHXXX models, and other Electra Glide models equipped with Fairing Mount Mirrors P/N 91945-98B.

## F. LEATHER THREE-POCKET FAIRING POUCH

Add convenient extra storage space to the inside of your fairing with this Leather Fairing Pouch, featuring three easily accessible, individual storage pockets with embossed "Harley-Davidson" logo on top of center pouch.

**58900-98B** **\$109.95**

Fits '96-later Electra Glide® and FLHTCUTG models.

Does not fit FLHX models or with Wind Deflectors P/N 57185-05, 58207-04 or 58204-98. Does not fit with Fairing Mounted GPS Navigation Systems.

## G. TWO-POCKET FAIRING POUCH

Convenient storage space right at your fingertips. Sized to fit with low-profile windshields and wind deflectors, this Two-Pocket Fairing Pouch is ideal for storing cell phones and sunglasses while you are on the road. Hook-and-loop closures keep the embossed leather flaps securely closed. Easy to install.

**58928-08** **\$99.95**

Fits '98-later Electra Glide, Street Glide® and Trike models. Does not fit with Fairing Mounted GPS Navigation Systems.

## H. ELECTRA GLIDE® LEATHER FAIRING POUCH

Easily installed inner fairing pouch is designed to hold sunglasses, cigarettes, etc. All-leather construction around a molded ABS plastic base for shape retention. Has an easy-to-use full-length hook-and-loop closure and features a black embroidered Bar & Shield logo on the lid.

**58248-96** **\$79.95**

Fits '96-later Electra Glide and FLHTCUTG models.

Does not fit FLHX models or with Wind Deflectors P/N 58207-04 or 58204-98. Does not fit with Fairing Mounted GPS Navigation Systems.



F

F. LEATHER THREE-POCKET FAIRING POUCH

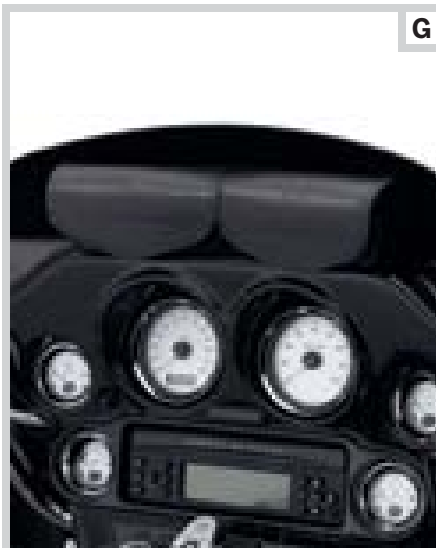

G

G. TWO-POCKET FAIRING POUCH



H

H. ELECTRA GLIDE LEATHER FAIRING POUCH

TOURING

Notice: The prices appearing in this catalog are the manufacturer's suggested retail prices. Actual retail prices may vary.

# 348 TOURING

## Fairing Lower

### A. COLOR-MATCHED VENTED FAIRING LOWER KIT\*

Control the air-flow to your lower legs for maximum riding comfort. These Color-Matched Fairing Lower feature a venting system that allows you to adjust the amount of air that circulates across the engine. On hot days, open the vent to direct additional cooling air and on cold or rainy days, close the vents for maximum protection from the elements. The ratcheting friction lock pivot allows you to easily set the position. The complete kit includes left and right Fairing Lower, convenient glove box and lid, and all necessary mounting hardware. Glove Box Doors are sold separately. NOTE: Fairing Lower Kits are painted in a single color and do not feature pinstriping.

Fits '83-later Touring and Trike models (except '98-'09 FLTR). Stock on FLHTCU, FLHTK and FLHTCUTG. '10 FLHXSE and FLHXXX models require the installation of Engine Guard P/N 49184-09 or 49050-09. Will not fit with Mustache Engine Guards.

### B. DETACHABLE FAIRING LOWER HARDWARE KIT

Beat the summer heat and prepare for around-town cruising by removing the fairing lowers on your Ultra Classic® Electra Glide® model. This kit includes highly polished stainless steel clamps that are detachable without the need for tools.

**58146-07** **\$99.95**

Fits '05-later Touring and Trike models equipped with Vented Fairing Lower and '88-later Touring and Trike models equipped with Vented Fairing Lower Kit 58854-YYXXX.

### C. SOFT STORAGE BAG FOR FAIRING LOWER

Protect your fairing lowers when they are removed for hot weather riding. This convenient storage bag features a heavy-weight 10 oz. cotton exterior and sturdy carrying handle. Dual zippers open to expose a soft felt interior with a sturdy divider for left and right lowers, and two zippered pouches for loose hardware storage. A classic embroidered Bar & Shield logo adorns the bag's exterior.

**95983-07** **\$79.95**

Fits all styles of Harley-Davidson Fairing Lower.



A. COLOR-MATCHED VENTED FAIRING LOWER KIT



B. DETACHABLE FAIRING LOWER HARDWARE KIT



C. SOFT STORAGE BAG FOR FAIRING LOWER

\*NOTE: This product is a "Paint to Order" accessory. Please allow for an average of 5 weeks delivery for this item.

Notice: The prices appearing in this catalog are the manufacturer's suggested retail prices. Actual retail prices may vary.



ROAD KING SHOWN WITH COLOR-MATCHED  
VENTED FAIRING LOWERES.

#### A. Color-Matched Vented Fairing Loweres

##### Color

Primed	58854-05	\$449.95
Aztec Orange Pearl	58854-05NV	\$649.95
Big Purple Flake	58854-09CWR	\$649.95
Birch White	58854-05AV	\$649.95
Black Cherry	58854-05BPS	\$649.95
Black Denim	58854-09BYM	\$649.95
Black Ice	58854-09CWL	\$649.95
Black Pearl	58854-05BPY	\$649.95
Brandy Wine Sunglo	58854-06BYF	\$649.95
Brilliant Silver	58854-05BHT	\$649.95
Bronze Pearl	58854-05QC	\$649.95
Candy Concord	58854-10DEH	\$824.95
Chopper Blue	58854-05BPO	\$649.95
Cobalt Blue	58854-05ZA	\$649.95
Concord Purple	58854-05QH	\$649.95
Copper Pearl	58854-08CPH	\$649.95
Crimson Red Denim	58854-08CPD	\$649.95
Crimson Red Sunglo	58854-08COZ	\$649.95
Dark Blue Denim	58854-08CPG	\$649.95
Dark Blue Pearl	58854-08CPC	\$649.95
Deep Cobalt	58854-06BXT	\$649.95
Deep Turquoise	58854-09CWN	\$649.95
Fire Fighter Red	58854-05BRK	\$649.95
Fire Red Pearl	58854-06BXY	\$649.95
Flame Blue Pearl	58854-09CWA	\$649.95
Glacier White Pearl	58854-05BHX	\$649.95
Gunmetal Pearl	58854-05BDT	\$649.95
Lava Red Sunglo	58854-05BJK	\$649.95
Light Candy Root Beer	58854-09CWT	\$649.95

Luxury Blue	58854-05XE	\$649.95
Luxury Rich Red	58854-05ZQ	\$649.95
Luxury Teal	58854-05BHV	\$649.95
Merlot Sunglo	58854-10DCE	\$649.95
Olive Pearl	58854-07CGV	\$649.95
Pacific Blue Denim	58854-07CHG	\$649.95
Pacific Blue Pearl	58854-07CGP	\$649.95
Peace Officer Blue	58854-05TQ	\$649.95
Pewter Denim	58854-07CHH	\$649.95
Pewter Pearl	58854-07CGR	\$649.95
Real Red	58854-05BBN	\$649.95
Red Hot Denim	58854-09CYE	\$649.95
Red Hot Sunglo	58854-09CYS	\$649.95
Rich Sunglo Blue	58854-05BPV	\$649.95
Scarlet Red	58854-10DBJ	\$649.95
Scarlet Red	58854-05LZ	\$649.95
Sierra Red	58854-05BHS	\$649.95
Sinister Blue Pearl	58854-05NR	\$649.95
Smokey Gold	58854-05BJL	\$649.95
Spiced Rum	58854-10DEK	\$824.95
Sterling Silver	58854-05BDP	\$649.95
Suede Blue Pearl	58854-07CGT	\$649.95
Suede Green Pearl	58854-05KB	\$649.95
Tequila Sunrise	58854-10DEM	\$824.95
Vivid Black	58854-05DH	\$649.95
White Pearl	58854-05ZB	\$649.95
White Gold Pearl	58854-07CGS	\$649.95
White Ice Pearl	58854-10DBV	\$649.95
Yellow Pearl	58854-05BPZ	\$649.95



# 350 TOURING

## Fairing Lower

### A. COLOR-MATCHED ROAD GLIDE® NON-VENTED FAIRING LOWER KIT\*

The unique lines of the Road Glide models are accentuated with these fairing lowers. Available with Color-Matched factory paint or in primed finish, ready to apply your own custom design. Glove Boxes are sold separately. NOTE: All fairing lower kits are painted with a single color scheme and do not include pinstripes. FLTR and FLTRI models equipped with Stainless Steel Braided Clutch Cable P/N 38660-00A require separate purchase of Service Kit P/N 38674-01.

Fits '04-'09 FLTR/I models.

<b>58861-04BDK</b>	Primed.	<b>\$449.95</b>
<b>58861-05BPS</b>	Black Cherry.	<b>\$624.95</b>
<b>58861-05BPY</b>	Black Pearl.	<b>\$624.95</b>
<b>58861-08CPF</b>	Candy Red Sunglo.	<b>\$624.95</b>
<b>58861-09BYZ</b>	Charcoal Slate.	<b>\$824.95</b>
<b>58861-05BPO</b>	Chopper Blue.	<b>\$624.95</b>
<b>58861-08CPH</b>	Copper Pearl.	<b>\$624.95</b>
<b>58861-08CPD</b>	Crimson Red Denim.	<b>\$624.95</b>
<b>58861-08COZ</b>	Crimson Red Sunglo.	<b>\$624.95</b>
<b>58861-08CPC</b>	Dark Blue Pearl.	<b>\$624.95</b>
<b>58861-06BXT</b>	Deep Cobalt.	<b>\$624.95</b>
<b>58861-06BXY</b>	Fire Red Pearl.	<b>\$624.95</b>
<b>58861-04BBP</b>	Impact Blue.	<b>\$624.95</b>
<b>58861-04BHV</b>	<del>Luxury Teal.</del> <b>OBSOLETE</b>	<b>\$624.95</b>
<b>58861-07BNR</b>	Mirage Orange Pearl.	<b>\$624.95</b>
<b>58861-07CGP</b>	Pacific Blue Pearl.	<b>\$624.95</b>
<b>58861-07CGR</b>	Pewter Pearl.	<b>\$624.95</b>
<b>58861-09CYE</b>	Red Hot Denim.	<b>\$624.95</b>
<b>58861-09CYS</b>	Red Hot Sunglo.	<b>\$624.95</b>
<b>58861-04BHS</b>	Sierra Red.	<b>\$624.95</b>
<b>58861-04BJL</b>	Smokey Gold.	<b>\$624.95</b>
<b>58861-09DAK</b>	Titanium Dust.	<b>\$824.95</b>
<b>58861-04DHD</b>	Vivid Black.	<b>\$624.95</b>
<b>58861-05BPZ</b>	Yellow Pearl.	<b>\$624.95</b>

Fits '98-'03 FLTR/I models.

<b>58841-98</b>	Primed.	<b>\$449.95</b>
<b>58841-98DH</b>	Vivid Black.	<b>\$624.95</b>

### B. NON-VENTED FAIRING LOWER\*

Made from tough, lightweight vacuum-formed ABS, these fairing lowers protect the rider from the elements and direct cooling air to the engine. Lower attaches to the engine guard without interfering with rider footboards. Kit includes all necessary mounting hardware. Glove Boxes are sold separately. NOTE: All fairing lower kits are painted with a single color scheme and do not include pinstripes.

Fits '83-later FLHT (except FLHTCUTG), FLHTC, FLHX and FLHR models. (Does not fit with Mustache Engine Guard P/N 49155-05 and Front Bullet Turn Signal Kit P/Ns 69492-05 and 69493-05.) (NOTE: Requires drilling a hole in the left side fairing lower for the engine guard filler valve on '84-'87 models.)

<b>58830-88</b>	Primed.	<b>\$429.55</b>
<b>58830-88DH</b>	Vivid Black.	<b>\$624.95</b>



A. COLOR-MATCHED ROAD GLIDE NON-VENTED FAIRING LOWER KIT



B. NON-VENTED FAIRING LOWER

\*NOTE: This product is a "Paint to Order" accessory. Please allow for an average of 5 weeks delivery for this item.

Notice: The prices appearing in this catalog are the manufacturer's suggested retail prices. Actual retail prices may vary.





C. FAIRING LOWER LOCKING GLOVE BOX DOORS SET

**C. FAIRING LOWER LOCKING GLOVE BOX DOORS SET**

Keyed-to-match security. Add secured storage to your fairing lowers. This locking Glove Box Door Kit replaces the Original Equipment flexible snap-on covers, and provides convenient, weather resistant storage for documents, cell phones, and sunglasses. The kits are "keyed to match" to your motorcycle ignition, for barrel style keys, for "one key" convenience. This locking door kit is an ideal companion to the Fitted Glove Box Liner Kit, P/N 58714-06. Kit includes left and right locking door assemblies and door frames.

**57411-08** **\$195.95**

Fits '91-later Touring and Trike models equipped with Electra Glide Ultra style fairing lowers, vented and non vented. Does not fit with Glove Box Door Pouch P/N 57400-06.

**D. GLOVE BOX DOOR POUCHES**

Pouches fit perfectly on your glove box doors to provide convenient storage of small items at your fingertips. Made of a ballistic nylon exterior and a soft, fuzzy interior with elastic sides for expandability. Perfect for your cell phone, digital media player, toll-way pass or any other small items. Reinforced cover features an embroidered Bar & Shield logo. Kit includes left and right pouches.

**57400-06** **\$29.95**

Fits Touring and Trike models equipped with vented fairing lowers. Does not fit with Locking Glove Box Door P/N 57411-08.



D. GLOVE BOX DOOR POUCHES



E. FLT AND FLHT FAIRING LOWER GLOVE BOXES - ULTRA CLASSIC STYLING

**E. FLT AND FLHT FAIRING LOWER GLOVE BOXES**

Offers a convenient place to store riding gloves, sunglasses, etc. The snap-on door cover (included) is embossed with Bar & Shield logo. Available in black only.

**Ultra Classic Styling**

**58683-89B** Left Side. **\$105.00**

Fits '04-earlier Original Equipment non-vented style FLHT Ultra Classic® Fairing Lower.

**58684-89B** Right Side. **\$105.00**

Fits '04-earlier Original Equipment non-vented style FLHT Ultra Classic Fairing Lower.

**58687-89** Left Side. **\$160.00**

Fits non-vented style FLT and FLTR Fairing Lower.

**58688-89A** Right Side. **\$160.00**

Fits non-vented style FLT and FLTR Fairing Lower.

**F. PROTECTIVE SOFT LOWERS**

Constructed of reinforced vinyl with polyester backing and black snaps. Install on engine guard for protection against the elements. Easy installation and removal. Should not be used when air temperature is above 50 degrees.

**58502-80C** **\$49.95**

Fits '80-later Touring models equipped with Engine Guards. Does not fit with Mustache Engine Guards.

**G. BAR & SHIELD LOGO SOFT LOWERS**

Sturdy front engine guard soft lowers feature a durable quick-release latch for attachment and convenience. Should not be used when air temperature is above 50 degrees.

**58525-95A** **\$59.95**

Fits '80-'83 and '88-later FLHT, FLHX and FLHR models equipped with engine guards. Does not fit with Mustache Engine Guards.



F. PROTECTIVE SOFT LOWERS



G. BAR &amp; SHIELD LOGO SOFT LOWERS

# 352 TOURING

## Wind Deflectors

### A. ADJUSTABLE AIR DEFLECTORS

The Adjustable Air Deflectors feature an infinitely adjustable friction pivot that holds the wing in position to direct the air where you need it. Close the vent to direct airflow around the fairing, or open the vent to maximize airflow on hot days. Available in dark- or light-smoked versions, the translucent deflectors are easy to install with the included mounting hardware.

Fits '08-later Electra Glide®, Street Glide® and Trike models.

<b>58156-08</b>	Dark Smoked.	<b>\$109.95</b>
<b>58166-08</b>	Lightly Smoked.	<b>\$109.95</b>

### B. ADJUSTABLE AIR DEFLECTOR KIT

Help keep your cool on hot summer rides. The smoked Adjustable Air Deflectors feature a spring-loaded detent system that locks in four different positions. Close the vent to direct airflow around the fairing, or open the vent to maximize airflow on hot days. Easy-to-install, the complete kit includes left and right deflector and all necessary mounting hardware.

**57804-07** **\$109.95**

Fits '96-later Electra Glide®, Street Glide® and Trike models.

### C. BLACK FAIRING AIR DEFLECTORS

Opaque black material to complement the opaque black Wind Deflector P/N 58204-98. This item deflects air away from elbows and upper torso. Reduces draft behind fairing.

**58568-98A** **\$39.95**

Fits '96-later Electra Glide, Street Glide and Trike models.

### D. DARK SMOKED FAIRING AIR DEFLECTORS

Dark smoked material to complement the dark smoked Wind Deflector P/N 57185-05 or 58207-04. Designed to deflect air away from the rider's elbows and upper torso. These easy-to-install Air Deflectors reduce the draft behind the fairing.

**57740-05** **\$39.95**

Fits '96-later Electra Glide, Street Glide and Trike models.

### E. SMOKED FAIRING AIR DEFLECTORS

Slightly tinted. Deflects air away from elbows and upper torso. Reduces draft behind fairing. Stock on FLHTCUI models.

**58120-96A** **\$29.95**

Fits '96-later Electra Glide®, Street Glide and Trike models.

### F. MID-FRAME AIR DEFLECTOR

Designed for severe duty and extreme temperature applications. These black deflectors attach to the frame below the seat, and direct heat away from the rider to improve comfort.

**58002-09** **\$74.95**

Fits '09-later Touring and Trike models. Original Equipment on FLHTCU, FLHTCUTG and FLHTK models.

**58022-07A** **\$74.95**

Fits '01-'08 Touring models. Does not fit '01-'07 models equipped with Adjustable Rider Backrests.



**A. ADJUSTABLE AIR DEFLECTORS – WINGS OPEN**

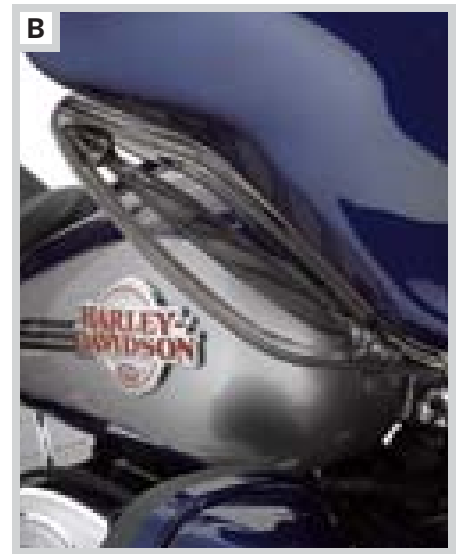

**B. ADJUSTABLE AIR DEFLECTOR KIT – OPEN**



**C. BLACK FAIRING AIR DEFLECTOR**



**D. DARK SMOKED FAIRING AIR DEFLECTOR**



**E. SMOKED FAIRING AIR DEFLECTOR**



**F. MID-FRAME AIR DEFLECTOR**

*Notice: The prices appearing in this catalog are the manufacturer's suggested retail prices. Actual retail prices may vary.*

## SEAT OF POWER.

*The right seat is equal parts ergonomics and comfort. Its shape anchors your position and determines the reach to the ground and to the controls; and the padding supports your tailbone and hips to relieve stress and pressure. Pick the right one for you...and your passenger.*

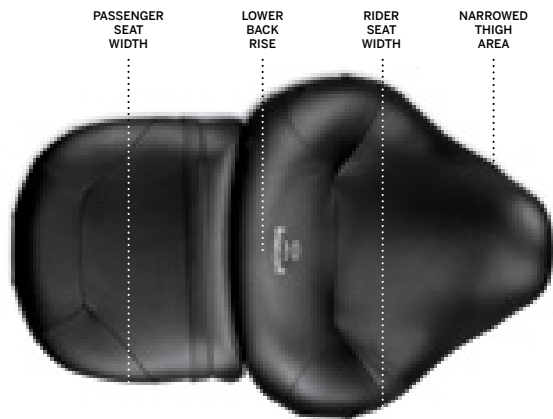

### COMFORT ZONE

A seat is more than just leather and foam. For maximum highway comfort, a broad seating surface distributes weight to reduce pressure points. For a short rider, a narrow, tapered thigh zone provides easier reach to the ground. And a stepped seat profile keeps the rider from sliding back during acceleration.

### TOURING SEAT TYPES

Solo or two-up, comfort or style, check out these seats to get an idea of where you want to sit.



#### CUSTOM PROFILE SEATS

*These saddles combine radical styling with a “deep in the bike” riding position. Long and lean, Badlander®, Brawler®, Sidekick® and Rallyrunner® seats bring you lower to the ground than most other seats.*



#### POSITION SEATS

*Designed to place the rider in the best relationship to the controls, Low-Profile®, Reach® and Tallboy® seats position short and tall riders for a comfortable extension of the arms and legs.*



#### TOURING SEATS

*Designed for comfort, Sundowner™, Signature Series™ and Road Zeppelin® seats offer a broad seating surface to reduce pressure points and a dish shape holds you in place and provides additional back support.*

### CHANGING YOUR SEAT



Switching out your seat is simple. And because certain rides call for certain styles, some folks like to have multiple seats to match the occasion. Install a comfortable, supportive touring seat for the longer treks, and swap it out for a low-profile seat for a night on the town. Please see your owner's manual for proper removal and installation of seats.

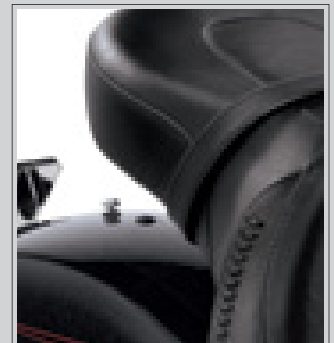

# 354 TOURING

## Seating

### A. BRAWLER® SEAT

When it's time to go it alone, go solo in style. These premium quality cowhide leather saddles are designed to create a subtle and distinctive look. Top-grain leather seating surface and contoured foam padding add long-haul comfort, and the durable hand-laid fiberglass seat pan is carpeted to protect the paint finish. Does not fit with passenger pillions.

**51525-09 \$299.95**

Fits '08-later Touring models (except Trike). Does not fit models equipped with Passenger Grab Rails. Does not accept Rider Backrest. Seat width 13.0".

**53373-02A \$299.95**

Fits '97-'07 Road King® and FLHX models. Does not fit with rider backrest. Seat width 13.0".

### B. SIDEKICK® SEAT

Share your custom ride. The two-up design of these premium cowhide leather seats offers a frame-hugging look, but adds back support for the rider, and additional padding for the passenger. The custom seating surface and the hand-laid fiberglass seat base show attention to detail second to none.

**51526-09 \$369.95**

Fits '08-later Touring models (except Trike). Does not fit models equipped with Passenger Grab Rails. Does not accept Rider Backrest. Seat width 13.5"; passenger pillion width 6.5".

**51444-04A \$369.95**

Fits '97-'07 Road King and FLHX models. Does not fit with rider backrest. Seat width 13.5"; passenger pillion width 6.5".

NOTE: Some Harley-Davidson® seats are made of leather. Fine leathers or other natural materials WILL gain "character," such as wrinkles or wear, with age. This is normal. A fine, aged patina and character wrinkles are a sign of the extremely high quality materials used to construct your seat or backrest. The appearance of scars or marks on the leather are a result of using natural leather panels and should not be thought of as an imperfection. Please use Harley-Davidson Leather Dressing P/N 98261-91V to protect your investment.

Notice: The prices appearing in this catalog are the manufacturer's suggested retail prices. Actual retail prices may vary.

THE CUSTOM SEAT PROGRAM  
ALLOWS YOU TO SELECT THE  
STITCH PATTERNS, LEATHER  
INLAYS AND THREAD COLORS  
TO COMPLEMENT FACTORY OR  
CUSTOM PAINT.

See pages 706-709 for more information.



A. BRAWLER SEAT – '08-LATER TOURING SHOWN



B. SIDEKICK SEAT – '08-LATER TOURING SHOWN







C. RALLYRUNNER SEAT – '08-LATER TOURING SHOWN

**C. RALLYRUNNER® SEAT**

The Rallyrunner Seat features thicker padding for the rider, and a wider passenger pillion for the passenger. The premium cowhide leather seating surface has a rich, luxurious feel, and the carpeted hand-laid fiberglass seat base hugs the fender for a custom look. The foam padding will form to the rider's shape, and provide hours of riding comfort.

**51527-09** **\$369.95**

Fits '08-later Touring models (except Trike). Does not fit models equipped with Passenger Grab Rails. Does not accept Rider Backrest. Seat width 13.5"; passenger pillion width 10.0".

**D. BADLANDER® SEAT**

Once again, bad is good. The popular Badlander Custom Seat is available for your Touring model. Designed to fit your bike like a glove, this seat delivers low-slung cruiser style from rear fender to the tank console. Low and lean, the clean, smooth cover and the embroidered "Harley-Davidson" logo add up to a radical look. Does not accept a rider backrest.

**52067-08** **\$199.95**

Fits '08-later Touring models (except Trike). Seat width 13.0"; passenger pillion width 6.0".

**52066-97C** **\$199.95**

Fits '97-'07 Road King® (except FLHRS) and FLHX models. Also fits '97-'07 Electra Glide® and Road Glide® models equipped with Fuel Tank Console P/N 71288-03A or Trim Piece P/N 52447-96. Seat width 12.25"; passenger pillion width 4.5".

**52265-01A** **\$199.95**

Fits '97-'07 Electra Glide (except FLHX) and Road Glide models. Seat width 12.5"; passenger pillion width 4.5".

**E. LEATHER LOW-PROFILE BUCKET SEAT**

A custom-look low and slammed seat, with a bucket contour for added support. Features embroidered logo and an opening that receives a matching Rider Backrest.

**52095-08** **\$299.95**

Fits '08-later Touring and Trike models. Seat width 15.0"; passenger pillion width 8.5".

**52918-98B** **\$299.95**

Fits '97-'07 Road King® (except FLHRS) and FLHX models. Also fits '97-'07 Electra Glide® and Road Glide® models equipped with Fuel Tank Console P/N 71288-03A or Trim Piece P/N 52447-96. Seat width 15.7"; passenger pillion width 6.5".



D. BADLANDER SEAT – '08-LATER TOURING SHOWN



E. LEATHER LOW-PROFILE BUCKET SEAT – '08-LATER TOURING SHOWN

NOTE: Some Harley-Davidson® seats are made of leather. Fine leathers or other natural materials WILL gain "character," such as wrinkles or wear, with age. This is normal. A fine, aged patina and character wrinkles are a sign of the extremely high quality materials used to construct your seat or backrest. The appearance of scars or marks on the leather are a result of using natural leather panels and should not be thought of as an imperfection. Please use Harley-Davidson Leather Dressing P/N 98261-91V to protect your investment.

Notice: The prices appearing in this catalog are the manufacturer's suggested retail prices. Actual retail prices may vary.

# 356 TOURING

## Seating

### A. REACH® SEAT

Reach® forward position seats are designed to move riders with shorter inseam closer to the controls and to bring the legs about 1" closer together so that feet rest firmly on the pavement. The scooped bucket-shape saddle is enhanced with added back support padding to move the rider approximately 1/2" lower and 1/2" forward. The combination positions the rider closer to the hand and foot controls to offer both comfort and confidence. Seat can be equipped with optional rider backrest for added support and comfort.

**52619-08A** **\$299.95**

Fits '08-later Touring and Trike models. Seat width 15.0"; passenger pillion width 13.0".

### B. REACH SEAT FOR '97-'07 MODELS

Reach forward position seats are designed to move riders with shorter inseams closer to the controls and to bring the legs closer together so that feet rest firmly on the pavement. The scooped bucket-shape saddle is enhanced with added back support padding to move the rider approximately 1.5" lower and 1.5" forward. The combination positions the rider closer to the hand and foot controls to offer both comfort and confidence. Combine with Reduced Reach Handlebar for the complete effect. Can also be used with Rider Backrest kits.

**52544-05A** **\$299.95**

Fits '97-'07 Electra Glide (except FLHX) and '98-'07 Road Glide models. Seat width 16.0"; passenger pillion width 13.0".

**52609-05** **\$299.95**

Fits '97-'07 Road King® (except FLHRS) and FLHX models. Also fits '97-'07 FLHT and FLTR models equipped with Fuel Tank Console P/N 71288-03A or Trim Piece P/N 52447-96. Seat width 16.0"; passenger pillion width 13.0".



A. REACH SEAT – '08-LATER TOURING



B. REACH SEAT – '97-'07 ELECTRA GLIDE AND ROAD GLIDE



B. REACH TOURING SEAT – '97-'07 ROAD KING AND STREET GLIDE

Notice: The prices appearing in this catalog are the manufacturer's suggested retail prices. Actual retail prices may vary.



C. TALLBOY SEAT – '08-LATER TOURING SHOWN

**C. TALLBOY® SEAT**

The new Tallboy Seat moves the rider back 2" to provide much needed arm and leg room for the long-limbed rider. The seat height is similar to stock, and the slight bucket shape offers additional lower back support. Passenger comfort will be maximized with the Tour-Pak® Luggage mounted in the rear-most position. Accepts rider backrest (except Adjustable Style) for additional touring comfort.

**52099-09A****\$299.95**

Fits '08-later Touring and Trike models. Does not fit models equipped with Passenger Grab Rails. Seat width 16.0"; passenger pillion width 14.0".

**D. TALLBOY SEAT FOR '97-'07 MODELS**

Stretch your legs in style. The Tallboy one-piece seat moves the rider back 1/2" and up 1-1/4" compared to the Original Equipment seat. The new position allows additional leg and arm movement for the long-limbed rider, and a comfortable seating space for the open road. The bucket design of the Tallboy Seat provides additional rider back support, and the wide raised pillion places the passenger for maximum comfort and commanding view. Can also be used with Rider Backrest Kits.

**52975-05****\$299.95**

Fits '97-'07 Electra Glide® (except FLHX) and Road Glide models. Seat width 17.5"; passenger pillion width 15.0".

**52976-05****\$299.95**

Fits '97-'07 Road King® and FLHX models. Also fits '97-'07 Electra Glide® and Road Glide® models equipped with Fuel Tank Console P/N 71288-03A or Trim Piece P/N 52447-96. Seat width 17.0"; passenger pillion width 16.0".

**E. PILLOW-LOOK SEAT**

Get the style and comfort of a pillow-look seat with a design and fitment made exclusively for Touring models. This seat offers a wide rider and passenger area for comfort over the long haul. Accepts rider backrest for additional touring comfort.

**51729-09A****\$299.95**

Fits '08-later Touring and Trike models. Seat width 15.0"; passenger pillion width 15.0".

**51102-01A****\$299.95**

Fits '97-'07 Road King® and FLHX models. Also fits '97-'07 Electra Glide® and Road Glide® models equipped with Fuel Tank Console P/N 71288-03A or Trim Piece P/N 52447-96. Seat width 17.0"; passenger pillion width 16.0".

**51704-05****\$299.95**

Fits '97-'07 Electra Glide (except FLHX) and Road Glide models. Seat width 17.0"; passenger pillion width 16.0".



D. TALLBOY SEAT – '97-'07 ELECTRA GLIDE AND ROAD GLIDE SHOWN



E. PILLOW-LOOK SEAT – '08-LATER TOURING SHOWN

# 358 TOURING

Seating

## A. HARLEY® HAMMOCK™ TOURING SEAT

Protect your backside from harsh road conditions. With its revolutionary fabric suspension system, the Harley Hammock Touring Seat offers increased rider isolation from sharp road impacts. The sling-like fabric suspension system that is integrated into the seat pan is manufactured from a unique blend of fibers that offer flexibility and durability. The fabric acts like a hammock, providing 2 inches of suspension above the seat pan, with an additional 2 inches of traditional foam on top. This internal suspension prevents "bottoming out" and provides a 30% improvement in comfort and endurance over the long haul by sheltering the rider from harsh road conditions. The vinyl surface is easy to clean and maintain, and is finished with a "Harley-Davidson" raised script logo. Can be equipped with Rider Backrest (sold separately) on most models. Seat width 17.5"; passenger pillion width 15.0".

**53051-09** **\$499.95**

Fits '08-later Touring models (except Trike). Does not fit models equipped with Passenger Grab Rail P/N 91583-99.



A. HARLEY HAMMOCK TOURING SEAT



A. HARLEY HAMMOCK TOURING SEAT

Notice: The prices appearing in this catalog are the manufacturer's suggested retail prices. Actual retail prices may vary.





**B. SIGNATURE SERIES SOLO SEAT WITH RIDER BACKREST**

**B. SIGNATURE SERIES™ SOLO SEAT WITH RIDER BACKREST**

The perfect combination of foam density and shape has resulted in our most comfortable seat for long haul touring. The seat is shaped with a wide seating area to spread the pressure across the broad surface and a narrow nose area to keep your legs together for a shorter reach to the ground. The Signature Series Solo Seat features a built-in, fully adjustable and removable rider backrest for added support. The backrest provides a 5-position height adjustment with 1.5" range, and a wide range of forward/back adjustment with a quick twist of the control knob. The backrest pad features a sleek shape that provides full lower back support without pushing the rider forward. When combined with the comfortable Passenger Pillion P/N 51770-09 (*sold separately*), the slim profile of the rider backrest offers the passenger a few more inches of space, and the fold-down design permits easy passenger mounting/dismounting. The rich vinyl seating surface is easy to clean and maintain, and features an embossed Bar & Shield logo on the side skirts for a finishing touch. Seat width 16.5".

**51700-09 \$499.95**

Fits '08-later Touring models (except Trike).

**C. SIGNATURE SERIES™ PASSENGER PILLION**

This easy-to-install pillion is designed for long range passenger comfort. The wide seating surface and specific-density padding reduces pressure points and spreads the weight for superior support. The smooth cover matches the Signature Series solo seat, and the embossed Bar & Shield logo on the rear shows everyone that you are riding in style. Add a matching Smooth Passenger Backrest for the complete look. Pillion width 15.0".

**51770-09 \$159.95**

Fits '08-later Touring models (except Trike) equipped with Solo Seat P/N 51700-09.

**D. COMFORT STITCH SEAT FOR ROAD KING® MODELS**

The deep bucket seat design and the smooth cover and stitching are the perfect complement to the Road King style. The deep pocket provides additional back and thigh support for long distance comfort. Can be used with Rider Backrest Kits.

**51157-04A \$299.95**

Fits '97-'07 Road King® and FLHX models. Also fits '97-'07 Electra Glide and Road Glide models equipped with Fuel Tank Console P/N 71288-03A or Trim Piece P/N 52447-96. Seat width 17.0"; passenger pillion width 16.0".

**51703-05 \$299.95**

Fits '97-'07 Electra Glide® (except FLHX) and Road Glide® models. Seat width 17"; passenger pillion width 16.0".



**C. SIGNATURE SERIES PASSENGER PILLION (SHOWN WITH MATCHING SOLO SEAT)**



**D. COMFORT STITCH SEAT FOR ROAD KING MODELS (SHOWN WITH COMFORT STITCH ADJUSTABLE RIDER BACKREST)**

# 360 TOURING

## Seating

### SUNDOWNER™ DEEP BUCKET SEATS

The Sundowner Seat provides the maximum in long-riding comfort. The deep-bucket design puts your body in the proper touring position and the generous padding makes it comfortable for both the rider and passenger as the miles are adding up. The dished shape provides added rider back support, and the wide passenger pillion is shaped to minimize pressure points.

#### A. SUNDOWNER™ DEEP BUCKET SEAT – SMOOTH

The smooth cover complements any Touring model. Seat accepts rider backrest for additional touring comfort.

**52093-08A** **\$299.95**

Fits '08-later Touring and Trike models. Seat width 16"; passenger pillion width 14".

**51726-05** **\$299.95**

Fits '97-'07 Road King® and FLHX models. Also fits '97-'07 Electra Glide® and Road Glide® models equipped with Fuel Tank Console P/N 71288-03A or Trim Piece P/N 52447-96. Seat width 15"; passenger pillion width 12".

**51542-01B** **\$299.95**

Fits '97-'07 Electra Glide (except FLHX) and Road Glide models. Seat width 16"; passenger pillion width 13.5".

#### B. SUNDOWNER™ DEEP BUCKET SEAT – ROAD KING® CLASSIC BASKETWEAVE

Decorated with pleated leather valance and chrome Road King Classic concho, the seat stays true to Road King Classic styling. Accepts rider backrest for additional touring comfort.

**51615-09A** **\$329.95**

Fits '08-later Touring and Trike models. Seat width 16"; passenger pillion width 14".

**51615-99C** **\$329.95**

Fits '97-'07 Road King and FLHX models. Also fits '97-'07 Electra Glide and Road Glide models equipped with Fuel Tank Console P/N 71288-03A or Trim Piece P/N 52447-96. Seat width 15"; passenger pillion width 12".

#### C. SUNDOWNER™ DEEP BUCKET SEAT – STREET GLIDE® STITCHING

Decorated with "tuck and roll" pleating, the Sundowner Seat complements the Street Glide styling. Accepts rider backrest for additional touring comfort.

**51630-09A** **\$329.95**

Fits '08-later Touring and Trike models. Seat width 16"; passenger pillion width 14".

**51630-06** **\$329.95**

Fits '97-'07 FLHX and Road King® models. Also fits '97-'07 Electra Glide® and Road Glide® models equipped with Fuel Tank Console P/N 71288-03A or Trim Piece P/N 52447-96. Seat width 15"; passenger pillion width 12".



A. SUNDOWNER DEEP BUCKET SEAT – SMOOTH '08-LATER ROAD KING SHOWN



B. SUNDOWNER DEEP BUCKET SEAT – ROAD KING CLASSIC '08-LATER SHOWN



C. SUNDOWNER DEEP BUCKET SEAT – STREET GLIDE '08-LATER SHOWN

Notice: The prices appearing in this catalog are the manufacturer's suggested retail prices. Actual retail prices may vary.



**D. SUNDOWNER DEEP BUCKET SEAT – ROAD KING BLACK STUDS**  
(SHOWN WITH ROAD KING PASSENGER BACKREST PAD)



**E. SUNDOWNER DEEP BUCKET SEAT – ROAD KING CUSTOM STITCHING**  
(SHOWN WITH RIDER BACKREST KIT AND PASSENGER BACKREST PAD)



**F. SUNDOWNER SOLO BUCKET SEAT – SMOOTH**  
(SHOWN WITH SUNDOWNER PASSENGER PILLION)

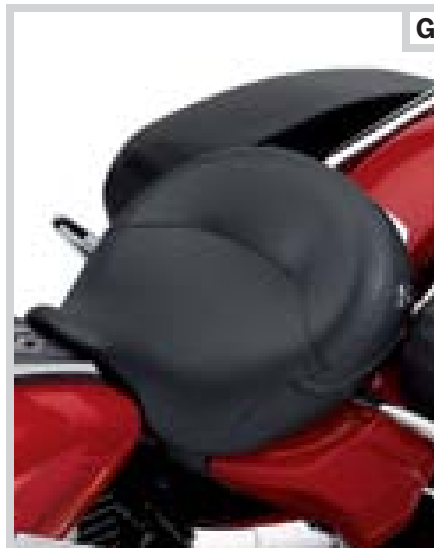

**G. SUNDOWNER SOLO BUCKET SEAT – ROAD KING CLASSIC BASKETWEAVE**

**D. SUNDOWNER™ DEEP BUCKET SEAT – ROAD KING® BLACK STUDS**

Decorated with black studs and the embroidered Road King V-logo, the seat stays true to Road King styling. Accepts rider backrest as well for additional touring comfort.

**51617-99C \$329.95**

Fits '97-'07 Road King® and FLHX models. Also fits '97-'07 Electra Glide® and Road Glide® models equipped with Fuel Tank Console P/N 71288-03A or Trim Piece P/N 52447-96. Seat width 15"; passenger pillion width 12".

**E. SUNDOWNER™ DEEP BUCKET SEAT – ROAD KING® CUSTOM STITCHING**

Decorated with complementing stitching, the Sundowner Seat holds true to the Road King Custom styling. Accepts rider backrest for additional touring comfort.

**51093-04A \$329.95**

Fits '97-'07 Road King and FLHX models. Also fits '97-'07 Electra Glide® and Road Glide® models equipped with Fuel Tank Console P/N 71288-03A or Trim Piece P/N 52447-96. Seat width 15"; passenger pillion width 12".

**F. SUNDOWNER™ SOLO BUCKET SEAT – SMOOTH**

Only one can sit on the throne. This unique seat combines the deep bucket design and added back support of the two-up Sundowner Seat with the stripped-down look of a solo saddle. Same great comfort as the popular two-up version, but in a solo. Matching passenger pillion is available for added versatility.

**51928-01 \$249.95**

Fits '97-'07 Road King® (except FLHRS) and FLHX models. Also fits '97-'07 Electra Glide® and Road Glide® models equipped with Fuel Tank Console P/N 71288-03A or Trim Piece P/N 52447-96. All models (except FLHR) require separate purchase of Solo Seat Hardware Kit P/N 52903-01. Does not accept rider backrest. Seat width 16".

**Shown with:**

**SUNDOWNER™ PASSENGER PILLION – SMOOTH**

This sculpted pillion provides your passenger with the same cushioned comfort as your Solo Sundowner Seat.

**51929-01 \$159.95**

Fits '97-'07 Touring models equipped with an Original Equipment or accessory solo seat (except Brawler seats). Pillion width 12.5".

**G. SUNDOWNER™ SOLO BUCKET SEAT – ROAD KING® CLASSIC BASKETWEAVE**

Styled to complement the Road King® Classic saddlebags, this deep bucket Sundowner Solo Seat features the pleated leather valance and decorative chrome concho that set the Classic apart from the rest. Sundowner Seats combine a deep bucket design with added back support for long-range touring comfort, while the Solo version provides the "stripped-down" look of a classic 50's era Harley-Davidson motorcycle. Passenger Pillion P/N 51929-01 is available for added versatility.

**51092-04 \$289.95**

Fits '97-'07 Road King (except FLHRS) and FLHX models. Also fits '97-'07 Electra Glide and Road Glide models equipped with Fuel Tank Console P/N 71288-03A or Trim Piece P/N 52447-96. All models (except FLHR) require separate purchase of Solo Seat Hardware Kit P/N 52903-01. Does not accept rider backrest. Seat width 16".

# 362 TOURING

Seating

## A. ROAD ZEPPELIN AIR ADJUSTABLE SEAT

The open road. That's where we developed and tested the revolutionary comfort of the Road Zeppelin Seat. This remarkable seat removes pressure points and "hot spots" by adjusting the amount of air contained in each bladder within the seat. Three easy-to-reach rocker switches on the side of the seat control the built-in compressor, adding and bleeding off air with the quick push of a button. On a long run, occasionally inflating and deflating the air bladders reduces the "numb butt" effect by improving the blood flow to the extremities. The new Road Zeppelin Seat features two adjustment zones for the rider and one for the passenger, and a re-designed internal air compressor that adjusts the air level nearly twice as fast as the previous version. The ergonomically-friendly seat design features a narrow front nose for ease of touching the ground at a stop, with a wide seating surface for long range rider and passenger comfort. This seat is a great addition to Trike models too. The easy-to-clean vinyl seat is finished with an embroidered Road Zeppelin logo that lets everyone see that you take riding comfort seriously. This easy-to-install seat accepts a rider backrest and passenger grab rail for additional touring comfort. Seat width 20.0"; passenger pillion width 14.5".

**51072-09** **\$699.95**

Fits '08-later Touring and FLHTCUTG models.  
(Does not fit FLHTXXX.)

### Passenger Zone

Press the 3rd button to inflate and deflate the passenger area, providing maximum comfort to the backbone and support to the thigh area.

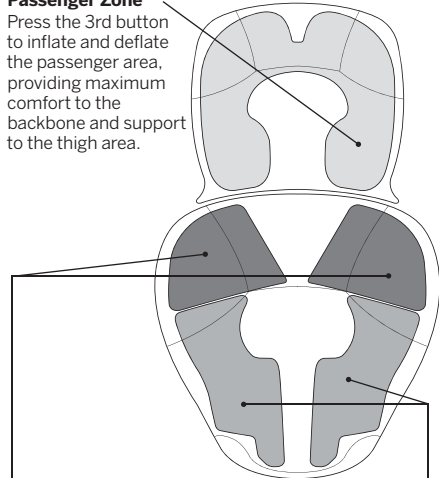

### Lower Back Zones

Press the 2nd button (rider only) to adjust the support in the lower back zone chambers, relieving pressure points in the lower back.

### Thigh Zones

Press the 1st button to adjust pressure in the two thigh zone chambers, improving blood flow to lower extremities and adding support to thighs.



A. ROAD ZEPPELIN AIR ADJUSTABLE SEAT



A. ROAD ZEPPELIN SEAT - CONTROL PANEL

Notice: The prices appearing in this catalog are the manufacturer's suggested retail prices. Actual retail prices may vary.





**B. ROAD ZEPPELIN AIR ADJUSTABLE SEAT – PILLOW-LOOK  
(SHOWN WITH PILLOW-LOOK PASSENGER BACKREST)**



**C. ROAD ZEPPELIN AIR ADJUSTABLE SEAT – LEATHER  
(SHOWN WITH ADJUSTABLE RIDER AND PASSENGER BACKREST)**

### ROAD ZEPPELIN® SEAT COLLECTION

When we sit down on the job, it's usually on a motorcycle. That's where we developed and tested the revolutionary comfort of the Road Zeppelin Seat Collection. These remarkable seats remove pressure points and adjust rider and passenger positions with the push of a few buttons. These buttons control air bladders that are placed within the seat to help relieve pressure from the lower back, tailbone or lower extremities. The seats come with a protective, water-resistant cover and are easy-to-install. So grab a seat. And enjoy the ride.

#### Tailbone Zones

Press the 2nd button to inflate and deflate the tailbone chamber, providing maximum comfort to the backbone.

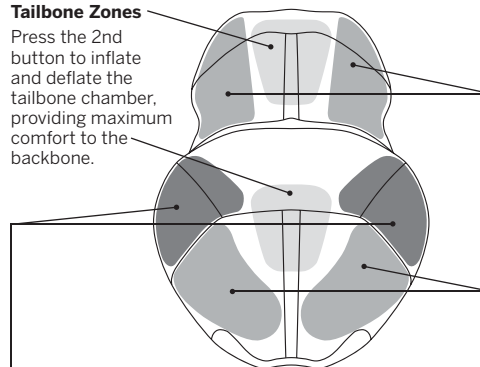

#### Lower Back Zones

Press the 3rd button (rider only) to adjust the support in the lower back zone chambers, relieving pressure points in the lower back.

#### Thigh Zones

Press the 1st button to adjust pressure in the two thigh zone chambers, improving blood flow through the lower extremities.

### B. ROAD ZEPPELIN® AIR ADJUSTABLE SEAT – PILLOW-LOOK

Vinyl Pillow-Look Road Zeppelin Seat is styled to match Original Equipment pillow-look backrests. Kit includes protective rain cover.

**52341-97D \$799.95**

Fits '97-'07 Electra Glide® (except FLHX) and Road Glide® models. Seat width 21.0"; passenger pillion width 17.0".

#### Shown with:

#### PILLOW-LOOK PASSENGER BACKREST FOR KING TOUR-PAK®

**52201-97A \$199.95**

Fits '97-later Touring and Trike models equipped with King Tour-Pak® luggage.

### C. ROAD ZEPPELIN AIR ADJUSTABLE SEAT – LEATHER

This premium seat features leather seating surfaces for long-distance touring comfort. Kit includes protective rain cover.

**52333-97D \$899.95**

Fits '97-'07 Electra Glide® (except FLHX) and Road Glide® models. Seat width 21.0"; passenger pillion width 17.0".

#### Shown with:

#### ROAD ZEPPELIN PASSENGER BACKREST FOR KING TOUR-PAK

**52335-97 \$279.95**

Fits '97-later Touring and Trike models equipped with King Tour-Pak luggage.

NOTE: Some Harley-Davidson® seats are made of leather. Fine leathers or other natural materials WILL gain "character," such as wrinkles or wear, with age. This is normal. A fine, aged patina and character wrinkles are a sign of the extremely high quality materials used to construct your seat or backrest. The appearance of scars or marks on the leather are a result of using natural leather panels and should not be thought of as an imperfection. Please use Harley-Davidson Leather Dressing P/N 98261-91V to protect your investment.

Notice: The prices appearing in this catalog are the manufacturer's suggested retail prices. Actual retail prices may vary.

# 364 TOURING

## Seating

### A. SUN RAY® HEATED SEAT\*

Chase away the chill on long fall and winter rides. This second generation heated seat features dual-zone heated rider and passenger positions with separate high/low/off toggle controls for personal comfort selection. The one-piece seat with integrated heat pad and control system is simple to install, and the heating element is switched on/off with the ignition to avoid draining the battery. Smooth styling complements any Touring model. Can be used with optional Rider Backrest Kits.

**52633-08A** **\$749.95**

Fits '08-later Touring and Trike models. Seat width 15"; passenger pillion width 15".

### B. SUN RAY® HEATED SEAT\* – '97-'07 MODELS

Add warmth and comfort to fall and winter rides. The Sun Ray Seat combines a supportive deep bucket profile and wide passenger pillion with a full length internal heating pad for cool weather comfort. The seat features three rider-selectable heat settings to chase away the chill and help maintain rider and passenger body temperature. One simple button switches settings from off to High, Medium or Low. The self-contained heating element allows simple installation without external controls or switches, and the optional LED Indicator Lamp Kit allows you to monitor heat settings at a glance. The internal heating element is switched on/off with the ignition to avoid draining your battery.

**52130-05** **\$599.95**

Fits '97-'07 Road King® and FLHX models. Also fits '97-'07 FLHT and FLTR models equipped with Fuel Tank Console P/N 71288-03A or Trim Piece 52447-96. Seat width 17.5"; passenger pillion width 13.5". Will accept Rider Backrest Kits.

**52127-05** **\$599.95**

Fits '97-'07 Electra Glide® (except FLHX) and '98-'07 Road Glide® models. Seat width 17.5"; passenger pillion width 13.5". Will accept Rider Backrest Kits.

#### Shown with:

#### LED INDICATOR LAMP FOR SUN RAY HEATED SEAT

Monitor the temperature setting of your Sun Ray Heated Seat at a glance. The LED illuminates at three different intensities to indicate the Low, Medium and High heat setting. The optional LED Indicator Lamp Kit mounts in an Auxiliary Switch Housing (sold separately) to put the lamp close to your line of sight.

**53040-05** **\$69.95**

Fits models equipped with Sun Ray Heated Seat P/N 52127-05 or 52130-05. Requires additional purchase of Auxiliary Switch Housing P/N 70255-02A, 70256-02, 70213-02A or 70248-02.

### C. FLHT/FLTR TRIM PIECE

This top-stitched trim piece opens a new world to the Standard Electra Glide® and Road Glide® model owners, allowing fitment of Road King® seats.

**52447-96** Fits '94-'07 FLHT and FLTR models. **\$24.95**

### D. TANK BRA FOR TOURING MODELS

Manufactured from non-abrasive, fleece-backed vinyl, this tank bra for your Touring model features an embroidered Bar & Shield logo. It protects your fuel tank from belt buckle and key scratches, and nicks from road debris. Designed for easy installation and a custom fit without tank or seat removal.

**62063-01** Fits '97-later Touring and Trike models. **\$39.95**



A. SUN RAY HEATED SEAT – '08-LATER TOURING MODELS



B. SUN RAY HEATED SEAT – '97-'07 ROAD KING MODELS  
(SHOWN WITH LED INDICATOR LAMP)



C. FLHT/FLTR TRIM PIECE



D. TANK BRA FOR TOURING MODELS

\*NOTE: It is possible to overload your motorcycle's charging system by adding too many electrical accessories. If your combined electrical accessories operating at any one time consume more electrical current than your vehicle's charging system can produce, the electrical consumption can discharge the battery and cause vehicle electrical system damage. Ask your dealer for advice about the amount of current consumed by additional electrical accessories.

Notice: The prices appearing in this catalog are the manufacturer's suggested retail prices. Actual retail prices may vary.

NEW

E



E. CIRCULATOR SEAT PAD

**E. CIRCULATOR SEAT PAD**

Keep comfortable on your next long ride. These breathable Circulator Seat Pads feature 3D construction that promotes air movement and reduces heat build-up where the rider's body touches the seat. Designed to keep the rider cool by reducing the perspiration build-up between you and the seating surface, the Circulator Pad can be installed and removed in seconds for easy cleaning. The low-profile design minimizes seat-height change compared to inflatable pads, while enhancing comfort with its shock-absorbing construction. Manufactured of UV-stable materials, these seat pads resist fading when exposed to the sun. Elastic under-seat strap and non-slip base provide secure installation, and the available Circulator Passenger Pillion Pad attaches to the rider pad with hook-and-loop tabs.

**51076-10** Large Pad (16.0" width). **\$89.95**

Fits Softail and Touring models with Original Equipment and accessory seats. Will not fit Spring seats and Road Zeppelin seats.

**51078-10** Passenger Pillion Pad (13.0" width). **\$69.95**  
Fits Original Equipment and accessory passenger pillions.

**F. SHEEPSKIN COVER COLLECTION**

Made with real sheep's wool that breathes when compressed to improve comfort and eliminate hot weather stickiness. Because it also insulates, wool gives added warmth for cold weather riding. Naugahyde side trim eliminates bulkiness and wrinkles for the sleek look of a custom-tailored seat with sheepskin inserts. A tough bungee cord sewn in the bottom hem provides a custom fit and prevents slipping.

**52060-98** Touring Seat Cover. **\$159.95**  
Fits '97-'07 Touring model seats (except Custom Collection and Low-Profile seats). Can be used with Rider Backrest.

**52061-98** Rider Backrest Cover. **\$69.95**  
Fits Touring models equipped with first generation Rider Backrests. Does not fit with XXXX-09 Rider Backrests.

**52062-98** Passenger Backrest Cover. **\$99.95**  
Fits '86-later King Tour-Pak® backrests.

**G. RAIN COVERS\*\***

Featuring a handy storage sack, this black nylon, water-resistant, Cordura® cover packs easily and shelters your seat from the storm.

**52952-97** Seat with Rider Backrest. **\$34.95**  
Fits most Touring seats with rider backrest and/or passenger backrest. Does not fit Trike models.

**51639-97** Touring Seat. **\$29.95**  
Fits FLSTS and most Touring seats. Does not fit with rider or passenger backrests.

**51637-97** Two-Up Seat. **\$29.95**  
Fits H-D two-up seats (except XR, FLSTS and Softail® Seats with Rider Backrests).

**51638-97** Solo Seat. **\$29.95**  
Fits H-D solo seats (except XR and FLSTS).

**H. CHROME BILLET SEAT MOUNTING BRACKET**

The highly stylized design of this bracket adds a stunning new look to the back of most seats.

**51804-02** **\$19.95**  
Replaces Bolt-on Seat Brackets P/N 52467-00, 51652-97 and 51652-83B used on most Original Equipment and accessory seats and pillions. See parts catalog or instruction sheet for your application.

**I. DETACHABLE SEAT HARDWARE KIT**

These hardware kits allow the rider to remove one-piece Harley-Davidson® seats quickly and easily.

**51676-97A** **\$19.95**  
Fits '97-later XL, Dyna®, Softail and Touring models. Does not fit seats equipped with spring-loaded rear seat bracket.



F. SHEEPSKIN COVER COLLECTION



G. RAIN COVER – TOURING SEAT WITH RIDER BACKREST COVER



H. CHROME BILLET SEAT MOUNTING BRACKET



I. DETACHABLE SEAT HARDWARE KIT



**\*\*WARNING:** Do not use while riding; could result in death or serious injury.

Notice: The prices appearing in this catalog are the manufacturer's suggested retail prices. Actual retail prices may vary.

# 366 TOURING

## Seating

### A. ADJUSTABLE RIDER BACKREST KITS

Add support for the long haul. With one quick pull from the integrated gas spring, you can instantly adjust the riding position through a 30-degree range. The backrest pad features a sleek shape that provides full lower back support without pushing the rider forward, and a slim profile that offers the passenger a few more inches of space. The backrest features a pull knob activated, five-position, 1.5" height adjustment. The backrest can be easily removed, and folds down to allow easier passenger mounting.

Fits '97-later Touring and Trike models equipped with most one-piece slotted seats. Installation requires separate purchase of model-specific Mounting Hardware Kit.

<b>1. 52423-09A</b>	Comfort Stitch Style.	<b>\$99.95</b>
<b>2. 52591-09A</b>	Road King® Classic Style.	<b>\$99.95</b>
<b>3. 52546-09A</b>	Street Glide® Style.	<b>\$99.95</b>
<b>4. 52464-09A</b>	Pillow-Look Style.	<b>\$99.95</b>
<b>5. 52501-09A</b>	Smooth Style.	<b>\$99.95</b>

### ADJUSTABLE RIDER BACKREST MOUNTING HARDWARE KIT

Kit includes mounting bracket, adjustment handle, and all required installation hardware.

**52593-09A** \$209.95  
Required to install Adjustable Rider Backrest on '97-'08 Touring models.

**52596-09A** \$209.95  
Required to install Adjustable Rider Backrest on '09-later Touring models (except Trike).

**54099-10** \$209.95  
Required to install Adjustable Rider Backrest on '09-later Trike models.



A. ADJUSTABLE RIDER BACKREST KITS

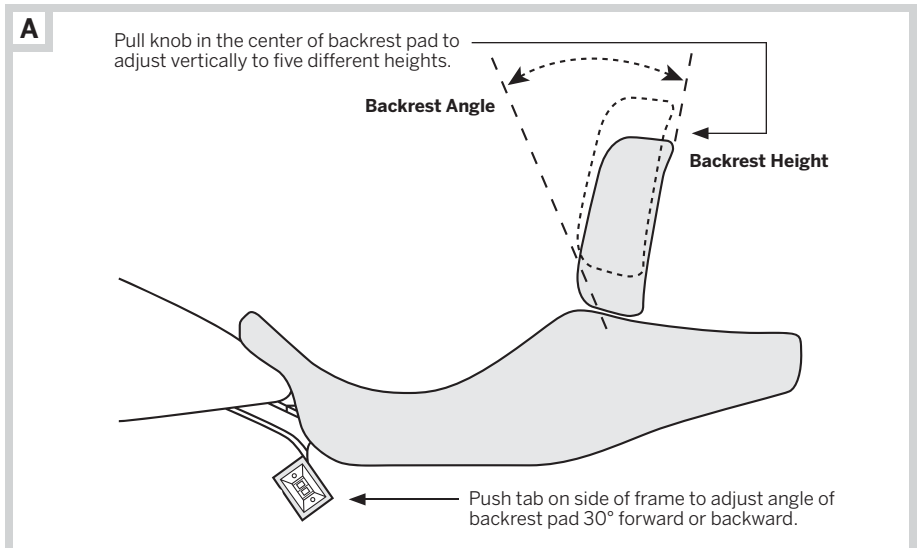

A. ADJUSTABLE RIDER BACKREST KITS

*Notice: The prices appearing in this catalog are the manufacturer's suggested retail prices. Actual retail prices may vary.*



B



B. RIDER BACKREST KITS

**B. RIDER BACKREST KITS**

Add back support for long-haul riding comfort. Contoured backrest pad is shaped to provide full lower back support without pushing the rider forward, and the slim profile offers the passenger a few more inches of room. An adjustable support bracket with four mounting locations accommodates different seats and riding positions. The backrest pad angle can be adjusted for maximum comfort.

Fits '88-later Touring models (except Trike) equipped with one-piece slotted seat. Installation requires separate purchase of model-specific Rider Backrest Mounting Hardware Kit.

<b>1. 52572-09A</b>	Comfort Stitch Style.	<b>\$189.95</b>
<b>2. 52583-09A</b>	Road King® Classic Style.	<b>\$189.95</b>
<b>3. 51631-09A</b>	Street Glide Style.	<b>\$189.95</b>
<b>4. 52900-09A</b>	Smooth Leather Style.	<b>\$209.95</b>
<b>5. 52914-09A</b>	Smooth Vinyl Style.	<b>\$189.95</b>
<b>6. 52530-09A</b>	Pillow-Look Style.	<b>\$189.95</b>
<b>7. 51564-09</b>	CVO Road Glide® Style.	<b>\$249.95</b>
<b>8. 51839-10</b>	CVO Street Glide® Style.	<b>\$249.95</b>

**RIDER BACKREST MOUNTING HARDWARE KIT**

Kit includes mounting bracket and all required installation hardware.

**52587-09** **\$29.95**

Required to install rider backrest on '88-'08 Touring models.

**52589-09** **\$29.95**

Required to install rider backrest on '09-later Touring models (except Trike).

**C. PASSENGER GRAB RAIL**

Add comfort and confidence for your riding companion. Chrome-plated handrail provides a convenient hand grip for your passenger, and a secure tie-down point for pillion-mounted touring luggage. For a custom look, add Passenger Handrail Covers P/N 91668-05 (*sold separately*).

**97026-09** **\$119.95**

Fits '09-later Touring models (except Trike).

**91583-99** **\$129.95**

Fits '06-'08 Electra Glide®, Street Glide™, Road King® and Road Glide® models. Does not fit Touring models with Tour-Pak mounted rear speakers, or models equipped with Leather Saddlebags. Original Equipment on '99-'05 FLHT, FLHTC and FLHTCU models.

**D. PASSENGER HANDRAIL COVERS**

Beef up the look of the passenger handrail with these easy-to-install chrome-plated grips. The thick diameter offers a firm and comfortable hand hold for your passenger, and features jet black rubber inserts, "ball-milled" grooves and Bar & Shield logo for added style. Kit includes right and left grip and stainless steel mounting hardware.

**91668-05** **\$54.95**

Fits '06-later Dyna®, Softail® and '99-later Touring models equipped with accessory Passenger Grab Rails.



C. PASSENGER GRAB RAIL



D. PASSENGER HANDRAIL COVERS

*Notice: The prices appearing in this catalog are the manufacturer's suggested retail prices. Actual retail prices may vary.*

# TOURING **BACKRESTS & RACKS**

## COMFORT ON THE GO.

*With a detachable backrest and luggage rack, your bike can go from a stripped-down after-noon cruiser to a fully loaded two-up touring machine in seconds. Comfort and convenience-driven accessories make for a less stressful ride.*

### THE RIGHT COMBINATION



#### PUTTING IT TOGETHER

*A detachable sissy bar upright and backrest pad is the starting point for a complete touring machine. Start by shopping the following pages and selecting all the components required for your particular model.*

### EQUIPPED FOR THE MILES AHEAD

Solo and stripped down, two-up and fully loaded, or anywhere in between, you can tailor any Harley-Davidson® motorcycle to meet the demands of the byways.

#### TWO-UP

*Take a day's ride on a bike built for two. Saddlebags carry clothes and the essentials, while a Sissy Bar Backrest Pad provides hours of passenger comfort on the open road.*



#### TWO-UP TOUR-PAK®

*The ultimate road trip. With all this space and comfort, you and one lucky passenger are fully equipped to go wherever you want, for as long as you want. See you later.*



#### SOLO TOUR-PAK®

*Ride like you're on a mission. The saddlebags and Tour-Pak offer tons of storage space, and the Solo Mounting Rack positions the Tour-Pak Pad for maximum rider back support.*



### CHANGING YOUR BACKREST



With a Docking Hardware Kit installed, adding or removing a Detachable accessory is a simple "slide and click" proposition. Rotate the cam-lock to release the sissy bar from the rear docking points. Pivot the sissy bar forward, and lift it free from the front docking points.

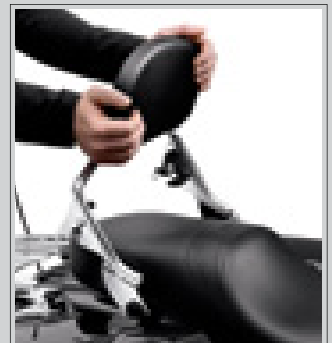

# TOURING 369

Backrests & Racks



A

**A. 2-POINT DOCKING HARDWARE KIT – CHROME**



NEW

A

**A. 2-POINT DOCKING HARDWARE KIT – GLOSS BLACK**



B

**B. 4-POINT DOCKING HARDWARE KIT – CHROME**



NEW

B

**B. 4-POINT DOCKING HARDWARE KIT – GLOSS BLACK**

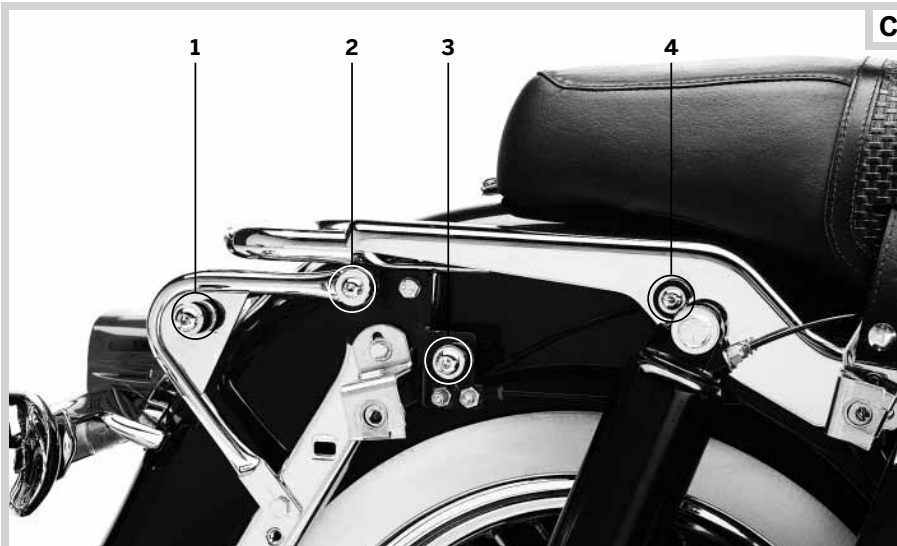

C

**C. DETACHABLE DOCKING HARDWARE KIT – '94-'08 TOURING MODELS**

## A. 2-POINT DOCKING HARDWARE KIT

Add a passenger backrest or solo rack to your Touring model. The simple choice if all you need is a passenger backrest or a solo rack, this kit contains the docking hardware necessary to install the basic Detachable accessory options on Road King®, Road Glide®, Street Glide® or Electra Glide® Standard models. Provides docking points to allow installation of Detachable Sissy Bar, Solo Luggage Rack, or Solo Tour-Pak® Rack. Does not fit with 2-Up Luggage Racks or 2-Up Tour-Pak Rack.

Fits '09-later FLHR, FLHRC, FLHT, FLHX, FLTR and FLTRX models. For use with Detachable Sissy Bars, Solo Luggage Rack, and Solo Tour-Pak Rack. Does not fit with 2-Up Luggage Racks or 2-Up Tour-Pak Rack. FLHRC models require separate purchase of Saddlebag Hinge Stop Kit P/N 90580-09.

<b>54030-09</b>	Chrome.	<b>\$109.95</b>
<b>54249-09</b>	Gloss Black.	<b>\$109.95</b>

## B. 4-POINT DOCKING HARDWARE KIT

The ideal choice for maximum versatility, this complete kit contains the docking hardware necessary to install all Detachable accessory options. Even if you only install a passenger backrest today, this kit allows you to add additional accessories as your touring demands change. Provides docking points to allow installation of Detachable Sissy Bar, Solo Luggage Rack, 2-Up Luggage Rack, Solo Tour-Pak Rack or 2-Up Tour-Pak Rack.

Fits '09-later FLHR, FLHRC, FLHT, FLHX, FLTR, FLTRX, FLHXSE and FLTRSE3 models. For use with Detachable Sissy Bars, Solo Luggage Racks, 2-Up Luggage Racks, Solo Tour-Pak Rack and 2-Up Tour-Pak Rack. FLHRC models require separate purchase of Saddlebag Hinge Stop P/N 90580-09.

<b>54205-09</b>	Chrome.	<b>\$149.95</b>
<b>54246-09</b>	Gloss Black.	<b>\$149.95</b>

## C. DETACHABLE DOCKING HARDWARE KITS – '97-'08 TOURING MODELS

### For Sissy Bar, Solo Luggage Rack or Solo Tour-Pak

Kit contains the docking hardware necessary to install Detachable accessories on your Road King, Road Glide, Street Glide or Electra Glide Standard model. Provides docking points to allow installation of Detachable Passenger Backrest, Solo Luggage Rack or Solo Tour-Pak Rack.

<b>53803-06</b>		<b>\$41.95</b>
Fits '97-'08 Touring models (except FLHTCUI and '07-'08 FLHRSE3/4).		

### For Two-Up Tour-Pak or Two-Up Luggage Rack

Kit contains the docking hardware necessary to install Detachable accessories on your Road King, Road Glide, Street Glide or Electra Glide Standard model. Provides docking points to allow installation of Detachable Two-Up Luggage Rack or Two-Up Tour-Pak.

<b>53804-06</b>		<b>\$59.95</b>
Fits '97-'08 Touring models (except FLHTCUI and '07-'08 FLHRSE3/4).		

<b>53988-07</b>		<b>\$54.95</b>
Fits '07-'08 FLHRSE3/4 models.		

## Docking Hardware Fitment Matrix – '94-'08 Models

Touring Detachable	Docking Kit	Diagram
Sissy Bar Upright P/N 52933-97B, 52805-97B, 52935-04 or 52723-06	<b>53803-06</b>	<b>3 &amp; 4</b>
Two-Up Luggage Rack P/N 53743-97	<b>53804-06</b>	<b>1 &amp; 2</b>
Two-Up Tour-Pak® Rack P/N 53276-04	<b>53804-06</b>	<b>1 &amp; 2</b>
Solo Tour-Pak Rack P/N 53260-02	<b>53803-06</b>	<b>3 &amp; 4</b>
Solo Luggage Rack P/N 53048-06	<b>53803-06</b>	<b>3 &amp; 4</b>

Notice: The prices appearing in this catalog are the manufacturer's suggested retail prices. Actual retail prices may vary.

TOURING

# 370 TOURING

## Backrests & Racks

### A. DETACHABLE PASSENGER

#### SISSY BAR UPRIGHT – SHORT ('09-LATER MODELS)

The ideal match for Low-Profile Custom and Badlander® seats, this backrest is 2" shorter than the standard-height upright. The one-piece upright accepts Short Backrest Pads (sold separately), and features easy on-and-off detachable convenience. Requires separate purchase of Docking Hardware.

Fits '09-later Road King®, FLHT, FLHX, FLTRX and FLTR models equipped with required Docking Kits. Also fits '09-later FLHTC, FLHTCU and FLHTK models equipped with Detachable Tour-Pak Rack Kit P/N 53246-09.

<b>52610-09</b>	Chrome.	<b>\$179.95</b>
<b>54248-09</b>	Gloss Black.	<b>\$179.95</b>

### B. DETACHABLE PASSENGER

#### SISSY BAR UPRIGHT – STANDARD-HEIGHT ('09-LATER MODELS)

Designed for the long haul, this standard-height sissy bar accepts a wide range of passenger backrest pads for customizable comfort. This detachable backrest can be installed or removed in seconds, adding versatility and style to your Touring model. Requires separate purchase of Docking Hardware.

Fits '09-later Road King®, FLHT, FLHX, FLTRX and FLTR models equipped with required Docking Kits. Also fits '09-later FLHTC, FLHTCU and FLHTK models equipped with Detachable Tour-Pak Rack Kit P/N 53246-09.

<b>52627-09</b>	Chrome.	<b>\$179.95</b>
<b>54247-09</b>	Gloss Black.	<b>\$179.95</b>

### C. DETACHABLE PASSENGER

#### SISSY BAR UPRIGHTS ('94-'08 MODELS)

A sissy bar and passenger backrest pad is the starting point for building a complete touring machine. The backrest provides long-range comfort and support, and adds a feeling of confidence and control for the passenger. Available in your choice of Short and Standard-Height designs, these chrome-plated Detachable One-Piece Uprights can be installed or removed in seconds to add versatility to your ride. A wide variety of Backrest Pads are available for separate purchase.

Fits '97-'08 Road King®, FLHT, FLHX and FLTR models equipped with required Docking Kits. Fits '06-'08 FLHTC models equipped with Detachable Tour-Pak Rack Mounting Kit P/N 53303-07 and Docking Hardware Kit P/N 53803-06.

<b>52935-04</b>	Short.	<b>\$179.95</b>
<b>52933-97B</b>	Standard-Height.	<b>\$179.95</b>

Fits '94-'96 FLHR and FLHT models equipped with Docking Kits.

<b>52805-97B</b>	Standard-Height.	<b>\$189.95</b>
------------------	------------------	-----------------



**A. SHORT DETACHABLE PASSENGER SISSY BAR UPRIGHT – CHROME**

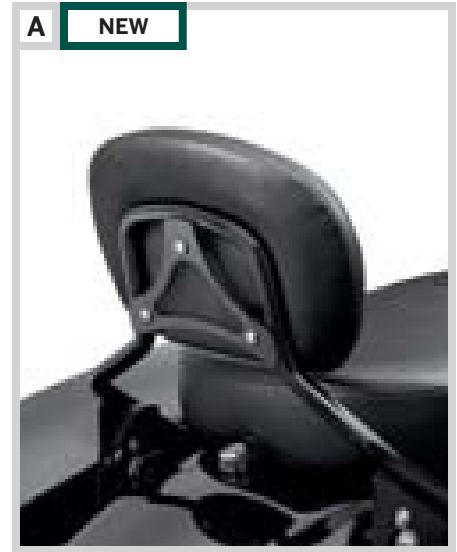

**A. SHORT DETACHABLE PASSENGER SISSY BAR UPRIGHT – GLOSS BLACK**



**B. STANDARD-HEIGHT DETACHABLE PASSENGER SISSY BAR UPRIGHT – CHROME**

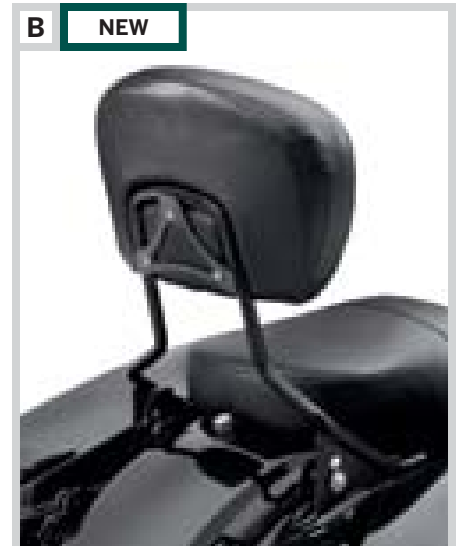

**B. STANDARD-HEIGHT DETACHABLE PASSENGER SISSY BAR UPRIGHT – GLOSS BLACK**



**C. SHORT DETACHABLE PASSENGER SISSY BAR UPRIGHT – '97-'08 MODELS**

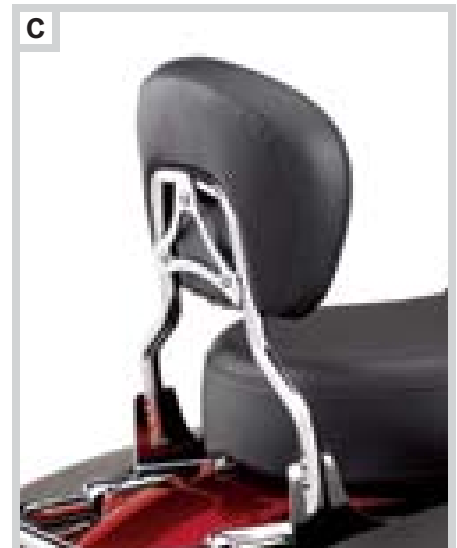

**C. STANDARD-HEIGHT DETACHABLE PASSENGER SISSY BAR UPRIGHT – '97-'08 MODELS**

Notice: The prices appearing in this catalog are the manufacturer's suggested retail prices. Actual retail prices may vary.





**D. TALL DETACHABLE PASSENGER SISSY BAR UPRIGHT (SHOWN WITH STYLED BACKREST MOUNTING PLATE)**



**E. DETACHABLES LOCK**



**F. BILLET PASSENGER BACKREST MOUNT**



**G. STYLED BACKREST MOUNTING PLATE**



**H. REAR DOCKING HARDWARE COVER KIT - CHROME**



**H. REAR DOCKING HARDWARE COVER KIT - BLACK**

**D. DETACHABLE PASSENGER SISSY BAR UPRIGHT - TALL ('97-'08 MODELS)**

The perfect complement to touring seats with large passenger pillion area, this brilliant, chrome-plated backrest is 2-1/2" taller than Passenger Sissy Bar P/N 52933-97B. The Tall Upright accepts most touring model passenger backrest pads and features easy on-and-off Detachable convenience. Requires separate purchase of Detachable Docking Hardware P/N 53803-06. Can be used with Universal Deluxe Side Loading Roller Bag P/N 98949-06 and Nylon Ultra Touring Bag P/N 98884-06.

**52723-06 \$159.95**

Fits '97-'08 Road King®, FLHT, FLHX and FLTR models equipped with required Docking Kits. Fits '06-'08 FLHTC models equipped with Detachable Tour-Pak Rack Kit P/N 53303-07 and Docking Hardware Kit P/N 53803-06.

**E. DETACHABLES LOCK\***

Now you can have the convenience of Detachables with the security of barrel locks. This unique lock replaces the camlock on your Harley-Davidson® Detachable accessories, providing additional security and peace-of-mind when parking your vehicle. Kit includes two extended-reach barrel-style keys for easy access to the lock. Designed exclusively by Harley-Davidson. Key registration\* and replacement service is available.

Fits all models equipped with Detachable Sideplates, Racks and Tour-Pak® Luggage Carriers (except '09-later Touring models equipped with Detachable Solo Tour-Pak Rack).

**46063-98 Single. \$46.95**

~~**46106-00 Set of Two. \$89.95**~~ **OBSELETE**

\*Key Registration and Replacement Service:

This service is provided by the lock manufacturer. Information is included in the product packaging.

**F. BILLET PASSENGER BACKREST MOUNT**

Chrome-plated billet aluminum and an engraved Bar & Shield emblem set the tone for this custom Passenger Backrest Mount, which will make you look even better as you're rolling by. Replaces the stock mounting plate, and includes chrome-plated mounting hardware.

**53086-04 \$64.95**

Fits Touring models equipped with Detachable Sissy Bar Upright P/N 52805-97B, 52933-97B, 52723-06, 52610-09 or 52627-09.

**G. STYLED BACKREST MOUNTING PLATE**

This custom Backrest Mounting Plate replaces the stamped metal mount for a distinctive look. The mirror-finished bracket, chrome-plated mounting hardware and vivid black insert contrasts with a leather or vinyl backrest pad to dress your Touring bike in style.

**52825-05 \$45.95**

Fits Touring models equipped with Detachable Sissy Bar Upright P/N 52805-97B, 52933-97B, 52723-06, 52610-09 or 52627-09.

**H. REAR DOCKING HARDWARE COVER KIT**

Disguise the rear docking hardware with these easy-to-install covers. The caps slide over the exposed docking points, and are held in place by a strong magnetic pull. The caps are easy to remove when you wish to reinstall detachable accessories. Covers are available with brilliant Chrome or durable Gloss Black finish to match your bike's attitude. Sold in pairs.

Fits many accessory docking hardware kits. Refer to the fitment matrix on page 543 or the Parts & Accessories section of [www.harley-davidson.com](http://www.harley-davidson.com) for details.

**48218-10 Short Chrome. (pair) \$24.95**

**48220-10 Large Chrome. (pair) \$24.95**

**48035-09 Small Chrome. (pair) \$24.95**

**48221-10 Short Black. (pair) \$24.95**

**48223-10 Large Black. (pair) \$24.95**

**48225-10 Small Black. (pair) \$24.95**

# 372 TOURING

## Backrests & Racks

### A. SHORT PASSENGER BACKREST PAD – SMOOTH LOOK

Smooth cover complements the Badlander® Seat, Custom Collection and Low-Profile seats. The slim profile allows additional passenger room, and the low overall height continues the long and lean profile of your custom Touring bike. Easily attaches to Detachable Short Sissy Bar Upright P/N 52935-04 with chrome mounting bracket (*included*).

**51579-05** **\$99.95**

Fits '97-later Touring models equipped with Short Detachable Sissy Bar Upright. Will not fit seats with tall passenger pillion pads.

### B. SHORT PASSENGER BACKREST PAD – COMPACT

Sized to complement low-profile custom seats, this compact leather backrest pad combines practical passenger support with custom compact style. The leather cover with smooth insert complements both synthetic and leather seating surfaces. Pad easily mounts to Detachable Short Sissy Bar Upright P/N 52935-04, and the kit includes a styled backrest mounting plate.

**52408-07** **\$189.95**

Fits '97-'08 Touring models equipped with Short Detachable Sissy Bar Upright P/N 52935-04. Will not fit seats with tall passenger pillion.

### C. PASSENGER BACKREST PAD – LEATHER LOW-PROFILE

Styled to match Leather Low-Profile Bucket Seat P/N 52918-98A.

**52920-98A** **\$109.95**

Fits '94-later Touring and Trike models equipped with Standard-Height or Tall Detachable Sissy Bar Upright or Luggage Rack P/N 53341-97A.

### D. PASSENGER BACKREST PAD – SMOOTH

Large backrest area is great for long distance touring. Contoured pad provides low back support, and the smooth top-stitched pad complements most seating surfaces. Pad height 9", width 13.5".

**52886-98C** **\$99.95**

Fits '94-later Touring and Trike models equipped with Standard-Height or Tall Detachable Sissy Bar Upright or Luggage Rack P/N 53341-97A.

### E. PASSENGER BACKREST PAD – TOP-STITCHED COMPACT

Styled to match Road King® Classic and Road Glide® models.

**52924-98A** **\$99.95**

Fits '94-later Touring and Trike models equipped with Standard-Height or Tall Detachable Sissy Bar Upright or Luggage Rack P/N 53341-97A.

### F. PASSENGER BACKREST PAD – STREET GLIDE™ STITCHING

Styled to match the Street Glide model. Large backrest area is great for long touring. Contoured pad provides low back support.

**51633-06** **\$99.95**

Fits '94-later Touring and Trike models equipped with Standard-Height or Tall Detachable Sissy Bar Upright or Luggage Rack P/N 53341-97A.



A. SHORT PASSENGER BACKREST PAD – SMOOTH LOOK



B. SHORT PASSENGER BACKREST PAD – COMPACT



C. PASSENGER BACKREST PAD – LEATHER LOW-PROFILE



D. PASSENGER BACKREST PAD – SMOOTH



E. PASSENGER BACKREST PAD – TOP-STITCHED COMPACT



F. PASSENGER BACKREST PAD – STREET GLIDE STITCHING

# TOURING 373

Backrests & Racks



G

**G. PASSENGER BACKREST PAD – CUSTOM STITCHING**



H

**H. PASSENGER BACKREST PAD – COMFORT STITCH**



I

**I. PASSENGER BACKREST PAD – PILLOW-LOOK**



J

**J. PASSENGER BACKREST PAD – STUDED**



K

**K. PASSENGER BACKREST PAD – STUDED**



NEW

L

**L. SADDLEBAG HINGE STOP KIT**

## G. PASSENGER BACKREST PAD – CUSTOM STITCHING

Styled to match Road King Custom models, the large backrest area is great for long touring. The contoured pad shape provides additional lower back support.

**52657-04A** **\$99.95**

Fits '94-later Touring and Trike models equipped with Standard-Height or Tall Detachable Sissy Bar Upright or Luggage Rack P/N 53341-97A.

## H. PASSENGER BACKREST PAD – COMFORT STITCH

Styled to match the smooth cover and stitch pattern of the Comfort Stitch Seats and Rider Backrests, this contoured pad can add hours of passenger comfort.

**51727-05** **\$99.95**

Fits '94-later Touring and Trike models equipped with Standard-Height or Tall Detachable Sissy Bar Upright or Luggage Rack P/N 53341-97A.

## I. PASSENGER BACKREST PAD – PILLOW-LOOK

This large backrest pad features a generous radius for increased passenger comfort.

**52708-97B** **\$99.95**

Fits '94-later Touring and Trike models equipped with Standard-Height or Tall Detachable Sissy Bar Upright or Luggage Rack P/N 53341-97A.

## J. PASSENGER BACKREST PAD – STUDED

This large backrest pad features a generous radius for increased passenger comfort. Studded styling matches Road King Touring Seat P/N 51617-99C and stock Road King seat.

**52709-97B** **\$99.95**

Fits '94-later Touring and Trike models equipped with Standard-Height or Tall Detachable Sissy Bar Upright or Luggage Rack P/N 53341-97A.

## K. PASSENGER BACKREST PAD – STUDED

This stylish Backrest Pad is accented with decorative black studs and an embroidered Road King V-Logo. Chrome-plated mounting bracket and chrome hardware are included.

**52555-94A** **\$89.95**

Fits '94-later Touring models equipped with Standard-Height or Tall Detachable Sissy Bar Upright or Luggage Rack P/N 53341-97A.

## L. SADDLEBAG HINGE STOP KIT

Required for installation of Docking Hardware Kits on '09-later FLHRC models, and Luggage Rack P/N 53011-98 on '94-'08 FLHRC and '07-'08 FLHRSE models.

**90580-09** **\$37.95**

Fits '09-later FLHRC models equipped with Docking Hardware Kits. Also fits '94-'08 FLHRC and '07-'08 FLHRSE models equipped with Luggage Rack P/N 53011-98.

TOURING

Notice: The prices appearing in this catalog are the manufacturer's suggested retail prices. Actual retail prices may vary.

## 374 TOURING

### Backrests & Racks

#### A. LUGGAGE RACK FOR DETACHABLE PASSENGER Sissy BAR UPRIGHT\*

This attractive chrome-plated rack adds additional versatility to your Detachable Passenger Backrest. Designed to mount directly to the detachable backrest upright, the rack and backrest can be easily removed or reinstalled as a unit to suit your touring or cruising style.

**53011-98 \$199.95**

Fits '94-'08 Touring models equipped with Detachable Backrests P/N 52805-97B, 52933-97B and 52723-06.

(Does not fit P/N 52935-04.) FLHRC and '07-'08 FLHRSE models also require separate purchase of Saddlebag Hinge Stop Kit P/N 90580-09.

#### B. DETACHABLE TWO-UP LUGGAGE RACK\*

Smooth sweeping curves and a brilliant chrome finish defines the look of this Luggage Rack. This sleek and functional rack is an elegant solution for carrying your luggage across the country. Designed to work with or without Detachable Passenger Backrests, this rack can be installed or removed from the Docking Hardware in seconds, creating a truly versatile ride.

**54215-09 \$219.95**

Fits '09-later FLHR, FLHRC, FLHT, FLHX, FLTR, FLTRX, FLHXSE and FLTRSE3. Requires separate purchase of 4-Point Docking Hardware Kit. FLTR, FLTRX and FLHX models require separate purchase of Antenna Relocation Kit P/N 76561-09. Some FLHRC EU registration plates may interfere with rack.

#### C. DETACHABLE TWO-UP LUGGAGE RACK\*

Designed to work with Detachable Backrests, these racks allow you to convert from a two-up traveler to a solo rider in classic style.

**53743-97 \$209.95**

Fits '97-'08 Road King®, FLHT, FLHX and FLTR models equipped with required Docking hardware. FLTR and FLHX models require separate purchase of Antenna Relocation for Detachable Two-Up Accessories P/N 76208-07.

Does not fit with Layback License Plate Mounting Kit P/N 53385-00. Some EU registration plates may interfere with rack.

#### D. DETACHABLE SOLO LUGGAGE RACK\*

Add touring capabilities to your solo seat-equipped model in less than 60 seconds. This Detachable Solo Rack fits over the fender when the passenger pillion is removed. The rack features sweeping curved rails, and the chrome finish adds a stylish flair. Easily interchangeable with Detachable Passenger Sissy Bar Upright. Requires installation of appropriate Docking Hardware Kit. Can be used with Universal Luggage Rack Bag P/N 98868-98.

**54213-09 \$219.95**

Fits '09-later FLHR, FLHRC, FLHT, FLHX, FLTR, FLTRX, FLHXSE and FLTRSE3 models equipped with a solo seat. Requires separate purchase of 2-Point or 4-Point Docking Hardware Kit.

**53048-06 \$219.95**

Fits '97-'08 Road King, FLHT, FLHX and FLTR models equipped with solo seat and required docking hardware.



A. LUGGAGE RACK FOR DETACHABLE PASSENGER Sissy BAR UPRIGHT



B. DETACHABLE TWO-UP LUGGAGE RACK



C. DETACHABLE TWO-UP LUGGAGE RACK



D. DETACHABLE SOLO LUGGAGE RACK – '09-LATER MODELS



D. DETACHABLE SOLO LUGGAGE RACK – '97-'08 MODELS



**\*WARNING:** Do not use this rack as a seat. Do not exceed the fender rack weight capacity. Using as seat or exceeding this capacity could cause handling problems which could result in loss of control and death or serious injury.

Notice: The prices appearing in this catalog are the manufacturer's suggested retail prices. Actual retail prices may vary.





NEW

E

E. STEALTH DETACHABLE LUGGAGE RACK – CHROME

**E. STEALTH DETACHABLE LUGGAGE RACK\***

Style and practicality in one. This classic four-bar Detachable Luggage Rack flows with the long and lean lines of today's custom rides. The rails and curving support blend together for an integrated floating look, and the "stealth" hidden hardware adds to the clean design. Available in chrome or gloss black finishes, the detachable rack can be removed in seconds, allowing you to strip your bike for around-town riding or to simplify cleaning and polishing the rear fender.

Fits '09-later FLHR (except FLHRC), FLHT, FLHX, FLTR, FLTRX, FLHXSE and FLTRSE3 models. Requires separate purchase of 4-Point Docking Hardware Kit.

<b>53472-09</b>	Chrome.	<b>\$299.95</b>
<b>53566-09</b>	Black.	<b>\$299.95</b>

**F. STEALTH RIGID LUGGAGE RACK KIT\***

Style and practicality in one. The classic four-bar luggage rack has been updated to flow with the long and lean lines of today's custom rides. The chrome-plated rails are rigid-mounted to the curving fender support, and blend together for an integrated floating look, and the "stealth" hidden hardware adds to the clean design.

**53938-04** **\$309.95**

Fits '06-'08 FLHX models. Also fits '99-'08 Electra Glide® Standard, Road King® (except FLHRSE3/4) and Road Glide® models with separate purchase of Bullet Turn Signal Bar and License Plate Relocation Kit P/N 53702-04.

**G. CHROME FOUR-CHANNEL LUGGAGE RACK AND SISSY BAR\***

Hand-polished chrome rack features easily adjustable bracket support.

**53341-97A** **\$219.95**

Fits '97-'08 Road King, FLHT and FLTR models. Racks accept the following backrests: P/N 52708-97A, 52709-97A, 52555-94A, 52920-98, 52924-98A and 52886-98B.

Does not fit with Short Passenger Backrest Pads.



NEW

E

E. STEALTH DETACHABLE LUGGAGE RACK – GLOSS BLACK



F

F. STEALTH RIGID LUGGAGE RACK KIT



G

G. CHROME FOUR-CHANNEL LUGGAGE RACK AND SISSY BAR



**\*WARNING:** Do not use this rack as a seat. Do not exceed the fender rack weight capacity. Using as seat or exceeding this capacity could cause handling problems which could result in loss of control and death or serious injury.

Notice: The prices appearing in this catalog are the manufacturer's suggested retail prices. Actual retail prices may vary.

# 376 TOURING

Tour-Pak® Luggage

## A. DETACHABLE TWO-UP TOUR-PAK® MOUNTING RACK\* – '09-LATER MODELS

Change your riding style in less than 60 seconds. The ultimate in touring flexibility, this Tour-Pak Rack makes the convenience and protection of a Razor-Pak, Chopped, King, or Leather Tour-Pak Luggage System a simple on-and-off proposition. Simple turn latches mount the rack to the bike's docking points, and allow you to replace the Tour-Pak with a detachable sissy bar upright for around-town cruising. The chrome-plated Detachable Rack positions a Tour-Pak behind the passenger pillion, and allows the passenger to use the luggage as a supporting backrest. Adjustable over a 3/4" range, the Tour-Pak can be located for maximum passenger room and comfort. Tour-Pak, Passenger Backrest Pad, and Docking Hardware Kit sold separately.

**53276-09A** **\$179.95**

Fits '09-later FLHR, FLHRC, FLHT, FLHX, FLTR, FLTRX, FLHXSE and FLTRSE3 models. Requires separate purchase of 4-Point Docking Hardware Kit. FLHX, FLTR, FLTRSE3 and FLHXSE models require separate purchase of Tour-Pak Antenna Relocation Kit P/N 76556-09.



A. DETACHABLE TWO-UP TOUR-PAK MOUNTING RACK – '09-LATER MODELS

## B. DETACHABLE SOLO TOUR-PAK MOUNTING RACK\* – '09-LATER MODELS

The Solo Tour-Pak Rack moves a Razor-Pak, Chopped or King Tour-Pak forward to a comfortable back-supporting position. The rack is designed to position the Tour-Pak® for solo riding and is adjustable over a 3/4" range. Simply remove the Tour-Pak from the convenient detachable hardware, add a passenger pillion, and the bike is ready for two-up riding. Tour-Pak, Backrest Pad and Docking Hardware sold separately.

**53260-09A** **\$179.95**

Fits '09-later FLHR, FLHRC, FLHT, FLHX, FLTR, FLTRX, FLHXSE and FLTRSE3 models equipped with a solo seat. Requires separate purchase of 2-Point or 4-Point Docking Hardware Kit. FLHX, FLTR, FLTRSE3 and FLHXSE models require separate purchase of Tour-Pak Antenna Relocation Kit P/N 76556-09.



B. DETACHABLE SOLO TOUR-PAK MOUNTING RACK – '09-LATER MODELS

## C. DETACHABLE TOUR-PAK MOUNTING RACK KIT FOR ELECTRA GLIDE® – '09-LATER MODELS

Transform your Electra Glide model for around town cruising. This kit includes everything needed to convert the rigid-mount Tour-Pak to an easy on-and-off detachable version. Complete kit includes two-up docking hardware kit, detachable Two-Up Tour-Pak Rack, chrome strut covers, chrome license plate holder, reflector, and AM/FM antenna relocation hardware.

**53246-09A** **\$549.95**

Fits '09-later FLHTC, FLHTCU and FLHTK models. FLHTCU and FLHTK models require separate purchase of Wiring Harness P/N 70032-09.

### Also available:

#### TOUR-PAK QUICK DISCONNECT HARNESS FOR ULTRA MODELS

Wiring Harness Kit allows the installation of Detachable Tour-Pak Rack Kit P/N 53246-09 on '09-later Ultra Classic Electra Glide and Limited models. Kit includes rear lighting wiring harness, CB antenna relocation kit and passenger communication port mounting clip.

**70032-09** **\$79.95**

Fits '09-later FLHTCU and FLHTK models equipped with Detachable Tour-Pak Rack Kit P/N 53246-09.



C. DETACHABLE TOUR-PAK MOUNTING RACK KIT FOR ELECTRA GLIDE – '09-LATER MODELS (SHOWN WITHOUT LICENSE PLATE BRACKET FOR CLARITY)



**\*WARNING:** Do not use this rack as a seat. Do not exceed the fender rack weight capacity. Using as seat or exceeding this capacity could cause handling problems which could result in loss of control and death or serious injury.

Notice: The prices appearing in this catalog are the manufacturer's suggested retail prices. Actual retail prices may vary.



**D. DETACHABLE TWO-UP TOUR-PAK MOUNTING RACK – '97-'08 MODELS**  
(SHOWN WITH CHOPPED TOUR-PAK LUGGAGE)



**E. DETACHABLE SOLO TOUR-PAK MOUNTING RACK – '97-'08 MODELS**  
(SHOWN WITH KING TOUR-PAK LUGGAGE)

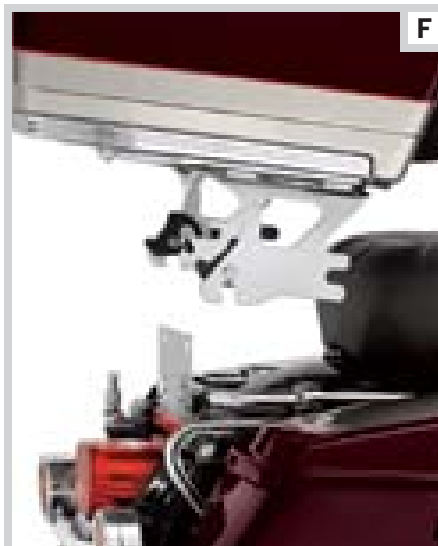

**F. DETACHABLE TOUR-PAK MOUNTING RACK KIT FOR ELECTRA GLIDE CLASSIC MODELS – '97-'08 MODELS**



**G. DETACHABLE TOUR-PAK LIGHT HARNESS KIT**

**D. DETACHABLE TWO-UP TOUR-PAK® MOUNTING RACK\* – '97-'08 MODELS**

Change your riding style in less than 60 seconds. The ultimate in touring flexibility, this Tour-Pak Rack makes the convenience and protection of a Razor-Pak, Chopped, King, or Leather Tour-Pak Luggage System a simple on-and-off proposition. Simple turn latches mount the rack to the bike's docking points, and allow you to replace the Tour-Pak with a detachable sissy bar upright for around-town cruising. The chrome-plated Detachable Rack positions a Tour-Pak behind the passenger pillion, and allows the passenger to use the luggage as a supporting backrest. Adjustable over a 3/4" range, the Tour-Pak can be located for maximum passenger room and comfort. Tour-Pak, Passenger Backrest Pad and Docking Hardware sold separately.

**53276-04 \$179.95**

Fits '97-'08 Road King®, FLHT, FLHX and FLTR models equipped with required docking hardware. FLTR and FLHX models require Antenna Relocation Kit P/N 76326-00A. Does not fit with Layback License Plate Mounting Kit P/N 53385-00. Some EU registration plates may interfere with Tour-Pak Rack. Models with rear fender tip trim can be adapted with the separate purchase of License Plate Relocation Kit P/N 60095-00A.

**E. DETACHABLE SOLO TOUR-PAK® MOUNTING RACK\* – '97-'08 MODELS**

The Solo Tour-Pak Rack moves a Razor-Pak, Chopped or King Tour-Pak forward to a comfortable back-supporting position. The rack is designed to position the Tour-Pak for solo riding and is adjustable over a 3/4" range. Simply remove the Tour-Pak from the convenient detachable hardware, add a passenger pillion, and the bike is ready for two-up riding. Tour-Pak, Backrest Pad and Docking Hardware sold separately.

**53260-02 \$209.95**

Fits '97-'08 Road King, FLHT, FLHX and FLTR models equipped with solo seat and required docking hardware.

**F. DETACHABLE TOUR-PAK® MOUNTING RACK KIT FOR ELECTRA GLIDE® CLASSIC MODELS\* – '97-'08 MODELS**

Transform your Electra Glide Classic model for around-town cruising. This kit includes everything needed to convert the rigid-mount Tour-Pak to an easy on-and-off detachable version. In just seconds (and without tools), you can install the Tour-Pak for that long run across the country, and remove it for a stripped-down look when you get there. With the addition of Docking Hardware Kit P/N 53803-06 (sold separately), you can install a detachable Sissy Bar Upright and passenger backrest pad for around-town passenger comfort. Complete kit includes two-up docking hardware kit, detachable Two-Up Tour-Pak Rack, chrome license plate holder, reflector, and AM/FM antenna relocation hardware.

**53303-07 \$329.95**

Fits '97-'08 FLHTC models. '97-'05 models require separate purchase of Light Harness Kit P/N 70113-08.

**G. DETACHABLE TOUR-PAK LIGHT HARNESS KIT**

Wiring Harness Kit allows the installation of Detachable Tour-Pak Rack Kit P/N 53303-07 on '97-'05 FLHTC models.

**70113-08 \$13.95**

Fits '97-'05 FLHTC models equipped with Detachable Tour-Pak Kit P/N 53303-07.



**\*WARNING:** Do not use this rack as a seat. Do not exceed the fender rack weight capacity. Using as seat or exceeding this capacity could cause handling problems which could result in loss of control and death or serious injury.

Notice: The prices appearing in this catalog are the manufacturer's suggested retail prices. Actual retail prices may vary.

# 378 TOURING

Tour-Pak® Luggage

## TOUR-PAK® LUGGAGE\*

Add cross-country luggage capacity to your ride with accessory Tour-Pak Luggage. A cavernous interior will hold one full-face helmet or two half helmets. Kit includes backrest pad, interior rubber mat, hardware and instructions. Luggage capacity: 2500 cubic inches. Dimensions: 18.5" W x 17" D x 13" H. Racks and docking kits sold separately. International models may require separate purchase of License Plate Relocation Kit P/N 60095-00A.

Fits '00-later Softail® models (except Deuce™, Rocker™ and FXSTSSE3) equipped with Detachable Solo or Two-Up Tour-Pak Rack. Fits '97-later Touring models (except Trike) equipped with Detachable Two-Up or Solo Tour-Pak Racks. Fits '04-later XL models equipped with Solo Tour-Pak Rack. '10 FLSTSE models require separate purchase of Mounting Hardware Kit P/N 54245-10.

<b>A. 53147-98C</b> Road King® Classic Leather Styling.	<b>\$649.95</b>
<b>B. 53092-08A</b> CVO Road King "Reptile Print" Leather Styling.	<b>\$649.95</b>
<b>C. 53690-06A</b> Smooth Vinyl with Bar & Shield Logo.	<b>\$499.95</b>
<b>D. 53057-07A</b> CVO Road King Flamed Leather Styling. Installation requires separate purchase of Lock Set P/N 54360-05.	<b>\$649.95</b>
<b>E. 54114-10</b> CVO Softail Convertible Buffalo Leather Styling.	<b>\$649.95</b>



**A. ROAD KING CLASSIC LEATHER TOUR-PAK LUGGAGE (SHOWN WITH DETACHABLE TWO-UP TOUR-PAK RACK)**

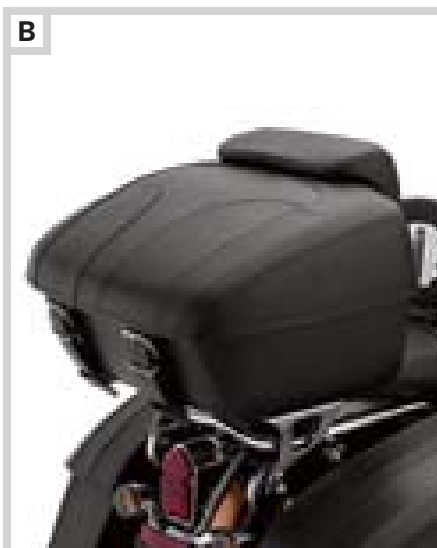

**B. CVO ROAD KING "REPTILE PRINT" LEATHER TOUR-PAK LUGGAGE**



**C. SMOOTH VINYL TOUR-PAK LUGGAGE**



**D. CVO ROAD KING FLAMED LEATHER TOUR-PAK LUGGAGE**

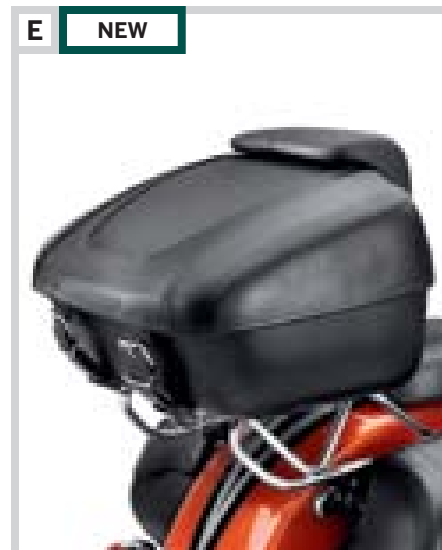

**NEW**

**E. CVO SOFTAIL CONVERTIBLE LEATHER TOUR-PAK LUGGAGE**

NOTE: Some Harley-Davidson® seats are made of leather. Fine leathers or other natural materials WILL gain "character," such as wrinkles or wear, with age. This is normal. A fine, aged patina and character wrinkles are a sign of the extremely high quality materials used to construct your seat or backrest. The appearance of scars or marks on the leather are a result of using natural leather panels and should not be thought of as an imperfection. Please use Harley-Davidson Leather Dressing P/N 98261-91V to protect your investment.

Notice: The prices appearing in this catalog are the manufacturer's suggested retail prices. Actual retail prices may vary.





**F. PREMIUM LEATHER TOUR-PAK LUGGAGE**  
(SHOWN WITH TOUR-PAK INSTALLATION KIT)



**F. PREMIUM LEATHER TOUR-PAK LUGGAGE**  
(SHOWN WITH TOUR-PAK INSTALLATION KIT)



**G. LEATHER TOUR-PAK LOCK SET**



**H. ROAD KING SADDLEBAG LOCK SET**



**I. ROAD KING CLASSIC SADDLEBAG TRIM**

#### F. PREMIUM LEATHER TOUR-PAK® LUGGAGE\*

First introduced on the '06 Screamin' Eagle Ultra Classic® Electra Glide, this king-sized Tour-Pak will provide all the storage capacity you need for a trip across the country. This smooth leather-wrapped luggage is highlighted with an embossed ostrich pattern insert, leather braiding and custom stitching, and features a raised center section to accommodate most full-face helmets. Tour-Pak includes Chrome Luggage Rack, Chrome Accent Spears, and Interior Light. Kit does not include Tour-Pak mounting rack, hardware or instructions to relocate an antenna on models equipped with a radio or CB.

**79189-06 \$1,499.00**

Fits '97-'08 Road King®, Road Glide®, Electra Glide® Standard and Street Glide® models equipped with Tour-Pak Rack and appropriate Docking Hardware Kits. Road Glide and Street Glide models require separate purchase of Antenna Relocation Kit P/N 76326-00A. All models require separate purchase of Tour-Pak Installation Kit P/N 90067-06, Keyed-to-Match Tour-Pak Lock P/N 53865-06, Lock Clip P/N 53868-06 and Fitted Tour-Pak Liners P/N 91814-06 and 53230-06. International models may require separate purchase of License Plate Relocation Kit P/N 60095-00A.

#### Shown with:

##### TOUR-PAK INSTALLATION KIT

Kit includes wrap-around passenger backrest pad and required Tour-Pak installation hardware. Does not include Tour-Pak mounting rack.

**90067-06 \$399.95**

Required for installation of Premium Leather Tour-Pak Luggage P/N 79189-06 on '97-'08 Road King®, Road Glide, Electra Glide Standard and Street Glide models.

#### G. LEATHER TOUR-PAK LOCK SET

Designed to discourage grab-and-run theft, this Lock Set provides a level of security that leather straps alone can't match. The complete kit includes external locking push-button latch release, locking mechanism, release cable, two keys, steel Tour-Pak lid mounting plate, and all required installation hardware. Special order keyed-to-match lock sets are available for models with barrel-type keys. Contact your Dealer with your vehicle key code.

**54360-05 \$169.95**

Fits models equipped with Leather or Synthetic Leather Tour-Pak Luggage (except P/N 79189-06).

#### H. ROAD KING® SADDLEBAG LOCK SET

Add theft deterrence to your Road King rigid leather saddlebags. Special order keyed-to-match lock set available. Contact your Dealer with your vehicle key code. Kit includes two keys.

**46316-04 \$239.95**

Fits '98-later Road King Classic models.

**46287-04 \$69.95**

Fits '04-'07 Road King Custom models.

#### I. ROAD KING® CLASSIC SADDLEBAG TRIM

Chrome-plated, extruded and machined aluminum trim for saddlebag lid. Saddlebag trim complements the details of the Road King fuel console. Includes four extruded trim spears and polished, stainless steel button head mounting hardware. Designed for use on the FLHRC leather saddlebags. Also looks great on Color-Matched hard bags.

**53767-98 \$129.95**

Fits '98-later Road King Classic and '93-later models with H-D® Color-Matched Hard Saddlebags.

# TOURING **TOUR-PAK®** & SADDLEBAGS

## ROOM TO ROAM

*Hitting the open road with just the clothes on your back may sound romantic, but it's not always the easiest way to travel. Rain gear, extra clothing and basic supplies are easy to take along when you add Tour-Pak® luggage and saddlebag accessories.*

## TOUR-PAK LUGGAGE: PACK IT ALL

Designed for maximum convenience and versatility, Tour-Pak luggage makes packing for your next trip a pleasure. Available in a variety of capacities, these hinge-opening trunks are designed to keep your belongings dry in almost any weather.



## SADDLEBAGS: FUNCTION WITH STYLE



Factory-equipped with saddlebags, Touring models are already capable of hauling almost everything you need. So why not dress them up to match your sense of style. Color-Matched Extended Saddlebags add capacity with a custom “tail dragger” look, and the matching Lid Spoilers add flair and visibility.



## OTHER THINGS TO CONSIDER

There are plenty of options that can make your saddlebags and Tour-Pak luggage work even harder. Form-fitted liners and mesh interior pouches simplify the search for small items, and lid rails and luggage racks make adding additional soft luggage a breeze.

- A. LED AUXILIARY LIGHTING
- B. FITTED LINERS & LIFT-OUT BAGS
- C. WATER BOTTLES & STORAGE POUCHES



## RAZOR-PAK LUGGAGE

The ultimate in touring style. The slim but surprisingly roomy Razor-Pak luggage is designed to add convenient luggage-carrying capacity without distracting from the lean look of your custom bagger. Ideal size to carry a briefcase, laptop computer, or a change of clothes, the locking Razor-Pak top case can actually swallow compact half-helmets and some lightweight riding gear. So, get in a good day at the office, change your gear, and hit Main Street in style. Razor-Pak luggage can be mounted to rigid or detachable Tour-Pak mounting racks, and accepts many of the lid racks, trim, spoilers and other accessories available for Chopped and King Tour-Pak luggage.



RAZOR-PAK LUGGAGE

Lock and Keys P/N 53194-07 (keyed-to-match) sold separately. Razor-Pak luggage can be installed on a Detachable Solo or Two-Up Tour-Pak Rack, Rigid Mount Rack, or Original Equipment Tour-Pak rack on Electra Glide Classic and Ultra Classic models. Dimensions: 22" W x 16" L x 5.5" H. Capacity: 1900 cubic inches. See your Dealer for additional hardware requirements.

*Fits '97-later Touring models. Not compatible with rear speakers.*

<b>79175-10BDK</b>	Prime.	<b>\$649.00</b>
<b>79175-10BPS</b>	Black Cherry Pearl.	<b>\$749.95</b>
<b>79175-10BYM</b>	Black Denim.	<b>\$749.95</b>
<b>79175-10BPY</b>	Black Pearl.	<b>\$749.95</b>
<b>79175-10BHT</b>	Brilliant Silver.	<b>\$749.95</b>
<b>79175-10DEH</b>	Candy Concord.	<b>\$1,199.95</b>
<b>79175-10CPF</b>	Candy Red Sunglo.	<b>\$749.95</b>
<b>79175-10CPD</b>	Crimson Red Denim.	<b>\$749.95</b>
<b>79175-10COZ</b>	Crimson Red Sunglo.	<b>\$749.95</b>
<b>79175-10CPG</b>	Dark Blue Denim.	<b>\$749.95</b>
<b>79175-10CPC</b>	Dark Blue Pearl.	<b>\$749.95</b>
<b>79175-10BXT</b>	Deep Cobalt Pearl.	<b>\$749.95</b>
<b>79175-10BXY</b>	Fire Red Pearl.	<b>\$749.95</b>
<b>79175-10CWA</b>	Flame Blue Pearl.	<b>\$749.95</b>
<b>79175-10BNR</b>	Mirage Orange Pearl.	<b>\$749.95</b>
<b>79175-10DCE</b>	Merlot Sunglo.	<b>\$749.95</b>
<b>79175-10CGV</b>	Olive Pearl.	<b>\$749.95</b>
<b>79175-10CGP</b>	Pacific Blue Pearl.	<b>\$749.95</b>
<b>79175-10CGR</b>	Pewter Pearl.	<b>\$749.95</b>
<b>79175-10CHG</b>	Pacific Blue Denim.	<b>\$749.95</b>
<b>79175-10CHH</b>	Pewter Denim.	<b>\$749.95</b>
<b>79175-10CYE</b>	Red Hot Denim.	<b>\$749.95</b>
<b>79175-10CYS</b>	Red Hot Sunglo.	<b>\$749.95</b>
<b>79175-10DBJ</b>	Scarlet Red.	<b>\$749.95</b>
<b>79175-10DEK</b>	Spiced Rum.	<b>\$1,199.95</b>
<b>79175-10CGT</b>	Suede Blue Pearl.	<b>\$749.95</b>
<b>79175-10DEM</b>	Tequila Sunrise.	<b>\$1,199.95</b>
<b>79175-10DH</b>	Vivid Black.	<b>\$749.95</b>
<b>79175-10CGS</b>	White Gold Pearl.	<b>\$749.95</b>
<b>79175-10DBV</b>	White Ice Pearl.	<b>\$749.95</b>
<b>79175-10BPZ</b>	Yellow Pearl.	<b>\$749.95</b>

*Notice: The prices appearing in this catalog are the manufacturer's suggested retail prices. Actual retail prices may vary.*

# 382 TOURING

Tour-Pak® Luggage

## CHOPPED TOUR-PAK® LUGGAGE

Achieve a radical touring profile with this 3" lower Tour-Pak. The traditional Tour-Pak luggage shape has been chopped and sectioned for a sleek, sporty look. Lock and Keys P/N 53194-07 (keyed-to-match) sold separately. Chopped Tour-Pak can be installed on a Detachable Solo or Two-Up Tour-Pak Rack, Rigid Mount Rack, or Original Equipment Tour-Pak rack on Electra Glide Classic and Ultra Classic models. Dimensions: 22" W x 16" L x 8" H. Capacity: 2800 cubic inches. See your Dealer for additional hardware requirements.



**COLOR-MATCHED CHOPPED TOUR-PAK LUGGAGE  
(SHOWN WITH DETACHABLE TWO-UP TOUR-PAK RACK AND BACKREST PAD)**

### CHOPPED TOUR-PAK® LUGGAGE

*Chopped Tour-Pak fits '97-later Touring models.  
Not compatible with rear speakers.*

#### Solid Color

Black Cherry		53111-05BPS	\$724.95
Black Denim		53111-09BYM	\$724.95
Black Pearl		53111-05BPY	\$724.95
Chopper Blue		53111-05BPO	\$724.95
Candy Red Sunglo		53111-08CPF	\$724.95
Crimson Red Denim		53111-08CPD	\$724.95
Crimson Red Sunglo		53111-08COZ	\$724.95
Dark Blue Denim		53111-08CPG	\$724.95
Dark Blue Pearl		53111-08CPC	\$724.95
Deep Cobalt		53111-06BXT	\$724.95
Fire Red Pearl		53111-06BXY	\$724.95
Flame Blue Pearl		53111-09CWA	\$724.95
Mirage Orange Pearl		53111-07BNR	\$724.95
Pacific Blue Denim		53111-07CHG	\$724.95
Pacific Blue Pearl		53111-07CGP	\$724.95
Pewter Denim		53111-07CHH	\$724.95
Pewter Pearl		53111-07CGR	\$724.95
Red Hot Denim		53111-09CYE	\$724.95
Red Hot Sunglo		53111-09CYS	\$724.95
Rich Sunglo Blue		53111-05BPV	\$724.95
Scarlet Red		53111-10DBJ	\$724.95
Smokey Gold		53111-04BJL	\$724.95
Vivid Black		53111-96DH	\$724.95
White Gold Pearl		53111-07CGS	\$724.95
Yellow Pearl		53111-05BPZ	\$724.95

#### Solid Color

#### Inner/Outer Pinstripe

Black Cherry	Burgundy/Burgundy	53111-05BPR	\$749.95
Black Denim	Medium Red	53111-10DBN	\$749.95
Black Pearl	Burgundy/Burgundy	53111-05BRD	\$749.95
Brilliant Silver	Blue/Medium Silver	<del>53111-04BHZ</del>	<del>\$749.95</del>
Brilliant Silver Pearl	Medium Silver	53111-10BJN	\$749.95
Flame Blue Pearl	Process Blue	53111-10CWB	\$749.95
Flame Blue Pearl/Brilliant Silver	Process Blue/Medium Silver	53111-10DCK	\$774.95
Fire Fighter Red	Pale Gold/Pale Gold	53111-05BRJ	\$749.95

**OBSOLETE**

Notice: The prices appearing in this catalog are the manufacturer's suggested retail prices. Actual retail prices may vary.





**Chopped Tour-Pak®**  
Solid Color with Pinstripe



**Chopped Tour-Pak**  
Solid Color with Twin Pinstripes



**Chopped Tour-Pak**  
Two-Tone Color with Twin Pinstripes

*Chopped Tour-Pak fits '97-later Touring models.  
Not compatible with rear speakers.*

Solid Color	Inner/Outer Pinstripe		
Glacier White Pearl	Medium Silver/Medium Silver	53111-04BJG	\$749.95
Peace Officer Blue	Blue/Medium Silver	53111-03EU	\$749.95
Red Hot Sunglo	Pale Gold/Medium Red	53111-10CYT	\$749.95
<i>Rich Sunglo Blue</i>	<i>Lunar Blue</i>	<del>53111-05BPT</del>	<del>\$749.95</del>
Scarlet Red	Bright Gold/Bright Gold	53111-03LI	\$749.95
Scarlet Red	Medium Red	53111-10DBO	\$749.95
Vivid Black	Anniversary Stripe	53111-03BDR	\$749.95
Vivid Black	Burgundy	53111-99AB	\$749.95
Vivid Black	Burgundy/Bright Gold	53111-99CF	\$749.95
Vivid Black	Medium Silver/Medium Silver	53111-04BHY	\$749.95
Vivid Black	Medium Silver	53111-10DBX	\$749.95
Solid Color/Panel	Inner/Outer Pinstripe		
Copper Pearl/Vivid Black	Orange/Pale Gold	53111-08COR	\$774.95
Crimson Red Sunglo/Candy Red Sunglo	Red/Pale Gold	53111-08CPR	\$774.95
Luxury Teal/Brilliant Silver	Burgundy	53111-04BJJ	\$774.95
Scarlet Red/Vivid Black	Camo Tan	53111-10DBM	\$774.95
Sterling Silver/Vivid Black	Anniversary Stripe	53111-03BDS	\$774.95
Suede Blue/Vivid Black	Tan/Dark Blue	53111-07CGY	\$774.95
Vivid Black/Brilliant Silver	Medium Silver	53111-04BKA	\$774.95
Vivid Black/Black Ice Pearl	Metallic Charcoal	53111-10DCL	\$774.95
White Gold Pearl/Pewter Pearl	Dark Blue/Medium Silver	53111-08CPY	\$774.95
Solid Color/Panel	Inner/Outer Pinstripe		
Big Purple Flake/Brilliant Silver	Proper Purple	53111-09CWS	\$949.95
Black Ice/Blue Ice	Tan/Blue	53111-09CWW	\$949.95
<i>Candy Cobalt/Starlight Black</i>		<del>53213-04BKK*</del>	<del>\$949.95</del>
Centennial Gold/Black & Burgundy		53111-03BFG	\$949.95
Electric Orange		53111-09CFZ	\$1,199.95
Light Candy Root Beer/Dark Candy Root Beer	Amber Gold/Burgundy	53111-09CWV	\$949.95
Merlot Sunglo/Cherry Red Sunglo	Amber Gold	53111-10DCF	\$949.95
<i>Orange Pearl &amp; Jet Black/Vivid Black</i>		<del>53213-04BKM*</del>	<del>\$949.95</del>
Stardust Silver		53111-09CZB	\$1,199.95
White Ice Pearl/Black Ice Pearl	Camo Tan/Light Purple	53111-10DBW	\$949.95
Yellow Pearl ('09 CVO)		53111-09BKR	\$1,199.95

*Notice: The prices appearing in this catalog are the manufacturer's suggested retail prices. Actual retail prices may vary.*

*\*Includes Pre-Mounted Radio Antenna Base*

# 384 TOURING

Tour-Pak® Luggage

## KING TOUR-PAK® LUGGAGE

Add long-haul convenience and storage capacity to your Road King®, Street Glide®, or Electra Glide® Standard model. Color-Matched to the motorcycle base color, this Tour-Pak is factory equipped with bottom reinforcement plate, luggage box mat, and map pouch. King Tour-Pak for FLHX models includes pre-mounted radio antenna base. King Tour-Pak can be installed on a Detachable Solo or Two-Up Tour-Pak Rack, Rigid Mount Rack, or Original Equipment Tour-Pak rack on Electra Glide Classic and Ultra Classic® models (*sold separately*). Dimensions: 22" W x 16" x 11" H. Capacity: 3850 cubic inches.



**COLOR-MATCHED KING TOUR-PAK® LUGGAGE FOR FLHR, FLHX AND FLHT MODELS  
(SHOWN WITH DETACHABLE SOLO TOUR-PAK RACK, BACKREST PAD AND SIDE LIGHT COVER)**

	KING TOUR-PAK LUGGAGE					
	Fits '97-'05	Fits '06-'08 FLHR	Fits '06-'08 FLHT	Fits '06-'08 FLHX	Fits '09-later FLHR/ FLHT/FLHXXX	Fits '09-later FLHX
<b>Solid Color</b>	<b>\$724.95</b>			<b>\$724.95</b>	<b>\$724.95</b>	<b>\$724.95</b>
Black Cherry	53116-05BPS	—	—	53270-06BPS	—	—
Black Denim	—	—	—	—	—	79071-10BYM
Black Pearl	53116-05BPY	—	—	53270-06BPY	—	79071-09BPY
Brilliant Silver	53116-04BHT	—	—	—	—	—
Brilliant Silver Pearl	—	—	—	—	—	79071-10BHT
Chopper Blue	53116-05BPO	—	—	—	—	—
Concord Purple	53116-00QH	—	—	—	—	—
Crimson Red Denim	—	—	—	53270-08CPD	—	—
Crimson Red Sunglo	—	—	—	53270-08COZ	—	—
Dark Blue Denim	—	—	—	53270-08CPG	—	—
Dark Blue Pearl	—	—	—	53270-08CPC	—	79071-09CPC
Deep Cobalt	—	—	—	53270-06BXT	—	—
Fire Fighter Red	53116-05BRK	—	—	—	—	—
Glacier White Pearl	53116-04BHJ	—	—	—	—	—
Gunmetal Pearl	53116-03BDT	—	—	—	—	—
Lava Red Sunglo	53116-04BJK	—	—	—	—	—
Luxury Blue	53116-01XE	—	—	—	—	—
Luxury Rich Red	53116-00ZQ	—	—	—	—	—
Luxury Teal	53116-04BHV	—	—	—	—	—
Pacific Blue Denim	—	—	—	53270-07CHG	—	—
Pewter Denim	—	—	—	53270-07CHH	—	79071-09CHH
Pewter Pearl	—	—	—	—	—	79071-09CGR
<b>Real Red</b>	<b>OBSOLETE 53116-04BBN</b>	—	—	—	—	—
Red Hot Denim	—	—	—	—	—	79071-09CYE
Red Hot Sunglo	—	—	—	—	53963-10CYS	79071-09CYS
Rich Sunglo Blue	53116-05BPV	—	—	—	—	—
Scarlet Red	—	—	—	—	—	79071-10DBJ
Sierra Red	53116-04BHS	—	—	—	—	—
Smokey Gold	53116-04BJL	—	—	—	—	—
Sterling Silver	53116-03BDP	—	—	—	—	—
Suede Green Pearl	53116-00KB	—	—	—	—	—
Vivid Black	53116-97DH	—	—	53270-06DH	53963-10DH	79071-09DH
White Gold Pearl	—	—	—	53270-08CGS	—	—
White Pearl	53116-02ZB	—	—	—	—	—
Yellow Pearl	53116-05BPZ	—	—	—	—	—



FLHX Tour-Pak®  
Solid Color



FLHT Tour-Pak  
Solid Color with Pinstripe



FLHR Tour-Pak  
Two-Tone Color with Twin Pinstripes

KING TOUR-PAK LUGGAGE

		Fits '97-'05	Fits '06-'08 FLHR	Fits '06-'08 FLHT	Fits '06-'08 FLHX	Fits '09-later FLHR/ FLHT/FLHXXX	Fits '09-later FLHX
<b>Solid Color</b>	<b>Inner/Outer Pinstripe</b>		<b>\$749.95</b>	<b>\$749.95</b>		<b>\$749.95</b>	<b>\$749.95</b>
Black Cherry	Burgundy/Burgundy	—	53332-06BPR	—	—	—	—
Black Denim	Medium Silver/Medium Silver	—	—	—	—	53963-09CWK	—
Black Pearl	Burgundy/Burgundy	—	53332-06BRD	—	—	—	—
Crimson Red Sunglo	Pale Gold/Medium Red	—	53332-08CPX	53274-08CPX	—	—	—
Dark Blue Pearl	Medium Silver/Blue	—	53332-08CPS	—	—	53963-09CPS	—
Deep Cobalt	Light Cobalt	—	53332-06BYC	—	—	—	—
Fire Red Pearl	Medium Silver	—	53332-06BXZ	53274-06BXZ	—	—	—
Flame Blue Pearl	Process Blue	—	—	—	—	53963-09CWB	—
Glacier White Pearl	Medium Silver/Medium Silver	—	53332-06BJG	—	—	—	—
Pacific Blue Pearl	Medium Silver/Medium Silver	—	—	53274-07CHC	—	—	—
Red Hot Sunglo	Pale Gold/Medium Red	—	—	—	—	53963-09CYT	—
Rich Sunglo Blue	Lunar Blue	—	—	53274-06BPT	—	—	—
Vivid Black	Medium Silver/Medium Silver	—	53332-06BHY	53274-06BHY	—	53963-09BHY	—
White Gold Pearl	Bright Gold	—	53332-07CGX	—	—	—	—
<b>Solid Color/Panel</b>	<b>Inner/Outer Pinstripe</b>		<b>\$774.95</b>	<b>\$774.95</b>	<b>\$774.95</b>	<b>\$774.95</b>	
Black Cherry/Black Pearl	Burgundy/Medium Silver	—	53332-06BRB	—	—	—	—
Black Cherry Pearl/Pewter Pearl	Medium Red	—	53332-07CHD	—	—	—	—
Chopper Blue/Brilliant Silver	Blue/Burgundy	—	53332-06BPX	—	—	—	—
Copper Pearl/Vivid Black	Orange/Pale Gold	—	—	—	53270-08COR	—	—
Crimson Red Sunglo/Candy Red Sunglo	Red/Pale Gold	—	53332-08CPR	—	—	—	—
Fire Red Pearl/Black Pearl	Tan/Tomato Red	—	53332-07CHA	—	—	—	—
Fire Red Pearl/Vivid Black	Tomato Red	—	53332-06BYA	—	—	—	—
Flame Blue Pearl/Pewter Pearl	Process Blue/Medium Silver	—	—	—	—	53963-09CWC	—
Flame Blue Pearl/Brilliant Silver	Process Blue/Medium Silver	—	—	—	—	53963-10DCK	—
Olive Pearl/Vivid Black	Burgundy/Bright Gold	—	53332-07CGZ	—	—	—	—
Red Hot Sunglo/Smokey Gold	Medium Red/Pale Gold	—	—	—	—	53963-09CYV	—
Rich Sunglo Blue/Chopper Blue	Blue/Medium Silver	—	53332-06BPW	—	—	—	—
Scarlet Red/Vivid Black	Camo Tan	—	—	—	—	53963-10DBM	—
Suede Blue Pearl/Vivid Black	Tan/Dark Blue	—	53332-07CGY	—	—	—	—
White Gold Pearl/Pewter Pearl	Dark Blue/Medium Silver	—	53332-08CPY	—	—	53963-09CPY	—
<b>Solid Color/Panel</b>	<b>Inner/Outer Pinstripe</b>	<b>\$949.95</b>					<b>\$949.95</b>
Big Purple Flake/Brilliant Silver	—	—	—	—	—	—	79071-09CWS
Black Ice/Blue Ice	—	—	—	—	—	—	79071-09CWW
Centennial Gold Black & Burgundy	—	79103-03BFG	—	—	—	—	—
Light Candy Cherry/Dark Candy Cherry	—	53172-05BSB	—	—	—	—	—
Light Candy Root Beer/Dark Candy Root Beer	—	—	—	—	—	—	79071-09CWW
Merlot Sunglo/Cherry Red Sunglo	Amber Gold	—	—	—	—	—	79071-10DCF
Sunrise Yellow Pearl/Stingray Silver	—	53172-05BSE	—	—	—	—	—
White Ice Pearl/Black Ice Pearl	Camo Tan/Light Purple	—	—	—	—	—	79071-10DBW
<b>Solid Color/Panel</b>	<b>Inner/Outer Pinstripe</b>						<b>\$1,199.95</b>
Candy Concord	—	—	—	—	—	—	79071-10DEH
Spiced Rum	—	—	—	—	—	—	79071-10DEK
Tequila Sunrise	—	—	—	—	—	—	79071-10DEM

Notice: The prices appearing in this catalog are the manufacturer's suggested retail prices. Actual retail prices may vary.

# 386 TOURING

Tour-Pak® Luggage

## ROAD GLIDE® TOUR-PAK® LUGGAGE

Turn your Road Glide model into a complete cross-country touring machine. Available in both Classic and Ultra versions, these King Tour-Pak luggage systems are Color-Matched to Road Glide solid color, solid color with pinstripes, and two-tone factory paint finishes. Tour-Pak is pre-drilled for locking hardware and passenger backrest (*sold separately*). Tour-Pak mounting racks are sold separately. Dimensions: 22" W x 16" L x 11" H. Capacity: 3850 cubic inches.

**Road Glide Classic Tour-Pak** features pre-mounted antenna base.

**Road Glide Ultra Tour-Pak** is pre-drilled for rear speaker boxes. Ultra Tour-Pak includes radio antenna base, CB antenna base and loading coil, side marker lights, and wrap-around tail lamp assembly.



**COLOR-MATCHED TOUR-PAK® LUGGAGE FOR ROAD GLIDE® MODELS – ULTRA STYLE SHOWN  
(SHOWN WITH TOUR-PAK MOUNTING KIT AND BACKREST PAD)**

### ROAD GLIDE® TOUR-PAK®

Solid Color/Panel	Pinstripe	Road Glide King		Road Glide Ultra	
		Fits '98-'05 models		Fits '98-'05 models	
Sterling Silver	—	53155-03BDP	<del>\$749.95</del>	—	—
Black Cherry/Brilliant Silver	Medium Silver	53155-05BRE	<del>\$774.95</del>	53217-05BRE	\$949.95
Black Pearl/Brilliant Silver	Medium Silver	53155-05BRF	<del>\$774.95</del>	53217-05BRF	\$949.95
Chopper Blue/Brilliant Silver	Medium Silver	53155-05BRH	<del>\$774.95</del>	—	—
Concord Purple	Medium Silver	53155-02BBY	<del>\$749.95</del>	—	—
Diamond Ice	Burgundy	53155-01XU	\$749.95	—	—
Impact Blue/Brilliant Silver	Medium Silver	53155-04BKE	<del>\$774.95</del>	—	—
Jade Sunglo	Medium Silver	53155-01XV	\$749.95	—	—
Luxury Rich Red Pearl	Red	53155-00EF	\$724.95	53217-00EF	\$924.95
Luxury Teal/Brilliant Silver	Medium Silver	53155-04BKC	<del>\$774.95</del>	—	—
Sierra Red/Brilliant Silver	Medium Silver	53155-04BKB	\$774.95	53217-04BKB	\$949.95
Smokey Gold/Brilliant Silver	Medium Silver	53155-04BKD	<del>\$774.95</del>	53217-04BKD	\$949.95
Vivid Black	Burgundy	53155-99AB	<del>\$724.95</del>	53217-99AB	\$924.95
Vivid Black/Brilliant Silver	Medium Silver	53155-04BKA	<del>\$724.95</del>	53217-04BKA	\$949.95
Yellow Pearl/Brilliant Silver	Medium Silver	53155-05BRG	<del>\$774.95</del>	53217-05BRG	\$949.95
Solid Color	Pinstripe	Fits '06-'08 models		Fits '06-'08 models	
Black Cherry	—	53325-07BPS	\$724.95	53287-07BPS	\$899.95
Black Pearl	—	53325-07BPY	\$724.95	53287-07BPY	\$899.95
Candy Red Sunglo	—	53325-08CPF	\$724.95	53287-08CPF	\$899.95
Copper Pearl	—	53325-08COR	\$724.95	53287-08COR	\$899.95
Crimson Red Denim	—	53325-08CPD	\$724.95	53287-08CPD	\$899.95
Crimson Red Sunglo	—	53325-08COZ	\$724.95	53287-08COZ	\$899.95
Dark Blue Pearl	—	53325-08CPC	\$724.95	53287-08CPC	\$899.95
Deep Cobalt	—	53325-07BXT	\$724.95	53287-07BXT	\$899.95

Notice: The prices appearing in this catalog are the manufacturer's suggested retail prices. Actual retail prices may vary.





Classic Tour-Pak® '06-'08  
Two-Tone with Pinstripe



Classic Tour-Pak® '98-'05  
Solid Color with Pinstripe



Classic Tour-Pak® '98-'05  
Two-Tone with Pinstripe



Ultra Tour-Pak® '06-'08  
Two-Tone with Pinstripe



Ultra Tour-Pak® '98-'05  
Two-Tone with Pinstripe



Ultra Tour-Pak® '98-'05  
Solid Color with Pinstripe

#### ROAD GLIDE® TOUR-PAK®

Solid Color/Panel	Pinstripe	Road Glide King		Road Glide Ultra	
		Fits '06-'08 models		Fits '06-'08 models	
Fire Red Pearl	—	53325-07BXY	\$724.95	53287-07BXY	\$899.95
Mirage Orange Pearl	—	53325-07BNR	\$724.95	53287-07BNR	\$899.95
Pacific Blue Pearl	—	53325-07CGP	\$724.95	53287-07CGP	\$899.95
Pewter Pearl	—	53325-07CGR	\$724.95	53287-07CGR	\$899.95
Vivid Black	—	53325-07DH	\$724.95	53287-07DH	\$899.95
Yellow Pearl	—	53325-07BPZ	\$724.95	53287-07BPZ	\$899.95
Black Cherry/Brilliant Silver	Burgundy	53325-06BZE	\$774.95	53287-06BZE	\$949.95
Black Pearl/Brilliant Silver	Burgundy	53325-06BZF	\$774.95	53287-06BZF	\$949.95
Brilliant Silver/Vivid Black	Medium Silver	53325-06BZD	\$774.95	53287-06BZD	\$949.95
Chopper Blue/Vivid Black	Blue	53325-06BZG	\$774.95	53287-06BZG	\$949.95
Copper Pearl/Vivid Black	Orange/Pale Gold	53325-08COR	\$774.95	53287-08COR	\$949.95
Deep Cobalt/Brilliant Silver	Medium Silver	53325-06BZJ	\$774.95	53287-06BZJ	\$949.95
Fire Red Pearl/Vivid Black	Burgundy	53325-06BZH	\$774.95	53287-06BZH	\$949.95
Vivid Black/Brilliant Silver	Medium Silver	53325-06BKA	\$774.95	53287-06BKA	\$949.95
Yellow Pearl/Vivid Black	Orange	53325-06BZK	\$774.95	53287-06BZK	\$949.95
Solid Color/Panel Single	Pinstripe	Fits '09-later models		Fits '09-later models	
Black Denim	Medium Red	79071-10DBN	\$749.95	—	—
Black Pearl	—	79224-09BPY	\$724.95	53287-09BPY	\$899.95
Dark Blue Pearl	—	79224-09CPC	\$724.95	53287-09CPC	\$899.95
Electric Orange	—	79224-09CFZ	\$1,199.95	—	—
Mirage Orange Pearl	—	79224-09BNR	\$724.95	53287-09BNR	\$899.95
Red Hot Denim	—	79224-09CYE	\$724.95	53287-09CYE	\$899.95
Red Hot Sunglo	—	79224-09CYS	\$724.95	53287-09CYS	\$899.95
Scarlet Red	Medium Red	79071-10DBO	\$749.95	—	—
Stardust Silver	—	79224-09CZB	\$1,199.95	—	—
Vivid Black	Medium Silver	79071-10DBX	\$749.95	—	—
Vivid Black	—	79224-09DH	\$724.95	53287-09DH	\$899.95
Yellow Pearl	—	79224-09BKR	\$1,199.95	—	—

Notice: The prices appearing in this catalog are the manufacturer's suggested retail prices. Actual retail prices may vary.

# 388 TOURING

Tour-Pak® Luggage

## A. RAZOR-PAK BACKREST PAD – SMOOTH

Clean, smooth styling complements most seating surfaces.

**79192-10** **\$129.95**

Fits models equipped with Razor-Pak luggage.

## B. CHOPPED TOUR-PAK® BACKREST PAD – SMOOTH

Clean, smooth styling complements most seating surfaces.

**52898-98A** **\$149.95**

Fits models equipped with Chopped Tour-Pak luggage.

## C. CHOPPED TOUR-PAK® BACKREST PAD – STUDED

Add passenger comfort to the unique, chopped Tour-Pak® luggage components. Matches '94-later stock and touring seats with black spots.

**52032-96** **\$149.95**

Fits models equipped with Chopped Tour-Pak luggage.

## D. CHOPPED TOUR-PAK BACKREST PAD – PILLOW-LOOK

Add passenger comfort to the unique, chopped Tour-Pak luggage. Matches stock and accessory Pillow-Look seats.

**52031-96** **\$149.95**

Fits models equipped with Chopped Tour-Pak luggage.

## E. CHOPPED TOUR-PAK BACKREST PAD – STREET GLIDE® STYLING

Styled to match the Street Glide Original Equipment or Sundowner™ seat.

**51635-06** **\$199.95**

Fits models equipped with Chopped Tour-Pak luggage.

## F. CHOPPED TOUR-PAK BACKREST PAD – CUSTOM VEHICLE OPERATIONS ROAD GLIDE® STYLING

Matches '09 CVO Road Glide Original Equipment seat with buffalo leather inlay.

**52621-09** **\$229.95**

Fits models equipped with Chopped Tour-Pak luggage.



A. RAZOR-PAK BACKREST PAD – SMOOTH



B. CHOPPED TOUR-PAK BACKREST PAD – SMOOTH



C. CHOPPED TOUR-PAK BACKREST PAD – STUDED



D. CHOPPED TOUR-PAK BACKREST PAD – PILLOW-LOOK



E. CHOPPED TOUR-PAK BACKREST PAD – STREET GLIDE STYLING



F. CHOPPED TOUR-PAK BACKREST PAD – CVO ROAD GLIDE STYLING

Notice: The prices appearing in this catalog are the manufacturer's suggested retail prices. Actual retail prices may vary.

# TOURING 389

*Tour-Pak® Luggage*



**G**

**G. KING TOUR-PAK BACKREST PAD – ROAD KING STYLING**



**H**

**H. KING TOUR-PAK BACKREST PAD – STREET GLIDE STYLING**

**G. KING TOUR-PAK® BACKREST PAD – ROAD KING® STYLING**

Embroidered "Road King" logo and smooth look matches your stock FLHR seat.

**52274-94A** **\$199.95**

Fits '94-later Touring and Trike models equipped with King Tour-Pak luggage.

**H. KING TOUR-PAK BACKREST PAD – STREET GLIDE® STYLING**

Styled to match the Street Glide Original Equipment or Sundowner seat.

**51634-06** **\$229.95**

Fits '97-later Touring and Trike models equipped with King Tour-Pak luggage.

**I. KING TOUR-PAK® BACKREST PAD – COMFORT STITCH**

Styled to match the Comfort Stitch Touring Seat series.

**52395-03** **\$199.95**

Fits '97-later Touring and Trike models equipped with King Tour-Pak luggage.

**J. KING TOUR-PAK® BACKREST PAD – SMOOTH**

Clean, smooth styling complements most seating surfaces.

**52892-98A** **\$199.95**

Fits '97-later Touring and Trike models equipped with King Tour-Pak luggage.

**K. KING TOUR-PAK BACKREST PAD – LEATHER ROAD ZEPPELIN®**

**52335-97** **\$279.95**

Fits '97-later Touring and Trike models equipped with King Tour-Pak luggage.

**L. KING TOUR-PAK BACKREST PAD – PILLOW-LOOK**

Styled to match Original Equipment and accessory Pillow-Look Seats.

**52201-97A** **\$199.95**

Fits '97-later Touring and Trike models equipped with King Tour-Pak luggage.

**52201-86B** **\$299.95**

Fits '96-earlier FLHT models with King Tour-Pak luggage.

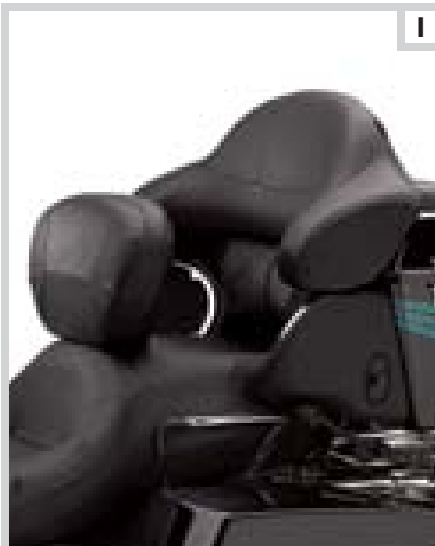

**I**

**I. KING TOUR-PAK BACKREST PAD – COMFORT STITCH**



**J**

**J. KING TOUR-PAK BACKREST PAD – SMOOTH**



**K**

**K. KING TOUR-PAK BACKREST PAD – LEATHER ROAD ZEPPELIN**



**L**

**L. KING TOUR-PAK BACKREST PAD – PILLOW-LOOK**

TOURING

*Notice: The prices appearing in this catalog are the manufacturer's suggested retail prices. Actual retail prices may vary.*

# 390 TOURING

Tour-Pak® & Saddlebag Accessories

## A. COLOR-MATCHED TOUR-PAK® SPOILER KIT\*

The combination of contoured styling and the practicality of an integrated auxiliary LED running/brake light blend form and function into the Tour-Pak Spoiler. Designed for easy installation, the Tour-Pak Spoiler works well with Tour-Pak Mounted Luggage Racks. Electrical connection is a breeze on '94-later models with simple plug-in connection. Kit includes all necessary hardware and template.

Fits models with King, Chopped or Razor-Pak Tour-Pak Luggage.

## B. COLOR-MATCHED SADDLEBAG LID SPOILER KIT\*

Complement the styling of the Tour-Pak® Spoiler Kit with these Saddlebag Lid Spoilers. Integrated, auxiliary LED running/brake lights are a simple plug-in connection for '94-later models. Includes a pair of spoilers and lights, mounting hardware and installation template, and can be installed on models equipped with Saddlebag Lid Rails.

Fits '93-later Touring models with Color-Matched Hard Saddlebags.

Also available:

### LED REPLACEMENT LIGHT KITS

<b>68160-99</b>	Tour-Pak Spoiler.	<b>\$64.95</b>
<b>68192-99</b>	Saddlebag Spoiler.	<b>\$43.68</b>



**A. COLOR-MATCHED TOUR-PAK SPOILER KIT**



**B. COLOR-MATCHED SADDLEBAG LID SPOILER KIT**

Color	A. TOUR-PAK SPOILER KIT		B. SADDLEBAG LID SPOILER KIT	
Primed	53149-99	\$204.95	58606-99	\$174.95
Anniversary Copper Pearl	53149-08CPH	\$229.95	58606-08CPH	\$199.95
Arctic White	53149-06GY	\$229.95	58606-06GY	\$199.95
Autumn Haze	—	—	58606-06BYW	\$199.95
Big Purple Flake	53149-09CWR	\$229.95	58606-09CWR	\$199.95
Black Cherry	53149-05BPS	\$229.95	58606-05BPS	\$199.95
Black Candy Crimson	—	—	58606-06BYY	\$199.95
Black Emerald	—	—	58606-06BYS	\$199.95
Black Ice (CVO)	—	—	58606-07CKF	\$199.95
Black Ice	53149-09CWL	\$229.95	58606-09CWL	\$199.95
Black Ice Denim	53149-10DBP	\$229.95	58606-10DBP	\$199.95
Black Pearl	53149-05BPY	\$229.95	58606-05BPY	\$199.95
Brandy Wine Sunglo	53149-06BYF	\$229.95	58606-06BYF	\$199.95
Brilliant Silver	53149-04BHT	\$229.95	58606-04BHT	\$199.95
Burgundy	53149-07CJA	\$229.95	58606-07CJA	\$199.95
Burnt Amber	53149-10DEC	\$229.95	58606-10DEC	\$199.95
Candy Concord	53149-10DEH	\$229.95	58606-10DEH	\$199.95
Candy Red Sunglo	53149-08CPF	\$229.95	58606-08CPF	\$199.95
Canyon Copper	53149-08CAS	\$229.95	58606-08CAS	\$199.95
Copperhead Pearl	53149-08CPL	\$229.95	58606-08CPL	\$199.95
Crimson Mist Black	53149-10DEF	\$229.95	58606-10DEF	\$199.95
Crimson Red Denim	53149-08CPD	\$229.95	58606-08CPD	\$199.95
Crimson Red Sunglo	53149-08COZ	\$229.95	58606-08COZ	\$199.95
Crystal Copper	53149-08CRR	\$229.95	58606-08CRR	\$199.95
Dark Blue Denim	53149-08CPG	\$229.95	58606-08CPG	\$199.95
Dark Blue Pearl	53149-08CPC	\$229.95	58606-08CPC	\$199.95
Dark Green Envy	53149-07CHZ	\$229.95	58606-07CHZ	\$199.95
Deep Cobalt Pearl	53149-06BXT	\$229.95	58606-06BXT	\$199.95
Deep Turquoise	53149-09CWN	\$229.95	58606-09CWN	\$199.95
Dragon Fly Green	53149-06CAX	\$229.95	58606-06CAX	\$199.95
Electric Orange	53149-09CFZ	\$229.95	58606-09CFZ	\$199.95
Fire Fighter Red	53149-05BRK	\$229.95	58606-05BRK	\$199.95
Fire Red Pearl	53149-06BXY	\$229.95	58606-06BXY	\$199.95
Flame Blue Candy	53149-10DGN	\$229.95	58606-10DGN	\$199.95

Color	A. TOUR-PAK SPOILER KIT		B. SADDLEBAG LID SPOILER KIT	
Flame Blue Pearl	53149-09CWA	\$229.95	58606-09CWA	\$199.95
Glacier White Pearl	53149-04BHX	\$229.95	58606-04BHX	\$199.95
Golden Glow	53149-08CJP	\$229.95	58606-08CJP	\$199.95
Jake Blue	53149-07CHY	\$229.95	58606-07CHY	\$199.95
Light Candy Cherry ('07 CVO)	—	—	58606-07BSC	\$199.95
Light Candy Root Beer	53149-09CWT	\$229.95	58606-09CWT	\$199.95
Lightning Blue Pearl	—	—	58606-07CJX	\$199.95
Merlot Sunglo	53149-10DCE	\$229.95	58606-10DCE	\$199.95
Olive Pearl	53149-07CGV	\$229.95	58606-07CGV	\$199.95
Orange Pearl	53149-04BNR	\$229.95	58606-04BNR	\$199.95
Pacific Blue Denim	53149-07CHG	\$229.95	58606-07CHG	\$199.95
Pacific Blue Pearl	53149-07CGP	\$229.95	58606-07CGP	\$199.95
Peace Officer Blue	53149-03TQ	\$229.95	58606-03TQ	\$199.95
Pewter Denim	53149-07CHH	\$229.95	58606-07CHH	\$199.95
Pewter Pearl	53149-07CGR	\$229.95	58606-07CGR	\$199.95
Purple Haze	53149-08CPK	\$229.95	58606-08CPK	\$199.95
Red Hot Denim	53149-09CYE	\$229.95	58606-09CYE	\$199.95
Red Hot Sunglo	53149-09CYS	\$229.95	58606-09CYS	\$199.95
Rich Sunglo Blue	53149-05BPV	\$229.95	58606-05BPV	\$199.95
Riptide Blue	53149-10DDZ	\$229.95	58606-10DDZ	\$199.95
Ruby Red	53149-09DAA	\$229.95	58606-09DAA	\$199.95
Scarlet Red ('03)	53149-03LZ	\$229.95	58606-03LZ	\$199.95
Scarlet Red ('10)	53149-10DBJ	\$229.95	58606-10DBJ	\$199.95
Scarlet Red (CVO)	53149-10BZN	\$229.95	58606-10BZN	\$199.95
Spiced Rum	53149-10DEK	\$229.95	58606-10DEK	\$199.95
Stardust Silver	53149-09CZB	\$229.95	58606-09CZB	\$199.95
Suede Blue Pearl	53149-07CGT	\$229.95	58606-07CGT	\$199.95
Tequila Sunrise	53149-10DEM	\$229.95	58606-10DEM	\$199.95
Vivid Black	53149-99DH	\$229.95	58606-99DH	\$199.95
White Frost	53149-08CTF	\$229.95	58606-08CTF	\$199.95
White Gold Pearl	53149-07CGS	\$229.95	58606-07CGS	\$199.95
White Ice Pearl	53149-10DBV	\$229.95	58606-10DBV	\$199.95
Yellow Pearl ('05-'07)	53149-05BPZ	\$229.95	58606-05BPZ	\$199.95
Yellow Pearl ('09 CVO)	53149-09BKR	\$229.95	58606-09BKR	\$199.95

\*NOTE: This product is a "Paint to Order" accessory. Please allow for an average of 5 weeks delivery for this item.

Notice: The prices appearing in this catalog are the manufacturer's suggested retail prices. Actual retail prices may vary.





C



C

**C. SADDLEBAG FILLER STRIP KIT – COLOR-MATCHED, VIVID BLACK ('09 SHOWN)**

**C. SADDLEBAG FILLER STRIP KIT – COLOR-MATCHED, VIVID BLACK, SLOTTED ('09 SHOWN)**

**C. COLOR-MATCHED SADDLEBAG FILLER STRIP KITS\***

For those who seek perfection, these kits fill in the gaps between the fender and the rear of the saddlebags, hiding the saddlebag mounting bracket. Choose between subtle black, highly polished chrome, or Color-Matched to your sheet metal and bags for a truly custom look.

Available to fit:

**Solid**

Fits '09-later FLHT and FLHR models.

**Solid**

Fits '93-'08 Electra Glide® (except FLHX) models, '94-'08 FLHR models (except FLHRCI with rear docking kit and FLHRS) and '93 FLHS models. (Will not fit models equipped with Nostalgic and Triple Rail Saddlebag Guard Rails or chrome Saddlebag Guard Kit P/Ns 90839-93A, 91216-97; Electra Glo™ Light Rails; Leather Saddlebags P/Ns 90652-94A, 90843-93; or with Fender Rail P/N 91019-92A. Does not fit '98-'08 FLTR.)

**Slotted**

Fits '09-later FLHT, FLHTC, FLHTCU, FLHTK and FLHR models equipped with Nostalgic Saddlebag Rail P/N 91286-09.

**Slotted**

Fits '95-'08 Electra Glide (except FLHX), '94-'08 FLHR (except FLHRS) and '93 FLHS models equipped with Nostalgic Saddlebag Guard Rails P/N 90839-94; fits '98 FLHRCI with Nostalgic Saddlebag Guard Rails P/N 91 265-98. (Will not fit above models equipped with saddlebags P/Ns 90652-94, 90843-93 or Fender Rail P/N 91019-92A. Will not fit '98-'08 FLHRCI with Rear Detachable Docking Kit or '98-'08 FLTR.)

**45896-98** Chrome. **\$99.95**

\*NOTE: This product is a "Paint to Order" accessory. Please allow for an average of 5 weeks delivery for this item.

**C. SADDLEBAG FILLER STRIP KITS**

Color	Solid – '93-'08		Solid – '09-later		Slotted – '09-later	
Chrome	45898-98	\$99.95	91422-09	\$169.95	91670-09	\$169.95
Prime	45898-10BEO	\$119.95	91614-10BEO	\$119.95	91741-10BEO	\$119.95
Black Cherry	45898-06BPS	\$169.95	—	—	—	—
Black Denim	—	—	91614-09BYM	\$169.95	91741-09BYM	\$169.95
Black Pearl	45898-06BPY	\$169.95	91614-09BPY	\$169.95	91741-09BPY	\$169.95
Brandy Wine Sunglo	45898-06BYF	\$169.95	—	—	—	—
Brilliant Silver	45898-08BHT	\$169.95	—	—	—	—
Brilliant Silver Pearl	—	—	—	—	91741-10BHT	\$169.95
Burgundy	45898-07CJA	\$169.95	—	—	—	—
Candy Red Sunglo	45898-08CPF	\$169.95	—	—	—	—
Chopper Blue	45898-06BPO	\$169.95	—	—	—	—
Copperhead Pearl	45898-08CPL	\$169.95	—	—	—	—
Copper Pearl	45898-08CPH	\$169.95	—	—	—	—
Crimson Red Sunglo	45898-08COZ	\$169.95	—	—	—	—
Dark Blue Pearl	45898-08CPC	\$169.95	91614-09CPC	\$169.95	91741-09CPC	\$169.95
Dark Green Envy	45898-07CHZ	\$169.95	—	—	—	—
Deep Cobalt Pearl	45898-06BXT	\$169.95	—	—	—	—
Fire Red Pearl	45898-06BXY	\$169.95	—	—	—	—
Flame Blue Pearl	—	—	91614-09CWA	\$169.95	91741-09CWA	\$169.95
Glacier White Pearl	45898-06BHX	\$169.95	—	—	—	—
Golden Glow	45898-08CPJ	\$169.95	—	—	—	—
Gunmetal Pearl	45898-07BDT	\$169.95	—	—	—	—
Jake Blue	45898-07CHY	\$169.95	—	—	—	—
Jet Black	45898-06BKL	\$169.95	—	—	—	—
Lava Red Sunglo	45898-06BJK	\$169.95	—	—	—	—
Luxury Blue	45898-06XE	\$169.95	—	—	—	—
Luxury Rich Red	45898-06ZQ	\$169.95	—	—	—	—
Luxury Teal	45898-06BHV	\$169.95	—	—	—	—
Merlot Sunglo	—	—	91614-10DCE	\$169.95	91741-10DCE	\$169.95
Olive Pearl	45898-07CGV	\$169.95	—	—	—	—
Pacific Blue Pearl	45898-07CGP	\$169.95	—	—	—	—
Pewter Pearl	45898-07CGR	\$169.95	91614-09CGR	\$169.95	91741-09CGR	\$169.95
Purple Haze	45898-08CPK	\$169.95	—	—	—	—
Red Hot Sunglo	—	—	91614-09CYS	\$169.95	91741-09CYS	\$169.95
Rich Sunglo Blue	45898-06BPV	\$169.95	—	—	—	—
Scarlet Red	—	—	91614-10DBJ	\$169.95	91741-10DBJ	\$169.95
Sierra Red	45898-06BHS	\$169.95	—	—	—	—
Smokey Gold	45898-06BJL	\$169.95	—	—	—	—
Sterling Silver	45898-07BDP	\$169.95	—	—	—	—
Suede Blue Pearl	45898-07CGT	\$169.95	—	—	—	—
Vivid Black	45898-08DH	\$169.95	91614-09DH	\$169.95	91741-09DH	\$169.95
White Gold Pearl	45898-07CGS	\$169.95	91614-09CGS	\$169.95	91741-09CGS	\$169.95
White Ice Pearl.	—	—	91614-10DBV	\$169.95	91741-10DBV	\$169.95
White Pearl.	45898-06ZB	\$169.95	—	—	—	—

# 392 TOURING

Tour-Pak® & Saddlebag Accessories

## A. COLOR-MATCHED STRETCHED SADDLEBAG BOTTOMS\*

Add the long and low “slammed” look to your Touring bike without compromising the suspension travel and ride height. These Stretched Saddlebag Bottoms wrap around the exhaust to add visual length to the bike, and hide the muffler bracket and hanger from view. The full-depth extended Saddlebag Bottoms add additional storage capacity, and are manufactured of the same materials as the latest Original Equipment saddlebags for a glass-smooth painted surface. Available primed or factory-finished to match your Original Equipment single-color painted finish, these Stretched Bottoms are pre-drilled to accept your existing saddlebag lids and latches. Simply attach the extended saddlebag bottom to your saddlebag lids with the included hardware, and install on the bike like the original bags.

Fits '93-later Touring models equipped with Color-Matched Hard Saddlebags.

<b>92003-10BDK</b>	Prime.	<b>\$1,099.95</b>
<b>92003-10BHT</b>	Brilliant Silver.	<b>\$1,299.95</b>
<b>92003-10BPS</b>	Black Cherry Pearl.	<b>\$1,299.95</b>
<b>92003-10BYM</b>	Black Denim.	<b>\$1,299.95</b>
<b>92003-10BPY</b>	Black Pearl.	<b>\$1,299.95</b>
<b>92003-10CPF</b>	Candy Red Sunglo.	<b>\$1,299.95</b>
<b>92003-10CPD</b>	Crimson Red Denim.	<b>\$1,299.95</b>
<b>92003-10COZ</b>	Crimson Red Sunglo.	<b>\$1,299.95</b>
<b>92003-10CPG</b>	Dark Blue Denim.	<b>\$1,299.95</b>
<b>92003-10CPC</b>	Dark Blue Pearl.	<b>\$1,299.95</b>
<b>92003-10BXT</b>	Deep Cobalt Pearl.	<b>\$1,299.95</b>
<b>92003-10BXY</b>	Fire Red Pearl.	<b>\$1,299.95</b>
<b>92003-10CWA</b>	Flame Blue Pearl.	<b>\$1,299.95</b>
<b>92003-10DCE</b>	Merlot Sunglo.	<b>\$1,299.95</b>
<b>92003-10BNR</b>	Mirage Orange Pearl.	<b>\$1,299.95</b>
<b>92003-10CGV</b>	Olive Pearl.	<b>\$1,299.95</b>
<b>92003-10CHG</b>	Pacific Blue Denim.	<b>\$1,299.95</b>
<b>92003-10CGP</b>	Pacific Blue Pearl.	<b>\$1,299.95</b>
<b>92003-10CHH</b>	Pewter Denim.	<b>\$1,299.95</b>
<b>92003-10CGR</b>	Pewter Pearl.	<b>\$1,299.95</b>
<b>92003-10CYE</b>	Red Hot Denim.	<b>\$1,299.95</b>
<b>92003-10CYS</b>	Red Hot Sunglo.	<b>\$1,299.95</b>
<b>92003-10DBJ</b>	Scarlet Red.	<b>\$1,299.95</b>
<b>92003-10CGT</b>	Suede Blue Pearl.	<b>\$1,299.95</b>
<b>92003-10DH</b>	Vivid Black.	<b>\$1,299.95</b>
<b>92003-10CGS</b>	White Gold Pearl.	<b>\$1,299.95</b>
<b>92003-10DBV</b>	White Ice Pearl.	<b>\$1,299.95</b>
<b>92003-10BPZ</b>	Yellow Pearl.	<b>\$1,299.95</b>

## B. SADDLEBAG EXTENSION KIT

Give your saddlebags the “tail dragger” look. Originally featured on the '09 CVO™ Road Glide®, these extensions visually stretch the saddlebags and wrap around the exhaust for a true “low rider” look. Manufactured from the same durable ABS material as the Original Equipment saddlebags, these primed extensions are ready to paint and attach to the saddlebag bottoms with the included fasteners and adhesive. No filler or re-painting of the Original Equipment bag is necessary. Finish the look with available Color-Matched Saddlebag Filler Strips (*sold separately*).

**90999-09** **\$299.95**

Fits '04-later Touring models equipped with Color-Matched Hard Saddlebags.



A. COLOR-MATCHED STRETCHED SADDLEBAG BOTTOMS



B. SADDLEBAG EXTENSION KIT

\*NOTE: This product is a “Paint to Order” accessory. Please allow for an average of 5 weeks delivery for this item.

Notice: The prices appearing in this catalog are the manufacturer's suggested retail prices. Actual retail prices may vary.



**C. PREMIUM TOUR-PAK HINGES**



**D. COLOR-MATCHED SADDLEBAG LATCH PLATE**



**E. CHROME BILLET SADDLEBAG LATCH KIT**



**F. FLAME BILLET SADDLEBAG LATCH KIT**

# TOURING 393

Tour-Pak® & Saddlebag Accessories

## C. PREMIUM TOUR-PAK® HINGES

Upgrade the appearance of your King Tour-Pak with these premium hinges. Stylized to complement the Original Equipment Tour-Pak latches, these hinges are polished and chrome-plated with no exposed hardware. Kit includes two hinges, and all necessary hardware. Drill required to remove the Original Equipment rivets.

**79211-08A** \$49.95  
Fits '88-later models equipped with Razor-Pak, Chopped or King Tour-Pak Luggage.

## D. COLOR-MATCHED SADDLEBAG LATCH PLATE

Color-Matched Saddlebag Latch Plates are an easy way to give your Touring bike a unique monochrome look. Available in Vivid Black or Primed finish, these latches add a splash of color to the motorcycle profile. Easy-to-install with Original Equipment hardware.

Fits '93-later Touring models equipped with Color-Matched Hard Saddlebags.

**91143-06BEO** Primed. (pair) \$84.95  
**90853-06DH** Vivid Black – Right Side. \$42.95  
**90857-06DH** Vivid Black – Left Side. \$42.95

## E. CHROME BILLET SADDLEBAG LATCH KIT

This sweep of chrome will set the tone for a very special Touring custom. Manufactured from 6061-T6 billet aluminum, this polished and plated latch replaces the Original Equipment saddlebag latch for a striking look. The "ball-milled" design and curved leading and trailing edge add a feeling of forward motion, even while parked on Main Street. Kit includes chrome-plated mounting hardware and saddlebag-mounted reflectors.

**90645-03A** \$129.95  
Fits '93-later Touring models equipped with hard saddlebags. HDI models require separate purchase of Reflector P/N 59289-92 and 59290-92.

## F. FLAME BILLET SADDLEBAG LATCH KIT

Styled to carry the "Flame" theme from front to back, this Flame Saddlebag Latch will get you noticed. The smooth black rubber insert is set into the brilliant chrome surface, defining the traditional "Hot Rod" flame pattern. The billet covers replace the Original Equipment latch covers, but retain the stock hinges and locks for easy installation. Kit includes chrome-plated mounting hardware and saddlebag-mounted reflectors.

**90690-04A** \$159.95  
Fits '93-later Touring models equipped with hard saddlebags. HDI models require separate purchase of Reflector P/N 59289-92 and 59290-92.

TOURING

Notice: The prices appearing in this catalog are the manufacturer's suggested retail prices. Actual retail prices may vary.

# 394 TOURING

Tour-Pak® & Saddlebag Racks

## A. AIR WING TOUR-PAK® LUGGAGE RACK\*

The low-profile aerodynamic styling of the Air Wing Tour-Pak Luggage Rack enhances the look of any Razor-Pak, Chopped or King Tour-Pak lid. The mirror-like chrome-plating draws your eye to the sleek lines, and the engraved Harley-Davidson script adds a signature finish. This full-sized rack protects both Tour-Pak lid and passenger backrest from scratches. Die-cast wing and lightweight steel tubing incorporate high-quality welded joints and the rack is hand-polished and chrome-plated using copper as a base coat followed by nickel and chrome to provide long-lasting beauty. Kit includes all necessary mounting hardware. For added visibility, add the available Air Wing Rack Light Kit P/N 68271-08 or 68250-08 (sold separately).

**79179-08** **\$179.95**

Fits King, Chopped and Razor-Pak Tour-Pak lids. Mounting hole pattern matches Premium Tour-Pak Luggage Rack P/N 53665-87.

## B. AIR WING RACK LED LIGHT KIT

Custom fit to the Air Wing Tour-Pak Rack, this fast-acting LED Light Kit operates as a supplemental rear running light and brake light. The high, center-mount position places the rear light in the line-of-sight of following vehicles, and the bright, fast-acting LED lamps get you noticed. Wiring is concealed inside the rack tubes for a clean, custom installation.

Fits models equipped with the Air Wing Tour-Pak Luggage Rack P/N 79179-08. Also fits FLHTCUSE4/5 models with Original Equipment Tour-Pak Rack.

**68271-08** Smoked Lens. **\$54.95**

**68250-08** Red Lens. **\$54.95**

## C. AIR WING SADDLEBAG LID RAIL KIT

The low-profile aerodynamic styling of the Air Wing Saddlebag Lid Rail enhances the look and protects the lid of your Color-Matched Hard Saddlebags. Mirror-chrome finished rails cascade down the front of the saddlebag to protect the paint from a misplaced boot heel, and the die-cast wing design at the rear complements the style of the Air Wing Luggage Rack. Kit includes all necessary mounting hardware. For added visibility, add the available Air Wing Light Kit P/N 68286-10 or 68388-10 (sold separately).

**88299-09** **\$129.95**

Fits '93-later Touring models with Color-Matched Hard Saddlebags. Does not fit models with leather covered bags or models equipped with Saddlebag Wing Tips P/N 53826-00B.

## D. AIR WING SADDLEBAG LID RAIL LED LIGHT KIT

Custom fit to the Air Wing Saddlebag Lid Rails, this fast-acting LED Light Kit operates as a supplemental rear running light and brake light. The high and outside mounting position places the lights in the line-of-sight of following vehicles, and the bright, fast-acting LED lamps get you noticed. Wiring is concealed inside the rack tubes for a clean, custom installation.

Fits models equipped with the Air Wing Saddlebag Lid Rails P/N 88299-09.

**68286-10** Smoked. **\$69.95**

**68388-10** Red. **\$69.95**

## E. CONTOURED TOUR-PAK LUGGAGE RACK\*

Designed to complement the contour of your Tour-Pak lid while adding luggage carrying capabilities. This highly polished and chrome-plated rack includes all necessary installation hardware.

**79148-06A** **\$149.95**

Fits King, Chopped and Razor-Pak Tour-Pak Luggage Systems (except '03 FLHTC or FLHTCUI 100th Anniversary Two-Tone and '00-'01 FLTRSEI models). Does not fit with Air Wing Tour-Pak Lid Trim P/N 53936-03, or Tour-Pak Accent Panel P/N 53911-01.



A. AIR WING TOUR-PAK LUGGAGE RACK



B. AIR WING RACK LED LIGHT KIT - SMOKED LENS



C. AIR WING SADDLEBAG LID RAIL KIT



D. AIR WING SADDLEBAG LID RAIL LED LIGHT KIT



E. CONTOURED TOUR-PAK LUGGAGE RACK



**\*WARNING:** Do not use this rack as a seat. Do not exceed the fender rack weight capacity. Using as seat or exceeding this capacity could cause handling problems which could result in loss of control and death or serious injury.



# TOURING 395

Tour-Pak® & Saddlebag Racks



**F. MINI TOUR-PAK LID RACK  
(SHOWN ON KING TOUR-PAK)**



**G. PREMIUM TOUR-PAK LUGGAGE RACK**



**H. TOURING SADDLEBAG LID RAILS**



**I. CLASSIC CHROME SADDLEBAG LID RAIL KIT**



**J. ULTRA CLASSIC TOUR-PAK CHROME ACCENT RAIL**

## F. MINI TOUR-PAK® LID RACK\*

Hand-polished, chrome-plated steel with a lot of attitude.

**53100-96** **\$99.95**

Fits King, Chopped and Razor-Pak Tour-Pak Luggage Systems (except '03 FLHTC or FLHTCUI 100th Anniversary Two-Tone and '00-'01 FLTRSEI models). Does not fit with Air Wing Tour-Pak Lid Trim P/N 53936-03, or Tour-Pak Accent Panel P/N 53911-01.

## G. PREMIUM TOUR-PAK® LUGGAGE RACK\*

This full-sized rack is especially designed to complement Tour-Pak lids with armrest-style passenger backrests. Protects both Tour-Pak lid and passenger backrest from scratches. Lightweight steel tubing incorporates high-quality welded joints and is hand-polished and chrome-plated using copper as a base coat followed by nickel and chrome to provide long-lasting beauty. Comes complete with all necessary mounting hardware.

**53665-87** **\$119.95**

Fits King, Chopped and Razor-Pak Tour-Pak lids.

## H. TOURING SADDLEBAG LID RAILS

This chrome-plated stepped rail design adds protection and style to Saddlebag Lids. Kit includes left and right trim lid rails, hardware and installation instructions. Made in the U.S.A.

**53640-96** **\$129.95**

Fits '93-later Touring models with Color-Matched Hard Saddlebags. Does not fit models with leather-covered bags or models equipped with Saddlebag Wing Tips P/N 53826-00B.

## I. CLASSIC CHROME SADDLEBAG LID RAIL KIT

Harley-Davidson designers have created these unique trim rails that wrap down the front of saddlebag covers and incorporate a stamped Classic nameplate. Helps protect saddlebag covers from scratches. Lightweight 1/2-inch steel tubing incorporates high-quality welded joints and is hand-polished and chrome-plated. Includes one pair of trim rails and all necessary mounting hardware.

**53670-93** **\$129.95**

Fits '93-later Touring models with Color-Matched Hard Saddlebags. Does not fit models with leather-covered bags or models equipped with Saddlebag Wing Tips P/N 53826-00B.

## J. ULTRA CLASSIC® TOUR-PAK® CHROME ACCENT RAIL

Fabricated from highly polished 1/2-inch steel tubing. Premium quality chrome-plating includes a copper base coat followed by nickel and chrome for long-lasting corrosion resistance and bright high-luster finish. Kit includes all necessary mounting hardware and installation instructions.

**53667-89A** **\$109.95**

Fits Ultra Classic® models (except '10 FLHTCUISE) and any King Tour-Pak equipped with King Tour-Pak Brake/Tail Lamp Kit P/N 68012-88E.



**\*WARNING:** Do not use this rack as a seat. Do not exceed the fender rack weight capacity. Using as seat or exceeding this capacity could cause handling problems which could result in loss of control and death or serious injury.

Notice: The prices appearing in this catalog are the manufacturer's suggested retail prices. Actual retail prices may vary.

# 396 TOURING

Tour-Pak® & Saddlebag Guards

## A. NOSTALGIC ROAD KING® CLASSIC SADDLEBAG GUARD RAILS

Accentuate the distinctive shape of Road King Classic saddlebags with these unique, contoured guard rails.

<b>91179-10</b>	Fits '10 FLHRC models.	<b>\$229.95</b>
<b>91179-09</b>	Fits '09 FLHRC models.	<b>\$229.95</b>
<b>91265-98A</b>	Fits '98-'08 FLHRC/I models only.	<b>\$229.95</b>

## B. NOSTALGIC SADDLEBAG GUARD RAILS

Road King model owners can forge a link with the Panhead era by easily bolting on these Nostalgic Saddlebag Guard Rails. Nostalgic twin tube design is manufactured of welded steel tubing and hand-polished with a sparkling chrome finish.

<b>91286-10</b>	Fits '10 FLHR, FLHT and FLHTK models.	<b>\$229.95</b>
<b>91286-09</b>	Fits '09 FLHR and FLHT models. Also fits FLTR models with separate purchase of Chrome Saddlebag Guard Kit P/N 49282-09B.	<b>\$229.95</b>
<b>90839-94A</b>	Fits '95-'08 FLHT standard, '94-'08 FLHR and '93 FLHS models. (Does not fit FLHX, FLHRC and FLHRS.)	<b>\$229.95</b>

## C. TWIN RAIL CHROME SADDLEBAG GUARD KIT

Each kit comes with rear saddlebag guards, side rails, mounting hardware, and instructions for easy installation.

<b>90892-09</b>	Fits '09-later FLHR, FLHT and FLTR models. Stock on '09-later FLHTC and FLHTCU models. FLTR models require separate purchase of Saddlebag Supports P/N 49194-09 and 90781-09, Nut P/N 7531 (Qty 2) and Antenna Mounting Bracket P/N 76516-09.	<b>\$319.95</b>
<b>91216-97</b>	Fits '97-'08 FLHT, FLHR, FLHTCUSE/2/3 and '98-'08 FLTR models. '04-'08 FLTR models require the separate purchase of Saddlebag Supports P/N 49194-85 and 90781-93, Nut P/N 7686 (Qty 2) and Screw P/N 3601 (Qty 2).	<b>\$319.95</b>



A. NOSTALGIC ROAD KING CLASSIC SADDLEBAG GUARD RAILS



B. NOSTALGIC SADDLEBAG GUARD RAILS



C. TWIN RAIL CHROME SADDLEBAG GUARD KIT

Notice: The prices appearing in this catalog are the manufacturer's suggested retail prices. Actual retail prices may vary.





D

D. SADDLEBAG SUPPORT KIT

**D. SADDLEBAG SUPPORT KIT**

Eliminate the rear saddlebag guard for a sleek, custom appearance. This kit replaces the loop saddlebag guard with a bolt-on chrome-plated support leg. Kit includes all necessary mounting hardware.

**90881-09A** **\$139.95**

Fits '09-later Touring models (except FLHRC, FLHTCUSE4/5 and Trike). Stock on '09-later FLHX, FLHXSE, FLTR, FLTRX and FLTRSE models. Does not fit with Saddlebag Filler Strip Kits.

**46565-04** **\$139.95**

Fits '97-'08 Touring (except FLHRC) models. Stock on FLHRS, FLHX and '04-'08 FLTR models.

**E. CHROME REAR SADDLEBAG GUARD KIT\***

Add protection and style to your ride. Complete kit replaces the under-saddlebag support found on Road King® Custom, Street Glide™ and Road Glide® models with loop-style saddlebag guards for a traditional look. Featured as Original Equipment on FLHR and FLHT models, these chrome-plated guards are shaped to accept Saddlebag Guard Bags (*sold separately*) for added storage. Kit includes left and right guards and all necessary mounting hardware.

**49282-09B** **\$189.95**

Fits '09-later FLHX, FLHXSE, FLTR, FLTRX and FLTRSE3 models.

**49291-07** **\$189.95**

Fits '04-'08 FLHRS, FLHX, FLTR and '05 FLHTCSE2 models.

**F. GLOSS BLACK REAR SADDLEBAG GUARD KIT\***

The classic Harley-Davidson® motorcycle color is black. It shows your attitude, your feelings and your desire to be different from the rest. These gloss black accessories are the ultimate extension of the Harley-Davidson philosophy. Manufactured from Original Equipment components, these parts provide superior fit and finish.

**49283-09** **\$189.95**

Fits '09-later Touring models (except Trike). FLHX, FLTR, FLTRX and FLTRSE3 models require separate purchase of Saddlebag Supports P/N 49194-09, 90781-09 and Nut P/N 7531 (Qty 2). FLHX, FLHXSE, FLTR and FLTRX models require separate purchase of Antenna Mounting Bracket P/N 76516-09.

**46548-03** **\$189.95**

Fits '97-'08 Touring models. ('04-'08 FLTR, FLHX and FLHRS models require the separate purchase of Saddlebag Supports P/Ns 49194-85 and 90781-93 and two P/Ns 3601 and 7686.)

**G. COMFORT PROFILE REAR SADDLEBAG GUARD KIT\***

The unique profile of these chrome-plated Rear Saddlebag Guards gives your passenger more leg room. A perfect replacement for the Original Equipment saddlebag guards.

**49179-09** **\$179.95**

Fits '09-later Touring models (except FLHTC, FLHTCU and Trike). FLHX, FLTR and FLTRSE3 models require separate purchase of Saddlebag Supports P/N 49194-09, 90781-09 and Nut P/N 7531 (Qty 2). FLHX, FLHXSE and FLTR models require separate purchase of Antenna Mounting Bracket P/N 76516-09. FLHRC models require separate purchase of reflectors P/N 59370-98 and 59371-98.

**49087-01** **\$179.95**

Fits '97-'08 FLHR, FLTR, FLHX and FLHT models. FLHRCI models require separate purchase of Reflector P/Ns 59370-98 and 59371-98. '04-'08 FLTR, FLHX and FLHRS models require separate purchase of Saddlebag Supports P/Ns 49194-85 and 90781-93 and two each of P/Ns 3601 and 7686. (Will not fit Saddlebag Guard Bags.)

**H. BILLET SADDLEBAG MOUNT BRACKET TRIM**

Give the rider following you something to look at. This chrome-plated "ball-milled" billet bracket replaces the mounting bolts between the lower saddlebag rail and the fender, for a clean, custom look. Kit includes 2 brackets and required hardware.

**91777-02** **\$59.95**

Fits '96-'08 Touring models (except FLHX). Does not fit with Saddlebag Guard Rails P/N 90839-04 or 91265-98, Filler Strip Kits P/N 45898-98, 45899-98, 45896-98 or 45897-98 or Active Exhaust Kit P/N 65467-05.



E

E. CHROME REAR SADDLEBAG GUARD KIT



F

F. GLOSS BLACK REAR SADDLEBAG GUARD KIT



G

G. COMFORT PROFILE REAR SADDLEBAG GUARD KIT



H

H. BILLET SADDLEBAG MOUNT BRACKET TRIM



**\*WARNING:** These guards may provide limited leg and cosmetic vehicle protection under unique circumstances (fall over while stopped, very low speed slide). They are not made nor intended to provide protection from bodily injury in a collision with another vehicle or any other object.

# 398 TOURING

Tour-Pak® & Saddlebag Trim

## A. SADDLEBAG GUARD RAIL INSERTS

These ribbed trim panels nest between the saddlebag guard rails for a gleaming chrome accent. Styled to complement the raised rib design of Harley-Davidson® front fender skirts, engine/transmission interface covers and passenger foot-board covers, the Guard Rail Inserts complete a fender-to-fender customizing statement. Kit includes all necessary mounting hardware.

**90251-09** **\$134.95**

Fits '09-later Electra Glide® Classic and Ultra Classic models and models equipped with Two Rail Saddlebag Guard Rails. Does not fit Trike models.

**90206-02** **\$134.95**

Fits '93-'08 Electra Glide® Classic and Ultra Classic®, '98-'08 Road Glide®, '93-'96 Tour Glide™ Ultra Classic, and '93-'08 Electra Glide Standard with Chrome Saddlebag Guard Kit P/N 90839-93A.

## B. SKULL SADDLEBAG GUARD RAIL INSERTS

These ribbed trim panels with a chrome skull medallion nest between the saddlebag guard rails for a gleaming chrome accent. Styled to complement the Skull Collection front fender skirts, the Guard Rail Inserts complete a fender-to-fender customizing statement. Kit includes all necessary mounting hardware.

**90255-09** **\$134.95**

Fits '09-later Electra Glide Classic and Ultra Classic models and models equipped with Two Rail Saddlebag Guard Rails. Does not fit Trike models.

**90214-05** **\$134.95**

Fits '93-'08 Electra Glide Classic and Ultra Classic, '98-'08 Road Glide, '93-'96 Tour Glide Ultra Classic, and '93-'08 Electra Glide Standard with Chrome Saddlebag Guard Kit P/N 90839-93A.

## C. CHROME TOUR-PAK® SPEAR TRIM KIT

These die-cast and chrome-plated trim spears add a sweeping slash of chrome to the Tour-Pak lid. These easy-to-install self-adhesive spears can also be used to cover the mounting holes when removing Tour-Pak Lid Rack P/N 53665-87 or 53101-96.

**53887-05** **\$39.95**

Fits '93-later Touring models with King, Chopped or Razor-Pak Tour-Pak Luggage.

## D. CHROME SADDLEBAG LID TRIM KIT

These die-cast and chrome-plated trim spears add a sweeping slash of chrome to the saddlebag lid. Kit includes left and right trim strips, gaskets, mounting hardware and installation template.

**53878-03** **\$79.95**

Fits '93-later Touring models equipped with Color-Matched hard saddlebags. Does not fit with Saddlebag Lid Rails, Lid Bra Kit P/N 57805-03, or previously installed Saddlebag Lid Organizer P/N 53548-02A.



A. SADDLEBAG GUARD RAIL INSERTS



B. SKULL SADDLEBAG GUARD RAIL INSERTS



C. CHROME TOUR-PAK SPEAR TRIM KIT



D. CHROME SADDLEBAG LID TRIM KIT

Notice: The prices appearing in this catalog are the manufacturer's suggested retail prices. Actual retail prices may vary.



# TOURING 399

Tour-Pak® & Saddlebag Trim



**E. ULTRA TOUR-PAK BRAKE LIGHT CHROME ACCENT COVERS**

## **E. ULTRA TOUR-PAK® BRAKE LIGHT CHROME ACCENT COVERS**

Kit includes a pair of triple chrome-plated steel brake lamp accents and a complementing chrome center trim piece that wraps any Ultra King Tour-Pak luggage.

**59239-93** **\$94.95**

Fits '89-later FLHTCU and FLHTCUTG models and other Touring models equipped with King Tour-Pak and Ultra Classic Brake Lamp Kit P/N 68012-88E. (Does not fit '10 FLHTK and FLHTCUSE.)

## **F. TOUR-PAK® SIDE LIGHT CHROME ACCENT COVERS**

Formed of triple chrome-plated steel, these easy-to-install accent covers add a touch of flash to your Tour-Pak side marker lights. Sold in pairs.

**59349-97** Fits '97-'05 King Tour-Pak Luggage. **\$64.95**

## **G. TOUR-PAK® CHROME AND SIMULATED LEATHER LID ACCENT PANEL**

Chrome and leather are the classic materials to dress your Harley motorcycle. And this Chrome and Simulated Leather Accent Panel is just the thing for customizing your Tour-Pak. The mirror-finish heavy chrome trim band with "Harley-Davidson" logo surrounds a field of black vinyl that fits the recess on your Tour-Pak lid. Includes installation hardware.

**53911-01** **\$59.95**

Fits '93-'05 Touring models equipped with King or Chopped Tour-Pak. (Does not fit with Mini Tour-Pak Lid Rack P/N 53100-96.) Will not fit with previously installed Tour-Pak Lid Organizer P/N 53249-01A.

## **H. SADDLEBAG WING TIPS**

This chrome-plated steel trim is an ideal way to customize your saddlebag lids, and to protect the leading edge from road debris. Mounting hardware included. Sold in pairs.

**53826-00B** **\$69.95**

Fits '93-later Touring models equipped with Color-Matched hard saddlebags. (Does not fit with Saddlebag Rails except P/N 53662-87T.)



**F. TOUR-PAK SIDE LIGHT CHROME ACCENT COVER**



**G. TOUR-PAK CHROME AND SIMULATED LEATHER LID ACCENT PANEL**



**H. SADDLEBAG WING TIP**

Notice: The prices appearing in this catalog are the manufacturer's suggested retail prices. Actual retail prices may vary.

# 400 TOURING

Tour-Pak® & Saddlebag Liners

## A. FITTED TOUR-PAK® LINER KITS

Line your Touring bike's luggage to protect your belongings and reduce noise and rattles on the road. Soft-touch felt-finish liner is formed to the interior for a perfect fit. Molded base and sides maximize the interior room, and one-piece design allows easy removal for cleaning and maintenance.

**53301-06** King Ultra Tour-Pak. **\$79.95**

Fits models equipped with King Tour-Pak Luggage with wrap-around Tail Lamp Kit. Does not fit '10 FLHTCUSE5, FLHTK or models with Tour-Pak bottom tub mounted accessories.

**53302-07** King Classic Tour-Pak. **\$79.95**

Fits models equipped with King Tour-Pak Luggage without wrap-around Tail Lamp Kit. Does not fit with Tour-Pak bottom tub mounted accessories.

**53285-06** Chopped Tour-Pak. **\$69.95**

Fits models equipped with Chopped Tour-Pak Luggage. Does not fit with Tour-Pak bottom tub mounted accessories.

## B. FITTED SADDLEBAG LINER KIT

Protect your belongings and reduce noise and rattles on the road. Soft-touch felt-finish liner is formed to the hard saddlebag interior for a perfect fit. Molded base and sides maximize the interior room, and one-piece design allows easy removal for cleaning and maintenance.

**92189-06** **\$149.95**

Fits '93-later Touring models equipped with Color-Matched hard saddlebags. Does not fit Police model saddlebags.

## C. FITTED GLOVE BOX LINER KIT

Protect your belongings and reduce noise and rattles on the road. Soft-touch felt-finish liner is formed to the fairing glove box interior for a perfect fit. Molded base and sides maximize the interior room, and one-piece design allows easy removal for cleaning and maintenance.

**58714-06** **\$29.95**

Fits Touring and Trike models equipped with Vented Fairing Lower.

## D. ROAD GLIDE® COMPARTMENT LINERS

Practical compartment liners, constructed of foam-backed material, are custom fit for the Road Glide model. Installs easily with included hook-and-loop tape.

**58932-98** **\$21.95**

Fits '98-later Road Glide models. (pair)

## E. ELECTRA GLIDE STANDARD FAIRING POUCH

Add additional storage in the radio opening of your FLHT fairing. This handy pouch is constructed of 600 denier water-resistant nylon. Easy-to-install with hook-and-loop fasteners for a convenient zippered compartment. Includes embroidered Bar & Shield logo.

**58313-96** **\$29.95**

Fits '96-later Electra Glide models without fairing mount radio.

## F. SADDLEBAG TOOL TETHER

A great way to bring along tools, spark plugs, and other small items, this unique Tool Tether replaces the saddlebag check strap. The hook-and-loop flaps lock the tools in place and help keep your saddlebag organized. Tools not included.

**53579-01** **\$29.95**

Fits '93-later Touring models equipped with Color-Matched hard saddlebags.



A. FITTED TOUR-PAK LINER KIT – KING CLASSIC SHOWN



B. FITTED SADDLEBAG LINER KIT



C. FITTED GLOVE BOX LINER KIT



D. ROAD GLIDE COMPARTMENT LINERS



E. ELECTRA GLIDE STANDARD FAIRING POUCH



F. SADDLEBAG TOOL TETHER

Notice: The prices appearing in this catalog are the manufacturer's suggested retail prices. Actual retail prices may vary.

# TOURING 401

Tour-Pak® & Saddlebag Liners



**G. TOUR-PAK WALL ORGANIZER**



**H. SADDLEBAG WALL ORGANIZER**



**I. TOUR-PAK LID ORGANIZER – KING TOUR-PAK**



**I. TOUR-PAK LID ORGANIZER – LEATHER TOUR-PAK**



**J. SADDLEBAG LID ORGANIZERS – COLOR-MATCHED HARD SADDLEBAGS**



**J. SADDLEBAG LID ORGANIZERS – LEATHER SADDLEBAGS**

## G. TOUR-PAK® WALL ORGANIZER

Convenient storage net wraps the interior walls of your King Tour-Pak for easy access to keys, cell phones, maps, and gloves. The organizer features three large nylon mesh pockets with hook-and-loop closures, two elastic pouches, and two open pouches for easy access. Easily installed with included hook-and-loop tabs.

**54014-05** **\$79.95**

Fits models equipped with Ultra or King Tour-Pak luggage. Does not fit with Chopped or Razor-Pak Tour-Pak.

## H. SADDLEBAG WALL ORGANIZER

Convenient storage net wraps the interior walls of your Color-Matched Saddlebags for easy access to keys, cell phones, maps, and gloves. The organizer features two open nylon mesh pockets, one pocket with a hook-and-loop closure, a pen, pencil and tire gauge holder, and a key holder. The easily installed organizer includes an embroidered "Harley-Davidson" script logo.

**88232-06** **\$49.95**

Fits Touring models equipped with hard saddlebags.

## I. TOUR-PAK® LID ORGANIZER

A true innovation in storage convenience and efficiency, this ingenious lid organizer helps keep smaller items conveniently located under your Tour-Pak lid for easy access. The organizer features five different-sized nylon-meshed pockets, as well as two flaps for additional storage. A great way to keep keys, cell phones, glasses, and papers handy.

**53249-01B** **\$89.95**

Fits models equipped with a King, Ultra, Chopped or Razor-Pak Tour-Pak. Does not fit '08-later CVO™ ULTRA models with Power Locks, or models equipped with Tour-Pak Spoiler Kit P/N 53149-series, Tour-Pak Light P/N 54302-98A, Mini Tour-Pak Lid Rack P/N 53100-96 or Contoured Tour-Pak Luggage Rack P/N 79148-06.

**54011-04** **\$89.95**

Fits models equipped with Leather or Synthetic Leather Tour-Pak Luggage (except P/N 79189-06). Does not fit with Tour-Pak Luggage Racks, Interior Light Kits or Lock Kits.

## J. SADDLEBAG LID ORGANIZERS

Convenient storage underneath the saddlebag lids with four easy access compartments for small items. Styled to match the Tour-Pak® Lid Organizer, these easy-to-install accessories include an embroidered "Harley-Davidson" script. (Sold in pairs.)

**53548-02A** **\$79.95**

Fits '93-later Touring models equipped with Color-Matched Hard Saddlebags. Does not fit with hard saddlebags on Police models, saddlebag lid rails and saddlebag lid trim kits.

**54008-04** **\$79.95**

Fits Touring models equipped with FLHRC saddlebags.

TOURING

Notice: The prices appearing in this catalog are the manufacturer's suggested retail prices. Actual retail prices may vary.

# 402 TOURING

Tour-Pak® & Saddlebag Liners

## A. TOUR-PAK® LID BRA

Protect your Razor-Pak, Chopped or King Tour-Pak luggage from scratches and road debris. The Tour-Pak Lid Bra is made with non-abrasive fleece-backed vinyl material and features an embroidered Bar & Shield logo. Easy-to-install with hook-and-loop tabs.

**57844-05** **\$79.95**

Fits models equipped with Razor-Pak, Chopped Tour-Pak and King Tour-Pak Luggage. Does not fit with Tour-Pak Lid Racks, Tour-Pak Lid Spoilers or Tour-Pak Interior Light Kits.

## B. SADDLEBAG LID BRA KIT

Protect your Original Equipment hard saddlebags from scratches and road debris. The Saddlebag Lid Bra is made with non-abrasive, fleece-backed vinyl material and features an embroidered Bar & Shield logo. Easy-to-install with hook-and-loop tabs. Kit includes left and right side Lid Bra.

**57805-03A** **\$89.95**

Fits '93-later Touring models with Color-Matched Hard Saddlebags. Does not fit with Police Model Hard Saddlebags, Saddlebag Lid Rails, Saddlebag Lid Spoilers, or Saddlebag Wing Tips.



A. TOUR-PAK LID BRA



B. SADDLEBAG LID BRA KIT

## C. PREMIER LINER FOR KING TOUR-PAK® LUGGAGE

High-quality, molded luggage fits perfectly inside the King Tour-Pak. Rigid, yet flexible design holds its shape for easy packing, and functions like traditional travel luggage on your journeys. Luggage features a durable carrying handle, heavy duty zipper, removable shoulder strap and rubber feet to keep the bag upright when out of the Tour-Pak. The interior features cross straps with secure clip to keep clothes in place, and a mesh section for toiletries. The bag is tastefully accented with an embroidered Bar & Shield logo on the zippered exterior pocket. Luggage capacity: 2,900 cubic inches. Dimensions: 22.5" L x 13" H x 10" D.

**53603-08** **\$129.95**

Fits models equipped with King Tour-Pak luggage. Does not fit with other accessories mounted to inside of Tour-Pak.

## D. PREMIER LINER FOR HARD SADDLEBAGS

High-quality, molded luggage fits perfectly inside Touring model hard saddlebags. Rigid, yet flexible design holds its shape for easy packing, and functions like traditional travel luggage on your journeys. Luggage features a durable carrying handle, heavy duty zipper, and rubber feet to keep the bag upright when out of the saddlebag. The interior features cross straps with secure clip to keep clothes in place, and a mesh section for toiletries. The bags are tastefully accented with an embroidered Bar & Shield logo on the zippered exterior pocket. Luggage capacity: 890 cubic inches (each bag). Dimensions: 24.5" L x 9" H x 6.5" D.

**90485-08** **\$169.95**

Fits models equipped with Color-Matched Hard Saddlebags. Does not fit with other accessories mounted to inside of saddlebag.



PREMIER LINERS FOR KING TOUR-PAK LUGGAGE AND HARD SADDLEBAGS



C. PREMIER LINER FOR KING TOUR-PAK LUGGAGE

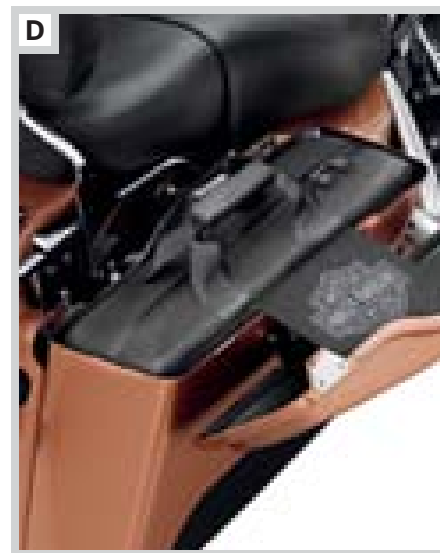

D. PREMIER LINER FOR HARD SADDLEBAGS

Notice: The prices appearing in this catalog are the manufacturer's suggested retail prices. Actual retail prices may vary.



# TOURING 403

Tour-Pak® & Saddlebag Liners



**E. PREMIUM KING TOUR-PAK LUGGAGE AND SADDLEBAG LINERS**



**F. DELUXE TOUR-PAK LINER**



**G. DELUXE SADDLEBAG LINERS**



**H. SADDLEBAG COOLERS**



**I. ROAD KING LEATHER SADDLEBAG LINERS**



**J. LEATHER TOUR-PAK LUGGAGE LINERS**

**E. PREMIUM KING TOUR-PAK® LUGGAGE AND SADDLEBAG LINERS**

1000 denier black nylon urethane coated on the inside for improved water resistance. Identified with an embossed Bar & Shield logo patch. Tour-Pak liner accommodates motorcycles equipped with or without AM/FM antennas as well as models equipped with Tour-Pak Mounted Brake/Tailamp Kit.

- 1. 53598-88A** Tour-Pak Liner. **\$56.95**  
Fits King and Ultra Tour-Pak Luggage.
- 2. 91847-88A** Saddlebag Liners. **\$54.95**  
Fits '80-'92 FLT, FLHT, FLHS models. (pair)

**F. DELUXE TOUR-PAK® LINER**

This high-quality, water-resistant bag liner is designed to fit perfectly into King Tour-Pak components. Styled with Bar & Shield logo, they feature convenient carrying straps.

- 53605-97** Fits King and Ultra Tour-Pak Luggage. **\$39.95**
- 91783-96** Fits Chopped Tour-Pak Luggage. **\$39.95**

**G. DELUXE SADDLEBAG LINERS**

These well-constructed, water-resistant bags are designed to fit perfectly into Touring model fiberglass saddlebags. Styled with an embroidered Bar & Shield logo, they feature improved inner storage pockets and convenient carrying straps. Sold in pairs.

- 91885-97A** **\$44.95**  
Fits '94-later Touring models equipped with Color-Matched Hard Saddlebags. Also fits VRSC™ Saddlebag P/N 91172-09. (pair)

**H. SLANT SADDLEBAG COOLER**

Keep water and soda cold right in your saddlebags on those hot summer rides. These zippered bags are fully lined and insulated to keep beverages cold. Room for up to twelve 12-oz. soda cans. The slant shape is designed to fit into Touring model Color-Matched Hard Saddlebags to maximize storage space.

- 1. 94184-01** **\$39.95**  
Fits '93-later Touring models equipped with Color-Matched Hard Saddlebags.

**SQUARE SADDLEBAG COOLER**

Turn your saddlebag into a refrigerator. The insulating liner keeps cold in, and the convenient zipper closure makes packing a snap. The square shape fits easily into most hard and soft saddlebags and has room for up to twelve 12-oz. soda cans.

- 2. 94185-01** **\$39.95**  
Fits '93-later Touring models equipped with stock saddlebags, '86-later FLSTC and '97-'03 FLSTS models equipped with stock leather saddlebags.

**I. ROAD KING® LEATHER SADDLEBAG LINERS**

Custom fit to the Road King leather saddlebags, these water-resistant liners feature handles and inner pockets for convenient packing, with an embroidered Bar & Shield logo.

- 91887-98** **\$44.95**  
Fits '98-later FLHRC and FLHRS models. (pair)

**J. LEATHER TOUR-PAK LUGGAGE LINERS**

This liner features a dual-direction zipper, map pocket and convenient carrying straps. The liner is constructed of water-resistant nylon and features an embroidered Bar & Shield logo. Designed specifically to fit Leather Tour-Pak Luggage.

- 53621-98** Fits Leather Tour-Pak Luggage. **\$39.95**

TOURING

Notice: The prices appearing in this catalog are the manufacturer's suggested retail prices. Actual retail prices may vary.

# 404 TOURING

## Luggage

### A. PREMIUM TOUR-PAK® RACK BAG

Finally, a durable and sturdy Premium Rack Bag that is tasteful enough to carry into a nice hotel. This versatile bag is manufactured from durable UV- and water-resistant 1680 denier ballistic nylon, and features reflective piping for added visibility. The heavy-duty zippers open to reveal a large storage space with three zippered interior mesh pockets. The bag features two zippered exterior pockets for convenient access to maps, sunscreen, and other roadside essentials, and a built-in rain cover with reflective stripe to help you survive that sudden downpour. The Premium Bag mounts to the luggage rack with quick disconnect clips, and the comfortable handle and removable shoulder strap make the move from the parking lot to the hotel room a breeze. The Premium Bag is finished with a Harley-Davidson® script logo. Dimensions: 20.5" W x 9.5" T x 13" D. Luggage capacity: 2,000 cubic inches.

**94807-09** **\$229.95**

Fits models equipped with Tour-Pak® Luggage Racks (except Mini Rack P/N 53100-96). Also fits Premium Sidecar Luggage Rack P/N 53669-89.

### B. TOUR-PAK® RACK BAG

This bag mounts conveniently to your Tour-Pak® luggage rack, eliminating the need for bungee cords or tie downs that can scratch paint. Hook-and-loop flaps hold the bag to the rack, so installation and removal is a snap. The foam-backed water-resistant material helps the bag retain its shape for easy loading, and the built-in Bar & Shield logo rain cover features a reflective stripe for added visibility. The bag includes 2 exterior side pockets for storage, 2 interior pockets (1 mesh, 1 soft cotton), and an interior key hook. The bag is 21" W x 12" T x 11.5" D. Luggage capacity: 2,500 cubic inches.

Fits Tour-Pak lids equipped with Air Wing Tour-Pak Rack P/N 79179-08, Premium Tour-Pak Luggage Rack P/N 53665-87, FLHTCUSE Tour-Pak Luggage Rack P/N 79125-06 and Contoured Luggage Rack P/N 79148-06A.

**94776-09** Leather. **\$259.95**

**94806-09** Polyester. **\$139.95**

### C. PASSENGER PILLION-MOUNTED ULTRA TOURING BAG

Pack everything you need for that long, solo ride across the country. This large touring bag is designed to fit the passenger seat of Harley® Touring models. The bag includes a water-resistant polyethylene liner that helps the bag retain its shape even when empty. Straps to the saddlebag guards and Tour-Pak mounting rack for convenient installation. The bag is 17" W x 19" T x 10" D. Luggage capacity: 2800 cubic inches.

**94788-01A** **\$199.95**

Fits '97-later Touring models equipped with Tour-Pak® Luggage and Saddlebag Guards.

### D. EXPANDABLE LUGGAGE RACK DUFFEL BAG

Urethane-coated 1000 denier nylon with a full-length zipper that wraps around the side gusset panels. Hook-and-loop fasteners attach to luggage rack tubing. Unique shoulder strap doubles as a mounting band. Main compartment zipper is covered by a protective flap secured with hook-and-loop closure. Fully expanded: 12.25" H x 12" W x 19.5" L. Not expanded: 8" H. Maximum recommended load is 10 lbs.

**91753-92** **\$99.95**

For use on Premium Tour-Pak® Luggage Rack P/N 53665-87 or Air Wing Rack P/N 79179-08.

### E. BOOM! AUDIO TANK POUCH

This portable music system pouch is designed for motorcycle use. The Neoprene jacket offers hard-core protection for your portable music device, while the built-in magnets hold the pouch securely to the fuel tank. The clear play-through window permits touch-screen control, and the anti-skid interior insert allows the pouch to accommodate players of various sizes. Simply plug in your headphones or connect your in-dash Advanced Audio Radio with an auxiliary cable, and enjoy your music collection. Two access ports are provided for headphone and output cables. Works well with many MP3 and other personal music players, but should not be used with hard-disk memory players. Window measurement: 2.5" W x 4" H.

**91003-10** Multi-Fit. **\$39.95**



A. PREMIUM TOUR-PAK RACK BAG



A. PREMIUM TOUR-PAK RACK BAG



B. TOUR-PAK RACK BAG – POLYESTER SHOWN



C. PASSENGER PILLION-MOUNTED ULTRA TOURING BAG



D. EXPANDABLE LUGGAGE RACK DUFFEL BAG



E. BOOM! AUDIO TANK POUCH

Notice: The prices appearing in this catalog are the manufacturer's suggested retail prices. Actual retail prices may vary.



**F. SADDLEBAG GUARD BAG AND WATER BOTTLE HOLDER – ROAD KING V-LOGO**



**G. SADDLEBAG GUARD BAG AND WATER BOTTLE HOLDER – ROAD KING CLASSIC CONCHO**



**H. SADDLEBAG GUARD BAG AND WATER BOTTLE HOLDER – BAR & SHIELD LOGO**



**I. ROAD KING SADDLEBAG GUARD BAG**



**J. ROAD KING CLASSIC SADDLEBAG GUARD BAG**



**K. TOURING SADDLEBAG GUARD BAG**

#### SADDLEBAG GUARD BAG WITH WATER BOTTLE HOLDER

The storage section features a hook-and-loop outer closure and a zippered inner closure to securely keep easy access to items such as sunglasses, wallets and cell phones. This bag also features a removable water bottle with the Bar & Shield logo, providing accessible water anytime on long trips.

#### F. SADDLEBAG GUARD BAG AND WATER BOTTLE HOLDER – ROAD KING® V-LOGO

This sturdy synthetic bag features an embroidered Road King V-Logo.

**92058-05** Left Side. **\$79.95**  
Fits '80-later Touring models equipped with saddlebag guard rails. Does not fit Comfort Profile Guard Rails.

**92057-05** Right Side. **\$79.95**  
Fits '93-later Touring models equipped with saddlebag guard rails. Does not fit Comfort Profile Guard Rails.

#### G. SADDLEBAG GUARD BAG AND WATER BOTTLE HOLDER – ROAD KING CLASSIC CONCHO

This sturdy synthetic bag features an embossed basket weave panel and chrome concho to match the Road King Classic model.

**92137-05** Left Side. **\$79.95**  
Fits '80-later Touring models equipped with saddlebag guard rails. Does not fit Comfort Profile Guard Rails.

**92136-05** Right Side. **\$79.95**  
Fits '93-later Touring models equipped with saddlebag guard rails. Does not fit Comfort Profile Guard Rails.

#### H. SADDLEBAG GUARD BAG AND WATER BOTTLE HOLDER – BAR & SHIELD LOGO

This sturdy synthetic bag features an embossed Harley-Davidson Bar & Shield logo.

**91991-98** Left Side. **\$79.95**  
Fits '80-later Touring models equipped with saddlebag guard rails. Does not fit Comfort Profile Guard Rails.

**91992-98** Right Side. **\$79.95**  
Fits '93-later Touring models equipped with saddlebag guard rails. Does not fit Comfort Profile Guard Rails.

#### SADDLEBAG GUARD BAGS

Bags are constructed of sturdy synthetic leather, with a hook-and-loop closure that makes it perfect for storing smaller items and a zippered inner pocket designed specifically for storing sunglasses.

#### I. ROAD KING SADDLEBAG GUARD BAGS

Convenience, durability and classic Road King styling are provided by these easy-to-install Guard Bags.

**91708-97** Left Side. **\$69.95**  
Fits '80-later Touring models equipped with saddlebag guard rails. Does not fit Comfort Profile Guard Rails.

**91709-97** Right Side. **\$69.95**  
Fits '93-later Touring models equipped with saddlebag guard rails. Does not fit Comfort Profile Guard Rails.

#### J. ROAD KING® CLASSIC SADDLEBAG GUARD BAGS

Convenient, synthetic leather bags feature a chrome, die-cast Road King Classic logo.

**91219-98** Left Side. **\$69.95**  
Fits '80-later Touring models equipped with saddlebag guard rails. Does not fit Comfort Profile Guard Rails.

**91220-98** Right Side. **\$79.95**  
Fits '93-later Touring models equipped with saddlebag guard rails. Does not fit Comfort Profile Guard Rails.

#### K. TOURING SADDLEBAG GUARD BAGS

Synthetic leather bag features an embossed Bar & Shield Logo.

**90955-97** Left Side. **\$69.95**  
Fits '80-later Touring models equipped with saddlebag guard rails. Does not fit Comfort Profile Guard Rails.

**90939-97** Right Side. **\$69.95**  
Fits '93-later Touring models equipped with saddlebag guard rails. Does not fit Comfort Profile Guard Rails.

# TOURING *SUSPENSION*

## NEVER IN A TIGHT SPOT

*On the road, you've got to feel good in the saddle. Whether you're cruising around town or out for the long haul, your bike should welcome you like an old friend and feel like an extension of yourself. So, once you've picked the bike, it's time to choose the suspension that best equips your ride to your personal dimensions.*



### A STRONG FOUNDATION



Being sure-footed at a stop or when parking your bike enhances your feeling of control and confidence. Adjusting the ride height by lowering the suspension may be the first step in fitting the bike to your inseam length. Combining a low-profile suspension and a narrow seat is the easiest way for a shorter rider to fit comfortably on a larger bike.

### THE FIT SHOP LIST



Here are a few options to consider when outfitting your bike to fit you. Find your model, and flip to the pages for more information.

2010	SUSPENSION	SEATS	HAND CONTROLS	FOOT CONTROLS
FLHR / FLHRC	Profile® Low Front Suspension Profile Low Rear Suspension (pg. 407)	Reach® Seat (pg. 356) Sidekick® Seat (pg. 354) Badlander® Seat (pg. 355) Low Profile Seat (pg. 355) Tallboy® Seat (pg. 357)	Various handlebar and / or riser options available (pg. 576-597)	Extended Reach Rider Footboards (pg. 434)
FLHTC / FLHTCU / FLHTK	Same as above (pg. 407)	Same as above (pg. 354-357)	Same as above (pg. 576-597)	Same as above (pg. 434)
FLHX	Profile® Low Front Suspension (pg. 407)	Same as above (pg. 354-357)	Same as above (pg. 576-597)	Same as above (pg. 434)
FLRTX	Same as above (pg. 407)	Same as above (pg. 354-357)	Same as above (pg. 576-597)	Same as above (pg. 434)



# TOURING 407

Suspension



**A. PROFILE LOW TOURING FRONT LOWERING KIT**



**B. PROFILE LOW CARTRIDGE STYLE FRONT END LOWERING KIT**



**C. PROFILE LOW TOURING SHOCKS**



**D. TOURING SUSPENSION AIR PUMP**

**A. PROFILE® LOW TOURING FRONT LOWERING KIT\***

Place the rider's feet firmly on the ground. This kit utilizes components designed to provide a 1" decrease in ride height.

**54564-09 \$149.95**

Fits '09-later Touring models (except FLHR, FLHRC, FLTRSE3, FLHXSE, Trike, FLHP and FLHPE models). Must only be installed on vehicles equipped with Profile Low Touring Shocks P/N 54635-09. Can be installed on FLHX and FLTRX models with Original Equipment rear shocks.

**46875-09 \$149.95**

Fits '09-later Road King® models. Must only be installed on vehicles equipped with Profile Low Touring Shocks P/N 54635-09.

**54614-05 \$99.95**

Fits '02-'08 Road King models. Must only be installed on vehicles equipped with Profile Low Touring Shocks P/N 54631-02B.

**54628-06 \$99.95**

Fits '06-'08 Touring models (except Road King or FLH Police models.) Must only be installed on vehicles equipped with Profile Low Touring Shocks P/N 54631-02B. Can be installed on FLHX models with Original Equipment rear shocks.

**B. PROFILE LOW CARTRIDGE STYLE FRONT END LOWERING KIT\***

A complete kit designed to lower the front end of your Touring bike by approximately 1". A great accessory to add when installing your Chrome Lower Fork Sliders. This kit includes similar suspension internal cartridge components used to improve the overall ride characteristics found in the Ultra Classic®, Classic and Road Glide® models. Must only be installed on vehicles equipped with Profile Low Touring Shocks P/N 54631-02B.

**54599-02 \$194.95**

Fits '02-'08 Road King® models.

**54598-02 \$119.95**

Fits '02-'05 Touring models (except Road King models).

**C. PROFILE® LOW TOURING SHOCKS\***

Lower the seat height of your Touring model without compromising the ride. The Profile Low Touring Shocks have been re-valved for a comfortable ride while lowering the seat height by up to 3/4". The kit maintains the air adjustability feature of the stock shocks.

**54635-09 \$279.95**

Fits '09-later Touring models (except Trike). Does not lower '09-later FLHX, FLTRX, FLHXSE and FLTRSE3 models.

**54631-02B \$279.95**

Fits '97-'08 Touring models (except FLHRSE3/4). Does not lower FLHRS or FLHX models.

**D. TOURING SUSPENSION AIR PUMP**

This pump was designed to allow safe and simple adjustment of the front and rear air suspension on Touring motorcycles. Unlike a bicycle pump or a fuel station air hose, the hand-operated pump with controllable "micro bleed" valve allows precise adjustment to air volume, and the "no loss" air connector maintains shock pressure when the fitting is removed. The 4.5" swivel air hose simplifies valve stem attachment. The aluminum housing is compact, lightweight, and durable, and fits easily into your bag for "on-the-road" adjustments. The high-quality 0-60 psi gauge ensures accurate air pressure.

**54630-03A \$46.95**

For use with Touring Air Suspension components.



**\*WARNING:** The Profile® Low Front Spring Kit cannot be used independently and must be used with the appropriate Profile Rear Shock Lowering Kit. Installation of any accessory suspension components may affect cornering clearance and jiffy stand operation. This could distract the rider, causing loss of control and death or serious injury.



**\*WARNING:** Installation of any accessory suspension components may affect cornering clearance and jiffy stand operation. This could distract the rider, causing loss of control and death or serious injury.

TOURING

Notice: The prices appearing in this catalog are the manufacturer's suggested retail prices. Actual retail prices may vary.

## DEFINE YOUR LOOK

*Customizing your motorcycle is about selecting accessories that work together to reflect your personality. Envision your bike as a whole and choose the options that will make that vision a reality. Developing a “look” for your bike doesn’t have to be difficult; before you start, just decide on a direction and stick with it.*



### BLACK & CHROME

Genuine H-D® Accessories are developed by the same folks that built your bike, so you can be assured that plated or painted parts will match the Original Equipment finishes for a unified look.

## FOCUS ON THE PROFILE

### FRONT END TRIM

Custom fork sliders, wheels and rotors put your sense of style front and center. And simple additions like custom axle covers and hardware finish the look.

### REAR END TRIM

A chrome swingarm and custom wheels make a major visual impact, and easy-to-install axle covers, belt guards and custom hardware give a unified look.

### WHEELS & BRAKES

Custom calipers, wheels and rotors can have a radical impact on the look, but small additions like caliper trim and chrome hardware can provide subtle style.

### CHASSIS TRIM

One of the easiest ways to customize your motorcycle is adding decorative covers. Fender trim, component covers and custom hardware all grab your attention.

### HAND CONTROLS

Adding mirrors, grips and a little chrome puts style in full view of the rider. A custom master cylinder, switch covers and hand levers give instant gratification.

### FOOT CONTROLS

Custom foot pegs, foot levers and shift linkages offer exceptional function and style, and highway pegs and engine guards add comfort and engine protection.

### CONSOLES & GAUGES

The link between your brain and the bike. Auxiliary gauges help you monitor your engine's vital signs, and a custom console says a lot beyond the numbers.

### ENGINE TRIM & HARDWARE

The V-Twin engine is the heart of the bike. Adding well-chosen covers, a custom air cleaner and a decorative collection instantly sets your bike apart from stock.

### LIGHTING

Lighting adds distinctive style and aids visibility. Choose from a variety of auxiliary lamps, headlamp trim and LED lighting to grab maximum attention.

### PERFORMANCE

Performance options make a styling statement as well. Screamin' Eagle® high-flow air cleaners and custom exhaust systems show that you mean business.

# 410 TOURING

Chassis Trim – Front End

## A. CHROME FRONT END KITS\*

The front forks on a Harley-Davidson® motorcycle set the tone for the bike, and can lead the way to a full-bore custom statement. So start customizing by adding chrome where it will have the most noticeable impact on the overall look of the bike, your front end. This package includes components necessary to completely chrome the front forks and includes some or all of the following (kit components vary depending on your model): Chrome Fork Sliders, Chrome Fork Axle Retainer Nut Kit, Chrome Fork Slider Drain Screw Kit, Chrome Front Wheel Spacers, Classic Chrome Front Axle Nut Cover Kit, and Chrome Upper Fork Nut Covers.

**46335-08** **\$449.95**

Fits '08-later Touring models (except Trike and models with ABS option).

**46371-08** **\$449.95**

Fits '08-later Touring models with ABS option (except Trike).

**46335-04A** **\$459.95**

Fits '00-'07 Touring models.

\*Chrome Front End Package price does not include labor or supplies.

## B. TOURING CHROME LOWER FORK SLIDERS

Competitively-priced, these chrome-plated Lower Fork Sliders give your bike upfront style. To ensure proper fitment and function, these sliders are manufactured from Original Equipment components. Features polished, triple chrome-plating and stamped "Harley-Davidson" logo.

**46472-00B** **\$299.95**

Fits '00-later Touring models (except Trike).

**45315-98** **\$329.95**

Fits '84-'99 Touring models.

**83819-09** **\$319.95**

Fits '09-later Trike models.

## C. GLOSS BLACK LOWER FORK SLIDERS

The classic Harley-Davidson® motorcycle color is black. It shows your attitude, your feelings and your desire to be different from the rest. These gloss black accessories are the ultimate extension of the Harley-Davidson philosophy. Manufactured from Original Equipment components, these parts provide superior fit and finish.

**46546-03** **\$249.95**

Fits '00-later Touring models (except Trike).



A. CHROME FRONT END KITS



B. TOURING CHROME LOWER FORK SLIDERS (SHOWN WITH CHROME UPPER FORK SLIDER COVERS)

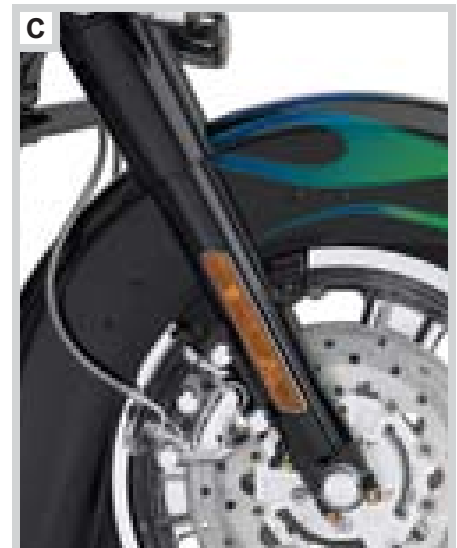

C. GLOSS BLACK LOWER FORK SLIDERS (SHOWN WITH GLOSS BLACK UPPER FORK SLIDER COVERS)

Notice: The prices appearing in this catalog are the manufacturer's suggested retail prices. Actual retail prices may vary.





**D. BAR & SHIELD LOGO UPPER FORK SLIDER COVERS**



**E. FLAMED UPPER FORK SLIDER COVERS**



**F. CHROME UPPER FORK SLIDER COVERS**



**G. GLOSS BLACK UPPER FORK SLIDER COVERS**



**H. CHROME FORK AXLE RETAINER NUT KIT**



**I. CHROME FORK SLIDER DRAIN SCREW KIT**

**D. BAR & SHIELD LOGO UPPER FORK SLIDER COVERS**

Add a personal "Harley-Davidson" touch to your chrome front end conversion with these Upper Fork Slider Covers. The chrome-plated covers feature a recessed, engraved Bar & Shield emblem and a beaded contour at the base of the cover. Kit replaces Original Equipment satin fork slider covers for a complete finished look.

**46116-03** **\$79.95**

Fits '49-'84 FL, '80-later Touring models.

**E. FLAMED UPPER FORK SLIDER COVERS**

Raised three-dimensional flames leap from the surface of the mirror-finished Upper Fork Slider Covers. The ideal finishing touch to a chrome front fork conversion, these covers replace the Original Equipment uppers for a custom look. Kit includes left and right covers.

**46165-03** **\$79.95**

Fits '49-'84 FL, '80-later Touring models.

**F. CHROME UPPER FORK SLIDER COVERS**

Brilliant chrome accents for the upper fork legs. Perfect for finishing off that chromed front end look when used with H-D® Genuine Motor Accessory Chrome Lower Fork Sliders.

**45963-97** **\$69.95**

Fits '49-'84 FL, '80-later Touring models and '86-later FLST, FLSTC, FLSTF (except '07), FLSTFB, FLSTSE and FLSTN models.

**G. GLOSS BLACK UPPER FORK SLIDER COVERS**

The classic Harley-Davidson motorcycle color is black. It shows your attitude, your feelings and your desire to be different from the rest. These gloss black accessories are the ultimate extension of the Harley-Davidson philosophy. Manufactured from Original Equipment components, these parts provide superior fit and finish.

**45591-02** **\$59.95**

Fits '49-'84 FL, '80-later Touring models and '86-later FLST, FLSTC, FLSTF (except '07), FLSTFB, FLSTSE and FLSTN models.

**H. CHROME FORK AXLE RETAINER NUT KIT**

It's the details that count. Complete the chrome transformation by adding this finishing touch to your chrome fork sliders. This Axle Retainer Nut Kit includes the stylish chrome-plated nuts and chrome lockwashers necessary to replace the stock hardware.

**45813-03** **\$7.95**

Fits '84-later Touring, '86-'07 FLST, FLSTC, FLSTF, FLSTN, '91-'07 FXST and FXSTB, and '91-'05 FXDWG models.

**I. CHROME FORK SLIDER DRAIN SCREW KIT**

It's the details that count. Complete the chrome transformation by adding this finishing touch to your chrome fork sliders. This Fork Slider Drain Screw Kit includes two chrome-plated drain screws and the seals required to replace the stock hardware.

**45848-03** **\$3.95**

Fits '87-later Softail® (except Springer, FXSTD and FXCW/C), '87-later Touring models, and '93-'05 FXDWG models.



# 412 TOURING

## Chassis Trim – Front End

### A. CLASSIC CHROME FRONT AXLE NUT COVER KIT

Covers are polished and chrome-plated. Includes Allen-head set screws and Allen wrench for easy installation.

Fits '02-later VRSC™ models (except VRSCR and VRSCF), '08-later XL, '07-later Softail® (except Springer®, FXCW, FXCWC and FXSTD), '08-later Dyna® and '08-later Touring models.

<b>44117-07A</b>	Die Cast.	<b>\$26.95</b>
<b>44116-07A</b>	Billet.	<b>\$41.95</b>

Fits '00-'07 Touring models and '04-'07 Dyna models (except '04-'05 FXDWG and '07 FXDSE).

<b>43062-04</b>	Die Cast.	<b>\$26.95</b>
<b>43061-04</b>	Billet.	<b>\$41.95</b>

Fits '84-'06 Softail (except Springer® and FXSTD); '91-'03 FXD, FXDX, FXDXT, FXDL, FXDS-CONV.; '93-'05 FXDWG; '80-'99 Touring; '88-'07 XL, FXR and '87-later FLXR/FXRS-SP, FXWG models.

<b>43899-86A</b>	Die Cast.	<b>\$26.95</b>
------------------	-----------	----------------

### B. GLOSS BLACK FRONT AXLE NUT COVER KIT

Gloss black covers conceal the front axle hardware for a clean, custom look. Kit includes set screws and Allen wrench for easy installation.

<b>43428-09</b>		<b>\$41.95</b>
-----------------	--	----------------

Fits '02-later VRSC models (except VRSCR and VRSCF), '08-later XL, '07-later Softail (except Springer, FXCW, FXCWC and FXSTD), '08-later Dyna and '08-later Touring models.

### C. WILLIE G.® SKULL COLLECTION FRONT AXLE NUT COVER KIT

Add a little attitude to your ride. Styled to complement Harley-Davidson® Skull accessory items, the menacing raised skull with black-filled eyes leaps from a field of chrome. The surrounding "Harley-Davidson Motorcycles" script is the perfect finishing touch. The Axle Nut Covers are easy-to-install, and include all necessary mounting hardware. Sold in pairs.

<b>43163-08A</b>		<b>\$28.95</b>
------------------	--	----------------

Fits '88-later XL, '84-later Softail (except Springer, FXCW, FXCWC and FXSTD), '02-later VRSC (except VRSCR and VRSCF), '91-later Dyna, and '99-later Touring models.

### D. ALUMINATOR® CHROME BILLET FRONT AXLE NUT COVER KIT

Chrome-plated aluminum billet axle cover kit with the classic styling of the Aluminator Collection. Includes mounting hardware and wrench for easy installation.

<b>44114-07</b>		<b>\$41.95</b>
-----------------	--	----------------

Fits '07-later Softail® models, (except Springer®, FXCW, FXCWC and FXSTD), '02-later VRSC (except VRSCR and VRSCF) models, and '02-later VRSC™ (except VRSCR and VRSCF) models.

<b>43059-04</b>		<b>\$41.95</b>
-----------------	--	----------------

Fits '00-'07 Touring models and '04-'07 Dyna models (except '04-'05 FXDWG and '07 FXDSE).

<b>43907-94</b>		<b>\$41.95</b>
-----------------	--	----------------

Fits '84-'06 Softail® (except Springer and FXSTD); '91-'03 FXD, FXDX, FXDXT, FXDL, FXDS-CONV.; '93-'05 FXDWG; '80-'99 Touring; '88-'07 XL, FXR and '87-later FLXR/FXRS-SP, FXWG models.

### E. FORK SLIDER END COVER KIT

Lead the way with chrome. This Fork Slider End Cover Kit is contoured to complement the shape of the front fork slider. Designed to conceal the front axle and fork slider hardware, the smooth chrome surface complements both Original Equipment satin finish and accessory chrome lower fork sliders. Complete kit includes all necessary installation hardware.

<b>46282-07</b>		<b>\$69.95</b>
-----------------	--	----------------

Fits '00-later Touring models (except Trike and models equipped with ABS brakes). Installation requires removal of Original Equipment or accessory axle nut covers. Does not fit with Tapered Wheel Spacers P/N 41458-08.



A. CLASSIC CHROME FRONT AXLE NUT COVER KIT – BILLET



B. GLOSS BLACK FRONT AXLE NUT COVER KIT



C. WILLIE G. SKULL COLLECTION FRONT AXLE NUT COVER KIT



D. ALUMINATOR CHROME BILLET FRONT AXLE NUT COVER KIT



E. FORK SLIDER END COVER KIT

Notice: The prices appearing in this catalog are the manufacturer's suggested retail prices. Actual retail prices may vary.



F

F. "H-D MOTOR CO." LOGO FRONT AXLE NUT COVER KIT



G

G. TAPERED FRONT AXLE NUT COVER KIT



H

H. CHROME FRONT WHEEL SPACERS – TAPERED



H

H. CHROME FRONT WHEEL SPACERS – DOMED



H

H. CHROME FRONT WHEEL SPACERS – STRAIGHT



I

I. CHROME REAR WHEEL SPACER KIT

#### F. "H-D MOTOR CO." LOGO FRONT AXLE NUT COVER KIT

Die-cast, chrome-plated covers feature the "Harley-Davidson Motor Co." logo in black. Includes Allen-head set screws and wrench for easy installation.

**44148-07A** **\$26.95**

Fits '02-later VRSC models (except VRSCR and VRSCF), '08-later XL, '07-later Softail (except Springer, FXCW, FXCWC and FXSTD), '08-later Dyna and '08-later Touring models.

**43063-04** **\$26.95**

Fits '00-'07 Touring models and '04-'07 Dyna models (except '04-'05 FXDWG and '07 FXDSE).

**43864-96** **\$28.95**

Fits '84-'06 Softail (except Springer and FXSTD); '91-'03 FXD, FXDX, FXDXT, FXDL, FXDS-CONV.; '93-'05 FXDWG; '80-'99 Touring; '88-'07 XL, FXR and '87-later FLXR/FXRS-SP, FXWG models.

#### G. TAPERED FRONT AXLE NUT COVER KIT

Thanks to an exclusive contoured profile, these unique chrome die-cast Front Axle Nut Covers appear smaller than others when installed. Sold in pairs.

**44109-07** **\$26.95**

Fits '07-later Softail® models, (except Springer, FXCW, FXCWC and FXSTD), '08-later Dyna® and Touring (except Trike), and '02-later VRSC™ (except VRSCR and VRSCF) models.

**43051-01** **\$26.95**

Fits '00-'07 Touring models and '04-'07 Dyna® models (except '04-'05 FXDWG and '07 FXDSE).

#### H. CHROME FRONT WHEEL SPACERS

Complete your total front end with these highly polished chrome-plated wheel spacers. Manufactured to the Original Equipment tolerances, they deliver exact fitment and custom shine.

**41458-08** Tapered. **\$39.95**

Fits '08-later Touring models (except Trike and models with ABS brakes). Does not fit with Fork Slider End Cover P/N 46282-07.

**41371-08** Domed. **\$44.95**

Fits '08-later Touring models (except Trike) with ABS brakes.

**41624-04** Domed. **\$39.95**

Fits '00-'07 Touring models.

**41610-02** Straight. **\$39.95**

Fits '00-'07 Touring models.

#### I. CHROME REAR WHEEL SPACER KIT

Add some chrome detail to an often overlooked area of the bike with this highly-polished Chrome Wheel Spacer Kit. Manufactured to the Original Equipment tolerances, they ensure product fitment and quality.

**41163-04** **\$29.95**

Fits '02-'07 Touring models. Does not fit with Isolated Drive System P/N 40287-07.

# 414 TOURING

Chassis Trim – Front End

## A. GLOSS BLACK NACELLE AND HANDLEBAR COVER KIT

The classic Harley-Davidson® motorcycle color is black. It shows your attitude, your feelings and your desire to be different from the rest. These gloss black accessories are the ultimate extension of the Harley-Davidson philosophy. Manufactured from Original Equipment components, these parts provide superior fit and finish.

**46547-03A** **\$299.95**  
Fits '94-later FLHR and FLHRC models.

Shown with:

## GLOSS BLACK HEADLAMP TRIM RING

**46555-03A** **\$27.95**  
Fits '94-later FLHR and FLHRC models.

## B. GLOSS BLACK OUTER FAIRING SKIRT

The classic Harley-Davidson motorcycle color is black. It shows your attitude, your feelings and your desire to be different from the rest. These gloss black accessories are the ultimate extension of the Harley-Davidson philosophy. Manufactured from Original Equipment components, these parts provide superior fit and finish.

**46559-03** **\$79.95**  
Fits '00-later FLHT, FLHX, FLHTC, FLHTCU and FLHTK models. Does not fit Trike models.

## C. CHROME LOWER TRIPLE TREE COVER

This Lower Triple Tree Cover dresses up the unfinished underside of the triple tree for a complete custom look. The chrome-plated steel cover installs easily, concealing the brake splitter fitting.

**66050-03** **\$64.95**  
Fits '87-later Touring models (except Trike). (Will not fit with Braided Brake Line P/N 45212-97B. Use Braided Brake Line P/N 46231-02A.)

## D. CHROME FORK BRACKET COVER FOR TOURING MODELS

Complete the custom look. This polished chrome cover is easily installed on the back of the lower triple tree and fills the gap between the fork stop and the slider cover. Chrome-plated mounting hardware is included.

**66058-01** **\$38.95**  
Fits '87-later Touring models (except Trike).

## E. CHROME FRONT FORK AIR BAFFLE

Deflect the cold night wind rushing between the fork tubes of your Touring model. This stylish chrome air baffle replaces the Original Equipment black baffle on '00-earlier models. Includes chrome mounting hardware.

**58520-79TC** **\$24.95**  
Fits '80-later FLT, FLHT, FLHX and FLHR models. Does not fit Trike models.



**A. GLOSS BLACK NACELLE AND HANDLEBAR COVER KIT (SHOWN WITH GLOSS BLACK HEADLAMP TRIM RING)**



**B. GLOSS BLACK OUTER FAIRING SKIRT**



**C. CHROME LOWER TRIPLE TREE COVER**



**D. CHROME FORK BRACKET COVER FOR TOURING MODELS**



**E. CHROME FRONT FORK AIR BAFFLE**

Notice: The prices appearing in this catalog are the manufacturer's suggested retail prices. Actual retail prices may vary.

# TOURING 415

Chassis Trim – Rear End



**F. FENDER STRUT COVERS – GLOSS BLACK**

## F. FENDER STRUT COVERS – GLOSS BLACK

Manufactured from Original Equipment components to ensure superior fit and finish, the gloss black Fender Strut Covers conceal the cast fender struts and continue the dark look to the area behind the saddlebags. The ideal finishing touch for your “blacked-out” Touring bike, these covers are the perfect complement to the optional gloss black Passenger Sissy Bars, Stealth Luggage Rack and Docking Hardware Kits.

**47498-09** **\$109.95**

Fits '09-later Touring models (except Trike and models equipped with rigid-mounted Tour-Pak luggage).

## G. CHROME LOWER BELT GUARD COVER

Dress your lower belt guard in chrome. This polished and chrome-plated metal guard is formed to fit over the Original Belt Guard for easy installation.

**60408-09** **\$74.95**

Fits '09-later Touring models (except Trike).

**60491-02A** Fits '97-'08 Touring models. **\$74.95**

## H. CHROME SPROCKET COVER

This Sprocket Cover gives the appearance of a chrome sprocket at a fraction of the cost. It matches the styling of the Original Equipment sprocket, and bolts on using the Original Equipment hardware.

**37757-07** **\$49.95**

Fits '07-later Softail® (except FXCW/C) and '07 Touring models.

## I. ISOLATED DRIVE SYSTEM SPROCKET KIT

Introduced on the '08 Touring models, the Isolated Drive System improves rider comfort and ride quality by dampening the mechanical noise and vibration caused by the engine's torque pulses. The rubber compensation elements in the sprocket act like a cushion, absorbing the power pulses from the engine. With the IDS installed, the motorcycle feels more refined, and is quieter while accelerating, shifting and cruising. Kit includes sprocket, compensator bowl, and installation hardware.

**40287-07** **\$305.00**

Fits '07 Touring (except Japanese) models equipped with Original Equipment and Harley-Davidson accessory wheels. Will not fit with 80-Spoke Laced Wheel P/N 42954-04, Polished Spun Aluminum Disc Wheel P/N 43760-03, or Slotted Six-Spoke Wheel P/N 43932-02 (chrome) or 43933-02 (black).



**G. CHROME LOWER BELT GUARD COVER ('97-'08 SHOWN)**



**H. CHROME SPROCKET COVER**



**I. ISOLATED DRIVE SYSTEM SPROCKET KIT**

Notice: The prices appearing in this catalog are the manufacturer's suggested retail prices. Actual retail prices may vary.



# 416 TOURING

## Brakes

### A. CHROME BREMBO® FRONT BRAKE CALIPER KITS

Add the shine of chrome to your bike with these highly polished Chrome Brake Caliper Kits. Manufactured from Original Equipment components for proven performance, these calipers are a great addition to the stock bike, or add the finishing touch to a complete custom equipped with chrome wheels, rotors, fork sliders and swingarm. (Brake pads and pad pins not included.)

**42012-06A** **\$824.95**  
Fits '08-later Touring models and '06-later VRSC™ models.

### B. CHROME FRONT CALIPER KIT

Add the shine of chrome to your front end with this highly polished Chrome Front Brake Caliper Kit. Manufactured from Original Equipment components for proven performance, these calipers are a great addition to the stock front end or add the finishing touch to a complete custom with chrome wheels, rotors and chrome fork sliders. (Brake pads and pad pins not included.)

**44392-00A** **\$789.95**  
Fits '00-'03 XL, '02-'05 VRSC™ and '00-'07 Dyna®, Softail® and Touring models equipped with dual disc front brakes.

### C. CHROME REAR CALIPER KIT

With H-D® chrome behind you, you're cruising with confidence. The Rear Caliper Kit offers a brilliant, long-lasting chrome finish while delivering Original Equipment performance and fitment. Bolts right to the existing mounting holes. (Brake pads and pad pins not included.)

**42030-05** **\$399.95**  
Fits '02-'07 Touring models and '05 VRSCA and VRSCB models.

### D. CHROME BANJO BOLT KIT

Replace the Original Equipment zinc finish brake line hardware with brilliant chrome custom banjo bolts.

**41843-08** **\$44.95**  
Fits '06-later VRSC™ models and '08-later Touring models.

### E. CHROME BANJO BOLT KIT

Replace the Original Equipment 12-point zinc finish brake line hardware with brilliant chrome custom tapered banjo bolts.

**41844-06** **\$27.95**  
Fits '02-'05 VRSCA and VRSCB models and '93-'07 Touring models. Does not fit with Banjo Bolt Cover P/N 32715-98. Kit includes three 3/8" banjo bolts and six sealing washers.



A. CHROME BREMBO FRONT BRAKE CALIPER KITS



B. CHROME FRONT CALIPER KIT



C. CHROME REAR CALIPER KIT



D. CHROME BANJO BOLT KIT



E. CHROME BANJO BOLT KIT

Notice: The prices appearing in this catalog are the manufacturer's suggested retail prices. Actual retail prices may vary.



NEW

F

F. AIR WING CALIPER AND ROTOR COVER



NEW

G

G. AIR WING CALIPER COVER



H

H. CHROME CALIPER ROTOR COVER



I

I. CALIPER COVER MEDALLION KIT



J

J. FRONT CALIPER COVER



K

K. CHROME CALIPER SCREEN INSERT

**F. AIR WING CALIPER AND ROTOR COVER**

Add a custom look to the front of your bike. These easy-to-clean mirror-chrome rotor covers surround the brake disc for a stylish appearance, and the matching deep-drawn steel covers hide the Original Equipment painted calipers. The Caliper Covers feature a sweeping Air Wing design and subtle Bar & Shield logo to enhance the look. Installation does not require brake line removal. Kit includes left- and right-hand covers and all necessary mounting hardware.

**44013-09A****\$199.95**

Fits '08-later Touring models (except '09 FLTRSE3).

**G. AIR WING CALIPER COVER**

Surround your calipers in chrome. These mirror-chrome deep-drawn steel covers hide the Original Equipment painted calipers, and feature a sweeping Air Wing design and subtle Bar & Shield logo to enhance the look. Installation does not require brake line removal. Kit includes left- and right-hand covers and all necessary mounting hardware.

**44729-09****\$89.95**

Fits '08-later Touring models (except Trike).

**H. CHROME CALIPER ROTOR COVER**

Add clean, chrome style to your front end with this cover, which features high-quality chrome-plating that complements the lines of your bike.

**42230-00****\$214.95**

Fits '00-'07 Touring models. Requires separate purchase of (1) Medallion Kit P/N 42231-00, 42235-00 or 42232-00.

**I. CALIPER COVER MEDALLION KIT**

Designed to match your specific style of bike. Easy to apply, these unique Caliper Rotor Cover Medallions are backed with adhesive and are notched for correct positioning.

Fits '00-'07 Touring models with Chrome Caliper Rotor Cover P/N 42230-00.

**1. 42231-00** Classic Style.**\$19.95****2. 42235-00** Road King® Classic Style.**\$19.95****J. FRONT CALIPER COVER**

Chrome-plated caliper covers styled with stepped contours and textured recess for a distinctive look. Split cover design does not require brake line removal. Sold in pairs.

**43798-00****\$79.95**

Fits '00-'07 Touring models. (Does not fit with braided brake lines.)

**K. CHROME CALIPER SCREEN INSERT**

Chrome-plated caliper inserts replace the Original Equipment satin-finish screens featured on Brembo brake calipers. Easy pop-in installation. Sold individually.

**42054-05** Front.**\$25.95**

Fits '06-later VRSC and '08-later Touring models.

**42053-05** Rear.**\$25.95**

Fits '06-later VRSC and '08-later Touring models.

# 418 TOURING

## Brakes

### A. CHROME CALIPER HARDWARE KIT

Chrome-plated hardware is a great finishing touch to Chrome Brake Calipers. This kit replaces the Original Equipment black 12-point bolts on a single caliper.

**44473-02A** \$39.95

Fits '00-'07 models (except Springer® front caliper, '04-later XL, '06-later FX Softail® rear calipers, and '06-later VRSC™ models).

### B. CHROME BRAKE DISC HARDWARE KIT

It's the details, like this chrome hardware kit, that really get your bike noticed. These button head screws add a unique, chrome-plated finish to the Original Equipment or accessory floating brake rotors. Kit includes 5 chrome-plated bolts manufactured to factory specifications to ensure fit and performance.

**46646-05** Front. \$12.95

Fits '90-later models (except VRSC™, XR, '06-later Dyna® models with cast wheel option and '07-later FLHRSE3/4). Dual disc models require purchase of two kits.

**46647-05** Rear. \$13.95

Fits '92-later models (except XR and Trike).

### C. DEEP DISH BRAKE CALIPER INSERT

This chrome-plated caliper insert features a dished-out center profile for added "flash". Includes self-adhesive backing for easy installation.

**44542-03** \$13.95

Fits '00-later front and rear brake calipers on all models (except Springer® front, '08-later Touring, '04-later XL and '06-later VRSC models).

### D. BRAKE CALIPER INSERTS

Easy to install inserts add a finishing touch to the front and rear brake calipers. Select a style that follows your custom direction. Self-adhesive backing.

Fits '00-later front and rear brake calipers on all models (except Springer front, '08-later Touring, '04-later XL and '06-later VRSC models).

**1. 44477-99** Classic Chrome. \$13.95

**2. 44476-99** Harley-Davidson Script. \$13.95

**3. 44474-99** Flames. \$13.95

### E. REAR SPROCKET BOLT COVER KIT

These chrome-plated covers with internal spring clips hide the Original Equipment sprocket bolts for a clean, custom look. Set of 5 covers.

**43876-04** \$38.95

Fits '93-later Softail®, '99-later Touring (except Trike) and '04-later XL models with Original Equipment 7/16" hex head sprocket mounting bolts (5/8" hex across the flats).

### F. CLASSIC COVERS KIT

Customize your bike down to the last detail. These hardware Cover Kits include the chrome-plated ABS caps and plugs in the sizes and styles required to dress the viewable hardware on the motorcycle. Classic Covers are available as complete Bike Kits with the covers for both engine and chassis hardware, or as Engine-only kits to dress the Twin Cam or XL engine. The kits are easy to install, with no tools required.

**94924-09** Bike Kit. \$259.95

Fits '09-later Touring models.

**94949-07** Bike Kit. \$249.95

Fits '99-'08 Touring models.

**94943-07** Engine Kit. \$109.95

Fits Twin Cam-equipped models.



A. CHROME CALIPER HARDWARE KIT



B. CHROME BRAKE DISC HARDWARE KIT



C. DEEP DISH BRAKE CALIPER INSERT



D. BRAKE CALIPER INSERTS



E. REAR SPROCKET BOLT COVER KIT



F. CLASSIC COVERS KIT  
(NOT ALL COMPONENTS SHOWN)

Notice: The prices appearing in this catalog are the manufacturer's suggested retail prices. Actual retail prices may vary.



G. TOURING V-LOGO FRONT FENDER RAIL



H. TOURING V-LOGO REAR FENDER RAIL



I. FENDER RAIL INSERT - FRONT



I. FENDER RAIL INSERT - REAR



J. ELECTRA GLIDE SPORT AND ROAD KING FRONT BUMPER ASSEMBLY



K. FRONT FENDER RAIL AND STANCHION KIT

**G. TOURING V-LOGO FRONT FENDER RAIL\***

A stylish re-creation of a popular Hydra Glide accessory, this twin tube design sweeps smartly back along the front fender. Matching Touring V-Logo Rear Fender Rail P/N 91100-94 integrates the styling from front to rear. Includes mounting hardware and installation instructions.

**91099-94A** **\$99.95**

Fits '80-later FLT, FLHT, FLHR, FLHC and '80-'93 FLHS models. (Does not fit '98-later FLHX, FLTR or FLHR models.)

**H. TOURING V-LOGO REAR FENDER RAIL\***

Designed with a similar styling theme to match our Touring V-Logo Front Fender Rail P/N 91099-94A. Replaces the stock rear fender rail and rubber bumper on Touring models. Chrome-plated twin tubes are crowned with a hand-polished and chrome-plated cast V-Logo reminiscent of Harley-Davidson's 1953 Golden Anniversary medallion. Includes hardware and installation instructions.

**91100-09** **\$99.95**

Fits '09-later FLHRC, FLTR, FLTRX and FLHX models. Does not fit with mud flaps.

**91100-94** **\$99.95**

Fits '80-'08 FLT, FLHT, FLHR, FLHC, '98-'03 FLTR and '80-'93 FLHS models. Does not fit with mud flaps.

**I. FENDER RAIL INSERTS**

This accessory closes the fender rail gap and features a Bar & Shield logo with black grooves for a clean, custom look. Kit includes all necessary hardware and mounting brackets.

**91358-99A** Front. **\$84.95**

Fits '80-later Tour Glide, FLHTC, FLHTCU and FLHTCUTG models. (Does not fit '98-later FLTR, FLHRS, or '94-later FLHR models.)

**91357-99A** Rear. **\$74.95**

Fits '80-'08 Tour Glide, FLHS, FLHR, FLHT/C and FLHTCU models and '06-'08 FLHX models. (Does not fit FLHRCI, FLHRS and FLTR.)

**J. ELECTRA GLIDE® SPORT AND ROAD KING® FRONT BUMPER ASSEMBLY**

Add style and protection to the front fender of your Electra Glide® Sport or Road King® motorcycle.

**91085-83D** **\$134.00**

Fits '87-'93 FLHS, '94-later FLHR and '96-later FLHT models. (Does not fit '98-later FLTR models.)

**K. FRONT FENDER RAIL AND STANCHION KIT\***

Chrome-plated accents straight from our 1947 catalog. Includes template for easy installation.

**91117-97** **\$69.95**

Fits '84-later FL Softail® (except FLSTF, FLSTFB, FLSTSE and FLSTSB) and Touring models.



**\*WARNING:** Fender rails are decorative items only. Do not strap anything to the rails. Adding any additional weight to the front fender could adversely affect vehicle handling, causing loss of control and death or serious injury.

Notice: The prices appearing in this catalog are the manufacturer's suggested retail prices. Actual retail prices may vary.



# 420 TOURING

## Chassis Trim

### A. BAR & SHIELD CHROME FENDER TIP LENS KIT

Chrome-plated polycarbonate construction features translucent Bar & Shield emblems. The kit includes front and rear lenses. Front lens features an amber Bar & Shield, rear lens features a red Bar & Shield. Quick and easy installation.

**59081-96** Front and Rear. **\$27.95**

Fits '80-'08 FLHT, FLT, FLHS, FLHR models and '86-'08 FLSTC, '93-'96 FLSTN models. (Does not fit Springer®, FLHRS, or FLTR models.)



A. BAR & SHIELD CHROME FENDER TIP LENS



B. FENDER TIP LENS WITH SKULL LOGO

### B. FENDER TIP LENS KIT WITH SKULL LOGO

This chrome-plated fender tip lens kit adds a little attitude to your ride. The kit features front and rear lenses with a translucent illuminated skull silhouette. The easy-to-install kit includes an amber front lens and red rear lens.

**59651-01** **\$27.95**

Fits '80-'08 Electra Glide®, Tour Glide, FLHS, Road King® (except Road King Classic and FLHRS), and '86-'08 FLSTC and '93-'96 FLSTN models.

### C. FLAMES FENDER TIP

Made of durable ABS plastic. Includes mounting hardware and installation instructions.

**59348-98** Front. **\$31.95**

Fits '80-later FLT, FLHTCUTG, FLHR, FLSTC and '93-'96 FLSTN models (replaces fender lamp assembly). (Does not fit Springer, FLHRS or FLTR Road Glide® models.)

**59315-98** Rear. **\$31.95**

Fits '80-'08 FLT, FLHR, FLSTC and '93-'96 FLSTN models (replaces fender lamp assembly). (Does not fit Springer, FLHRS or FLTR Road Glide® models.)



C. FLAMES FENDER TIP



D. "LIVE TO RIDE" LOGO FENDER TIP

### D. "LIVE TO RIDE" LOGO FENDER TIP

Made of durable ABS plastic. Includes mounting hardware and installation instructions.

**59068-96** Front. **\$31.95**

Fits '80-later FLT, FLHTCUTG, FLHR, FLSTC and '93-'96 FLSTN models (replaces fender lamp assembly). (Does not fit Springer, FLHRS and FLTR models.)

**59069-96** Rear. **\$31.95**

Fits '80-'08 FLT, FLHR, FLSTC and '93-'96 FLSTN models (replaces fender lamp assembly). (Does not fit Springer, FLHRS or FLTR Road Glide® models.)

### E. "H-D" CLASSIC FENDER TIP

Stock on Road King® Classic models, these nostalgic-look fender tips are also available for other models. Replaces fender lamp assembly.

**59002-98** Front. **\$31.95**

Fits '80-later FL, FLHR and FLHTCUTG models and '86-'08 FLSTC models.

**59052-98** Rear. **\$31.95**

Fits '80-'08 FL and FLHR models, and '86-'99 FLSTC models. (Does not fit FLSTF and FLTR models.)



E. "H-D" CLASSIC FENDER TIP



F. BAR & SHIELD LOGO FRONT FENDER SPEAR

### F. BAR & SHIELD LOGO FRONT FENDER SPEAR

This chrome-plated trim spear adds a sweeping dash of chrome to the front fender. Featuring a raised Bar & Shield logo set against a textured black field, this self-adhesive medallion is easy-to-install.

**91195-04** **\$39.95**

Fits Touring and FL Softail® models (except FLSTSB).

### G. CHROME FRONT FENDER TRIM KIT

Replace the Original Equipment stainless steel fender trim with a splash of chrome. Kit includes left and right side trim strip.

**59209-91T** **\$26.95**

Fits '82-later Touring models (except Road Glide and Road King Custom), FLHTCUTG, and '86-later FLST, FLSTN and FLSTC models. Does not fit models equipped with clean front fender.



G. CHROME FRONT FENDER TRIM KIT

Notice: The prices appearing in this catalog are the manufacturer's suggested retail prices. Actual retail prices may vary.

**H. SKULL FENDER SKIRT****I. FLAMES FENDER SKIRT****J. CHROME FENDER SKIRT****K. ROAD KING CLASSIC FENDER SKIRT****L. V-LOGO FENDER SKIRT****M. CONCHO FENDER SKIRT****H. SKULL FENDER SKIRT**

This decorative chrome-plated fender skirt is a direct replacement for stock fender skirt. Features a three-dimensional sculptured concho with skull design set off with black accents. Mounting hardware included.

**59582-02A****\$54.95**

Fits '80-later Touring models, '86-'06 FLSTC, '06 FLST and '93-'96 FLSTN models equipped with Original Equipment fender skirt.

**I. FLAMES FENDER SKIRT**

Designed as an easy-to-install replacement for the Original Equipment fender skirt, this chrome steel fender skirt features an embossed 3-D flame design. Kit includes mounting hardware.

**60179-06****\$54.95**

Fits '80-later Touring models, '86-'06 FLSTC, '06 FLST and '93-'96 FLSTN models equipped with Original Equipment fender skirt.

**J. CHROME FENDER SKIRT**

This rigid-steel fender skirt, designed to replace the original factory-equipped aluminum trim, is formed, polished, and chrome-plated. Its ribbed pattern offers a unique styling element and adds rigidity. Subtle but distinctive brushed aluminum Bar & Shield logos are framed by a stamped-in ribbed outline on both sides.

**59228-91****\$54.95**

Fits '80-later Touring models, '86-'06 FLSTC, '06 FLST and '93-'96 FLSTN models equipped with Original Equipment fender skirt.

**K. ROAD KING® CLASSIC FENDER SKIRT**

The latest in the family of Road King-inspired accessories, this chrome-plated steel fender skirt features four raised accent ribs and a die-cast Road King Classic medallion in chrome with black accents. Mounting hardware included.

**59005-98****\$54.95**

Fits '80-later Touring models equipped with Original Equipment fender skirt.

**L. V-LOGO FENDER SKIRT**

V-Logos are die-cast aluminum integrated with the fender skirt, then chrome-plated for a desirable shine. Includes all mounting hardware.

**59146-96****\$54.95**

Fits '80-later Touring models, '86-'06 FLSTC, '06 FLST and '93-'96 FLSTN models equipped with Original Equipment fender skirt.

**M. CONCHO FENDER SKIRT**

This decorative fender skirt features conchos inspired by the Heritage Softail® Classic motorcycle.

**59147-96****\$54.95**

Fits '80-later Touring models, '86-'06 FLSTC, '06 FLST and '93-'96 FLSTN models equipped with Original Equipment fender skirt.

# 422 TOURING

Chassis Trim

## A. FAT BOY® FRONT FENDER ADAPTER KIT

Add a true custom style to your Road King® model. This polished and chrome-plated Adapter Kit will allow you to install the smooth curving Fat Boy front fender on your Touring bike. Manufactured from 6061-T6 Billet Aluminum, this kit includes all necessary mounting hardware. Primed or Color-Matched fender sold separately.

**59013-02A** **\$84.95**  
Fits '00-later Touring models (except Trike). Does not fit Touring models equipped with fairing lowers.

## B. STUDED REAR FENDER MUD FLAP

Black mud flap with accenting decorative studs.

**59230-88** **\$29.95**  
Fits '08-earlier FLHT, FLHS, FLHRC, FLT, FLTR, '86-'90 FLST, '86-'06 FLSTF and '93-'96 FLSTN models. (Does not fit '09-later Touring or models with rear bumper rail.)

## C. ROAD KING® CLASSIC REAR FENDER MUD FLAP

Sturdy, black rubber mud flap features the Road King Classic logo.

**59385-98** **\$19.95**  
Fits '98-later FLHRC and FLTR models.

**59386-98** **\$19.95**  
Fits '79-later FLH, FLHT, FLT, '98-later FLTR, '79-'93 FLHS and '94-later FLHR. (Does not fit FLHX models.)

## D. ROAD KING CLASSIC REAR MUD FLAP

Mud flap features embossed leather to match the FLHRCI saddlebags and seat and includes Road King script.

**59765-98** **\$49.95**  
Fits '94-'08 FLHR, FLHRCI models. (Does not fit with Touring V-Logo Rear Fender Rail P/N 91100-94.)

## E. H-D® V-LOGO MUD FLAP – TRIKE

The noble red "H-D" V-logo is molded onto black rubber. Kit includes left and right mud flap, reinforcing brackets and mounting hardware.

**83833-09** **\$59.95**  
Fits '09-later Trike models.



A. FAT BOY FRONT FENDER ADAPTER KIT



B. STUDED REAR FENDER MUD FLAP



C. ROAD KING CLASSIC REAR FENDER MUD FLAP



D. ROAD KING CLASSIC REAR MUD FLAP



E. H-D V-LOGO MUD FLAP – TRIKE

Notice: The prices appearing in this catalog are the manufacturer's suggested retail prices. Actual retail prices may vary.



NEW

F

F. CHROME INNER PRIMARY COVER TRIM

**F. CHROME INNER PRIMARY COVER TRIM**

Get the look of a chrome inner primary cover without tearing apart the drive train. Designed to wrap the top surface of the painted inner primary cover, these mirror-chrome die-cast and steel shells provide a beefy finished look to the engine cases. Easy-to-install, the two-piece covers are secured with the outer primary hardware, and held in place at four points for quiet operation. The tight tolerances and smooth edges produce a solid, one-piece look. Kit includes required mounting hardware. For a complete custom look, consider adding a Chrome Cylinder Base Cover and Classic Chrome Socket Head Screw Covers (sold separately).

**60869-10****\$139.95**

Fits '07-later Touring and Trike models.

**G. CHROME VOLTAGE REGULATOR COVER**

This chrome-plated steel cover features an open-faced design to allow airflow through the voltage regulator. Chrome-plated mounting hardware included.

**74538-09****\$38.95**

Fits '09-later Touring models (except models with Oil Coolers). Will not fit models equipped with a sidecar.

**74543-00****\$38.95**

Fits '97-'08 Electra Glide®, Road Glide®, and Road King® models (except models with Oil Coolers). Will not fit '07-later models equipped with a sidecar.



NEW

G

G. CHROME VOLTAGE REGULATOR COVER – '09-LATER MODELS



G

G. CHROME VOLTAGE REGULATOR COVER – '97-'08 MODELS

**H. CHROME VOLTAGE REGULATOR**

Original Equipment Voltage Regulators with a sparkling triple-plated chrome finish. Hand-buffed, then copper-, nickel-, and chrome-plated, these brilliant chrome-plated regulators are the perfect highlight for any Harley-Davidson® motorcycle.

**74622-09**

Fits '09-later Touring models.

**\$169.95****74622-06**

Fits '06-'08 Touring models.

**\$169.95****74622-04**

Fits '04-'05 Touring models.

**\$169.95****74537-93A****\$109.95**

Fits '89-'95 1340 models, '96 FLT, FLHT, and FLHR models (except fuel injected), '96-'99 Softail® and '96-'98 Dyna® models.



H

H. CHROME VOLTAGE REGULATOR

Notice: The prices appearing in this catalog are the manufacturer's suggested retail prices. Actual retail prices may vary.



# 424 TOURING

## Hand Controls

### A. CHROME HAND CONTROL COMPONENTS

The flash of chrome. It's the first thing that everyone sees. And the one thing that everyone remembers. Dressing your bike's hand controls in chrome is one of the first steps in building a complete custom ride. After all, the hand controls are the one visual and physical connection you have with your bike every minute you are in the saddle. Harley-Davidson offers all the components you need to make the custom conversion.

A complete Chrome Hand Control makeover would include:

- Chrome Clutch Bracket and Master Cylinder Reservoir Kit
- Chrome Switch Housing Kit
- Chrome Switch Cap Kit
- Chrome Hand Control Levers
- Custom Hand Grips
- Custom Brake Lines and Control Cables

### B. CHROME CLUTCH BRACKET AND MASTER CYLINDER RESERVOIR KIT

Replace your stock painted aluminum controls with brilliant chrome, without compromising on quality. This kit is manufactured from the Original Equipment components, and includes Chrome Master Cylinder Cover. When combined with Chrome Switch Housing Kit, Chrome Switch Cap Kit and other Genuine Motor Accessories, this front brake control kit provides a look that does more than stop your bike – it'll stop traffic.

**42117-08** **\$384.95**  
Fits '08-later Touring models. (Does not fit models equipped with hydraulic clutch.)

**46418-05A** **\$329.95**  
Fits '05-'07 Touring and '06 Dyna and Softail models with dual disc front brakes. (Does not fit models equipped with hydraulic clutch.)

**45281-99D** **\$329.95**  
Fits '96-'03 XL, '96-'05 Dyna®, Softail® and '96-'04 Touring models with dual disc front brakes. (Does not fit models equipped with hydraulic clutch.)

**46112-02D** **\$399.95**  
Fits '02-'05 VRSC™ models. Also fits hydraulic clutch-equipped '96-'05 Dyna, Softail, and '96-'04 Touring models with dual disc front brakes.

### C. CHROME MASTER CYLINDER COVER

Includes one chrome-plated cover, gasket, and decal. Easily installed with included stainless steel screws.

**42123-08** **\$59.95**  
Fits '08-later Touring models.

**46424-05B** **\$34.95**  
Fits '05-'07 Touring and '06-later Dyna® and Softail® models.

**45078-96D** **\$34.95**  
Fits '96-'03 XL, '02-'05 VRSC™, '96-'05 Dyna, Softail and '96-'04 Touring models.



A. CHROME HAND CONTROL COMPONENTS



B. CHROME CLUTCH BRACKET AND MASTER CYLINDER RESERVOIR KIT – '08-LATER STYLE



B. CHROME CLUTCH BRACKET AND MASTER CYLINDER RESERVOIR KIT – '96-'07 STYLE



C. CHROME MASTER CYLINDER COVER – '08-LATER MODELS



C. CHROME MASTER CYLINDER COVER – '96-'07 MODELS

Notice: The prices appearing in this catalog are the manufacturer's suggested retail prices. Actual retail prices may vary.

# TOURING 425

Hand Controls



**D. CHROME SWITCH HOUSING KIT**



**E. CHROME SWITCH CAP KIT**

## D. CHROME SWITCH HOUSING KIT

Convert your housings from black to chrome with this complete kit. Includes left, right, upper and lower housings. No switches or wiring required. Installation instructions included.

**70222-96B \$139.95**

Fits '96-later VRSC™, XL, XR, Dyna®, Softail® and FLHR Road King® models. Does not fit FXSTDSE and FLHRSEI2 models.

**71813-09 \$149.95**

Fits '96-later FLHT, FLHTC, '06-later FLHX, FLTRX and FLHXXX models equipped with cruise control.

**70223-96B \$149.95**

Fits '96-later FLHT, FLHTC, '06-later FLHX, FLHXXX and FLTRX models without cruise control.

**70228-96C \$149.95**

Fits '96-later FLHTCU, FLHTK, FLTR and FLHTCUTG models and '02-later FLHRC models. Also fits '02-later FLHR models equipped with cruise control.

## E. CHROME SWITCH CAP KIT

Not satisfied until everything you see is chrome? These Chrome Switch Cap Kits will add style to one of the most visible areas of your bike, the switches. Shaped for the same ergonomic feel as the Original Equipment hand control switches, these caps replace the stock black caps without re-wiring. The chrome switch caps complement other chrome hand control accessories.

**71816-09 \$23.95**

Fits '96-later FLHT, FLHTC, FLHX, FLTRX and FLHXXX models equipped with cruise control.

**71804-03 \$18.95**

Fits '96-later XL, XR, Dyna, Softail and FLHR models, '02-later VRSC models, and '98-'01 FLHRC models. FLHR models equipped with cruise control use Kit P/N 71808-03.

**71803-03 \$19.95**

Fits '96-later FLHT, FLHTC, FLHX, FLTRX and FLHXXX models without cruise control.

**71802-03 \$23.95**

Fits '96-later FLHTCU, FLHTK, FLHTCUTG and FLTR models.

**71808-03 \$19.95**

Fits '02-later FLHRC/I models and FLHR models equipped with cruise control.

## F. CHROME HAND CONTROL LEVER KIT

Continue the chrome theme with these Hand Control Levers. Cast from aluminum, these levers feature a custom finish designed to match the accessory chrome hand controls or complement Original Equipment-style black components. Clutch anti-rattle clip and new pivot bushings included.

**38843-08 \$139.95**

Fits '08-later Touring models.

**45075-07 \$99.95**

Fits '96-'03 XL models and '96-'07 Dyna, Softail and Touring models. (Does not fit police models, VRSC models, or models equipped with hydraulic clutch.)

**46114-07 \$85.95**

Fits '02-'05 VRSC models and '96-'06 Dyna, Softail and Touring models equipped with hydraulic clutch.

NOTE: Reduces reach on '92-earlier models.

## G. BLACK HAND CONTROL LEVER KIT

Grab some black with these levers – a natural fit for black accessory handlebars or to further the blacked-out look of your motorcycle. A clutch anti-rattle clip and new pivot bushings are included.

**38845-08 \$139.95**

Fits '08-later Touring models.

**44994-07 \$99.95**

Fits '96-'03 XL models and '96-'07 Dyna, Softail and Touring models. (Does not fit Police models, VRSC models, or models equipped with hydraulic clutch.)

**46157-03 \$99.95**

Fits '02-'05 VRSC models and '96-'06 Dyna, Softail and Touring models equipped with hydraulic clutch.



**F. CHROME HAND CONTROL LEVER**



**G. BLACK HAND CONTROL LEVER**

TOURING

Notice: The prices appearing in this catalog are the manufacturer's suggested retail prices. Actual retail prices may vary.

# 426 TOURING

## Hand Controls

### A. CRUISE CONTROL KIT

For long-distance runs, there's nothing better than letting your bike do all the work. This Cruise Control Kit puts you just minutes away from true touring bliss. Simply install the new hand controls and module and you're ready to roll. No splicing into the wiring harness or taking off the tank to install. Kit includes updated switch housings, module and all necessary hardware.

**77196-08** **\$239.95**

Fits '08-later FLHX, FLHT, FLHTC, FLHXXX and FLTRX models.

**77197-08** Fits '08-later FLHR models. **\$239.95**

**77198-07** Fits '07 FLHRS models. **\$389.95**

**77197-07** Fits '07 FLHR models. **\$389.95**

**77196-07** **\$389.95**

Fits '07 FLHT, FLHX and FLHTC models.

**77198-04** Fits '04-'06 FLHRS/I models. **\$389.95**

**77197-04** Fits '04-'06 FLHR/I models. **\$389.95**

**77196-04** **\$389.95**

Fits '04-'06 FLHT/C/CI and '06 FLHX/I models.

**77182-02** **\$389.95**

Fits '02-'03 FLHT and FLHTC/I.

**77183-02** **\$389.95**

Fits '02-'03 FLHR and FLHRI.



A. CRUISE CONTROL KIT – '08-LATER MODELS



A. CRUISE CONTROL KIT – '02-'07 MODELS

### B. AUXILIARY ACCESSORY SWITCH HOUSING KIT

Keep your eyes on the road and your hands on the grips with these easy-to-reach Auxiliary Accessory Switch Housings. Available for left and right hand control clusters, these housings will allow you to install up to six switches (when two housings are used) to control various electrical devices. Available in satin black to match Original Equipment switch housings or a bright chrome finish to complement accessory Chrome Switch Housing Kits. All necessary mounting hardware is included. Switches sold separately.

Fits all '96-later XL, XR, Dyna®, Softail®, VRSC™ and '96-'07 Touring models. Does not fit models equipped with Large Diameter Handlebars or Tour-Pak® Mounted CD Changer P/N 77184-01. '04-later XL and XR models require separate purchase of (2) Screw P/N 3832M.

**70255-02B** Chrome Right Side. **\$34.95**

Fits all '96-later VRSC, XL, XR, Dyna, Softail and Touring models (except Trike). Does not fit models equipped with Large Diameter Handlebars or Tour-Pak Mounted CD Changer P/N 77184-01. '04-later XL and XR models require separate purchase of (2) Screw P/N 3832M.

**70213-02C** Chrome Left Side. **\$34.95**

**70248-02B** Black Left Side. **\$34.95**

Shown with:

#### AUXILIARY ON/OFF SWITCH KIT

Styled to match the Original Equipment hand controls. These Auxiliary On/Off switches allow you to control additional electrical accessories with the touch of a finger when installed in the Auxiliary Accessory Switch Housing. Switches sold individually.

**71718-02** **\$13.95**

Fits Auxiliary Accessory Switch Housing Kits P/N 70255-02B, 70256-02, 70213-02C, and 70248-02B.



B. AUXILIARY ACCESSORY SWITCH HOUSING KIT – CHROME (SHOWN WITH AUXILIARY ON/OFF SWITCH)



C. CHROME SWITCH CAP KIT – AUXILIARY ON/OFF SWITCH CAP

### C. CHROME SWITCH CAP KIT – AUXILIARY ON/OFF SWITCH CAP

Replace the stock black caps without re-wiring. The Chrome Switch Caps complement other chrome hand control accessories to complete the custom look.

**71656-07** **\$9.95**

Fits models equipped with Auxiliary On/Off Switch Kit 71718-02. Kit contains one chrome On/Off Switch Cap and two chrome plugs for use with Auxiliary Switch Housings equipped with P/N 71718-02.

### D. REDUCED EFFORT CLUTCH KIT

Kit includes a new clutch spring and inner/outer ramps that significantly reduce clutch lever effort. Original Equipment on '06-later Twin Cam-equipped models.

**36808-05** **\$44.95**

Fits '99-'05 Twin Cam-equipped models. Stock on '06-later Twin Cam-equipped models. This kit is not compatible with Screamin' Eagle® Performance Parts.



D. REDUCED EFFORT CLUTCH KIT



E. POLYURETHANE HANDLEBAR RISER BUSHINGS

Notice: The prices appearing in this catalog are the manufacturer's suggested retail prices. Actual retail prices may vary.



**F. CHROME THROTTLE AND  
IDLE CABLE ADJUSTER COVERS**



**G. CHROME THROTTLE CABLE CLIP**



**H. CHROME BILLET CLUTCH CABLE CLAMP**



**I. CHROME CLUTCH CABLE CLAMP COVER**



**J. CUSTOM BRAIDED CONTROL CABLES AND BRAKE LINES – STAINLESS STEEL SHOWN**

### E. POLYURETHANE HANDLEBAR RISER BUSHINGS

These Handlebar Riser Bushings replace the Original Equipment stacked rubber and zinc washer combination with a long-lasting polyurethane bushing and cover. The long-lasting one-piece bushing can reduce handlebar vibration.

**56298-03 \$39.95**

Fits '83-later Touring models (except Trike). '83-'93 models require use of '94-later Riser Mount Bolts P/N 3605.

### F. CHROME THROTTLE AND IDLE CABLE ADJUSTER COVERS

Replace the black rubber throttle and idle cable boots with brilliant chrome. This two-piece "ball-milled" dust cover offers a striking contrast to Original Equipment black cables, and a natural finishing touch when installing braided cables. Easy-to-install with included hardware.

**64115-04 \$59.95**

Fits '96-'07 Touring models (except FLHRS with Original Equipment handlebar), and '96-later FXSTB, FLSTS and '05-later FLSTN. Will fit '05-later Softail® models equipped with separate purchase of a Front Turn Signal Relocation Kit.

### G. CHROME THROTTLE CABLE CLIP

Tie up the loose ends to complete your custom ride. When matched to Original Equipment black cables or available braided cables, these chrome-plated clips link the throttle/idle cables with brilliant chrome.

**91274-04 \$29.95**

Fits '84-later models (except '08-later Touring and Trike).

### H. CHROME BILLET CLUTCH CABLE CLAMP

The perfect addition to braided or stock black clutch cables. This Clutch Cable Clamp is machined from billet aluminum, and polished and plated for a lasting shine. The clamp is designed to grip the cable and frame down tube, adding a custom look to the front of your cycle. Includes chrome-plated hardware.

**91252-03 \$39.95**

Fits models with 1-1/8" diameter front frame down tube ('84-'08 Touring models and '84-'99 Softail models).

**91249-04 \$39.95**

Fits '04-later XL and '09-later Touring models with 1-3/8" diameter front frame down tube.

### I. CHROME CLUTCH CABLE CLAMP COVER

It's all in the details. This high-polish chrome-plated clip replaces the plastic clutch cable clip on the frame tube, and locks the cable in place for a custom look. Kit includes chrome cable clip, and chrome hardware for easy installation.

**38792-05A \$28.95**

Fits '94-later Road King® models (except FLHRS models).

### J. CUSTOM BRAIDED CONTROL CABLES

Dress your bike for maximum custom impact. Harley-Davidson offers a choice of three braided cable finishes to match your customizing style.

Throttle and idle cable kits offer great looks and a smooth, precise action. Internal anti-friction inserts and cable pre-lubrication ensure long life and consistent performance. Kit includes throttle cable, idle cable and any necessary installation hardware.

Clutch cable kits feature anti-friction inserts and factory pre-lubrication to ensure smooth, long lasting cable operation. The internal cable seal eliminates the possibility of transmission fluid leaks, and the exclusive silicone boot attractively and effectively protects the cable adjuster components from moisture. Kit includes clutch cable, adjuster boot, and any necessary installation hardware.

*Refer to the Multi-Fit section pages 607–611 for specific model requirements.*

### CUSTOM BRAIDED BRAKE LINE KITS

Dress your bike for maximum custom impact. Harley-Davidson offers a choice of three braided brake line finishes to match your customizing style. Kits for dual disc models consist of three brake lines with a chrome-plated junction tee, while kits for single disc models consist of a single line.

*Refer to the Multi-Fit section pages 612–615 for specific model requirements.*

*Notice: The prices appearing in this catalog are the manufacturer's suggested retail prices. Actual retail prices may vary.*



# 428 TOURING

## Foot Controls

### A. CHROME REAR MASTER CYLINDER COVER

An easy way to add chrome to your bike is with this chrome-plated version of the stock master cylinder cover.

**46463-08** \$59.95

Fits '08-later Touring models (except Trike).

**46425-05A** \$29.95

Fit '05-'07 Touring and '06-later Softail® models.

**45149-99C** \$29.95

Fit '00-'05 Softail and '99-'04 Touring models.

### B. CHROME REAR MASTER CYLINDER KIT

Dress your foot controls in brilliant chrome. This kit replaces the black painted rear master cylinder with a polished and plated version, manufactured from Original Equipment components for proper fit and function. The kit includes the mirror-finish master cylinder body, matching chrome master cylinder cover and polished cover hardware.

**41777-05A** \$164.95

Fits '05-'07 Touring and '06-later Softail models.

**41775-04B** \$164.95

Fits '99-'04 Touring models and '00-'05 Softail® models.

### C. REAR MASTER CYLINDER COVER

Chrome-plated steel cover. Custom molded rubber retainer allows for easy installation and removal.

**45318-99** \$41.95

Fits '99-'07 Touring models without fairing lowers.

### D. CHROME JIFFY STAND BRACKET COVER

Chrome-plated cover conceals the black jiffy stand bracket for a cleaner appearance. Works with fairing lowers. No hardware required.

**50251-01** Fits '96-'07 Touring models. \$39.95

### E. JIFFY STAND EXTENSION KIT

This kit has been redesigned to add convenience and style to our existing jiffy stand. Polished and chrome-plated, it installs easily and includes all chrome hardware.

**50233-00** \$39.95

Fits '84-later Touring (except Trike) and '86-'06 Softail® models (except '05-'06 FLSTN).



A. CHROME REAR MASTER CYLINDER COVER – '08-LATER MODELS



A. CHROME REAR MASTER CYLINDER COVER – '99-'07 MODELS



B. CHROME REAR MASTER CYLINDER KIT



C. REAR MASTER CYLINDER COVER



D. CHROME JIFFY STAND BRACKET COVER



E. JIFFY STAND EXTENSION KIT

Notice: The prices appearing in this catalog are the manufacturer's suggested retail prices. Actual retail prices may vary.



**F. BILLET STYLE REAR BRAKE LEVER – CHROME**



**F. BILLET STYLE REAR BRAKE LEVER – SATIN BLACK**



**G. BILLET STYLE HEEL/TOE SHIFT LEVER – CHROME**



**G. BILLET STYLE HEEL/TOE SHIFT LEVER – SATIN BLACK**



**H. BILLET STYLE REAR BRAKE LEVER**



**I. BUCKSHOT HEEL/TOE SHIFT LEVER**

#### F. BILLET STYLE REAR BRAKE LEVER

Styled to complement our billet style mirror stems and shift levers, these Billet Style Rear Brake Levers are forged from 2014-T6 aluminum, then machined, polished and chrome-plated or powder-coated for a beautiful, custom look. Levers are available in mirror-chrome or satin black finish. Brake pedal pads sold separately.

Fits '08-later Touring models.

<b>42638-08A</b>	Chrome.	<b>\$164.95</b>
<b>46883-09</b>	Satin Black.	<b>\$164.95</b>

Fits '97-'07 Touring models.

<b>42638-03</b>	Chrome.	<b>\$164.95</b>
-----------------	---------	-----------------

#### G. BILLET STYLE HEEL/TOE SHIFT LEVER

Styled to complement our billet style mirror stems, these Billet Style Shift Levers are forged from 6061-T6 aluminum, then finish-machined and chrome-plated or powder-coated for a beautiful, custom look. Kit includes a front and rear lever and chrome hardware.

Fits '86-later FL Softail® and '88-later Touring models.

<b>34535-00B</b>	Chrome.	<b>\$139.95</b>
<b>34023-08</b>	Satin Black.	<b>\$139.95</b>

#### H. BILLET STYLE REAR BRAKE LEVER

Styled to complement our billet style mirror stems and shift levers, this Billet Style Rear Brake Lever is forged from 2014-T6 aluminum, then machined and chrome-plated for a beautiful, custom look. Brake pedal pads sold separately.

<b>42638-00A</b>		<b>\$159.95</b>
------------------	--	-----------------

Fits '87-'99 FLSTC, FLSTS, FLSTF and FLSTN models, and '97-'07 FLHT, FLHTC/I, FLHTCUI, FLHR/I, FLHRCL, FLTR/I models.

#### I. BUCKSHOT HEEL/TOE SHIFT LEVER

Styled to complement the Buckshot hand and foot control collection, this forged billet aluminum shift lever lends a custom look to your bike. The chrome lever features a deep groove perforated with counter-bored holes to catch the light and draw the eye. Kit includes front and rear shift lever and installation hardware.

<b>34558-05A</b>		<b>\$139.95</b>
------------------	--	-----------------

Fits '86-later FL Softail® and '88-later Touring models.

# 430 TOURING

## Foot Controls

### A. FOLDING HEEL SHIFTER

Give your left foot a little extra room. Folding Heel Shifter permits the rider to move the rear shift peg out of the way when on the open road, while retaining heel/toe shift functionality around town. Positive detent holds the peg in the selected position, and can be adjusted while riding. Easy to install, the replacement rear lever is chrome-plated, and shaped to match the Original Equipment toe shift lever. Lever accepts stock or accessory shifter peg.

**33876-07** **\$69.95**

Fits '86-later FL Softail® models and '88-later Touring models.

### B. HEEL/TOE SHIFTER SHAFT COVER

Conceal the splined end of the shifter shaft when you remove the heel shift lever. The easy-to-install chrome-plated aluminum billet cap is held in place with a flush Allen screw for a clean look.

**35471-05** **\$14.95**

Fits '82-later Touring and FL Softail models equipped with heel/toe shift levers. Installation requires removal of heel shift lever.

### C. CHROME GEAR SHIFT LINKAGE COVERS

A simple and inexpensive way to detail your Touring bike. These easy-to-install chrome-plated covers conceal the stock gear shifter linkage for a brilliant finish. Kit includes all necessary mounting hardware.

Fits '99-later Touring models with stock gear shift linkage.

**1. 46301-01** Diamond. **\$41.95**

**2. 46303-01** "Harley-Davidson" Script. **\$41.95**

**3. 46305-01** Engraved "Harley-Davidson". **\$41.95**



A. FOLDING HEEL SHIFTER – RETRACTED POSITION



B. HEEL/TOE SHIFTER SHAFT COVER



C. CHROME GEAR SHIFT LINKAGE COVER – "HARLEY-DAVIDSON" SCRIPT



C. CHROME GEAR SHIFT LINKAGE COVERS

Notice: The prices appearing in this catalog are the manufacturer's suggested retail prices. Actual retail prices may vary.



D. CUSTOM GEAR SHIFT LINKAGES

**D. CUSTOM GEAR SHIFT LINKAGES**

Kick your custom into gear with this collection of high-quality custom shift linkages. Available in a variety of designs to match your bike's style, these aluminum linkages feature aircraft quality rod ends for easy adjustment and smooth operation. The easy-to-install linkage kit includes a transmission lever cover and decorative acorn nuts and bolts for a complete custom look.

Fits '86-later Softail® and Touring models. (Does not fit '97-'99 FLSTS models, models equipped with Softail Extended Reach Forward Controls.)

1. 33857-09	FLHX Black Anodized.	<b>\$129.95</b>
2. 33915-09	Diamond Black.	<b>\$129.95</b>
3. 34018-08	Slotted with Bar & Shield Logo – Black Anodized.	<b>\$129.95</b>
4. 34604-09	Bullet.	<b>\$129.95</b>
5. 34850-09	Skull.	<b>\$129.95</b>
6. 33851-09	Road King Scripted.	<b>\$129.95</b>
7. 33840-09	Flame.	<b>\$149.95</b>
8. 33801-09	Harley-Davidson Scripted.	<b>\$129.95</b>
9. 33762-09	Ball-Milled with Bar & Shield Logo.	<b>\$129.95</b>
10. 33760-09	Slotted with Bar & Shield Logo.	<b>\$129.95</b>
11. 33884-09	Smooth with Bar & Shield Logo.	<b>\$109.95</b>
12. 33807-09	Buckshot.	<b>\$129.95</b>
13. 33823-09	Tribal.	<b>\$149.95</b>

**E. POLISHED STAINLESS STEEL GEAR SHIFT LINKAGES**

Kick your customizing into gear with this collection of high-quality, polished stainless steel shift linkages. Available in a variety of designs, the linkages feature aircraft quality rod ends, a stainless steel transmission lever cover and decorative acorn nuts and bolts for a complete custom look. The polished, stainless steel finish will last without chipping, peeling or discoloring. Easy to install.

Fits '86-later Softail® and Touring models. (Does not fit '97-'99 FLSTS models, models equipped with Softail Extended Reach Forward Controls.)

1. 33819-98A	Hex.	<b>\$129.95</b>
2. 33817-98A	Twisted.	<b>\$109.95</b>
3. 33814-98A	Round.	<b>\$89.95</b>

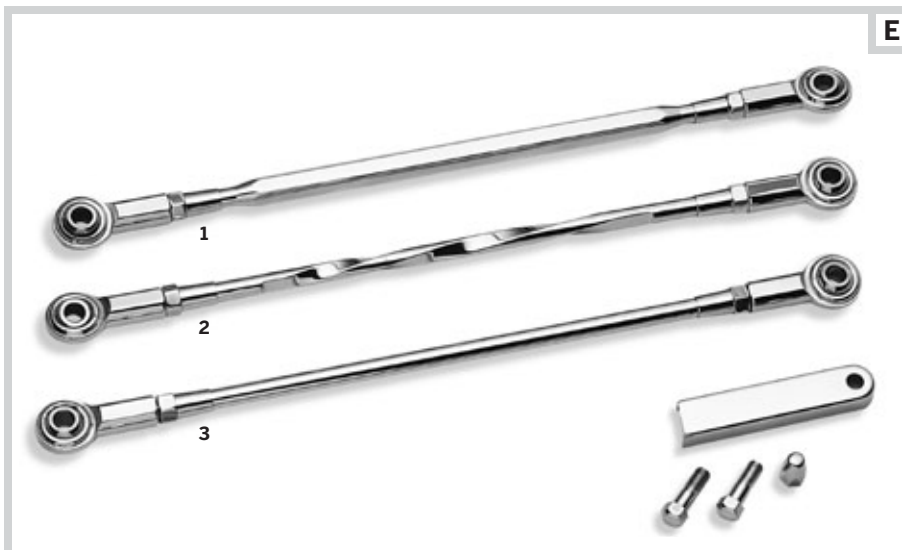

E. POLISHED STAINLESS STEEL GEAR SHIFT LINKAGES

Notice: The prices appearing in this catalog are the manufacturer's suggested retail prices. Actual retail prices may vary.



# 432 TOURING

## Engine Guards & Highway Pegs

### A. MUSTACHE ENGINE GUARD\*

Combine classic shape and modern function for a unique twist on engine protection. The flow of this engine guard complements the traditional style of the Touring models, while the gracefully curved upper section incorporates highway pegs into the shape. The integrated rubber pads offer a comfortable and slip-resistant cushion for your feet while traveling the open road. One-piece engine guard kit includes all required mounting hardware.

**49155-09A** \$249.95

Fits '09-later Touring models (except FLTR, FLTRX, FLHTCU, FLHTK and FLHTCUTG). Does not fit models equipped with fairing lowers.

**49155-05B** \$249.95

Fits '97-'08 Touring models (except FLTR).

Does not fit models equipped with fairing lowers.

### B. GLOSS BLACK ENGINE GUARD KIT\*

The classic Harley-Davidson® color is black. It shows your attitude and your desire to be different from the rest. These gloss black accessories are the ultimate extension of the Harley-Davidson® philosophy. Manufactured from Original Equipment components, these parts provide superior fit and finish.

**49050-09** Fits '09-later Touring models. \$209.95

**46549-03** Fits '97-'08 Touring models. \$209.95

### C. ADJUSTABLE HIGHWAY PEG MOUNTING KIT – ANGLED\*\*

Stretch out for added comfort. This chrome-plated Adjustable Highway Peg Mounting Kit can be set for shorter riders, and it can be reversed to reach far forward for those with long legs. The angled design allows the arm to reach back and around to clear fairing lowers. The arm can be raised and lowered for a custom fit. The mounting clamp firmly grips the engine guard, and the locking design secures the peg at the desired angle. Kit includes chrome-plated mounting hardware. Footpegs sold separately.

Fits 1-1/4" engine guards.

**50830-07A** Short Angled. \$109.95

**50829-07A** Long Angled. \$109.95



A. MUSTACHE ENGINE GUARD



B. GLOSS BLACK ENGINE GUARD KIT



C. ADJUSTABLE HIGHWAY PEG MOUNTING KIT – SHORT ANGLED



C. ADJUSTABLE HIGHWAY PEG MOUNTING KIT – LONG ANGLED



**\*WARNING:** Engine guards may provide limited leg and cosmetic vehicle protection under unique circumstances (fall over while stopped, very low speed slide). They are not made nor intended to provide protection from bodily injury in a collision with another vehicle or any other object.



**\*\*WARNING:** Do not use engine guard footpegs under normal stop and go operating conditions. Doing so could result in death or serious injury.



**\*\*WARNING:** Do not use highway pegs under normal stop and go operating conditions. Doing so could result in death or serious injury.

Notice: The prices appearing in this catalog are the manufacturer's suggested retail prices. Actual retail prices may vary.

# TOURING 433

Engine Guards & Highway Pegs



**D. ADJUSTABLE HIGHWAY PEG MOUNTING KIT – SHORT OFFSET**



**E. ADJUSTABLE HIGHWAY PEG MOUNTING KIT – 360°**

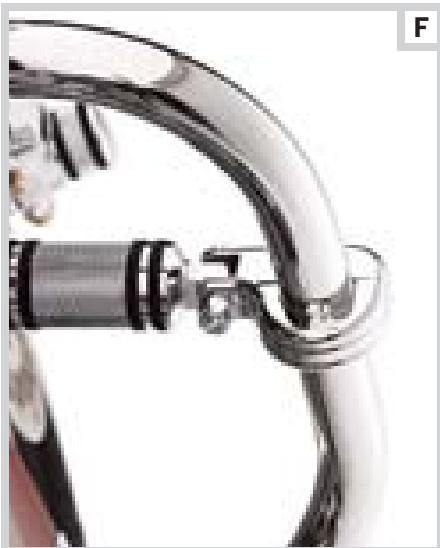

**F. CHROME BILLET ENGINE GUARD FOOTPEG MOUNTING KIT**



**G. CHROME DISPLAY STAND**



**H. CHROME CENTER STAND**

## D. ADJUSTABLE HIGHWAY PEG MOUNTING KIT – OFFSET\*

Take rider comfort to the next level. These Offset Adjustable Highway Peg Mounts allow the rider a wide range of adjustment to accommodate nearly every shape and size. The offset design allows installation on the side or top of the engine guard, and the 360 degree rotation permits comfortable positioning for short or tall riders. The clamp securely grips the engine guard, and the locking design keeps the peg at the desired angle. Kit includes chrome-plated clamp, adjustable arm, and chrome mounting hardware. Footpegs are sold separately.

Fits 1-1/4" engine guards.

<b>50828-07A</b>	Short Offset.	<b>\$129.95</b>
<b>50827-07A</b>	Long Offset.	<b>\$129.95</b>

## E. ADJUSTABLE HIGHWAY PEG MOUNTING KIT – 360°\*

Change your foot position for added comfort on long stretches of open road. The 360° Adjustable Highway Peg can be rotated and locked in a wide range of positions to accommodate both the tall and short rider. The chrome-plated clamp holds its place on the engine guard, and the arm locks the peg securely in position. Kit includes chrome-plated mount, arm, and installation hardware. Footpegs sold separately.

<b>50832-07A</b>	Fits 1-1/4" engine guards.	<b>\$109.95</b>
------------------	----------------------------	-----------------

## F. CHROME BILLET ENGINE GUARD FOOTPEG MOUNTING KIT\*

Here's a stylish way to get your feet into the wind. This beautifully polished and chrome-plated billet aluminum footpeg mount kit installs easily on your engine guard, and lets you stretch your legs on cross-country rides. Works with all H-D® male-mount footpegs.

<b>50957-02B</b>		<b>\$99.95</b>
------------------	--	----------------

Fits front engine guards with 1-1/4" diameter tubing (except VRSC™ Guard P/N 49267-01A, 49388-09, XL Engine Guard P/N 49060-04, 49215-07 or Softail® Nostalgic Engine Guard P/N 49037-05). Requires separate purchase of Chrome Bullet Tip Footpeg Bolt Kit P/N 94133-01.

## G. CHROME DISPLAY STAND

This Chrome Display Stand is perfect for ride-in shows. This brilliant polished chrome stand also makes it easier to check transmission fluid levels.

<b>99002-97A</b>		<b>\$249.95</b>
------------------	--	-----------------

Fits '97-'08 Touring models. Does not fit FLHRSE3/4, FLHTCUSE2/3 or '07-'08 Police models. Does not fit with oil coolers.

## H. CHROME CENTER STAND

Lifting your bike upright and off the side stand is ideal for cleaning and servicing, and reduces the space required for parking – handy where space is at a premium in a crowded garage, a small parking spot, or at a ride-in bike show. The robust Chrome Center Stand attaches directly to the frame and does not reduce the lean angle. Designed to work with all Original Equipment suspension configurations and with Profile suspension lowering kits, the adjustable feet can be set to lift the rear tire clear of the pavement, or to keep the rear tire on the ground for reduced lifting effort. The lifting lever is inconspicuously tucked away, and fits with all Harley-Davidson® Original Equipment and accessory footboards. Kit includes chrome stand, black mounting brackets, and all necessary installation hardware.

<b>91573-09</b>		<b>\$329.95</b>
-----------------	--	-----------------

Fits '09-later Touring models (except Trike) with Original Equipment or Profile® Low Suspension.

<b>91573-06</b>		<b>\$329.95</b>
-----------------	--	-----------------

Fits '99-'08 Touring models with Original Equipment or Profile® Low Suspension.



**\*WARNING:** Do not use engine guard footpegs under normal stop and go operating conditions. Doing so could result in death or serious injury.



**\*WARNING:** Do not use highway pegs under normal stop and go operating conditions. Doing so could result in death or serious injury.

Notice: The prices appearing in this catalog are the manufacturer's suggested retail prices. Actual retail prices may vary.

# 434 TOURING

## Footboards

### A. EXTENDED REACH RIDER FOOTBOARD PANS

This kit extends the rider footboard forward of the stock location, providing the tall rider a comfortable riding position. The kit includes left and right footboard pans, designed to accept traditional D-shaped Original Equipment or accessory rider footboard inserts.

**50409-04** **\$79.95**

Fits '02-later Touring models. Also fits '97-'01 Touring models equipped with Extended Reach Billet Style Brake Lever P/N 42638-03.

### B. BLACK RIDER FOOTBOARD PANS

Complete the blacked-out transformation. Replace the Original Equipment chrome footboard pans with sinister gloss black. Kit includes both the right and left pan, and is installed using the Original Equipment hardware and insert pad. Custom footboard inserts are sold separately.

Fits '86-later Touring and '86-later FL Softail® models.

**51322-08** Traditional Shape. **\$79.95**

**51060-08** Swept Wing Shape. **\$79.95**

### C. STREAMLINER RIDER FOOTBOARD KIT

Add the sleek sweeping footboard design from the Road King® Custom to your Touring bike. Kit includes vibration-isolation footboard pads with three chrome bands, and the complete chrome-plated pans that easily bolt in place of the Original Equipment footboards.

**50631-04** **\$179.95**

Fits '86-later Touring and '86-later FL Softail® models.

#### Shown with:

#### STREAMLINER BRAKE PEDAL PAD

Complement the streamlined footpegs and footboards with this simple-to-install Brake Pedal Pad. The chrome frame surrounds a black rubber pad accented with three chrome bands for style and grip.

**42712-04** Large. **\$54.95**

Fits '80-later Touring and '86-later FL Softail models.

### D. STREAMLINER PASSENGER FOOTBOARD AND MOUNT KIT

Styled to match the rider footboards on the Road King Custom, Road Glide Custom and Street Glide models, these Swept Wing Passenger Footboards feature a Streamliner-style rubber pad surrounded by a chrome accent. The smooth Swept Wing footboard pan is chrome-plated throughout to add a custom touch, even in the folded position. Designed for convenient bolt-on installation, the complete kit includes chrome-plated aluminum footboards, rubber pads, mounting hardware and installation instruction.

**50378-07A** **\$369.95**

Fits '93-later Touring models (except Trike).

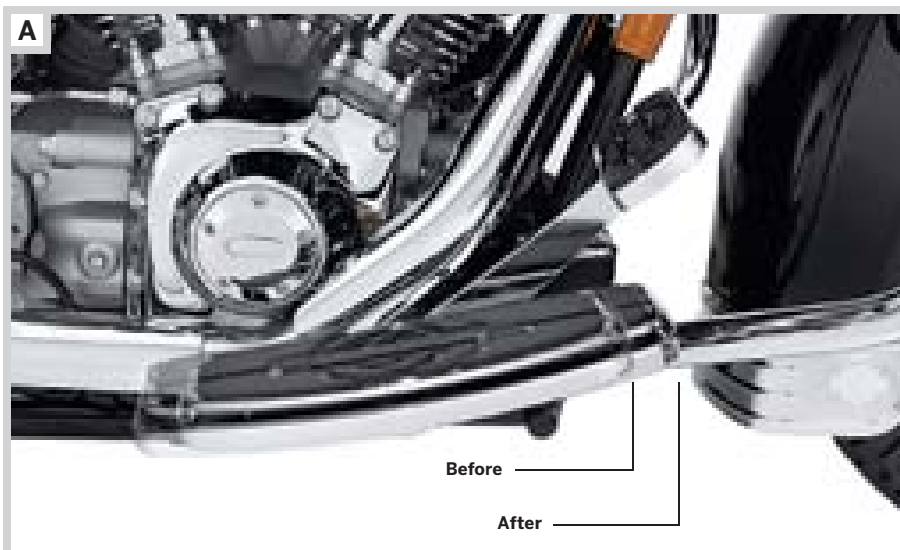

A. EXTENDED REACH RIDER FOOTBOARD PANS



B. BLACK RIDER FOOTBOARD PANS – TRADITIONAL SHAPE



B. BLACK RIDER FOOTBOARD PANS – SWEEP WING SHAPE



C. STREAMLINER RIDER FOOTBOARD KIT (SHOWN WITH BRAKE PEDAL PAD)



D. STREAMLINER PASSENGER FOOTBOARD AND MOUNT KIT

Notice: The prices appearing in this catalog are the manufacturer's suggested retail prices. Actual retail prices may vary.

# TOURING 435

Footboards



**E. PASSENGER FOOTBOARD AND MOUNT KIT**



**F. CHROME PASSENGER FOOTBOARD PANS**

## E. PASSENGER FOOTBOARD AND MOUNT KIT

Convenient bolt-on installation. Includes specially designed mounting stud/brackets for proper installation. Footboards fold up when not in use. Kit includes Original Equipment-style aluminum footboards, rubber pads, mounting hardware and installation instruction.

**50379-07B**

**\$134.95**

Fits '93-later Touring models.

## F. CHROME PASSENGER FOOTBOARD PANS

Replace the factory black painted passenger footboard with the custom look of smooth chrome. The kit includes left- and right-hand traditional D-shaped footboard pans, chrome-plated, and ready to install with your Original Equipment hardware. Just add your choice of footboard insert for the finishing touch.

**50752-04**

**\$169.95**

Fits '86-later Touring, '00-later Softail® and '06-later Dyna models equipped with passenger footboard supports.

## G. SWEEP WING PASSENGER FOOTBOARD PANS

These unique Swept Wing Passenger Footboard pans complement the Swept Wing Rider Footboard shape, and allows you to replace the Original Equipment passenger footpegs on certain models with footboards. When folded, the footboard displays a mirror-chrome surface in your choice of Smooth or ball-milled Grooved design. Footboard inserts and footboard supports sold separately.

Fits '86-later Touring models (except Trike), '00-later Softail® models and '06-later Dyna® models equipped with passenger footboard supports.

**50716-04** Smooth.

**\$139.95**

**50357-04** Grooved.

**\$169.95**

## H. HALF-MOON PASSENGER FOOTBOARDS

Styled to match the Half Moon Rider Footboards, these classic passenger footboards add both style and comfort to your nostalgic ride. Available in mirror-finish chrome or gloss black finish, the kit includes left and right footboard pan and vibration-isolation footboard inserts. Model-specific footboard mounts are sold separately.

Fits '86-later Touring (except Trike), '00-later Softail® and '06-later Dyna models equipped with passenger footboard supports.

**50807-08** Chrome.

**\$179.95**

**50810-08** Gloss Black.

**\$179.95**



**G. SWEEP WING PASSENGER FOOTBOARD PANS – GROOVED**



**G. SWEEP WING PASSENGER FOOTBOARD PANS – SMOOTH**



**H. HALF-MOON PASSENGER FOOTBOARDS – CHROME**



**H. HALF-MOON PASSENGER FOOTBOARDS – GLOSS BLACK**

TOURING

Notice: The prices appearing in this catalog are the manufacturer's suggested retail prices. Actual retail prices may vary.



# 436 TOURING

## Footboards

### A. ADJUSTABLE PASSENGER FOOTBOARD MOUNT KIT

Maximize your passenger's riding comfort. These 5-position Adjustable Mounts raise and lower the passenger footboard. The lowest position is 2" forward from stock, and the highest position is 2.5" higher than stock. Easy to adjust with a common hex wrench. Kit includes left and right adjustable support assembly and all required mounting hardware. Footboard pans and inserts sold separately.

Fits '93-later Touring models (except Trike).

**50768-07** Chrome. **\$349.95**

### B. REDUCED REACH PASSENGER FOOTBOARD MOUNT KIT

Kit raises the height of your passenger footboards by approximately 2-1/4" for increased passenger comfort. Especially desirable on '97-later Touring models due to the frame and saddlebag guard change. Includes mounting hardware.

**50789-99B** **\$124.95**

Fits '93-later Touring models (except Trike). Does not fit with saddlebag guard bags.

### C. CHROME PASSENGER FOOTBOARD SUPPORT KIT

Designed to mount the Passenger Footboard in the proper position, these highly polished and chrome-plated brackets add a custom look when the footboard is in the raised or lowered position.

**52714-04** Fits '96-'06 Touring models. **\$279.95**

### D. CHROME PASSENGER FOOTBOARD BRACKETS

Chrome for the ride home, this bracket is one more way for you to add style to your miles. Highly polished and chrome-plated, this bracket looks good whether the footboard is in the up or down position. Includes chrome hardware.

**53070-00A** **\$129.95**

Fits '93-later Touring models.



A. ADJUSTABLE PASSENGER FOOTBOARD MOUNT KIT - CHROME

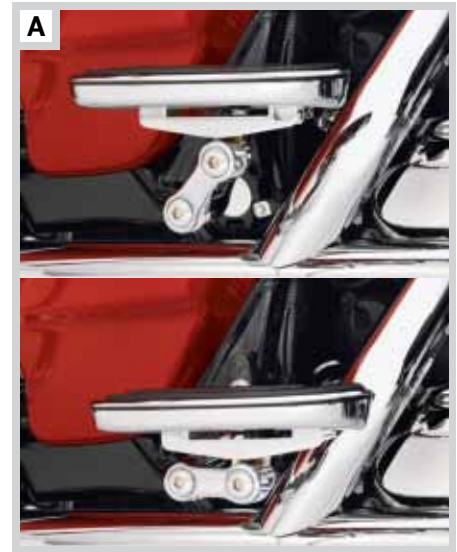

A. ADJUSTABLE PASSENGER FOOTBOARD MOUNT KIT - CHROME



B. REDUCED REACH PASSENGER FOOTBOARD MOUNT KIT - BEFORE



B. REDUCED REACH PASSENGER FOOTBOARD MOUNT KIT - AFTER



C. CHROME PASSENGER FOOTBOARD SUPPORT KIT



D. CHROME PASSENGER FOOTBOARD BRACKETS

Notice: The prices appearing in this catalog are the manufacturer's suggested retail prices. Actual retail prices may vary.



**E. CHROME PASSENGER FOOTPEG MOUNT KIT**



**F. ADJUSTABLE PASSENGER FOOTPEG MOUNT KIT**



**G. HEEL RAISER FOOTPEG KIT**



**G. HEEL RAISER FOOTPEG KIT**



**H. MINI FOOTBOARD KIT**



**H. MINI FOOTBOARD KIT**

**E. CHROME PASSENGER FOOTPEG MOUNT KIT**

Designed specifically for the sport-touring rider, this chrome-plated kit allows passenger footboards to be removed and replaced with a variety of male-mount style Harley-Davidson® footpegs. The kit has 3 adjustable height positions and includes all hardware.

**50198-97B**

**\$109.95**

Fits '93-later Touring models (except Trike).

**F. ADJUSTABLE PASSENGER FOOTPEG MOUNT KIT**

Maximize your passenger's riding comfort. Proper foot position reduces the cramped or stretched-out feeling, and relieves pressure on the knees and the tail bone. These Adjustable Mounts raise and lower the passenger footpeg to accommodate taller and shorter passengers. Easy to adjust with common tools, the mount adjusts through a 360° range (depending on model), allowing both fore and aft and up and down height adjustment. Kit includes left and right adjustable support assembly and all required mounting hardware. Footpegs sold separately.

**50763-09**

**\$149.95**

Fits models with H-D male mount style passenger footpeg supports (except Softail models). Does not fit with Heel Raiser Footpeg Kit P/N 50178-09. Does not fit the rider position.

**G. HEEL RAISER FOOTPEG KIT**

Comfort and cool, clean looks in one. Heel Raiser Chrome and Rubber Footpegs provide a large surface area that lets you change foot position for maximum comfort, and the fold-out heel rest provides floorboard-style support that relieves calf and thigh tension on the highway. The heel rest can be deployed or retracted with your boot while riding. The sole-gripping horizontal black rubber bands complement the mirror-chrome finish, and add vibration isolation and a rich appearance to the pegs. Complete the look with Shifter Pegs and Brake Pedal Pads from the Chrome and Rubber Collection. Heel Raiser mounts to the standard H-D style footpeg support, so it can be used in many rider and passenger applications.

**50178-09**

**\$189.95**

Fits H-D® male mount style footpeg supports (except the rider position on '02-later VRSCD/DX/F/R/X, '07-later XL883L, XL883N, XL1200N, '09-later XR, '08-later FXCW/C, and passenger position on Softail models). Fits mid-control equipped XL and Dyna models when equipped with engine guards and Highway Peg Mount P/N 50964-98 or 50957-02B. Does not fit with Adjustable Passenger Footpeg Support P/N 50763-09 or 50787-09, or Whiskers Adjustable Highway Bar P/N 50855-09 and 50865-09. Does not fit mid-control position.

**H. MINI FOOTBOARD KIT**

This Mini Footboard Kit can be installed in place of traditional footpegs and provides a little additional leg support and more options to move your feet around on a long run. Mini Footboards mount to standard H-D style footpeg supports, and can be used in many rider and passenger applications. A little larger than a bicycle pedal, Footboards can be pivoted to the proper angle for maximum riding comfort. The sole-gripping horizontal black rubber bands complement the mirror-chrome finish, and add vibration isolation and a rich appearance to the pegs. Complete the look with Shifter Pegs and Brake Pedal Pads from the Chrome and Rubber Collection.

**50451-09**

**\$109.95**

Fits models with forward controls (except FXCW/C, VRSCDX and VRSCF). Does not fit with mid-controls or with Frame Mounted Highway Pegs P/N 50855-09 and 50865-09. Fits passenger male mount style footpeg supports on most models (except '03-earlier XL, '06-earlier VRSC, '05-earlier Dyna, and FXSTD, FLSTSB, FLSTF, FLSTN and Softail models with shotgun exhaust). Softail passenger position also requires Support Kit P/N 50454-09.

# 438 TOURING

## Footboards

### A. V-LOGO PASSENGER FOOTBOARD COVERS

V-Logos are die-cast aluminum integrated with the cover, then chrome-plated for a desirable shine. Includes all mounting hardware.

**50194-96 \$64.95**

Fits '87-later Touring, '86-later FL Softail®, and '06-later Dyna® models equipped with traditional D-shaped aluminum passenger footboards.

### B. CONCHO PASSENGER FOOTBOARD COVERS

Heritage Softail® Classic-inspired conchos make these covers look great whether footboards are up or down.

**50193-96 \$74.95**

Fits '87-later Touring, '86-later FL Softail, and '06-later Dyna models equipped with traditional D-shaped aluminum passenger footboards.

### C. ROAD KING® CLASSIC PASSENGER FOOTBOARD COVERS

The latest in the family of Road King® Classic-inspired accessories, this chrome-plated steel footboard cover features a chrome die-cast Road King Classic medallion with black accents and a stylish leather accent piece. Mounting hardware included.

**50246-00 \$74.95**

Fits '87-later Touring, '86-later FL Softail, and '06-later Dyna models equipped with traditional D-shaped aluminum passenger footboards.

### D. SKULL PASSENGER FOOTBOARD COVERS

Chrome-plated steel footboard cover disguises the Original Equipment passenger footboard, and features a three-dimensional sculptured medallion with the "Harley-Davidson" skull logo. This easy-to-install kit includes all required mounting hardware.

**50836-07 \$74.95**

Fits '87-later Touring, '86-later FL Softail, and '06-later Dyna models equipped with traditional D-shaped aluminum passenger footboards.

### E. CHROME PASSENGER FOOTBOARD COVERS

Easy installation using chrome hardware.

**50782-91 \$64.95**

Fits '87-later Touring, '86-later FL Softail, and '06-later Dyna models equipped with traditional D-shaped aluminum passenger footboards.

### F. CHROME MUFFLER BRACKET COVER KIT

Brilliant stamped-steel cover conceals the Original Equipment exhaust brackets. Contoured for a custom fit, these easy-to-install mirror-chrome covers add a distinctive finishing touch. Sold in pairs.

**80716-08 \$59.95**

Fits '97-later Touring models (except Trike). Fits Screamin' Eagle® Street Performance Touring 4" Mufflers P/N 64985-07A and 80732-09. Does not fit with Fishtail 4" Muffler End Cap P/N 80616-07. Does not fit with Screamin' Eagle 3-1/2" Mufflers P/Ns 80490-07, 80491-07, 80677-08, 65467-05, 80463-06, or 65259-00.



A. V-LOGO PASSENGER FOOTBOARD COVER



B. CONCHO PASSENGER FOOTBOARD COVER



C. ROAD KING CLASSIC PASSENGER FOOTBOARD COVER

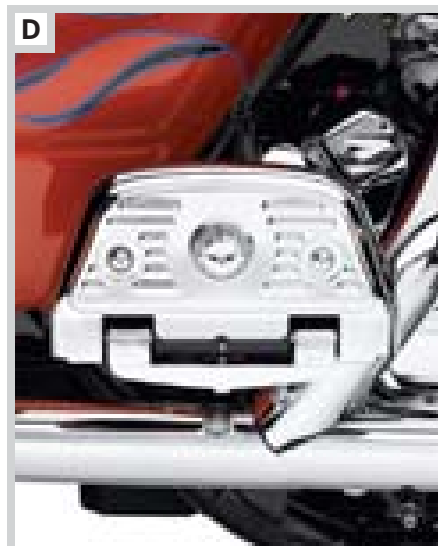

D. SKULL PASSENGER FOOTBOARD COVER



E. CHROME PASSENGER FOOTBOARD COVER



F. CHROME MUFFLER BRACKET COVER KIT

*Notice: The prices appearing in this catalog are the manufacturer's suggested retail prices. Actual retail prices may vary.*

# TOURING 439

Dash, Console & Gauges



G. FORK LOCK COVER – CLOSED



G. FORK LOCK COVER – OPEN

## G. FORK LOCK COVER

This chrome-plated aluminum die-cast cover finishes the look of the Road King® fork lock. The protective cover adds a finishing touch to the handlebar cover, and the smooth domed lid flips up to provide access to the fork lock. Includes chrome-plated flush-mount hardware.

**71790-05** Fits '94-later FLHR models. **\$49.95**

## H. "BULLSEYE" CONSOLE NUT

Replace your plain stock chrome acorn nut with this special chrome-plated Console Nut that features a machined "Bullseye" design highlighted with black accent rings.

**94755-99** **\$7.95**

Fits '90-'95 and '00-later Softail® models (except FXSTD, FXCW/C, FLSTSB and '09-later FLSTC), '93-'03 FXDWG, '94-'07 FLHR models.

## I. "BULLSEYE" CONSOLE WASHER

As a replacement for the plain stock washer on Road King models, this chrome-plated billet Console Washer features a three dimensional, machined-in "Bullseye" design, highlighted with black accent rings. A stainless steel mounting screw is provided and, once installed, is hidden under the black center insert with Bar & Shield logo.

**94753-99** **\$19.95**

Fits '94-'07 FLHR (except FLHRS) models and '84-later Softail tank panels with screw mounts.

## J. V-LOGO TURN SIGNAL INDICATOR FOR ROAD KING® MODELS

These Lighted Turn Signal Indicators add a subtle statement of style that accentuates the Road King motorcycle's nostalgic look.

**91578-00** **\$39.95**

Fits '94-'02 and '04-'07 FLHR and FLHRCI models.

## K. GAUGE VISOR RING

A touch of chrome makes all the difference. These easy-to-install trim rings feature an integrated eyebrow visor to shield the gauge face from the sun's glare. Self-adhesive backing for secure mount.

**74661-04** 4-5/8" Gauge. **\$24.95**

Fits '99-'08 FXDWG, '99-'07 Road King, and '99-later Softail models (except FXSTD, FXCW/C, FLSTFSE and Softail models equipped with Chrome Console P/N 67575-04).

**74662-04** 3-3/4" Gauge. **\$22.95**

Fits '99-later XL, Dyna® (except FXDWG) and '98-later Road Glide® models.



H. "BULLSEYE" CONSOLE NUT



I. "BULLSEYE" CONSOLE WASHER



J. V-LOGO TURN SIGNAL INDICATOR FOR ROAD KING MODELS



K. GAUGE VISOR RING

Notice: The prices appearing in this catalog are the manufacturer's suggested retail prices. Actual retail prices may vary.



# 440 TOURING

Dash, Console & Gauges

## A. PUSH-BUTTON FUEL TANK CONSOLE DOOR RELEASE

An added convenience you'll appreciate at fuel stops. This lockable replacement for your stock fuel tank console door lock allows the door to be opened without a key by depressing the center button of the lock. For basic security, it can be locked with any barrel key.

**53842-00C** **\$27.95**

Fits '92-later Electra Glide®, Street Glide®, Tour Glide, Road Glide® and Trike models.

## B. SMOOTH PUSH-BUTTON FUEL TANK CONSOLE DOOR RELEASE

Add stop-and-go speed at the gas pump. The smooth chrome-plated button replaces the lock for push-to-open convenience. No more digging in your pocket for the key. The large button is easy to operate while wearing gloves.

**53919-04A** **\$27.95**

Fits '92-later Electra Glide, Street Glide, Tour Glide, Road Glide and Trike models.

## C. THE WILLIE G.® SKULL COLLECTION FUEL TANK CONSOLE DOOR

Add a little attitude to your ride. Styled to complement Harley-Davidson® Skull accessory items, the menacing raised skull with black-filled eyes leaps from a field of chrome. The surrounding "Harley-Davidson Motorcycles" script is the perfect finishing touch.

**61308-09** **\$32.95**

Fits '08-later Electra Glide, Street Glide, Road Glide and Trike models.

**61374-04** **\$32.95**

Fits '92-'07 Electra Glide®, Tour Glide™ and Road Glide® models.

## D. THE FLAMES COLLECTION FUEL TANK CONSOLE DOOR

Ever since they began emerging on gas tanks a few decades ago, flames have been a symbol of custom styling. Now, Harley-Davidson continues the tradition with the Flames Collection.

**61319-09** **\$37.95**

Fits '08-later Electra Glide, Street Glide, Road Glide and Trike models.

**61359-98** **\$37.95**

Fits '92-'07 Electra Glide, Tour Glide and Road Glide models.

## E. THE HARLEY-DAVIDSON "LIVE TO RIDE" COLLECTION FUEL TANK CONSOLE DOOR

"Live To Ride, Ride to Live." It has become the motto of the Harley-Davidson nation, accompanying riders over millions of miles of travel. This collection is a tribute to that way of life.

**61335-09** **\$37.95**

Fits '08-later Electra Glide, Street Glide, Road Glide and Trike models.

**61286-92T** **\$37.95**

Fits '92-'07 Electra Glide®, Tour Glide™ and Road Glide® models.

## F. NUMBER ONE SKULL COLLECTION FUEL TANK CONSOLE DOOR

The sinister Harley-Davidson #1 Skull logo dresses for a night on the town. This complete die-cast aluminum collection has been polished and chrome-plated to a brilliant shine, then finished with a contrasting black-filled Dark Custom Skull logo.

**62378-10** **\$34.95**

Fits '08-later Electra Glide®, Street Glide®, Road Glide® and Trike models.



A. PUSH-BUTTON FUEL TANK CONSOLE DOOR RELEASE



B. SMOOTH PUSH-BUTTON FUEL TANK CONSOLE DOOR RELEASE



C. THE WILLIE G. SKULL COLLECTION FUEL TANK CONSOLE DOOR



D. THE FLAMES COLLECTION FUEL TANK CONSOLE DOOR



E. THE HARLEY-DAVIDSON "LIVE TO RIDE" COLLECTION FUEL TANK CONSOLE DOOR



F. NUMBER ONE SKULL COLLECTION FUEL TANK CONSOLE DOOR

Notice: The prices appearing in this catalog are the manufacturer's suggested retail prices. Actual retail prices may vary.

# TOURING 441

Dash, Console & Gauges



G

G. CHROME FUEL TANK CONSOLE

## G. CHROME FUEL TANK CONSOLE

Visually stretch the look of the fuel tank with this full-length tank console. This die-cast console has been polished and chrome-plated to a mirror-like finish, and is capped off with a satin and gloss black Bar & Shield insert. The kit is a direct replacement for the Original Equipment console, and can be used with the stock fuel door, or accented with any of the Harley-Davidson® accessory collection doors. Kit includes all necessary mounting hardware.

**71288-03A**

**\$189.95**

Fits '97-'07 FLHT, FLHTC and '98-'07 FLTR models. Installation requires the use of a Road King-Style seat. Will not fit FLHT or FLHTC models equipped with a CB Intercom Kit.

## H. CB INTERCOM CHROME CONSOLE

Add a sweep of style to your fuel tank. This chrome-plated console is a direct replacement for the Original Equipment black finish CB console. The easy-to-install console features a plug-in connection for the CB microphone.

**77140-05**

Fits '03-'07 FLHTCUI models.

**\$79.95**

## I. CB INTERCOM CHROME TRIM

Add a finishing touch to your dash. This chrome-plated stainless steel insert with black graphics fills the recess on the fuel tank-mounted CB radio pod, and is a direct replacement for the stock insert. The adhesive backing allows easy installation.

**13718-03**

Fits '03-'07 FLHTCUI models.

**\$17.95**

## J. CB INTERCOM CHROME TRIM

A stylish, high-quality replacement for the stock trim, these chrome-plated stainless steel inserts come complete with contrasting black print. Adhesive backed for easy installation.

**13739-00**

Fits '98-'02 FLHTCUI models.

**\$16.95**

## K. FAIRING MOUNT MIRRORS

Fairing Mount Mirrors offer a truly innovative look from the traditional handlebar-mounted mirrors. Mounting just inside the inner fairing, the molded plastic mirror housings complement the contours of the '96-later FLHT fairing. They provide a wide range of adjustability and feature convex mirror glass that maximizes your field of view. The Bar & Shield logo is carefully laser-etched on each mirror glass. Kit includes necessary hardware, instructions and mounting template for easy installation. For a finishing touch, add a splash of chrome with the available Chrome Mirror Covers P/N 91924-09 or Illuminated Covers P/N 92600-10.

**91945-98B**

**\$59.95**

Fits '96-later FLHT, FLHTC, FLHTCU, FLHTK and FLHTCUTG models.



H

H. CB INTERCOM CHROME CONSOLE



I

I. CB INTERCOM CHROME TRIM



J

J. CB INTERCOM CHROME TRIM



K

K. FAIRING MOUNT MIRRORS

TOURING

Notice: The prices appearing in this catalog are the manufacturer's suggested retail prices. Actual retail prices may vary.

# 442 TOURING

Dash, Console & Gauges

## A. CHROME INNER FAIRING TRIM KIT

Add a touch of luxury and style to your dash. This complete kit dresses the inner fairing by surrounding the radio faceplate and gauges with chrome. Package includes: Bar & Shield Radio Faceplate Trim, two Speedo/Tach Gauge Bezels, four Small Gauge Bezels, Radio and Gauge Faceplate Trim and two Front Speaker Trim Rings.

**96396-09 \$114.95**

Fits '06-later Electra Glide®, Street Glide® and Trike models equipped with the Advanced Audio System Radio.

## B. CHROME INSTRUMENT BEZEL SERIES

A touch of chrome makes all the difference.

### 1. Chrome Radio Trim Bezel

This bezel surrounds your radio with chrome and complements the Chrome Gauge Trim Bezels.

**74596-00 \$16.95**

Fits '98-'05 FLHTC and FLHTCU models. Also fits FLHT models with accessory radio.

### 2. Chrome Indicator Lamp Bezel Cover

As a complement to our existing chrome instrument bezel series, this Indicator Lamp Bezel Cover completes the look. Easy-to-install, chrome-plated steel stamping with adhesive backing.

**74562-98 \$14.95**

Fits '96-later Electra Glide, Street Glide and Trike models.

### Chrome Instrument Gauge Bezel Cover Kit

These bezel covers take just seconds to install and add the beauty of chrome to your dashboard.

**3. 74550-92T \$17.95**

Fits Voltmeter, Oil Pressure, Air Temp and Fuel Gauge on '86-later Electra Glide, Street Glide, Road Glide and Trike models. (pair)

**4. 74541-00 \$14.95**

Fits '00-later Speedometer and Tachometer Gauges on FLHT, FLTR, Trike, XL, and Dyna® (except FXDWG) models. (sold individually)

**4. 74560-96 \$21.95**

Fits Speedometer and Tachometer on '96-'99 FLHT and '98-'99 FLTR models. (pair)

## C. FAIRING DASH PAD

Original Equipment on the '06-'07 Screamin' Eagle® Electra Glide® Ultra model, this custom dash pad adds a recessed cockpit look to the inner fairing. The smooth top-stitched leather visor features a brilliant chrome-plated gauge eyebrow for a custom touch.

**58262-05 \$159.95**

Fits '97-later Electra Glide, Street Glide and Trike models.



A. CHROME INNER FAIRING TRIM KIT (SHOWN WITH FAIRING DASH PAD)



B. CHROME INSTRUMENT BEZEL SERIES



C. FAIRING DASH PAD

Notice: The prices appearing in this catalog are the manufacturer's suggested retail prices. Actual retail prices may vary.

# TOURING 443

Dash, Console & Gauges



D. RADIO AND GAUGE FACEPLATE TRIM

## D. RADIO AND GAUGE FACEPLATE TRIM

This chrome faceplate trim is installed on the raised section of the inner fairing and highlights the air temperature gauge, oil pressure gauge, indicator lamp and the radio. Trim can be installed with Chrome Instrument Gauge Bezels P/N 74550-92T for an added custom touch.

**74612-06** **\$27.95**  
Fits '96-later Electra Glide®, Street Glide® and Trike models.

## E. SKULL RADIO FACEPLATE

This brushed aluminum radio faceplate features the Harley-Davidson Skull Collection design in the upper corner. Simple self-adhesive installation on any model equipped with the Advanced Audio System Radio.

**77142-06** **\$14.95**  
Fits '06-later Touring models equipped with Advanced Audio System Radio.

## F. BAR & SHIELD LOGO RADIO FACEPLATE

This brushed aluminum radio faceplate features the Harley-Davidson Bar & Shield logo in the upper corner. Simple self-adhesive installation on any model equipped with the Advanced Audio System Radio.

**77143-07** **\$14.95**  
Fits '06-later Touring models equipped with Advanced Audio System Radio.

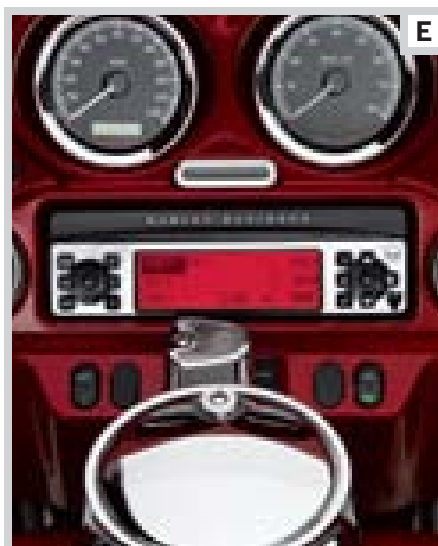

E. SKULL RADIO FACEPLATE



F. BAR & SHIELD LOGO RADIO FACEPLATE

## G. CHROME FRONT SPEAKER TRIM

Accented by a horizontal center bar with a Bar & Shield logo, this chrome-plated trim makes your speakers look as good as they sound. Convenient adhesive backing allows you to install the trim easily without removing the outer fairing. Made from lightweight ABS material.

**74604-99** **\$29.95**  
Fits '96-later Electra Glide®, Street Glide and Trike models with Original Equipment Speaker Grills.

## H. CHROME REAR SPEAKER TRIM

When it comes to styling, chrome always sounds great, especially when it's added to your rear speakers. These chrome-plated, steel trim bezels mount directly over the Original Equipment rear speaker grills, adding a subtle spot of chrome. Easy-to-install, the kit includes chrome-plated mounting hardware.

**74584-99** **\$34.95**  
Fits '98-later FLHTCU, FLHTK and FLHTCUTG models.



G. CHROME FRONT SPEAKER TRIM



H. CHROME REAR SPEAKER TRIM

Notice: The prices appearing in this catalog are the manufacturer's suggested retail prices. Actual retail prices may vary.



# 444 TOURING

Dash, Console & Gauges

## A. COLOR-MATCHED INNER FAIRING

Add a custom touch to your Electra Glide®, Street Glide® or Road Glide® motorcycle with a Color-Matched Inner Fairing and Fairing Cap. Designed to replace the Original Equipment matte black inner fairing, the color-matched finish offers a brilliant contrast to the gauge faces and accessory chrome instrument bezels.

Electra Glide kit includes inner fairing and fairing cap. Road Glide Kit includes inner fairing, instrument housing and glove box doors.

## B. PERSONAL ACCENTS CONSOLE INSERT COLLECTIONS

As a rider, there is probably no part of your bike you see more than your dash and tank console. And thanks to Personal Accents Inserts, it's also the easiest part of your bike to customize. Console inserts are available in a stylish assortment of finishes that blend with your personal direction. Matching Tour-Pak® Inserts are also available to complete the custom transformation.

Fits '08-later FLHR and FLHRC models.

1. 71939-08	Bar & Shield Logo.	\$54.95
2. 71971-08	Flamed.	\$54.95
3. 71972-08	Raised Skull.	\$54.95
5. 71973-08	Vivid Black.	\$54.95

Fits '94-'07 FLHR (except FLHRS) models.

2. 71161-05	Flamed.	\$49.95
3. 71373-05	Raised Skull.	\$49.95
4. 71256-07	Stacked Skull.	\$49.95
5. 71232-05	Vivid Black.	\$54.95

Fits '94-'07 FLHR (except FLHRS) models.

1. 71125-05	Bar & Shield.	\$74.95
2. 71168-05	Flamed.	\$74.95
4. 70905-07	Stacked Skull.	\$74.95
5. 71237-05	Vivid Black.	\$74.95

Fits '89-'07 FLHS, FLTR, FLH, FLHT, FLHTC, and FLTC models.

1. 71114-05	Bar & Shield.	\$49.95
2. 71149-05	Flamed.	\$49.95
3. 71370-05	Raised Skull.	\$49.95
4. 71131-07	Stacked Skull.	\$49.95
5. 71229-05	Vivid Black.	\$54.95

Fits '06-later FLHX and '04-'05 FLHTCSE models.

1. 71118-05	Bar & Shield.	\$29.95
2. 71153-05	Flamed.	\$29.95
3. 71371-05	Raised Skull.	\$29.95
4. 71138-07	Stacked Skull.	\$29.95
5. 71230-05	Vivid Black.	\$49.95

Fits '04-'07 FLHRS models.

3. 71372-05	Raised Skull.	\$49.95
5. 71231-05	Vivid Black.	\$54.95

Fits '08-later FLHT, FLHTC, FLTR and FLTRSE (except FLTRX) models.

1. 71924-08	Bar & Shield.	\$54.95
2. 71925-08	Flamed.	\$54.95
3. 71926-08	Raised Skull.	\$54.95
5. 71927-08	Vivid Black.	\$54.95

Fits '03-'07 FLHTCU models.

1. 71123-05	Bar & Shield.	\$29.95
2. 71165-05	Flamed.	\$29.95
3. 71376-05	Raised Skull.	\$29.95
5. 71235-05	Vivid Black.	\$29.95

Fits '08-later FLHX models.

1. 71900-08	Bar & Shield.	\$29.95
2. 71901-08	Flamed.	\$29.95
3. 71902-08	Raised Skull.	\$29.95
5. 71903-08	Vivid Black.	\$29.95

Fits King and Chopped Tour-Pak and Razor-Pak lids.

1. 71124-05	Bar & Shield.	\$49.95
2. 71167-05	Flamed.	\$49.95
3. 71377-05	Raised Skull.	\$49.95



A. ELECTRA GLIDE



A. ROAD GLIDE



B. PERSONAL ACCENTS CONSOLE INSERT COLLECTIONS

Notice: The prices appearing in this catalog are the manufacturer's suggested retail prices. Actual retail prices may vary.

# TOURING 445

Dash, Console & Gauges



Fairing Cap

Inner Fairing



Instrument Housing

Inner Fairing & Glove Box Doors

Color	<i>Fits '04-'07 Electra Glide and Street Glide models</i>	<i>Fits '08-later Electra Glide and Street Glide models (except Trike)</i>	<i>Fits '09-later Trike models</i>	<i>Fits '06-later Road Glide models</i>
Primed	58508-09BDK	58468-09BDK	—	58722-09BDK
Big Purple Flake	—	58468-09CWR	—	—
Black Cherry	58508-09BPS	—	—	58722-09BPS
Black Denim	—	58468-09BYM	—	58722-10BYM
Black Ice Pearl	—	58468-09CWL	—	—
Black Pearl	58508-09BPY	58468-09BPY	—	58722-09BPY
Brilliant Silver	—	—	—	58722-09BHT
Candy Red Sunglo	—	58468-09CPF	—	58722-09CPF
Chopper Blue	58508-09BPO	—	—	58722-09BPO
Copper Pearl	—	58468-09CPH	—	58722-09CPH
Copperhead Pearl	—	58468-09CPL	—	—
Crimson Red Denim	—	58468-09CPD	—	58722-09CPD
Crimson Red Sunglo	—	58468-09COZ	—	58722-09COZ
Dark Blue Denim	—	58468-09CPG	—	—
Dark Blue Pearl	—	58468-09CPC	83527-10CPC	58722-09CPC
Deep Cobalt	58508-09BXT	—	—	58722-09BXT
Deep Turquoise	—	58468-09CWN	—	—
Fire Red Pearl	58508-09BXY	—	—	58722-09BXY
Flame Blue Pearl	—	58468-09CWA	83527-10CWA	—
Glacier White Pearl	58508-09BHX	—	—	—
Golden Glow	—	58468-09CPJ	—	—
Impact Blue	—	—	—	58722-09BBP
Jake Blue	58508-09CHY	—	—	—
Lava Red Sunglo	58508-09BJK	—	—	—
Light Candy Root Beer	—	58468-09CWT	—	—
Luxury Blue	58508-09XE	—	—	—
Luxury Teal	58508-09BHV	—	—	58722-09BHV
Merlot Sunglo	—	58468-10DCE	—	—
Mirage Orange Pearl	—	—	—	58722-09BNR
Olive Pearl	58508-09CGV	—	—	—
Pacific Blue Denim	58508-09CHG	—	—	—
Pacific Blue Pearl	58508-09CGP	—	—	58722-09CGP
Pewter Denim	58508-09CHH	58468-09CHH	—	—
Pewter Pearl	58508-09CGR	58468-09CGR	—	58722-09CGR
Purple Haze	—	58468-09CPK	—	—
Red Hot Denim	—	58468-09CYE	—	58722-09CYE
Red Hot Sunglo	—	58468-09CYS	83527-10CYS	58722-09CYS
Rich Sunglo Blue	58508-09BPV	—	—	—
Scarlet Red	—	58468-10DBJ	—	58722-10DBJ
Sierra Red	58508-09BHS	—	—	58722-09BHS
Smokey Gold	58508-09BJL	—	—	58722-09BJL
Suede Blue Pearl	58508-09CGT	—	—	—
Sunset Yellow Pearl	—	—	—	58722-09CPE
Vivid Black	58508-09DH	58468-09DH	83527-10DH	58722-09DH
White Gold Pearl	58508-09CGS	58468-09CGS	—	—
White Ice Pearl	—	58468-10DBV	—	—
Yellow Pearl	—	—	—	58722-09BPZ
<b>PRIMED</b>	<b>\$429.95</b>	<b>\$429.95</b>	<b>\$429.95</b>	<b>\$795.95</b>
<b>COLOR-MATCHED</b>	<b>\$529.95</b>	<b>\$529.95</b>	<b>\$529.95</b>	<b>\$995.95</b>

# 446 TOURING

Dash, Console & Gauges

## COMBINATION SPEEDOMETER/TACHOMETERS

Maintain the clean view over the handlebar. This unique Combination Speedometer/Tachometer allows you to monitor engine speed without adding a handlebar-mounted tach. The unit mounts in the stock dash opening and is a direct plug-in installation.

### A. COMBINATION SPEEDOMETER/TACHOMETER – COLOR-MATCHED LIGHTING

Utilizing the trip reset push-button, the multi-color LED lighting system allows the rider to adjust the backlighting of the gauge to the color of choice. With over 600 color tone options, the gauge lighting can be matched to any paint scheme or viewing preference. The gauge features an easy-to-read LCD odometer/tripmeter. Mileage reinstatement is available through your Dealer.

Fits '08-later Road King® models.

**74745-08** MPH. **\$499.95**

**74747-08** KPH. **\$499.95**

Fits '07 Dyna® FXDC, FXDWG, Softail®, and Road King® models.

**74676-07** MPH. **\$499.95**

**74677-07** KPH. **\$499.95**

### B. COMBINATION SPEEDOMETER/TACHOMETER – SPUN ALUMINUM FACE

The backlit face aids night viewing and the gauge features an easy-to-read LCD odometer/tripmeter. Mileage reinstatement available through your Dealer.

Fits '08-later Road King models.

**74753-08** MPH. **\$499.95**

**74755-08** KPH. **\$499.95**

Fits '07 Dyna FXDC, FXDWG, Softail, and Road King models.

**74718-07** MPH. **\$499.95**

**74719-07** KPH. **\$499.95**

### C. COMBINATION SPEEDOMETER/TACHOMETER – NOSTALGIC FACE

Styled to match the Nostalgic Face gauges. The backlit face aids night viewing, and the gauge features an easy-to-read LCD odometer/tripmeter. '08-later fitments include color-matched adjustable backlighting. Mileage reinstatement is available through your Dealer.

Fits '08-later Road King models.

**74749-08** MPH. **\$499.95**

**74751-08** KPH. **\$499.95**

Fits '07 Dyna FXDC, FXDWG, Softail, and Road King models.

**74556-07** MPH. **\$449.95**

**74557-07** KPH. **\$449.95**

Fits '04-'06 Dyna FXD35, FXDWG, Softail, and Road King models.

**74556-04** MPH. **\$449.95**

**74557-04** KPH. **\$449.95**



A. COMBINATION SPEEDOMETER/TACHOMETER – COLOR-MATCHED LIGHTING



B. COMBINATION SPEEDOMETER/TACHOMETER – SPUN ALUMINUM FACE



C. COMBINATION SPEEDOMETER/TACHOMETER – NOSTALGIC FACE

Notice: The prices appearing in this catalog are the manufacturer's suggested retail prices. Actual retail prices may vary.

# TOURING 447

Dash, Console & Gauges



**D. COMBINATION SPEEDOMETER/TACHOMETER ('03 MODEL SHOWN)**

## D. COMBINATION SPEEDOMETER/TACHOMETER

Maintain the clean view over the handlebar. This unique Combination Speedometer/Tachometer allows you to monitor engine speed without adding a handlebar-mounted tach. The unit mounts in the stock dash opening, and is a direct plug-in installation. The backlit face aids night viewing, and the gauge features an easy-to-read LCD odometer/tripmeter. Mileage reinstatement is available through your Dealer.

Fits '07 Dyna® FXDC, FXDWG, Softail®, and Road King® models.

<b>74549-07</b>	MPH.	<b>\$499.95</b>
<b>74555-07</b>	KPH.	<b>\$499.95</b>

Fits '04-'06 Dyna FXD35, FXDWG, Softail, and Road King models.

<b>74549-04</b>	MPH.	<b>\$499.95</b>
<b>74555-04</b>	KPH.	<b>\$499.95</b>

Fits '95-'03 FLHR models and '00-'03 Softail® models (except FXSTD). '95-'98 FLHR models require Speedo/Tach Installation Kit P/N 74468-03. (shown)

<b>74461-03A</b>	MPH.	<b>\$449.95</b>
<b>74471-03A</b>	KPH.	<b>\$449.95</b>

### Speedometer/Tachometer Installation Kit

Allows the installation of the Harley-Davidson® Combination Speedometer/Tachometer on older models.

<b>74468-03</b>		<b>\$59.95</b>
-----------------	--	----------------

Required to install Speedometer/Tachometer Kit on '95-'98 FLHR, FXDWG, and '96-'98 Softail models.

## E. SPUN ALUMINUM FACE SPEEDOMETERS

Add a touch of luxury and style to your dash. First featured on the '04 Screamin' Eagle® Deuce™ and Electra Glide® motorcycles, these spun aluminum gauges offer a rich contrast to a chrome console or black inner fairing surface. The gauges feature subtle Harley-Davidson racing orange backlighting for a unique night-time look. Mileage reinstatement is available through your Dealer.

Fits '04-'06 Dyna® FXDWG, Softail®, and Road King® models, and '06 Dyna FXD35 and '07 FXDC models.

<b>67313-05A</b>	MPH.	<b>\$199.95</b>
<b>67315-05A</b>	KPH.	<b>\$199.95</b>

## F. NOSTALGIC FACE SPEEDOMETER

The single numbers and pearl white sweep are the modern interpretation of a classic era speedometer face. This retro style gauge features subtle backlighting for easy night viewing, and an easy-to-read LCD odometer/tripmeter. Original Equipment on the Softail Deluxe, this speedometer mounts in the stock dash opening, and is a direct plug-in replacement. Mileage reinstatement is available through your Dealer.

<b>67566-05A</b>	MPH.	<b>\$199.95</b>
------------------	------	-----------------

Fits '04-'06 FXDWG and Softail, '06 FXD35, '07 FXDC, and '04-'06 non-cruise control equipped Road King models.



**E. SPUN ALUMINUM FACE SPEEDOMETER**



**F. NOSTALGIC FACE SPEEDOMETER**

Notice: The prices appearing in this catalog are the manufacturer's suggested retail prices. Actual retail prices may vary.



# 448 TOURING

Dash, Console & Gauges

## A. 2-5/8" MINI TACH KITS WITH SHIFT LIGHT

Now available with an attention-grabbing rider-selectable shift light, these chrome-plated, 0-8,000 RPM Mini Tachometers add style and function. Measuring 2-5/8 inches in diameter, these chrome-plated tachs boast superior illumination and high-quality construction. The hard-coated lens is both fog and scratch-resistant and is ultrasonically welded to the case, resulting in a strong, reliable seal. Tested to the highest industry standards, each kit is specifically designed for each model, with styling that matches current speedometer graphics, including a lighted pointer. Complete wiring, hardware, and installation instructions are included. (NOTE: Mini Tach Kits are not compatible with windshield bags.)

Fits '96-'03 and '07-later XL Custom, '96-later FXDWG, '06 FXD35, '07-later FXDC, '08-later FXDF, '84-later FX Softail® (except FXCW/C), '86-later FL Softail (except '07-later FLSTF and FLSTFB), and '94-later Road King® models equipped with Mini Tach Mounting Bracket. Separate purchase of application-specific Mounting Bracket and Gauge Housing is required.

<b>69828-06</b>	Spun Aluminum Face.	<b>\$229.95</b>
<b>69829-06</b>	Black Face.	<b>\$229.95</b>



A. 2-5/8" MINI TACH KITS WITH SHIFT LIGHT – SPUN ALUMINUM FACE



A. 2-5/8" MINI TACH KITS WITH SHIFT LIGHT – BLACK FACE

## B. 2-5/8" MINI TACH MOUNTING BRACKET – NACELLE

Polished and plated to a brilliant shine, this steel bracket is designed to mount a 2-5/8" Mini Gauge at the ideal viewing angle. Designed for specific applications, these brackets are easy-to-install, and do not interfere with hand controls or indicator lights. Gauge installation requires separate purchase of Gauge Housing.

**67231-04A** **\$54.95**

Fits '94-later FLHR models (except FLHRSEI or FLHRS) with H-D® Mini Tach Kit (Mini Tach sold separately). Also fits '86-later FL Softail® models equipped with Chrome Headlight Nacelle P/N 67907-96B. (Does not fit with Fat Handlebars and Beach Bars.)

Shown with:

### 2-5/8" MINI TACH KITS

Add style and function with these chrome-plated, 0-8,000 RPM mini tachometers. Measuring 2-5/8 inches in diameter, these chrome-plated tachs boast superior illumination and high-quality construction. Complete wiring, hardware, and installation instructions are included. (NOTE: Mini Tach Kits are not compatible with Windshield Bags.)

Fits '96-'03 and '07-later XL Custom, '96-later FXDWG, '06 FXD35, '07-later FXDC, '08-later FXDF, '84-later FX Softail® (except FXCW/C), '86-later FL Softail (except '07-later FLSTF and FLSTFB), and '94-later Road King® models equipped with Mini Tach Mounting Bracket. Separate purchase of application-specific Mounting Brackets and Gauge Housing is required.

**68953-04** Black Face. **\$209.95**



B. MINI TACH MOUNTING BRACKET – NACELLE (SHOWN WITH BLACK FACE MINI TACH)



C. CHROME BILLET MINI TACH MOUNT – NACELLE

## C. CHROME BILLET MINI TACH MOUNT – NACELLE

Chrome-plated aircraft quality aluminum Mini Tach Mount adds a custom addition to your Road King® model. Scalloped lower edge assembles directly to your stock handlebar clamp cover, for a one-piece look. Add the appropriate 2-5/8" Mini Gauge and gauge housing (*sold separately*) to complete the custom look.

**68961-98A** **\$119.95**

Fits '94-later FLHR models (except FLHRSEI or FLHRS) with H-D Mini Tach Kit (Mini Tach sold separately). Also fits '86-later FL Softail® models equipped with Chrome Headlight Nacelle P/N 67907-96B. (Does not fit with Fat Handlebars and Beach Bars.)

## D. MINI TACH CYLINDRICAL GAUGE HOUSING

Finish your gauge installation in style. Chrome-plated steel housing features a flat bottom and cylindrical shape for a traditional appearance.

**67523-04** **\$59.95**

Fits models equipped with 2-5/8" Mini Tach and appropriate mounting bracket.

## E. MINI TACH TAPERED GAUGE HOUSING

Housing features a "tapered look" to dress up the Mini Tach for a sleek appearance. Easy replacement for the original Mini Tach gauge housing.

**67524-04** **\$24.95**

Fits models equipped with 2-5/8" Mini Tach and appropriate mounting bracket.



D. MINI TACH CYLINDRICAL GAUGE HOUSING



E. MINI TACH TAPERED GAUGE HOUSING

Notice: The prices appearing in this catalog are the manufacturer's suggested retail prices. Actual retail prices may vary.

# TOURING 449

Dash, Console & Gauges



NEW

F

**F. OIL LEVEL AND TEMPERATURE DIPSTICK WITH LIGHTED LCD READOUT – BLACK**



NEW

F

**F. OIL LEVEL AND TEMPERATURE DIPSTICK WITH LIGHTED LCD READOUT – CHROME**

**F. OIL LEVEL AND TEMPERATURE DIPSTICK WITH LIGHTED LCD READOUT**

New and improved "capacitive" level sensing technology provides the highest degree of accuracy and durability. Now available in chrome and black, these dipsticks allow you to check your oil level and oil temperature with the push of a button. Add function and style by replacing your stock dipstick with this hard working version. No more grabbing a rag to pull your hot dipstick. No more oil drips on your pipes and on the garage floor. Simply push the button and this dipstick lights up with a brilliant backlight. Oil level is indicated by a four-segment readout - it even reminds you to check your oil when it is hot. Designed to be waterproof, the LCD display operates on a long-lasting, replaceable Lithium coin-type battery (CR2032 3V, P/N 66373-06). Display features a low battery indicator, and press-and-hold feature to toggle between Fahrenheit and Celsius.

Fits '07-later Touring models (except Trike models and models equipped with a sidecar).

<b>63004-09</b>	Chrome.	<b>\$139.95</b>
<b>63030-09</b>	Black.	<b>\$139.95</b>

Fits '02-'06 Touring models (except models equipped with a sidecar). Also fits '99-'01 Touring models equipped with Chrome Oil Filler Spout P/N 62470-02, 62453-02 or 62454-02A.

<b>62946-09</b>	Chrome.	<b>\$139.95</b>
<b>63131-09</b>	Black.	<b>\$139.95</b>



G

**G. CLUTCH LEVER BRACKET CLAMP CLOCK – BLACK FACE**



G

**G. CLUTCH LEVER BRACKET CLAMP CLOCK – SILVER FACE**

**G. CLUTCH LEVER BRACKET CLAMP CLOCK**

The freedom of the open road dictates the final destination, but sometimes you need to be there on time. Designed to mount to your Clutch Lever Bracket Clamp, this polished stainless steel clock will keep you on schedule. Styled to match Original Equipment gauge design, the clock is available with black or silver face. Waterproof to 3 atmospheres so you don't have to worry when the weather turns bad.

Fits all models. Not compatible with Auxiliary Accessory Switch Housing Kits.

<b>75041-03</b>	Black Face.	<b>\$59.95</b>
<b>75042-03</b>	Silver Face.	<b>\$59.95</b>



H

**H. MASTER CYLINDER CLAMP THERMOMETER – BLACK FACE**



H

**H. MASTER CYLINDER CLAMP THERMOMETER – SILVER FACE**

**H. MASTER CYLINDER CLAMP THERMOMETER**

Designed to mount to the Brake Master Cylinder Clamp, this polished stainless steel temperature gauge will keep you in touch with the outside air temperature. Styled to match the Original Equipment gauge design and the Clutch Lever Bracket Clamp Clock, the thermometer is available with black or silver face. This waterproof gauge is simple to install.

Fits all models. Not compatible with Auxiliary Accessory Switch Housing Kits.

<b>75102-04</b>	Black Face, Fahrenheit.	<b>\$59.95</b>
<b>75104-04</b>	Silver Face, Fahrenheit.	<b>\$59.95</b>
<b>75108-06</b>	Black Face, Celsius.	<b>\$69.95</b>
<b>75115-06</b>	Silver Face, Celsius.	<b>\$69.95</b>

**I. BILLET ANALOG CLOCK**

Housed in a billet aluminum case, this unique Analog Clock provides a simple solution to telling time on the road. Strong double-sided tape attaches this water-resistant clock to your master cylinder housing. The available chrome or black finish complements the controls on your bike.

Fits all models. Not compatible with Auxiliary Accessory Switch Housing Kits.

<b>75055-03</b>	Chrome Finish.	<b>\$54.95</b>
<b>75054-03</b>	Black Finish.	<b>\$54.95</b>



I

**I. BILLET ANALOG CLOCK – CHROME**



J

**J. OIL PRESSURE GAUGE KIT**

**J. OIL PRESSURE GAUGE KIT**

Check your oil pressure at a glance with this oil-filled Pressure Gauge Kit, specifically designed to look good, fit right, and perform properly on your Twin Cam-equipped motorcycle. The custom mounting brackets have been polished and chrome-plated to rigid Harley-Davidson standards and the gauge offers premium reliability. The kit includes all necessary hardware and mounting brackets for quick and clean installation.

**75133-99** **\$84.95**

Fits '99-'05 Dyna® models, '00-later Softail® models, and '99-later FLHT (except Trike) and FLHR models. Does not fit with Billet Rocker Box Covers P/N 17658-03.

*Notice: The prices appearing in this catalog are the manufacturer's suggested retail prices. Actual retail prices may vary.*

TOURING

# 450 TOURING

Dash, Console & Gauges

## A. TITANIUM FACE GAUGES

Add a rich, custom look to your dash. First featured on the '10 FLHTK Ultra Limited model, these black and icy cool "titanium" numbered gauges feature white LED backlighting and large, easy-to-read numbers for at-a-glance viewing. Gauges are plug-in ready, and require no additional splicing or re-wiring for installation. Mileage reinstatement is available through your Dealer.

Fits '08-later Touring (except Road King®) and Trike models.

<b>74682-10</b>	4" Speedometer – MPH.	<b>\$159.95</b>
<b>74683-10</b>	4" Speedometer – KPH.	<b>\$159.95</b>
<b>74692-10</b>	4" Tachometer.	<b>\$159.95</b>
<b>74688-10</b>	Fuel Gauge.	<b>\$49.95</b>
<b>74689-10</b>	Air Temperature Gauge.	<b>\$49.95</b>
<b>74690-10</b>	Oil Pressure Gauge.	<b>\$49.95</b>
<b>74691-10</b>	Voltmeter.	<b>\$49.95</b>

## B. SPUN ALUMINUM FACE GAUGES

Add a touch of luxury and style to your dash. First featured on the '04 Screamin' Eagle® Deuce™ and Electra Glide® models, these Spun Aluminum Face Gauges offer a rich contrast to a chrome console or black inner fairing surface. The gauges feature subtle Harley-Davidson racing orange backlighting for a unique night-time look. Mileage reinstatement is available through your Dealer.

**67516-08** 4" Speedometer – MPH. **\$199.95**  
Fits '08 Electra Glide® and Road Glide® models equipped with 4" gauges.

**67516-04B** 4" Speedometer – MPH. **\$199.95**  
Fits '04-'07 Electra Glide® and Road Glide® models equipped with 4" gauges.

**67519-08** 4" Speedometer – KPH. **\$199.95**  
Fits '08 Electra Glide and Road Glide models equipped with 4" gauges.

**67519-04B** 4" Speedometer – KPH. **\$199.95**  
Fits '04-'07 Electra Glide and Road Glide models equipped with 4" gauges.

**67522-04B** 4" Tachometer. **\$189.95**  
Fits '04-later Electra Glide and Road Glide models and '04-later XL and Dyna models equipped with 4" gauges.

**74552-04A** Voltmeter. **\$55.00**  
Fits '04-later Electra Glide, Road Glide and Trike models.

**75113-04A** Fuel Gauge. **\$82.50**  
Fits '04-'07 Electra Glide and Road Glide models.

**75113-08** Fuel Gauge. **\$82.50**  
Fits '08 Electra Glide and Road Glide models.

**74553-04A** Oil Pressure Gauge. **\$51.00**  
Fits '04-later Electra Glide, Road Glide and Trike models. FLHT/I models require purchase of additional service parts for installation. See your Dealer for details.

**74554-04** Air Temperature Gauge. **\$45.95**  
Fits '04-later Electra Glide, Road Glide and Trike models. FLHT/I models require purchase of additional service parts for installation. See your Dealer for details.

## C. SILVER FACE GAUGE KIT – SPEEDOMETER AND TACHOMETER

Put a new face on your instrument panel with this kit. Kit includes new speedometer/odometer calibrated to existing mileage.

**74457-00** **\$399.95**  
Fits '00-'03 FLHT, FLHTC, FLHTCU and FLTR models.



A. TITANIUM FACE GAUGES



B. SPUN ALUMINUM FACE GAUGES



C. SILVER FACE GAUGE KIT – SPEEDOMETER AND TACHOMETER

Notice: The prices appearing in this catalog are the manufacturer's suggested retail prices. Actual retail prices may vary.



# TOURING 451

Dash, Console & Gauges



**D. OIL TEMPERATURE GAUGE – FAIRING MOUNT**



**E. OIL PRESSURE AND AIR TEMP GAUGE KIT FOR FLHT MODELS**



**F. SWITCHED CIRCUIT ADAPTER HARNESS & ELECTRICAL ACCESSORY ADAPTER**



**G. SUPPLEMENTAL 12V POWER POINT**



**H. 45-AMP CHARGING SYSTEM FOR ELECTRA GLIDE MODELS**



**I. 32-AMP HIGH-OUTPUT ALTERNATOR KIT**

**D. OIL TEMPERATURE GAUGE – FAIRING MOUNT**

Keep a close eye on your engine's vital signs. This 2" diameter gauge monitors engine oil temperature to provide an early warning of conditions that may require attention. The gauge face is styled to complement Original Equipment fairing mount gauges. Complete kit includes gauge, mounting bracket, installation hardware, and wiring harness.

Fits '99-later FLHT, FLHTC, FLHTCU, FLHX, FLTR and Trike models. Will not fit '09-later FLTRSE3, FLHXSE and FLHTCUSE4/5. Not compatible with Chrome Instrument Gauge Bezel P/N 74550-92T or Chrome Inner Fairing Trim Kit P/N 96396-09.

<b>1. 75320-05A</b> Aluminum Face.	<b>\$139.95</b>
<b>2. 75324-05A</b> Silver Face.	<b>\$139.95</b>
<b>3. 75265-04A</b> Black Face.	<b>\$139.95</b>

**E. OIL PRESSURE AND AIR TEMP GAUGE KIT FOR FLHT MODELS**

This kit finishes the instrument console on the Electra Glide® Standard. Complete with all necessary brackets and hardware.

<b>74439-00</b> Fits '00-later FLHT models.	<b>\$119.95</b>
---	-----------------

**F. SWITCHED CIRCUIT ADAPTER HARNESS\***

This harness allows two accessories to be connected to the switched accessory circuit featured on '94-later Touring models. You then may switch two accessories on or off simultaneously as required.

<b>70264-94A</b> Fits '94-later Touring models.	<b>\$17.95</b>
---	----------------

**ELECTRICAL ACCESSORY ADAPTER\***

Harness accommodates the addition of multiple electrical accessories to the main battery power circuit on '04-later models.

<b>70270-04</b> Fits '04-later XL, XR, Dyna®, Softail® and Touring models.	<b>\$15.95</b>
--	----------------

**G. SUPPLEMENTAL 12V POWER POINT\***

Easy-to-install power point allows an additional 12-volt power source for electrical accessories powered by a cigarette lighter type socket. Features a water-resistant cover with laser-etched Bar & Shield logo.

<b>91843-97</b> Fits '94-later FLHR (except FLHRCI), FLT, FLTR, FLHT, FLHX and Trike models.	<b>\$19.95</b>
--	----------------

**H. 45-AMP CHARGING SYSTEM FOR ELECTRA GLIDE® MODELS**

Standard equipment on H-D® Touring-style Police motorcycles, this high-output charging system knows how to work for a living. Add more electronics – including lights – on your Electra Glide® model without worrying about whether you've got the juice to back it up.

<b>29999-97B</b> Fits '99-'05 FLHT models.	<b>\$264.95</b>
--	-----------------

**I. 32-AMP HIGH-OUTPUT ALTERNATOR KIT**

Stock on all '89-later carbureted 1340 models. 50% increase in amperage for the heavily accessorized motorcycle.

<b>29985-87</b> Fits '84-'88 FLT, FLHT, and FXR (wet clutch) models. (Will not fit '84-'88 Softail®.) Stock on all '89-'95 and some '96-'97 Evolution® 1340-equipped models.	<b>\$239.95</b>
--	-----------------

\*NOTE: It is possible to overload your motorcycle's charging system by adding too many electrical accessories. If your combined electrical accessories operating at any one time consume more electrical current than your vehicle's charging system can produce, the electrical consumption can discharge the battery and cause vehicle electrical system damage. Ask your dealer for advice about the amount of current consumed by additional electrical accessories.

Notice: The prices appearing in this catalog are the manufacturer's suggested retail prices. Actual retail prices may vary.

TOURING



# 452 TOURING

Dash, Console & Gauges

## A. FLUSH-MOUNT FUEL CAP AND GAUGE KIT\*

Emphasize the long and lean look of the fuel tank. This Flush-Mount Fuel Cap and Gauge Kit offers a pop-up filler design that when installed and sealed looks identical to the flush gauge. A simple push, and the fuel filler cap pops up to provide ample grip, even while wearing gloves. The flush fuel gauge features individual LED lamps that shine through a mirror-coated glass that glows when the ignition is switched on. A photocell automatically adjusts LED brightness for improved visibility in direct sunlight, and dims at night to avoid distraction. Complete kit includes fuel cap, fuel gauge, trim ring, and plug-in wiring harness.

Fits '08-later Road King® models.

**62823-08A** Chrome. **\$199.95**

**75027-08A** Gloss Black. **\$199.95**

Fits '04-'07 Road King® models.

**62823-06A** Chrome. **\$199.95**



A. FLUSH-MOUNT FUEL CAP AND GAUGE KIT – CHROME



A. FLUSH-MOUNT FUEL CAP AND GAUGE KIT – GLOSS BLACK



A. FLUSH-MOUNT FUEL GAUGE – FULL



A. FLUSH-MOUNT FUEL CAP – OPEN

\*Some local regulations prohibit using colored lights during vehicle operation on public streets. May not conform to local lighting regulations.

Notice: The prices appearing in this catalog are the manufacturer's suggested retail prices. Actual retail prices may vary.

# TOURING 453

Dash, Console & Gauges



**B. LED FUEL GAUGE – SMOOTH (FULL READING SHOWN)**



**C. LED FUEL GAUGE – DIAMOND BLACK COLLECTION**



**D. LED FUEL GAUGE – BAR & SHIELD LOGO**



**E. LED FUEL GAUGE – THE SKULL COLLECTION**



**F. LED FUEL GAUGE – FLAMES COLLECTION**

## LED FUEL GAUGES\*

This low-profile fuel gauge replaces the analog readout with bright LED lamps. The six edge-mounted LED lamps glow blue when the tank is full, and extinguish one by one as fuel is consumed. Plug-in installation without splicing. Available in seven styles to match Original Equipment and accessory fuel caps.

### B. LED FUEL GAUGE – SMOOTH\*

This low-profile fuel gauge matches the profile of the Original Equipment fuel cap.

**75242-08 \$139.95**

Fits '08-later Softail®, Road King® and '09-later Dyna® models (except FXD).

**75237-03B \$139.95**

Fits '04-'08 FXDB, FXDL, FXD35, FXDF and FXDWG models, '07-'08 FXDC models, '04-'07 Softail® models, '01-'03 EFI Softail models (except FXSTDI), '03-'07 Road King models, and '01-'02 EFI Road King models.

### C. LED FUEL GAUGE – DIAMOND BLACK COLLECTION\*

This matte-black gauge features a machined Bar & Shield logo and knurled edges for a raw look. The design complements the Diamond Black Fuel Cap P/N 62778-10, and is the perfect addition to a "blacked-out" custom ride. Photocell automatically adjusts LED brightness for improved visibility in direct sunlight, and dims at night to avoid distraction.

**75358-10 \$149.95**

Fits '08-later Softail®, Road King® and '09-later Dyna models (except FXD).

**75357-10 \$149.95**

Fits '04-'08 FXDB, FXDL, FXD35, FXDWG and FXDF models, '07-'08 FXDC models, '04-'07 Softail® models, '01-'03 EFI Softail® models (except FXSTDI), '03-'07 Road King® and '01-'02 EFI Road King® models.

### D. LED FUEL GAUGE – BAR & SHIELD LOGO\*

This low-profile fuel gauge matches the Harley-Davidson Bar & Shield logo medallion style of the accessory Self-Locking Fuel Cap.

**75051-08 \$139.95**

Fits '08-later Softail®, Road King® and '09-later Dyna models (except FXD).

**75084-04B \$139.95**

Fits '04-'08 FXDB, FXDL, FXD35, FXDF and FXDWG models, '07-'08 FXDC models, '04-'07 Softail® models, '01-'03 EFI Softail models (except FXSTDI), '03-'07 Road King models, and '01-'02 EFI Road King models.

### E. LED FUEL GAUGE – THE SKULL COLLECTION\*

Complements the Skull Collection Billet Fuel Cap P/N 75097-05. Photocell automatically adjusts LED brightness for improved visibility in direct sunlight, and dims at night to avoid distraction.

**75098-08 \$159.95**

Fits '08-later Softail®, Road King® and '09-later Dyna models (except FXD).

**75095-05A \$159.95**

Fits '04-'08 FXDB, FXDL, FXD35, FXDF and FXDWG models, '07-'08 FXDC models, '04-'07 Softail models, '01-'03 EFI Softail models (except FXSTDI), '03-'07 Road King models, and '01-'02 EFI Road King models.

### F. LED FUEL GAUGE – FLAMES COLLECTION\*

This cap complements the Flames Collection Fuel Cap P/N 75176-08. Photocell automatically adjusts LED brightness for improved visibility in direct sunlight, and dims at night to avoid distraction.

**75231-08 \$149.95**

Fits '08-later Softail, Road King and '09-later Dyna models (except FXD).

**75311-08 \$149.95**

Fits '04-'08 FXDB, FXDL, FXD35, FXDWG and FXDF models, '07-'08 FXDC models, '04-'07 Softail models, '01-'03 EFI Softail models (except FXSTDI), '03-'07 Road King and '01-'02 EFI Road King models.

\*Some local regulations prohibit using colored lights during vehicle operation on public streets. May not conform to local lighting regulations.

Notice: The prices appearing in this catalog are the manufacturer's suggested retail prices. Actual retail prices may vary.

# 454 TOURING

Dash, Console & Gauges

## A. FUEL CAP – DIAMOND BLACK COLLECTION

Drift over to the dark side. This matte-black fuel cap features a machined Bar & Shield logo and knurled edges for a raw look and easy grip. The design complements the Diamond Black Fuel Gauge, and is the perfect addition to a “blacked-out” custom ride.

**62778-10** **\$49.95**

Fits '92-later XL and Dyna (except '04-later FXD, FXDX, '05-'06 FXDC and '07 FXDSE), '00-later Softail models, and '94-later Road King models.

## B. BAR & SHIELD LOGO SELF-LOCKING FUEL CAP

Functional and stylish, these polished, chrome-plated caps feature a convenient self-locking mechanism and a stamped Harley-Davidson Bar & Shield logo on the key hole cover. Maintains the same features as the Original Equipment fuel cap. The kit comes complete with two keys.

**62803-97A** **\$49.95**

Fits '92-later XL and Dyna® (except '04-later FXD, FXDX, '05-'06 FXDC and '07 FXDSE), '00-later Softail® models, and '94-later Road King models. Also fits '99-'00 FXR models.

## C. FUEL CAP – SKULL COLLECTION

Add a little attitude to your ride. Styled to complement Harley-Davidson Skull accessory items, the menacing raised skull with black-filled eyes features a rich chrome-plated finish and a styled shape that is easy to grip, even while wearing gloves.

**75097-05** **\$49.95**

Fits '92-later XL and Dyna (except '04-later FXD, FXDX, '05-'06 FXDC, FXDSE), '00-later Softail® models (except FXSTD, FXSTSSE/2), and '94-later Road King® models. Does not fit with Low-Profile Chrome Fuel Tank Console P/N 71208-07.

## D. FUEL CAP – FLAMES COLLECTION

Set your gas tank apart from the rest. These Fuel Caps feature a rich chrome-plated finish and a styled shape that is easy to grip, even while wearing gloves.

**75176-08** **\$49.95**

Fits '92-later XL and Dyna (except '04-later FXD, FXDX, '05-'06 FXDC, and '07 FXDSE), '00-later Softail models (except FXSTD), and '94-later Road King models.

## E. BILLET FUEL CAP

Set your gas tank apart from the rest. These machined Billet Fuel Caps feature a rich chrome-plated finish and a styled shape that is easy to grip, even while wearing gloves.

Fits '92-later XL and Dyna® (except '04-later FXD, FXDX, '05-'06 FXDC and '07 FXDSE), '00-later Softail® models, and '94-later Road King models.

**62816-03** Cross. **\$49.95**

**62819-03** Six Shooter. **\$49.95**

## F. FUEL CAP MEDALLION – “LIVE TO RIDE” LOGO

Self-Adhesive.

Fits '83-later models (except '04-later XL Custom and XL1200L, FXD, and FXDX models, '05-'06 FXDC models, all FXR w/plastic fuel cap, Electra Glide, Tour Glide, Road Glide, VRSC™ and fuel caps with gauges).

**99020-86T** Chrome. **\$16.95**

**99020-90T** Gold. **\$22.95**



A. FUEL CAP – DIAMOND BLACK COLLECTION



B. BAR & SHIELD LOGO SELF-LOCKING FUEL CAP



C. FUEL CAP – SKULL COLLECTION



D. FUEL CAP – FLAMES COLLECTION



E. BILLET FUEL CAP – CROSS



E. BILLET FUEL CAP – SIX SHOOTER



F. “LIVE TO RIDE” LOGO FUEL CAP MEDALLION – GOLD



F. “LIVE TO RIDE” LOGO FUEL CAP MEDALLION – CHROME

Notice: The prices appearing in this catalog are the manufacturer's suggested retail prices. Actual retail prices may vary.

# TOURING 455

Dash, Console & Gauges



**G. FUEL CAP MEDALLION – H-D MOTOR CO. LOGO**



**H. FUEL CAP MEDALLION – WILLIE G. SKULL**

**G. FUEL CAP MEDALLION – “H-D MOTOR CO.” LOGO**

Top off your Original Equipment fuel cap. Adhesive backing for easy installation.

**99539-97 \$13.95**

Fits '83-later models (except '04-later XL883C, XL1200L and 1200C models, FXD and FXDX models, '05-'06 FXDC, all FXR with plastic fuel cap; Electra Glide®, Road Glide®, Tour Glide™ and VRSC™ models; and all fuel caps with gauges).

**H. FUEL CAP MEDALLION –WILLIE G. SKULL**

**99670-04 \$16.95**

Fits '83-later models (except '04-later XL883C, XL1200L and 1200C models, FXD and FXDX models, '05-'06 FXDC, all FXR with plastic fuel cap; Electra Glide, Road Glide, Tour Glide and VRSC™ models; and all fuel caps with gauges).

**I. CLOISSONNÉ FUEL CAP MEDALLION**

Get decorated with this multi-colored cloisonné medallion featuring chrome-plated graphics. Easy installation with self-adhesive backing.

Fits '83-later models (except '05-'06 FXDC, '04-later XL Customs and FXDX models, FXR with plastic fuel cap, Electra Glide®, Tour Glide™, Road Glide®, VRSC™ and fuel caps with fuel gauges).

**95741-01 Silver. \$22.95**

**99537-96 Black. \$22.95**



**I. CLOISSONNÉ FUEL CAP MEDALLION – SILVER**



**I. CLOISSONNÉ FUEL CAP MEDALLION – BLACK**

**J. FUEL CAP MEDALLION –NUMBER ONE SKULL COLLECTION**

Put the sinister Harley-Davidson #1 Skull Collection right in front of you. This decorative steel cover is contoured to hug the Original Equipment Fuel Cap, and is easy to install with the factory-applied adhesive backing.

Fits '83-later models (except '04-later XL883C, XL1200L and 1200C models, FXD and FXDX models, '05-'06 FXDC, all FXR with plastic fuel cap, Electra Glide, Road Glide, Tour Glide, Trike and VRSC™ models, and all fuel caps with gauges).

**99673-10 Chrome. \$19.95**

**99688-10 Black. \$19.95**

**K. FUEL CAP MEDALLION –THE FLAMES COLLECTION**

**99686-98 \$22.95**

Fits all '83-later models (except '04-later XL Custom and XL1200L, FXD, and FXDX models, '05-'06 FXDC models, all FXR w/plastic fuel cap, Electra Glide®, Tour Glide™, Road Glide®, VRSC™ and fuel caps with fuel gauges).

**L. CHROME FUEL TANK MOUNTING HARDWARE KIT**

Beauty lies in the details, and this chrome-plated Fuel Tank Mounting Hardware Kit ensures you won't leave this one overlooked. The perfect finishing touch to your fuel tank, the kit includes the "Bullet Tip" custom bolts and machined washers required for the specific model application. Hardware design matches the Chrome Bullet Tip Footpeg Bolt Kit P/N 94133-01 and other available accessories.

**62920-00A Fits '98-later Touring models. \$34.95**



**J. FUEL CAP MEDALLION NUMBER ONE SKULL COLLECTION – CHROME**



**J. FUEL CAP MEDALLION NUMBER ONE SKULL COLLECTION – BLACK**

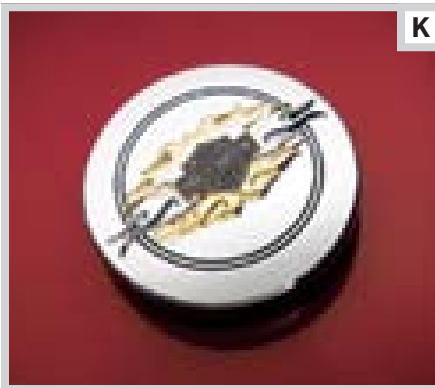

**K. FUEL CAP MEDALLION THE FLAMES COLLECTION**

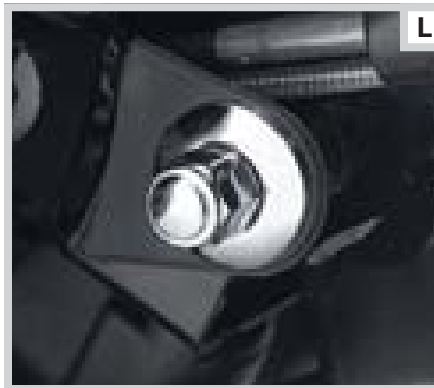

**L. CHROME FUEL TANK MOUNTING HARDWARE KIT**

Notice: The prices appearing in this catalog are the manufacturer's suggested retail prices. Actual retail prices may vary.

TOURING



## 456 TOURING

*Trike Accessories*

### HARLEY-DAVIDSON® TRIKE MODELS

Experience the confidence, stability, comfort and cargo space that only a three-wheel motorcycle can provide. Just like all Harley-Davidson models, our Three-Wheel motorcycles can be customized to match your riding personality. There are exclusive Trike accessories, and there are also many Touring and Multi-Fit products that can be added to your ride. A wide variety of seats, hand and foot controls, lighting and decorative accessories can help you tailor the bike for the best fit, maximum function, and eye-catching good looks.



**TRI-GLIDE™ ULTRA CLASSIC**  
(SHOWN WITH AVAILABLE GENUINE MOTOR ACCESSORIES)



**STREET GLIDE® TRIKE**  
(SHOWN WITH AVAILABLE GENUINE MOTOR ACCESSORIES)



NEW

A

A. CHROME LOWER FORK SLIDERS



NEW

A

**A. CHROME LOWER FORK SLIDERS**

Competitively-priced, these chrome-plated Lower Fork Sliders give your bike upfront style. To ensure proper fitment and function, these sliders are manufactured from the Original Equipment components. Features polished, triple chrome-plating and stamped "Harley-Davidson" logo.

**83819-09****\$319.95**

Fits '09-later Trike models.

**B. PREMIUM LUGGAGE RACK FOR FLHXXX MODELS\***

Designed to complement the contours of your Street Glide Trike's rear fender and trunk, this Premium Luggage Rack offers plenty of extra capacity when you hit the road. The rack's strong solid bar construction incorporates high-quality welded joints and is hand-polished and chrome-plated to a brilliant shine. Kit includes rack and all necessary mounting hardware. For additional versatility and passenger comfort, add the available Passenger Sissy Bar P/N 83921-10 and your choice of backrest pad (*sold separately*).

**83954-10** Chrome.**\$239.95**

Fits '10 FLHXXX models.

**C. PASSENGER SISSY BAR UPRIGHT FOR FLHXXX MODELS**

Add passenger comfort and support to your Street Glide Trike model. Designed to blend with the curved lines of the Premium Luggage Rack, this polished chrome upright attaches directly to the Luggage Rack for a clean look. The one-piece upright accepts most standard-height touring model passenger backrest pads (*sold separately*), and is the perfect finishing element for your long-distance touring machine.

**83921-10** Chrome.**\$139.95**

Fits '10 FLHXXX models. Requires separate purchase of Premium Luggage Rack P/N 83954-10.



NEW

B

B. PREMIUM LUGGAGE RACK FOR FLHXXX MODELS



NEW

C

C. PASSENGER SISSY BAR UPRIGHT (SHOWN WITH PREMIUM LUGGAGE RACK)

**D. CHROME REAR GUARD**

Unique rear guard wraps around the bodywork to protect your finish from damage. Lightweight steel tubing incorporates high-quality welded joints and is hand-polished and chrome-plated for a brilliant finish. Kit includes all necessary mounting hardware for bolt-on installation.

**83825-09****\$209.95**

Fits '09-later Trike models.



NEW

D

D. CHROME REAR GUARD



**\*WARNING:** Do not use this rack as a seat. Do not exceed the fender rack weight capacity. Using as seat or exceeding this capacity could cause handling problems which could result in loss of control and death or serious injury.

Notice: The prices appearing in this catalog are the manufacturer's suggested retail prices. Actual retail prices may vary.

# 458 TOURING

Trike Accessories

## A. CHROME FENDER TRIM KIT

This Chrome Fender Trim Kit dresses the opening of the wheel well and adds a touch of elegance to the rear of the bike. With no visible fasteners, the trim accentuates the shape and protects the painted edge of the rear fender from minor stone chips. Self-adhesive backing for easy installation.

**83812-09** **\$99.95**  
Fits '09-later Trike models.

## B. EXHAUST TRIM

This chrome-plated accent piece trims the exhaust openings in the trunk fascia, and adds a touch of brightwork to the rear of the bike. Easy to install with no visible fasteners, the formed steel trim features pre-applied high-temp adhesive backing for a clean, uncluttered look.

**83843-09** **\$39.95**  
Fits '09-later Trike models.

## C. WHEEL CENTER COVER KIT

These chrome-plated hubcaps adds style and depth to the Tri Glide rear wheels. The snap-fit covers have no visible fasteners for a clean, custom look.

**83841-09** **\$39.95**  
Fits '09-later Trike models.

## D. TOUR-PAK INSTALLATION KIT FOR FLHXXX TRIKE MODELS

Add touring versatility and extra storage capacity to your Street Glide Trike model. Kit includes everything you need to install Color-Matched Tour-Pak or Razor-Pak luggage on your Street Glide Trike's rear trunk.

**54144-10** **\$99.95**  
Required for installation of King, Chopped or Razor-Pak luggage on '10 FHXXX models.



A. CHROME FENDER TRIM KIT



B. EXHAUST TRIM



C. WHEEL CENTER COVER KIT



D. TOUR-PAK INSTALLATION KIT FOR FLHXXX TRIKE MODELS

Notice: The prices appearing in this catalog are the manufacturer's suggested retail prices. Actual retail prices may vary.

# TOURING 459

Trike Accessories



NEW

E

E. TRUNK LUGGAGE



NEW

F

F. TRANSPARENT PAINT GUARD KIT



NEW

G

G. TRUNK DOOR ORGANIZER



NEW

H

H. H-D V-LOGO MUD FLAP



NEW

I

I. INDOOR/OUTDOOR MOTORCYCLE COVER

## E. TRUNK LUGGAGE

These well-constructed, ballistic nylon bags are designed to fit perfectly into the trunk of the Tri Glide™ model. Styled with a reflective Bar & Shield logo, the bags feature zippered outer pouches and a mesh inner storage pocket for packing convenience. Comfortable carrying straps make transportation a breeze. Sold in pairs.

**83847-09**

**\$89.95**

Fits '09-later Trike models.

## F. TRANSPARENT PAINT GUARD KIT

This transparent skin is designed to protect parts of the Trike bodywork from boot scuffs and road debris. The 12 pieces of crystal-clear material (6 per side) protect the area surrounding the passenger footboard, and are pre-cut to fit the leading and inner surface of the rear fender, the fascia panel of the trunk, and the side covers. The application process is similar to that of tinted window film, and the material can be removed and replaced when it is no longer cosmetically appealing.

**83989-10**

**\$129.95**

Fits '09-later Trike models.

## G. TRUNK DOOR ORGANIZER

For on-the-road storage and efficiency, this ingenious organizer helps keep smaller items conveniently located on your trunk door for easy access. The easy-to-install self-adhesive organizer features three nylon-mesh pockets with hook-and-loop-secured flaps that offer quick access to keys, cell phones, glasses, gloves, and maps. Organizer features an embroidered "Harley-Davidson" script logo. Add the matching Tour-Pak® Lid Organizer P/N 53249-01B inside of the Tour-Pak luggage for maximum organization.

**83928-09**

**\$59.95**

Fits '09-later Trike models.

## H. H-D® V-LOGO MUD FLAP

The noble red "H-D" V-logo is molded onto black rubber. Kit includes left and right mud flap, reinforcing brackets and mounting hardware.

**83833-09**

**\$59.95**

Fits '09-later Trike models.

## I. INDOOR/OUTDOOR MOTORCYCLE COVER

Our most versatile cover, this all-weather, indoor/outdoor cover is made of a tough, lightweight 300 denier, fade resistant polyester. The urethane-coated material and double stitched seams provide excellent strength and water resistance. Venting system allows condensation to escape during long-term storage. Exhaust heat shield panels protect the cover from hot exhaust systems. Additional features include a protective windshield liner, securing strap, elastic edges, and a convenient storage pouch. Features hook-and-loop secured openings to accommodate dual antennas. Features silkscreened Eagle logo.

**83845-09**

**\$149.95**

Fits '09-later Trike models.

TOURING

Notice: The prices appearing in this catalog are the manufacturer's suggested retail prices. Actual retail prices may vary.



# 460 TOURING

## Sidecar Accessories

Harley-Davidson is the only major motorcycle company that makes its own sidecars.\* Harley® sidecars are available in a wide range of solid and two-tone colors. We'll match stock paint for 2004-2010 model years and offer two interior styles: Standard and Ultra Classic®. The Ultra model offers a plush interior which includes a premium sound system designed to complement the stereo on FL models. All Harley® sidecars feature hand-laid fiberglass bodies, third wheel disc brake, carpeted interiors, windshields, tonneau covers, and four different wheel/tire combinations. Sidecar includes all necessary mounting hardware.

See your Harley-Davidson® Dealer for additional information.



**\*WARNING:** Sidecars are for use only on FL Touring motorcycles. Sidecars must never be used on Softail® motorcycles, FLSTS/FLSTSC motorcycles, motorcycles fitted with the Springer® front fork or '05-'07 Police motorcycles with anti-lock brakes. Use of these vehicles or forks with sidecars could adversely affect handling which could result in death or serious injury.

Notice: The prices appearing in this catalog are the manufacturer's suggested retail prices. Actual retail prices may vary.



**A. LIGHTLY SMOKED SIDECAR WINDSHIELD – CLASSIC**



**A. LIGHTLY SMOKED SIDECAR WINDSHIELD – ULTRA**



**B. SIDECAR COVER WITH EAGLE LOGO**



**C. PREMIUM SIDECAR LUGGAGE RACK**



**D. SIDECAR STEP KIT**



**E. SIDECAR PARKING BRAKE KIT**

#### A. SIDECAR WINDSHIELDS

Carry over the lightly-smoked styling to your sidecar rig. Hard-coated Lexan® polycarbonate resists scratching and abrasion.

**88860-97** Lightly Smoked. **\$154.95**

Fits '91-later TLE Classic and RLE Sidecars.

**88861-97** Lightly Smoked. **\$154.95**

Fits '89-later Ultra Sidecars.

#### B. SIDECAR COVER WITH EAGLE LOGO\*

Constructed from tough, lightweight, 250-denier water-repellent polyester. Matches Harley-Davidson® Touring-style motorcycle cover, but is specifically sized to cover the body and windshield of your sidecar. Includes protective windshield liner, silkscreened Eagle logo, and elastic edging for a secure fit.

**98725-91** Fits H-D® sidecars. **\$79.95**

NOTE: H-D® motorcycle covers are not designed to be used while trailering. Using H-D motorcycle covers while trailering may cause the cover to tear, possibly causing damage to the cover, motorcycle and sidecar.

#### C. PREMIUM SIDECAR LUGGAGE RACK\*\*

Designed to complement the contours of your sidecar while offering added luggage capacity. Lightweight steel tubing incorporates high-quality welded joints and is hand-polished and chrome-plated by American craftsmen. Comes complete with all necessary mounting hardware and installation instructions.

**53669-89** Fits '67-later H-D sidecars. **\$109.95**

#### D. SIDECAR STEP KIT

Heavy-gauge steel step allows easier entrance and exit to sidecar. High-gloss black enamel finish. Includes rubber pedal pad.

**88490-88A** Fits '80-later H-D® sidecars. **\$41.95**

#### E. SIDECAR PARKING BRAKE KIT

Designed for convenient and secure parking of sidecar rigs. Includes specially-designed rear caliper mounting bracket that includes the parking brake caliper. Complete kit comes with hand-operated brake lever, all necessary brackets, hardware and comprehensive installation instructions.

**44103-09** **\$1,149.95**

Fits '09-later Touring models equipped with a sidecar.

**44103-02A** **\$699.95**

Fits '02-'07 FLT and FLHT models equipped with a sidecar.

**44103-08** **\$699.95**

Fits '08 FLT and FLHT models equipped with a sidecar.

#### Also available:

##### HIGH LOAD DRIVE BELT (not shown)

This high strength belt is manufactured to improve belt life due to the heavy duty loads required by the addition of a sidecar to the motorcycle.

**40130-03** Fits '97-'03 FLT models. **\$239.00**



**\*WARNING:** Do not use with someone riding inside. Doing so could result in death or serious injury.



**\*WARNING:** Do not use this rack as a seat. Do not exceed the fender rack weight capacity. Using as seat or exceeding this capacity could cause handling problems which could result in loss of control and death or serious injury.

Notice: The prices appearing in this catalog are the manufacturer's suggested retail prices. Actual retail prices may vary.

# SCREAMIN' EAGLE®

*If you want to get the most out of your machine, precise tuning is an absolute. Screamin' Eagle Performance Parts supply the raw power you need and distinct sound you want while keeping you within the law. All our street-legal configurations are factory-tested for high performance and unmatched reliability.*

## THE DYNO CHART

An invaluable tool in performance modification, the dyno chart can visually compare the performance characteristics of a stock engine with those of a modified engine — and can help you determine if a particular set up will generate the power gains you're after. The horizontal axis indicates engine speed in RPM and the left and right vertical axis shows the amount of torque and horsepower produced. Comparing the stock and modified torque and horsepower curves can tell you how a configuration performs in a specific RPM range.

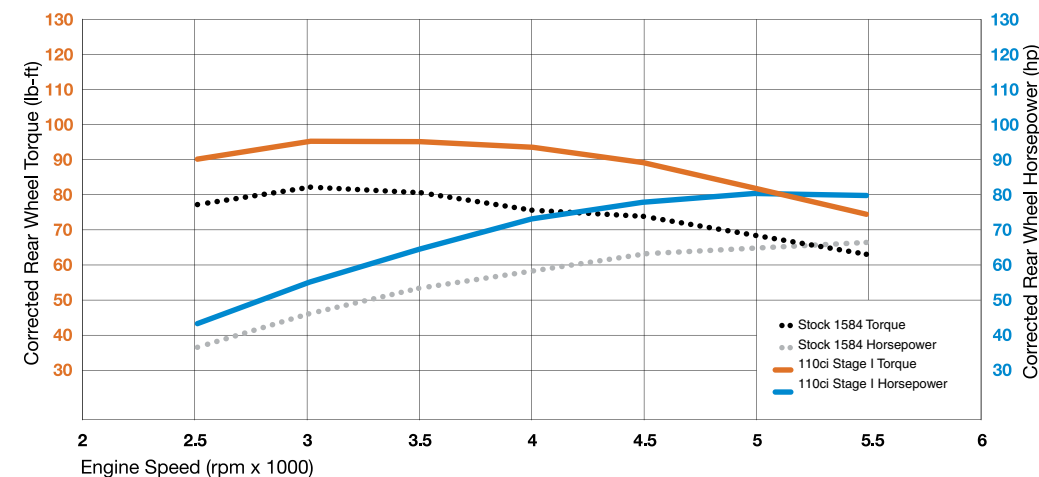

## HORSEPOWER & TORQUE

While many judge a motorcycle's performance solely in terms of horsepower, torque is an equally important factor in the equation. In a nutshell, torque is the twisting force that gets your bike moving, while horsepower is the effort required to keep it moving — meaning that torque influences acceleration, while horsepower determines velocity. Your goal should be to reach the balance between horsepower and torque that most closely matches the performance you need.

## WARRANTY & CAUTION

### OVERVIEW

Harley-Davidson has the engineering expertise, the sophisticated dyno lab and complete testing facilities to provide enthusiasts with a line of performance products designed to produce good, solid, reliable horsepower and torque. Engine related performance parts are intended for the experienced rider only.

### WARRANTY

Installation of Screamin' Eagle® products, and similar off-road or competition products from other manufacturers, except some street-legal offerings installed by authorized Harley® dealers, may void your H-D® limited vehicle warranty. Installation of a California performance kit on a 49-state model motorcycle or a 49-state performance kit onto a California model motorcycle will void manufacturers warranty, as it will not result in a street-legal configuration.

### CAUTION

Harley-Davidson® motorcycles modified with some Screamin' Eagle® high-performance engine parts must not be used on public roads and in some cases may be restricted to closed-course competition.



## FEARED BY COMPETITORS, LOVED BY SPECTATORS.

*Victory is measured in milliseconds. Quarter-mile or flat track, you'll find H-D® riders running out front. Keeping them in the lead are genuine Screamin' Eagle Pro Racing Parts—engineered for the track, and destined for the winner's circle. As part of our commitment to the sport, we proudly support NHRA®, AMA® and AHDRA®, organizations that move enthusiasts from the stands to the starting line.*

### A NEW KIND OF ICON

Harley-Davidson® motorcycles are the official motorcycle of the National Hot Rod Association (NHRA®). To feel the power and excitement of professional drag racing, visit an NHRA event and experience the Harley-Davidson Acceleration Nation® display. Exhibits feature the latest motorcycles, photo opportunities and a chance to race two specially prepared V-Rod® motorcycles on a drag strip simulator.



nhra.com



amaflattrack.com



ahdra.com

Visit [www.harley-davidson.com](http://www.harley-davidson.com) for schedules and information on Harley-Davidson racing.

### SHOW AND GO

*What do Screamin' Eagle engineers do in their spare time? They build fast bikes like this strip-conquering 113 cubic inch Dyna® Street Bob® race bike.*



### HARLEY-DAVIDSON RACE CATALOG

Perfected by time and proven by champions, Screamin' Eagle® Pro can take your bike to a level of performance you never thought possible. For the latest information on Screamin' Eagle Pro Racing Parts, see your Harley-Davidson dealer, or visit [www.harley-davidson.com/racecatalog](http://www.harley-davidson.com/racecatalog) and download a copy of the Screamin' Eagle Pro catalog. Harley-Davidson® motorcycles modified with Screamin' Eagle® Pro performance parts must not be used on public roads and may be restricted to closed-course competition.

[www.harley-davidson.com/racecatalog](http://www.harley-davidson.com/racecatalog)



### THREE WAYS TO FEEL THE HEAT

#### NHRA® FULL THROTTLE® PRO STOCK MOTORCYCLE RACING

*Experience the ultimate in side-by-side two-wheeled competition. This elite class of professional racing delivers a high octane, high adrenaline rush like no other. With blazing speeds up to 200 mph, NHRA Pro Stock Motorcycle drag racing is the culmination of perfect timing, raw horsepower and flawless precision. To follow the Screamin' Eagle®/Vance & Hines factory team, visit [www.nhra.com](http://www.nhra.com).*

#### AMA® PRO FLAT TRACK RACING

*Some battles are best fought on the dirt. AMA Pro Flat Track Racing blends tradition with sights, sounds and action to produce the best in wheel-to-wheel competition. Balanced on a razor's edge at speeds up to 140 mph, purpose-built Harley-Davidson® XR-750-powered motorcycles battle the competition in one of the most exciting spectator sports on two wheels. To follow the Harley-Davidson factory team, visit "Flat Track News" at [www.harley-davidson.com](http://www.harley-davidson.com).*

#### AHDRA® SCREAMIN' EAGLE® CLASS RACING

*If you ever wondered what it would feel like to tear down the track, the time to make that dream a reality is now. AHDRA competition provides all enthusiasts the opportunity to experience the high-octane adrenaline of drag racing. With your street bike or race-prepped machine, there are five Screamin' Eagle classes—including the VRXSE Destroyer™ class—to put you out on the track and in the zone. For full details, visit [www.abdra.com](http://www.abdra.com).*



*Clinching the 2008 AMA Grand National Twins Championship, Kenny Coolbeth became the sixth racer in history to win three consecutive titles. Wrecking Crew member Bryan Smith had his best season yet with a second place finish in the final points standings. Teammate Joe Kopp won six races and finished fourth in points, while Jared Mees posted a strong top-ten finish.*



*On his way to winning the 2008 NHRA® Pro Stock world championship, Screamin' Eagle/Vance & Hines racer Eddie Krawiec set both his career-best elapsed time and top speed aboard his V-Rod® motorcycle. Teammate Andrew Hines was the No. 2 qualifier in the Countdown to One playoffs and set his best elapsed time at 6.875 seconds in Madison, IL.*



# SCREAMIN' EAGLE® STAGE KITS

## LIFE STAGES

Developed specifically for fuel-injected Harley-Davidson® motorcycles, Screamin' Eagle® Street-Legal Stage Kits eliminate the guesswork and the need for trial-and-error testing normally associated with engine modifications. Just define your performance goals, and pick the Stage Kit that gets you there.

### DYNO CHARTS

Twin Cam 96® Stock vs. 96ci Stage I Kit

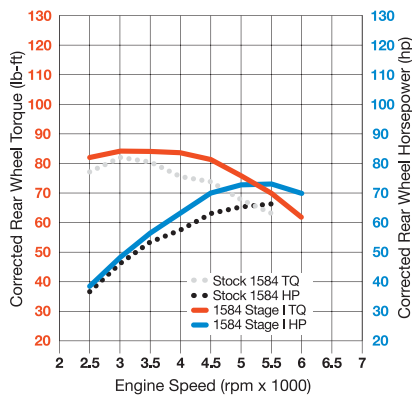

Twin Cam 96 Stock vs. 103ci Stage I Kit

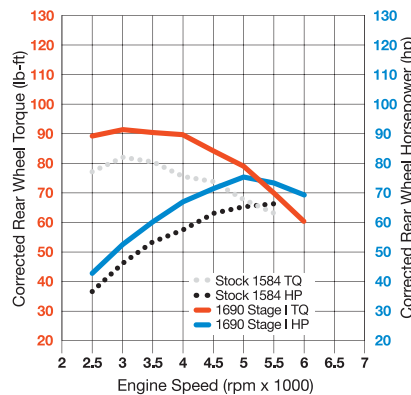

Twin Cam 96 Stock vs. 110ci Stage I Kit

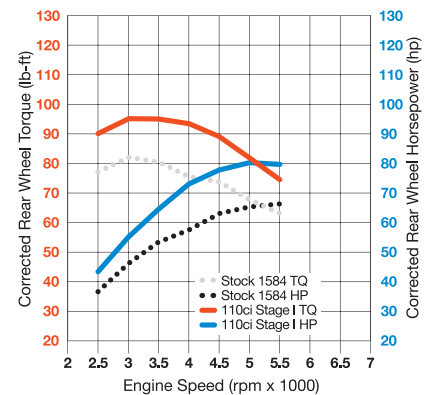

#### STAGE I AIR CLEANER

**Let It Breathe** The first step to unleashing the power of a V-Twin motor is to let it breathe. The engine is an air pump, so the more air and fuel it can swallow, burn and exhale, the more power it produces. Adding a Stage I High Flow or Heavy Breather Air Cleaner and Street Performance Muffler combination produces a lot of “bang for the buck,” and is a great place to start your performance build.

#### STAGE I BIG BORE

**Open It Up** Getting inside the engine and adding big bore cylinders and matching pistons is the fastest way to increase your bike’s pulling power. When the torque curve peaks early and continues to pull all the way through the mid-range, you feel it. Big bore engines provide the power required to pass a slow moving camper or to pull a loaded bike up a long grade. Want even more? Step up to the Big Bore Stage II Kit and you add performance-matched cams for measurable increases in torque and horsepower.

#### STAGE I BIG DISPLACEMENT

**Get It All** There’s no substitute for cubic inches. Screamin’ Eagle® 110 kits for Twin Cam 96™ models deliver hard-hitting Street Legal performance with proven reliability. Original Equipment on the Harley-Davidson® Screamin’ Eagle® CVO™ motorcycles, these Stage I Kits feature system-matched cylinders, heads, pistons, cams and ECM calibrations for demonstrated performance.

### CAUTION ICONS



**GO LIGHT** These Screamin’ Eagle® products are 50-state street-legal for sale and use on all vehicles, including those that are pollution-controlled.



**STOPHAND** Harley-Davidson® motorcycles modified with some performance engine parts must not be used on public roads and in some cases may be restricted to closed-course competition. Those performance parts identified with a stophand symbol are U.S. EPA legal, but are NOT legal for sale or use in California on pollution-controlled motor vehicles. California guidelines on tampering can also lead to substantial fines and penalties.



**CALIFORNIA** These Screamin’ Eagle products are street legal for sale and use on pollution-controlled vehicles in the state of California.

# SCREAMIN' EAGLE® 467

XL Stage Kits

A



A. SCREAMIN' EAGLE SPORTSTER 883CC TO 1200CC STAGE I CONVERSION KIT

## A. SCREAMIN' EAGLE® SPORTSTER® 883CC TO 1200CC STAGE I CONVERSION KIT\*

Make your Iron 883 roar. This complete conversion kit will alter the personality of your 883-equipped Sportster model. Designed to bring your XL883 model up to XL1200 specifications, this kit includes Sportster Stage I Air Cleaner Kit, XL1200 Cylinder Heads, and XL1200 Cylinders and Pistons. Kit includes black highlighted cylinders and cylinder heads. No case machining is required for installation. Street legal when used with stock mufflers. All models require ECM calibration\* (priced separately).

**29784-07** Black. **\$1,199.95**  
Fits '07-later XL883 models.

\*Recalibration is required for proper installation, and will allow engine to rev to 7000 RPM. See dealer for details.

## B. SCREAMIN' EAGLE SPORTSTER STAGE I AIR CLEANER KIT\*

The XL Stage I Air Cleaner Kit provides increased airflow to boost the power of your fuel injected Sportster model. The complete kit features a composite air cleaner back plate, air cleaner cover adapter, a high-flow washable synthetic media filter element that does not require oiling, and a breather system that routes gasses and excess oil directly into the intake. Kit also includes cover trim, and all mounting hardware. Street legal when used with stock mufflers. All models require ECM calibration\* (priced separately).

**29782-07A** Fits '07-later XL models. **\$139.95**

\*Recalibration is required for proper installation, and will allow engine to rev to 7000 RPM. See dealer for details.

SCREAMIN' EAGLE

B



B. SCREAMIN' EAGLE SPORTSTER STAGE I AIR CLEANER KIT

B

### SPORTSTER 1200 STOCK VS. 1200 STAGE I KIT (P/N 29782-07 shown)

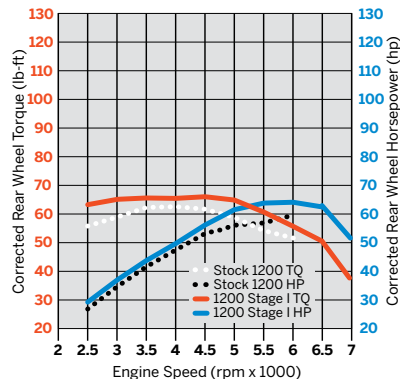

**CAUTION:** Harley-Davidson EFI systems will not compensate for any component changes. Do not mill heads or increase compression in any way. Do not use cams other than those supplied in the kit. Do not change kit components. Failure to comply may result in engine damage.

Notice: The prices appearing in this catalog are the manufacturer's suggested retail prices. Actual retail prices may vary.

# 468 SCREAMIN' EAGLE®

Twin Cam Stage Kits

## A. SCREAMIN' EAGLE® STREET LEGAL 110 CUBIC INCH STAGE I KIT FOR EFI MODELS\*

Bring your Twin Cam motorcycle up to the same displacement and power output as the CVO Screamin' Eagle® models – a gigantic 1800cc's. This street legal kit combines all the proven components of the CVO Screamin' Eagle models – the 4" big-bore forged pistons and cylinders, SE-255 camshafts, and cylinder heads with automatic compression release. The Screamin' Eagle cylinder heads and forged piston combination offers a 9.3:1 compression ratio for easy starting. The cylinder heads also prominently feature the "Screamin' Eagle 110" script. Kit includes all required gaskets (except primary cover and transmission interface gasket) and hardware to complete the installation. Installation requires case boring. Professional installation recommended. Separate purchase of cam spacers is required. See service manual for proper procedure and cam spacer part numbers. Requires separate purchase of appropriate Automatic Compression Release Wiring Harness. All EFI-equipped models require ECM calibration\* (priced separately).

Fits 50-state '10 Touring models (except FLHX and FLTRX). Kit includes CVO Air Cleaner Back Plate.

<b>27501-10</b>	Black.	<b>\$1,449.95</b>
<b>27504-10</b>	Silver.	<b>\$1,449.95</b>

Fits 50-state '10 FXDF and FXDWG models. Kit includes Heavy Breather Air Cleaner.

<b>27505-10</b>	Black.	<b>\$1,675.95</b>
-----------------	--------	-------------------

Fits 49-state '09 Touring models.\* Kit includes CVO Air Cleaner Back Plate and Catalytic Header Pipe.

<b>27501-09</b>	Black.	<b>\$1,675.95</b>
<b>27504-09</b>	Silver.	<b>\$1,675.95</b>

Fits 49-state '09 FXDF models.\* Kit includes Heavy Breather Air Cleaner and Catalytic Header Pipe.

<b>27505-09</b>	Black.	<b>\$1,979.95</b>
-----------------	--------	-------------------

Fits 49-state '09 Softail® models with Staggered Dual Mufflers.\* Does not fit FLSTF and FLSTN models. Kit includes Heavy Breather Air Cleaner and CVO Mufflers.

<b>27508-09</b>	Black.	<b>\$1,979.95</b>
<b>27506-09</b>	Silver.	<b>\$1,979.95</b>

Fits 49-state '08 Touring models.\* Kit includes CVO Air Cleaner Back plate, and CVO mufflers.

<b>27800-08A</b>	Black.	<b>\$2,459.95</b>
<b>27801-08A</b>	Silver.	<b>\$2,459.95</b>

Fits '07-later HDI Touring models, '07-later HDI Dyna models, and '07-'09 HDI FLSTF and '07 FXSTD Softail models. Street legal on HDI-configured models when installed with Original Equipment air cleaner and exhaust.

<b>29866-07A</b>	Black.	<b>\$2,295.95</b>
------------------	--------	-------------------

Fits 49-state '08 FLSTF models.\* Kit includes Heavy Breather Air Cleaner and CVO mufflers.

<b>27804-08</b>	Black.	<b>\$2,459.95</b>
-----------------	--------	-------------------

A



Stage I Air Cleaner

Heavy Breather Air Cleaner

Touring ('07-'08 only)

Dyna ('07-'08 only)

Softail ('07-'09 only)

\*Recalibration is required for proper installation, and will allow engine to rev to 5600 RPM. See dealer for details. Labor cost not included.

When installed by an authorized Harley-Davidson Dealer at the time of vehicle delivery, these kits do not impact the vehicle's limited warranty.

NOTE: Installation of a California performance kit onto a 49-state model motorcycle, or a 49-state performance kit onto a California model motorcycle will void manufacturers warranty, as it will not result in a street legal configuration.

## A. SCREAMIN' EAGLE STREET LEGAL 110 CUBIC INCH STAGE I KIT FOR EFI MODELS

Notice: The prices appearing in this catalog are the manufacturer's suggested retail prices. Actual retail prices may vary.

# SCREAMIN' EAGLE® 469

Twin Cam Stage Kits

B



Touring

Softail

\*Recalibration is required for proper installation, and will allow engine to rev to 6200 RPM. See dealer for details. Labor cost not included.

When installed by an authorized Harley-Davidson Dealer at the time of vehicle delivery, these kits do not impact the vehicle's limited warranty.

NOTE: Installation of a California performance kit onto a 49-state model motorcycle, or a 49-state performance kit onto a California model motorcycle will void manufacturers warranty, as it will not result in a street legal configuration.

## B. SCREAMIN' EAGLE® STREET LEGAL BIG BORE STAGE II KIT FOR EFI MODELS – 103 CUBIC INCHES\*

The Stage II Big Bore Kit provides the parts you need to increase the horsepower of your EFI-equipped model. The kit increases the displacement of your Twin Cam-equipped model from 96 cubic inches (1584cc) to 103 cubic inches (1690cc). Includes Stage II (SE-255) cams, Big Bore cylinders, Big Bore flat top pistons, clips, and a Stage I Air Cleaner Kit with one-piece back plate, integral breathers, all mounting hardware, and gaskets. Also includes a high performance clutch spring. Separate purchase of cam spacers is required. See manual for proper procedure and cam spacer part numbers. Requires separate purchase of primary cover gasket. Not all components shown. 49-state kits include catalyst mufflers or headers, and California kits are street legal on California pollution controlled vehicles when used with Original Equipment mufflers. All EFI-equipped models require ECM calibration\* (priced separately).

Fits 50-state '10 Softail models.  
Also fits '08-later California Softail models.\*

**27543-08** Black. **\$899.95**

Fits 50-state '10 Touring models (except FLHTK, FLHX, FLTRX and Trike). Also fits '08-later California Touring models (except Trike, FLHTK, FLHX and FLTRX).\*

**27557-08** Black. **\$899.95**

**27558-08** Silver. **\$899.95**

Fits 50-state '10 Dyna models. Also fits '08-later California Dyna models (except FXDF and FXDWG).\*

**27545-08** Black. **\$899.95**

Fits 49-state '09 Touring models (except Trike).  
Not street legal in California.\*

**27564-09** Black. **\$899.95**

**27565-09** Silver. **\$899.95**

Fits 49-state '08 Touring models.  
Not street legal in California.\*

**27532-08** Black. **\$1,199.95**

**27533-08** Silver. **\$1,199.95**

Fits 49-state '08-'09 Dyna® models (except FXDF).  
Not street legal in California.\*

**27541-08** Black. **\$1,199.95**

Fits '09 Dyna FXDF models.  
50-state street legal.\*

**27566-09** Black. **\$899.95**

**NOTICE:** Installation of automatic or manual compression releases on large displacement engines is highly recommended.

SCREAMIN' EAGLE

## B. SCREAMIN' EAGLE STREET LEGAL BIG BORE STAGE II KIT FOR EFI MODELS – 103 CUBIC INCHES

Notice: The prices appearing in this catalog are the manufacturer's suggested retail prices. Actual retail prices may vary.



# 470 SCREAMIN' EAGLE®

Twin Cam/Evo Stage Kits

## A. SCREAMIN' EAGLE® BIG BORE STAGE I KIT FOR EFI MODELS – 103 CUBIC INCHES\*

This Big Bore Kit lets you increase the displacement of your Twin Cam 96 engine-equipped model from 96 cubic inches (1584cc) to 103 cubic inches (1690cc). Includes Big Bore cylinders, Big Bore flat top piston assemblies and a Stage I Air Cleaner Kit with one-piece back plate, integral breathers, all mounting hardware, and gaskets. A high performance clutch spring is included to provide the additional clutch capacity required by the extra torque. Requires separate purchase of primary cover gasket. This kit is street legal when used with stock mufflers. (Not all components shown.) All EFI-equipped models require ECM calibration\* (priced separately).

\*Recalibration is required for proper installation, and will allow engine to rev to 6200 RPM. See dealer for details. Labor cost not included.

Fits all '07 Twin Cam and '08-later Softail® models.\*

<b>29903-07A</b>	Black.	<b>\$639.95</b>
<b>29904-07A</b>	Silver.	<b>\$639.95</b>

Fits '08-later Dyna® models.\*

<b>27535-08</b>	Black.	<b>\$639.95</b>
<b>27536-08</b>	Silver.	<b>\$639.95</b>

Fits '08-later Touring models (except FLHTK and Trike).\*

<b>27539-08</b>	Black.	<b>\$639.95</b>
<b>27540-08</b>	Silver.	<b>\$639.95</b>

Fits European '10 Touring models. Legal on HDI configured models when used with stock exhaust and air cleaner.

<b>27534-10</b>	Black.	<b>\$639.95</b>
-----------------	--------	-----------------

**NOTICE:** Installation of automatic or manual compression releases on large displacement engines is highly recommended.

## B. SCREAMIN' EAGLE® EVOLUTION 1340 EFI STAGE I PERFORMANCE KIT\*\*

This 50-state street legal kit increases torque throughout the RPM range, with a 15% increase at the peak. Stage I Kit includes air cleaner and breather kit, and all required hardware. All models require ECM calibration\*\* (priced separately). These kits are designed to work with stock mufflers.

**29387-97B** **\$119.95**

Fits '97-'98 Evolution® 1340-equipped EFI models only. Also fits '95-'96 Evolution 1340-equipped EFI models when used with ECM P/N 32423-97B. (Does not fit Twin Cam-equipped models.)

\*\*Recalibration is required for proper installation, and will allow engine to rev to 6000 RPM. See dealer for details. Labor cost not included.

## C. SCREAMIN' EAGLE® PERFORMANCE AIR CLEANER FOR VRSC™ MODELS

This high flow air cleaner provides the clean stable air the engine needs for maximum performance. The washable filter element does not require oiling.

**29793-02C** Fits '02-later VRSC™ models. **\$64.95**

**CAUTION:** Dealer installation required – failure to comply may result in a lean fuel condition and severe engine damage.

**CAUTION:** Harley-Davidson EFI systems will not compensate for any component changes. Do not mill heads or increase compression in any way. Do not use cams other than those supplied in the kit. Do not change kit components. Failure to comply may result in engine damage.



A. SCREAMIN' EAGLE BIG BORE STAGE I KIT FOR EFI MODELS – 103 CUBIC INCHES



B. SCREAMIN' EAGLE EVOLUTION 1340 EFI STAGE I PERFORMANCE KIT

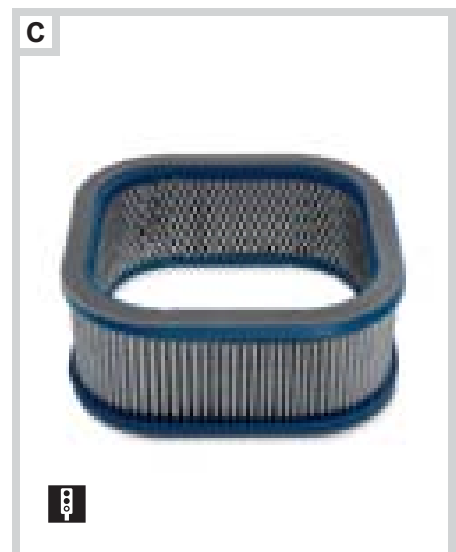

C. SCREAMIN' EAGLE PERFORMANCE AIR CLEANER FOR VRSC MODELS

Notice: The prices appearing in this catalog are the manufacturer's suggested retail prices. Actual retail prices may vary.

# SCREAMIN' EAGLE® 471

Air Cleaner Kits



**D. SCREAMIN' EAGLE STAGE I AIR CLEANER KIT – MULTI-FIT**



**D. SCREAMIN' EAGLE STAGE I AIR CLEANER KIT – '08-LATER DYNA**



**D. SCREAMIN' EAGLE STAGE I AIR CLEANER KIT – '08-LATER TOURING**



**E. SCREAMIN' EAGLE AIR CLEANER BACK PLATE KIT**

## D. SCREAMIN' EAGLE® STAGE I AIR CLEANER KIT – TWIN CAM MODELS\*

Kit features a one-piece cast back plate with integral breather and mounting brackets for simplified installation, and a "state of the art" synthetic media washable air cleaner element that does not require oiling. If you want more torque from your Twin Cam-equipped model, this kit provides a freer breathing capability to pump-up the power of your EFI-equipped motorcycle. This kit includes air cleaner, breather, and all required hardware. Street legal when used with stock mufflers. All EFI-equipped models require ECM calibration\* (*priced separately*).

\*Recalibration is required for proper installation, and will allow engine to rev to 6200 RPM. See dealer for details. Labor cost not included.

**29773-02C \$139.95**

Fits '08-later Softail and '08-later Dyna equipped with accessory Air Cleaner Covers (stock on '08 CVO Dyna). (FLSTSB models require separate purchase of Gasket P/N 29591-99 and Screw P/N 29703-00.) Also fits '01-'07 EFI Softail, '02-'07 EFI Touring, '04-'07 EFI Dyna and models equipped with Accessory Air Cleaner Covers. (Stock on '05 FLSTFI 15th Anniversary, '05-'07 CVO Softails, '07 CVO Dyna, and '07 CVO Road King models.) '06-'07 CVO Electra Glide models require the separate purchase of Air Cleaner Cover P/N 29121-07. Air Cleaner Trim is sold separately.\*

**29406-08 \$149.95**

Fits '08-later Dyna models with Original Equipment Air Cleaner Cover.\*

**29260-08 \$139.95**

Fits '08-later Touring and Trike models with Original Equipment 50mm Throttle Body. '08-later CVO models require separate purchase of Air Cleaner Cover P/N 29121-07.\*

**29489-99C \$139.95**

Fits '99-'01 fuel-injected Touring models.\*

## E. SCREAMIN' EAGLE® AIR CLEANER BACK PLATE KIT

Finished in brilliant chrome or wrinkle black, this replacement back plate complements the finish of your engine. Cast back plate design features integral breather and mounting brackets for simplified installation.

Fits '99-later Softail®, '02-'07 Touring and '99-'07 Dyna® models equipped with Screamin' Eagle Stage Kits or High Flow Air Cleaner Kits. Installation may require separate purchase of (2) O-Ring P/N 11292, (2) Breather Tube P/N 29557-05, and (2) Breather Screw P/N 29465-99. See your dealer for details.

**29510-05 Chrome. \$49.95**

**29586-06 Wrinkle Black. \$39.95**

Fits '08-later Dyna models.

**29170-08 Chrome. \$49.95**

**29119-08 Wrinkle Black. \$39.95**

Fits '08-later Touring models.

**29624-08 Chrome. \$49.95**

**29319-08 Wrinkle Black. \$39.95**

Notice: The prices appearing in this catalog are the manufacturer's suggested retail prices. Actual retail prices may vary.

# 472 SCREAMIN' EAGLE®

Air Cleaner Kits

## A. SCREAMIN' EAGLE® STREET LEGAL "HEAVY BREATHER" PERFORMANCE AIR CLEANER KIT

This high-flow forward-facing exposed element Air Cleaner Kit is sure to turn heads at the starting line. Featuring a polished elbow and exposed filter, this unique air cleaner system offers improved performance and air flow when compared to the stock or Screamin' Eagle High Flow air cleaner. The washable and re-chargeable filter features a bright chrome end cap with a laser-engraved Screamin' Eagle logo. Intake tube and back plate are made from die cast lightweight aluminum, and are polished and chrome-plated or painted black for a brilliant finish. The back plate features integral breathers and sealed breather bolt plug. Kit includes a water-repellent rain sock and all mounting hardware. All EFI-equipped models require ECM calibration\* (priced separately).

Fits '08-later Touring models. Does not fit models equipped with fairing lower glove boxes. Street legal when used with Original Equipment throttle body.\*

<b>29006-09A</b>	Gloss Black.	<b>\$299.95</b>
<b>29253-08A</b>	Chrome.	<b>\$299.95</b>

Fits '08-later Touring models equipped with Fairing Lower Glove Boxes. Street legal when used with Original Equipment throttle body.

<b>28716-10</b>	Compact Design – Chrome.	<b>\$299.95</b>
-----------------	--------------------------	-----------------

Fits '08-later Dyna® and Softail® models.\*

<b>29098-09</b>	Gloss Black.	<b>\$299.95</b>
<b>29299-08</b>	Chrome.	<b>\$299.95</b>

Fits '08-later XL models.\*

<b>29080-09</b>	Gloss Black.	<b>\$299.95</b>
<b>29264-08</b>	Chrome.	<b>\$299.95</b>

\*Recalibration is required for proper installation. See dealer for details. Labor cost not included.

## B. SCREAMIN' EAGLE "HEAVY BREATHER" RAIN SOCK

Caught in the rain? This element cover is tailored to provide a perfect fit, decorated with the Screamin' Eagle Logo. Made from breathable and water resistant material, this cover lets air through while water beads and rolls off your Heavy Breather Air Cleaner element. Don't get caught without it.

<b>29493-05</b>		<b>\$19.95</b>
-----------------	--	----------------

Fits models equipped with Heavy Breather Air Cleaner Kits.

## C. SCREAMIN' EAGLE "HEAVY BREATHER" DECORATIVE MEDALLION

Add the finishing touch to your Heavy Breather Air Cleaner by installing this medallion. Featuring a bright chrome-plated die cast base and contrasting black inlay with diamond cut "Screamin' Eagle" script. Easy to install.

<b>29017-09</b>		<b>\$19.95</b>
-----------------	--	----------------

Fits models equipped with Heavy Breather Air Cleaner Kits.

## D. SCREAMIN' EAGLE HEAVY BREATHER DECORATIVE ENDCAP – WILLIE G. SKULL

Add a sinister touch to your Heavy Breather Air Cleaner. Chrome-plated self-adhesive cover features a forward-facing "Willie G. Skull" medallion.

<b>28720-10</b>		<b>\$29.95</b>
-----------------	--	----------------

Fits models equipped with Screamin' Eagle Heavy Breather Air Cleaner Kits (except Compact Version P/N 28716-10).



A. SCREAMIN' EAGLE "HEAVY BREATHER" PERFORMANCE AIR CLEANER KIT – SOFTAIL/DYNA – CHROME



A. SCREAMIN' EAGLE "HEAVY BREATHER" PERFORMANCE AIR CLEANER KIT – SOFTAIL/DYNA – BLACK

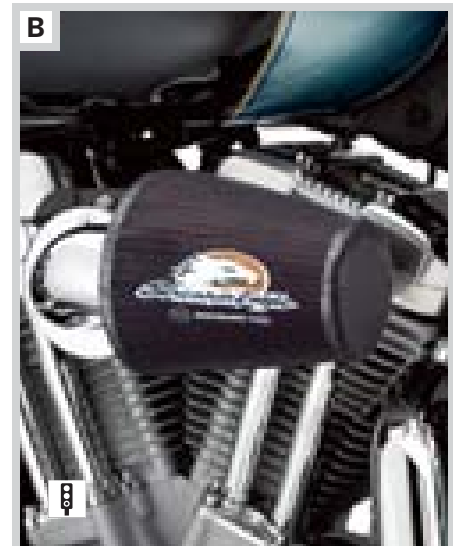

B. SCREAMIN' EAGLE "HEAVY BREATHER" RAIN SOCK



C. SCREAMIN' EAGLE "HEAVY BREATHER" DECORATIVE MEDALLION



D. SCREAMIN' EAGLE "HEAVY BREATHER" DECORATIVE ENDCAP – WILLIE G. SKULL

Notice: The prices appearing in this catalog are the manufacturer's suggested retail prices. Actual retail prices may vary.

# SCREAMIN' EAGLE® 473

Air Cleaner Kits



NEW

E

E. SCREAMIN' EAGLE "VENTILATOR" PERFORMANCE AIR CLEANER KIT – CHROME

## E. SCREAMIN' EAGLE® "VENTILATOR" PERFORMANCE AIR CLEANER KIT

E

Stylish low-profile exposed element air cleaner kit provides increased air flow to boost the power of your fuel injected engine. The track-inspired exposed element adds a purposeful look to the bike, and the included waterproof rain sock protects the filter during inclement weather. This easy-to-install kit includes low-profile air cleaner cover, high-flow filter element, back plate, Screamin' Eagle badge, protective rain sock, and all required installation hardware. Street legal when used with stock mufflers. All EFI-equipped models require ECM calibration\* (priced separately).

Fits '09-later Touring models. Also fits '09-later Trike models.

<b>29490-09</b>	Chrome.	<b>\$225.25</b>
<b>29915-09</b>	Gloss Black.	<b>\$239.95</b>

Fits '10 Dyna® and Softail® models.

<b>28721-10</b>	Chrome.	<b>\$239.95</b>
<b>28722-10</b>	Gloss Black.	<b>\$239.95</b>

## F. SCREAMIN' EAGLE "HEAVY BREATHER" AND STREET PERFORMANCE EXHAUST KIT

E

This street legal combination pairs two great accessories in one convenient package, the Screamin' Eagle Heavy Breather air intake system and the Screamin' Eagle Blunt Revolver Street Performance mufflers. Kit provides high style, improved sound quality, and great performance. All EFI-equipped models require ECM calibration\* (priced separately). Mufflers are 50-state street legal on stock displacement '08-later FXDF and '10 FXDWG models.

**29408-08** **\$619.95**

Fits '08-later FXDF and '10 FXDWG models.

\*Recalibration is required for proper installation. See Dealer for details. Labor cost not included.



NEW

E

E. SCREAMIN' EAGLE "VENTILATOR" PERFORMANCE AIR CLEANER KIT – GLOSS BLACK



E

E. SCREAMIN' EAGLE "VENTILATOR" AIR CLEANER – SHOWN WITH RAIN SOCK



F

F. SCREAMIN' EAGLE "HEAVY BREATHER" AND STREET PERFORMANCE EXHAUST KIT

SCREAMIN' EAGLE

Notice: The prices appearing in this catalog are the manufacturer's suggested retail prices. Actual retail prices may vary.



# 474 SCREAMIN' EAGLE®

Air Cleaner Covers

## A. FORGED BILLET ALUMINUM AIR CLEANER COVER

This unique Billet Aluminum Air Cleaner Cover is styled with inverted V-shape air inlets to complement the V-twin engine profile, and is designed with a generous open intake to maximize engine breathing. Manufactured from 6061-T6 billet aluminum, this high-quality forged dual throat air cleaner cover is expertly CNC-machined to exacting tolerances. Then, its surfaces are polished mirror-smooth, and chrome-plated or black-anodized to match your customizing direction. The air cleaner kits include complementing brushed aluminum or matte black side inserts and a hidden mounting bolt. Complete the installation with one of the numerous custom medallion inserts (*sold separately*).

Fits Twin Cam and '93-'99 Evolution® 1340 carbureted models equipped with Screamin' Eagle® Air Cleaner Kits (cone shaped filter). See your dealer for specific applications.

<b>29745-00A</b>	Chrome.	<b>\$219.95</b>
<b>29506-09</b>	Black Anodized.	<b>\$219.95</b>

Shown with:

### BILLET AIR CLEANER SIDE INSERT KIT

Add a touch of color to the H-D® Forged Billet Aluminum Air Cleaner Cover. These easy-to-install Side Inserts are available in a matte black finish to add depth and dimension.

<b>97005-02</b>	<b>\$6.95</b>
-----------------	---------------

Fits Chrome Forged Billet Aluminum Air Cleaner Cover P/N 29745-00A.

Also shown with:

### BILLET AIR CLEANER MEDALLION KITS

These polished and chrome-plated inserts for the Billet Air Cleaner Cover snap easily into place. The kit includes an O-ring gasket and individual decorative medallions.

Fits Forged Billet Aluminum Air Cleaner Cover P/N 29745-00A and 29506-09.

<b>29902-09</b>	Dark Custom Logo.	<b>\$38.95</b>
<b>29929-07</b>	Screamin' Eagle 96 Cubic Inch.	<b>\$38.95</b>
<b>29888-06</b>	Screamin' Eagle 103 Cubic Inch.	<b>\$38.95</b>
<b>29898-06</b>	Screamin' Eagle 110 Cubic Inch.	<b>\$38.95</b>

## B. SMOOTH AIR CLEANER COVER

Wrap your Screamin' Eagle® round air cleaner element in style. The mirror-chrome low-profile Air Cleaner Cover shields the element and opens breathing space between the backing plate and the cover. Cut-away bottom design exposes the air cleaner element to maximize the air flow. Easy-to-install, the one-piece cover is the ideal complement to the Chrome Air Cleaner Back Plate P/N 29510-05.

<b>29153-07</b>	<b>\$44.95</b>
-----------------	----------------

Fits '99-later Twin Cam models equipped with Screamin' Eagle Stage Kits or High Flow Air Cleaner Assembly. '08 Dyna® models require separate purchase of Stage I Air Cleaner Kit P/N 29773-02C.



**A. FORGED BILLET ALUMINUM AIR CLEANER COVER – BLACK ANODIZED (SHOWN WITH BILLET AIR CLEANER MEDALLION KIT – DARK CUSTOM LOGO COLLECTION)**



**A. BILLET AIR CLEANER AND MEDALLION KIT – SCREAMIN' EAGLE 96 CUBIC INCH**



**A. BILLET AIR CLEANER AND MEDALLION KIT – SCREAMIN' EAGLE 103 CUBIC INCH**



**A. BILLET AIR CLEANER AND MEDALLION KIT – SCREAMIN' EAGLE 110 CUBIC INCH**



**B. SMOOTH AIR CLEANER COVER**

Notice: The prices appearing in this catalog are the manufacturer's suggested retail prices. Actual retail prices may vary.



# SCREAMIN' EAGLE® EXHAUST

*Street-sweeping sound and captivating style are the most prominent features of these pipes, but it's the added torque and horsepower that really make them worth it. Street Performance Mufflers are perfect for immediate results over a wide RPM range, while the ballistic shape lets everyone know what they're up against.*

## POWER VS. NOISE

*A loud exhaust system doesn't mean improved performance. Screamin' Eagle Street Performance Mufflers are designed to significantly increase airflow and add torque and horsepower you can feel — with a twist of the throttle. Engineered with carefully-managed back pressure, Street Performance Mufflers deliver where it counts — during a roll-on pass or on a*

*long run up a steep grade. All street-legal Harley-Davidson exhaust systems meet EPA regulations and carry an EPA stamp.*

*Freedom and the right to ride are at the heart of motorcycling. We understand that unless we, as riders, take steps to be socially responsible, our right to ride and our lifestyle may be in jeopardy. Remember to ride respectfully.*



# 476 SCREAMIN' EAGLE®

Sportster Exhaust

## A. SCREAMIN' EAGLE® STREET PERFORMANCE SLIP-ON MUFFLERS – SPORTSTER® SHORTY DUAL

Street legal high-flow mufflers are factory tuned to deliver an aggressive exhaust note and improved performance comparable to Screamin' Eagle II mufflers. Chrome-plated mufflers feature a new ballistic-shape inlet and a deep embossed "Screamin' Eagle" signature script. 50-state street legal on stock '07-later model engines.

Fits '07-later XL models. Installation requires separate purchase of Muffler Clamps P/N 65296-95A (Qty. 2).

**80502-07** Slash Out. **\$299.95**

**80503-07** Slash Down. **\$299.95**



A. SCREAMIN' EAGLE STREET PERFORMANCE SLIP-ON MUFFLERS – SPORTSTER SHORTY DUAL, SLASH DOWN

## SPORTSTER 1200 STOCK VS. SE STREET PERFORMANCE MUFFLERS (P/N 80503-07 shown)

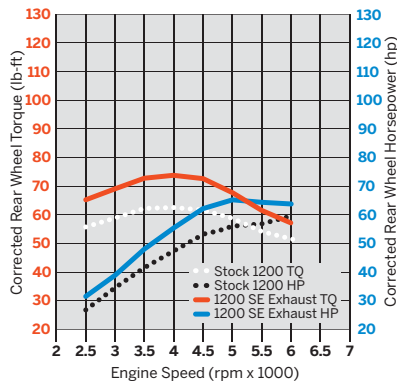

NOTE: There is no warranty on exhaust pipes and mufflers with regard to any discoloration. Blueing is caused by tuning characteristics, cam timing, carburetor jetting, over-heating, etc. and is not caused by defective manufacturing.

Notice: The prices appearing in this catalog are the manufacturer's suggested retail prices. Actual retail prices may vary.



A. SCREAMIN' EAGLE STREET PERFORMANCE SLIP-ON MUFFLERS – SPORTSTER SHORTY DUAL, SLASH OUT

# SCREAMIN' EAGLE® 477

Sportster Exhaust



**B. SCREAMIN' EAGLE STREET PERFORMANCE SLIP-ON MUFFLERS –  
SPORTSTER SHORTY DUAL, JET BLACK**

**B. SCREAMIN' EAGLE® STREET PERFORMANCE  
SLIP-ON SHORTY DUAL MUFFLERS – JET BLACK**

Street performance factory tuned mufflers in a tough black finish. Mufflers feature high flowing internals to maximize performance, an aggressive exhaust note, and a unique black ceramic coating that stands up to abuse. These pipes are a "must" to get the blacked-out look. 50-state street legal on stock '07-later model engines.

**80726-09A** **\$389.95**

Fits '07-later XL models. Installation requires separate purchase of Muffler Clamps P/N 65296-95A (Qty. 2).

**C. SCREAMIN' EAGLE® JET BLACK BUCKSHOT  
EXHAUST SHIELD KIT**

Extend the blacked-out look along the bike's entire profile. These formed steel exhaust shields feature a unique jet black ceramic coating that complements the jet black Screamin' Eagle Street Performance Slip-On Mufflers P/N 80726-09A. The black coating maintains its uniform black finish, and has survived stringent Harley-Davidson testing for durability and corrosion resistance. The Sportster model shields feature a perforated "Buckshot" design that exposes the head pipe for a raw, rebellious look. Manufactured to Original Equipment standards for exacting fit, the easy-to-install kit includes front and rear head pipe shields.

**64924-09** **\$149.95**

Fits '04-later XL models.



**C. SCREAMIN' EAGLE JET BLACK BUCKSHOT EXHAUST SHIELD KIT**

SCREAMIN' EAGLE

*Notice: The prices appearing in this catalog are the manufacturer's suggested retail prices. Actual retail prices may vary.*



# 478 SCREAMIN' EAGLE®

Sportster Exhaust

## A. HARLEY-DAVIDSON® SLIP-ON CATALYST MUFFLERS FOR SPORTSTER® MODELS

Choose your style, Slash Down or Baloney Cut. These 49-state street legal mufflers offer great sound quality and feature the "Harley-Davidson" script on the rear muffler. Not legal for sale or use on California catalyst equipped vehicles.

Fits '06 XL models.

<b>80417-06</b>	Tapered Baloney Cut.	<b>\$299.95</b>
<b>80416-06</b>	Slash Down.	<b>\$299.95</b>

## B. HARLEY-DAVIDSON SLIP-ON MUFFLERS FOR SPORTSTER MODELS

These 49-state street legal mufflers have a classic slash down or tapered baloney design that adds a custom touch to any XL. The unique cutout nestles into the Original Equipment crossover. These chrome-plated mufflers have the "Harley-Davidson" script stamped in the rear muffler.

Fits '04-'05 XL models.

<b>80415-04</b>	Slash Down.	<b>\$259.95</b>
<b>80412-04</b>	Tapered Baloney Cut.	<b>\$259.95</b>

## C. HARLEY-DAVIDSON SLIP-ON MUFFLERS

These slip-on mufflers offer great sound and classic "Harley-Davidson" script on the rear muffler. These big-body mufflers are available in a sporty 45-degree baloney cut.

Fits '98-'03 XL (except 883R), '92-'03 883 Hugger®, '96-'03 XL1200C and '92-'03 XLs equipped with Profile Low Rear Suspension P/N 54571-94A.

<b>80102-97</b>	Baloney Cut*.	<b>\$219.95</b>
-----------------	---------------	-----------------



A. HARLEY-DAVIDSON SLIP-ON CATALYST MUFFLERS – SLASH DOWN



B. HARLEY-DAVIDSON SLIP-ON MUFFLERS – TAPERED BALONEY CUT



C. HARLEY-DAVIDSON SLIP-ON MUFFLERS – BALONEY CUT

\*NOTE: Due to increased diameter of these mufflers some realignment of headpipes is usually required. It is recommended to replace exhaust port gaskets, P/N 65324-83A (stock) or P/N 17048-98 (performance), to avoid tendency of headpipes to return to original position when re-tightened.

\*NOTE: Due to the increased diameter of these mufflers, variation in support tube and frame mounting tab location (pre '98 vehicles), some contact may be experienced between the support tube and the outlet of the front muffler. Adjust as required for clearance.

NOTE: There is no warranty on exhaust pipes and mufflers with regard to any discoloration. Blueing is caused by tuning characteristics, cam timing, carburetor jetting, over-heating, etc. and is not caused by defective manufacturing.

Notice: The prices appearing in this catalog are the manufacturer's suggested retail prices. Actual retail prices may vary.

NEW

D

## SCREAMIN' EAGLE® 479

Dyna Exhaust

**D. SCREAMIN' EAGLE® STREET PERFORMANCE MUFFLERS – DYNA® STAGGERED DUAL – JET BLACK**

Make your statement before they see you coming. The throaty Screamin' Eagle Street Performance sound sets the tone, and the bold styling drives the note home. One-of-a-kind ballistic inlet shape flows back past the embossed "Screamin' Eagle" logo to the unique "Blunt Revolver" end treatment. The unique black ceramic coating stands up to abuse and the elements, and the chrome-finished end caps feature cut-out chambers that expose the jet-black finish below for a bold contrast. Complete the blacked-out look with Jet Black Exhaust Shields P/N 65247-09 (*sold separately*). Mufflers are 50-state street legal on stock displacement '08-later FXDF and '10 FXDWG models.

**80601-09****\$389.95**

Fits '08-later FXDF and '10 FXDWG models. Installation requires separate purchase of Muffler Clamps P/N 65296-95A (Qty. 2).

**Shown with:****SCREAMIN' EAGLE JET BLACK EXHAUST SHIELD KIT**

Extend the blacked-out look along the bike's entire profile. These formed steel exhaust shields feature the "tommy gun" cutouts and a unique jet black ceramic coating that complements the jet black Screamin' Eagle Street Performance Slip-On Mufflers P/N 80601-09. The black coating maintains its uniform black finish, and has survived stringent Harley-Davidson testing for durability and corrosion resistance. Manufactured to Original Equipment standards for exact fit, the easy-to-install kit includes front and rear head pipe shields.

**65247-09****\$229.95**

Fits '08-later FXDF and '10 FXDWG models with forward controls.

**E. SCREAMIN' EAGLE® STREET PERFORMANCE MUFFLERS – DYNA® STAGGERED DUAL**

Make your statement before they see you coming. The throaty Screamin' Eagle Street Performance sound sets the tone, and the bold styling drives the note home. One-of-a-kind ballistic inlet shape flows back past the embossed "Screamin' Eagle" logo to the unique "Blunt Revolver" end treatment. The black-finished end caps feature cut-out chambers that expose the mirror-chrome finish below for a bold contrast. Mufflers are 50-state street legal on stock displacement '08-later FXDF models.

**80674-08****\$349.95**

Fits '08-later FXDF and '10 FXDWG models. Installation requires separate purchase of Muffler Clamps P/N 65296-95A (Qty. 2).



**D. SCREAMIN' EAGLE STREET PERFORMANCE MUFFLERS – DYNA STAGGERED DUAL – JET BLACK (SHOWN WITH JET BLACK EXHAUST SHIELD KIT)**



**E. SCREAMIN' EAGLE STREET PERFORMANCE MUFFLERS – DYNA STAGGERED DUAL**

NOTE: There is no warranty on exhaust pipes and mufflers with regard to any discoloration. Blueing is caused by tuning characteristics, cam timing, carburetor jetting, over-heating, etc. and is not caused by defective manufacturing.

Notice: The prices appearing in this catalog are the manufacturer's suggested retail prices. Actual retail prices may vary.

# 480 SCREAMIN' EAGLE®

Dyna Exhaust

## A. SCREAMIN' EAGLE® STREET PERFORMANCE SLIP-ON MUFFLERS – DYNA® SHORTY DUAL

Factory engineers tuned these pipes to satisfy the most discriminating Harley enthusiast. Aggressive sound quality is paired with performance comparable to Screamin' Eagle II race-use mufflers, and they're street legal! Chrome-plated mufflers feature a new ballistic-shape inlet and a deep embossed "Screamin' Eagle" signature script. Street legal on stock displacement engines.

Fits '07 Dyna® models (except '07 FXDSE2) and '08-'09 49-state Dyna models (except FXDF, FXDSE2 and FXDFSE).

Installation requires separate purchase of Muffler Clamps P/N 65296-95A (Qty. 2).



~~80492-07~~ ~~Slash Out.~~ ~~OBSOLETE~~ ~~\$299.95~~

80493-07 Slash Down. \$299.95

Fits 50-state '10 Dyna models (except FXDF, FXDWG and FXDFSE2). Also fits '08-later California Dyna models (except FXDF, FXDSE2, FXDFSE/2, and '10 FXDWG). Installation requires separate purchase of Muffler Clamps P/N 65296-95A (Qty. 2).



80678-08 Slash Down. \$374.95

NOTE: "Screamin' Eagle" script not included on mufflers P/N 80678-08. "Screamin' Eagle" script is available on Muffler Heat Shield Kit P/N 64806-07A, sold separately (not shown).



A. SCREAMIN' EAGLE STREET PERFORMANCE SLIP-ON MUFFLERS – DYNA SHORTY DUAL, SLASH OUT



A. SCREAMIN' EAGLE STREET PERFORMANCE SLIP-ON MUFFLERS – DYNA SHORTY DUAL, SLASH DOWN

NOTE: There is no warranty on exhaust pipes and mufflers with regard to any discoloration. Blueing is caused by tuning characteristics, cam timing, carburetor jetting, over-heating, etc. and is not caused by defective manufacturing.

Notice: The prices appearing in this catalog are the manufacturer's suggested retail prices. Actual retail prices may vary.



NEW

B

# SCREAMIN' EAGLE® 481

Dyna Exhaust

## B. SCREAMIN' EAGLE® STREET PERFORMANCE SLIP-ON SHORTY DUAL MUFFLERS – JET BLACK

Street performance factory tuned mufflers in a tough black finish. Mufflers feature high flowing internals to maximize performance, and a rich, aggressive exhaust note that lets everyone know you're around. The heat-resistant jet-black Cermet coating stands up to abuse, and will not fade or blue. These pipes are a "must" to get the blacked-out custom look. Kit includes mufflers and jet-black muffler shields with embossed Screamin' Eagle logo. EPA stamped, these mufflers are street legal on stock displacement engines.

**80794-10** Slash Down. **\$449.95**  
 Fits '07-later Dyna® models (except FXDF, FXDSE2 and '10 FXDWG). Installation requires separate purchase of Muffler Clamps P/N 65296-95A (Qty. 2).

### Shown with: SCREAMIN' EAGLE JET BLACK EXHAUST SHIELD KIT

Extend the blacked-out look along the bike's entire profile. These formed steel exhaust shields feature a unique jet black ceramic coating that complements the jet black Screamin' Eagle Street Performance Slip-On Mufflers. The black coating maintains its uniform black finish, and has survived stringent Harley-Davidson testing for durability and corrosion resistance. Manufactured to Original Equipment standards for exact fit, the easy-to-install kit includes front and rear head pipe shields.

**80821-10** **\$159.95**  
 Fits '06-later FXD, FXDB, FXDC, FXDL and '06-'08 FXDWG models with shorty dual exhaust.

## C. HARLEY-DAVIDSON® DYNA SLIP-ON MUFFLERS

Harley-Davidson Slip-On Mufflers for Dyna models. Choose your style, slash down or baloney cut. These 50-state street legal mufflers offer great sound quality, improved performance and feature the "Harley-Davidson" script on the rear muffler.

Fits '06 Dyna® models.  
**80418-06** Slash Down. **\$299.95**

Fits '95-'05 Dyna models.  
**80366-99** Slash Down. **\$299.95**

**80104-99** Baloney Cut. **\$299.95**

SCREAMIN' EAGLE

B. SCREAMIN' EAGLE STREET PERFORMANCE SLIP-ON SHORTY DUAL MUFFLERS – JET BLACK



C

C. HARLEY-DAVIDSON DYNA SLIP-ON MUFFLERS – SLASH DOWN

NOTE: Due to increased diameter of these mufflers some realignment of headpipes is usually required. It is recommended to replace exhaust port gaskets, P/N 65324-83A (stock) or P/N 17048-98 (performance), to avoid tendency of headpipes to return to original position when re-tightened.

NOTE: There is no warranty on exhaust pipes and mufflers with regard to any discoloration. Blueing is caused by tuning characteristics, cam timing, carburetor jetting, over-heating, etc. and is not caused by defective manufacturing.

Notice: The prices appearing in this catalog are the manufacturer's suggested retail prices. Actual retail prices may vary.



# 482 SCREAMIN' EAGLE®

Softail Exhaust

## A. SCREAMIN' EAGLE® STREET PERFORMANCE SLIP-ON MUFFLERS – SOFTAIL® SHORTY DUAL

Street Performance Mufflers harness factory technology to produce a sound that is undeniably "Harley-Davidson." Not only do these mufflers make an aggressive statement with sound, they boost performance comparable to Screamin' Eagle II race-use mufflers, and are street legal. Chrome-plated mufflers feature a new ballistic-shape inlet and a deep embossed "Screamin' Eagle" signature script. Street legal on stock displacement engines.

Fits '07 Softail® models equipped with shorty dual exhaust and '08-'09 49-state Softail models with shorty dual exhaust. Installation requires separate purchase of Muffler Clamps P/N 65296-95A (Qty. 2).

**80494-07** Slash Out. **\$299.95**

**80495-07** Slash Down. **\$299.95**

Fits 50-state '10 Softail models with shorty dual exhaust. Also fits '08-later California Softail models with shorty dual exhaust. Installation requires separate purchase of Muffler Clamps P/N 65296-95A (Qty. 2).

**80679-08** Slash Down. **\$374.95**

NOTE: "Screamin' Eagle" script not included on mufflers P/N 80679-08. "Screamin' Eagle" script is available on Muffler Heat Shield Kit P/N 64806-07A, sold separately (*not shown*).



A. SCREAMIN' EAGLE STREET PERFORMANCE SLIP-ON MUFFLERS – SOFTAIL SHORTY DUAL, SLASH DOWN



A. SCREAMIN' EAGLE STREET PERFORMANCE SLIP-ON MUFFLERS – SOFTAIL SHORTY DUAL, SLASH OUT

NOTE: There is no warranty on exhaust pipes and mufflers with regard to any discoloration. Blueing is caused by tuning characteristics, cam timing, carburetor jetting, over-heating, etc. and is not caused by defective manufacturing.

Notice: The prices appearing in this catalog are the manufacturer's suggested retail prices. Actual retail prices may vary.



NEW

B

# SCREAMIN' EAGLE® 483

Softail Exhaust

## B. SCREAMIN' EAGLE® STREET PERFORMANCE SLIP-ON SHORTY DUAL MUFFLERS – JET BLACK



Street performance factory tuned mufflers in a tough black finish. Mufflers feature high flowing internals to maximize performance, and a rich, aggressive exhaust note that lets everyone know you're around. The heat-resistant jet black Cermat coating stands up to abuse, and will not fade or blue. These pipes are a "must" to get the blacked-out custom look. Kit includes mufflers and jet-black muffler shields with embossed Screamin' Eagle logo. EPA stamped, these mufflers are street legal on stock displacement engines.

**80813-10** **\$449.95**

Fits '07-later Softail models equipped with shorty dual exhaust. Installation requires separate purchase of Muffler Clamps P/N 65296-95A (Qty. 2).

### Shown with:

## SCREAMIN' EAGLE JET BLACK EXHAUST SHIELD KIT



Extend the blacked-out look along the bike's entire profile. These formed steel exhaust shields feature a unique jet black ceramic coating that complements the jet black Screamin' Eagle Street Performance Slip-On Mufflers. The black coating maintains its uniform black finish, and has survived stringent Harley-Davidson testing for durability and corrosion resistance. Manufactured to Original Equipment standards for exact fit, the easy-to-install kit includes front and rear head pipe shields.

**80818-10** **\$159.95**

Fits '08-later FXCW/C models equipped with shorty dual exhaust.

**80824-10** **\$159.95**

Fits '07-later FXST, FXSTB and FXSTC models equipped with shorty dual exhaust.



B. SCREAMIN' EAGLE STREET PERFORMANCE SLIP-ON SHORTY DUAL MUFFLERS – JET BLACK

SCREAMIN' EAGLE



NEW

B



B. JET BLACK EXHAUST SHIELD KIT – FXCW



NEW

B



B. JET BLACK EXHAUST SHIELD KIT – FXST

NOTE: There is no warranty on exhaust pipes and mufflers with regard to any discoloration. Blueing is caused by tuning characteristics, cam timing, carburetor jetting, over-heating, etc. and is not caused by defective manufacturing.

Notice: The prices appearing in this catalog are the manufacturer's suggested retail prices. Actual retail prices may vary.

# 484 SCREAMIN' EAGLE®

Softtail Exhaust

## A. SCREAMIN' EAGLE® STREET PERFORMANCE SLIP-ON MUFFLERS – SOFTAIL® SHOTGUN

Tough sound, nice performance. Street Performance Mufflers feature unique, high flow internals, tuned to sound as cool as they look. These mufflers boast performance you can feel, comparable to Screamin' Eagle II race-use mufflers. Chrome-plated mufflers feature a new ballistic-shape inlet and are street legal. Complement the unique inlet shape with matching shields (*sold separately*) that feature a deep embossed "Screamin' Eagle" signature script. Street legal on stock displacement engines.

Fits '07 FLSTF and FXSTD models equipped with shotgun exhaust and '08-'09 49-state FLSTF models with shotgun exhaust. Installation requires separate purchase of Muffler Clamps P/N 65296-95A (Qty. 2).

**80496-07** Slash Out. **\$299.95**

**80497-07** Slash Down. **\$299.95**

Fits 50-state '10 FLSTF and FLSTFB models with shotgun exhaust. Also fits '08-later California FLSTF and FLSTFB models with shotgun exhaust. Installation requires separate purchase of Muffler Clamps P/N 65296-95A (Qty. 2).

**80680-08** Slash Down. **\$374.95**

### Shown with:

#### SCREAMIN' EAGLE® MUFFLER SHIELDS – SHOTGUN

Styled to complement the ballistic inlet shape of the Screamin' Eagle Street Performance Slip-On Mufflers. The rear shield features a deep embossed "Screamin' Eagle" signature script. Kit includes chrome-plated front and rear shields and mounting hardware.

**64806-07A** **\$49.95**

Fits '07-later Screamin' Eagle Street Performance 3-1/2" diameter mufflers.



A. SCREAMIN' EAGLE STREET PERFORMANCE SLIP-ON MUFFLERS – SOFTAIL SHOTGUN (FAT BOY SHOWN), SLASH OUT (SHOWN WITH SCREAMIN' EAGLE MUFFLER SHIELDS)



A. SCREAMIN' EAGLE STREET PERFORMANCE SLIP-ON MUFFLERS – SOFTAIL SHOTGUN (FAT BOY SHOWN), SLASH DOWN (SHOWN WITH SCREAMIN' EAGLE MUFFLER SHIELDS)

NOTE: There is no warranty on exhaust pipes and mufflers with regard to any discoloration. Blueing is caused by tuning characteristics, cam timing, carburetor jetting, over-heating, etc. and is not caused by defective manufacturing.

Notice: The prices appearing in this catalog are the manufacturer's suggested retail prices. Actual retail prices may vary.



**B. SCREAMIN' EAGLE STREET PERFORMANCE SLIP-ON SHOTGUN MUFFLERS – JET BLACK**

# SCREAMIN' EAGLE® 485

Softail Exhaust

## **B. SCREAMIN' EAGLE® STREET PERFORMANCE SLIP-ON SHOTGUN MUFFLERS – JET BLACK**

Street performance factory tuned mufflers in a tough black finish. Mufflers feature high flowing internals to maximize performance, and a rich, aggressive exhaust note that lets everyone know you're around. The heat-resistant jet black Cermet coating stands up to abuse, and will not fade or blue. These pipes are a "must" to get the blacked-out custom look. Kit includes mufflers and jet-black muffler shields with embossed Screamin' Eagle logo. EPA stamped, these mufflers are street legal on stock displacement engines.

**80621-10** Slash Down. **\$449.95**  
 Fits '07-later FLSTF, FLSTFB and FXSTD models equipped with shotgun exhaust. Installation requires separate purchase of Muffler Clamps P/N 65296-95A (Qty. 2).

## **Shown with: SCREAMIN' EAGLE JET BLACK EXHAUST SHIELD KIT**

Extend the blacked-out look along the bike's entire profile. These formed steel exhaust shields feature a unique jet black ceramic coating that complements the jet black Screamin' Eagle Street Performance Slip-On Mufflers. The black coating maintains its uniform black finish, and has survived stringent Harley-Davidson testing for durability and corrosion resistance. Manufactured to Original Equipment standards for exact fit, the easy-to-install kit includes front and rear head pipe shields.

**80817-10** **\$189.95**  
 Fits '07-later FLSTF, FLSTFB and FXSTD models equipped with shotgun exhaust.

SCREAMIN' EAGLE



**B. JET BLACK EXHAUST SHIELD KIT – FAT BOY**

NOTE: There is no warranty on exhaust pipes and mufflers with regard to any discoloration. Blueing is caused by tuning characteristics, cam timing, carburetor jetting, over-heating, etc. and is not caused by defective manufacturing.

Notice: The prices appearing in this catalog are the manufacturer's suggested retail prices. Actual retail prices may vary.



# 486 SCREAMIN' EAGLE®

Softtail Exhaust

## A. SCREAMIN' EAGLE® STREET PERFORMANCE SLIP-ON MUFFLERS – SOFTAIL® SHOTGUN

Tough sound, nice performance. Street Performance Mufflers feature unique, high flow internals, tuned to sound as cool as they look. These mufflers boast performance you can feel, comparable to Screamin' Eagle II race-use mufflers. Chrome-plated mufflers feature a new ballistic-shape inlet and are street legal. Complement the unique inlet shape with matching shields (*sold separately*) that feature a deep embossed "Screamin' Eagle" signature script. Street legal on stock displacement engines.

Fits '07 FLSTN models with shotgun exhaust and '08-'09 49-state FLSTN and FLSTSB models with shotgun exhaust. Installation requires separate purchase of Muffler Clamps P/N 65296-95A (Qty. 2).

**80500-07** Slash Out. **\$299.95**

**80501-07** Slash Down. **\$299.95**

Fits 50-state '10 FLSTN and FLSTSB models with shotgun exhaust. Also fits '08-later California FLSTN and FLSTSB models with shotgun exhaust. Installation requires separate purchase of Muffler Clamps P/N 65296-95A (Qty.2).

**80681-08** Slash Down. **\$374.95**

### Shown with:

#### SCREAMIN' EAGLE® MUFFLER SHIELDS – SHOTGUN

Styled to complement the ballistic inlet shape of the Screamin' Eagle Street Performance Slip-On Mufflers. The rear shield features a deep embossed "Screamin' Eagle" signature script. Kit includes chrome-plated front and rear shields and mounting hardware.

**64806-07A** **\$49.95**

Fits '07-later Screamin' Eagle Street Performance 3-1/2" diameter mufflers.



A. SCREAMIN' EAGLE STREET PERFORMANCE SLIP-ON MUFFLERS – SOFTAIL DELUXE SHOWN, SLASH DOWN (SHOWN WITH SCREAMIN' EAGLE MUFFLER SHIELDS)



A. SCREAMIN' EAGLE STREET PERFORMANCE SLIP-ON MUFFLERS – SOFTAIL DELUXE SHOWN, SLASH OUT (SHOWN WITH SCREAMIN' EAGLE MUFFLER SHIELDS)

NOTE: There is no warranty on exhaust pipes and mufflers with regard to any discoloration. Blueing is caused by tuning characteristics, cam timing, carburetor jetting, over-heating, etc. and is not caused by defective manufacturing.

Notice: The prices appearing in this catalog are the manufacturer's suggested retail prices. Actual retail prices may vary.



NEW

B

# SCREAMIN' EAGLE® 487

Softail Exhaust

## B. SCREAMIN' EAGLE® STREET PERFORMANCE SLIP-ON SHOTGUN MUFFLERS – JET BLACK



Street performance factory tuned mufflers in a tough black finish. Mufflers feature high flowing internals to maximize performance, and a rich, aggressive exhaust note that lets everyone know you're around. The heat-resistant jet black Cermet coating stands up to abuse, and will not fade or blue. These pipes are a "must" to get the blacked-out custom look. Kit includes mufflers and jet-black muffler shields with embossed Screamin' Eagle logo. EPA stamped, these mufflers are street legal on stock displacement engines.

**80781-10** Slash Down. **\$449.95**

Fits '07-later FLSTN and FLSTSB models with shotgun exhaust. Installation requires separate purchase of Muffler Clamps P/N 65296-95A (Qty. 2).

### Shown with:

## SCREAMIN' EAGLE JET BLACK EXHAUST SHIELD KIT



Extend the blacked-out look along the bike's entire profile. These formed steel exhaust shields feature a unique jet black ceramic coating that complements the jet black Screamin' Eagle Street Performance Slip-On Mufflers. The black coating maintains its uniform black finish, and has survived stringent Harley-Davidson testing for durability and corrosion resistance. Manufactured to Original Equipment standards for exact fit, the easy-to-install kit includes front and rear head pipe shields.

**80829-10** **\$189.95**

Fits '07-later FLSTSB and FLSTN models equipped with shotgun exhaust.

## C. HARLEY-DAVIDSON® SOFTAIL® SLIP-ON MUFFLERS – SHOTGUN



These 49-state legal mufflers allow you to have an exhaust system with classic Slash Down ends while maintaining street legal sound level. Features "Harley-Davidson" script on upper muffler. (Not legal for sale or use on California catalyst-equipped vehicles.)

Fits '05 FLSTN models.

**80460-05** Slash Down. **\$254.95**



B. SCREAMIN' EAGLE STREET PERFORMANCE SLIP-ON SHOTGUN MUFFLERS – JET BLACK



C



C. HARLEY-DAVIDSON SOFTAIL SLIP-ON MUFFLERS – SHOTGUN, SLASH DOWN (FAT BOY SHOWN)

NOTE: There is no warranty on exhaust pipes and mufflers with regard to any discoloration. Blueing is caused by tuning characteristics, cam timing, carburetor jetting, over-heating, etc. and is not caused by defective manufacturing.

Notice: The prices appearing in this catalog are the manufacturer's suggested retail prices. Actual retail prices may vary.

SCREAMIN' EAGLE

# 488 SCREAMIN' EAGLE®

Touring Exhaust

## A. SCREAMIN' EAGLE® STREET PERFORMANCE SLIP-ON MUFFLERS – ONE PIECE

Street Performance Touring Mufflers combine aggressive sound quality with aggressive performance results. High flow internal design produces performance you can feel, comparable to Screamin' Eagle II race-use mufflers. Street legal, these chrome-plated mufflers feature a new ballistic-shape inlet and a deep embossed "Screamin' Eagle" signature script. Street legal on stock displacement engines.

Fits 50-state '09-later Touring and Trike models (except FLHTCUSE, FLTRSE, FLHXSE and '10 FLHX and FLTRX). Installation requires separate purchase of Muffler Clamps P/N 65296-95A (Qty. 2).

**80721-09** Slash Down. **\$369.95**

Fits '07 Touring models and '08 49-state Touring models (except '07-'08 FLHTCUSE and FLHRSE). Installation requires separate purchase of Muffler Clamps P/N 65296-95A (Qty. 2).

**80490-07** Slash Out. **\$369.95**

**80491-07** Slash Down. **\$369.95**

Fits '08 California Touring models (except '08 FLHTCUSE and FLHRSE). Installation requires separate purchase of Muffler Clamps P/N 65296-95A (Qty. 2).

**80677-08** Slash Down. **\$419.95**

## B. SCREAMIN' EAGLE® STREET PERFORMANCE BLACK ONE PIECE SLIP-ON MUFFLERS

Experience the dark side. Street Performance one piece touring mufflers now available in black. Features an aggressive exhaust note, high flowing internals to maximize performance, and a unique black ceramic coating, unmatched for durability. Mufflers also feature ballistic inlet shape and embossed Screamin' Eagle script logo.

**80742-09** Slash Down. **\$369.95**

Fits 50-state '09-later Touring and Trike models (except FLHTCUSE, FLTRSE, FLHXSE and '10 FLHX and FLTRX). Installation requires separate purchase of Muffler Clamps P/N 65296-95A (Qty. 2).



A. SCREAMIN' EAGLE STREET PERFORMANCE SLIP-ON MUFFLERS – ONE PIECE, SLASH DOWN



A. SCREAMIN' EAGLE STREET PERFORMANCE SLIP-ON MUFFLERS – ONE PIECE, SLASH OUT



B. SCREAMIN' EAGLE STREET PERFORMANCE BLACK ONE PIECE SLIP-ON MUFFLERS

NOTE: There is no warranty on exhaust pipes and mufflers with regard to any discoloration. Blueing is caused by tuning characteristics, cam timing, carburetor jetting, over-heating, etc. and is not caused by defective manufacturing.

Notice: The prices appearing in this catalog are the manufacturer's suggested retail prices. Actual retail prices may vary.



C. SCREAMIN' EAGLE NIGHTSTICK 2-INTO-1 SLIP-ON MUFFLER



D. SCREAMIN' EAGLE FATSHOTZ 2-INTO-2 SLIP-ON MUFFLERS



E. SCREAMIN' EAGLE JET BLACK EXHAUST SHIELD KIT – TOURING

# SCREAMIN' EAGLE® 489

Touring Exhaust

## SCREAMIN' EAGLE® DIFFUSION DISC SLIP-ON MUFFLERS

Tuned by the factory for the ultimate combination of improved performance, rich tone and legal sound levels, these 50-state street legal slip-on mufflers are the perfect match for your Touring motorcycle. The high-flow design of the external diffusion discs produces plenty of low-end "guts" for getting your fully-loaded bike away from the light, and a fat torque curve that gets you quickly around a slow-moving RV. These long and lean mirror-chrome mufflers feature an embossed Screamin' Eagle logo, and are flared to an aggressive 4" opening at the rear. The multiple stainless steel diffusion disks are capped with a blacked-out ring and stainless hardware for a classic finishing touch. These slip-on mufflers are easy to install, and are available to fit both 2-into-1 and traditional 2-into-2 Touring model exhaust configurations. Mufflers are EPA stamped.

## C. SCREAMIN' EAGLE NIGHTSTICK 2-INTO-1 SLIP-ON MUFFLER

Maximize the performance of your 2-into-1 exhaust-equipped 2010 Street Glide or Road Glide model. Designed for easy installation on the Original Equipment header pipe and muffler hanger, this long and lean muffler provides the right combination of air flow and back pressure to boost the performance and sound quality of your bike. EPA stamped, this muffler is 50-state street-legal on stock displacement engines.

**80881-10 \$249.95**

Fits 50-state '10 FLHX and FLTRX models with Original Equipment 2-into-1 exhaust. Installation requires separate purchase of Muffler Clamp P/N 65296-95A.

## D. SCREAMIN' EAGLE FATSHOTZ 2-INTO-2 SLIP-ON MUFFLERS

Provide a performance and style boost to your 2-into-2 exhaust-equipped Touring motorcycle. Designed for easy installation on the Original Equipment header pipes and muffler hangers, these mirror-chrome flared mufflers are tuned to maximize air flow while keeping the rich exhaust note within the legal limits. EPA stamped, these mufflers are 50-state street-legal on stock displacement engines.

**80847-10 \$429.95**

Fits 50-state '10 Touring and Trike models with dual exhaust (except FLHTCUSE, FLHXSE and '10 FLHX and FLTRX). Also fits '09 California Touring and Trike models (except FLHTCUSE and FLTRSE). Installation requires separate purchase of Muffler Clamps P/N 65296-95A (Qty. 2).

## FATSHOTZ 2-INTO-1 MUFFLER PERFORMANCE

(P/N 80847-10 shown)

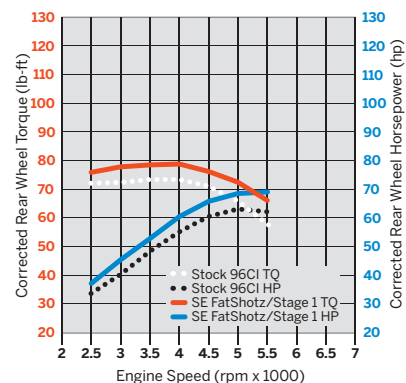

## E. SCREAMIN' EAGLE JET BLACK EXHAUST SHIELD KIT – TOURING

Extend the blacked-out look along the bike's entire profile. These formed steel exhaust shields feature a unique jet black ceramic coating that complements the jet black Screamin' Eagle Street Performance Slip-On Mufflers P/N 80742-09. The jet black coating maintains its uniform black finish, and has survived stringent Harley-Davidson testing for durability and corrosion resistance. Manufactured to Original Equipment standards for exacting fit, the easy-to-install kit includes front and rear head pipe shields.

**64981-09 \$249.95**

Fits '09-later Touring models (except '10 FLHX and FLTRX). Also fits '09-later Trike models.

NOTE: There is no warranty on exhaust pipes and mufflers with regard to any discoloration. Blueing is caused by tuning characteristics, cam timing, carburetor jetting, over-heating, etc. and is not caused by defective manufacturing.



# 490 SCREAMIN' EAGLE®

Touring Exhaust

## A. SCREAMIN' EAGLE® STREET PERFORMANCE TOURING MUFFLERS

We tuned these mufflers to provide an exhaust note with some muscle, maintained the awesome performance, and kept flexible end cap style. The Screamin' Eagle® Street Performance exhaust system combines a large internal volume with re-tuned baffles to strike the perfect balance required to deliver usable performance. The large 4" diameter cans provide the additional internal volume necessary for high flow of exhaust gases with just the right amount of back pressure. A large selection of end cap designs are available (*sold separately*) to provide the finishing touch. The final result – great sound, great performance, and your own style.

**80732-09 \$389.95**

Fits 50-state '09-later Touring models (except FLHTCUSE, FLTRSE, FLHXSE and '10 FLHX and FLTRX). Installation requires separate purchase of Muffler Clamps P/N 65296-95A (Qty. 2). Requires separate purchase of two End Caps.

**64985-07A \$389.95**

Fits '07 Touring models and '08 49-state Touring models (except '07-'08 FLHTCUSE and FLHRSE). Installation requires separate purchase of Muffler Clamps P/N 65296-95A (Qty. 2). Requires separate purchase of two End Caps.



A. SCREAMIN' EAGLE STREET PERFORMANCE TOURING MUFFLERS – SHOWN WITH REVOLVER END CAPS

## B. TOURING MUFFLER SHIELD KIT

These chrome-plated muffler shields extend the Original Equipment exhaust pipe shield to the end of the muffler and will not interfere with end caps. They are perfect for restoring the luster to your Performance Mufflers by covering any scratches or weathering. Kit includes two exhaust shields and related hardware.

**65829-00 \$134.95**

Fits Harley-Davidson® 3-1/2" Touring Mufflers, Screamin' Eagle Performance Mufflers, and Harley-Davidson Performance Mufflers. These shields are not intended for use on FLSTS models or on One-Piece Performance Mufflers.

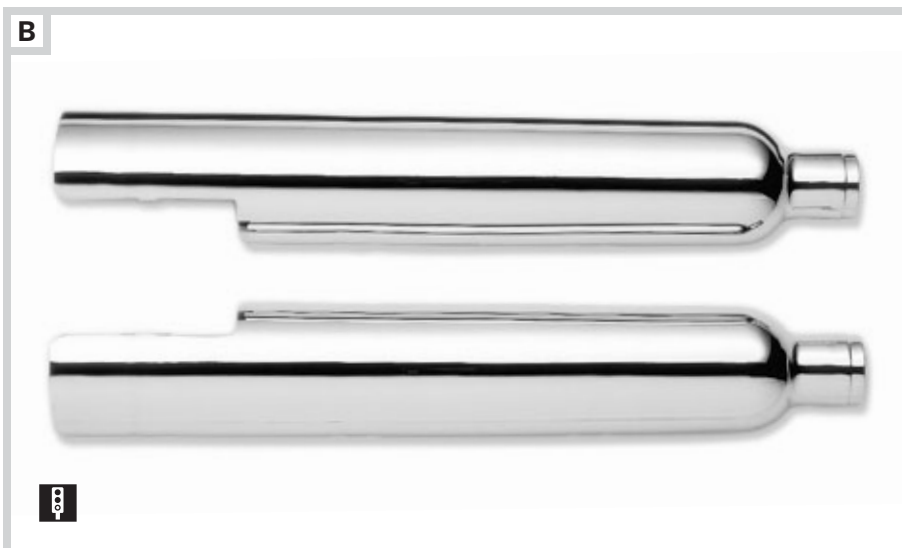

B. TOURING MUFFLER SHIELD KIT

## C. CUSTOM EXHAUST SHIELD

Complete the flow of brilliant chrome from the front to the rear of the Touring exhaust system. Chrome Front Exhaust Shield replaces the Original Equipment front shield and covers the exposed exhaust pipe adjacent to the rider footboard. Easy-to-install, the shield mounts with existing hardware.

**65694-05A \$99.62**

Fits '00-'08 Touring models. Original Equipment on '05 FLHTCSE/2 models.



C. CUSTOM EXHAUST SHIELD

## D. SCREAMIN' EAGLE PERFORMANCE EXHAUST GASKET KIT

The exhaust gasket is a flat-woven stainless steel design that does not compress into the exhaust port, improving flow out of the head into the exhaust header pipe.

**17048-98 \$7.95**

Fits Evolution 1340-equipped models, XL, XR and '99-later Twin Cam-equipped models (except Trike). (*pair*)



D. SCREAMIN' EAGLE PERFORMANCE EXHAUST GASKET KIT

NOTE: There is no warranty on exhaust pipes and mufflers with regard to any discoloration. Blueing is caused by tuning characteristics, cam timing, carburetor jetting, over-heating, etc. and is not caused by defective manufacturing.

Notice: The prices appearing in this catalog are the manufacturer's suggested retail prices. Actual retail prices may vary.

# SCREAMIN' EAGLE® 491

Touring Exhaust



**E. 4" CHROME END CAPS – SLASH UP/DOWN/OUT**



**E. 4" CHROME END CAPS – PISTON**



**E. 4" CHROME END CAPS – BILLET TAPERED SLASH**



**E. 4" CHROME END CAPS – REVOLVER**



**E. 4" CHROME END CAPS – FISHTAIL**



**F. SCREAMIN' EAGLE 4" END CAPS – BLACK AND CHROME BLUNT REVOLVER**



**G. CHROME MUFFLER BRACKET COVER KIT**



**G. CHROME MUFFLER BRACKET COVER KIT**

## E. 4" CHROME END CAPS

Sold individually.

Fits '07-later Touring models equipped with 4" Street Performance Touring Muffler Kit P/N 64985-07A and 80732-09.

<b>80622-07</b>	Slash Up/Down/Out.	<b>\$39.95</b>
<b>80618-07</b>	Piston.	<b>\$39.95</b>
<b>80623-07</b>	Billet Tapered Slash.	<b>\$64.95</b>
<b>80619-07</b>	Revolver.	<b>\$39.95</b>
<b>80616-07A</b>	Fishtail.	<b>\$55.95</b>

## F. SCREAMIN' EAGLE® 4" END CAPS – BLACK AND CHROME BLUNT REVOLVER

These stylish Revolver End Caps feature a black outer shell with chrome inner dimples that will make you stand out in the crowd. The two-piece design allows removal of outer black shell for cleaning the inner chrome surface.

**80611-09** **\$109.95**

Fits Screamin' Eagle Street Performance Touring End Cap Muffler P/N 64985-07A and 80732-09.

## G. CHROME MUFFLER BRACKET COVER KIT

Brilliant stamped-steel cover conceals the Original Equipment exhaust brackets. Contoured for a custom fit, these easy-to-install mirror-chrome covers add a distinctive finishing touch (*sold in pairs*).

**80716-08** **\$59.95**

Fits '97-later Touring models (except Trike). Fits Screamin' Eagle Street Performance Touring 4" Mufflers P/N 64985-07A and 80732-09. Does not fit with Fishtail 4" Muffler End Cap P/N 80616-07. Does not fit with Screamin' Eagle 3-1/2" Mufflers P/Ns 80490-07, 80491-07, 80677-08, 65467-05, 80463-06, or 65259-00.

# SCREAMIN' EAGLE® ENGINE PARTS & TOOLS

## FINISH LINE OR FINISHING TOUCH

*From heavy-duty internal engine and drive-line components to specialty tools and cosmetic accessories, Screamin' Eagle® can supply everything you need to build a reliable, street legal, high-performance engine.*

### ENGINE PARTS

Increased engine power and higher rev limits increase the stresses placed on other components. To maximize your engine's potential and help ensure its long-term health, remember to add high performance rocker arms, valve springs and cylinder studs into the mix. And performance clutches and drive-line components make sure you get all that power to the ground.



IGNITION  
PG : 498



ENGINE  
COMPONENTS  
PG : 493



TRANSMISSION  
PG : 497

CLUTCH  
COMPONENTS  
PG : 496



### DECORATIVE ACCESSORIES

Show off your hard work. Screamin' Eagle logo air cleaner trim and timer covers put the cap on your performance build.



### SPECIALTY TOOLS

Grab a helping hand. Screamin' Eagle Specialty Tools are designed to simplify complex engine assembly tasks.



# SCREAMIN' EAGLE® 493

Engine Components



A

## A. SCREAMIN' EAGLE® HYDRAULIC CAM CHAIN TENSIONER PLATE UPGRADE KIT

This kit updates the cam chain tensioner of your Twin Cam 88 engine to the latest design, as featured on the Twin Cam 96® engine. The billet cam support plate has been designed to allow the installation of the Twin Cam 96 hydraulic cam chain tensioner to Twin Cam 88-equipped models. These Hydraulic Cam Chain Tensioners will significantly outlast the spring loaded tensioners, and are an ideal addition to an engine modified for improved performance. In addition, '02-'06 models utilize a Twin Cam 96 single row front roller chain and sprocket (included in kit). '99-'01 models use Original Equipment front silent chain and sprocket to retain the cam position sensor function. The kit includes the improved Twin Cam 96 oil pump that increases flow by 8% and scavenging by 22% to enhance other performance upgrades.

**25284-08** **\$429.95**

Fits '99-'05 Dyna® models, '99-06 Touring models, and '00-'06 Softail® models. Installation requires separate purchase of Spacer Kit P/N 25285-08.

**Also available:**

### SCREAMIN' EAGLE CAM CHAIN TENSIONER SPACER KIT

Specifically designed for Hydraulic Cam Chain Tensioner Upgrade Kit P/N 25284-08. Kit includes an assortment of six different spacers. Spacers are required to space the cam sprocket to correct alignment with the mating pinion chain sprocket.

**25285-08** **\$17.95**

Required for installation of Screamin' Eagle Hydraulic Cam Chain Tensioner Upgrade Kit P/N 25284-08.

**Inset photo:**

### SCREAMIN' EAGLE® BILLET CAM SUPPORT PLATE

A great upgrade for any performance motor. The Billet Cam Support Plate is manufactured from billet aluminum with pressed-in bronze bushings, and is pre-assembled with the crankshaft bushing and oil pressure relief valve. Aluminum is specified at 6061 billet plate, heat treated to T6 specifications with a surface-hardened anodized finish to provide superior strength, rigidity, and durability. CNC-precision machining ensures precise dimensions and constant material thickness across the plate, enabling perfect alignment of cams and chains. Cam bushings are made from 660 bronze material to provide enhanced wear resistance, and to stand up to increased loads from the high lift cams common in large displacement motors.

**25282-07** **\$329.95**

Fits '06-later Dyna and '07-later Softail and Touring models.

## B. SCREAMIN' EAGLE LEFTY BEARING

When high performance engine modifications are made, the increased torque is transferred via the crankshaft to the drive system, putting a significantly higher load on the bearing. The Lefty Bearing is designed to provide increased load capacity and enhanced durability in high-torque applications. The bearing is installed in the left side of the crank case, and supports the output shaft to the primary drive system.

**24004-03A** **\$39.95**

Fits '03-later Twin Cam-equipped models.

## C. SCREAMIN' EAGLE TIMKEN BEARING SLEEVE

Convert a 2003-later Twin Cam model with a factory-installed roller bearing to a Timken tapered bearing. When used with Screamin' Eagle Timken Bearing Tool P/N 34823-08 (sold separately), the Bearing Sleeve can be installed without precision machining. Sleeve accepts press-in Timken bearing (sold separately).

**34822-08** **\$120.95**

Fits '03-later Twin Cam-equipped models. Installation requires separate purchase of model-specific Sprocket Spacer. '03-'05 Dyna® use P/N 24038-99A, '03-'06 Softail® use P/N 24039-01A, '03-06 Touring use P/N 24008-99, and '06-later Dyna, '07-later Softail and '07-later Touring models use P/N 11887.



B



C

B. SCREAMIN' EAGLE LEFTY BEARING

C. SCREAMIN' EAGLE TIMKEN BEARING SLEEVE

Notice: The prices appearing in this catalog are the manufacturer's suggested retail prices. Actual retail prices may vary.



# 494 SCREAMIN' EAGLE®

Engine Components

## A. SCREAMIN' EAGLE® TAPPETS

These Screamin' Eagle Tappets incorporate a unique axle, roller and bearing design that increases durability and stability of the tappets. Works well in high horsepower/high RPM applications.

**18572-07** **\$269.95**

Fits '99-later Twin Cam-equipped models and '00-later XL and XR models.

**18568-98** **\$259.95**

Fits '84-'99 Evolution® 1340-equipped models, and '86-'90 XL models. (set of 4)



A. SCREAMIN' EAGLE TAPPETS

## B. SCREAMIN' EAGLE PERFORMANCE VALVE SPRING KIT\*

This performance Beehive-shaped Valve Spring Kit will permit the Sportster engine to rev to 7000 RPM. The unique ovate wire yields increased performance from a compact spring design. The installed spring pressure is increased to 208 lbs, and allows a maximum lift of .575". Complete kit includes springs, upper collars and keepers, and lower collars with integral valve seals.

**18013-03A** **\$149.95**

Fits '04-later XL, XR and '05-later Twin Cam-equipped models. Does not fit Screamin' Eagle Performance Heads with 5/16" diameter valves.



B. SCREAMIN' EAGLE PERFORMANCE VALVE SPRING KIT

## C. SCREAMIN' EAGLE TWIN CAM FORGED ROCKER SUPPORTS

Increased strength rocker supports will handle the increased loads from higher lift cams and higher RPM applications. This product keeps valve train geometry solid. Works with stock or roller rocker arms. Includes required hardware for installation.

**17675-01B** **\$154.95**

Fits '99-later Twin Cam-equipped models.



C. SCREAMIN' EAGLE TWIN CAM FORGED ROCKER SUPPORTS

## D. SCREAMIN' EAGLE ROLLER ROCKER ARMS

Unique roller-tip design increases strength and reduces valve stem side-loading and tip friction. Built to handle cams with up to .700" lift in high RPM application. Complete kit includes set of four.

**17378-98** **\$469.95**

Fits '84-'99 Evolution 1340-equipped models, '86-later XL and XR models and '99-later Twin Cam-equipped models. (Modification is required on Twin Cam rocker covers.)



D. SCREAMIN' EAGLE ROLLER ROCKER ARMS

## E. SCREAMIN' EAGLE® PREMIUM TAPERED QUICK-INSTALL ADJUSTABLE PUSHRODS

These premium pushrods are tapered for enhanced clearance at the cylinder head, allowing the use of higher lift cams. The one-piece chrome moly tube adds rigidity and durability, and the threaded adjustment feature provides easy cam installation without removing the cylinder heads or rocker boxes. To simplify adjustment, the tube features six flats, with one flat marked with a large dot for tracking the adjustment. The threaded rod features 4 flats to reduce wrench swing. Each pushrod features the Screamin' Eagle logo and is marked for "Intake" or "Exhaust". Kit includes 4 pushrods and required pushrod tubes.

**18404-08** **\$164.95**

Fits '99-later Twin Cam-equipped models.



E. SCREAMIN' EAGLE PREMIUM TAPERED QUICK-INSTALL ADJUSTABLE PUSHRODS

## F. SCREAMIN' EAGLE QUICK-INSTALL PUSHROD KIT FOR TWIN CAM-EQUIPPED MODELS

These pushrods have been designed to allow for easier installation, adjustment, and improved durability. This unique Screamin' Eagle design allows for installation of camshafts in the Twin Cam without the removal of the heads or rocker boxes. This design is also a great performer, constructed of stiff chrome moly tubing and thread-rolled adjusters. Kit includes required pushrod tubes and clips for adjustment of pushrods.

**17997-99A** **\$146.95**

Fits '99-later Twin Cam-equipped models.



F. SCREAMIN' EAGLE QUICK-INSTALL PUSHROD KIT FOR TWIN CAM-EQUIPPED MODELS

**\*CAUTION:** Proper valve spring to rocker cover clearance must always be verified during installation of Screamin' Eagle Valve Spring Kits. Failure to have adequate clearance may result in engine damage.

Notice: The prices appearing in this catalog are the manufacturer's suggested retail prices. Actual retail prices may vary.

# SCREAMIN' EAGLE® 495

Engine Components



**G. AUTOMATIC COMPRESSION RELEASE**



**H. SCREAMIN' EAGLE BIG BORE HIGH PERFORMANCE HEAD GASKET KIT**



**I. SCREAMIN' EAGLE CV CARBURETOR TOP COVER**

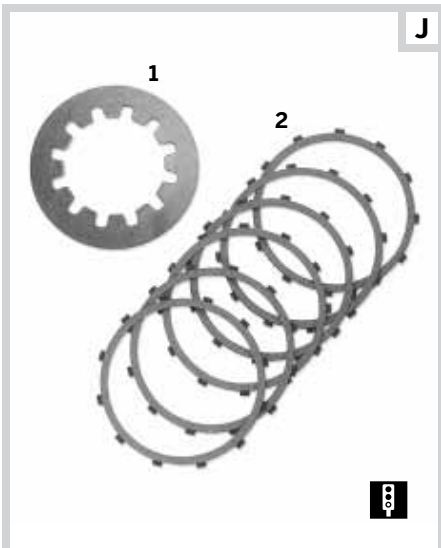

**J. HIGH PERFORMANCE CLUTCH DISCS AND SPRING FOR '89-EARLIER MODELS**



**K. SCREAMIN' EAGLE PERFORMANCE CLUTCH KIT**

**G. AUTOMATIC COMPRESSION RELEASE**

Automatic Compression Release (ACR) valves reduce the strain of starting your high performance motor by reducing cylinder compression – automatically! The engine is easier to turn over, resulting in less wear on your starter and battery. After start, the ACR valves close to restore full compression. ACR gives you peace of mind and protects your investment. ACR can be installed on stock or Screamin' Eagle Performance cylinder heads for all '07-later Twin Cam-equipped models. Installation requires machining to be performed by a competent machinist using the Screamin' Eagle Automatic Compression Release Fixture Kit P/N 94648-08 (sold separately). Installation requires separate purchase of model-specific ACR Wiring Harness P/N 70623-06 or 70623-08.

**28861-07A** **\$34.95**  
Fits '07-later Twin Cam-equipped models. Can be used with Original Equipment or Screamin' Eagle Cylinder Heads. (each)

Also available:

**SCREAMIN' EAGLE® AUTOMATIC COMPRESSION RELEASE WIRING HARNESS**

**70623-06** **\$59.95**  
Fits '07-later Dyna and Softail models and '07 Touring models equipped with Automatic Compression Release Cylinder Heads.

**70623-08** **\$49.95**  
Fits '08-later Touring models equipped with Automatic Compression Release Cylinder Heads (except '10 FLHTCU, FLHTK, FLHXXX, and '09-'10 FLHTCUTG).

**H. SCREAMIN' EAGLE BIG BORE HIGH PERFORMANCE HEAD GASKET KIT**

This multi-layered head gasket provides improved sealing for 3-7/8" Big Bore high performance engines. Sold in pairs. For engines with compression ratios above 10.0:1, Screamin' Eagle High Tensile Cylinder Studs P/N 16505-01 are required.

**16101-01** **\$44.95**  
Fits '99-later Big Bore Twin Cam-equipped models.

**I. SCREAMIN' EAGLE CV CARBURETOR TOP COVER**

This great looking carb top adds a finishing touch to the Original Equipment or Screamin' Eagle 44mm CV carburetor. The die-cast top features a brilliant chrome finish and "Screamin' Eagle" diamond engraving for clean crisp detail.

**27477-04** **\$26.95**  
Fits carbureted models equipped with Original Equipment or Screamin' Eagle Big Bore 44mm CV carburetor.

**J. HIGH PERFORMANCE CLUTCH DISCS AND SPRING FOR '89-EARLIER MODELS**

Offers increased clutch capacity. Reduces clutch slippage and resultant heat build-up under heavy use/high performance engines.

**1. Screamin' Eagle Clutch Spring** **\$23.95**  
**37875-86A**  
Fits '84-1/2-'89 1340cc wet clutch models.

**High Performance Clutch Spring** **\$23.95**  
**36783-87** Fits '84-1/2-'90 XL alternator models.

**2. Screamin' Eagle Clutch Discs** **\$90.00**  
**37931-84**  
Fits '82-1/2-'89 1340cc wet clutch models. Stock production on '87-'89 models. Set of six.

**K. SCREAMIN' EAGLE PERFORMANCE CLUTCH KIT**

Performance clutch kit converts the 8-plate clutch to a 9-plate design. The surface area is increased by 13%, and the spring rate is increased by 10% for a combination that can handle over 115 lb-ft of torque at the crank, a 23% increase over the stock-rated capacity. Kit includes Kevlar-based friction discs and performance clutch spring.

**38002-04** **\$199.95**  
Fits '91-later XL, XR models and '94-'97 Evolution® 1340-equipped models.

Notice: The prices appearing in this catalog are the manufacturer's suggested retail prices. Actual retail prices may vary.

# 496 SCREAMIN' EAGLE®

Clutch Components

## A. SCREAMIN' EAGLE® TWIN CAM PERFORMANCE RACE CLUTCH HUB KIT

Innovative new clutch hub kit offers improved clutch performance, and is perfect for large displacement applications. Will support engines producing up to 160 lb-ft of torque. Kit includes the hub, pressure plate and clutch springs, and can be used with stock friction discs and spacers or Screamin' Eagle Friction Disc Kit P/N 37980-10. (Does not include clutch friction plates.)

**37976-08** **\$249.95**  
Fits '07-later Twin Cam-equipped models. Does not fit models equipped with Hydraulic Clutch.

## B. SCREAMIN' EAGLE® RACE CLUTCH KIT

This clutch has an innovative design that features new long life friction plates and 6 individual coil springs to adjust your clutch to your specific needs. Designed to handle up to 160 lb-ft of torque at the crank.

**37970-03A** **\$384.95**  
Fits '90-'99 Evolution® 1340-equipped models and '99-'06 Softail®, Touring and '99-'05 Dyna® models. (Will not fit models equipped with Hydraulic Clutch.)

NOTE: '90-'97 Evolution 1340-equipped models require Clutch Shell P/N 37707-98A and Rod Adjuster Screw P/N 37090-98A. '90-'93 Evolution 1340-equipped models also require starter P/N 31553-94B.

## C. SCREAMIN' EAGLE PERFORMANCE CLUTCH FRICTION DISC KIT

Newly-developed friction material delivers longer life than Original Equipment friction discs. Kit includes new precision-machined flat steel plates. This Friction Disc Kit is a perfect match for the Screamin' Eagle Twin Cam Performance Race Clutch Hub Kit P/N 37976-08.

**37980-10** **\$169.95**  
Fits '99-later Twin Cam-equipped model and '98-later Evolution-equipped models.

**Heavy Duty Clutch Spring for Stock Clutch** (not shown)

**37951-98** **\$29.95**  
Fits '99-later Twin Cam-equipped models and '98-later Evolution 1340-equipped models.

## D. SCREAMIN' EAGLE BIG TWIN COMPENSATOR

This premium compensator has been engineered with heavier springs and increased travel to support the high-torque output associated with high compression race and large displacement engines. Designed to support up to 7 times the energy absorption capacity of the Original Equipment compensator, this unit helps protect the engine and driveline components during harsh drag race launches. The perfect addition to a complete performance upgrade, and it complements the installation of the Screamin' Eagle Performance Clutch Hub P/N 37976-08.

**40274-08** **\$249.95**  
Fits '06-later Dyna, '07-later Softail (except FXCW, FXCWC and FXSTSSE3), and '07-later Touring models. Original Equipment on Trike models. Installation on '06 Dyna models requires separate purchase of '07-style stator.

## E. SCREAMIN' EAGLE PERFORMANCE SLIPPER CLUTCH FOR VRSC MODELS

This clutch offers reduced lever effort and improved performance. The unique "slip and assist" ramp system opens the two halves of the clutch hubs slightly during high loads to the drivetrain, allowing a moderate slip that reduces shock to the drivetrain during rapid downshifting. The resulting reduction in wheel hop allows maximum contact between the tire and the road in wet or slippery conditions. Clutch lever effort is also reduced by 20% in 1130cc and 30% on 1250cc applications.

**37938-08KA** **\$239.95**  
Fits '02-'07 VRSC models.



A. SCREAMIN' EAGLE TWIN CAM PERFORMANCE RACE CLUTCH HUB KIT



B. SCREAMIN' EAGLE RACE CLUTCH KIT



C. SCREAMIN' EAGLE PERFORMANCE CLUTCH FRICTION DISC KIT



D. SCREAMIN' EAGLE BIG TWIN COMPENSATOR



E. SCREAMIN' EAGLE PERFORMANCE SLIPPER CLUTCH FOR VRSC MODELS

Notice: The prices appearing in this catalog are the manufacturer's suggested retail prices. Actual retail prices may vary.

# SCREAMIN' EAGLE® 497

Transmission

F



The Screamin' Eagle 6 Speed Transmission has been tested and validated using the same rigorous procedures that Original Equipment transmissions are subjected to, and is backed by a 12 or 24 month (depending on model year), unlimited mileage warranty when installed at the time of a new bike purchase.



## F. SCREAMIN' EAGLE® 6-SPEED TRANSMISSION AND GEAR SET



Designed from the ground up, the Screamin' Eagle transmission incorporates many of the best Original Equipment features, like late-style shifting mechanism and a newly designed "shift ring" system to make this the smoothest shifting Harley-Davidson® transmission available. The "shift ring" system is similar to the system used in the VRSC transmission, and it slides on the shafts to mate into the gears. This eliminates sliding heavy gears to accomplish the shift, and results in smooth, precise and light effort shifting. Sixth gear is a true overdrive, at a .89:1 ratio, and the first five gears mimic today's proven 5-speed ratios. The overdrive feature allows you to run a lower engine RPM in sixth gear, at any given road speed. Lower RPM can result in lower vibration, longer engine life and smoother cruising. The Screamin' Eagle 6-Speed Transmission is available as a complete transmission, or as a replacement gear set, and can be matched with hydraulic or cable-operated clutch controls.

Screamin' Eagle 6-Speed Transmissions feature forged chrome "trap door", forged shifter forks and forged and precisely ground gears. No speedometer or exhaust mount modifications are required. Complete transmissions are ready to install into the chassis, and the 6-Speed Gear Set Kits are designed to replace the stock gear set without removing the transmission. Gear Set Kits require slight modification (template included) to the Original Equipment transmission case, and include all necessary installation hardware.

### COMPLETE TRANSMISSION

Fits '01-'05 Dyna® models. Requires separate purchase of appropriate Side Cover Release Kit.

<b>33034-03A</b>	Silver and Chrome.	<b>\$2,799.95</b>
<b>33040-03A</b>	Black and Chrome.	<b>\$2,799.95</b>

Fits '00-'06 Softail® models. Requires separate purchase of appropriate Side Cover Release Kit.

<b>33044-03A</b>	Silver and Chrome.	<b>\$2,799.95</b>
<b>33045-03A</b>	Black and Chrome.	<b>\$2,799.95</b>

Fits '90-'99 Softail models. Includes Cable Side Cover Release Kit.

<b>33105-03</b>	Silver and Chrome.	<b>\$2,799.95</b>
<b>33104-03</b>	Black and Chrome.	<b>\$2,799.95</b>

Fits '02-'06 Touring models. Requires separate purchase of appropriate Side Cover Release Kit.

<b>33136-04</b>	Silver and Chrome.	<b>\$2,799.95</b>
<b>33137-04</b>	Black and Chrome.	<b>\$2,799.95</b>

### GEAR SET

<b>33100-03A</b>		<b>\$2,099.95</b>
------------------	--	-------------------

Fits '90-'99 Softail models and '91-'94 and '96-'00 Dyna models. Requires separate purchase of appropriate Side Cover Release Kit.

<b>33101-03A</b>		<b>\$2,099.95</b>
------------------	--	-------------------

Fits '90-'00 Touring models. Requires separate purchase of appropriate Side Cover Release Kit.

<b>33102-03A</b>		<b>\$2,099.95</b>
------------------	--	-------------------

Fits '00-'06 Softail and '01-later Touring models. Requires separate purchase of appropriate Side Cover Release Kit.

<b>33103-03A</b>		<b>\$2,099.95</b>
------------------	--	-------------------

Fits '01-'05 Dyna models. Requires separate purchase of appropriate Side Cover Release Kit.

### Shown with:

#### SCREAMIN' EAGLE® TRANSMISSION SIDE COVER FOR 6-SPEED TRANSMISSION



Includes unique side cover and clutch components required for installing a Screamin' Eagle 6-Speed Transmission.

<b>38753-04A</b>	Hydraulic Clutch.	<b>\$299.95</b>
------------------	-------------------	-----------------

Fits '99-'06 Touring, '99-'05 Dyna®, and '00-'06 Softail® models equipped with Screamin' Eagle 6-Speed Transmission and Hydraulic Clutch. NOTE: If installing a Hydraulic Clutch on a previously installed Screamin' Eagle 6-Speed, separate purchase of the Clutch Release Cover Gasket P/N 35148-03 is required.

<b>38752-04</b>	Cable Clutch.	<b>\$199.95</b>
-----------------	---------------	-----------------

Fits '90-'06 Touring, '91-'05 Dyna, and '90-'06 Softail models equipped with Screamin' Eagle 6-Speed Transmission and cable-actuated clutch.

SCREAMIN' EAGLE

## F. SCREAMIN' EAGLE 6-SPEED TRANSMISSION AND GEAR SET (SHOWN WITH SCREAMIN' EAGLE TRANSMISSION SIDE COVER FOR 6-SPEED TRANSMISSION)

Notice: The prices appearing in this catalog are the manufacturer's suggested retail prices. Actual retail prices may vary.



# 498 SCREAMIN' EAGLE®

Ignition

## A. SCREAMIN' EAGLE® ST PERFORMANCE SPARK PLUG



Screamin' Eagle ST Spark Plugs feature double platinum coating for superior erosion resistance and extended life. The "V" trimmed ground electrode reduces shrouding of the flame front to promote flame propagation, and the fine wire center electrode enhances start ups and ignitability. Screamin' Eagle ST Plugs feature Ribbed Core Technology (RCT) that provides resistance to fouling, and are designed with Original Equipment-style noise suppression to prevent electrical interference with radios and CB communication equipment. Works great in racing applications where rich air/fuel conditions are required. Unique style with Screamin' Eagle logo.

### High Compression Applications

These plugs are designed for high performance applications involving modifications in high flow air cleaners, cam shafts, exhaust, performance heads, ignition components, higher compression ratios above Original Equipment configurations or engines specific for racing applications.

**32186-10** \$15.95

Fits '99-later Twin Cam-equipped models, '86-later XL and XR models, and 1340 Evolution models equipped with Screamin' Eagle Performance Cylinder Heads.

**32188-10** \$15.95

Fits '84-'99 Evolution 1340-equipped models, '75-'81 Shovelhead 74 and 80ci, and '83-'84 XR1000 models.

### Stock Compression Applications

Designed for modified engines including performance carburetors, high-flow air cleaners, cam shafts, exhaust systems and ignition systems in conjunction with stock compression ratios.

**32187-10** Fits '72-'85 XL1000 (except XR1000). \$15.95

**32189-10** \$15.95

Fits '84-'99 Evolution® 1340-equipped models, '75-'81 Shovelhead 74 and 80ci models.

**32192-10** \$15.95

Fits '99-later Twin Cam-equipped models, and '86-later Evolution Sportster® 883, 1100 and 1200 models.

*Notice: The prices appearing in this catalog are the manufacturer's suggested retail prices. Actual retail prices may vary.*

A

NEW



A. SCREAMIN' EAGLE ST PERFORMANCE SPARK PLUG

**Terminal construction** ensures solid watertight connection with standard or performance spark plug wires.

**Plated jacket** helps prevent corrosion in harsh weather and temperature conditions.

**"V-trimmed" ground electrode** reduces shrouding to promote flame propagation.

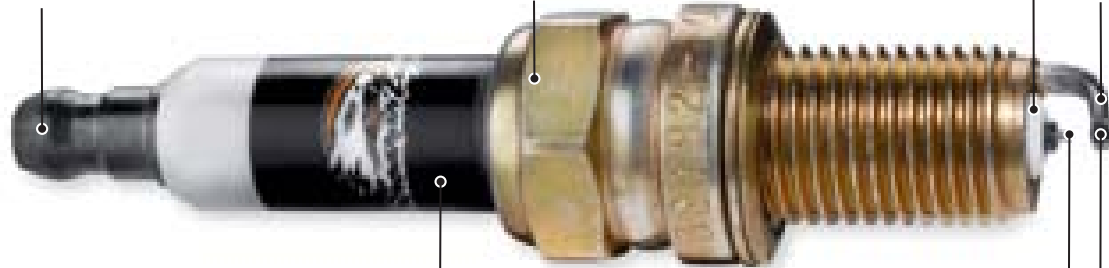

**Built-in suppressor/resistor** reduces radio noise and interference.

**Fine Wire Center Electrode** promotes ignitability and enhances start up.

**Platinum pads** on both electrodes reduce gap erosion for longer plug life.

**RCT (Ribbed Core Technology)** provides improved resistance to plug fouling. The rib's proximity promotes spark discharge to the shell on plugs that are starting to foul, allowing the air/fuel charge in the cylinder to ignite and clear the plug.

# SCREAMIN' EAGLE® 499

Ignition

**B**



**B. SCREAMIN' EAGLE 10MM PHAT SPARK PLUG WIRES**

## **B. SCREAMIN' EAGLE® 10MM PHAT SPARK PLUG WIRES**



Fat 10mm plug wires add dimension and style to your ride. Screamin' Eagle boot design and suppression core wires ensure solid connection and maximum voltage transfer between coil and plugs. "Screamin' Eagle" logo printed along wire to add style.

Multi-Fit.

<b>32095-98A</b>	Black.	<b>\$19.95</b>
<b>31987-85B</b>	Yellow.	<b>\$19.95</b>

Fits '09-later Touring models.

<b>32303-08</b>	Black.	<b>\$19.95</b>
<b>32318-08</b>	Red.	<b>\$19.95</b>
<b>32325-08</b>	Orange.	<b>\$19.95</b>

Fits '99-'08 Touring models.

<b>31932-99B</b>	Black.	<b>\$19.95</b>
<b>31939-99B</b>	Red.	<b>\$19.95</b>
<b>31946-99B</b>	Orange.	<b>\$19.95</b>

Fits '99-'09 Dyna® models.

<b>31930-99B</b>	Black.	<b>\$19.95</b>
<b>31937-99B</b>	Red.	<b>\$19.95</b>
<b>31944-99B</b>	Orange.	<b>\$19.95</b>

Fits '00-later Softail® models (except FXCW/FXCWC).

<b>31907-08</b>	Black.	<b>\$19.95</b>
<b>32359-00B</b>	Red.	<b>\$19.95</b>
<b>32360-00B</b>	Orange.	<b>\$19.95</b>

Fits '08-later FXCW and FXCWC models.

<b>31965-08</b>	Black.	<b>\$19.95</b>
<b>31967-08</b>	Red.	<b>\$19.95</b>

Fits '91-'98 Dyna, '85-'99 Softail and '80-'84 Touring models.

<b>32093-98A</b>	Black.	<b>\$19.95</b>
<b>31964-89B</b>	Orange.	<b>\$19.95</b>

Fits '07-later XL models.

<b>31901-08</b>	Black.	<b>\$19.95</b>
<b>31902-08</b>	Orange.	<b>\$19.95</b>

Fits '04-'06 XL models.

<b>31958-04A</b>	Black.	<b>\$19.95</b>
<b>31956-04A</b>	Orange.	<b>\$19.95</b>

Fits '86-'03 XL models.

<b>32092-98A</b>	Black.	<b>\$19.95</b>
<b>31963-89A</b>	Orange.	<b>\$19.95</b>

SCREAMIN' EAGLE

## **C. SCREAMIN' EAGLE PERFORMANCE COILS – EVOLUTION® ENGINES**



These coils provide over 40,000 volts to powerfully spark your Evolution motor. Quick rise time for high RPM and high compression performance applications.

Fits all '84-'99 carbureted Evolution-equipped and '86-'03 XL models with electronic ignitions (except '98-later XL1200S).

<b>31653-97</b>	Black.	<b>\$54.95</b>
-----------------	--------	----------------

## **D. SCREAMIN' EAGLE STREET LEGAL IGNITION SYSTEMS – TWIN CAM**



~~This module is 50-state street legal, and is programmed to allow the engine to turn 5000 RPM. Designed for use on engines with stock compression ratio.~~

<del><b>31765-04A</b></del>	<del>OBSOLETE</del>	<del><b>\$119.95</b></del>
-----------------------------	---------------------	----------------------------

~~Fits carbureted '04-'06 Touring models.~~

**C**



**C. SCREAMIN' EAGLE PERFORMANCE COILS – EVOLUTION ENGINES**

**D**



**D. SCREAMIN' EAGLE STREET LEGAL IGNITION SYSTEM – TWIN CAM**

Notice: The prices appearing in this catalog are the manufacturer's suggested retail prices. Actual retail prices may vary.

# 500 SCREAMIN' EAGLE®

Decorative Accessories

## A. SCREAMIN' EAGLE® ACCESSORY COLLECTION

Add style to your motorcycle with these Screamin' Eagle accessories, and proclaim you're serious about performance.

### 1. Oval Air Cleaner Insert

Fits '66-'03 XL models.

<b>29382-97A</b>	Black on Silver.	<b>\$7.95</b>
<b>29383-97A</b>	Silver on Black.	<b>\$7.95</b>

### 2. Timer Cover

Fits models with horizontal holes.

<b>32565-97A</b>	Silver on Black.	<b>\$5.95</b>
<b>32566-97A</b>	Black on Silver.	<b>\$5.95</b>

### 3. Timer Cover

Fits '99-later Twin Cam-equipped models.

<b>32744-99</b>	Black on Silver.	<b>\$7.95</b>
<b>32743-99</b>	Silver on Black.	<b>\$7.95</b>

### 4. Air Cleaner Insert

Fits '84-later Evolution® 1340-equipped models.

<b>29619-99</b>	Silver on Black.	<b>\$7.95</b>
<b>29622-99</b>	Black on Silver.	<b>\$7.95</b>

### 5. Air Cleaner Insert

Fits '99-'06 Twin Cam-equipped models.

<b>29620-99</b>	Black on Silver.	<b>\$7.95</b>
<b>29567-99</b>	Silver on Black.	<b>\$7.95</b>

## B. SCREAMIN' EAGLE® AIR CLEANER TRIM RING

**29503-07** Black & Orange. **\$7.95**

Fits '07-later Touring and Softail® models (except FLSTSB), and '07 Dyna® models equipped with Original Equipment air cleaner cover.

## C. SCREAMIN' EAGLE MEDALLION

This easy-to-install medallion features the race-bred "Screamin' Eagle" logo. The self-adhesive medallion can be used on sissy bar uprights, battery covers or any flat surface.

**92209-05** **\$21.95**

Fits Medallion Plate-style Sissy Bar Uprights and other flat surfaces.



A. SCREAMIN' EAGLE ACCESSORY COLLECTION



B. SCREAMIN' EAGLE AIR CLEANER TRIM RING



C. SCREAMIN' EAGLE MEDALLION

Notice: The prices appearing in this catalog are the manufacturer's suggested retail prices. Actual retail prices may vary.

# SCREAMIN' EAGLE® 501

Specialty Tools



D. SCREAMIN' EAGLE CASE BORING TOOL



E. SCREAMIN' EAGLE TIMKEN BEARING TOOL



F. SCREAMIN' EAGLE AUTOMATIC COMPRESSION RELEASE TOOL



G. SCREAMIN' EAGLE MECHANICAL COMPRESSION RELEASE MACHINING FIXTURE



H. SCREAMIN' EAGLE AUTOMATIC COMPRESSION RELEASE REMOVAL TOOL



I. SCREAMIN' EAGLE OXYGEN SENSOR SOCKET TOOL

## D. SCREAMIN' EAGLE® CASE BORING TOOL

The Screamin' Eagle Case Boring Tool takes the guesswork out of boring Twin Cam engine cases to accept oversize cylinders. Designed to be used with a heavy-duty 15" drill press or milling machine, the fixture holds and aligns the cases for accurate machining. Ideal for installing a Twin Cam 110 cubic inch Stage Kit or a race-use "bigger bore" 113 cubic inch stroker cylinders.

**94419-06** **\$1,398.95**  
For use on '99-later Twin Cam engines.

## E. SCREAMIN' EAGLE TIMKEN® BEARING TOOL

Timken tool allows you to convert 2003-later Twin Cam models with a factory-installed output shaft roller bearing to a Timken tapered bearing. Tool allows technician to press in a bearing sleeve without having to do a precision crankcase boring operation. Sleeve presses in and is retained with screws. Timken bearing races are then pressed into the sleeve. Timken Bearing Sleeve P/N 34822-08 is sold separately.

**34823-08** **\$749.95**  
For use on '03-later Twin Cam-equipped models.

## F. SCREAMIN' EAGLE® AUTOMATIC COMPRESSION RELEASE TOOL

This kit provides all the fixtures and tools necessary for a machinist to install Automatic Compression Release (ACR) valves onto stock or Screamin' Eagle Performance cylinder heads. Complete installation requires separate purchase of Automatic Compression Release Kit P/N 28861-07A and model-specific Wiring Harness P/N 70623-06 or 70623-08.

**94648-08** **\$949.95**  
For machining of Original Equipment cylinder heads or Screamin' Eagle Performance Heads P/N 16952-08, 16953-08, 16952-99C and 16953-99C on '99-later Twin Cam-equipped models.

## G. SCREAMIN' EAGLE MECHANICAL COMPRESSION RELEASE MACHINING FIXTURE

Simplify the addition of mechanical compression releases to your stock Twin Cam cylinder heads. The fixture allows precision accuracy for the drilling, spot facing, and tapping necessary to install Compression Release Kit P/N 32076-04 (sold separately). Fixture accommodates the machining of the front and rear heads, even when the valves are already in place, and when the process is complete, the Compression Release Kit P/N 32076-04 threads in place.

**94638-08** **\$249.95**  
For use on '99-later Twin Cam models.

## H. SCREAMIN' EAGLE AUTOMATIC COMPRESSION RELEASE REMOVAL TOOL

Socket designed for removal and installation of Harley-Davidson® Automatic Compression Release solenoid.

**94048-09** **\$39.95**  
For all Harley-Davidson models equipped with Screamin' Eagle Automatic Compression Release.

## I. SCREAMIN' EAGLE OXYGEN SENSOR SOCKET TOOL

This cut-away socket is designed to clear the wire lead and simplify the removal or installation of the oxygen sensor on all closed loop fuel injected models. Manufactured to withstand up to 125 ft-lb of torque, the socket has a 3/8" drive receiver or can be used with a 7/8" wrench.

**94136-09** **\$35.95**  
For use on '06-later EFI models with O2 sensors.

SCREAMIN' EAGLE

Notice: The prices appearing in this catalog are the manufacturer's suggested retail prices. Actual retail prices may vary.



# 502 SCREAMIN' EAGLE®

Specialty Tools

## A. SCREAMIN' EAGLE® TWIN CAM CHAIN TENSIONER TOOL

A must for any camshaft work, this tool lets you easily assemble and disassemble cams by unloading the pressure on the primary and secondary chain tensioners on early Twin Cam models.

**94075-09** **\$39.95**

For use on '99-'05 Dyna®, '00-'06 Softail® and '99-'06 Touring models.

## B. SCREAMIN' EAGLE PRIMARY DRIVE LOCKING TOOL

This tool is designed to keep the primary drive system from rotating during the installation and removal of the compensator sprocket nut or the clutch hub nut. The tool is easily inserted into the primary drive system and wedges in place to restrict movement without damaging the sprocket teeth.

**94102-09** **\$34.95**

For use on '07-later Touring models.

## C. SCREAMIN' EAGLE MAINSHAFT SPROCKET AND PULLEY LOCKNUT REMOVAL AND INSTALLATION TOOL

This extended-length socket is designed to fit over the long transmission shaft simplifying the removal and installation of the large transmission pulley locknuts. Manufactured from hardened tool steel, the socket includes a stabilizer spacer that keeps the threaded shaft end from hitting the socket during removal and installation.

**94137-09** **\$149.95**

For use on '84-later Evolution® 1340-equipped models, and '99-'05 Dyna, '00-'06 Softail and '99-'06 Touring models.

**94141-10** **\$149.95**

For use on '06-later Dyna and '07-later Softail and Touring models.

## D. SCREAMIN' EAGLE® CAM LOCKING TOOL

Tool allows a technician to effectively lock the camshaft and crankshaft sprockets to properly remove, replace, and torque the sprocket bolts. Tool is made from non-marring Delrin® to protect the crank and cam sprocket teeth and surface finishes.

**94076-09** Roller Chain. **\$34.95**

For use on '06-later Dyna®, '07-later Softail® and '07-later Touring models.

**94077-09** Silent Chain. **\$34.95**

For use on '99-'05 Dyna, '00-'06 Softail and '99-'06 Touring models.



A. SCREAMIN' EAGLE TWIN CAM CHAIN TENSIONER TOOL



A. SCREAMIN' EAGLE TWIN CAM CHAIN TENSIONER TOOL



B. SCREAMIN' EAGLE PRIMARY DRIVE LOCKING TOOL

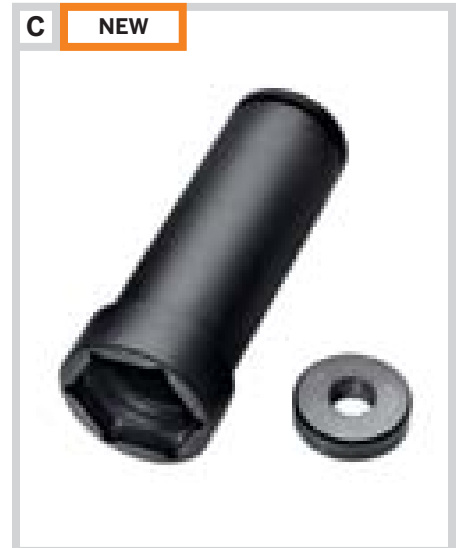

C. SCREAMIN' EAGLE MAINSHAFT SPROCKET AND PULLEY LOCKNUT REMOVAL AND INSTALLATION TOOL



D. SCREAMIN' EAGLE CAM LOCKING TOOL – ROLLER CHAIN



D. SCREAMIN' EAGLE CAM LOCKING TOOL – SILENT CHAIN

Notice: The prices appearing in this catalog are the manufacturer's suggested retail prices. Actual retail prices may vary.

# SCREAMIN' EAGLE® 503

Specialty Tools



**E. SCREAMIN' EAGLE CAMSHAFT REMOVAL AND INSTALLATION TOOL**



**E. SCREAMIN' EAGLE CAMSHAFT REMOVAL AND INSTALLATION TOOL**



**F. SCREAMIN' EAGLE INNER CAM BEARING REMOVAL TOOL**

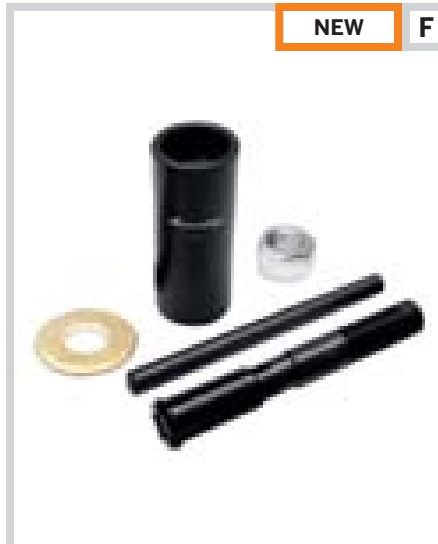

**F. SCREAMIN' EAGLE INNER CAM BEARING REMOVAL TOOL**



**G. SCREAMIN' EAGLE INNER CAM BEARING INSTALLATION TOOL**



**H. SCREAMIN' EAGLE MAINSHAFT BEARING RACE REMOVAL AND INSTALLATION TOOL**

## **E. SCREAMIN' EAGLE® CAMSHAFT REMOVAL AND INSTALLATION TOOL**

This multi-function tool is designed to remove and replace the front and rear camshafts and the ball bearings of a Twin Cam 88®-based engine. It precisely aligns the camshaft to ensure smooth press-in and press-out of the support plate.

**94085-09** **\$127.95**

For use on '99-'05 Dyna®, '00-'06 Softail® and '99-'06 Touring models.

## **F. SCREAMIN' EAGLE® INNER CAM BEARING REMOVAL TOOL**

This precision tool simplifies the removal of the inner cam bearing, and reduces the risk of damaging the crankcase. Tool is also designed to keep the pin rollers from accidentally falling into the crankcase.

**94078-09** **\$120.95**

For use on '99-'05 Dyna®, '00-'06 Softail® and '99-'06 Touring models.

**94144-09** **\$120.95**

For use on '06-later Dyna and '07-later Softail and Touring models.

## **G. SCREAMIN' EAGLE INNER CAM BEARING INSTALLATION TOOL**

This precision tool is designed to ease the installation of the inner cam bearing into the bore. Manufactured from hardened tool steel, this precision tool perfectly positions the bearings and prevents the pin bearings from falling into the engine case.

**94107-09** **\$179.95**

For use on '99-later Twin Cam engines featuring both early- and late-model inner cam bearing designs.

## **H. SCREAMIN' EAGLE MAINSHAFT BEARING RACE REMOVAL AND INSTALLATION TOOL**

This tool is designed to easily remove and install the bearing race on the transmission mainshaft. Manufactured from hardened tool steel, the tool operates with standard wrenches.

**94129-09** **\$195.95**

For use on '84-later Evolution® 1340 and Twin Cam-equipped models with five speed transmissions.

# 504 SCREAMIN' EAGLE®

Specialty Tools

## A. SCREAMIN' EAGLE® ROCKER BOX BOLT RATCHETING WRENCH

This high-quality wrench simplifies working on the rocker box while the engine is mounted in the motorcycle's frame. This tool features a low-profile design to allow access to the tight spaces between the frame and the engine. The wrench has a long handle for increased reach, a replaceable bit and a reversible ratcheting action so the socket head cap screw can be ratcheted in or out. The comfortable soft vinyl grip with Screamin' Eagle logo protects the engine from scratches.

**94057-09** **\$34.95**

For use on all Harley-Davidson® Big Twin rocker box covers.



**A. SCREAMIN' EAGLE ROCKER BOX BOLT RATCHETING WRENCH**



**A. SCREAMIN' EAGLE ROCKER BOX BOLT RATCHETING WRENCH**

## B. SCREAMIN' EAGLE LOWER ROCKER BOX WRENCH

This quality long-handled wrench is designed to simplify installation and removal of the lower rocker box on Twin Cam engines. The special 7/16" socket is shaped to reach these confined areas. The comfortable soft vinyl grip with Screamin' Eagle logo protects the engine from scratches.

**94074-09** **\$25.95**

For use on Twin Cam engines.



**B. SCREAMIN' EAGLE LOWER ROCKER BOX WRENCH**



**B. SCREAMIN' EAGLE LOWER ROCKER BOX WRENCH**

## C. SCREAMIN' EAGLE INTAKE MANIFOLD WRENCH

This reversible ratcheting box wrench simplifies and speeds up the installation and removal of the intake manifold socket head cap screws used on Big Twin® engines. The comfortable soft vinyl grip with Screamin' Eagle logo protects the engine from scratches.

**94063-09** **\$34.95**

For use on all Big Twin engines.



**C. SCREAMIN' EAGLE INTAKE MANIFOLD WRENCH**



**C. SCREAMIN' EAGLE INTAKE MANIFOLD WRENCH**

## D. SCREAMIN' EAGLE FLYWHEEL SHAFT RATCHET WRENCH

This high-quality ratcheting tool allows technician to manually rotate the flywheel of the engine to check cam timing, and to inspect valve-to-valve, piston-to-valve and piston-to-piston clearances. Designed to easily slip over the output crankshaft spline, the wrench features a simple-to-use finger-operated lever to reverse the ratcheting direction.

**94038-09** 24 Tooth Spline. **\$54.95**

For use on '06-later Dyna® and '07-later Touring and Softail® models.

**94088-09** Sportster Spline. **\$39.95**

For use on '72-later XL and XR models.

**94089-09** 10 Tooth Spline. **\$39.95**

For use on '72-'06 Big Twin engines (except '06 Dyna models).



**D. SCREAMIN' EAGLE FLYWHEEL SHAFT RATCHET WRENCH**



**D. SCREAMIN' EAGLE FLYWHEEL SHAFT RATCHET WRENCH**

Notice: The prices appearing in this catalog are the manufacturer's suggested retail prices. Actual retail prices may vary.

# SCREAMIN' EAGLE® 505

Specialty Tools



NEW

E

**E. SCREAMIN' EAGLE PUSH ROD TUBE INSTALLATION AND REMOVAL TOOL**



NEW

E

**E. SCREAMIN' EAGLE PUSH ROD TUBE INSTALLATION AND REMOVAL TOOL**

**E. SCREAMIN' EAGLE PUSH ROD TUBE INSTALLATION AND REMOVAL TOOL**

This handy tool simplifies the removal and installation of the retaining clip on Harley-Davidson® collapsible push rod tubes. Convenient design reduces the risk of scratched engine parts and hands, and the quality composite handles provide a sure and solid grip.

**94086-09** **\$39.95**  
For use on Harley-Davidson collapsible push rod tubes.

**F. SCREAMIN' EAGLE CHROME PROTECTIVE SOCKETS – BLACK FINISH**

Unique internal composite material protects the chrome finish on fasteners when these sockets are used. Mirror black finish, with laser etched SE logo, torque limit and size on each socket.

For use on all Harley-Davidson motorcycles.

**94670-08** **\$159.95**  
(9) 3/8" Drive Sockets 3/8"-15/16", SAE Standard.

**94666-08** **\$149.95**  
(8) 3/8" Drive Sockets 8mm-15mm. Metric.

**G. INDUCTION ALIGNMENT BRACKET KIT**

The Induction Alignment Bracket Kit provides exact alignment and easy installation of engine intake manifolds, preventing intake air leaks.

**40054-01** **\$19.95**  
For use on Twin Cam and Evolution® 1340 engines equipped with CV Carburetors or Electronic Fuel Injection.

**H. SCREAMIN' EAGLE ASSEMBLY LUBE**

Screamin' Eagle Assembly Lube provides superior protection during installation or servicing of internal engine components. Formulated with a high tackifier, this lubricant clings to parts and provides excellent start-up and break-in protection. It provides excellent corrosion resistance, and it won't drip off like common oil when you set coated parts aside to work on the rest of the engine. That's why we use it on all of our test engines. Don't start your re-built or serviced engine without it. Recommended applications: cams, gears, crankpins, piston wrist pins, oil pumps, valve guides, rocker arm and push rod tips and roller tappet wheels.

**94971-09** Universal. **\$9.95**



NEW

F

**F. SCREAMIN' EAGLE CHROME PROTECTIVE SOCKETS – BLACK FINISH**

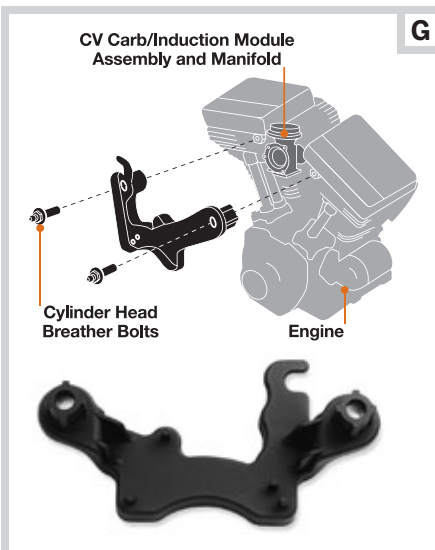

G

**G. INDUCTION ALIGNMENT BRACKET KIT**



NEW

H

**H. SCREAMIN' EAGLE ASSEMBLY LUBE**

SCREAMIN' EAGLE

*Notice: The prices appearing in this catalog are the manufacturer's suggested retail prices. Actual retail prices may vary.*



# ENGINE REMANUFACTURING

*To get your engine firing like new, we can remanufacture your high-mileage motor to original specifications. Select a Stage I Big Bore upgrade and take your pick of chrome, polished or powder-coated factory finishes to give your engine a new lease on life. When originally removed and installed by an authorized Harley-Davidson® dealer, your remanufactured engine will carry a 12-month Unlimited Mileage Limited Warranty.*

*For more information, visit: [www.harley-davidson.com/reman](http://www.harley-davidson.com/reman)*

## HOW IT'S DONE STEP BY STEP

When the miles start to add up, the Harley-Davidson® Engine Remanufacturing Program can put the rumble back into your powerplant simply, quickly and affordably. The program is available for the Evolution® 1340, and many Twin Cam engines. Contact your Harley-Davidson® dealer for more information.

### GETTING STARTED

*Your engine's journey begins at your Harley-Davidson dealership. The engine is removed from your bike and shipped via Con-way® in a specially-designed container to our state-of-the-art Powertrain Operation, Capitol Drive facility in Wauwatosa, WI.*



### STEP 1: DISASSEMBLY

*Upon its arrival, your engine is completely taken apart and inspected by the remanufacturing team. Engine components that can be cleaned and remanufactured to original specifications are saved, while those not worth saving are discarded.*



### STEP 2: CLEANING AND POWDER COATING

*All reusable parts are cleaned, and paint is thermally removed from the cylinders and beads. Small components are cleaned through a baking soda blasting process. After inspection, parts are powder coated in our state-of-the-art production paint facility.*



### STEP 3: MACHINING

*Once powder coated, these parts are machined, bored and honed to exact tolerances. Then, they proceed through rigid specification checks. Only the components that meet our strict standards ever make it past this point.*



### STEP 4: REASSEMBLY

*During reassembly, crankcases are set, bearings are pressed and components are meticulously reassembled. All chromed and polished components are replaced with new parts, and your engine is upgraded to meet the latest specifications, while retaining its stock configuration.\**

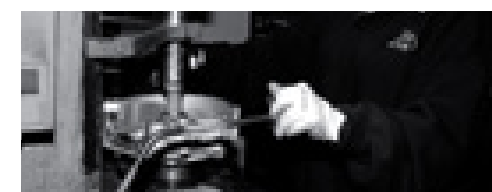

### STEP 5: TESTING AND FINISHING

*After reassembly, your engine is run through a battery of tests to ensure it performs to Harley-Davidson standards. Upon passing these tests, your engine is awarded a one-year, unlimited mileage factory warranty. After cleaning and polishing, your engine is ready to come home.*



### BACK IN THE SADDLE

*Approximately two weeks after its journey began, your V-Twin® is returned to your dealer for installation with a new lease on life and its original Vehicle Identification Number (VIN).*



\* For legal and warranty purposes, all engines will receive stock camshafts. If you have installed high-performance cams, they will not be reinstalled or returned.

# 508 ENGINES

Revolution® & Evolution® Engines

## A. NEW ERA REVOLUTION® ENGINE PROGRAM – VRSC™

With the launch of the V-Rod® motorcycle in 2002, the world was introduced to a revolutionary new powertrain, and now, the Revolution engine is available from your Harley-Davidson® Dealer. Available in black and black 1250cc configuration as featured as Original Equipment in the 2009 VRSCDX models.

**19569-10K** Black and Black 1250cc. **\$6,995.00**  
Fits '10 VRSC models (except VRSCF). Does not include intake system or mini wire harness.

## B. SMART START EVOLUTION ENGINE PROGRAM

Since the first single cylinder built in 1903, engines have been the heart and soul of Harley-Davidson history. Each motor has made its unique contribution, and the V2 Evolution® engine is no exception. With the Smart Start Engine Program, buying a new Evolution engine has never been easier. When replacing your Evolution motor, Smart Start offers brand new, factory-tested engines at an unbeatable price. Choose the standard Silver and Polished Evolution, the classic Black and Chrome or the Silver and Chrome finish. Either way, you won't just be making a new start, you'll be making a smart start. Carburetor, manifold, and timer cover not included.

### 1340CC EVOLUTION ENGINE

**16161-99** Silver and Polished. **\$3,295.00**  
Fits all '99 Softail® models.

**16160-99** Black and Chrome. **\$3,995.00**  
Fits all '99 Softail models.

**16177-99** Silver and Chrome. **\$3,495.00**  
Fits all '99 Softail models (not shown).

A

NEW



A. NEW ERA REVOLUTION ENGINE PROGRAM – VRSC BLACK AND BLACK

B



NOTE: Replacement engines must be re-fitted with emission control devices and systems, appropriate for the vehicle model and model year in order to ensure emissions compliance. Failure to do so constitutes tampering under US EPA guidelines and can lead to substantial fines and penalties.

Legal for use on public roads only when installed in the specified models. Not legal for use on public roads when installed in models other than the ones specified and not eligible for the P&A 24 month warranty when installed in models other than the ones specified. Please see the Parts and Accessories warranty statement and your dealer for more information.

B. SILVER AND POLISHED 1340CC EVOLUTION ENGINE (BLACK AND CHROME INSET)

Notice: The prices appearing in this catalog are the manufacturer's suggested retail prices. Actual retail prices may vary.

**NEW****C**

# ENGINES 509

*Softail® Twin Cam Engines***C. THE NEW ERA TWIN CAM ENGINE PROGRAM – SOFTAIL TWIN CAM 110B****C. THE NEW ERA TWIN CAM ENGINE PROGRAM – SOFTAIL®**

First introduced on the '07 Custom Vehicle Operations™ Springer® Softail model, this 110 cubic inch big bore stroker motor is the largest complete engine available from the Motor Company. The 4" big bore cylinders and pistons, SE-255 camshafts, and Screamin' Eagle® cylinder heads with automatic compression release combine with the factory stroker flywheel to deliver solid torque and horsepower where you need it. And the internal balance shaft system keeps vibration under control. Matching Cruise Drive® Six Speed Transmission is available for Softail applications.

**1800CC TWIN CAM 110B™****19293-10** Black and Chrome. **\$6,895.00**

Fits '10 FLSTSE models. Does not include intake system, timer cover, stator, rotor, or compensating sprocket assembly.

**D. THE NEW ERA TWIN CAM ENGINE PROGRAM – SOFTAIL®**

The balanced Twin Cam has brought a whole new ride to the Softail® family – and now that ride is available to you. With the New Era Program, you get the most technologically advanced, air-cooled, V-Twin engine for Softail® motorcycles on the planet. When the Custom Vehicle Operations Fat Boy® model was introduced, it established a new benchmark for the term Softail "Factory Custom". The 103 cubic inch "Stroker" Twin Cam "B" engine is available in Silver and Chrome finish to match the CVO Fat Boy model or in Black and Chrome to match your custom direction. The 88B is available in Black and Chrome or Silver and Polished, as are the matching transmissions. With the Twin Cam 88B™ and 103B™ engines, the Softail model really lives up to its reputation. See your local Harley-Davidson® Dealer for details.

**1690CC TWIN CAM 103B™****19293-06C** Black and Chrome. **\$6,895.00**

Fits '06 FLSTFSE2 models. Does not include intake system, timer cover, stator, rotor or compensating sprocket assembly.

**19296-06C** Silver and Chrome. **\$6,895.00**

Fits '06 FLSTFSE2 models. Does not include intake system, timer cover, stator, rotor or compensating sprocket assembly.

**1450CC TWIN CAM 88B™****19259-06C** Black and Chrome. **\$4,945.00**

Fits '06 Softail models (except '06 FLSTFSE2). Does not include intake system, timer cover, stator, rotor or compensating sprocket assembly.

**19258-06C** Silver and Polished. **\$3,945.00**

Fits '06 Softail models (except '06 FLSTFSE2). Does not include intake system, timer cover, stator, rotor or compensating sprocket assembly.

**D. THE NEW ERA TWIN CAM ENGINE PROGRAM – SOFTAIL TWIN CAM 88B**

NOTE: Replacement engines must be re-fitted with emission control devices and systems, appropriate for the vehicle model and model year in order to ensure emissions compliance. Failure to do so constitutes tampering under US EPA guidelines and can lead to substantial fines and penalties.

Legal for use on public roads only when installed in the specified models. Not legal for use on public roads when installed in models other than the ones specified and not eligible for the P&A 24 month warranty when installed in models other than the ones specified. Please see the Parts and Accessories warranty statement and your dealer for more information.

Notice: The prices appearing in this catalog are the manufacturer's suggested retail prices. Actual retail prices may vary.

# 510 ENGINES

Touring Twin Cam Engines

## A. THE NEW ERA TWIN CAM ENGINE PROGRAM – TOURING

**PROGRAM – TOURING**  
First introduced on the '07 Custom Vehicle Operations™ Road King® and Ultra Classic® Electra Glide® models, this 110 cubic inch big bore stroker motor is the largest complete engine available from the Motor Company. The 4" big bore cylinders and pistons, SE-255 camshafts, and Screamin' Eagle® cylinder heads with automatic compression release combine with the factory stroker flywheel to deliver solid torque and horsepower where you need it. Matching Cruise Drive® Six Speed Transmission is available for Touring applications.

### 1800CC TWIN CAM 110A™

**19176-10** Black and Chrome. **\$6,395.00**  
Fits '10 FLHTCUSE5 AND FLHXSE models. Requires installation of Oil Cooler P/N 63068-09 and Cover Kit P/N 63127-09. Does not include intake system, timer cover, stator, rotor, or compensating sprocket assembly.

**Also available:**

### THE NEW ERA TWIN CAM® ENGINE PROGRAM – TOURING

When the Custom Vehicle Operations Electra Glide® model was introduced, it established a new benchmark for the term "Factory Custom". Now, the 103 cubic inch "Stroker" Twin Cam engine is available in Silver and Chrome finish to match the CVO Ultra Classic Electra Glide model or in Black and Chrome to match your custom direction.

### 1690CC TWIN CAM 103A™

**19176-06C** Black and Chrome. **\$6,395.00**  
Fits '06 FLHTCUSE models. Requires installation of Oil Cooler P/N 62994-04 and Cover Kit P/N 62995-04. Does not include intake system, timer cover, stator, rotor or compensating sprocket assembly.

**19264-06C** Silver and Chrome. **\$6,395.00**  
Fits '06 FLHTCUSE models. Requires installation of Oil Cooler P/N 62994-04 and Cover Kit P/N 62995-04. Does not include intake system, timer cover, stator, rotor or compensating sprocket assembly.

## B. THE NEW ERA TWIN CAM ENGINE PROGRAM – DYNA®

When the Twin Cam 88® Engine was introduced for the 1999 model year, it took the motorcycling world by storm and turned the page on a new chapter in Motor Company history. With the New Era Twin Cam 88 Engine Program, you can get your own piece of Harley history by owning the most technologically advanced air-cooled V-Twin engine on the market. The New Era Twin Cam 88 is available in the Dyna configuration in Black and Chrome or Silver and Polished. Carburetor and manifold not included. See your local Harley-Davidson® Dealer for details.

### 1450CC TWIN CAM 88®

**19255-05B** Black and Chrome. **\$4,445.00**  
Fits '05 Dyna models. (Does not include intake system, timer cover, stator, rotor or compensating sprocket assembly.)

**19256-05B** Silver and Polished. **\$3,445.00**  
Fits '05 Dyna models. (Does not include intake system, timer cover, stator, rotor or compensating sprocket assembly.)

NOTE: Replacement engines must be re-fitted with emission control devices and systems, appropriate for the vehicle model and model year in order to ensure emissions compliance. Failure to do so constitutes tampering under US EPA guidelines and can lead to substantial fines and penalties.

Legal for use on public roads only when installed in the specified models. Not legal for use on public roads when installed in models other than the ones specified and not eligible for the P&A 24 month warranty when installed in models other than the ones specified. Please see the Parts and Accessories warranty statement and your dealer for more information.

Notice: The prices appearing in this catalog are the manufacturer's suggested retail prices. Actual retail prices may vary.

A

NEW



A. THE NEW ERA TWIN CAM ENGINE PROGRAM – TOURING TWIN CAM 110A

B



B. THE NEW ERA TWIN CAM ENGINE PROGRAM – DYNA TWIN CAM 88



C



C. SMART START FIVE SPEED SOFTAIL TRANSMISSIONS

**C. SMART START FIVE SPEED SOFTAIL® TRANSMISSIONS**

A natural extension of the Smart Start Evolution Engine Program.

**33006-99** Black and Chrome. **\$1,782.00**  
Fits all '99 Softail® models (except FLSTS).

**33005-99** Silver Painted. **\$1,665.00**  
Fits all '99 Softail models (except FLSTS).

**D. NEW ERA FIVE SPEED SOFTAIL TRANSMISSION**

**33006-06A** Black and Chrome. **\$1,782.00**  
Fits '06 Softail models (except '06 FLSTFSE2).

**33005-06A** Silver Painted. **\$1,665.00**  
Fits '06 Softail models (except '06 FLSTFSE2).

**E. NEW ERA SIX SPEED CRUISE DRIVE TRANSMISSION**

Complements the New Era Twin Cam Engine Program.

**33118-10** Black and Chrome. **\$1,782.00**  
Fits '10 FLHTCUSE5 and FLHXSE models.

**33139-10** Black and Chrome. **\$1,782.00**  
Fits '10 FLSTSE models.

D



D. NEW ERA FIVE SPEED SOFTAIL TRANSMISSION

E



E. NEW ERA SIX SPEED CRUISE DRIVE TRANSMISSION – TOURING SHOWN

NOTE: Replacement engines must be re-fitted with emission control devices and systems, appropriate for the vehicle model and model year in order to ensure emissions compliance. Failure to do so constitutes tampering under US EPA guidelines and can lead to substantial fines and penalties.

Legal for use on public roads only when installed in the specified models. Not legal for use on public roads when installed in models other than the ones specified and not eligible for the P&A 24 month warranty when installed in models other than the ones specified. Please see the Parts and Accessories warranty statement and your dealer for more information.

Notice: The prices appearing in this catalog are the manufacturer's suggested retail prices. Actual retail prices may vary.



# ENGINE TRIM

*The V-Twin is one of the most impactful visual elements of your motorcycle, making it a great opportunity for customization. Pick a direction that reflects your attitude and find the trim options that will help you execute it. Your engine is the heart and soul of your ride, so wear it on your sleeve.*

## CHROME VS. BLACK

### CHROME

*A fresh take on the Dark Custom™ logo, this collection features domed surfaces and high-contrast finish. These die-cast and formed aluminum covers are highly polished for both durability and style.*



### BLACK

*Polished and black anodized for a quality finish, these billet covers are machined, anodized and then remachined to expose the raw aluminum beneath the surface.*



## FOCUS ON THE CENTER

*Developing a “look” for your bike doesn’t have to be difficult. Add a well-chosen air cleaner, some custom hardware and a complementing derby and timer cover collection, and you’ll have a strong style that tells other motorists exactly what you’re about.*

### BLACK & CHROME

You can make a huge custom impact by changing the basic engine finish. Genuine H-D® chrome and wrinkle black covers are designed for precise fit and trouble-free installation.



## DEFINING YOUR BIG TWIN ENGINE’S LOOK

The easiest and most affordable way to customize is by adding decorative covers. With choices ranging from air cleaner covers to headbolt bridges, you can dress every inch of your engine.



## IT'S IN THE DETAILS



### CHROME HARDWARE (RIGHT)

The final step in finishing a bike is the hardware — but not just any “hardware store” parts will do. Harley-Davidson® Chrome Hardware is manufactured to Original Equipment specifications, ensuring the finish, the fitment and quality you expect.

### OIL LEVEL DIPSTICKS (LEFT)

Oil is the lifeblood of your V-Twin engine, so keep an eye on its health. LCD-lighted dipsticks provide push-button access to the oil temperature and oil level information. No more grabbing a rag to pull your hot dipstick, and no more oil drips on your pipes and the garage floor.



# 514 ENGINE TRIM

## Oil Coolers

### PREMIUM OIL COOLER KIT

This oil cooler was designed specifically for Harley-Davidson to out-perform all other coolers in the industry. The cooler features a unique "Turbulator" system that evenly distributes oil across the cooling chambers. The air fins are designed to efficiently dissipate heat. The oil cooler has been designed to simplify installation and enhance performance. The large heat exchanger provides excellent cooling efficiency. The kit features a one-piece adapter plate with integrated thermostat that allows oil lines to connect to the oil filter bracket. Thermostat activates at 185°F (85°C). Kit comes complete with mounting hardware and pre-cut oil lines. Kit includes Chrome Oil Cooler Cover.

#### A. DYNA® MODELS

**26151-07** **\$299.95**  
Fits '06-later Dyna® models (except FXDSE/2, FXDFSE/2 and California models). Does not fit with Front Spoiler Kits or Definitive5™ Filtration System Kits. Fits with all H-D® Engine Guards.

#### B. SOFTAIL® MODELS

**26157-07** **\$299.95**  
Fits '00-later Softail® models. FXCW and FXCWC models require separate purchase of Horn Relocation Kit for Oil Cooler P/N 69015-08. Does not fit with Softail Front Spoiler Kits, or Definitive5 Filtration System Kits. Fits with all H-D Engine Guards.

#### Also available:

#### HORN RELOCATION KIT

Required when installing Oil Cooler Kit P/N 26157-07 on FXCW or FXCWC models.

**69015-08** **\$12.95**  
Fits '08-later FXCW and FXCWC models equipped with Oil Cooler Kit P/N 26157-07.

#### C. TOURING MODELS

**26155-09** **\$299.95**  
Fits '09-later Touring models. Stock on '09-later FLTRSE3, FLHXSE and FLHTCUSE4/5. Does not fit with Definitive5™ Filtration System Kit or models equipped with a sidecar.

**26155-07** **\$299.95**  
Fits '07-'08 Touring models. Stock on '07-'08 FLHTCUSE2/3. Does not fit with Chrome Display Stand P/N 99002-97A, Definitive5 Filtration System Kit or models equipped with a sidecar.

**26082-05B** **\$299.95**  
Fits '99-'06 Touring models. Does not fit with Chrome Display Stand P/N 99002-97A, Definitive5 Filtration System Kit or models equipped with a sidecar.



A. PREMIUM OIL COOLER KIT FOR DYNA MODELS



B. PREMIUM OIL COOLER FOR SOFTAIL MODELS

#### Inside View of Premium Oil Cooler with Turbulators

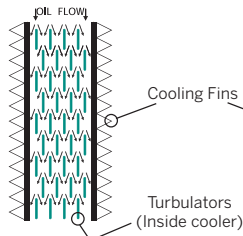

Turbulators disperse and mix oil inside cooler to provide more efficient cooling capabilities. The cooler oil is not allowed to remain along the boundaries of the flow tube as in conventional coolers.

#### Inside View of Conventional Oil Cooler without Turbulators

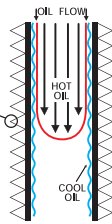

Coolers without the Turbulator system allow oil to flow only in a straight path. Oil does not mix and the cooler oil remains along the outer boundaries, while the hotter oil remains along the center path of flow. Without the mixing effects of the Turbulators, the conventional oil cooler provides less efficient cooling capabilities.



C. PREMIUM OIL COOLER KIT FOR TOURING – '09 SHOWN

Notice: The prices appearing in this catalog are the manufacturer's suggested retail prices. Actual retail prices may vary.



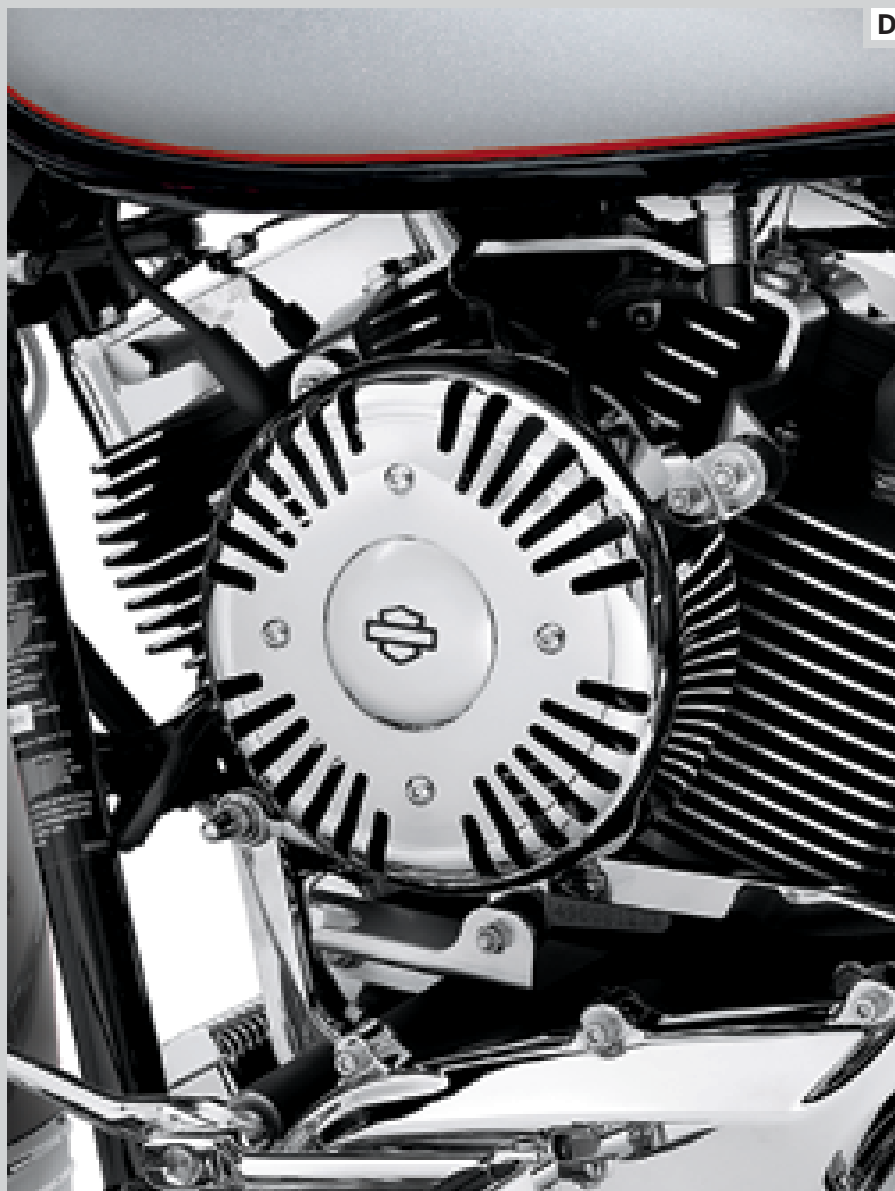

D

## D. CHROME FAN KIT FOR TOURING MODELS

Complete with a Bar & Shield logo decorative cover, this handsome Chrome Fan Kit is great for parade duty, rush hour traffic or anytime you are sitting still on your air-cooled V-Twin. Cover design and strong brackets ensure that this fan will stand the test of time. Lab results show a 20 degree reduction in oil temperature (measured at the oil tank) when using the fan. Kit includes all hardware and wiring for fan installation and horn relocation.

**91196-08** **\$449.95**

Fits '07-later Touring models (except Trike) and models equipped with 110CI Twin Cam Engine.

**91550-00C** **\$379.95**

Fits '97-'06 FLHT models and '97-'06 FLHR models equipped with fuel injected Twin Cam or fuel injected Evolution® 1340 engines only. (Does not fit on carbureted models or models equipped with Headbolt Covers.)

## E. HARLEY-DAVIDSON® GENUINE HIGH PERFORMANCE 1.4KW STARTER

This starter offers both great styling and increased performance, providing 15% greater torque than the stock replacement starter. Engineered and tested by Harley-Davidson from the ground up, this starter offers unparalleled reliability and durability. No special battery or battery cable requirements.

Fits '06-later Dyna® and '07-later Softail® and Touring models.

**31619-06A** Black Finish. **\$424.00**

**31621-06A** Chrome Finish. **\$525.00**

Fits '94-'06 Softail® and Touring, '94-'05 Dyna and '99-'00 FXR models.

**31559-99A** Chrome Finish. **\$525.00**

**31335-03A** Black Finish. **\$424.00**

## F. AUTOMATIC PRIMARY CHAIN TENSION ADJUSTER

Original Equipment on '06-later Dyna and '07 Softail and Touring models, this Automatic Primary Chain Adjuster eliminates the need to manually adjust the primary chain tension at traditional service intervals.

**40063-05A** **\$109.95**

Fits '85-'06 Evolution® 1340 and Twin Cam powertrain. Requires separate purchase of model-specific primary gasket and seals.

D. CHROME FAN KIT FOR TOURING MODELS



E

E. HARLEY-DAVIDSON GENUINE HIGH PERFORMANCE 1.4KW STARTER – CHROME



F

F. AUTOMATIC PRIMARY CHAIN TENSION ADJUSTER

Notice: The prices appearing in this catalog are the manufacturer's suggested retail prices. Actual retail prices may vary.

# 516 ENGINE TRIM

Derby, Point & Inspection Covers

## A. NUMBER ONE SKULL COLLECTION

The sinister Harley-Davidson #1 Skull logo dresses for a night on the town. This complete die-cast aluminum collection has been polished and chrome-plated to a brilliant shine, then finished with a contrasting black-filled Dark Custom Skull logo. The black-filled race track stripe and recessed hardware pockets provide added depth and dimension. Includes chrome-plated mounting hardware. (Available September 2009)

- |  |                   |                |
|--|-------------------|----------------|
| <b>1. 25331-10</b>   | Derby Cover.      | <b>\$64.95</b> |
| Fits '99-later Evolution® 1340 and Twin Cam-equipped models. Installation on '06-later Dyna® and '07-later Touring and Softail® models requires separate purchase of Gasket P/N 25416-99C. |                   |                |
| <b>2. 27956-10</b>   | Air Cleaner Trim. | <b>\$44.95</b> |
| Fits Evolution 1340 and Twin Cam-equipped models with stock air cleaner (except '08-later Dyna and FLSTSB).  |                   |                |
| <b>3. 27958-10</b>   | Air Cleaner Trim. | <b>\$54.95</b> |
| Fits '08-later Dyna® models (except FXDSE2 and FXDFSE) with Original Equipment Air Cleaner Covers.   |                   |                |
| <b>4. 32519-10</b>   | Timer Cover.      | <b>\$25.95</b> |
| Fits '99-later Twin Cam-equipped models.   |                   |                |



A. NUMBER ONE SKULL COLLECTION



A. NUMBER ONE SKULL COLLECTION

Notice: The prices appearing in this catalog are the manufacturer's suggested retail prices. Actual retail prices may vary.



**B. DARK CUSTOM LOGO COLLECTION**

**B. DARK CUSTOM LOGO COLLECTION**

The famous Harley-Davidson #1 logo with a sinister twist. Machined from billet aluminum, these covers feature domed surfaces that are polished and black anodized to a rich satin sheen, and then remachined to exposed the raw aluminum. The resulting high-contrast design complements both polished and painted engine finishes.

**1. 25562-09** Derby Cover **\$129.95**

Fits '99-later Evolution® 1340 and Twin Cam-equipped models. Installation on '06-later Dyna® and '07-later Touring and Softail® models requires separate purchase of Gasket P/N 25416-99C.

**2. 32414-09** Timer Cover. **\$59.95**

Fits '99-later Twin Cam-equipped models.



**B. DARK CUSTOM LOGO COLLECTION**

*Notice: The prices appearing in this catalog are the manufacturer's suggested retail prices. Actual retail prices may vary.*

# 518 ENGINE TRIM

Derby, Point & Inspection Covers

## A. THE BLACK FIN COLLECTION

Finish the sinister black look of your motorcycle with the Black Fin Collection from Harley-Davidson. The raised horizontal lines on these die-cast covers echo the traditional cylinder fin look, and the wrinkle black finish is a perfect match for the blacked-out primary, cam cover and Fined Headbolt Bridge Kit.

**1. 25454-01** Derby Cover. **\$38.95**  
Fits '99-later Evolution® 1340 and Twin Cam-equipped models. Installation on '06-later Dyna and '07-later Touring and Softail models requires separate purchase of Gasket P/N 25416-99C.

**2. 32677-01** Timer Cover. **\$20.95**  
Fits '99-later Twin Cam-equipped models.

**3. 60618-01** Chain Inspection Cover. **\$33.95**  
Fits '80-'05 FXWG, FXDWG and '84-'06 Softail® models.



A. THE BLACK FIN COLLECTION

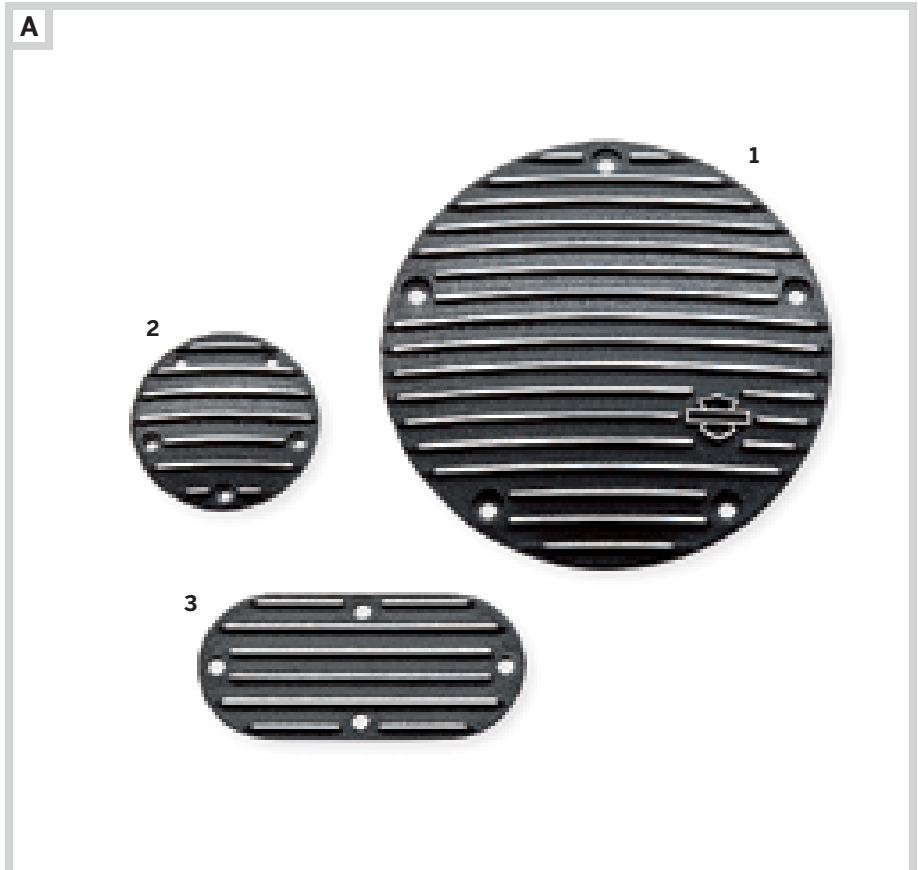

A. THE BLACK FIN COLLECTION

Notice: The prices appearing in this catalog are the manufacturer's suggested retail prices. Actual retail prices may vary.





B. THE WILLIE G. SKULL COLLECTION

**B. THE WILLIE G.® SKULL COLLECTION**

Add a little attitude to your ride. Styled to complement Harley-Davidson® Skull accessory items, the menacing raised skull with black-filled eyes leaps from a field of chrome. The surrounding "Harley-Davidson Motorcycles" script is the perfect finishing touch. This complete collection of engine covers dresses your bike for a true custom look.

**1. 25441-04A** Derby Cover. **\$54.95**

Fits '99-later Evolution® 1340 and Twin Cam-equipped models. Installation on '06-later Dyna® and '07-later Touring and Softail® models requires separate purchase of Gasket P/N 25416-99C. Includes chrome-plated stainless steel mounting hardware.

**2. 32975-04A** Timer Cover. **\$25.95**

Fits '99-later Twin Cam-equipped models. Includes chrome-plated stainless steel mounting hardware.

**3. 29417-04** Air Cleaner Insert. **\$39.95**

Fits Evolution 1340 and Twin Cam-equipped models with stock air cleaner (except '08-later Dyna and FLSTSB).

**4. 27939-08** Air Cleaner Insert. **\$54.95**

Fits '08-later Dyna models (except FXDSE2 and FXDFSE) with Original Equipment Air Cleaner Covers.



B. THE WILLIE G. SKULL COLLECTION

# 520 ENGINE TRIM

Derby, Point & Inspection Covers

**THE HARLEY-DAVIDSON "LIVE TO RIDE" COLLECTION**  
 "Live To Ride, Ride to Live." It has become the motto of the Harley-Davidson nation, accompanying riders over millions of miles of travel. This collection is a tribute to that way of life.

## A. GOLD "LIVE TO RIDE" LOGO COLLECTION

- 1. 29328-99** Air Cleaner Trim. **\$39.95**  
 Fits Evolution® 1340 and Twin Cam-equipped models with stock air cleaner (except '08-later Dyna® and FLSTSB).
- 2. 29289-90T** Air Cleaner Trim. **\$43.95**  
 Fits Evolution® 1340-equipped models with 8" round air cleaners.
- 3. 25340-99A** Derby Cover. **\$59.95**  
 Fits '99-later Evolution® 1340 and Twin Cam-equipped models. Installation on '06-later Dyna® and '07-later Touring and Softail® models requires separate purchase of Gasket P/N 25416-99C. Includes chrome-plated stainless steel mounting hardware.
- 4. 25391-90T** Derby Cover. **\$59.95**  
 Fits '70-'98 models (except Sportster® models).
- 5. 32689-99A** Timer Cover. **\$31.95**  
 Fits '99-later Twin Cam-equipped models. Includes chrome-plated stainless steel mounting hardware.
- 6. 32585-90T** Timer Cover. **\$32.95**  
 Fits models with vertical mounting holes.
- 7. 27929-08** Dyna Air Cleaner Trim. **\$54.95**  
 Fits '08-later Dyna models (except FXDSE2 and FXDFSE/2) with Original Equipment Air Cleaner Covers.
- 8. 29405-90T** Oval Air Cleaner Trim. **\$39.95**  
 Fits '66-'78 and '83-'03 XL models, '67-early '78 FL, and '71-early '78 FX models.
- 60653-92T** Chain Inspection Cover. **\$38.95**  
 Fits '85-'06 Electra Glide®, '98-'06 Road Glide®, '85-'96 Tour Glide™, '94-'06 Road King® models.
- 9. 60569-91TA** Oval Chain Inspection Cover. **\$38.95**  
 Fits '65-'84 FL, '82-'86 FXWG, '93-'05 FXDWG and '84-'06 Softail® models.

## B. CHROME "LIVE TO RIDE" LOGO COLLECTION

- 25372-02A** Derby Cover. **\$43.95**  
 Fits '99-later Evolution® 1340 and Twin Cam-equipped models. Installation on '06-later Dyna and '07-later Touring and Softail models requires separate purchase of Gasket P/N 25416-99C. Includes chrome-plated stainless steel mounting hardware.
- 1. 25391-84T** Derby Cover. **\$47.95**  
 Fits '70-'98 models (except XL models).
- 2. 32698-02A** Timer Cover. **\$25.95**  
 Fits '99-later Twin Cam-equipped models. Includes chrome-plated stainless steel mounting hardware.
- 3. 32581-85T** Timer Cover. **\$25.95**  
 Fits models with horizontal mounting holes (except '04-later XL models).
- 32585-89T** Timer Cover. **\$25.95**  
 Fits models with vertical mounting holes.
- 4. 29341-02** Air Cleaner Trim. **\$29.95**  
 Fits '99-later Twin Cam-equipped models (except '08 Dyna) with stock air cleaners.
- ~~**5. 29289-89T** Air Cleaner Trim. **\$32.95**  
 Fits Evolution-1340-equipped models with 8-inch round air cleaner.~~ **OBSOLETE**
- 6. 27935-08** Air Cleaner Trim. **\$47.95**  
 Fits '08-later Dyna models (except FXDSE2 and FXDFSE/2) with Original Equipment Air Cleaner Covers.
- 7. 60568-91TA** Chain Inspection Cover. **\$29.95**  
 Fits '65-'84 FL, '82-'86 FXWG, '93-'05 FXDWG and '84-'06 Softail® models.



A. THE GOLD "LIVE TO RIDE" COLLECTION



A. THE GOLD "LIVE TO RIDE" LOGO COLLECTION



B. THE CHROME "LIVE TO RIDE" LOGO COLLECTION

Notice: The prices appearing in this catalog are the manufacturer's suggested retail prices. Actual retail prices may vary.

# ENGINE TRIM 521

Derby, Point & Inspection Covers



C

C. THE GOLD & CHROME FLAMES COLLECTION

## THE FLAMES COLLECTION

Ever since they began emerging on gas tanks a few decades ago, flames have been a symbol of custom styling. Now, Harley-Davidson continues the tradition with the Flames Collections.

### C. GOLD & CHROME FLAMES COLLECTION

- 1. 25334-99A** Derby Cover. **\$59.95**  
Fits '99-later Evolution® 1340 and Twin Cam-equipped models. Installation on '06-later Dyna® and '07-later Touring and Softail® models requires separate purchase of Gasket P/N 25416-99C. Includes chrome-plated stainless steel mounting hardware.
- 2. 32662-99A** Timer Cover. **\$32.95**  
Fits '99-later Twin Cam-equipped models. Includes chrome-plated stainless steel mounting hardware.
- 3. 27936-08** Air Cleaner Trim. **\$54.95**  
Fits '08-later Dyna models (except FXDSE2 and FXDFSE/2) with Original Equipment Air Cleaner Covers.
- 4. 25393-98** Derby Cover. **\$59.95**  
Fits all '70-'98 models (except Sportster® models).
- 5. 32571-98A** Timer Cover. **\$25.95**  
Fits all models with horizontal holes on timer cover. Includes chrome-plated stainless steel mounting hardware.
- 6. 32590-98** Timer Cover. **\$25.95**  
Fits models with vertical holes on timer cover.
- 7. 29415-99** Air Cleaner Trim. **\$39.95**  
Fits Evolution 1340 and Twin Cam-equipped models with stock air cleaner (except '08-later Dyna and FLSTSB).

#### Air Cleaner Replacement Screw (not shown)

**29419-98A** **\$2.65**  
Fits Flames Air Cleaner Trim P/N 29410-98 and 29415-99.

**8. 60585-98** Inspection Cover. **\$38.95**

Fits '85-'06 Electra Glide®, '98-'06 Road Glide®, '85-'96 Tour Glide™, '94-'06 Road King® models.

**9. 60584-98** Inspection Cover. **\$38.95**

Fits '80-'86 FXWG; '93-'05 FXDWG and '84-'06 Softail® models.

### D. CHROME FLAMES COLLECTION

- 1. 25336-06** Derby Cover. **\$43.95**  
Fits '99-later Evolution® 1340 and Twin Cam-equipped models. Installation on '06-later Dyna® and '07-later Touring and Softail® models requires separate purchase of Gasket P/N 25416-99C. Includes chrome-plated stainless steel mounting hardware.
- 2. 32964-06** Timer Cover. **\$25.95**  
Fits '99-later Twin Cam-equipped models. Includes chrome-plated stainless steel mounting hardware.
- 3. 29430-06** Air Cleaner Trim. **\$25.95**  
Fits Evolution 1340 and Twin Cam-equipped models with stock air cleaner (except '08-later Dyna and FLSTSB).
- 4. 27937-08** Air Cleaner Trim. **\$47.95**  
Fits '08-later Dyna models (except FXDSE2 and FXDFSE/2) with Original Equipment Air Cleaner Covers.



C

C. THE GOLD & CHROME FLAMES COLLECTION



D



D

D. THE CHROME FLAMES COLLECTION

Notice: The prices appearing in this catalog are the manufacturer's suggested retail prices. Actual retail prices may vary.

## 522 ENGINE TRIM

Derby, Point & Inspection Covers

### A. THE HARLEY-DAVIDSON MOTOR CO. COLLECTION

This collection personifies Harley style. It had better, because we put our name on it – The Harley-Davidson Motor Co. Collection.

**1. 25338-99A** Derby Cover. **\$41.95**  
Fits '99-later Evolution® 1340 and Twin Cam-equipped models. Installation on '06-later Dyna® and '07-later Touring and Softail® models requires separate purchase of Gasket P/N 25416-99C. Includes chrome-plated stainless steel mounting hardware.

**2. 25330-98** Derby Covers – 3-Hole. **\$47.95**  
Fits '70-'98 models (except Sportsters).

**3. 32047-99A** Timer Cover. **\$25.95**  
Fits '99-later Twin Cam-equipped models. Includes chrome-plated stainless steel mounting hardware.

**4. 32666-98** Timer Cover. **\$20.95**  
Fits models with vertical holes on timer cover.

**32668-98A** Timer Cover. **\$20.95**  
Fits models with horizontal holes on timer cover. Includes chrome-plated stainless steel mounting hardware.

**5. 27938-08** Air Cleaner Trim. **\$47.95**  
Fits '08-later Dyna models (except FXDSE2 and FXDFSE/2) with Original Equipment Air Cleaner Covers.

### B. HARLEY-DAVIDSON MOTOR CO. AIR CLEANER INSERT

Add insert to dress up the air cleaner. Includes matching screw.

**29243-97** **\$15.95**  
Fits Evolution® 1340 and Twin Cam-equipped models with stock air cleaner (except '08-later Dyna and FLSTSB).



A. THE HARLEY-DAVIDSON MOTOR CO. COLLECTION



A. THE HARLEY-DAVIDSON MOTOR CO. COLLECTION



B. HARLEY-DAVIDSON MOTOR CO. AIR CLEANER INSERT

Notice: The prices appearing in this catalog are the manufacturer's suggested retail prices. Actual retail prices may vary.



# ENGINE TRIM 523

Derby, Point & Inspection Covers



C

## C. CLASSIC CHROME COVERS

From the design philosophy of less is more, we bring you this collection of basic chrome accessories, which provide a clean, custom look that is guaranteed to turn heads.

**60668-99** Derby Cover. **\$63.95**  
Fits '99-'05 Dyna® and '99-'06 Touring and Softail® models (shown).

**60766-06** Derby Cover. **\$63.95**  
Fits '06-later Dyna and '07-later Softail and Touring models.

**1. 60668-84B** Derby Cover. **\$63.95**  
Fits '70-'98 Big Twin and Evolution 1340 equipped models.

**2. 34760-04** Derby Cover. **\$63.95**  
Fits '04-later XL models.

**3. 32584-88TA** Timer Cover. **\$20.95**  
Fits '70-later models (except Twin Cam-equipped models). Includes chrome-plated stainless steel mounting hardware.

**4. 32679-99A** Timer Cover. **\$20.95**  
Fits Twin Cam-equipped models. Includes chrome-plated stainless steel mounting hardware.

### Primary Chain Inspection Cover

**5. 34761-94** Fits '94-'03 XL models. **\$23.35**

### Chrome Inspection Covers – with Shifter Hole

**6. 60529-90A** **\$78.00**  
Fits '91-'05 Dyna models (except FXDWG).

### Chrome Inspection Cover – without Shifter Hole

**7. 60572-86** **\$20.80**  
Fits '93-'05 FXDWG and '86-'06 FXST, FXSTS, FLST models.

### Chrome Inspection Cover – without Shifter Hole

**8. 60670-85A** Fits '85-'06 Touring models. **\$40.00**

C. CLASSIC CHROME COVERS

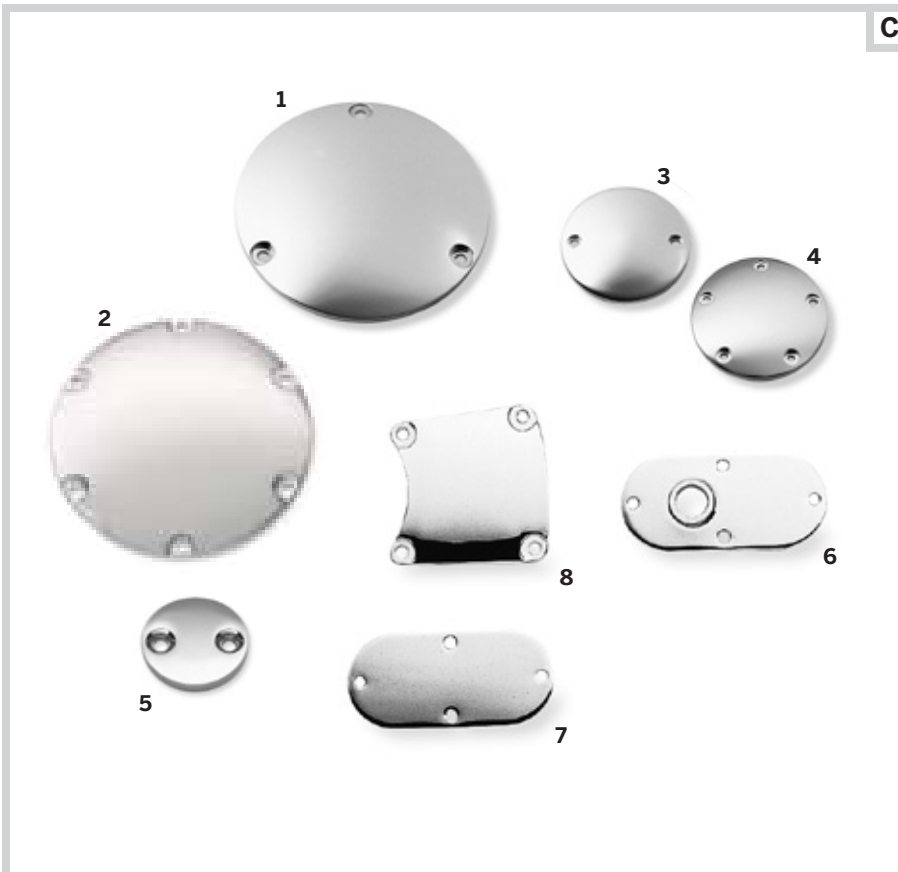

C

C. CLASSIC CHROME COVERS

Notice: The prices appearing in this catalog are the manufacturer's suggested retail prices. Actual retail prices may vary.

# 524 ENGINE TRIM

## Primary Covers

### A. CHROME ENGINE KIT FOR TWIN CAM-EQUIPPED MODELS

Upgrade your silver polished motor to the brilliance of chrome. Kit includes the rocker housing and rocker cover, tappet cover, outer primary, derby cover, cam cover, transmission top and side cover and all necessary gaskets.

**16327-06A** **\$749.95**  
Fits '06-later Dyna® models with mid controls.  
Stock on FXDL and FXDC models.

**16327-01A** **\$749.95**  
Fits '01-'05 Dyna models.

**16318-07A** **\$749.95**  
Fits '07-later FXST, FXSTB, FLSTFB, and FLSTSB models.

**16330-08A** **\$749.95**  
Fits '08-'09 FXCW models.

**16318-01A** **\$749.95**  
Fits '01-'06 Softail® models.

**16326-07A** **\$749.95**  
Fits '07-later Electra Glide® Standard models.

**16326-02** **\$749.95**  
Fits '01-'06 Electra Glide Standard models.



A. CHROME ENGINE KIT FOR TWIN CAM-EQUIPPED MODELS – '06-LATER DYNA SHOWN

### B. CHROME INNER PRIMARY COVER

Because all components in this cover are exactly like the Original Equipment part, you can be sure this cover will match your outer cover, right down to the high-quality chrome-plating. It completes the look of your powertrain without the hassle of troublesome exchange programs. This cover includes all bearings, dowel pins and seals already installed, to ensure Harley-Davidson quality.

**60792-06B** **\$299.95**  
Fits '06-later FXDWG, FXDSE/2, FXDFSE/2 and '07-later Softail models (except FXCW, FXCWC, and '09 FXSTSSE3). Also fits '08-later FXDF models with Forward Foot Controls.

**60815-08** **\$299.95**  
Fits '08-later FXCW, FXCWC and '09 FXSTSSE3 models. Kit does not include gaskets. Requires separate purchase of Primary Cover Gasket P/N 60547-06 and O-Ring P/N 27444-00Y.

**60639-00** **\$299.95**  
Fits '94-'06 Softail® models.

**60794-06B** **\$299.95**  
Fits '06-later Dyna models (except FXDWG, FXDSE/2, FXDFSE and FXDF with Forward Foot Controls).

**60751-01** **\$299.95**  
Fits '01-'05 Dyna models (except FXDWG).

**60747-01** **\$299.95**  
Fits '01-'05 FXDWG models.

**60739-07** **\$299.95**  
Fits '07-later Touring models. Kit does not include gaskets, and requires separate purchase of Primary Cover Gasket P/N 34901-07 and O-Ring P/N 27444-00Y.

**60739-01** **\$299.95**  
Fits '01-'06 Touring models.



B. CHROME INNER PRIMARY COVER – TOURING SHOWN



B. CHROME INNER PRIMARY COVER – SOFTAIL SHOWN



B. CHROME INNER PRIMARY COVER – FXCW/C SHOWN

Notice: The prices appearing in this catalog are the manufacturer's suggested retail prices. Actual retail prices may vary.

# ENGINE TRIM 525

Primary Covers



NEW

C

C. CHROME INNER PRIMARY COVER TRIM – DYNA WITH MID CONTROLS

## C. CHROME INNER PRIMARY COVER TRIM

Get the look of a chrome inner primary cover without tearing apart the drive train. Designed to wrap the top surface of the painted inner primary cover, these mirror-chrome die-cast and steel shells provide a beefy finished look to the engine cases. Easy-to-install, the two-piece covers are secured with the outer primary hardware, and held in place at four points for quiet operation. The tight tolerances and smooth edges provide a solid, one-piece look. Kit includes required mounting hardware. For a complete custom look, consider adding a Chrome Cylinder Base Cover and Classic Chrome Socket Head Screw Covers (*sold separately*).

**60849-10** **\$139.95**

Fits '06-later Dyna® models with mid controls.

**60870-10** **\$139.95**

Fits '06-later Dyna models with forward controls.

**60868-10** **\$139.95**

Fits '07-later Softail® models (except FXCW, FXCWC and FLSTSC). Fits with Original Equipment shift linkage and Polished Shift Linkages P/N 33819-98A, 33817-98A or 33814-98A

**60869-10** **\$139.95**

Fits '07-later Touring and Trike models.



NEW

C

C. CHROME INNER PRIMARY COVER TRIM – SOFTAIL



Dyna with Mid Controls



Dyna with Forward Controls



Touring and Trike



NEW

C

C. CHROME INNER PRIMARY COVER TRIM – TOURING AND TRIKE

ENGINE TRIM

Notice: The prices appearing in this catalog are the manufacturer's suggested retail prices. Actual retail prices may vary.

# 526 ENGINE TRIM

Primary & Rocker Box Covers

## A. ENGINE COMPONENTS – WRINKLE BLACK

These black powder coated engine covers are the perfect start in converting your powertrain to a striking wrinkle black look. Manufactured from Original Equipment components, these covers are masked and painted on the factory production paint line to ensure a matching wrinkle black finish and a perfect fit. Complete the "blacked-out" look with matching primary covers, rocker housings, rocker covers, cam covers and transmission covers (*sold separately*).

**60758-06** Primary Cover. **\$269.00**  
Fits '06-later Dyna® models with mid controls and accessory Forward Control kits.

**60717-07** Primary Cover. **\$269.00**  
Fits '07-later Softail® models. Also fits '06-later Dyna Wide Glide® and Fat Bob® equipped with factory forward controls. Will not fit with Accessory Forward Controls.

**60705-09** Primary Cover. **\$199.95**  
Fits '07-later Touring models.

**17620-99** Rocker Box Cover. **\$75.75**  
Fits '99-later Dyna, Touring and '00-later Softail® models. (*2 required.*)

**17618-99A** Rocker Box Lower Housing. **\$75.75**  
Fits '99-later Dyna, Touring and '00-later Softail models. (*2 required.*)

**25364-01B** Cam Cover. **\$138.00**  
Fits '01-later Dyna, Softail and '01 Carb Touring and '02-later Touring models.

**37135-06** Transmission Side Cover. **\$52.50**  
Fits '06-later Dyna and '07-later Softail and Touring models.

**34521-06B** Transmission Top Cover. **\$71.00**  
Fits '06-later Dyna and '07-later Softail and Touring models.

**60713-07** Derby Cover. **\$39.00**  
Fits '06-later Dyna and '07-later Softail and Touring models.

## B. CHROME ENGINE AND TRANSMISSION COMPONENTS – TWIN CAM-EQUIPPED

Dress the engine of your Twin Cam-equipped model in chrome. These chrome-plated components are manufactured to Original Equipment specifications for exact fit and finish.

### Chrome Transmission Top Cover

**34469-06B** **\$165.00**  
Fits '06-later Dyna®, '07-later Softail® and Touring models.

### Chrome Transmission Side Cover

**37116-06** **\$103.00**  
Fits '06-later Dyna, '07-later Softail and Touring models.

**37105-99** **\$103.00**  
Fits '99-'05 Dyna, '99-'06 Touring and '00-'06 Softail models.

### Chrome Outer Primary Cover

**60764-06** **\$349.00**  
Fits '06-later Dyna models (except FXDWG).

**60782-06** **\$349.00**  
Fits '06-later Dyna® Wide Glide® and '07-later Softail models.

**60553-07** Fits '07-later Touring models. **\$349.00**

**60543-99B** **\$349.00**  
Fits '99-'05 Dyna® and '99-'06 Softail® models.

**60665-99B** Fits '99-'06 Touring models. **\$349.00**

NOTE: This cover will fit '94-'98 FLT models when used with Clutch Cover P/N 60668-99 and Gasket P/N 25416-99C.

### Chrome Cam Cover

**25369-01B** **\$150.80**  
Fits '01-later Softail and Dyna, '01 Carb Touring and '02-later Touring models.

**25247-99** **\$150.80**  
Fits '99-'00 Dyna and Touring, '01 EFI Touring and '00 Softail models.



A. ENGINE COMPONENTS – WRINKLE BLACK



B. CHROME ENGINE AND TRANSMISSION COMPONENTS – TWIN CAM-EQUIPPED '06-LATER DYNA, '07-LATER SOFTAIL AND TOURING MODELS



B. CHROME ENGINE AND TRANSMISSION COMPONENTS – TWIN CAM-EQUIPPED MODELS

Notice: The prices appearing in this catalog are the manufacturer's suggested retail prices. Actual retail prices may vary.



# ENGINE TRIM 527

Primary & Rocker Box Covers



C. CHROME TRANSMISSION TOP COVERS



D. CHROME ROCKER AND TAPPET COVERS



E. CHROME ENGINE AND TRANSMISSION COMPONENTS – EVOLUTION 1340-EQUIPPED MODELS

## C. CHROME TRANSMISSION TOP COVERS

<b>34469-01</b>	Fits '01-'05 Dyna® models.	<b>\$165.00</b>
<b>34469-99B</b>	Fits '99-'00 Dyna models.	<b>\$165.00</b>
<b>34541-00</b>	Fits '00-'06 Softail® and '01-'06 Touring models.	<b>\$165.00</b>
<b>34468-98A</b>	Fits '98-'99 Softail models and '98-'00 Touring models.	<b>\$165.00</b>

## D. CHROME ROCKER AND TAPPET COVERS

Fits '99-later Dyna and Touring; '00-later Softail models.		
<b>17572-99</b>	Rocker Cover.	<b>\$103.00</b>
<b>17573-99A</b>	Lower Rocker Housing.	<b>\$109.00</b>
<b>17964-99</b>	Tappet Cover, Front.	<b>\$28.00</b>
<b>17966-99</b>	Tappet Cover, Rear.	<b>\$28.00</b>

## E. CHROME ENGINE AND TRANSMISSION COMPONENTS – EVOLUTION® 1340-EQUIPPED MODELS

<b>Chrome Transmission Top Cover</b>		
<b>34468-98A</b>	Fits '98-'99 Softail® models and '98-'00 FLT models.	<b>\$165.00</b>

<b>Chrome Crankcase Gear Covers</b>		
<b>25256-93A</b>	Fits '93-'99 Evolution® 1340-equipped models.	<b>\$175.00</b>

<b>25268-84A</b>	Fits '84-'92 Evolution 1340-equipped models (4 and 5-speed models).	<b>\$175.00</b>
------------------	---	-----------------

<b>Chrome Outer Primary Covers</b>		
<b>60665-85B</b>	Fits '85-'88 FXR, FLT, and FLHT models.	<b>\$349.00</b>

<b>60543-86A</b>	Fits '86-'88 FXST, FXSTS, and FLST models.	<b>\$349.00</b>
------------------	--	-----------------

<b>60543-89</b>	Fits '89-'93 FXST, FXSTS, FLST, and FXD models.	<b>\$349.00</b>
-----------------	---	-----------------

<b>60665-89</b>	Fits '89-'93 FXR, FLT, and FLHT models.	<b>\$349.00</b>
-----------------	---	-----------------

<b>60543-94</b>	Fits '94 Softail and Dyna models.	<b>\$349.00</b>
-----------------	-----------------------------------	-----------------

<b>60543-95</b>	Fits '95 Softail and Dyna models.	<b>\$349.00</b>
-----------------	-----------------------------------	-----------------

<b>60665-94</b>	Fits '94 FXR and '94-'98 FLT models.	<b>\$349.00</b>
-----------------	--------------------------------------	-----------------

<b>Chrome Inspection Covers – with Shifter Hole</b>		
<b>60667-85A</b>	Fits '85-'94 FXR models.	<b>\$40.00</b>
<b>60529-90A</b>	Fits '91-'05 Dyna models (except FXDWG).	<b>\$78.00</b>

<b>Chrome Inspection Covers – without Shifter Hole</b>		
<b>60572-86</b>	Fits '93-'05 FXDWG and '86-'06 FXST, FXSTS, FLST models.	<b>\$20.80</b>
<b>60670-85A</b>	Fits '85-'06 FLT models.	<b>\$40.00</b>

<b>Chrome Outer Rocker Cover</b>		
Sold as separate pieces. Order two per vehicle.		
<b>17528-92</b>	Fits '92-'99 Evolution® 1340-equipped models.	<b>\$77.95</b>
<b>17528-84A</b>	Fits '84-'91 Evolution 1340-equipped models.	<b>\$77.95</b>

<b>Chrome Rocker Cover Spacer</b>		
Sold as separate pieces. Order two per vehicle.		
<b>17529-92</b>	Fits '92-'99 Evolution 1340-equipped models.	<b>\$98.80</b>
<b>17529-84A</b>	Fits '84-'91 Evolution 1340-equipped models.	<b>\$98.80</b>

<b>Chrome Lower Rocker Cover</b>		
Sold as separate pieces. Order two per vehicle.		
<b>17530-92</b>	Fits '92-'99 Evolution 1340-equipped models.	<b>\$142.20</b>
<b>17530-84B</b>	Fits '84-'91 Evolution 1340-equipped models.	<b>\$142.20</b>

<b>Chrome Transmission Side Cover</b>		
<b>37105-87A</b>	Fits '87-'98 FLT, FLHT, FLHS, FLHR, Dyna, and '87-'99 FXST, FXSTS, and FLST models.	<b>\$103.00</b>

Notice: The prices appearing in this catalog are the manufacturer's suggested retail prices. Actual retail prices may vary.

## 528 ENGINE TRIM

### Engine & Transmission Covers

#### A. ENGINE/TRANSMISSION INTERFACE AND TOP COVER KIT

This chrome-plated cover kit dresses the area between the cam cover and transmission, and hugs the transmission top cover for a custom look. The cover conceals the interface hardware, and wraps the oil filler spout for a unified appearance. The four-piece cover kit includes chrome mounting hardware and the hex wrenches required for installation.

**66516-07** Fits '06-later Dyna® models. **\$99.95**

#### B. ENGINE TRANSMISSION INTERFACE COVER

Featuring a ribbed design for sharp surface contrasts, this chrome Engine Transmission Interface Cover provides a custom option to conceal the space between the cam cover and the transmission. The two-piece cover stretches from the gearcase cover to the rear of the transmission, and frames the transmission side cover with a band of chrome for a complete custom look. Kit includes all necessary mounting hardware.

**66543-08** **\$99.95**  
Fits '07-later Softail® models (except FLSTSC, FXCW, and FXCWC). Does not fit models equipped with hydraulic clutch.

#### C. ENGINE TRANSMISSION MOUNT COVER

Dress your engine in style, without hiding its mechanical heart. The chrome oil lines remain visible, while the cover wraps the fittings and engine to transmission connection in chrome. Kit includes chrome-plated mounting hardware.

**37982-04** **\$64.95**  
Fits '00-'06 Softail® models (except FLSTS and FLSTSC).

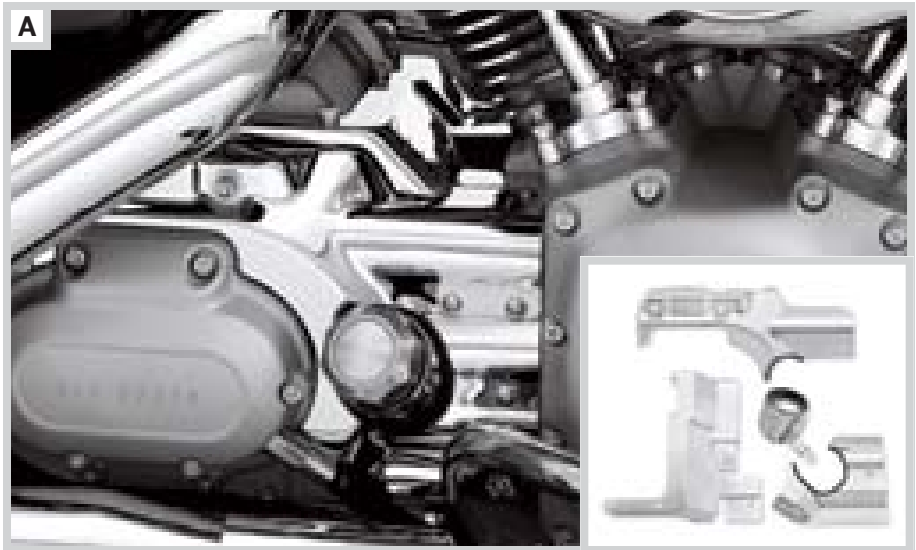

A. ENGINE/TRANSMISSION INTERFACE AND TOP COVER KIT



B. ENGINE TRANSMISSION INTERFACE COVER



C. ENGINE TRANSMISSION MOUNT COVER

*Notice: The prices appearing in this catalog are the manufacturer's suggested retail prices. Actual retail prices may vary.*

# ENGINE TRIM 529

Engine & Transmission Covers

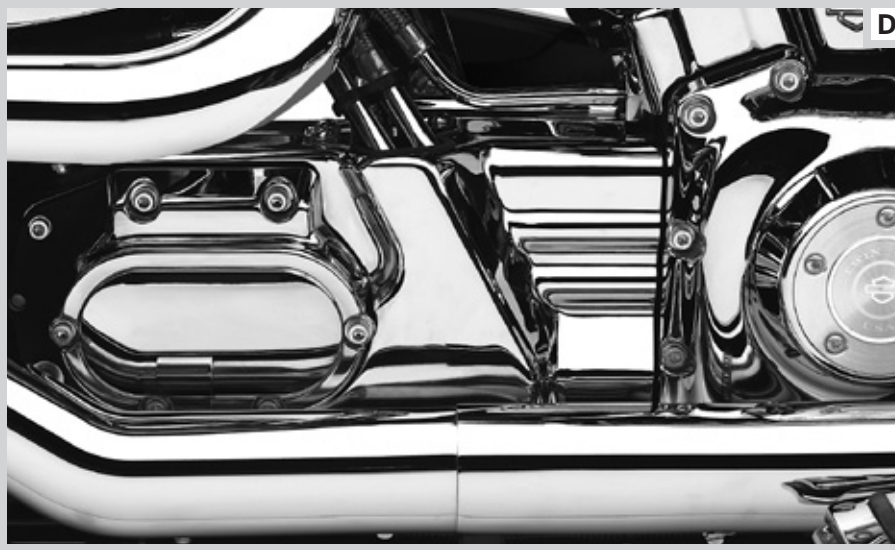

**D. ENGINE TRANSMISSION INTERFACE COVER**

## D. ENGINE TRANSMISSION INTERFACE COVER

Featuring a ribbed design for sharp surface contrasts, this chrome Engine to Transmission Interface Cover provides a custom option to conceal the space between the transmission, rear motor mount, and gearcase cover. Includes mounting hardware and bracket. Can be installed with or without complementing Top Cover P/N 66510-00.

**66508-00** **\$64.95**

Fits '00-'06 Softail® models (except FLSTS and FLSTSC). Does not fit with Braided Stainless Steel Oil Lines or Hydraulic Clutch.

## E. ENGINE TRANSMISSION INTERFACE COVER EXTENSION

Wrap the rear of the transmission in chrome, and stretch the look of the Engine Transmission Interface Cover P/N 66508-00 from the front of the engine to the back. This easy-to-install kit complements both black and silver engines. Complete kit includes chrome-plated mounting hardware.

**66139-04** **\$43.95**

Fits '00-'06 Softail models (except FLSTS and FLSTSC). Must be used with Engine Transmission Interface Cover P/N 66508-00.

## F. ENGINE TRANSMISSION TOP COVER

This cover stylishly fills the top gap between the engine and transmission, and complements the design of the Engine Transmission Interface Cover P/N 66508-00. Includes mounting hardware.

**66510-00** **\$39.95**

Fits '00-'06 Softail models. (Requires separate purchase of Engine Transmission Interface Cover P/N 66508-00 for installation.) Does not fit with Braided Stainless Steel Oil Lines, Hydraulic Clutch, or Cylinder Base P/N 32753-01.

## G. ENGINE/TRANSMISSION INTERFACE AND TOP COVER KIT

This chrome-plated cover kit dresses the area between the cam cover and transmission, and wraps the rear and top of the transmission for a custom look. The ribbed two-piece side cover kit conceals the interface hardware, and the contoured top cover fills the valley between the rear cylinder and transmission cover. The three-piece kit includes all necessary mounting hardware.

**66532-07** **\$99.95**

Fits '07-'08 Touring models. Will not fit with Chrome Transmission Oil Dipstick P/N 37154-06, or models equipped with Hydraulic Clutch.



**E. ENGINE TRANSMISSION INTERFACE COVER EXTENSION**



**F. ENGINE TRANSMISSION TOP COVER**



**G. ENGINE/TRANSMISSION INTERFACE AND TOP COVER KIT**

Notice: The prices appearing in this catalog are the manufacturer's suggested retail prices. Actual retail prices may vary.



# 530 ENGINE TRIM

## Engine & Transmission Covers

### A. CAST ENGINE/TRANSMISSION INTERFACE KIT

Bridge the space between the cam cover and the transmission in style. The cast and chrome-plated cover conceal the space between the transmission and gear case cover, bringing a unified look to the right side of your Touring bike. Kit includes all necessary mounting hardware.

**66545-07** **\$64.95**

Fits '07-'08 Touring models. Will not fit models equipped with Hydraulic Clutch.



**A. CAST ENGINE/TRANSMISSION INTERFACE KIT**

### B. CAST ENGINE/TRANSMISSION INTERFACE COVER

Bridge the space between the cam cover and the transmission in style. The cast and chrome-plated cover conceals the oil hose, oil line cover, and the clutch cable, bringing a unified look to the right side of your Touring bike.

**66530-03** **\$99.95**

Fits '02-'06 Touring models. Will not fit with Lifter Block Cover P/N 18248-99, models equipped with Hydraulic Clutch or Screamin' Eagle® Six Speed Transmission.



**B. CAST ENGINE/TRANSMISSION INTERFACE COVER**

### C. RIBBED ENGINE TRANSMISSION INTERFACE COVER FOR TOURING MODELS

Featuring a ribbed design for sharp surface contrasts, this chrome Engine to Transmission Interface Cover provides a custom option to conceal the space between the transmission and gearcase cover. Includes mounting bracket and hardware.

**66503-02** **\$64.95**

Fits '02-'06 Touring models. Will not fit models equipped with Hydraulic Clutch or Screamin' Eagle Six Speed Transmission.

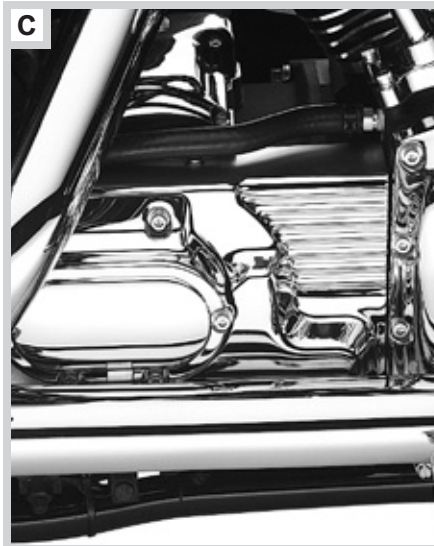

**C. RIBBED ENGINE TRANSMISSION INTERFACE COVER FOR TOURING MODELS**

### D. ENGINE TRANSMISSION INTERFACE COVER

This special, chrome-plated steel cover features an embossed Bar & Shield logo and textured recess that is designed to allow easy access to the transmission dipstick without removal of the cover. This cover cleans up the area between the transmission and the gearcase cover by concealing the oil lines.

**66096-02** **\$69.95**

Fits '02-'06 Touring models. Will not fit models equipped with Hydraulic Clutch or Screamin' Eagle Six Speed Transmission.



**D. ENGINE TRANSMISSION INTERFACE COVER**

### E. CHROME OIL HOSE COVER

A unique custom option, this chrome-plated Oil Hose Cover hides the oil hose on the right side of your Touring bike. The two-piece design allows for easy installation. Includes chrome mounting hardware.

**37961-02** **\$59.95**

Fits '02-'06 Touring models. Must be used with Engine Transmission Interface Cover P/Ns 66096-02 or 66503-02. (Does not fit with Lifter Block Cover Kit P/N 18248-99 or Starter Solenoid Cover P/N 31724-98.)



**E. CHROME OIL HOSE COVER**

*Notice: The prices appearing in this catalog are the manufacturer's suggested retail prices. Actual retail prices may vary.*





**F. RIBBED OIL PUMP COVER**



**G. CHROME OIL FILLER SPOUT**

**F. RIBBED OIL PUMP COVER**

Finished with flashing chrome, this hand-polished steel cover has a ribbed pattern that matches the transmission covers on '87-'98 Evolution® 1340 models. Allows normal check of oil level without removal and includes all necessary hardware and instructions.

**66088-96** **\$79.95**  
Fits '87-'98 FLT, FLHT, FLHS, FLHRC, FLHR and FLTR models.

**G. CHROME OIL FILLER SPOUT**

Add more chrome to the side of your transmission with this chrome-plated version of the stock oil filler spout. Made from the same Original Equipment component to ensure product quality and fitment. Kit includes new replacement gasket and chrome hardware.

**62511-06** Fits '06-later Dyna® models. **\$49.95**

**H. CHROME OIL FILLER SPOUT**

Add more chrome to the side of your transmission with this chrome-plated version of the stock oil filler spout. Made from the same Original Equipment component to ensure product and fitment integrity. Comes with a new replacement gasket and chrome hardware.

**62470-02** **\$69.95**  
Fits '99-'06 FLHT, FLHR, and FLTR models. Also fits '93-'98 Evolution® 1340-equipped models without Oil Temperature Dipstick with Lighted LCD Readout P/N 62936-00B.

**I. CHROME OIL VENT LINE**

Add a final detail to your Touring model with this Chrome Oil Vent Line, constructed from steel tubing that's polished and chrome-plated for a brilliant finish. Kit includes polished and chrome-plated compression fittings, and installs easily for a custom look.

**33111-02** **\$49.95**  
Fits '02-'06 Touring models. Also fits '99-'06 Touring models equipped with Oil Filler Spout P/N 62470-02, 62453-02, or 62454-02A.

**J. CHROME OIL HOSE COVER**

Add some chrome to the Twin Cam with this polished and chrome-plated Oil Hose Cover. We start with the Original Equipment cover, to ensure correct fitment and product integrity, then polish and chrome-plate it to the high standards you've come to expect from Genuine Motor Accessories. Includes chrome-plated mounting hardware.

**37946-99** **\$59.95**  
Fits '99-'06 Touring models. (Does not fit with Twin Cam Premium Oil Cooler for Touring Models P/N 62868-99 or Oil Temperature Gauge Kit P/N 75265-04 or 74513-04.)

**K. CHROME OIL FILTER BRACKET**

This highly-polished, triple chrome-plated bracket looks great against a blacked-out engine. To ensure proper fitment, it's made from the same Original Equipment aluminum die-casting. Includes chrome mounting hardware and new seals.

**26321-99A** **\$69.95**  
Fits '99-'06 Touring and '99-'05 Dyna® models. Does not fit Softail® models.



**H. CHROME OIL FILLER SPOUT**



**I. CHROME OIL VENT LINE**



**J. CHROME OIL HOSE COVER**



**K. CHROME OIL FILTER BRACKET**

Notice: The prices appearing in this catalog are the manufacturer's suggested retail prices. Actual retail prices may vary.

# 532 ENGINE TRIM

## Engine & Transmission Covers

### A. CYLINDER BASE COVER – SMOOTH

Add a finished chrome look to the left side of your Twin Cam engine. This easy-to-install kit includes all necessary mounting hardware.

**32042-07** **\$49.95**  
Fits '07-later Softail® models. Will not fit CVO™ models and models equipped with 110 cubic inch engines.

**32077-07** **\$49.95**  
Fits '06-later Dyna® and '07-later Touring models. Will not fit CVO models and models equipped with 110 cubic inch engines.

### B. CYLINDER BASE COVER – RIBBED

Add a finished chrome look to the left side of your Twin Cam engine with this stylish chrome die-cast cover. Easy installation with included hardware. (Shift linkage removed for photo.)

**32753-01** **\$49.95**  
Fits '99-'06 Touring models, '99-'05 Dyna models with forward controls, and '00-'06 Softail® models. Will not fit with Engine Transmission Top Covers P/N 66505-00, 66510-00 and 66513-00.

### C. LIFTER BLOCK COVER

Unlike other lifter block covers on the market, this chrome-plated cover features a design that helps hide the mounting hardware. With an embossed Bar & Shield logo, this kit cleans up the lifter block area and extends chrome from the gearcase cover to the lifter tubes. Includes all mounting hardware and installation tools.

**18248-99** **\$59.95**  
Fits '99-'06 Touring and '99-'05 Dyna models. Does not fit with Top Covers P/N 66513-00 or 66505-00, Oil Hose Cover P/N 37961-02 or Interface Cover P/N 66530-03.

**18278-06** **\$59.95**  
Fits '06-later Dyna and '07-later Touring models.

**18262-00** **\$59.95**  
Fits '00-later Twin Cam Softail® models. (Will not fit with Engine/Transmission Interface Top Cover P/N 66510-00.)

### D. CHROME BILLET ALUMINUM LIFTER COVERS

Manufactured from billet aluminum and polished and plated for a rich look, these Chrome Billet Aluminum Lifter Covers add a custom look to Twin Cam-equipped models. Unique styling matches H-D® Chrome Pushrod Cover Kit, and fits with stock or Screamin' Eagle® Quick-Install Pushrods. Kit includes chrome mounting hardware and gaskets to complete the installation.

**18088-02** **\$129.95**  
Fits '99-later Twin Cam-equipped models.

### E. CHROME PUSHROD COVER KIT

These covers feature a unique look, courtesy of a special grooved design, and superior quality, thanks to a crafted combination billet 6061-T6 aluminum, finished with copper-, dual nickel- and chrome-plating. Can be used with Original Equipment pushrods or Screamin' Eagle® Adjustable Pushrods.

**18096-00A** **\$174.95**  
Fits '99-later Twin Cam-equipped models.

### F. CHROME NEUTRAL SWITCH COVER

Add a final custom detail to your chrome transmission cover with this Chrome Neutral Switch Cover. It installs easily and comes with installation hardware.

**33919-00** **\$24.95**  
Fits '98-'05 Dyna and '98-'06 Touring models.



A. CYLINDER BASE COVER – SMOOTH

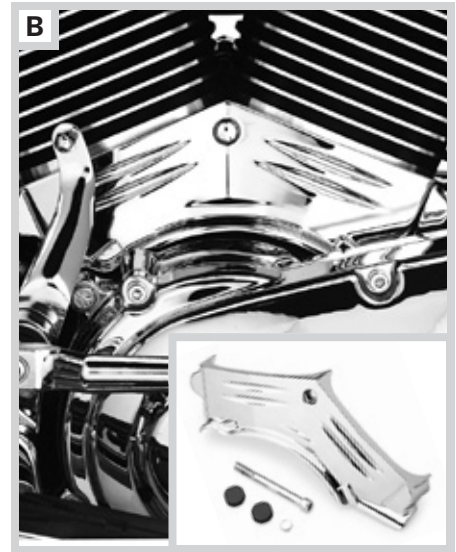

B. CYLINDER BASE COVER – RIBBED



C. LIFTER BLOCK COVER



D. CHROME BILLET ALUMINUM LIFTER COVERS



E. CHROME PUSHROD COVER KIT

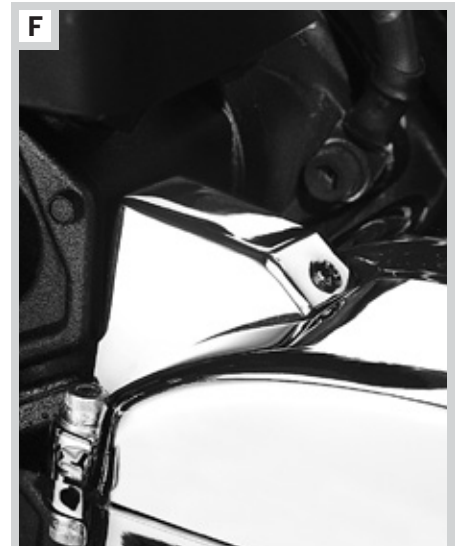

F. CHROME NEUTRAL SWITCH COVER

Notice: The prices appearing in this catalog are the manufacturer's suggested retail prices. Actual retail prices may vary.



# ENGINE TRIM 533

Engine & Transmission Covers

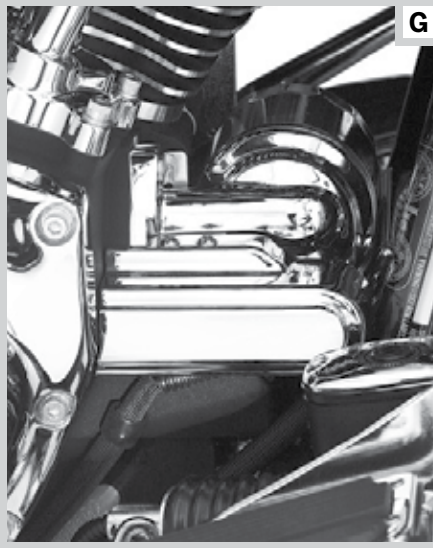

G

**G. OIL PRESSURE SWITCH COVER**



H

**H CHROME STARTER SOLENOID COVER KIT**



I

**I. STARTER SOLENOID COVER**



J

**J. CLUTCH CABLE CONNECTOR COVER**



K

**K. CHROME OIL COOLER COVER KIT**

## G. OIL PRESSURE SWITCH COVER

Cover the stock oil pressure switch with this highly-polished chrome cover. This cover is easily installed with the hardware provided.

**66218-01** **\$31.95**

Fits '99-'06 Electra Glide® Classic, Ultra Classic®, and Road Glide® models and '04-'06 Road King® and Electra Glide Standard models. Will not fit with Super Premium Oil Cooler Kit P/N 62895-03A.

~~**66217-01** **\$31.95**~~

~~Fits '99-'05 Dyna®, '99-'03 Road King® and Electra Glide® Standard models. Does not fit '99-'03 FLHT models equipped with optional oil temperature gauge kit. OBSOLETE~~

## H. CHROME STARTER SOLENOID COVER KIT

Add chrome to an often-overlooked area with this cover, featuring the same high-quality, bright finish used on most of our accessories.

**31783-00** **\$21.95**

Fits '94-later models (except '02-later VRSC™).

## I. STARTER SOLENOID COVER

With die-cast grooves that add texture, this chrome-plated cover is an easy-to-install element of style. Includes stainless steel hardware.

**31724-98** **\$21.95**

Fits '90-later Evolution® 1340-equipped models, '99-'06 Twin Cam-equipped models (except '06 Dyna®), '95-later XL883 and '91-later XL1200 models. (Does not fit with Oil Vent Hose Cover P/N 37961-02.)

## J. CLUTCH CABLE CONNECTOR COVER

Add the finishing touch to your transmission. This chrome-plated die-cast cover conceals the clutch cable connector as it enters the transmission end cover. The grooved and tapered cover is styled to match the Fuel Tank Fitting Cover P/N 62809-06 and the Chrome Clutch Ferrule and Banjo Bolt Cover Kit P/N 32714-98A to complete a custom look. Kit includes chrome-plated mounting hardware.

**38636-07** **\$24.95**

Fits '06-later Dyna, '07-later Softail, and '07-later Touring models (except models equipped with Hydraulic Clutch). Does not fit with braided or Diamondback clutch cables.

**32875-04** **\$26.95**

Fits '99-'06 Touring, '00-'06 Softail® and '99-'05 Dyna® models, except models equipped with Hydraulic Clutch. Does not fit with braided or Diamondback clutch cables.

## K. CHROME OIL COOLER COVER KIT

Dress the Touring Oil Cooler in style. This Chrome Oil Cooler Cover is designed to hug the contours of the cooler body while allowing complete airflow across the surface. Includes required mounting hardware.

**62995-04** **\$49.95**

Fits '99-'06 Touring models equipped with Touring Oil Cooler Kit P/N 62895-03A.

# 534 ENGINE TRIM

Carb & EFI Covers

## A. ENRICHENER/CHOKE KNOB COVER

A subtle chrome touch that can make all the difference, this cover features the Bar & Shield logo and can be installed in minutes.

**29431-97** Fits '86-'06 carbureted models. **\$29.95**

## B. CHROME FUEL PETCOCK COVER

This cover offers unique styling, with chrome plating and a "Harley-Davidson Motor Co." logo. Cover is notched for position identification.

**62968-02** Fits '02-'06 carbureted models. **\$34.95**

**62863-98** Fits '94-'01 carbureted models. **\$34.95**

## C. CHROME "H-D MOTOR CO." LOGO CV CARBURETOR TOP COVER

Die-cast and chrome-plated, with black-lettered logo. Includes mounting hardware for easy installation.

**27351-96** **\$21.95**

Fits '88-'06 XL, '90-'00 1340 models, and '99-'06 Twin Cam models. Works with Screamin' Eagle® 44mm CV Carburetor Kit P/N 27934-99. (Does not fit fuel injected models.)

## D. CLASSIC CHROME CV CARBURETOR TOP COVER

Die-cast and chrome-plated cover with chrome-plated mounting hardware.

**27353-96** **\$19.95**

Fits '88-'06 XL; '90-'00 Evolution® 1340-equipped models, and '99-'06 Twin Cam-equipped models. Works with Screamin' Eagle® 44mm CV Carburetor Kit P/N 27934-99. (Does not fit fuel injected models.)

**27129-88T** **\$.95**

Replacement Chrome Screw with Washer.

## E. CHROME BAR & SHIELD LOGO CV CARBURETOR TOP COVER

This die-cast and chrome-plated cover features a Bar & Shield design highlighted with a gloss black outline, lettering and chrome-plated mounting hardware. Works with Screamin' Eagle® 44mm CV Carburetor Kit P/N 27934-99.

**27040-88T** **\$21.95**

Fits '88-'06 XL and '90-'00 Evolution® 1340 and '99-'06

Twin Cam-equipped models with CV carburetors.

Does not fit fuel injected models.

## F. FUEL TANK FITTING COVER

This classic chrome styled two piece die-cast cover conceals the EFI fuel line fitting below the tank. Easy-to-install, the kit includes chrome-plated hardware and hex key wrench.

**62809-06** **\$29.95**

Fits '03-later fuel injected Touring, '02-later fuel injected Softail®, and '04-'07 fuel injected Dyna® models.



A. ENRICHENER/CHOKE KNOB COVER

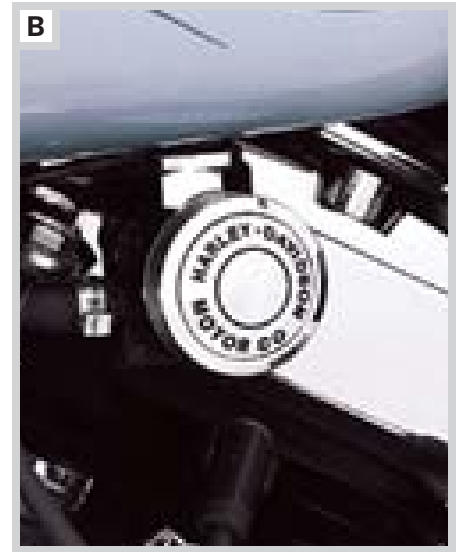

B. CHROME FUEL PETCOCK COVER



C. CHROME H-D MOTOR CO. LOGO CV CARBURETOR TOP COVER



D. CLASSIC CHROME CV CARBURETOR TOP COVER



E. CHROME BAR & SHIELD LOGO CV CARBURETOR TOP COVER



F. FUEL TANK FITTING COVER

Notice: The prices appearing in this catalog are the manufacturer's suggested retail prices. Actual retail prices may vary.



# ENGINE TRIM 535

Carb & EFI Covers



**G. EFI INTAKE MANIFOLD COVER**



## G. EFI INTAKE MANIFOLD COVER

Add a finishing touch to your Original Equipment or custom air cleaner. This mirror-polished chrome cover conceals the sensors, plugs and wires on the intake manifold, and adds a splash of chrome below the fuel tank.

**27483-07A** **\$39.95**

Fits '04-later Dyna®, '01-later Softail® and '02-'07 Touring models with Electronic Fuel Injection. Does not fit HDI models.

## H. BRAIDED STAINLESS STEEL EFI FUEL LINE

Add a finishing touch to the fuel-injected Dyna with this Braided Stainless Steel Fuel Line. Complete replacement line includes pre-installed fuel tank and EFI module connectors.

**63020-04** **\$39.95**

Fits '04-'05 fuel-injected Dyna models.

## I. BRAIDED STAINLESS STEEL FUEL CROSSOVER LINE

A beautifully Braided Stainless Steel Fuel Line accented with highly polished chrome fittings for your front fuel tank crossover. Innovative fittings are designed to eliminate unsightly hose clamps.

**63709-04** **\$34.95**

Fits '04-later Dyna® models (except FXDWG, '06 FXD35, '07-later FXDC and '08-later FXDF models).

**63729-04** **\$34.95**

Fits '04-later FXDWG, '06 FXD35, '07-later FXDC, '08-later FXDF, and FXDFSE/2 models.

**63690-00A** Fits '93-'03 Dyna models. **\$34.95**

**63698-02** Fits '97-'07 Touring models. **\$34.95**

**63692-00A** **\$34.95**

Fits '00-later Softail models (except FXSTD and FXCW/C).

## J. BRAIDED STAINLESS STEEL OIL LINES

These attractive, Braided Stainless Steel Oil Lines are designed with a unique fitting and seal, eliminating unsightly hose clamps. Includes task-specific wrenches for installation and extra seals.

**63860-00** Fits '00-'06 Softail models. **\$169.95**

**63705-97** Fits '92-'99 Softail models. **\$174.95**

## K. BILLET OIL LINE SEPARATOR

This chrome-plated billet aluminum clamp holds the Original Equipment oil lines in position for a clean, custom appearance. Complete kit is easy-to-install, and includes chrome-plated hardware.

**91333-06** **\$29.95**

Fits '00-later Softail models (except FXCW/C and FXSTSSE3) with Original Equipment oil lines.



**H. BRAIDED STAINLESS STEEL EFI FUEL LINE**



**I. BRAIDED STAINLESS STEEL FUEL CROSSOVER LINE**



**J. BRAIDED STAINLESS STEEL OIL LINES**



**K. BILLET OIL LINE SEPARATOR**

Notice: The prices appearing in this catalog are the manufacturer's suggested retail prices. Actual retail prices may vary.

# 536 ENGINE TRIM

## Oil Level Dipsticks

### A. CHROME OIL DIPSTICK

Easy-to-install chrome-plated oil dipstick adds a finishing touch and shows your attention to detail.

**62692-07** Fits '06-later Dyna® models. **\$49.95**

**62695-09** **\$49.95**

Fits '08-later FXCW and FXCWC models.

### B. CHROME OIL DIPSTICK

Simply an easy-to-install, chrome-plated version of the stock oil dipstick that shows your attention to detail.

**62857-99** Fits '99-'05 Dyna® models. **\$37.95**

**62858-99** Fits '99-'06 Touring models. **\$37.95**

### ~~C. CHROME OIL DIPSTICK – INSERT-STYLE~~

~~With a machined recess on the top for the installation of a small round insert, this chrome-plated version of the stock oil dipstick is a great way to add a custom touch to your bike. Simply fill the recess with a 1/8" insert from any Harley-Davidson® accessory collection (sold separately). Easy to install. (NOTE: Insert P/N 44139-94 will not fit.)~~

~~**62861-99** Fits '99-'06 Touring models. **\$37.95**~~

OBSOLETE

### D. SPEED-CHECK TRANSMISSION DIPSTICK

This decorative and functional dipstick is hand-operated, eliminating the need for a wrench. It has a Bar & Shield logo and is easy-to-install.

**37123-98A** **\$21.95**

Fits '87-'99 Evolution® 1340-equipped models and '99-'06 Touring, '00-'06 Softail® and '99-'05 Dyna models. (Does not fit with Oil Pump Cover P/Ns 66394-93 and 66088-96, Interface Cover P/N 66508-00, or models equipped with hydraulic clutch.)

**37103-08** **\$21.95**

Fits '06-later Dyna® and '07-later Softail® and Touring models. Will not fit Touring models equipped with Engine/Transmission Interface Cover P/N 66532-07.



A. CHROME OIL DIPSTICK – '06-LATER DYNA



A. CHROME OIL DIPSTICK – SOFTAIL ROCKER



B. CHROME OIL DIPSTICK



C. CHROME OIL DIPSTICK – INSERT-STYLE



D. SPEED-CHECK TRANSMISSION DIPSTICK – (37123-98A SHOWN)



D. SPEED-CHECK TRANSMISSION DIPSTICK – (37103-08 SHOWN)

Notice: The prices appearing in this catalog are the manufacturer's suggested retail prices. Actual retail prices may vary.



NEW

E

**E. OIL LEVEL AND TEMPERATURE DIPSTICK WITH LIGHTED LCD READOUT – CHROME ('02-'06 TOURING SHOWN)**



NEW

E

**E. OIL LEVEL AND TEMPERATURE DIPSTICK WITH LIGHTED LCD READOUT – BLACK ('07-LATER TOURING SHOWN)**



NEW

E

**E. OIL LEVEL AND TEMPERATURE DIPSTICK WITH LIGHTED LCD READOUT – CHROME ('00-LATER SOFTAIL SHOWN)**



NEW

E

**E. OIL LEVEL AND TEMPERATURE DIPSTICK WITH LIGHTED LCD READOUT – BLACK ('00-LATER SOFTAIL SHOWN)**



E

**E. OIL LEVEL AND TEMPERATURE DIPSTICK WITH LIGHTED LCD READOUT – CHROME (ROCKER SHOWN)**



NEW

E

**E. OIL LEVEL AND TEMPERATURE DIPSTICK WITH LIGHTED LCD READOUT – BLACK ('06-LATER DYNA SHOWN)**



F

**F. OIL TEMPERATURE DIPSTICK WITH LIGHTED LCD READOUT**

**E. OIL LEVEL AND TEMPERATURE DIPSTICK WITH LIGHTED LCD READOUT**

New and improved "capacitive" level sensing technology provides the highest degree of accuracy and durability. Now available in chrome and black, these dipsticks allow you to check your oil level and oil temperature with the push of a button. Add function and style by replacing your stock dipstick with this hard working version. No more grabbing a rag to pull your hot dipstick. No more oil drips on your pipes and on the garage floor. Simply push the button and this dipstick lights up with a brilliant backlight. Oil level is indicated by a four-segment readout - it even reminds you to check your oil when it is hot. Designed to be waterproof, the LCD display operates on a long-lasting, replaceable Lithium coin-type battery (CR2032 3V, P/N 66373-06). Display features a low battery indicator, and press-and-hold feature to toggle between Fahrenheit and Celsius.

Fits '07-later Touring models (except Trike models and models equipped with a sidecar).

<b>63004-09</b>	Chrome.	<b>\$139.95</b>
<b>63030-09</b>	Black.	<b>\$139.95</b>

Fits '02-'06 Touring models (except models equipped with a sidecar). Also fits '99-'01 Touring models equipped with Chrome Oil Filler Spout P/N 62470-02, 62453-02 or 62454-02A.

<b>62946-09</b>	Chrome.	<b>\$139.95</b>
<b>63131-09</b>	Black.	<b>\$139.95</b>

Fits '00-later Softail® models (except FXCW, FXCWC and FXSTSSE3).

<b>62955-09</b>	Chrome.	<b>\$139.95</b>
<b>63055-09</b>	Black.	<b>\$139.95</b>

Fits '08-later FXCW, FXCWC and FXSTSSE3 models.

<b>63002-09</b>	Chrome.	<b>\$139.95</b>
-----------------	---------	-----------------

Fits '06-later Dyna® models.

<b>62974-09</b>	Chrome.	<b>\$139.95</b>
<b>63065-09</b>	Black.	<b>\$139.95</b>

**F. OIL TEMPERATURE DIPSTICK WITH LIGHTED LCD READOUT**

Add function and style by replacing your stock dipstick with this hardworking version, which includes a beautiful chrome cap and LCD (liquid crystal display) oil temperature readout. The readout is push button operated with an automatic shut-off in five seconds and operates within plus or minus one degree. Designed also to stay on up to 15 minutes if desired. Fahrenheit or Celsius can be changed with a simple push button operation. The readout is displayed with a rare blue light background for easier operation at night. All LCD dipsticks now incorporate an updated and more heat resistant LCD electronic unit. Twin Cam LCD dipsticks also include an improved twist and pull cam-lock removal feature. Designed to be waterproof with replaceable Lithium battery.

<b>62938-00E</b>	Fits '99-'05 Dyna models.	<b>\$99.95</b>
<b>66373-06</b>		<b>\$1.95</b>

CR2032 3v Lithium Replacement Battery.



# 538 ENGINE TRIM

## Cylinder Head Covers

### A. FINNED HEADBOLT BRIDGE

This exclusive aluminum Finned Headbolt Bridge covers both headbolts and the spark plug, filling out your cylinder fins all the way to the rocker box. Featuring an engraved Bar & Shield emblem, the bridge is easy-to-install with unique headbolt mounts. All necessary mounting hardware included (*sold in pairs*).

**43857-00** Silver Highlighted. **\$47.95**  
Fits '99-later Twin Cam-equipped models with electronic fuel injection and '00-later FXSTD models.

**43840-01** Silver Highlighted. **\$47.95**  
Fits '99-'06 carbureted Twin Cam-equipped models.

**43859-00** Black Highlighted. **\$47.95**  
Fits '99-later Twin Cam-equipped models with electronic fuel injection and '00-later FXSTD models.

**43841-01** Black Highlighted. **\$47.95**  
Fits '99-'06 carbureted Twin Cam-equipped models.

### B. CHROME HEADBOLT BRIDGE

This exclusive Headbolt Bridge covers both the headbolts and spark plug with a splash of chrome and an engraved Bar & Shield emblem. Easy-to-install with unique headbolt mounts. Kit includes all necessary mounting hardware (*sold in pairs*).

**43858-00** **\$54.95**  
Fits '99-later Twin Cam-equipped models (except SE110Cl engines).

### C. CLASSIC CHROME HEADBOLT COVERS

Precision-machined of high-quality aluminum and manufactured in the U.S.A. Hand-polished and chrome-plated. This kit includes 4 chrome headbolt covers, set screws, and an Allen wrench for easy installation.

**43822-01** **\$36.95**  
Fits '99-later Twin Cam-equipped models.

**43890-93** **\$36.95**  
Fits '84-'99 Evolution® 1340 and '87-later XL and '08-later XR models.

### D. CHROME SPARK PLUG/HEADBOLT COVER

Quickly add a chrome accent from the headbolt covers to the spark plug. Installs in seconds without tools.

**43835-98** **\$54.95**  
Fits '84-'99 Evolution® 1340-equipped models and '85-'03 XL models. (Does not fit Screamin' Eagle® Evolution Heads.)

### E. GLOSS BLACK HEADBOLT COVER KIT

The perfect accessory for your blacked-out motorcycle, these gloss black, powder-coated covers feature two machined grooves that add that subtle, yet distinctive custom highlight.

**43896-99** **\$38.95**  
Fits '92-later Evolution 1340, XL and XR models. Also fits '99-later Twin Cam-equipped models.



A. FINNED HEADBOLT BRIDGE – SILVER



A. FINNED HEADBOLT BRIDGE – BLACK



B. CHROME HEADBOLT BRIDGE



C. CLASSIC CHROME HEADBOLT COVERS



D. CHROME SPARK PLUG/HEADBOLT COVER



E. GLOSS BLACK HEADBOLT COVER KIT

Notice: The prices appearing in this catalog are the manufacturer's suggested retail prices. Actual retail prices may vary.



# ENGINE TRIM 539

Cylinder Head Covers



F

**F. CHROME BAR & SHIELD LOGO HEADBOLT COVER KIT**



G

**G. CHROME "H-D MOTOR CO." HEADBOLT COVER KIT**

## F. CHROME BAR & SHIELD LOGO HEADBOLT COVER KIT

Precision-machined of high quality aluminum and manufactured in the U.S.A. Hand-polished and chrome-plated. Kit includes 4 headbolt covers, set screws and Allen wrench for easy installation.

**43911-95** **\$36.95**

Fits '84-'99 Evolution 1340-equipped and '87-later XL and '08-later XR models.

## G. CHROME "H-D MOTOR CO." HEADBOLT COVER KIT

**43884-96** **\$36.95**

Fits '92-'99 Evolution® 1340, XL and XR models. Also fits '99-later Twin Cam-equipped models.

## H. CLASSIC CHROME SPARK PLUG COVERS

Quickly slips over spark plug for a secure fit.

**32747-99** **\$18.95**

Fits '99-later Twin Cam-equipped models.

## I. CHROME "H-D MOTOR CO." LOGO SPARK PLUG COVERS

Quickly slips over spark plug for a secure fit.

**32745-99** **\$18.95**

Fits '99-later Twin Cam-equipped models.

## J. CLASSIC CHROME ROCKER BOX BOLT COVERS

Matching the styling of our classic chrome headbolt covers, these chrome-plated Rocker Box Bolt Covers add chrome to your engine. Easy-to-install, the covers are held in place by a spring steel clip. Sold in packages of four.

**43868-99** **\$23.95**

Fits '99-later Twin Cam-equipped models.

**43943-01** **\$23.95**

Fits '84-'99 Evolution 1340 and '87-later XL and '08-later XR models.



H

**H. CLASSIC CHROME SPARK PLUG COVERS**



I

**I. CHROME H-D MOTOR CO. LOGO SPARK PLUG COVERS**



J

**J. CLASSIC CHROME ROCKER BOX BOLT COVERS**



J

Notice: The prices appearing in this catalog are the manufacturer's suggested retail prices. Actual retail prices may vary.

# 540 ENGINE TRIM

## Air Cleaner Covers

### A. HARLEY-DAVIDSON® AIR CLEANER COVER

A classic look backed with superior quality, this brilliant chrome Air Cleaner Cover features a black paint-filled "Harley-Davidson" logo. Chrome-plated stainless steel mounting screw included.

**29754-01** **\$59.95**

Fits '02-later Touring models (except '08-later Touring models equipped with Screamin' Eagle® High Flow Air Cleaner Kits), '04-'07 EFI Dyna®, and '01-later Softail® models (except California and '08-later FLSTSB models). Screamin' Eagle® High Flow Air Cleaner Kits require the separate purchase of Air Cleaner Adapter Kit P/N 29769-01.

### HARLEY-DAVIDSON AIR CLEANER ADAPTER KIT (not shown)

This adapter kit allows H-D® Air Cleaner Cover P/Ns 29598-00, 29599-00 and 29754-01 to be used with Screamin' Eagle® High Flow Air Cleaner Breather Kits on Twin Cam-equipped models. Includes anti-rotation adapter plate and mounting hardware.

**29769-01** **\$8.95**



A. HARLEY-DAVIDSON AIR CLEANER COVER

### B. NOSTALGIC BAR & SHIELD LOGO AIR CLEANER COVER FOR TWIN CAM MODELS

This cover offers unique styling with a concave center and stamped "Harley-Davidson" logo to give your bike a look that's nostalgic, yet distinctive to the Twin Cam engine. Polished and chrome-plated, it is easily installed in minutes.

**29765-01** **\$59.95**

Fits '04-'07 EFI Dyna, and all '01-later Softail® models (except carbureted California and '08-later FLSTSB models). Also fits all '02-later Touring models (except carbureted California models). If installed with Screamin' Eagle High Flow Air Cleaner Kits, requires the separate purchase of Gasket P/N 29591-99.

### C. NOSTALGIC BAR & SHIELD LOGO AIR CLEANER COVER FOR EVOLUTION® 1340 MODELS

Get a polished look with an extra dose of heritage with the Nostalgic Collection – chrome-plated accessories featuring an original-style Bar & Shield logo and a stamped "Made in the U.S.A." An easy-to-install trip down memory lane, each piece is hand-polished and copper-plated, then buffed again prior to adding layers of nickel and chrome. This triple-layer treatment provides a brilliant finish. Includes a polished stainless steel mounting screw.

**29138-91** **\$59.95**

Fits '90-'99 carbureted (CV) Evolution® 1340-equipped models. Also fits '99-later Twin Cam models equipped with Screamin' Eagle High Flow Air Cleaners when installed with Gasket Kit P/N 29591-99 (sold separately).



B. NOSTALGIC BAR & SHIELD LOGO AIR CLEANER COVER FOR TWIN CAM MODELS

### D. SMOOTH AIR CLEANER COVER

Wrap your Screamin' Eagle® round air cleaner element in style. The mirror-chrome low-profile Air Cleaner Cover shields the element and opens breathing space between the backing plate and the cover. Cut-away bottom design exposes the air cleaner element to maximize the air flow. Easy-to-install, the one-piece cover is the ideal complement to the Chrome Air Cleaner Back Plate P/N 29510-05.

**29153-07** **\$44.95**

Fits '99-later Twin Cam models equipped with Screamin' Eagle Stage Kits or High-Flow Air Cleaner Assembly. '08-later Dyna models require separate purchase of Stage I Air Cleaner Kit P/N 29773-02C.



C. NOSTALGIC BAR & SHIELD LOGO AIR CLEANER COVER FOR EVOLUTION 1340 MODELS



D. SMOOTH AIR CLEANER COVER

Notice: The prices appearing in this catalog are the manufacturer's suggested retail prices. Actual retail prices may vary.

# ENGINE TRIM 541

Air Cleaner Covers



**E. FORGED BILLET ALUMINUM AIR CLEANER COVER – BLACK ANODIZED**  
(SHOWN WITH DARK CUSTOM LOGO AIR CLEANER MEDALLION)



**E. FORGED BILLET ALUMINUM AIR CLEANER – CHROME**  
(SHOWN WITH WILLIE G. SKULL MEDALLION AND BLACK SIDE INSERTS)



**E. BILLET AIR CLEANER MEDALLION KITS**  
(95 CUBIC INCH SHOWN)



**E. BILLET AIR CLEANER MEDALLION KITS**  
(SCREAMIN' EAGLE 96 CUBIC INCH SHOWN)



**E. BILLET AIR CLEANER MEDALLION KITS**  
(SCREAMIN' EAGLE 103 CUBIC INCH SHOWN)



**E. BILLET AIR CLEANER MEDALLION KITS**  
(SCREAMIN' EAGLE 110 CUBIC INCH SHOWN)

## E. FORGED BILLET ALUMINUM AIR CLEANER COVER

This unique Billet Aluminum Air Cleaner Cover is styled with inverted V-shape air inlets to complement the V-twin engine profile, and is designed with a generous open intake to maximize engine breathing. Manufactured from 6061-T6 billet aluminum, this high-quality forged dual throat air cleaner cover is expertly CNC-machined to exacting tolerances. Then, its surfaces are polished mirror-smooth and chrome-plated or black anodized to match your customizing direction. The air cleaner kits include complementing brushed aluminum or matte black side inserts and a hidden mounting bolt. Complete the installation with one of the numerous custom medallion inserts (*sold separately*).

**29506-09** Black Anodized. **\$219.95**

Fits Twin Cam and '93-'99 Evolution® 1340 carbureted models equipped with Screamin' Eagle® Air Cleaner Kits (cone shaped filter). See your Dealer for specific applications.

**29745-00A** Chrome. **\$219.95**

Fits Twin Cam and '93-'99 Evolution® 1340 carbureted models equipped with Screamin' Eagle® Air Cleaner Kits (cone shaped filter). See your Dealer for specific applications.

**Also available:**

### BILLET AIR CLEANER SIDE INSERT KIT

Add a touch of color to the H-D® Forged Billet Aluminum Air Cleaner Cover. These easy-to-install Side Inserts are available in a matte black finish to add depth and dimension.

**97005-02** **\$6.95**

Fits Chrome Forged Billet Aluminum Air Cleaner Cover P/N 29745-00A.

**Also shown with:**

### BILLET AIR CLEANER MEDALLION KITS

These polished and chrome-plated inserts for the Billet Air Cleaner Cover snap easily into place. The kit includes an O-ring gasket and individual decorative medallions.

Fits Forged Billet Aluminum Air Cleaner Cover P/N 29745-00A and 29506-09.

**29748-00** 95 Cubic Inch. **\$24.95**

**29929-07** Screamin' Eagle 96 Cubic Inch. **\$38.95**

**29888-06** Screamin' Eagle 103 Cubic Inch. **\$38.95**

**29898-06** Screamin' Eagle 110 Cubic Inch. **\$38.95**

**29833-06** The Willie G.® Skull Collection. **\$24.95**

**29902-09** Dark Custom Collection. **\$38.95**

# 542 ENGINE TRIM

## Hardware Covers

### A. CLASSIC COVERS KIT

Customize your bike down to the last detail. These hardware Cover Kits include the chrome-plated ABS caps and plugs in the sizes and styles required to dress the viewable hardware on the motorcycle. Classic Covers are available as complete Bike Kits with the covers for both engine and chassis hardware, or as Engine-only kits to dress the Twin Cam or XL engine. The kits are easy-to-install, with no tools required.

<b>94947-07</b>	Bike Kit. Fits '99-later Dyna® models.	<b>\$259.95</b>
<b>94921-09</b>	Bike Kit. Fits '09-later FXCW and FXCWC models.	<b>\$249.95</b>
<b>94922-09</b>	Bike Kit. Fits '09-later FLSTSB models.	<b>\$259.95</b>
<b>94923-09</b>	Bike Kit. Fits '09-later Softail® models (except FXCW, FXCWC and FLSTSB).	<b>\$259.95</b>
<b>94948-07</b>	Bike Kit. Fits '00-'08 Softail models.	<b>\$279.95</b>
<b>94924-09</b>	Bike Kit. Fits '09-later Touring models.	<b>\$259.95</b>
<b>94949-07</b>	Bike Kit. Fits '99-'08 Touring models.	<b>\$249.95</b>
<b>94946-07</b>	Bike Kit. Fits '04-later XL models.	<b>\$184.95</b>
<b>94943-07</b>	Engine Kit. Fits Twin Cam-equipped models.	<b>\$109.95</b>
<b>94944-07</b>	Engine Kit. Fits '04-later XL models.	<b>\$94.95</b>



A. CLASSIC COVERS KIT

### Classic Covers Kit Contents

Intended Fastener	Part Number	Bike Kit	Bike Kit	Bike Kit	Bike Kit	Bike Kit	Bike Kit	Bike Kit	Bike Kit	Engine Kit	Engine Kit
		'04-later Sportster®	'99-later Dyna®	'09-later FXCWC	'09-later FLSTSB	'09-later Softail®	'00-'08 Softail	'09-later Touring	'99-'08 Touring	'04-later Sportster	Twin Cam-models
		<b>94946-07</b>	<b>94947-07</b>	<b>94921-09</b>	<b>94922-09</b>	<b>94923-09</b>	<b>94948-07</b>	<b>94924-09</b>	<b>94949-07</b>	<b>94944-07</b>	<b>94943-07</b>
1/4" socket head cap screw	<b>94903-07</b>	56	56	50	50	50	50	55	50	56	50
5/16" socket head cap screw	<b>94904-07</b>	11	11	7	6	11	11	8	7	—	7
5/16" socket head cap screw (plug)	<b>94905-07</b>	5	8	—	5	4	8	—	—	—	—
3/8" socket head cap screw	<b>94906-07</b>	3	6	5	7	6	12	3	3	3	3
5/16" special hex screw (angled cap)	<b>94907-07</b>	—	8	8	8	8	8	8	8	—	8
5/16" T40 Torx button head screw	<b>94908-07</b>	—	5	5	5	5	5	10	10	—	—
3/8" T45 Torx button head screw	<b>94909-07</b>	—	5	5	5	5	5	—	—	—	—
1/4" 12-point screw	<b>94910-07</b>	—	4	—	—	—	4	—	4	—	—
10mm 12-point screw	<b>94911-07</b>	4	8	7	2	5	8	4	8	—	—
1/2" flanged hex bolt	<b>94912-07</b>	1	—	1	1	1	1	2	—	—	—
3/8" T45 Torx button head screw	<b>94913-07</b>	4	4	—	10	10	18	2	—	—	—
7/16" hex bolt	<b>94914-07</b>	5	5	5	5	5	5	—	—	—	—
3/8" hex bolt (9/16" hex)	<b>94915-07</b>	1	11	2	—	1	11	—	16	—	3
3/8" deep hex bolt (9/16" hex)	<b>94916-07</b>	2	6	—	—	—	6	—	—	—	—
1/4" hex bolt (7/16" hex)	<b>94917-07</b>	—	1	—	2	—	—	14	14	—	—
5/16" hex bolt (1/2" hex)	<b>94918-07</b>	8	10	4	4	4	12	10	16	4	8
1/2" hex bolt	<b>94919-07</b>	2	2	4	4	4	4	—	—	—	—
1/2" deep hex bolt	<b>94920-07</b>	—	—	1	1	1	1	—	—	—	—
7/16" hex bolt	<b>94941-07</b>	3	—	—	—	—	—	—	3	—	—
5/16" T40 Torx button head screw	<b>94942-07</b>	4	6	1	1	4	6	—	9	—	—

Notice: The prices appearing in this catalog are the manufacturer's suggested retail prices. Actual retail prices may vary.



# ENGINE TRIM 543

Hardware Covers



NEW

B

**B. REAR DOCKING HARDWARE COVER KIT – BLACK**

## B. REAR DOCKING HARDWARE COVER KIT

Disguise the rear docking hardware with these easy-to-install covers. The caps slide over the exposed docking points, and are held in place by a strong magnetic pull. The caps are easy to remove when you wish to reinstall detachable accessories. Covers are available with brilliant Chrome or durable Gloss Black finish to match your bike's attitude (*sold in pairs*).

Fits many accessory docking hardware kits. Refer to the fitment matrix in the P&A Retail Catalog or the Parts & Accessories section of [www.harley-davidson.com](http://www.harley-davidson.com) for details.

<b>48218-10</b>	Short Chrome ( <i>pair</i> ).	<b>\$24.95</b>
<b>48220-10</b>	Large Chrome ( <i>pair</i> ).	<b>\$24.95</b>
<b>48035-09</b>	Small Chrome ( <i>pair</i> ).	<b>\$24.95</b>
<b>48221-10</b>	Short Black ( <i>pair</i> ).	<b>\$24.95</b>
<b>48223-10</b>	Large Black ( <i>pair</i> ).	<b>\$24.95</b>
<b>48225-10</b>	Small Black ( <i>pair</i> ).	<b>\$24.95</b>



NEW

B

**B. REAR DOCKING HARDWARE COVER KIT – CHROME**



Short Chrome



Large Chrome



Small Chrome



Short Black



Large Black



Small Black

Docking Kit Part Number	Fitment	Large Chrome: <b>48220-10</b>		Small Chrome: <b>48035-09</b>		Short Chrome: <b>48218-10</b>		
		Black: <b>48223-10</b>		Black: <b>48225-10</b>		Black: <b>48221-10</b>		
<b>XL Models</b>								
<b>53529-04</b>	Fits '04-later XL (some black) models.		-		1		1	
<b>53528-95B</b>	Fits '94-'03 XL (without bags) models.		1		1		-	
<b>53532-02</b>	Fits '02-'03 XL (with bags) models.		1		-		-	
<b>90465-98A</b>	Fits '94-'01 XL (with bags) models.		1		-		-	
<b>Dyna Models</b>								
<b>53961-06</b>	Fits '06-later Dyna (FXD/L) models.		-		1		1	
<b>53964-06A</b>	Fits '08-later FXDF/SE/2 and '06-'08 FXDWG models.		-		1		1	
<b>54097-10</b>	Fits '10 FXDWG (black) models.		-		1		1	
<b>53797-09</b>	Fits '09-later FXDB (black) models.		-		1		1	
<b>53533-02A</b>	Fits '02-'05 Dyna models.		1		-		-	
<b>53882-02A</b>	Fits '02-'05 FXDWG and '01-'02 FXDWG2/3 models.		1		-		-	
<b>53858-01</b>	Fits '96-'01 FXDWG (except FXDWG2) models.		1		-		-	
<b>53527-95A</b>	Fits '96-'01 Dyna models.		1		-		-	
<b>Softail Models</b>								
<b>53932-03</b>	Fits '03-later Softail (without bags) models.		1		1		-	
<b>54265-10</b>	Fits '10 FLSTFB (black) models. <b>OBSOLETE</b>		1		1		-	
<b>53824-00</b>	Fits '00-'02 Softail (without bags) models.		1		1		-	
<b>53531-95A</b>	Fits '84-'95 Softail models.		1		1		-	
<b>Touring Models</b>								
<b>54205-09</b>	Fits '09-later Touring (4pt) chrome models.		-		2		-	
<b>54246-09</b>	Fits '09-later Touring (4pt) black models.		-		2		-	
<b>54030-09</b>	Fits '09-later Touring (2pt) chrome models.		-		1		-	
<b>54249-09</b>	Fits '09-later Touring (2pt) black models.		-		1		-	
<b>53803-06</b>	Fits '97-'08 Touring (front) models.		-		1		-	
<b>53804-06</b>	Fits '94-'08 Touring (rear) models.		1		1		-	
<b>53988-07</b>	Fits '07-'08 FLHRSE3/4 models.		-		1		1	

Notice: The prices appearing in this catalog are the manufacturer's suggested retail prices. Actual retail prices may vary.

ENGINE TRIM

# 544 ENGINE TRIM

Hardware Covers & Chrome Hardware

## A. CLASSIC CHROME SOCKET HEAD SCREW COVER KIT

Finish the show-winning look with these easy-to-install hardware covers. These machined brass and chrome-plated covers are corrosion resistant, and the internal spring steel retention clip resists vibration and thermal cycling to securely hold the covers in place.

<b>94830-02</b>		<b>\$34.95</b>
Fits 1/4" socket head screws with hex drive (Pkg. of 10).		
<b>94832-02</b>		<b>\$15.95</b>
Fits 5/16" socket head screws with hex drive (Pkg. of 4).		
<b>94834-02</b>		<b>\$15.95</b>
Fits 3/8" socket head screws with hex drive (Pkg. of 4).		
<b>94046-03</b>		<b>\$36.95</b>
Fits M6 metric socket head screws with hex drive (Pkg. of 10).		

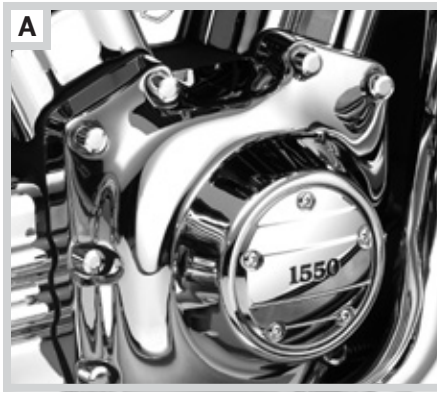

A. CLASSIC CHROME SOCKET HEAD SCREW COVER KIT



B. CLASSIC CHROME HEX BOLT COVERS

## B. CLASSIC CHROME HEX BOLT COVERS

Place over a variety of exposed bolts for a cleaner, detailed look. Compression clips for a secure fit. Sold in packages of 6 covers with retaining clips.

<b>43881-96</b>	Fits 1/2" hex bolts.	<b>\$14.95</b>
<b>43850-96</b>	Fits 9/16" hex bolts.	<b>\$14.95</b>

## C. CHROME ALLEN HOLE PLUG KITS

Made in the U.S.A. See your Dealer for more information about the complete line of chrome hardware.

<b>94130-93T</b>	1/4" (Pkg. of 10).	<b>\$5.99</b>
<b>94131-93T</b>	5/16" (Pkg. of 10).	<b>\$5.99</b>
<b>94132-93T</b>	3/8" (Pkg. of 10).	<b>\$5.99</b>



C. CHROME ALLEN HOLE PLUG KITS

## D. CHROME "H-D MOTOR CO." LOGO ALLEN HOLE PLUGS

<b>94527-95</b>	1/4-inch (Pkg. of 10).	<b>\$8.95</b>
<b>94529-95</b>	5/16-inch (Pkg. of 10).	<b>\$8.95</b>
<b>94531-95</b>	3/8-inch (Pkg. of 10).	<b>\$8.95</b>



D. CHROME H-D MOTOR CO. LOGO ALLEN HOLE PLUGS

## E. CHROME DOME HEX NUTS

Update the custom look with Chrome Dome hardware. These uniquely styled hex nuts bring a new look to the traditional acorn shape, and feature a low-profile design and a smooth chrome finish.

<b>8067</b>	7/16" – 20 thread. (Pkg. of 10).	<b>\$19.20</b>
<b>8066</b>	7/16" – 14 thread. (Pkg. of 10).	<b>\$19.20</b>
<b>8065</b>	3/8" – 24 thread. (Pkg. of 10).	<b>\$16.30</b>
<b>8064</b>	3/8" – 16 thread. (Pkg. of 10).	<b>\$16.30</b>
<b>8063</b>	5/16" – 24 thread. (Pkg. of 10).	<b>\$14.40</b>
<b>8062</b>	5/16" – 18 thread. (Pkg. of 10).	<b>\$14.40</b>
<b>8061</b>	1/4" – 28 thread. (Pkg. of 10).	<b>\$13.00</b>
<b>8060</b>	1/4" – 20 thread. (Pkg. of 10).	<b>\$13.00</b>
<b>8071</b>	10 – 24 thread. (Pkg. of 10).	<b>\$12.50</b>
<b>8072</b>	10 – 32 thread. (Pkg. of 10).	<b>\$12.50</b>
<b>8073</b>	1/2" – 13 thread. (Pkg. of 5).	<b>\$14.10</b>
<b>8074</b>	1/2" – 20 thread. (Pkg. of 5).	<b>\$14.10</b>



E. CHROME DOME HEX NUTS



E. CHROME DOME HEX NUTS

## F. CHROME TIMER COVER SCREW KITS

Dress up accessory timer covers by replacing the stock zinc plate screws with brilliant chrome.

<b>32690-99A</b>	Fits Twin Cam 5-hole timer covers. Kit contains five chrome-plated button head Torx® screws.	<b>\$11.95</b>
<b>94208-04</b>	Fits '04-later XL models.	<b>\$5.95</b>



F. CHROME TIMER COVER SCREW KIT – TWIN CAM SHOWN

## G. CHROME DERBY COVER SCREW KIT

Dress up accessory derby covers by replacing the stock zinc-plated screws with brilliant chrome.

<b>25913-99</b>	Fits '99-later Dyna®, Softail® and Touring models. Kit contains five chrome-plated button head Torx screws and five stainless steel washers.	<b>\$13.95</b>
<b>94630-98</b>	Fits 1340 Evolution® models. Kit includes three button head Torx screws and oil seals.	<b>\$12.45</b>
<b>94631-98</b>	Fits '94-'03 XL models.	<b>\$7.95</b>
<b>94207-04</b>	Fits '04-later XL models.	<b>\$15.95</b>



G. CHROME DERBY COVER SCREW KIT – TWIN CAM SHOWN

Notice: The prices appearing in this catalog are the manufacturer's suggested retail prices. Actual retail prices may vary.



**H. CHROME HARDWARE KIT – PRIMARY COVER (TOURING SHOWN)**



**I. CHROME HARDWARE KIT – PRIMARY COVER (SOFTAIL SHOWN)**



**J. CHROME HARDWARE KIT – ROCKER BOX (BIG TWIN SHOWN)**

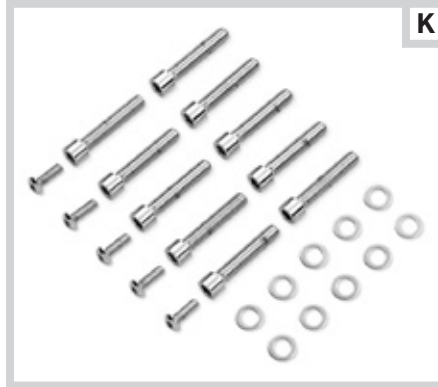

**K. CHROME HARDWARE KIT – CAM COVER**



**L. CHROME HARDWARE KIT – LIFTER BLOCK (BIG TWIN SHOWN)**



**M. CHROME HARDWARE KIT – GEARCASE/FRONT SPROCKET COVER (XL SHOWN)**



**N. CHROME AIR CLEANER SCREW**



**O. XL AIR CLEANER SCREW KIT**

**H. CHROME HARDWARE KIT – PRIMARY COVER**

Kit includes chrome washers, button head and smooth socket head screws made to Harley-Davidson specifications. Kit includes the hardware required to replace the visible set of zinc-plated fasteners on the outer primary cover. Inspection and derby cover hardware included. Lock patch included where required.

**94053-03A** Fits '99-'05 Dyna® models and '00-'06 Softail® models. **\$59.95**

**94052-03A** Fits '99-'06 Touring models. **\$59.95**

**60801-06** Fits '06-later Dyna and '07-later Softail models (except FXCW/C and FXSTSSE3). **\$59.95**

**94052-07** Fits '07-later Touring models. **\$59.95**

**60607-08** Fits '08-later FXCW/C and FXSTSSE3 models. **\$59.95**

**94281-04** Fits '04-later XL models. **\$59.95**

**I. CHROME HARDWARE KIT – TRANSMISSION**

Kit includes chrome washers and smooth socket head screws made to Harley-Davidson specifications. Kit includes the hardware required to replace the visible set of zinc-plated fasteners on the transmission top cover, bearing housing assembly and clutch release cover. Lock patch included where required.

**94056-03** Fits '99-'05 Dyna models. **\$54.95**

**94055-03** Fits '00-'06 Softail models. **\$54.95**

**94054-03** Fits '99-'06 Touring models. **\$54.95**

**34856-06A** Fits '06-later Dyna and '07-later Softail and Touring models (except Trike). **\$54.95**

**J. CHROME HARDWARE KIT – ROCKER BOX**

Kit includes chrome washers, and smooth socket head screws made to Harley-Davidson specifications. Kit includes the hardware required to replace the visible set of zinc-plated fasteners on rocker box covers. Lock patch included where required.

**94059-03** Fits '99-later Dyna, '99-'07 Touring models and '00-later Softail models. **\$34.95**

**94291-04A** Fits '04-later XL models. **\$34.95**

**K. CHROME HARDWARE KIT – CAM COVER**

Kit includes chrome washers, button head and smooth socket head screws made to Harley-Davidson specifications. Kit includes the hardware required to replace the visible set of zinc-plated fasteners on the cam cover. Cam position sensor cover hardware included. Lock patch included where required.

**94058-03** Fits '99-later Dyna® and Touring models and '00-later Softail® models. **\$32.95**

**L. CHROME HARDWARE KIT – LIFTER/TAPPET BLOCK**

Kit includes chrome washers and smooth socket head screws made to Harley-Davidson specifications. Kit includes the hardware required to replace the visible set of zinc-plated fasteners on lifter block covers. Lock patch included where required.

**94068-03** Fits '99-later Dyna and Touring models and '00-later Softail models. **\$20.95**

**M. CHROME HARDWARE KIT – GEARCASE/FRONT SPROCKET COVER**

Kit includes smooth socket head screws and washers, and button head timer cover screws made to Harley-Davidson specifications. Kit includes the hardware required to replace the visible set of zinc-plated fasteners on the gearcase and front sprocket cover. Lock patch included where required.

**94280-04** Fits '04-later XL models. **\$42.95**

**N. CHROME AIR CLEANER SCREW**

Complete the chrome on your stock air cleaner cover with this chrome-plated stainless steel screw, which easily replaces the polished stock air cleaner screw.

**29600-00** Fits stock Twin Cam engines. **\$4.95**

**29703-00** Fits stock Evolution® 1340 engines. **\$4.95**

**O. XL AIR CLEANER SCREW KIT**

**29351-95** Fits '85-'03 XL models. **\$5.85**

Notice: The prices appearing in this catalog are the manufacturer's suggested retail prices. Actual retail prices may vary.

# 546 ENGINE TRIM

## Chrome Hardware

### A. SWITCH HOUSING HARDWARE KIT

Complete the chrome conversion with this Chrome Hardware Kit. Chrome-plated stainless steel hardware replaces the Original Equipment black hardware on the hand control switch housing, clutch and brake bracket clamps.

**91124-03A** **\$17.95**  
Fits '96-later models (except '04-later XL and XR).

### B. CHROME SCREWS FOR FLST SEAT BRACKET

**94289-94T** **\$9.95**  
Fits '87-'99 FLSTC, FLSTF and FLSTN models.

### C. WINDSHIELD ACORN NUT KIT

Kit contains 10 low crown 12-24 acorn nuts.

**94111-95** **\$7.95**  
Fits Compact, King-Size, Convertible and Road King® windshields. (Pkg. of 10.)

### D. CHROME ACORN NUT KITS

<b>94115-93T</b>	10 – 24 thread. (Pkg. of 5).	<b>\$4.95</b>
<b>94116-93T</b>	10 – 32 thread. (Pkg. of 5).	<b>\$4.95</b>
<b>94117-93T</b>	1/4" – 20 thread. (Pkg. of 5).	<b>\$4.95</b>
<b>94118-93T</b>	1/4" – 28 thread. (Pkg. of 5).	<b>\$4.95</b>
<b>94119-93T</b>	5/16" – 18 thread. (Pkg. of 4).	<b>\$4.95</b>
<b>94120-93T</b>	5/16" – 24 thread. (Pkg. of 4).	<b>\$4.95</b>
<b>94121-93T</b>	3/8" – 16 thread. (Pkg. of 3).	<b>\$4.95</b>
<b>94122-93T</b>	3/8" – 24 thread. (Pkg. of 3).	<b>\$4.95</b>
<b>94123-93T</b>	7/16" – 14 thread. (Pkg. of 2).	<b>\$4.95</b>
<b>94124-93T</b>	7/16" – 20 thread. (Pkg. of 2).	<b>\$4.95</b>
<b>94125-93T</b>	1/2" – 13 thread. (Pkg. of 1).	<b>\$4.95</b>
<b>94126-93T</b>	1/2" – 20 thread. (Pkg. of 1).	<b>\$4.95</b>
<b>94127-93T</b>	5/8" – 18 thread. (Pkg. of 1).	<b>\$4.95</b>

### E. CHROME TORX® BUTTON HEAD SCREWS

Available in 1/4-inch, 5/16-inch and 3/8-inch coarse thread, up to 2-1/4 inches long. Grade 8. See your Dealer for more information.

### F. CHROME HEX SOCKET BUTTON HEAD SCREWS

Available in 8-32, 10-24, 10-32, 1/4-inch, 5/16-inch and 3/8-inch, up to 1 inch long. See your Dealer for more information.

### G. CHROME TORX SOCKET HEAD SCREWS

Available in 1/4-inch, 5/16-inch and 3/8-inch coarse thread, up to 2-1/4 inches long. Grade 8. See your Dealer for more information.

### H. CHROME SOCKET HEAD SCREWS

Available in 1/4-inch, 5/16-inch and 3/8-inch coarse and fine thread, up to 3 inches long. See your Dealer for more information.



A. SWITCH HOUSING HARDWARE KIT



B. CHROME SCREWS FOR FLST SEAT BRACKET



C. WINDSHIELD ACORN NUT KIT



D. CHROME ACORN NUT KITS



E. CHROME TORX BUTTON HEAD SCREWS



F. CHROME HEX SOCKET BUTTON HEAD SCREWS



G. CHROME TORX SOCKET HEAD SCREWS



H. CHROME SOCKET HEAD SCREWS

*Notice: The prices appearing in this catalog are the manufacturer's suggested retail prices. Actual retail prices may vary.*





**I. CHROME SMOOTH SOCKET HEAD SCREWS**



**J. CHROME HEX HEAD SCREWS**

**I. CHROME SMOOTH SOCKET HEAD SCREWS**

Available in 1/4-inch, 5/16-inch and 3/8-inch coarse and fine thread, up to 3 inches long. See your Dealer for more information.

**J. CHROME HEX HEAD SCREWS**

Available in 1/4-inch, 5/16-inch and 3/8-inch coarse and fine thread, up to 3 inches long. See your Dealer for more information.

**K. CHROME 12-POINT SCREWS**

Available in 1/4-inch, 5/16-inch and 3/8-inch coarse thread, up to 2-1/4 inches long. Grade 8. See your Dealer for more information.

**L. CHROME FLAT-HEAD SCREWS**

When the details matter, even your screws are chromed. These Grade 8 Hex Drive screws are available in 17 different sizes. See your Dealer for more information.



**K. CHROME 12-POINT SCREWS**



**L. CHROME FLAT-HEAD SCREWS**

**M. CHROME LOCK NUTS WITH NYLON INSERTS**

Available in 10-24, 1/4-inch, 5/16-inch, 3/8-inch, 7/16-inch and 5/8-inch sizes, coarse and fine thread. See your Dealer for more information.

**N. CHROME HEX NUTS**

Available in 1/4-inch, 5/16-inch and 3/8-inch sizes, coarse and fine thread. See your Dealer for more information.

**O. CHROME FLAT WASHERS**

Available in 1/4-inch, 5/16-inch and 3/8-inch sizes. See your Dealer for more information.

**P. CHROME LOCK WASHERS**

Available in 1/4-inch, 5/16-inch and 3/8-inch sizes. See your Dealer for more information.



**M. CHROME LOCK NUTS WITH NYLON INSERTS**



**N. CHROME HEX NUTS**



**O. CHROME FLAT WASHERS**



**P. CHROME LOCK WASHERS**

Notice: The prices appearing in this catalog are the manufacturer's suggested retail prices. Actual retail prices may vary.

# HAND CONTROLS

*Your style fingerprints are all over your bike. Now put them where they count. Custom hand and foot controls, mirrors, and handlebars set the tone in comfort and attitude. Start by selecting a handlebar from a full range of shapes and sizes. Add proper control cables and finish it with chrome or black grips and pegs.*

## PICK A DIRECTION

### SINISTER LOOKS

*Build on the factory satin black controls by adding black levers, mirrors and custom grips. And because all the black finishes match, the controls look like they were machined from a single piece.*



### SIMPLE STYLE

*Adding chrome mirrors, grips and a master cylinder cover gives instant gratification. To take your customizing further, add chrome switch caps, a set of chrome switch housings and braided lines and cables.*



## HANG 'EM HIGH OR LOW

*Where a handlebar positions your hands, wrists, arms, shoulders and back are all key factors to keep in mind when searching for the right fit. The three key elements to any handlebar are rise, width and pullback. Every rider requires a special combination, so choose wisely.*

*For a complete selection of handlebar options, see pages 576-597.*

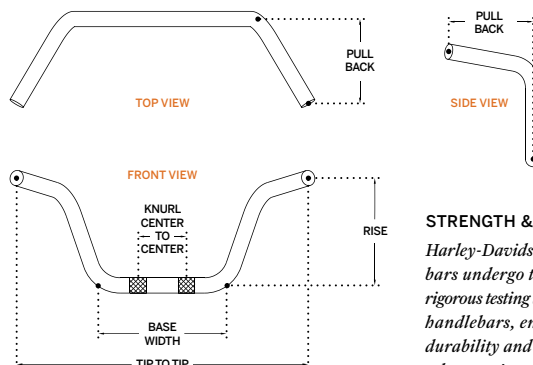

**STRENGTH & QUALITY**  
*Harley-Davidson® accessory bars undergo the same rigorous testing as our factory handlebars, ensuring durability and control that others can't match.*

### YOUR RIDING POSITION



#### STOCK HANDLEBAR

*Just about every model of Harley-Davidson® motorcycle comes with a different stock handlebar. Selected to complement the style of the bike, the handlebar may be the ideal shape for many riders, but of course, not everyone has the same physical characteristics.*



#### STOCK HANDLEBAR WITH RISERS

*If the stock handlebar has the correct width and hand position for you, but seems just a little too far away, we offer riser kits that can bring the controls within reach. Straight and curved risers are available for many model and handlebar combinations.*



#### DRAG HANDLEBAR

*Narrow, flat and more aggressive, drag bars provide a straight elbow and neutral hand and wrist position. For maximum comfort, drag bars can be positioned with curved or straight risers to minimize stretch to the controls.*



#### APE HANGER & TALLBOY® BARS

*Tall and wide, ape hanger and Tallboy® handlebars provide a classic "fist-in-the-wind" look, and can add long-haul comfort for riders with long arms. Because handlebar height is regulated in many areas, check local laws before installing a tall handlebar.*



#### WIDE BEACH BAR

*Low and wide, a beach bar spreads your arms and gives you room to breathe. Ideal for the rider with long arms, beach bars can be a little too wide for many riders. While selecting a bar, make sure you can reach the hand controls when the handlebar is fully turned.*



#### NARROW BEACH BAR

*Not up for the wide grip? This handlebar combines the low-rise and sweeping shape of a beach bar with a narrower tip-to-tip width for added rider control. And when combined with pullback risers, this might be an ideal compromise between comfort and style.*

\*NOTE: Installation of some handlebars and risers may require a change in clutch and/or throttle cable and brake hose for some models. Handlebar height is regulated in many states. Check state or local laws before installation.

# 550 CONTROLS

## Heated Hand Grips

### HEATED HAND GRIPS

Keep comfortable on those cool morning or frigid night rides. Warm hands have a major impact on overall body comfort, and sometimes gloves just aren't enough. These thermostatically controlled grips have variable heat settings and automatic temperature monitoring to adjust to changing ambient temperatures. The grips remain at a constant temperature regardless of changes in outside temperatures. The self-contained control circuit and control knob means you have no additional switches or controller boxes to mount, and the grips are switched on/off with the ignition to avoid draining your battery. The "glueless" grip design allows grip removal if you change handlebars or motorcycles.

### A. CONTOURED CHROME AND RUBBER CUSTOM HEATED HAND GRIPS

**56512-02C** **\$219.95**

Fits '96-later XL, XR, Dyna®, Softail®, VRSC™ and '96-'07 Touring models. Not compatible with internally wired handlebars.

**56512-08A** **\$229.95**

Fits '08-later Touring models. Not compatible with internally wired handlebars.

### B. FLAME HEATED HAND GRIPS

**56047-03C** **\$249.95**

Fits '96-later XL, XR, Dyna, Softail, VRSC and '96-'07 Touring models. Not compatible with internally wired handlebars.

**56047-08A** **\$259.95**

Fits '08-later Touring models. Not compatible with internally wired handlebars.



A. HEATED HAND GRIPS (CONTOURED CHROME AND RUBBER SHOWN)



A. CONTOURED CHROME AND RUBBER CUSTOM HEATED HAND GRIPS



B. FLAME HEATED HAND GRIPS

*Notice: The prices appearing in this catalog are the manufacturer's suggested retail prices. Actual retail prices may vary.*



# CONTROLS 551

Heated Hand Grips



C

**C. WILLIE G. SKULL COLLECTION HEATED HAND GRIPS**



D

**D. AILERON HEATED HAND GRIPS**



E

**E. IRONSIDE HEATED HAND GRIPS**



F

**F. CHROME AND RUBBER HEATED HAND GRIPS - SMALL DIAMETER**



G

**G. NOSTALGIC HEATED HAND GRIPS**



H

**H. STEALTH HEATED HAND GRIPS**

**C. WILLIE G. SKULL COLLECTION HEATED HAND GRIPS**

**56926-05A** **\$249.95**  
Fits '96-later XL, XR, Dyna®, Softail®, VRSC™ and '96-'07 Touring models. Not compatible with internally wired handlebars.

**56926-08A** **\$259.95**  
Fits '08-later Touring models. Not compatible with internally wired handlebars.

**D. AILERON HEATED HAND GRIPS**

**56828-03B** **\$249.95**  
Fits '96-later XL, XR, Dyna, Softail, VRSC and '96-'07 Touring models. Not compatible with internally wired handlebars.

**56828-08A** **\$259.95**  
Fits '08-later Touring models. Not compatible with internally wired handlebars.

**E. IRONSIDE HEATED HAND GRIPS**

**56997-07A** **\$249.95**  
Fits '96-later XL, XR, Dyna, Softail, VRSC and '96-'07 Touring models. Not compatible with internally wired handlebars.

**56049-08A** **\$259.95**  
Fits '08-later Touring models. Not compatible with internally wired handlebars.

**F. CHROME AND RUBBER HEATED HAND GRIPS**

**56196-03C** Small Diameter. **\$229.95**  
Fits '96-later XL, XR, Dyna®, Softail®, VRSC™ and '96-'07 Touring models. Not compatible with internally wired handlebars.

**56196-08A** Small Diameter. **\$239.95**  
Fits '08-later Touring models. Not compatible with internally wired handlebars.

**56174-03C** Large Diameter. (not shown) **\$229.95**  
Fits '96-later XL, XR, Dyna, Softail, VRSC and '96-'07 Touring models. Not compatible with internally wired handlebars.

**G. NOSTALGIC HEATED HAND GRIPS**

**56619-03B** **\$219.95**  
Fits '96-later XL, XR, Dyna, Softail, VRSC and '96-'07 Touring models. Not compatible with internally wired handlebars.

**H. STEALTH HEATED HAND GRIPS**

**56750-04B** **\$229.95**  
Fits '96-later XL, XR, Dyna, Softail, VRSC and '96-'07 Touring models. Not compatible with internally wired handlebars.

Notice: The prices appearing in this catalog are the manufacturer's suggested retail prices. Actual retail prices may vary.

# 552 CONTROLS

## Hand Grips

### A. STITCHED HAND GRIPS

Combine the style of braided leather with the comfort and secure grip of rubber. Designed to echo the feel of a hand-tied leather-wrapped grip, the thick black molded rubber surface is deeply embossed with a double-laced braid pattern. The rubber surface provides a sure grip in the sun or the rain, and the highly styled chrome base and end cap add a custom touch to your hand controls.

**56757-05** Medium 1.5" Diameter. **\$59.95**  
Fits '96-later XL, XR, Dyna®, Softail®, VRSC™ and '96-'07 Touring models.

### B. "LIVE TO RIDE" LOGO HAND GRIPS

These comfortable, yet stylish grips are available in black and in your choice of gold or chrome "Live To Ride" logo. Kit includes adhesive required for installation.

Fits '96-later XL, XR, Dyna, Softail, VRSC and '96-'07 Touring models.

**56210-94T** Black with Gold. **\$54.95**  
**56217-94T** Black with Chrome. **\$45.95**

### C. SPORTSTER® COLLECTION – CONTOURED CHROME AND RUBBER HAND GRIPS

The Sportster® Collection from Harley-Davidson adds depth and shadows to your custom ride. The layered design is formed from die-cast aluminum, polished, and chrome-plated to a mirror-finish. The bold "Sportster" script is filled with black for a distinctive contrast. These small diameter (1.3") Contoured Chrome and Rubber Hand Grips combine the classic hour-glass shape for comfort with a black molded rubber surface for grip. Chrome end caps feature the "Sportster" script.

**56735-04** Fits '96-later XL and XR models. **\$49.95**

### D. BUCKSHOT HAND GRIPS

Styled to complement the Buckshot Hand and Foot Control Collection. The mirror chrome outer grip features deep grooves perforated by rows of counterbored holes to expose the black surface below. "Gloless" design permits easy installation and removal without damage.

~~**56904-06** **\$69.95**~~  
~~Fits '96-later XL, XR, Dyna, Softail, VRSC and '96-'07 Touring models.~~

**OBSOLETE**

### E. BLACK CUSHION HAND GRIPS

Includes plastic throttle sleeve/grip assembly for easier installation and adhesive for left grip installation. These custom Cushion Grips include etched Bar & Shield logos and are available in black with chrome end caps. Kit includes adhesive required for installation.

**56006-88C** **\$49.95**  
Fits '82-later XL, XR, Dyna, Softail, VRSC and '00-'07 Touring models.

### F. "H-D MOTOR CO." LOGO HAND GRIPS

Black textured grips, die-cast with black-lettered "H-D Motor Co." logo. Kit includes adhesive required for installation.

**56285-98** **\$45.95**  
Fits '82-later XL, XR, Dyna, Softail, VRSC and '00-'07 Touring models.

### G. HAND GRIP DECORATIVE END CAPS

Throw some attitude onto your Smooth Leather, Custom Print Leather or Chrome and Rubber Horizontal Hand Grips. These easy-to-install caps replace the originals and take customization to a whole new level.

Fits Contoured Chrome and Rubber Custom Hand Grips P/N 56459-01A, Chrome and Rubber Horizontal Hand Grips P/Ns 56246-96A, 56263-96A, 56241-96 and 56258-96, Flame Hand Grips P/N 56518-02, Diamond Plate Hand Grips P/N 55618-04, 56688-04 and Smooth Leather Hand Grips P/N 56197-98A.

**56676-02** Flame End Cap. (pair) **\$19.95**  
**56658-00** Skull End Cap. (pair) **\$19.95**



A. STITCHED HAND GRIPS



B. "LIVE TO RIDE" LOGO HAND GRIPS – BLACK WITH GOLD



C. SPORTSTER COLLECTION – CONTOURED CHROME AND RUBBER HAND GRIPS



D. BUCKSHOT HAND GRIPS



E. BLACK CUSHION HAND GRIPS



F. "H-D MOTOR CO." LOGO HAND GRIPS



G. HAND GRIP DECORATIVE END CAPS – FLAME



G. HAND GRIP DECORATIVE END CAPS – SKULL

Notice: The prices appearing in this catalog are the manufacturer's suggested retail prices. Actual retail prices may vary.



NEW

H

H. TRIBAL HAND GRIPS

## H. TRIBAL COLLECTION

Tribal art adds an element of ancient mystery, with a monochrome palette and simple lines that transform into a totem meant to be worn proudly. The design features smooth black rubber surfaces that rise above the cast-in recesses of the jet black shell, adding depth and dimension to the collection.

### Hand Grips

The easy-to-install hand grips are a comfortable 1.5" diameter, and feature a "glueless" design that can be removed for service without damage.

**56254-09** **\$89.95**

Fits '96-later VRSC™, XL, XR, Dyna®, Softail® and '96-'07 Touring models.

**56257-09** **\$89.95**

Fits '08-later Touring models.

### Shifter Peg

The easy-to-install shifter peg's position is adjustable for comfort, and the rubber backing protects the toe of your boot from scuffing during shifting.

**34669-09A** **\$29.95**

Fits all models (except '06-later VRSC models with forward controls and '08-later XR models).

### Footpegs

Footpeg rotation is adjustable for position, so your feet ride on the rubber pad whether used as a rider, passenger, or highway peg. Kit includes left and right peg.

**51376-09** **\$69.95**

Fits models with H-D® male mount style footpeg supports (except the rider position on '07-later XL883L, XL883N, XL1200N, '08-later XR, '08-later FXCW/C, and '02-later VRSC models).

### Brake Pedal Pads

This easy-to-install Brake Pedal Pad complements the Tribal Collection for a complete custom look.

**42008-09** Small **\$39.95**

Fits '84-later FX Softail (except FXSTDSE) and '96-later FXDWG models.

**42560-09** Large **\$39.95**

Fits '80-later Touring models and '86-later FL Softail models.



NEW

H

H. TRIBAL FOOTPEGS AND SHIFTER PEG



NEW

H

H. TRIBAL BRAKE PEDAL PADS



NEW

I

I. SILENCER HAND GRIPS

## I. THE SILENCER COLLECTION

Make your own noise. Unique electroless nickel plating provides this collection with a warm, burnished finish that looks like you've been twisting this throttle for years. The warm look of the nickel will complement both bright and satin paint colors, and looks right when paired with the black Original Equipment hand controls. The precision drilled surfaces bite against the palm of your glove and boot sole for positive grip, and provide the gun barrel look.

### Hand Grips

Hand Grips are a comfortable 1.4" diameter for a compact custom look, and the "glueless" design allows easy removal for service without damage.

**55869-10** **\$79.95**

Fits '96-later VRSC, XL, XR, Dyna, Softail and '96-'07 Touring models.

### Footpegs and Shifter Peg

These small-diameter Footpegs offer the ideal pivot point to operate the brake and shift levers, and the wide surface provides room to rest your boot.

**50056-10** Footpeg **\$79.95**

Fits models with H-D® male mount style footpeg supports (except the rider position on '07-later XL883L, XL883N, XL1200N, '08-later XR, and '08-later FXCW/C models).

**50039-10** Footpeg with Wear Peg **\$79.95**

Fits '07-later XL883L, XL883N, XL1200N and '08-later XR models.

**35286-10** Shifter Peg **\$18.95**

Fits all models (except '06-later VRSC models with forward controls, and XR models).

### Brake Pedal Pad

The easy-to-install compact brake pedal pad completes the custom Silencer look. Includes mounting hardware.

**48990-10** Small **\$29.95**

Fits '84-later FX Softail models (except FXSTDSE) and '93-later Dyna models equipped with Forward Controls.



NEW

I

I. SILENCER FOOTPEGS AND SHIFTER PEG



NEW

I

I. SILENCER BRAKE PEDAL PAD

# 554 CONTROLS

## Hand Grips & Foot Controls

### THE DIAMOND BLACK COLLECTION

Shroud your bike in mystery. This blacked-out hand and foot control collection features distinctive knurled surfaces that expose the raw billet aluminum for a dramatic contrast. Designed to age and "break-in" like a pair of comfortable stone-washed jeans, the satin black finish will complement both high-gloss and "denim" paint colors. The narrow rubber bands and the knurled surfaces provide a positive grip.

#### A. DIAMOND BLACK HAND GRIPS

Hand grips are a comfortable 1.5" diameter, and feature "glue-less" installation that can be easily removed for service without damage.

**56405-08** \$69.95

Fits '96-later XL, XR, Dyna®, Softail®, VRSC™, and '97-'07 Touring models.

**56746-08** \$79.95

Fits '08-later Touring models.

#### B. DIAMOND BLACK FOOTPEGS AND SHIFTER PEG

The slim footpeg design allows a comfortable pivot point, and the wide surface and large diameter end cap keep your boot in place.

**1. 50113-10** Footpegs – Large Diameter. \$84.95

Fits models with H-D® male mount style footpeg supports (except the rider position on '07-later XL883L, XL883N, XL1200N, '08-later XR, and '08-later FXCW/C models). (pair)

**2. 50911-08** Footpegs – Small Diameter. \$79.95

Fits models with H-D male mount style footpeg supports (except the rider position on '07-later XL883L, XL883N, XL1200N, XR, '08-later FXDB, FXDF, FXCW/C, and '02-later VRSC models). (pair)

**3. 34690-08** Shifter Peg. \$18.95

Fits all models (except '06-later VRSC models with forward controls and XR models).

#### C. DIAMOND BLACK FOOTPEG WITH WEAR PEG

Featuring a replacement wear peg, this slim footpeg design allows a comfortable pivot point, and the wide surface and large diameter end cap keep your boot in place.

**50695-08** \$79.95

Fits '08-later XR1200 models.

#### D. DIAMOND BLACK BRAKE PEDAL PADS

Available in two sizes, these brake pedal pads complete the clean, custom black billet look.

**41850-08** Small. \$39.95

Fits '84-later FX Softail models (except FXSTDSE) and '93-later Dyna models equipped with forward controls.

**46718-08** Large. \$49.95

Fits '80-later Touring models and '86-later FL Softail models.

#### E. DIAMOND BLACK FOOTBOARD INSERT KIT

Machined from billet aluminum, these footboard inserts retain the cast-in vibration isolation found on the Original Equipment footboards. Kit includes right and left insert.

**50549-08** Rider – Traditional Shape. \$199.95

Fits '80-later Touring models and '86-later FL Softail models with traditional shape rider footboards.

**50627-08** Passenger – Traditional Shape. \$179.95

Fits '86-later Touring, '86-later Softail and '06-later Dyna models equipped with traditional shape passenger footboards.



A. DIAMOND BLACK HAND GRIPS



B. DIAMOND BLACK FOOTPEGS AND SHIFTER PEG



C. DIAMOND BLACK FOOTPEG WITH WEAR PEG



D. DIAMOND BLACK BRAKE PEDAL PADS



E. DIAMOND BLACK FOOTBOARD INSERT KIT – RIDER



E. DIAMOND BLACK FOOTBOARD INSERT KIT – PASSENGER





**F. NARROW BAND BILLET HAND GRIPS**



**F. NARROW BAND BILLET HAND GRIPS**

### THE NARROW BAND COLLECTION

A raw look wrapped in class. This hand and foot control collection features a deep knurled surface for a positive grip, and slim black rubber stripes over the chrome finish for stylish contrast. The mirror chrome finish over the knurled surface scatters light to grab the attention of fellow riders. These components look great next to either chrome or black controls, and help you establish your own customizing direction.

#### F. NARROW BAND BILLET HAND GRIPS

Continuing the distinctive knurled chrome and rubber band look of the Billet Footpegs, these hand grips provide a clean, custom look. The end caps are adorned with a Bar & Shield logo.

**56443-00A** **\$69.95**

Fits '96-later XL, XR, Dyna®, Softail®, VRSC™ and '97-'07 Touring models.

#### G. NARROW BAND BILLET FOOTPEGS AND SHIFTER PEG

These high-quality, dramatic custom pegs are machined from premium 6061-T6 aluminum, then polished and chrome-plated for long-lasting good looks.

Fits models with H-D® male-mount style footpeg supports (except the rider position on '07-later XL883L, XL883N, XL1200N, XR, '08-later FXDB, FXDF, FXCW/C, and '02-later VRSC models).

**50978-99** Small Diameter. **\$79.95**

**50976-99** Large Diameter. **\$84.95**

**49254-99** Shifter Peg. **\$18.95**

Fits all models (except '06-later VRSC models with forward controls and XR models).

#### H. NARROW BAND BILLET BRAKE PEDAL PAD

Designed to complement the distinctive knurled chrome and rubber look of the Narrow Band footpegs and hand grips, these Brake Pedal Pads complete the clean, custom billet look.

**42623-00** Large. **\$49.95**

Fits '80-later Touring models and '86-later FL Softail® models.

**42629-00** Small. **\$39.95**

Fits '84-later FX Softail models (except FXSTDSE) and '93-later Dyna models equipped with forward controls.

#### I. NARROW BAND BILLET FOOTBOARD INSERT KITS

These Rider and Passenger Footboard Inserts complete the clean, custom billet look. Machined from billet aluminum and combined with high-durability rubber, these inserts retain the cast-in vibration isolation found in the stock footboard inserts. Kit includes right and left insert.

**51011-01** Rider – Traditional Shape. **\$199.95**

Fits '80-later Touring models (except FLHRS) and '86-later FL Softail models (except '05-'06 FLSTN).

**51017-01** Passenger – Traditional Shape. **\$179.95**

Fits '86-later Touring (except FLHRS), '86-later Softail® and '06-later Dyna models equipped with H-D® Accessory Passenger Footboards.



**G. NARROW BAND BILLET FOOTPEGS AND SHIFTER PEG**



**H. NARROW BAND BILLET BRAKE PEDAL PAD – LARGE AND SMALL**



**I. NARROW BAND BILLET RIDER FOOTBOARD INSERT (SHOWN WITH BRAKE PEDAL PAD)**



**I. NARROW BAND BILLET PASSENGER FOOTBOARD INSERT**

Notice: The prices appearing in this catalog are the manufacturer's suggested retail prices. Actual retail prices may vary.

# 556 CONTROLS

## Hand Grips & Foot Controls

### CRESTED BAR & SHIELD LOGO COLLECTION

Combine classic styling with contemporary shapes for a one-of-a-kind custom look. Styled to complement the Original Equipment rider footboard on the Softail® Deluxe model, the Crested Bar & Shield Logo Collection adds an "art deco" touch to any model. Rimmed with a smooth band of chrome, the contrasting vivid black rubber pad features a deep slotted design that runs parallel to the length of the motorcycle. Interrupted only by an embossed Bar & Shield logo, the molded rubber pad offers a comfortable and easy-to-clean surface.

#### A. CONTOURED CHROME AND RUBBER CUSTOM HAND GRIPS

These grips combine a classic hourglass shape for comfort with the style for the new century. The black molded rubber surface with Bar & Shield logo gives plenty of grip, while the chrome end caps add a smooth organic touch.

Fits '96-later XL, XR, Dyna®, Softail®, VRSC™ and '96-'07 Touring models.

**56799-04** Small 1.3" Diameter. **\$49.95**

**56459-01A** Medium 1.5" Diameter. **\$59.95**

Fits '08-later Touring models.

**56459-08** Medium 1.5" Diameter. **\$59.95**



**A. CONTOURED CHROME AND RUBBER CUSTOM HAND GRIPS**



**B. CONTOURED CHROME AND RUBBER CUSTOM HEATED HAND GRIPS**

#### B. CONTOURED CHROME AND RUBBER CUSTOM HEATED HAND GRIPS

**56512-02C** **\$219.95**  
Fits '96-later XL, XR, Dyna, Softail, VRSC and '96-'07 Touring models. Not compatible with internally wired handlebars.

**56512-08A** **\$229.95**  
Fits '08-later Touring models. Not compatible with internally wired handlebars.

#### C. CRESTED BAR & SHIELD LOGO FOOTPEG KIT

**50576-05** **\$59.95**

Fits models with H-D male-mount style footpeg supports (except the rider position on '07-later XL883L, XL883N, XL1200N, XR, '08-later FXCW/C, and '02-later VRSC models). (pair)

Shown with:

#### CRESTED BAR & SHIELD LOGO SHIFTER PEG

**33946-05** **\$14.95**

Fits all models (except '06-later VRSC models with forward controls and XR models).



**C. CRESTED BAR & SHIELD LOGO FOOTPEG AND SHIFTER PEG**

#### D. CRESTED BAR & SHIELD LOGO BRAKE PEDAL PAD

**42700-05** Large. **\$39.95**

Fits '80-later Touring and '86-later FL Softail models.

**42701-05** Small. **\$39.95**

Fits '84-later FX Softail (except FXSTDSE), and '93-later Dyna models equipped with forward controls.



**D. CRESTED BAR & SHIELD LOGO BRAKE PEDAL PAD - SMALL AND LARGE**

#### E. TAPERED RIDER FOOTBOARD KIT WITH CRESTED BAR & SHIELD LOGO INSERT

Long and lean, the tapered design of these footboards allows maximum flexibility in foot placement for added comfort on long rides. Kit includes left and right tapered footboard pans and rubber isolated deluxe inserts with smooth chrome surround. The inserts feature a slotted rubber design with embossed Bar & Shield logo. Original Equipment on Softail Deluxe models.

**50634-05** **\$149.95**

Fits '86-later FL Softail® models.



**E. TAPERED RIDER FOOTBOARD KIT WITH CRESTED BAR & SHIELD LOGO INSERT**

#### F. TAPERED PASSENGER FOOTBOARD KIT WITH CRESTED BAR & SHIELD LOGO INSERT

Styled to match the rider footboards on the Softail Deluxe model, these Tapered Passenger Footboards feature a Crested Bar & Shield logo rubber pad surrounded by a chrome accent. The footboard pan is chrome-plated throughout to add a custom touch, even in the folded position.

**50396-05** **\$219.95**

Fits '86-later Touring (except Trike), '86-later Softail and '06-later Dyna models equipped with passenger footboards. Installation on models equipped with passenger footpegs requires separate purchase of additional hardware.



**F. TAPERED PASSENGER FOOTBOARD KIT WITH CRESTED BAR & SHIELD LOGO INSERT**

Notice: The prices appearing in this catalog are the manufacturer's suggested retail prices. Actual retail prices may vary.



G

G. STEALTH HAND GRIP



H

H. STEALTH HEATED HAND GRIPS



I

I. STEALTH FOOTPEG AND SHIFTER PEG



J

J. STEALTH BRAKE PEDAL PAD –  
LARGE AND SMALL



K

K. STEALTH RIDER FOOTBOARD INSERT –  
SWEEP WING (SHOWN WITH  
LARGE STEALTH BRAKE PEDAL PAD)



K

K. STEALTH PASSENGER FOOTBOARD INSERT –  
SWEEP WING

## STEALTH COLLECTION

Just like a Stealth fighter, you may not hear it coming, but you'll definitely know when it arrives. The mirror-chrome finish, deep tapered grooves, and thin black rubber tread make the Stealth Collection anything but invisible. First featured on the Screamin' Eagle® Electra Glide® motorcycle, this complete collection allows you to dress your bike for maximum impact.

### G. STEALTH HAND GRIPS

These Hand Grips feature a smooth contoured shape, "ball-milled" grooves, raised rubber tread and a "glueless" design that allows removal without damage.

**56729-04** Fits '96-later XL, XR, Dyna®, Softail®, VRSC™ and '06-'07 Touring models. Stock on '04-later FLHTCSE/2 models. **\$69.95**

**56729-08** Fits '08-later Touring models. **\$79.95**

### H. STEALTH HEATED HAND GRIPS

**56750-04B** Fits '96-later XL, XR, Dyna, Softail, VRSC and '96-'07 Touring models. Not compatible with internally wired handlebars. **\$229.95**

### I. STEALTH FOOTPEG KIT

**50359-04** Fits models with H-D® male-mount style footpeg supports (except the rider position on '07-later XL883L, XL883N, XL1200N, XR, '08-later FXDB, FXDF, FXCW/C, and '02-later VRSC models). **\$59.95**

Shown with:

### STEALTH SHIFTER PEG

**34664-04** Fits all models (except '06-later VRSC models with forward controls and XR models). Stock on '04-later FLHTCSE/2 models. **\$14.95**

### J. STEALTH BRAKE PEDAL PAD

**42555-04** Large. Fits '80-later Touring and '86-later FL Softail models. Stock on '04-later FLHTCSE/2 models. **\$69.95**

**42650-08** Small. Fits '84-later FX Softail models (except FXSTDSE) and '96-later Dyna models equipped with forward controls. **\$39.95**

### K. STEALTH FOOTBOARD INSERTS

The Footboard Insert Kit features "ball-milled" Harley-Davidson script logo, tapered grooves, raised rubber tread, and the distinct Sweep Wing footboard shape.

**50202-04** Rider – Sweep Wing. Fits '04-later FLHRS, FLHX models, and '86-later Touring and Softail® models equipped with Sweep Wing-shaped Rider Footboard Kit P/N 50631-04 or Sweep Wing Footboard Pans P/N 50683-04 (Right) and 50688-04 (Left). Stock on '04-later FLHTCSE/2 models. **\$229.95**

**50358-04** Passenger – Sweep Wing. Fits models equipped with Sweep Wing Passenger Footboard Kit P/N 50357-04 or 50716-04. Does not fit Softail or Trike models. Stock on '04-later FLHTCSE/2 models. Not compatible with Nostalgic Bar & Shield Derby Cover P/N 53785-99. Use of the following derby covers require the separate purchase of Chrome Passenger Footboard Support Kit P/N 52714-04: Stratum P/N 25501-01, Twin Cam P/N 25713-99, Black Fin P/N 25454-01, Slotted P/N 25345-01, Flames P/N 25334-99, V-Wing P/N 25335-99, Aluminator® P/N 25469-00, or Live To Ride P/N 25340-99 and 25372-02. **\$199.95**

Notice: The prices appearing in this catalog are the manufacturer's suggested retail prices. Actual retail prices may vary.



# 558 CONTROLS

## Hand Grips & Foot Controls

### THE AILERON COLLECTION

A pilot knows the thrill of taking wing, and that feeling is the inspiration behind the Aileron Collection. The curving chrome contours and the smooth rubber inserts combine to form an aerodynamic shape that mimics the trailing control surfaces of a fighter's wing. This easy-to-install collection is the ideal match for a contemporary custom ride.

#### A. AILERON HAND GRIPS

Fold your fingers around the chrome "aileron" ridge for a sweet tactile feel. These grips combine a traction-grip smooth rubber surface with a comfortable 1.5" diameter for excellent control in wet or dry weather. The easy-to-install "glueless" design allows you to remove the grips for service without damage.

**56425-02 \$69.95**

Fits '96-later XL, XR, Dyna®, Softail®, VRSC™ and '96-'07 Touring models.

**56425-08 \$79.95** Fits '08-later Touring models.

#### B. AILERON HEATED HAND GRIPS

**56828-03B \$249.95**

Fits '96-later XL, XR, Dyna, Softail, VRSC and '96-'07 Touring models. Not compatible with internally wired handlebars.

**56828-08A \$259.95**

Fits '08-later Touring models. Not compatible with internally wired handlebars.

#### C. AILERON FOOTPEGS

Sweeping rearward like a fighter plane wing, the Aileron Peg Collection is a perfect match for your low-profile street machine. Curving chrome surrounds the deep black rubber pad that is accented with a deeply embossed Bar & Shield logo. These pegs look great alone, or matched with Aileron Hand Grips.

**50305-02 \$169.95**

Fits models with H-D® male-mount style footpeg supports (except the rider position on '07-later XL883L, XL883N, XL1200N, XR, '08-later FXDB, FXDF, FXCW/C, and '02-later VRSC models).

#### D. AILERON BRAKE PEDAL PAD – LARGE

The Aileron Brake Pedal Pad features curving chrome surrounding a deep black rubber pad, accented with a deeply embossed Bar & Shield logo. Easy-to-install, this brake pedal pad complements the Aileron Collection for a complete custom look.

**42678-05A \$89.95**

Fits '80-later Touring models and '86-later FL Softail® models. Original Equipment on FLSTFSE models.

Shown with:

#### AILERON SHIFTER PEG

**34601-02 \$84.95**

Fits all models (except '06-later VRSC models with forward controls and XR models).

#### E. AILERON RIDER FOOTBOARD INSERT KIT

Comfortable and stylish, the Aileron Rider Footboard Inserts lend a custom touch to the Softail Deluxe. Surrounded by a brilliant chrome boarder, the smooth rubber traction strips are divided by a deep perforated groove. A large Bar & Shield logo completes the custom look. Easy-to-install, the footboard inserts retain cast-in vibration isolation for a fatigue-free ride. Kit includes left and right insert.

**50363-05 \$199.95**

Fits '05-later FLSTN models and models equipped with Tapered Rider Footboard Kit P/N 50634-05.



A. AILERON HAND GRIPS



B. AILERON HEATED HAND GRIPS



C. AILERON FOOTPEGS



D. AILERON LARGE BRAKE PEDAL PAD AND SHIFTER PEG



E. AILERON RIDER FOOTBOARD INSERT KIT

Notice: The prices appearing in this catalog are the manufacturer's suggested retail prices. Actual retail prices may vary.



# CONTROLS 559

Hand Grips & Foot Controls



**F. IRONSIDE HAND GRIP**



**G. IRONSIDE HEATED HAND GRIPS**



**H. IRONSIDE COLLECTION FOOTPEG AND SHIFTER PEG**



**I. IRONSIDE BRAKE PEDAL PADS – LARGE**



**J. IRONSIDE COLLECTION RIDER FOOTBOARD INSERT – SWEEP WING (SHOWN WITH LARGE BRAKE PEDAL PAD)**



**J. IRONSIDE COLLECTION PASSENGER FOOTBOARD INSERT – SWEEP WING**

## THE IRONSIDE COLLECTION

Surrounded by brilliant chrome, the rich black rubber tread is offset with scalloped accents and faux rivets. Resembling riveted metal plates, this collection adds a tough industrial-age look to a modern classic custom ride.

### F. IRONSIDE HAND GRIPS

The Hand Grips are a comfortable 1.5" diameter, and feature a "glueless" design for easy installation.

**57202-07** **\$79.95**

Fits '96-later XL, Dyna®, Softail®, VRSC™ and '97-'07 Touring models.

**57202-08** **\$89.95**

Fits '08-later Touring models.

### G. IRONSIDE HEATED HAND GRIPS

**56997-07A** **\$249.95**

Fits '96-later XL, XR, Dyna, Softail, VRSC and '96-'07 Touring models. Not compatible with internally wired handlebars.

**56049-08A** **\$259.95**

Fits '08-later Touring models. Not compatible with internally wired handlebars.

### H. IRONSIDE COLLECTION FOOTPEG KIT

Footpeg rotation is adjustable for position, so your feet ride on the rubber pad whether used as a rider, passenger, or highway peg. Kit includes left and right peg.

**50935-07** **\$149.95**

Fits models with H-D® male-mount style footpeg supports (except the rider position on '07-later XL883L, XL883N, XL1200N, XR, '08-later FXDB, FXDF, FXCW/C, and '02-later VRSC models).

**Shown with:**

### IRONSIDE COLLECTION SHIFTER PEG KIT

Shifter peg position is adjustable for comfort, and the rubber backing protects the toe of your boot from scuffing during shifting.

**34720-07** **\$59.95**

Fits all models (except '06-later VRSC models with forward controls and XR models).

### I. IRONSIDE BRAKE PEDAL PADS

Large brake pedal pad complements the Ironside Footboard Insert and Footpeg collection.

**46959-07** Large. **\$89.95**

Fits '80-later Touring and '86-later FL Softail® models.

### J. IRONSIDE COLLECTION FOOTBOARD INSERTS

Easy-to-install footboard kits retain the Original Equipment cast-in vibration isolation for a fatigue-free ride. Kit includes left and right insert.

**50968-07** Rider – Swept Wing. **\$219.95**

Fits '04-later FLHRS, FLHX models, and '86-later Touring and Softail models equipped with Swept Wing-shaped Rider Footboard Kit P/N 50631-04 or Swept Wing Footboard Pans P/N 50683-04 (Right) and 50688-04 (Left).

**52312-07** Passenger – Swept Wing. **\$199.95**

Fits '04-later FLHTCSE/2 models, and models equipped with Swept Wing Passenger Footboard Kit P/N 50357-04 or 50716-04. Does not fit Softail models.

CONTROLS

*Notice: The prices appearing in this catalog are the manufacturer's suggested retail prices. Actual retail prices may vary.*

# 560 CONTROLS

## Hand Grips & Foot Controls

### FLAME COLLECTION

Styled to carry the "Flame" theme from front to back, this hot collection will get you noticed. The smooth black rubber defines the brilliant chrome "Hot Rod" flame pattern, and the dimensional surface adds comfort and grip.

#### A. FLAME HAND GRIPS

These hot new grips will get you noticed. Smooth rubber is molded into the machined billet grip and defines the chrome "Hot Rod" flame. The grips are simple to install, and the "glueless" design allows removal without damage.

**56518-02** \$79.95

Fits '96-later XL, XR, Dyna®, Softail®, VRSC™ and '96-'07 Touring models.

**56518-08** Fits '08-later Touring models. \$89.95

#### B. FLAME HEATED HAND GRIPS

**56047-03C** \$249.95  
Fits '96-later XL, XR, Dyna, Softail, VRSC and '96-'07 Touring models. Not compatible with internally wired handlebars.

**56047-08A** \$259.95

Fits '08-later Touring models. Not compatible with internally wired handlebars.

#### C. FLAME FOOTPEGS

**50312-03** \$59.95

Fits models with H-D® male-mount style footpeg supports (except '07-later XL883L, XL883N, XL1200N, XR, '08-later FXCW/C, and '02-later VRSC models). (pair)

#### D. FLAME SHIFTER PEG

**34617-03** \$14.95

Fits all models (except '06-later VRSC models with forward controls and XR models).

#### E. FLAME HEEL REST KIT

**34680-03** \$29.95

Fits models equipped with Heel Rest Kit P/N 50227-01.

#### F. FLAME BRAKE PEDAL PAD

**42841-03** Small. \$39.95

Fits '84-later FX Softail® models (except FXSTDSE) and '96-later Dyna models equipped with forward controls.

**42554-03** Large. \$39.95

Fits '80-later Touring models and '86-later FL Softail models.

#### G. FLAME FOOTBOARD INSERTS

**50295-02** Rider – Traditional Shape. \$99.95

Fits '86-later Touring models and '86-later Softail models equipped with traditional shape rider footboards.

**50310-02** Passenger – Traditional Shape. \$84.95

Fits '86-later Touring (except FLHRS), '86-later Softail and '06-later Dyna models equipped with H-D Accessory Passenger Footboards.



A. FLAME HAND GRIPS



B. FLAME HEATED HAND GRIPS



C. FLAME FOOTPEG



D. FLAME SHIFTER PEG



E. FLAME HEEL REST KIT



F. FLAME BRAKE PEDAL PAD – LARGE AND SMALL



G. FLAME RIDER FOOTBOARD INSERTS – TRADITIONAL SHAPE (SHOWN WITH LARGE FLAME BRAKE PEDAL PAD)



G. FLAME PASSENGER FOOTBOARD INSERTS – TRADITIONAL SHAPE

Notice: The prices appearing in this catalog are the manufacturer's suggested retail prices. Actual retail prices may vary.

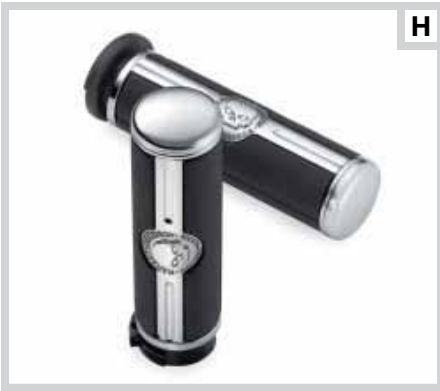

**H. WILLIE G. SKULL HAND GRIPS**



**I. WILLIE G. SKULL HEATED HAND GRIPS**



**J. WILLIE G. SKULL FOOTPEG AND SHIFTER PEG**



**K. WILLIE G. SKULL BRAKE PEDAL PADS – LARGE AND SMALL**



**L. WILLIE G. SKULL RIDER FOOTBOARD INSERTS – TRADITIONAL SHAPE (SHOWN WITH LARGE BRAKE PEDAL PAD)**



**L. WILLIE G. SKULL PASSENGER FOOTBOARD INSERTS – TRADITIONAL SHAPE**



**L. WILLIE G. SKULL RIDER FOOTBOARD INSERTS – SWEEP WING SHAPE**



**M. WILLIE G. SKULL HEEL REST KIT**

### WILLIE G. SKULL COLLECTION

The deep black rubber pads are set against a brilliant polished and chrome-plated field to yield the dramatic appearance of the Skull Collection.

#### H. WILLIE G. SKULL HAND GRIPS

Contrasting the chrome sinister skull logo surrounded by "Harley-Davidson" script, the raised rubber pads add positive grip and comfort for the long haul. Easy-to-install, these grips feature a "glueless" design that allows removal without damage.

Fits '96-later XL, XR, Dyna®, Softail®, VRSC™ and '96-'07 Touring models.

<b>56751-04</b>	Small 1.3" Diameter.	<b>\$79.95</b>
<b>56740-04</b>	Medium 1.5" Diameter.	<b>\$79.95</b>
<b>56741-04</b>	Large 1.6" Diameter.	<b>\$79.95</b>

Fits '08-later Touring models.

<b>56740-08</b>	Medium 1.5" Diameter.	<b>\$89.95</b>
-----------------	-----------------------	----------------

#### I. WILLIE G. SKULL HEATED HAND GRIPS

**56926-05A** **\$249.95**  
Fits '96-later XL, XR, Dyna, Softail, VRSC and '96-'07 Touring models. Not compatible with internally wired handlebars.

**56926-08A** **\$259.95**  
Fits '08-later Touring models. Not compatible with internally wired handlebars.

#### J. WILLIE G. SKULL FOOTPEG KIT

**50370-04** **\$59.95**  
Fits models with H-D® male-mount style footpeg supports (except the rider position on '07-later XL883L, XL883N, XL1200N, XR, '08-later FXDB, FXDF, FXCW/C, and '02-later VRSC models). (pair)

Shown with:

#### SKULL SHIFTER PEG

**34689-04** **\$14.95**  
Fits all models (except '06-later VRSC models with forward controls and '06-later Dyna models with forward controls).

#### K. WILLIE G. SKULL BRAKE PEDAL PADS

**42710-04** Small. **\$49.95**  
Fits '84-later FX Softail (except FXSTDSE), and '93-later Dyna models equipped with forward controls.

**42711-04** Large. **\$69.95**  
Fits '80-later Touring and '86-later FL Softail models.

#### L. WILLIE G. SKULL FOOTBOARD INSERTS

**50710-04** Rider – Traditional Shape. **\$99.95**  
Fits '86-later Touring models and '86-later Softail models equipped with traditional shape rider footboards.

**50713-04** Passenger – Traditional Shape. **\$84.95**  
Fits '86-later Touring (except FLHRS), '86-later Softail and '06-later Dyna models equipped with H-D Accessory Passenger Footboards.

**50704-04** Rider – Swept Wing Shape. **\$99.95**  
Fits '04-later FLHRS models, and '86-later Touring and Softail® models equipped with Swept Wing-shaped Rider Footboard Kit P/N 50631-04 or Swept Wing Footboard Pans P/N 50683-04 (Right) and 50688-04 (Left).

#### M. WILLIE G. SKULL HEEL REST KIT

**34699-04** **\$29.95**  
Fits models equipped with Heel Rest Kit P/N 50227-01.



# 562 CONTROLS

## Hand Grips & Foot Controls

### THE NOSTALGIC COLLECTION

With a serious nod to the past, the Nostalgic Collection applies a fresh twist to a classic design. The chrome surround and raised rubber shapes outline the historic round shield and name band that has been at the center of Harley-Davidson Original Equipment footboards for years. The classic look extends to the matching hand grips that feature the classic "bicycle grip" shape. This easy-to-install collection is the ideal match for your traditional styling direction.

#### A. NOSTALGIC HAND GRIPS

Comfortable nostalgic hourglass style with a chrome accent ring and a molded-in "Harley-Davidson" logo. These rubber grips were inspired by Harley-Davidson® motorcycles of the 1940s. (sold in pairs)

**56275-96B** \$59.95

Fits '96-later XL, XR, Dyna®, Softail®, VRSC™ and '96-'07 Touring models.

**56275-08** Fits '08-later Touring models. \$59.95

#### B. NOSTALGIC HEATED HAND GRIPS

**56619-03B** \$219.95  
Fits '96-later XL, XR, Dyna, Softail, VRSC and '96-'07 Touring models. Not compatible with internally wired handlebars.

#### C. NOSTALGIC SHIFTER PEG

**34627-99** \$14.95

Fits all models (except '06 later VRSC models with forward controls and XR models).

#### D. NOSTALGIC BRAKE PEDAL PAD

**44248-96** \$39.95

Fits '80-later Touring models and '86-later FL Softail® models.

#### E. NOSTALGIC FOOTBOARD INSERT KITS

Quick, easy replacement of stock rubber footboard insert. Made from stamped chrome-plated steel and high-durability rubber. Retains cast-in vibration isolation found in stock footboard inserts. Kit includes left and right insert.

**50187-96** Rider – Traditional Shape. \$99.95

Fits '86-later Touring models and '86-later Softail models equipped with traditional shape rider footboards.

**50190-96** Passenger – Traditional Shape. \$84.95

Fits '86-later Touring (except FLHRS), '86-later Softail® and '06-later Dyna models equipped with H-D Accessory Passenger Footboards.

**50051-09** Rider – Half-Moon Shape. \$149.95

Fits '08-later FLSTSB, '09-later FLSTC and models equipped with Half-Moon Rider Footboards.

**50027-09** \$129.95

Fits '86-later Touring, '00-later Softail and '06-later Dyna models equipped with passenger footboard supports and Half-Moon Footboard Pan Kits P/N 50807-08 or 50810-08.



A. NOSTALGIC HAND GRIPS



B. NOSTALGIC HEATED HAND GRIPS



C. NOSTALGIC SHIFTER PEG



D. NOSTALGIC BRAKE PEDAL PAD



E. NOSTALGIC RIDER FOOTBOARD INSERT – TRADITIONAL SHAPE (SHOWN WITH BRAKE PEDAL PAD)



E. NOSTALGIC PASSENGER FOOTBOARD INSERT – TRADITIONAL SHAPE



E. NOSTALGIC RIDER FOOTBOARD INSERT – HALF-MOON SHAPED (SHOWN WITH BRAKE PAD)



**NEW**

E. NOSTALGIC PASSENGER FOOTBOARD INSERTS – HALF-MOON SHAPED

Notice: The prices appearing in this catalog are the manufacturer's suggested retail prices. Actual retail prices may vary.





**F. X² HAND GRIPS**



**G. X² FOOTPEG KIT**



**H. STREAMLINER SHIFTER PEG AND FOOTPEG**



**I. STREAMLINER BRAKE PEDAL PAD**



**J. STREAMLINER RIDER FOOTBOARD (SHOWN WITH BRAKE PEDAL PAD AND FOOTPEG KIT)**



**K. STREAMLINER PASSENGER FOOTBOARD INSERT – SWEEP WING SHAPE**

### THE X² COLLECTION

Custom squared. These contemporary Hand Grips and matching Footpegs feature thick black rubber surfaces surrounded by mirror-polished chrome. The shape fills your hand like the control stick of a fighter plane. The squared-off contour provides positive throttle twist, and the matching Footpegs provide ample space to rest your heel.

#### F. X² HAND GRIPS

These uniquely styled grips look like a fighter pilot's flight stick. Highly contrasting "ribs" of chrome and rubber give this small diameter grip a futuristic look.

**56711-03 \$79.95**

Fits '96-later XL, XR, Dyna®, Softail®, VRSC™ and '96-'07 Touring models.

#### G. X² FOOTPEG KIT

Styled to complement the X² Hand Grips, these unique Footpegs feature a massive chrome housing that surrounds a deep black rubber traction surface. Fine chrome "ribs" give these footpegs a futuristic look. Finish the look with a complementing Streamliner Shifter Peg P/N 34967-04.

**50472-08 \$89.95**

Fits models with H-D male-mount style footpeg supports (except the rider position on '07-later XL883L, XL883N, XL1200N, XR, '08-later FXDB, FXDF, FXCW/C, and '02-later VRSC models).

### THE STREAMLINER COLLECTION

Inspired by the art-deco designs of the Streamliner era, this collection reflects the simple lines and shapes that still remain contemporary today. The rich black rubber features three raised chrome Tri-Line bands for contrast, and a rich chrome surround to finish the look.

#### H. STREAMLINER FOOTPEG KIT

Complete the streamlined look with Streamliner Footpegs. Kit includes left and right footpegs.

**50211-04 \$159.95**

Fits models with H-D® male-mount style footpeg supports (except the rider position on '07-later XL883L, XL883N, XL1200N, XR, '08-later FXDB, FXDF, FXCW/C, and '02-later VRSC models).

#### Shown with:

##### STREAMLINER SHIFTER PEG

Complement the streamlined footpegs and footboards with this simple-to-install Shifter Peg. The chrome frame surrounds a black rubber pad accented with three chrome bands for style and grip.

**34967-04 \$14.95**

Fits all models (except '06-later VRSC models with forward controls and XR models).

#### I. STREAMLINER BRAKE PEDAL PAD

Complement the streamlined footpegs and footboards with this simple-to-install Brake Pedal Pad. The chrome frame surrounds a black rubber pad accented with three chrome bands for style and grip.

**42712-04 Large \$54.95**

Fits '80-later Touring models and '86-later FL Softail® models.

#### J. STREAMLINER RIDER FOOTBOARD KIT

Add the sleek sweeping footboard design from the Road King® Custom to your Touring bike. Kit includes vibration-isolation footboard pads with three chrome bands, and the complete chrome-plated pans that easily bolt in place of the Original Equipment footboards.

**50631-04 \$179.95**

Fits '86-later Touring models and '86-later FL Softail® models.

#### K. STREAMLINER PASSENGER FOOTBOARD INSERT KIT – SWEEP WING SHAPE

Styled to match the Road King® Custom model's Original Equipment Streamliner Rider Footboards. Featuring vibration-isolation rubber inserts with three chrome bands, this insert is designed to fit the Sweep Wing shape passenger footboard pan. Kit includes left and right side insert.

**50420-05 \$84.95**

Fits '04-later FLHTCSE/2 models, and models equipped with Sweep Wing Passenger Footboard Kit P/N 50357-04 or 50716-04.

# 564 CONTROLS

## Hand Grips & Foot Controls

### CHROME AND RUBBER COLLECTION

Chrome and Rubber both have their distinct places in the world of motorcycle styling. It seemed natural to bring the two together to create this unique collection.

#### A. CHROME AND RUBBER HAND GRIPS

Designed to match the Chrome Footboard Inserts and Brake Pedal Pads, these grips are made from an injected rubber molding process that combines chromed steel and durable rubber. (sold in pairs)

Fits '96-later XL, XR, Dyna®, Softail®, VRSC™ and '96-'07 Touring models.

<b>56246-96A</b>	Small.	<b>\$69.95</b>
<b>56263-96A</b>	Large.	<b>\$69.95</b>

Fits '08-later Touring models.

<b>56246-08</b>	Small.	<b>\$69.95</b>
<b>56263-08</b>	Large.	<b>\$69.95</b>

Fits '82-'95 models. Kit includes adhesive required for installation.

<b>56241-96</b>	Small.	<b>\$59.95</b>
-----------------	--------	----------------

#### B. CHROME AND RUBBER HEATED HAND GRIPS

Fits '96-later XL, XR, Dyna, Softail, VRSC and '96-'07 Touring models. Not compatible with internally wired handlebars. (sold in pairs)

<b>56196-03C</b>	Small Diameter.	<b>\$229.95</b>
<b>56174-03C</b>	Large Diameter.	<b>\$229.95</b>

Fits '08-later Touring models. Not compatible with internally wired handlebars.

<b>56196-08A</b>	Small Diameter.	<b>\$239.95</b>
------------------	-----------------	-----------------

#### C. CHROME AND RUBBER CUSTOM FOOTPEGS AND SHIFTER PEG

Fits models with H-D® male-mount style footpeg supports (except the rider position on '07-later XL883L, XL883N, XL1200N, XR, '08-later FXDB, FXDF, FXCW/C, and '02-later VRSC models).

<b>50500-03</b>	Oversize. (pair)	<b>\$79.95</b>
<b>50130-95A</b>	Large. (pair)	<b>\$69.95</b>
<b>50131-95A</b>	Small. (pair)	<b>\$59.95</b>
<b>34608-95</b>	Shifter Peg.	<b>\$14.95</b>

Fits all models (except '06-later VRSC models with forward controls and XR models).

#### D. CHROME AND RUBBER BRAKE PEDAL PAD

Fits '80-later Touring models and '86-later FL Softail models.

<b>42478-95</b>	Large.	<b>\$39.95</b>
-----------------	--------	----------------

Fits '84-later FX Softail® models (except FXSTDSE) and '93-later Dyna models equipped with forward controls.

<b>42476-95</b>	Small.	<b>\$39.95</b>
-----------------	--------	----------------

#### E. CHROME AND RUBBER FOOTBOARD INSERTS

**50176-95** Rider – Traditional Shape. **\$99.95**  
Fits '86-later Touring models and '86-later Softail models equipped with traditional shape rider footboards. (pair)

**50177-95** Passenger – Traditional Shape. **\$84.95**  
Fits '86-later Touring (except FLHRS), '86-later Softail® and '06-later Dyna models equipped with H-D Accessory Passenger Footboards. (pair)



A. CHROME AND RUBBER HAND GRIPS



B. CHROME AND RUBBER HEATED HAND GRIPS – SMALL DIAMETER



C. CHROME AND RUBBER CUSTOM FOOTPEGS AND SHIFTER PEG



D. CHROME AND RUBBER BRAKE PEDAL PADS



E. CHROME AND RUBBER RIDER FOOTBOARD INSERT (SHOWN WITH BRAKE PEDAL PAD)



E. CHROME AND RUBBER PASSENGER FOOTBOARD INSERT

Notice: The prices appearing in this catalog are the manufacturer's suggested retail prices. Actual retail prices may vary.



NEW

F

F. HEEL RAISER FOOTPEG KIT



NEW

F

F. HEEL RAISER FOOTPEG KIT



NEW

G

G. MINI FOOTBOARD KIT



H

H. AIRFOIL CUSTOM FOOTPEGS AND SHIFTER PEG



I

I. AIRFOIL BRAKE PEDAL PADS



J

J. AIRFOIL HEEL RESTS

### F. HEEL RAISER FOOTPEG KIT

Comfort and cool, clean looks in one. Heel Raiser Chrome and Rubber Footpegs provide a large surface area that lets you change foot position for maximum comfort, and the fold-out heel rest provides floorboard-style support that relieves calf and thigh tension on the highway. The heel rest can be deployed or retracted with your boot while riding. The sole-gripping horizontal black rubber bands complement the mirror-chrome finish, and add vibration isolation and a rich appearance to the pegs. Complete the look with Shifter Pegs and Brake Pedal Pads from the Chrome and Rubber Collection. Heel Raiser mounts to the standard H-D style footpeg support, so it can be used in many rider and passenger applications.

**50178-09** **\$189.95**

Fits H-D® male mount style footpeg supports (except the rider position on '02-later VRSCD/DX/F/R/X, '07-later XL883L, XL883N, XL1200N, '09-later XR, '08-later FXCW/C, and passenger position on Softail® models). Fits mid-control equipped XL and Dyna® models when equipped with engine guards and Highway Peg Mount P/N 50964-98 or 50957-02B. Does not fit with Adjustable Passenger Footpeg Support P/N 50763-09 or 50787-09, or Whiskers Adjustable Highway Bar P/N 50855-09 and 50865-09. Does not fit mid-control position.

### G. MINI FOOTBOARD KIT

This Mini Footboard Kit can be installed in place of traditional footpegs and provides a little additional leg support and more options to move your feet around on a long run. Mini Footboards mount to standard H-D style footpeg supports, and can be used in many rider and passenger applications. A little larger than a bicycle pedal, Footboards can be pivoted to the proper angle for maximum riding comfort. The sole-gripping horizontal black rubber bands complement the mirror-chrome finish, and add vibration isolation and a rich appearance to the pegs. Complete the look with Shifter Pegs and Brake Pedal Pads from the Chrome and Rubber Collection.

**50451-09** **\$109.95**

Fits models with forward controls (except FXCW/C, VRSCDX and VRSCF). Does not fit with mid-controls or with Frame Mounted Highway Pegs P/N 50855-09 and 50865-09. Fits passenger male mount style footpeg supports on most models (except '03-earlier XL, '06-earlier VRSC™, '05-earlier Dyna, and FXSTD, FLSTSB, FLSTF, FLSTN and Softail models with shotgun exhaust). Softail passenger position also requires Support Kit P/N 50454-09.

### THE AIRFOIL COLLECTION

Shaped to control the wind, this classic collection features thick vertical rubber treads set in a field of mirror-polished chrome. The slim tapered shape mimics the leading edge of a plane's wing, and the contour is as contemporary as it gets.

### H. AIRFOIL CUSTOM FOOTPEGS AND SHIFTER PEG

Fits models with H-D® male-mount style footpeg supports (except the rider position on '07-later XL883L, XL883N, XL1200N, XR, '08-later FXDB, FXDF, FXCW/C, and '02-later VRSC models).

**50474-03** Oversize. **\$79.95**

**50133-95** Large. **\$69.95**

**50134-95** Small. **\$59.95**

**34626-95** Shifter Peg. **\$14.95**

Fits all models (except '06-later VRSC models with forward controls and XR models).

### I. AIRFOIL BRAKE PEDAL PAD

Fits '80-later Touring models and '86-later FL Softail models.

**42557-95** Large. **\$39.95**

Fits '84-later FX Softail® models (except FXSTDSE) and '93-later Dyna models equipped with forward controls.

**42482-95** Small. **\$39.95**

### J. AIRFOIL HEEL RESTS

Designed to complement H-D Airfoil Footpegs, these Airfoil Heel Rests help reduce rider fatigue on a long trip, and add a touch of style around town.

**50281-01** **\$119.95**

Fits '89-later FX Softail models (except FXCW/C) and '90-later Dyna models (except '03-later FXDWG and Dyna models with forward controls).



# 566 CONTROLS

## Footpegs

### A. SLOTTED CHROME AND RUBBER CUSTOM FOOTPEGS

Great by themselves or paired with our Billet and Rubber Hand Grips, these heavy chrome and rubber billet style footpegs are a delight to the eye and to the foot. The integral molded black rubber tread with Bar & Shield logo is a sharp contrast to the mirror-finish slotted chrome surround, and makes a styling statement sure to get you noticed.

**43280-01** **\$64.95**

Fits models with H-D® male-mount style footpeg supports (except the rider position on '07-later XL883L, XL883N, XL1200N, XR, '08-later FXDB, FXDF, FXCW/C, and '02-later VRSC™ models). (pair)

### B. BILLET FOOTPEGS AND SHIFTER PEG – CHROME

Achieve a sporty look with these sleek high-grade billet aluminum footpegs and shifter peg. The footpegs feature a two-piece construction that makes correct footpad orientation easy and allows for installation on all models using a male-mount style footpeg support. Made in the U.S.A.

**49234-98** Footpegs. **\$99.95**

Fits models with H-D® male-mount style footpeg supports (except the rider position on '07-later XL883L, XL883N, XL1200N, XR, '08-later FXDB, FXDF, FXCW/C, and '02-later VRSC models). (pair)

**49238-98** Shifter Peg. **\$16.95**

Fits all models (except '06-later VRSC models with forward controls and XR models).

### C. CUSHION FOOTPEGS

With etched Bar & Shield logos. Adjustable end caps ensure proper position of logo. Tough polypropylene cushion matches the look of Harley-Davidson® Black Cushion Grips.

**91821-85** Small. **\$39.95**

Fits models with H-D® male-mount style footpeg supports (except the rider position on '07-later XL883L, XL883N, XL1200N, XR, '08-later FXDB, FXDF, FXCW/C, and '02-later VRSC models). (pair)

### D. CUSTOM FOOTPEGS AND SHIFTER PEG

This footpeg grouping is chrome-plated and features a zinc die-cast body with steel shaft. The black rubber pads have "Harley-Davidson" graphics molded-in for rich detail. Allen wrench included. All footpegs sold in pairs.

Fits models with H-D® male-mount style footpeg supports (except the rider position on '07-later XL883L, XL883N, XL1200N, XR, '08-later FXDB, FXDF, FXCW/C, and '02-later VRSC models).

**1. 50915-90T** Large Diameter Footpeg. **\$49.95**

**2. 50916-90T** Small Diameter Footpeg. **\$44.95**

Fits all models (except '06-later VRSC models with forward controls and XR models).

**3. 34635-90T** Custom Shifter Peg. **\$12.95**

### E. FOOTPEGS AND SHIFTER PEG WITH CHROME END COVER

**1. 49117-77TB** Small Diameter Footpeg. **\$29.95**

Fits models with H-D® male-mount style footpeg supports (except the rider position on '07-later XL883L, XL883N, XL1200N, XR, '08-later FXDB, FXDF, FXCW/C, and '02-later VRSC models). (pair)

**2. 34633-85T** Shifter Peg. **\$9.95**

Fits all models (except '06-later VRSC models with forward controls and XR models).

**3. 49500-92T** 5" Extended Footpegs. **\$39.95**

Fits models with H-D® male-mount style footpeg supports (except the rider position on '07-later XL883L, XL883N, XL1200N, XR, '08-later FXCW/C, and '02-later VRSC models). (pair)

### F. LARGE CUSHIONED FOOTPEG KIT

These fat pegs smooth your ride by dampening vibration.

**49110-98** **\$34.95**

Fits models with H-D® male-mount style footpeg supports (except the rider position on '07-later XL883L, XL883N, XL1200N, XR, '08-later FXDB, FXDF, FXCW/C, and '02-later VRSC models). (pair)



A. SLOTTED CHROME AND RUBBER CUSTOM FOOTPEGS



B. BILLET FOOTPEGS AND SHIFTER PEG – CHROME



C. CUSHION FOOTPEGS



D. CUSTOM FOOTPEGS AND SHIFTER PEG



E. FOOTPEGS AND SHIFTER PEG WITH CHROME END COVER



F. LARGE CUSHIONED FOOTPEG KIT

Notice: The prices appearing in this catalog are the manufacturer's suggested retail prices. Actual retail prices may vary.





G



H

### G. O-RING FOOTPEGS AND SHIFTER PEG WITH ETCHED BAR & SHIELD LOGO

#### Chrome O-Ring Shifter Peg

Rotates for smooth shifting. Extends O-ring life and reduces boot scuffing.

**1. 49149-84A** **\$19.95**

Fits all models (except '06-later VRSC models with forward controls, XR models, or '06-later Dyna® models with forward controls).

#### Chrome O-Ring Footpegs

With etched Bar & Shield logos. Replaces your stock rider or passenger pegs.

**2. 49128-82** Small male-mount. **\$39.95**

Fits models with H-D® male-mount style footpeg supports (except the rider position on '07-later XL883L, XL883N, XL1200N, XR, '08-later FXDB, FXDF, FXCW/C, and '02-later VRSC models). (pair)

### H. ANTI-VIBRATION-STYLE FOOTPEGS

Uniquely designed to isolate vibration. Standard on FXR, FXD, FXDL, FXD CONV. and '91-later XL models. Use as highway or passenger pegs only for FXDWG, XL Custom, and Softail models. May also be used in place of small diameter footrests. Footrest rubber is also available separately.

Fits models with H-D® male-mount style footpeg supports (except the rider position on '07-later XL883L, XL883N, XL1200N, XR, '08-later FXDB, FXDF, FXCW/C, and '02-later VRSC models). (pair)

**50643-82** Footpeg – Right. **\$19.95**

**50647-82** Footpeg – Left. **\$19.95**

**50646-82** Footpeg – Rubber only. **\$9.00**

### I. CHROME FOOTPEG MOUNTING HARDWARE KIT

Polished and chrome-plated hex head bolts replace the Original Equipment footpeg mounting hardware for a truly finished look. Kit includes two chrome-plated bolts and lock nuts with nylon inserts. The bolts carry a Harley-Davidson Bar & Shield proof mark. All hardware is developed to Original Equipment standards to ensure product quality.

**94139-01** **\$11.95**

Fits male-mount style footpegs (except XR models).

### J. CHROME BULLET TIP FOOTPEG BOLT KIT

Put the final touch on a custom footpeg installation with this Chrome Bullet Tip Footpeg Bolt Kit. Sold in pairs, this accessory includes chrome button head bolts, washers and uniquely styled nuts. All hardware is developed to Original Equipment standards to ensure product quality.

**94133-01** **\$21.95**

Fits male-mount style footpegs (except XR models).

### K. POLISHED STAINLESS STEEL FOOTPEG MOUNTING PINS

Stainless steel for rust and corrosion resistance. Polished for good looks. Replaces Original Equipment footpeg mounting hardware.

**42679-01** **\$12.95**

Fits male-mount style footpegs (except XR models).

### L. REPLACEMENT MATS AND CUSHIONS

**50614-40TA** **\$20.00**

Fits P/N 50599-89T and P/N 50603-40T Footboards.

Old-style. (pair)

**50614-66T** **\$13.75**

Fits P/N 50603-74T and P/N 50603-66T Footboards. (pair)

**50614-91A** **\$20.00**

Fits all isolator-style footboards. Stock on '91-'05 models.

**50598-89T** **\$21.00**

Rubber Mount. Fits P/N 50599-89T.



I



J

I. CHROME FOOTPEG MOUNTING HARDWARE KIT

J. CHROME BULLET TIP FOOTPEG BOLT KIT



K



L

K. POLISHED STAINLESS STEEL FOOTPEG MOUNTING PINS

L. REPLACEMENT MATS AND CUSHIONS – (OLD STYLE SHOWN)

Notice: The prices appearing in this catalog are the manufacturer's suggested retail prices. Actual retail prices may vary.

# 568 CONTROLS

## Footboards

### A. BLACK RIDER FOOTBOARD PANS

Complete the blacked-out transformation. Replace the Original Equipment chrome footboard pans with sinister gloss black. Kit includes both the right and left pan, and is installed using the Original Equipment hardware and insert pad. Custom footboard inserts are sold separately.

Fits '86-later Touring models and '86-later FL Softail® models.

<b>51322-08</b>	Traditional Shape.	<b>\$79.95</b>
<b>51060-08</b>	Swept Wing Shape.	<b>\$79.95</b>

### B. SWEEP WING RIDER FOOTBOARD PANS – CHROME

Add a sleek tapered look to your footboard-equipped model. These chrome-plated Swept Wing pans are installed using the Original Equipment mounts and hardware. Add your choice of swept-wing shaped footboard inserts (*sold separately*).

Fits '86-later Touring models and '86-later FL Softail® models.

<b>50683-04</b>	Right.	<b>\$54.00</b>
<b>50688-04</b>	Left.	<b>\$54.00</b>

### C. RIDER FOOTBOARDS

All footboards are sold individually.

<del><b>1. Old-Style</b></del>	<del>Fits '40-'65 FL models.</del>	<del><b>\$54.10</b></del>
<del><b>2. Rubber Mount</b></del>	<del>Fits '66-'87 FL models.</del>	<del><b>\$46.00</b></del>

**OBSOLETE**

### D. HALF-MOON RIDER FOOTBOARDS

Combine the style of the 40s with the comfort of today. The classic half moon-shaped rider footboards are available in polished stainless steel or gloss black finish to complement your styling direction. The traditional "Harley-Davidson" rubber insert features a vibration-isolation design for a long, comfortable ride. Kit includes left and right footboard pans and matching rubber inserts.

Fits '86-later FL Softail models.

<b>51345-08</b>	Polished Stainless.	<b>\$149.95</b>
<b>51400-08</b>	Gloss Black.	<b>\$149.95</b>



**A. BLACK RIDER FOOTBOARD PANS – TRADITIONAL SHAPE (SHOWN WITH INSERT)**



**A. BLACK RIDER FOOTBOARD PANS – SWEEP WING SHAPE (SHOWN WITH STREAMLINER INSERT)**



**B. SWEEP WING RIDER FOOTBOARD PANS (SHOWN WITH STREAMLINER INSERT)**



**C. RIDER FOOTBOARDS**



**D. HALF-MOON RIDER FOOTBOARD – POLISHED STAINLESS**



**D. HALF-MOON RIDER FOOTBOARD – GLOSS BLACK**

Notice: The prices appearing in this catalog are the manufacturer's suggested retail prices. Actual retail prices may vary.



**E. OLD-STYLE RIDER FOOTBOARD ASSEMBLY (SHOWN WITH BRAKE PEDAL PAD)**



**F. CHROME PASSENGER FOOTBOARD PAN KIT**



**G. SWEPT WING PASSENGER FOOTBOARD KIT – GROOVED**



**G. SWEPT WING PASSENGER FOOTBOARD KIT – SMOOTH**



**H. HALF-MOON PASSENGER FOOTBOARDS – CHROME**



**H. HALF-MOON PASSENGER FOOTBOARDS – GLOSS BLACK**

**E. OLD-STYLE RIDER FOOTBOARD ASSEMBLY**

This rubber-mounted Footboard Assembly brings together classic styling of the 1940s with the comfort of today. Footboards are sold separately.

**50599-89T** **\$49.95**  
Fits '80-later FLT, FLHT, FLTR and '86-later FLST, FLSTN, FLSTF, FLSTS models. (each)

**F. CHROME PASSENGER FOOTBOARD PAN KIT**

Replace the factory black painted passenger footboard with the custom look of smooth chrome. The kit includes left- and right-hand traditional D-shaped footboard pans, chrome-plated, and ready to install with your Original Equipment hardware. Just add your choice of footboard insert for the finishing touch.

**50752-04** **\$169.95**  
Fits '86-later Touring, '00-later Softail® and '06-later Dyna® models equipped with passenger footboard supports.

**G. SWEPT WING PASSENGER FOOTBOARD PANS**

These unique Swept Wing Passenger Footboard pans complement the Swept Wing Rider Footboard shape, and allows you to replace the Original Equipment passenger footpegs on certain models with footboards. When folded, the footboard displays a mirror-chrome surface in your choice of Smooth or ball-milled Grooved design. Footboard inserts and footboard supports sold separately.

Fits '86-later Touring models (except Trike), '00-later Softail® models and '06-later Dyna® models equipped with passenger footboard supports.

**50716-04** Smooth. **\$139.95**  
**50357-04** Grooved. **\$169.95**

**H. HALF-MOON PASSENGER FOOTBOARDS**

Styled to match the Half Moon Rider Footboards, these classic passenger footboards add both style and comfort to your nostalgic ride. Available in mirror-finish chrome or gloss black finish, the kit includes left and right footboard pan and vibration-isolation footboard inserts. Model-specific footboard mounts are sold separately.

Fits '86-later Touring (except Trike), '00-later Softail® and '06-later Dyna models equipped with passenger footboard supports.

**50807-08** Chrome. **\$179.95**  
**50810-08** Gloss Black. **\$179.95**

*Notice: The prices appearing in this catalog are the manufacturer's suggested retail prices. Actual retail prices may vary.*



# 570 CONTROLS

## Highway Pegs

### A. CHROME BILLET ENGINE GUARD FOOTPEG MOUNTING KIT\*

Here's a stylish way to get your feet into the wind. This beautifully polished and chrome-plated billet aluminum footpeg mount kit installs easily on your engine guard, and lets you stretch your legs on cross-country rides. Works with all H-D style male-mount footpegs.

**50957-02B** \$99.95

Fits front engine guards with 1-1/4" diameter tubing (except VRSC™ Guard P/N 49267-01A, 49388-09, XL Engine Guard P/N 49060-04, 49215-07 or Softail® Nostalgic Engine Guard P/N 49037-05). Requires separate purchase of Chrome Bullet Tip Footpeg Bolt Kit P/N 94133-01.

### B. ADJUSTABLE HIGHWAY PEG MOUNTING KIT – 360°\*

Change your foot position for added comfort on long stretches of open road. The 360° Adjustable Highway Peg can be rotated and locked in a wide range of positions to accommodate both the tall and short rider. The chrome-plated clamp holds its place on the engine guard, and the arm locks the peg securely in position. Kit includes chrome-plated mount, arm, and installation hardware. Footpegs sold separately.

**50832-07A** Fits 1-1/4" engine guards. \$109.95

### C. ADJUSTABLE HIGHWAY PEG MOUNTING KIT – ANGLED\*

Stretch out for added comfort. This chrome-plated Adjustable Highway Peg Mounting Kit can be set for shorter riders, and it can be reversed to reach far forward for those with long legs. The angled design allows the arm to reach back and around to clear fairing lowers. The arm can be raised and lowered for a custom fit. The mounting clamp firmly grips the engine guard, and the locking design secures the peg at the desired angle. Kit includes chrome-plated mounting hardware. Footpegs sold separately.

#### Long Angled

**50829-07A** Fits 1-1/4" engine guards. \$109.95

#### Short Angled

**50830-07A** Fits 1-1/4" engine guards. \$109.95

### D. ADJUSTABLE HIGHWAY PEG MOUNTING KIT – OFFSET\*

Take rider comfort to the next level. These Offset Adjustable Highway Peg Mounts allow the rider a wide range of adjustment to accommodate nearly every shape and size. The offset design allows installation on the side or top of the engine guard, and the 360° rotation permits comfortable positioning for short or tall riders. The clamp securely grips the engine guard, and the locking design keeps the peg at the desired angle. Kit includes chrome-plated clamp, adjustable arm, and chrome mounting hardware. Footpegs are sold separately.

#### Long Offset

**50827-07A** Fits 1-1/4" engine guards. \$129.95

#### Short Offset

**50828-07A** Fits 1-1/4" engine guards. \$129.95



A. CHROME BILLET ENGINE GUARD FOOTPEG MOUNTING KIT



B. ADJUSTABLE HIGHWAY PEG MOUNTING KIT – 360°



C. ADJUSTABLE HIGHWAY PEG MOUNTING KIT – LONG ANGLED



C. ADJUSTABLE HIGHWAY PEG MOUNTING KIT – SHORT ANGLED



D. ADJUSTABLE HIGHWAY PEG MOUNTING KIT – LONG OFFSET



D. ADJUSTABLE HIGHWAY PEG MOUNTING KIT – SHORT OFFSET



**\*WARNING:** Engine guards may provide limited leg and cosmetic vehicle protection under unique circumstances (fall over while stopped, very low speed slide). They are not made nor intended to provide protection from bodily injury in a collision with another vehicle or any other object.



**\*WARNING:** Do not use engine guard footpegs under normal stop and go operating conditions. Doing so could result in death or serious injury.



**\*WARNING:** Do not use highway pegs under normal stop and go operating conditions. Doing so could result in death or serious injury.

Notice: The prices appearing in this catalog are the manufacturer's suggested retail prices. Actual retail prices may vary.





**E. ENGINE GUARD FOOTPEG MOUNTING KIT**



**F. ENGINE GUARD FOOTPEG MOUNT CHROME HARDWARE KIT**

**E. ENGINE GUARD FOOTPEG MOUNTING KIT\***

Allows easy installation of any H-D® male-mount style footpegs on to H-D front engine guards. All pieces necessary are included in the kit, with no extra hardware to buy.

**50964-98** **\$39.95**

Fits 1-1/4" engine guards (except VRSC™ Guard P/N 49267-01A, 49388-09, XL Engine Guard P/N 49060-04 or Softail® Nostalgic Engine Guard P/N 49037-05).

**F. ENGINE GUARD FOOTPEG MOUNT CHROME HARDWARE KIT\***

Jump from zinc to chrome with this chrome-plated hardware kit, which replaces the standard hardware in Engine Guard Footpeg Mounting Kit P/N 50964-98. Made to Original Equipment standards for unmatched quality, the bolts bear the "Harley-Davidson" mark to signify they're the genuine article.

**94140-02** **\$16.95**

Fits Engine Guard Footpeg Mounting Kit P/N 50964-98 and 50957-02B.

**G. FOOTPEG SUPPORTS WITH HARDWARE\***

**50900-72TA** **\$29.95**

Fits late '72-'81 FX, '84-'99 FXST, and '83-'94 FXR models. (pair)

**H. FOOTPEG THREE-PIECE CHROME CLAMPS\***

For use on frame or engine guard. Universal mount except VRSC models.

**50904-85T** 1" diameter. **\$9.95**

**50903-85T** 1-1/4" diameter. **\$9.95**

**I. CUSTOM "HARLEY"® SCRIPTED FOOTPEGS\***

These chrome-plated footpegs sport a gold-tone inlay of the "Harley" logo. Easy-to-install by clamping onto engine guard.

**49102-86T** **\$39.95**

Fits 1" and 1-1/4" bars (except VRSC™, XL883N and XL1200N models).

**J. ENGINE GUARD MOUNT FOOTPEGS\***

Chrome-plated with rubber inserts.

**49144-86** **\$26.95**

Fits H-D engine guards except VRSC models.



**G. FOOTPEG SUPPORTS WITH HARDWARE**



**H. FOOTPEG THREE-PIECE CHROME CLAMPS**



**I. CUSTOM "HARLEY" SCRIPTED FOOTPEGS**



**J. ENGINE GUARD MOUNT FOOTPEGS**



**\*WARNING:** Engine guards may provide limited leg and cosmetic vehicle protection under unique circumstances (fall over while stopped, very low speed slide). They are not made nor intended to provide protection from bodily injury in a collision with another vehicle or any other object.



**\*WARNING:** Do not use engine guard footpegs under normal stop and go operating conditions. Doing so could result in death or serious injury.



**\*WARNING:** Do not use highway pegs under normal stop and go operating conditions. Doing so could result in death or serious injury.

Notice: The prices appearing in this catalog are the manufacturer's suggested retail prices. Actual retail prices may vary.

# 572 CONTROLS

## Mirrors

### A. SPLIT VISION MIRRORS\*

See even more of the world you just passed. This exclusive-design Split Vision Mirror minimizes blind spots and provides a wide panoramic rear view of the left and right lane, and the road behind you. The mirror features a large primary panel for normal view, and a second outboard convex panel for a wider field of vision. Chrome-plated to a brilliant shine, the mirror's shape adds a contemporary touch to the traditional teardrop design. The deep embossed "Harley-Davidson" script and the curving slotted stem set this mirror apart from the others.

**92190-06** **\$119.95**  
Fits '82-later models (except VRSCF). (pair)

### B. MIRRORS WITH AUXILIARY RUNNING LIGHT AND DIRECTIONAL INDICATOR\*

Function and style in one package. This forged mirror combines a traditional swept shape with a contemporary addition – forward-facing auxiliary lighting. Smoked lenses hide bands of amber LED lamps that glow as running lamps when the ignition is on, and add a fast-acting auxiliary directional indicator when the turn signals are activated. The forward-facing eye-level lamps command additional attention from oncoming traffic. Both mirrors flash when the emergency hazard lights are activated. The wiring is concealed in the housing and stem, and is easily connected to the Original Equipment wiring harness. Available in mirror-chrome or satin black finish.

Fits '97-later models (except VRSCF). (pair)  
**92059-07** Chrome. **\$299.95**  
**92068-08** Satin Black. **\$299.95**

### C. TRIBAL COLLECTION MIRRORS\*

Billet-style mirror features a tapered shape that provides excellent rearward visibility. The deeply grooved stem and the swept-back design hug the contour of the handlebar, and the tribal flames add an element of ancient mystery. The distinctive cast-in recesses of the tribal layout highlight the details in the metal work, and add depth and dimension to the gloss black or polished chrome finish. Design complements the available Tribal Collection hand grips, footpegs and foot controls.

Fits '82-later models (except VRSCF). (pair)  
**92410-09** Chrome. **\$129.95**  
**92398-09** Gloss Black. **\$129.95**



A. SPLIT VISION MIRROR



A. SPLIT VISION MIRROR



B. MIRROR WITH AUXILIARY RUNNING LIGHT AND DIRECTIONAL INDICATOR



C. TRIBAL COLLECTION MIRROR – CHROME

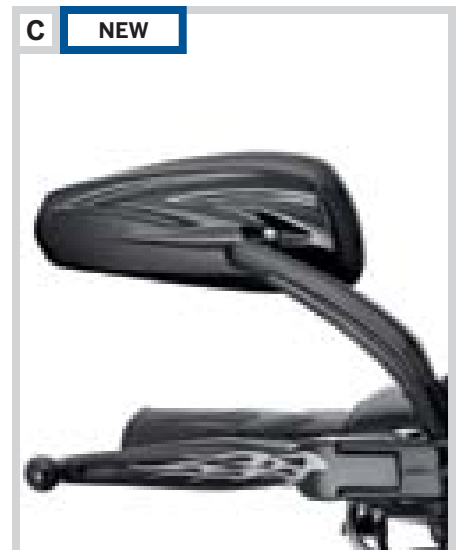

C. TRIBAL COLLECTION MIRROR – GLOSS BLACK

\*Harley-Davidson Motor Company cannot test and make specific fitment recommendations concerning every possible mirror and handlebar combination. Therefore, after installing new mirrors or handlebars, and before operating the motorcycle, check to ensure that the mirrors provide the operator a clear view to the rear.

Notice: The prices appearing in this catalog are the manufacturer's suggested retail prices. Actual retail prices may vary.



**D. BUCKSHOT MIRROR – CHROME**



**D. BUCKSHOT MIRROR – SATIN BLACK**

**D. BUCKSHOT MIRRORS\***

The deep grooved and perforated stem of this custom mirror is the ideal complement to the Buckshot Collection of foot and hand controls. The tapered mirror and stem are polished and chrome-plated or black-coated for a deep luster.

Fits '82-later models (except VRSCF). (pair)

<b>92096-05</b>	Chrome.	<b>\$219.95</b>
<b>92416-08</b>	Satin Black.	<b>\$219.95</b>

**E. DOME BILLET STYLE MIRRORS\***

This special mirror features a smooth, dome-shaped billet head, unique single slot stem, and a mirror-chrome or satin black finish. It's a clean look that provides distinctive style. Made in the U.S.A.

Fits '82-later models (except VRSCF). (pair)

<b>92423-08</b>	Satin Black.	<b>\$199.95</b>
<b>91519-99</b>	Chrome.	<b>\$199.95</b>

**F. PROFILE CUSTOM MIRRORS WITH SLOTTED STEM\***

Billet-style mirror features a low-profile swept back design, slotted stem, and a laser etched "Harley-Davidson" script on mirror back. The teardrop shape provides excellent rearward visibility, and the slim lines add a true custom touch.

**91697-06A** **\$139.95**

Fits '82-later models (except VRSCF). (pair)

**G. TAILFIN CUSTOM MIRRORS\***

This billet-style swept Tailfin Mirror offers a unique view of the road behind you. The finned mirror back and the custom raised-rib mirror stem combine to bring the art deco "streamliner" look into the 21st century. The die-cast mirror body and forged stem are polished and chrome-plated for a brilliant finish.

**91696-05A** **\$99.95**

Fits '82-later models (except VRSCF). (pair)



**E. DOME BILLET STYLE MIRROR – SATIN BLACK**



**E. DOME BILLET STYLE MIRROR – CHROME**



**F. PROFILE CUSTOM MIRROR WITH SLOTTED STEM**



**G. TAILFIN CUSTOM MIRROR**

\*Harley-Davidson Motor Company cannot test and make specific fitment recommendations concerning every possible mirror and handlebar combination. Therefore, after installing new mirrors or handlebars, and before operating the motorcycle, check to ensure that the mirrors provide the operator a clear view to the rear.

Notice: The prices appearing in this catalog are the manufacturer's suggested retail prices. Actual retail prices may vary.

# 574 CONTROLS

## Mirrors

### A. BULLET MIRRORS\*

This sweeping teardrop-shaped mirror is manufactured from forged aluminum, and beautifully chrome-plated for a custom appearance. The "bullet grooved" curved stem and the smooth mirror housing are highlighted with a laser-etched "Harley-Davidson" script.

**91657-02** **\$219.95**  
Fits '82-later models (except VRSCF). (pair)

### B. THE WILLIE G.® SKULL COLLECTION TEARDROP MIRRORS\*

Add a little attitude to your ride. Styled to complement Harley-Davidson Skull accessory items, the menacing raised skull with black-filled eyes leaps from a field of chrome. The surrounding "Harley-Davidson Motorcycles" script is the perfect finishing touch. The teardrop shape improves rearward visibility.

**91315-04** **\$109.95**  
Fits '82-later models (except VRSCF). (pair)

### C. OVAL ALUMINATOR BILLET STYLE MIRRORS\*

Some people would call this a collection that is precision-made by computer-controlled machinery which produces rare shapes, beveled edges, subtle counterbores and distinctive ovals. We call it the Aluminator Collection. Signature Aluminator styling gets added function with a specially machined stem and convex lens that allow adjustments for the optimum field of view. Both the extruded aluminum stem and forged aluminum head are machined, polished and chrome-plated. Made in the U.S.A.

**91965-98** **\$199.95**  
Fits '82-later models (except VRSCF). (pair)

### D. ONE-PIECE ROUND MIRROR\*

Fits all models (except VRSCF).

**91931-92T** Short Stem, Left Side. **\$19.95**  
**91930-92T** Short Stem, Right Side. **\$19.95**

### E. TEARDROP MIRRORS\*

High-profile custom mirrors at a great price. These beautifully chrome-plated mirrors are available in two styles, Classic and Script. They feature laser-etched convex glass and black, color-filled graphics.

Fits '82-later models (except VRSCF). (pair)

**91971-98** Classic. **\$99.95**  
**91968-98** "Harley-Davidson" Script. **\$99.95**



A. BULLET MIRROR



B. THE WILLIE G. SKULL COLLECTION TEARDROP MIRROR



C. OVAL ALUMINATOR BILLET STYLE MIRROR

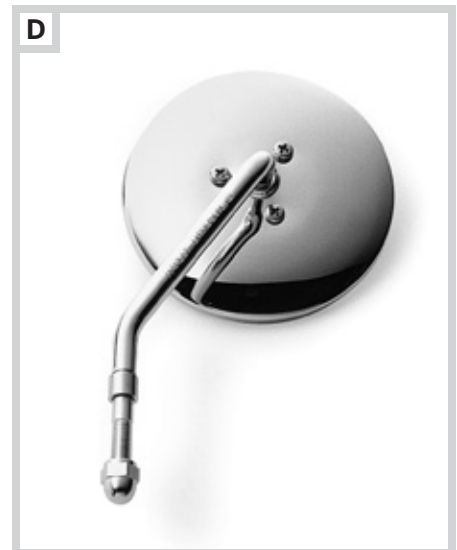

D. ONE-PIECE ROUND MIRROR



E. TEARDROP MIRROR - CLASSIC



E. TEARDROP MIRROR - "HARLEY-DAVIDSON" SCRIPT

\*Harley-Davidson Motor Company cannot test and make specific fitment recommendations concerning every possible mirror and handlebar combination. Therefore, after installing new mirrors or handlebars, and before operating the motorcycle, check to ensure that the mirrors provide the operator a clear view to the rear.

Notice: The prices appearing in this catalog are the manufacturer's suggested retail prices. Actual retail prices may vary.





F. FLAMES COLLECTION MIRROR



G. "LIVE TO RIDE" LOGO COLLECTION MIRRORS



H. TAPERED MIRRORS – BLACK



I. TAPERED MIRRORS – CHROME



J. BLACK LONG-STEM ONE-PIECE MIRROR



K. CHROME TWO-PIECE MIRROR



L. DIE-CAST MIRROR WITH "HARLEY DAVIDSON" SCRIPT LOGO – ONE-PIECE



M. MIRROR EXTENSION KIT

**F. FLAMES COLLECTION MIRRORS\***

Fits '65-later models (except VRSCF).

<b>91940-98</b>	Short Stem, Left.	<b>\$37.95</b>
<b>91939-98</b>	Short Stem, Right.	<b>\$37.95</b>

**G. "LIVE TO RIDE" LOGO COLLECTION MIRRORS\***

Fits '65-later models (except VRSCF).

**1. One-Piece Short Stem Mirrors**

<b>91866-90T</b>	Gold, Left.	<b>\$37.95</b>
<b>91864-90T</b>	Gold, Right.	<b>\$37.95</b>
<b>91865-90T</b>	Chrome, Left.	<b>\$29.95</b>
<b>91863-90T</b>	Chrome, Right.	<b>\$29.95</b>

**2. One-Piece Long Stem Mirrors**

<b>91871-93T</b>	Gold, Left.	<b>\$39.95</b>
<b>91861-93T</b>	Gold, Right.	<b>\$39.95</b>
<b>91874-93T</b>	Chrome, Left.	<b>\$29.95</b>
<b>91862-93T</b>	Chrome, Right.	<b>\$29.95</b>

**H. TAPERED MIRRORS – BLACK\***

Update your Harley® motorcycle with the latest style in mirrors. This tapered-style mirror, introduced on the 2003 Anniversary models, improves rearward visibility, offers a wider range of adjustment, and eliminates the rear fasteners for a cleaner look.

Fits '65-later models (except VRSCF).

<b>92023-03A</b>	Short Stem Kit, Left and Right.	<b>\$69.95</b>
<b>91982-03B</b>	Short Stem, Right.	<b>\$34.95</b>
<b>91983-03B</b>	Short Stem, Left.	<b>\$34.95</b>
<b>91909-03B</b>	Long Stem, Right.	<b>\$34.95</b>
<b>91910-03B</b>	Long Stem, Left.	<b>\$34.95</b>

**I. TAPERED MIRRORS – CHROME\***

Update your Harley motorcycle with the latest style in mirrors. This tapered-style mirror, introduced on the 2003 Anniversary models, improves rearward visibility, offers a wider range of adjustment, and eliminates the rear fasteners for a cleaner look.

Fits '65-later models (except VRSCF).

<b>92022-03A</b>	Short Stem Kit, Left and Right.	<b>\$72.95</b>
<b>91840-03B</b>	Short Stem, Right.	<b>\$36.95</b>
<b>91845-03B</b>	Short Stem, Left.	<b>\$36.95</b>
<b>91846-03B</b>	Long Stem, Right.	<b>\$36.95</b>
<b>91848-03B</b>	Long Stem, Left.	<b>\$36.95</b>

**J. BLACK LONG STEM ONE-PIECE MIRRORS\***

Fits '65-later models (except VRSCF).

<b>91910-90A</b>	Long Stem, Left Side.	<b>\$28.95</b>
<b>91909-90A</b>	Long Stem, Right side. (not shown)	<b>\$28.95</b>
<del><b>91878-77A</b></del>	<del>Long Stem, Right or Left Side. (not shown)</del>	<del><b>\$26.95</b></del>

**K. CHROME TWO-PIECE MIRRORS\***

Fits '65-later models (except VRSCF).

<b>91875-70B</b>	Short Stem, Right or Left Side.	<b>\$28.95</b>
<b>91879-67B</b>	Long Stem, Right or Left Side. (not shown)	<b>\$26.95</b>

**L. DIE-CAST MIRRORS WITH "HARLEY-DAVIDSON" SCRIPT LOGO\***

Fits all models (except VRSCF).

**Short Stem, One-Piece**

<b>91921-91T</b>	Left Side.	<b>\$19.95</b>
<b>91920-91T</b>	Right Side.	<b>\$19.95</b>

**M. MIRROR EXTENSION KIT\***

Chrome-plated extenders relocate mirrors approximately two inches higher.

<b>91907-87</b>	Fits all models (except VRSCF). (pair)	<b>\$29.95</b>
-----------------	--	----------------

\*Harley-Davidson Motor Company cannot test and make specific fitment recommendations concerning every possible mirror and handlebar combination. Therefore, after installing new mirrors or handlebars, and before operating the motorcycle, check to ensure that the mirrors provide the operator a clear view to the rear.

Notice: The prices appearing in this catalog are the manufacturer's suggested retail prices. Actual retail prices may vary.

# 576 CONTROLS

## Handlebars

### HANDLEBAR BASICS\*

Bars communicate style and also affect how you handle your bike. You want to select a handlebar that puts your arms in a position that matches both the attitude you want to convey and the kind of riding you expect to do. While every handlebar has its own distinct measurements and characteristics, there are four basic factors to consider in your quest for custom-styled comfort:

**Rise** is the vertical distance between a handlebar's tip and its base. Adding risers to bars that sit low can help put hand grips in a higher spot.

**Pull Back** brings hand controls closer while also lowering grip height. More pullback facilitates an upright posture, and suits riders with a shorter reach.

**Width** is measured from the tip of one hand grip to the other. Touring calls for a wider bar, while sport riding is best with a narrower tip-to-tip width.

**Knurl Center to Center** is the distance between the center of one knurl to the center of the other knurl. To ensure correct fit between the handlebar and risers, measure the center to center distance between the riser clamping surfaces and select a handlebar with the same dimension.

\*NOTE: Installation of some handlebars and risers may require a change in clutch and/or throttle cable and brake hose for some models. Handlebar height is regulated in many states. Check state or local laws before installation.

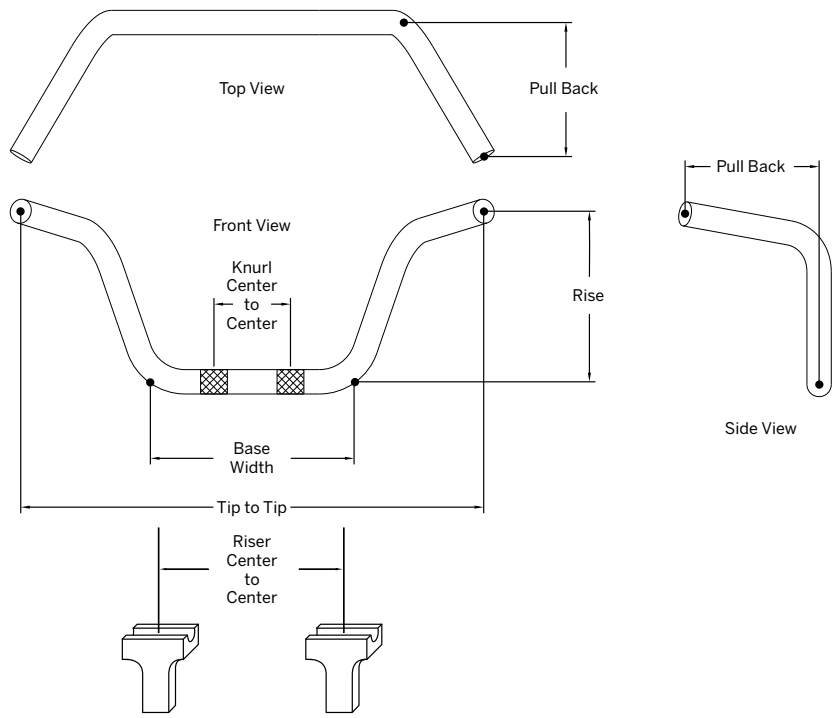

Handlebar Measurements

### Handlebar Dimensions (In Inches)

Handlebar	Tip to Tip	Base Width	Pull Back	Knurl Center-to-Center	Rise (Tip-to-Base) (Outside)
55835-05A	31.75	3.50	4.75	—	11.00
55861-09	30.25	15.75	6.25	3.50	9.75
55862-09	31.50	10.50	9.50	3.14	6.75
55864-09	31.25	11.50	5.00	3.14	12.00
55865-09	30.25	15.75	6.25	3.50	9.75
55866-09	31.50	10.50	9.50	3.14	6.75
55908-04	30.50	13.50	11.00	3.14	8.00
55908-08 OBSOLETE	<del>30.50</del>	<del>13.50</del>	<del>11.00</del>	<del>3.14</del>	<del>10.00</del>
55914-98	30.75	15.00	7.50	3.50	12.25
55919-82 OBSOLETE	<del>32.50</del>	<del>14.25</del>	<del>9.00</del>	<del>3.50</del>	<del>5.00</del>
55919-82T	32.50	14.25	9.00	3.50	5.00
55920-83B	29.75	13.25	5.75	3.50	9.50
55924-97	30.25	15.75	6.25	3.50	9.75
55934-89	26.75	9.75	9.00	3.14	4.00
55934-92	26.75	9.75	9.00	3.14	4.00
55943-05	30.75	18.75	8.00	4.75	8.25
55954-00	30.00	13.75	9.00	3.14	9.50
55955-00A	32.00	11.50	3.50	3.14	10.50
55958-01	31.50	13.50	9.00	3.50	4.75
55967-08	35.50	12.25	4.75	3.50	11.50
55972-00	31.00	7.75	5.75	3.14	6.00
55975-08A	30.25	9.00	5.75	—	6.75
55977-09	30.75	6.50	7.00	3.50	0.00
55985-10	30.25	9.00	5.75	—	6.75
56004-00	31.00	7.75	5.75	3.14	6.00
56021-04B	31.00	8.75	5.75	4.25	6.00
56029-00	28.00	8.00	6.25	3.50	10.00
56032-08	31.50	9.00	7.50	3.25	9.75
56036-08	31.75	15.75	6.50	3.50	10.00
56039-03A	30.00	3.50	8.00	—	12.50
56055-01 OBSOLETE	<del>30.25</del>	<del>8.50</del>	<del>4.75</del>	<del>3.14</del>	<del>3.75</del>
56075-07	32.00	10.00	6.50	3.14	8.75
56079-93	32.00	10.00	6.50	3.14	8.75
56079-93T	32.00	10.00	6.50	3.14	8.75
56081-82A	25.50	10.00	9.50	3.14	3.25
56081-82T	26.75	9.00	9.00	3.14	4.25
56082-83	26.75	6.50	4.75	3.14	4.00
56082-83T	26.75	6.50	4.75	3.14	4.00
56085-83A	31.00	7.75	5.75	3.14	6.00
56085-83T	31.00	7.75	5.75	3.14	6.00
56086-81	25.00	8.80	9.75	3.14	6.25
56086-81T	25.00	8.80	9.75	3.14	6.25
56093-88A	25.50	12.00	9.75	4.75	3.75
56102-99	30.00	11.75	9.25	3.14	5.25

Handlebar	Tip to Tip	Base Width	Pull Back	Knurl Center-to-Center	Rise (Tip-to-Base) (Outside)
56103-08 / 56273-08	31.50	—	7.00	3.50	11.50
56110-98	26.75	6.50	4.75	3.14	4.00
56113-98	28.00	8.00	6.25	3.50	5.25
56150-04	28.75	7.50	6.25	2.78	9.75
56152-04B	32.00	13.00	6.25	3.14	11.25
56154-04	30.00	11.75	9.25	3.14	5.25
56166-08	32.00	13.00	5.50	3.14	11.25
56176-08	30.75	15.25	7.50	3.50	12.25
56180-08	30.00	13.75	9.00	3.14	9.50
56184-08	34.00	17.00	5.00	3.50	9.75
56330-00	31.25	9.00	4.25	3.50	8.00
55975-08A	30.25	9.00	5.75	—	6.75
56422-02C	30.50	7.75	5.75	3.50	4.75
56434-98	27.00	8.50	4.00	3.14	n/a
56473-98 OBSOLETE	<del>28.00</del>	<del>8.00</del>	<del>6.25</del>	<del>3.50</del>	<del>5.25</del>
56528-02	30.25	8.75	2.00	—	7.00
56533-02A	28.25	8.50	1.50	—	10.75
56552-95 OBSOLETE	<del>31.50</del>	<del>12.50</del>	<del>9.00</del>	<del>3.14</del>	<del>5.50</del>
56556-95 OBSOLETE	<del>28.50</del>	<del>12.25</del>	<del>9.25</del>	<del>3.14</del>	<del>3.00</del>
56557-95	31.25	11.50	9.00	3.50	6.25
56558-95	27.00	8.50	4.00	3.14	n/a
56562-95 OBSOLETE	<del>30.50</del>	<del>10.50</del>	<del>9.50</del>	<del>3.14</del>	<del>6.00</del>
56563-95	31.50	9.50	5.50	3.14	9.75
56569-86	31.25	11.50	5.00	3.14	12.00
56570-98	31.50	10.50	9.50	3.14	6.75
56571-98A	32.00	11.50	3.50	3.14	10.50
56621-99	29.25	8.25	3.25	3.14	7.50
56623-99	31.25	11.50	5.00	3.14	12.00
56624-99	25.50	12.00	9.75	4.75	3.75
56625-99	30.25	15.75	6.25	3.50	9.75
56675-05	33.25	12.00	9.50	3.14	8.25
56700-03A	33.25	12.00	9.50	3.14	8.25
56760-04	35.50	12.25	4.75	4.75	12.00
56793-05	30.25	—	5.75	—	n/a
56832-04	33.75	10.00	7.25	3.22	8.25
56855-05	35.75	12.25	4.75	3.12	12.00
56856-05	35.75	12.25	4.75	3.12	12.00
56857-05	32.60	9.00	6.60	3.14	9.01
56902-08	31.25	11.50	5.00	3.14	12.00
56940-09	30.75	18.75	8.00	4.75	8.25
56941-09	34.00	11.50	3.25	3.24	4.00
56947-08	28.00	—	5.25	3.50	9.00
56964-07	34.00	17.00	5.00	3.50	9.75
56981-07	30.50	7.00	3.25	3.50	3.50



**A. BEACH BAR HANDLEBAR – SPRINGER MODELS**

**A. BEACH BAR HANDLEBAR – SPRINGER® MODELS\***

This beefy 1-1/4" bar shows off your bike in style! This fat bar allows you to tuck the wires inside the bar for a clean, custom appearance, and the highly polished and chrome-plated bar will get you noticed. Installation requires separate purchase of additional components.

**56760-04** **\$199.95**

Fits '00-'07 FXSTS, FLSTS, FLSTSC and '08-later FLSTSB Springer models. All models require separate purchase of Riser Kit P/N 56850-04 and additional components for installation. Does not fit with Heated Hand Grips, Hydraulic Clutch Kits, or Handlebar Mounted Gauges.

**Beach Handlebar (56760-04)**

2000-2006 FXSTS	OEM Stock	Stainless Steel Braided	Diamondback™	Diamond-Black
Clutch Cables	Stock 38666-00	38674-03	38851-09	38818-10
Throttle / Idle Cables	Stock 56306-96 / 56305-96	56720-03	Not available	Not available
Brake Lines	Not available	45192-04	Not available	Not available
Riser Kit	56850-04	56850-04	56850-04	56850-04
Spring	46058-97	46058-97	46058-97	46058-97
Washer (Qty 2)	6756	6756	6756	6756
Fork Leg Stud (Qty 2)	56550-97	56550-97	56550-97	56550-97

**2000-2003 FLSTS, 2005-2007 FLSTSC & 2008-later FLSTSB**

Clutch Cables ('00-'06 models)	Stock 38666-00	38674-03	38851-09	38818-10
Clutch Cables ('07-'10 models)	Stock 38666-07A	Not available	38851-09	38818-10
Throttle / Idle Cables	Stock 56343-01 / 56342-01	56344-03A	56807-05A	Not available
Brake Lines	Not available	45783-02	46693-06	Not available
Riser Kit	56850-04	56850-04	56850-04	56850-04
Screw	3538	3538	3538	3538
Spacer	5989	5989	5989	5989
Front Directional Mounting Kit ('08-later FLSTSB models)	68266-03	68266-03	68266-03	68266-03
Turn Signal Wire Extension Kit ('00-'03 FLSTS models)	72137-03	72137-03	72137-03	72137-03
Turn Signal Wire Extension Kit ('05-'07 FLSTSC & '08-later FLSTSB models)	55912-06	55912-06	55912-06	55912-06

\*NOTE: Installation of some handlebars and risers may require a change in clutch and/or throttle cable and brake hose for some models. Handlebar height is regulated in many states. Check state or local laws before installation.

Notice: The prices appearing in this catalog are the manufacturer's suggested retail prices. Actual retail prices may vary.

# 578 CONTROLS

## Handlebars

### A. BEACH BAR HANDLEBAR\*

This beefy 1-1/4" bar shows off your bike in style! This fat bar allows you to tuck the wires inside the bar for a clean, custom appearance, and the highly polished and chrome-plated bar will get you noticed. Installation requires separate purchase of additional components.

**55967-08 \$179.95**

Fits '06-'07 FXDB, '08-later FXDF, '02-'05 FXDL, '99-later FXDWG, '00-later FXST, FXSTB, FXSTC, FXSTD, FLSTC, FLSTF, FLSTFB and '03-later FLHR, FLHRC, FLHRS models. All models require separate purchase of additional installation components. Does not fit '08 ABS equipped models, Heated Hand Grips, Hydraulic Clutch Kits, Handlebar Mounted Gauges, Road Tech Radio, Softail Nacelle Kit P/N 67907-96C or Sidecar-equipped models.

*Notice: The prices appearing in this catalog are the manufacturer's suggested retail prices. Actual retail prices may vary.*



A. BEACH BAR HANDLEBAR – SHOWN ON ROAD KING MODEL

### Beach Handlebar (55967-08)

2001-2005 FXDL	OEM Stock	Stainless Steel Braided	Diamondback™	Diamond-Black
Clutch Cables	Not available	Not available	38852-09	38875-09A
Throttle / Idle Cables	Stock 56356-96 / 56355-96	56579-02A	56805-05A	38918-09
Brake Lines	Not available	Not available	Upper 42907-07 / Lower 42371-07	Upper N/A / Lower 48920-10
Riser Kit	56916-07	56916-07	56916-07	56916-07
Brake / Throttle Clip	70488-02	70488-02	70488-02	70488-02
Turn Signal Wire Extension Kit	72137-03	72137-03	72137-03	72137-03
Switch Wire Extension (4") – Left	72140-03	72140-03	72140-03	72140-03
Switch Wire Extension (4") – Right	72141-03	72141-03	72141-03	72141-03
<b>1999-2005 FXDWG</b>				
Clutch Cables	Stock 38661-00	56590-02	38854-09	38916-09A
Throttle / Idle Cables	Stock 56356-96 / 56355-96	56579-02A	56805-05A	38918-09
Brake Lines	Not available	Not available	Upper 42905-07 / Lower 42366-07	Not available
Riser Kit	56916-07	56916-07	56916-07	56916-07
Brake / Throttle Clip	70488-02	70488-02	70488-02	70488-02
<b>2006-2008, 2010 FXDWG</b>				
Clutch Cables	Stock 38789-06B	Not available	38854-09	38916-09A
Throttle / Idle Cables	Stock 56356-96A / 56355-96A	56579-02A	55700-07	38957-09
Brake Lines	Not available	Not available	Upper 42774-07 / Lower 42108-07	Upper N/A / Lower 48926-10
Riser Kit	56916-07	56916-07	56916-07	56916-07
Brake / Throttle Clip	70488-02	70488-02	70488-02	70488-02
<b>2006-2007 FXDB</b>				
Clutch Cables	Stock 38789-06B	Not available	38854-09	38916-09A
Throttle / Idle Cables	Stock 56356-96A / 56355-96A	56579-02A	55700-07	38957-09
Brake Lines	Not available	Not available	Upper 42774-07 / Lower 42110-07	Not available
Riser Kit	56916-07	56916-07	56916-07	56916-07
Brake / Throttle Clip	70488-02	70488-02	70488-02	70488-02
<b>2008-later FXDF</b>				
Clutch Cables	38789-06B	Not available	38854-09	38916-09A
Throttle / Idle Cables	56356-96A / 56355-96A	56579-02A	55700-07	38957-09
Brake Lines	Not available	Not available	Upper 44213-08 / Lower 42112-08A	Not available
Riser Kit	56916-07	56916-07	56916-07	56916-07
Brake / Throttle Clip	70488-02	70488-02	70488-02	70488-02
<b>2000-later FXST</b>				
Clutch Cables ('00-'06 models)	Stock 38666-00	38674-03	38851-09	38818-10
Clutch Cables ('07-'10 models)	Stock 38666-07A	Not available	38851-09	38818-10
Throttle / Idle Cables	Stock 56343-01 / 56342-01	56344-03A	56807-05A	38954-09
Brake Lines	Not available	Not available	Upper 42768-07 / Lower 42366-07	Not available
Riser Kit	56916-07	56916-07	56916-07	56916-07
<b>2000-2009 FXSTB</b>				
Clutch Cables ('00-'06 models)	38666-00	38674-03	38851-09	38818-10
Clutch Cables ('07-'09 models)	38666-07A	Not available	38851-09	38818-10
Throttle / Idle Cables	56343-01 / 56342-01	56344-03A	56807-05A	38954-09
Brake Lines	Not available	Not available	Upper 42768-07 / Lower 42366-07	Not available
Riser Kit	56916-07	56916-07	56916-07	56916-07
Switch Wire Extension (10") – Left ('00-'06 models)	72150-03	72150-03	72150-03	72150-03
Switch Wire Extension (10") – Right ('00-'06 models)	72151-03	72151-03	72151-03	72151-03
Switch Wire Extension (10") – Left & Right ('07-'09 models)	70234-07	70234-07	70234-07	70234-07



## Beach Handlebar (55967-08)

2007-later FXSTC	OEM Stock	Stainless Steel Braided	Diamondback™	Diamond-Black
Clutch Cables	Stock 38666-07A	Not available	38851-09	38818-10
Throttle / Idle Cables	56343-01 / 56342-01	56344-03A	56807-05A	38954-09
Brake Lines	Not available	Not available	Upper 42768-07 / Lower 42366-07	Not available
Riser Kit	56916-07	56916-07	56916-07	56916-07

## 2000-2007 FXSTD

Clutch Cables ('00-'06 models)	38666-00	38674-03	38851-09	38818-10
Clutch Cables ('07 models)	38666-07A	Not available	38851-09	38818-10
Throttle / Idle Cables	56343-01 / 56342-01	56344-03A	56807-05A	38954-09
Brake Lines	Not available	Not available	Upper 42768-07 / Lower 42366-07	Not available
Riser Kit	56916-07	56916-07	56916-07	56916-07
Mount Spacer (Qty 2)	6740	6740	6740	6740
Switch Wire Extension (4") – Left ('00-'06 models)	72140-03	72140-03	72140-03	72140-03
Switch Wire Extension (4") – Right ('00-'06 models)	72141-03	72141-03	72141-03	72141-03
Switch Wire Extension (4") – Left & Right ('07 models)	70229-07	70229-07	70229-07	70229-07

## 2000-2008 FLSTC

Clutch Cables ('00-'06 models)	Stock 38666-00	56414-03	38851-09	38818-10
Clutch Cables ('07-'08 models)	Stock 38666-07A	Not available	38851-09	38818-10
Throttle / Idle Cables	Stock 56343-01 / 56342-01	56344-03A	56805-05A	38918-09
Brake Lines	Not available	Not available	Upper 42772-07 / Lower 42371-07	Not available
Riser Kit	56916-07	56916-07	56916-07	56916-07

## 2009-later FLSTC

Clutch Cables	Not available	Not available	38851-09	38818-10
Throttle / Idle Cables	Not available	56344-03A	56805-05A	38918-09
Brake Lines	Not available	Not available	Upper 42772-07 / Lower 42371-07	Not available
Riser Kit	56916-07	56916-07	56916-07	56916-07

## 2000-later FLSTF

Clutch Cables ('00-'06 models)	Stock 38666-00	56414-03	38851-09	38818-10
Clutch Cables ('07-'10 models)	38666-07A	Not available	38851-09	38818-10
Throttle / Idle Cables	Stock 56343-01 / 56342-01	56344-03A	56805-05A	38918-09
Brake Lines	Not available	Not available	Upper 42772-07 / Lower 42371-07	Not available
Riser Kit	56916-07	56916-07	56916-07	56916-07

## 2010-later FLSTFB

Clutch Cables	Not available	Not available	38851-09	38818-10
Throttle / Idle Cables	Not available	56344-03A	56805-05A	38918-09
Brake Lines	Not available	Not available	Upper 42772-07 / Lower 42371-07	Not available
Riser Kit	56916-07	56916-07	56916-07	56916-07
Switch Wire Extension Kit (10") – Left & Right	70234-07	70234-07	70234-07	70234-07
Turn Signal Wire Extension Kit	72137-03	72137-03	72137-03	72137-03

## 2008-later FLHR & FLHRC

Clutch Cables	Stock 38667-08A	Not available	38921-09	38967-10
Brake Lines ('08-later models NON-ABS)	Not available	Not available	Upper 45134-08 / Lower 44907-08	Not available
Brake Lines ('09-later models WITH ABS)	Not available	Not available	Upper 46747-09 / Lower 41825-09	Not available
Riser Kit	56789-05	56789-05	56789-05	56789-05
Handlebar Cover Kit	67893-02	67893-02	67893-02	67893-02
Twist Grip Sensor Kit	32310-08	32310-08	32310-08	32310-08

## 2003-2007 FLHR & FLHRC

Clutch Cables ('03-'06 models)	Stock 38667-00	38660-03	38921-09	38967-10
Clutch Cables ('07 models)	Stock 38667-07	Not available	38921-09	38967-10
Throttle / Idle Cables	Stock 56523-02 / 56522-02 or 56376-02 / 56237-99A	56616-03	56809-05	55723-10
Brake Lines	Not available	45510-04	Upper 45134-08 / Lower 45818-07	Not available
Riser Kit	56789-05	56789-05	56789-05	56789-05
Handlebar Cover Kit	67893-02	67893-02	67893-02	67893-02
Brake/Throttle Clip	70488-02	70488-02	70488-02	70488-02
Switch Wire Extension Kit ('03 models)	72187-05	72187-05	72187-05	72187-05
Switch Wire Extension Kit ('04-'06 models)	72184-04	72184-04	72184-04	72184-04
Switch Wire Extension Kit ('07 models)	70198-07	70198-07	70198-07	70198-07

## 2004-2007 FLHRS

Clutch Cables ('04-'06 models)	Stock 38667-00	38660-03	38921-09	38967-10
Clutch Cables ('07 models)	Stock 38667-07	Not available	38921-09	38967-10
Throttle / Idle Cables	Stock 56295-03 / 56293-03 or 56555-04 / 56554-04	56719-03	56810-05	Not available
Brake Lines	Not available	45510-04	Upper 45134-08 / Lower 45818-07	Not available
Riser Kit	56789-05	56789-05	56789-05	56789-05
Handlebar Cover Kit	56699-04	56699-04	56699-04	56699-04
Bar & Shield Logo Trim	14448-94	14448-94	14448-94	14448-94
Brake / Throttle Clip	70488-02	70488-02	70488-02	70488-02

\*NOTE: Installation of some handlebars and risers may require a change in clutch and/or throttle cable and brake hose for some models. Handlebar height is regulated in many states. Check state or local laws before installation.

# 580 CONTROLS

## Handlebars

### A. NARROW BEACH BAR HANDLEBAR\*

Original Equipment on the '07 Screamin' Eagle® Fat Boy® model, this beefy 1-1/4" handlebar sets the tone for a full-on custom ride. This chrome-plated fat bar combines the low rise and sweeping shape of a beach-style bar with a narrower tip-to-tip width for added rider comfort. Factory drilled to allow internal wiring for show-winning style.

**56857-05 \$199.95**

Fits '00-later FXST, FXSTB, FXSTC, FXSTD, FLSTF, FLSTFB and FLSTC models. All models require separate purchase of additional installation components. Does not fit with Heated Hand Grips, Hydraulic Clutch Kits, Handlebar Mounted Gauges, or Road Tech™ Radio.

### B. FAT HANDLEBAR FOR ROAD KING® MODELS\*

Similar to Original Equipment handlebars on the '08 CVO Road King® model, these beefy 1-1/4" chrome handlebars are designed to be compatible for use with TGS-equipped Road King models. This handlebar provides a flatter hand position, 2" more rise than the stock bars, and allows you to tuck the wires inside the bar for a clean, custom look.

**56032-08 \$259.95**

Fits '08-later Road King® models. All models require separate purchase of additional components for installation. Does not fit with Heated Hand Grips, Hydraulic Clutch Kits, Handlebar Mounted Gauges or Road Tech™ Rise Mount Radio Kit. Does not fit '08 ABS equipped models.



A. NARROW BEACH BAR HANDLEBAR – SHOWN ON FAT BOY



A. NARROW BEACH BAR HANDLEBAR – SHOWN ON HERITAGE SOFTAIL CLASSIC



B. FAT HANDLEBAR FOR ROAD KING MODELS

\*NOTE: Installation of some handlebars and risers may require a change in clutch and/or throttle cable and brake hose for some models. Handlebar height is regulated in many states. Check state or local laws before installation.

Notice: The prices appearing in this catalog are the manufacturer's suggested retail prices. Actual retail prices may vary.

## Narrow Beach Handlebar (56857-05)

2000-later FXST	OEM Stock	Stainless Steel Braided	Diamondback™	Diamond-Black
Clutch Cables ('00-'06 models)	Stock 38666-00	38674-03	38851-09	38818-10
Clutch Cables ('07-'08 models)	Stock 38666-07A	Not available	38851-09	38818-10
Throttle / Idle Cables	Stock 56343-01 / 56342-01	56344-03A	56807-05A	38954-09
Brake Lines	Not available	Not available	Upper 42768-07 / Lower 42366-07	Not available
Riser Kit	56916-07	56916-07	56916-07	56916-07

## 2000-2009 FXSTB

Clutch Cables ('00-'06 models)	38666-00	38674-03	38851-09	38818-10
Clutch Cables ('07-'09 models)	38666-07A	Not available	38851-09	38818-10
Throttle / Idle Cables	56343-01 / 56342-01	56344-03A	56807-05A	38954-09
Brake Lines	Not available	Not available	Upper 42768-07 / Lower 42366-07	Not available
Riser Kit	56916-07	56916-07	56916-07	56916-07
Switch Wire Extension (10") – Left ('00-'06 models)	72150-03	72150-03	72150-03	72150-03
Switch Wire Extension (10") – Right ('00-'06 models)	72151-03	72151-03	72151-03	72151-03
Switch Wire Extension (10") – Left & Right ('07-'09 models)	70234-07	70234-07	70234-07	70234-07

## 2007-later FXSTC

Clutch Cables	Stock 38666-07A	Not available	38851-09	38818-10
Throttle / Idle Cables	56343-01 / 56342-01	56344-03A	56807-05A	38954-09
Brake Lines	Not available	Not available	Upper 42768-07 / Lower 42366-07	Not available
Riser Kit	56916-07	56916-07	56916-07	56916-07

## 2000-2007 FXSTD

Clutch Cables ('00-'06 models)	38666-00	38674-03	38851-09	38818-10
Clutch Cables ('07 models)	38666-07A	Not available	38851-09	38818-10
Throttle / Idle Cables	56343-01 / 56342-01	56344-03A	56807-05A	38954-09
Brake Lines	Not available	Not available	Upper 42768-07 / Lower 42366-07	Not available
Riser Kit	56916-07	56916-07	56916-07	56916-07
Mount Spacer (Qty 2)	6740	6740	6740	6740
Switch Wire Extension (4") – Left ('00-'06 models)	72140-03	72140-03	72140-03	72140-03
Switch Wire Extension (4") – Right ('00-'06 models)	72141-03	72141-03	72141-03	72141-03
Switch Wire Extension (4") – Left & Right ('07 models)	70229-07	70229-07	70229-07	70229-07

## 2000-2008 FLSTC

Clutch Cables ('00-'06 models)	Stock 38666-00	56414-03	38850-09	38877-09A
Clutch Cables ('07-'08 models)	Stock 38666-07A	Not available	38850-09	38877-09A
Throttle / Idle Cables	Stock 56343-01 / 56342-01	56344-03A	56807-05A	38954-09
Brake Lines	Not available	Not available	Upper 44964-07 / Lower 42371-07	Not available
Riser Kit	56916-07	56916-07	56916-07	56916-07

## 2009-later FLSTC

Clutch Cables	Not available	Not available	38850-09	38877-09A
Throttle / Idle Cables	Not available	56344-03A	56807-05A	38954-09
Brake Lines	Not available	Not available	Upper 44964-07 / Lower 42371-07	Not available
Riser Kit	56916-07	56916-07	56916-07	56916-07

## 2000-later FLSTF

Clutch Cables ('00-'06 models)	Stock 38666-00	56414-03	38850-09	38877-09A
Clutch Cables ('07-'10 models)	38666-07A	Not available	38850-09	38877-09A
Throttle / Idle Cables	Stock 56343-01 / 56342-01	56344-03A	56807-05A	38954-09
Brake Lines	Not available	Not available	Upper 44964-07 / Lower 42371-07	Not available
Riser Kit	56916-07	56916-07	56916-07	56916-07

## 2010-later FLSTFB

Clutch Cables	Not available	Not available	38850-09	38877-09A
Throttle / Idle Cables	Not available	56344-03A	56807-05A	38954-09
Brake Lines	Not available	Not available	Upper 44964-07 / Lower 42371-07	Not available
Riser Kit	56916-07	56916-07	56916-07	56916-07
Switch Wire Extension Kit (4") – Left & Right	70229-07	70229-07	70229-07	70229-07
Turn Signal Wire Extension Kit	72137-03	72137-03	72137-03	72137-03

## Fat Handlebar for Road King Models (56032-08)

### 2008-later FLHR & FLHRC

Clutch Cables	Stock 38667-08A	Not available	38921-09	38967-10
Brake Lines ('08-later models NON-ABS)	Not available	Not available	Upper 44259-08 / Lower 44907-08	Not available
Brake Lines ('09-later models WITH ABS)	Not available	Not available	Upper 46711-09 / Lower 41825-09	Not available
Riser Kit	56789-05	56789-05	56789-05	56789-05
Handlebar Cover Kit	67893-02	67893-02	67893-02	67893-02
Twist Grip Sensor Kit	32310-08	32310-08	32310-08	32310-08

## 582 CONTROLS

### Handlebars

#### A. FAT MINI-APE HANDLEBAR\*

Big and beefy in the chopper tradition, this 1-1/4" Mini-Ape Handlebar is the perfect finish to an "old school" ride. Factory drilled to allow internal wiring, the show-quality chrome reflects your attention to custom details.

**56832-04** **\$199.95**

Fits '99-later FXDWG and FXDF, '06-'07 FXDB, '00-later FXST, FXSTB, FXSTC, FLSTC, FLSTN and FLSTF/B and '08-later FXCW/C models. All models require separate purchase of Riser Kit P/N 56916-07 and additional installation components. Does not fit with Heated Hand Grips, Hydraulic Clutch Kits, handlebar mounted gauges, Road Tech™ Radio or Softail® Nacelle Kit P/N 67907-96B.



A. FAT MINI-APE HANDLEBAR – SHOWN ON DYNA WIDE GLIDE



A. FAT MINI-APE HANDLEBAR – SHOWN ON SOFTAIL DELUXE

\*NOTE: Installation of some handlebars and risers may require a change in clutch and/or throttle cable and brake hose for some models. Handlebar height is regulated in many states. Check state or local laws before installation.

Notice: The prices appearing in this catalog are the manufacturer's suggested retail prices. Actual retail prices may vary.



## Fat Mini-Ape Handlebar (56832-04)

	OEM Stock	Stainless Steel Braided	Diamondback™	Diamond-Black
<b>1999-2005 FXDWG</b>				
Clutch Cables	Not available	56416-03	38856-09	Not available
Throttle / Idle Cables	Not available	56350-03A	55700-07	38957-09
Brake Lines	Not available	Not available	Upper 42774-07 / Lower 42366-07	Not available
Riser Kit	56916-07	56916-07	56916-07	56916-07
Turn Signal Wire Extension Kit	72137-03	72137-03	72137-03	72137-03
Switch Wire Extension (4") – Left	72140-03	72140-03	72140-03	72140-03
Switch Wire Extension (4") – Right	72141-03	72141-03	72141-03	72141-03
<b>2006-2008, 2010 FXDWG</b>				
Clutch Cables	Not available	Not available	38857-09	38875-09A
Throttle / Idle Cables	Not available	56350-03A	55700-07	38957-09
Brake Lines	Not available	Not available	Upper 42774-07 / Lower 42108-07	Not available
Riser Kit	56916-07	56916-07	56916-07	56916-07
<b>2006-2007 FXDB</b>				
Clutch Cables	Not available	Not available	38857-09	38875-09A
Throttle / Idle Cables	Not available	56350-03A	55700-07	38957-09
Brake Lines	Not available	Not available	Upper 42774-07 / Lower 42110-07	Not available
Riser Kit	56916-07	56916-07	56916-07	56916-07
<b>2008-later FXDF</b>				
Clutch Cables	Not available	Not available	38857-09	38875-09A
Throttle / Idle Cables	Not available	56350-03A	55700-07	38957-09
Brake Lines	Not available	Not available	Upper 44259-08 / Lower 42112-08A	Not available
Riser Kit	56916-07	56916-07	56916-07	56916-07
<b>2000-later FXST</b>				
Clutch Cables ( <i>'07-'10 models</i> )	Not available	Not available	38852-09	38875-09A
Throttle / Idle Cables	56356-96A / 56355-96A	56350-03A	55700-07	38957-09
Brake Lines	Not available	Not available	Upper 42774-07 / Lower 42366-07	Not available
Riser Kit	56916-07	56916-07	56916-07	56916-07
Turn Signal Wire Extension Kit	72137-03	72137-03	72137-03	72137-03
Switch Wire Extension (4") – Left ('00-'06 models)	72140-03	72140-03	72140-03	72140-03
Switch Wire Extension (4") – Right ('00-'06 models)	72141-03	72141-03	72141-03	72141-03
Switch Wire Extension (4") – Left & Right ('07-'10 models)	70229-07	70229-07	70229-07	70229-07
<b>2000-2009 FXSTB</b>				
Clutch Cables ( <i>'07-'09 models</i> )	Not available	Not available	38852-09	38875-09A
Throttle / Idle Cables	56356-96A / 56355-96A	56350-03A	55700-07	38957-09
Brake Lines	Not available	Not available	Upper 42774-07 / Lower 42366-07	Not available
Riser Kit	56916-07	56916-07	56916-07	56916-07
Switch Wire Extension (10") – Left ('00-'06 models)	72150-03	72150-03	72150-03	72150-03
Switch Wire Extension (10") – Right ('00-'06 models)	72151-03	72151-03	72151-03	72151-03
Switch Wire Extension (10") – Left & Right ('07-'09 models)	70234-07	70234-07	70234-07	70234-07
<b>2007-later FXSTC</b>				
Clutch Cables	Not available	Not available	38852-09	38875-09A
Throttle / Idle Cables	56356-96A / 56355-96A	56350-03A	55700-07	38957-09
Brake Lines	Not available	Not available	Upper 42774-07 / Lower 42366-07	Not available
Riser Kit	56916-07	56916-07	56916-07	56916-07
Turn Signal Wire Extension Kit	72137-03	72137-03	72137-03	72137-03
Switch Wire Extension (4") – Left ('00-'06 models)	72140-03	72140-03	72140-03	72140-03
Switch Wire Extension (4") – Right ('00-'06 models)	72141-03	72141-03	72141-03	72141-03
Switch Wire Extension (4") – Left & Right ('07-'10 models)	70229-07	70229-07	70229-07	70229-07
<b>2008-later FXCW &amp; FXCWC</b>				
Clutch Cables	Not available	Not available	38854-09	38916-09A
Throttle / Idle Cables	Not available	Not available	55700-07	38957-09
Brake Lines	Not available	Not available	Upper 44964-07 / Lower 45770-08	Not available
Riser Kit	56916-07	56916-07	56916-07	56916-07
Bolt, Riser Mount (quantity 2)	3471	3471	3471	3471
Turn Signal Wire Extension Kit	72137-03	72137-03	72137-03	72137-03
Switch Wire Extension (4") – Left & Right ('07-'10 models)	70229-07	70229-07	70229-07	70229-07
P-Clamp ('08-'09 models)	10053	10053	10053	10053
Screw/Washer ('08-'09 models)	3594/6703	3594/6703	3594/6703	3594/6703
<b>2000-later FLSTC, FLSTF &amp; FLSTN</b>				
Clutch Cables ('00-'06 models)	38661-00	56447-04	38852-09	38875-09A
Clutch Cables ('07-'10 models)	38789-06B	Not available	38852-09	38875-09A
Throttle / Idle Cables	56356-96A / 56355-96A	56350-03A	55700-07	38957-09
Brake Lines	Not available	Not available	Upper 42774-07 / Lower 42371-07	Not available
Riser Kit	56916-07	56916-07	56916-07	56916-07
Turn Signal Wire Extension Kit	72137-03	72137-03	72137-03	72137-03
Switch Wire Extension (4") – Left ('00-'06 models)	72140-03	72140-03	72140-03	72140-03
Switch Wire Extension (4") – Right ('00-'06 models)	72141-03	72141-03	72141-03	72141-03
Switch Wire Extension (4") – Left & Right ('07-'10 models)	70229-07	70229-07	70229-07	70229-07
<b>2010-later FLSTFB</b>				
Clutch Cables	38789-06B	Not available	38852-09	38875-09A
Throttle / Idle Cables	56356-96A / 56355-96A	56350-03A	55700-07	38957-09
Brake Lines	Not available	Not available	Upper 42774-07 / Lower 42371-07	Not available
Riser Kit	56916-07	56916-07	56916-07	56916-07
Turn Signal Wire Extension Kit	72137-03	72137-03	72137-03	72137-03
Switch Wire Extension (10") – Left & Right ('07-'10 models)	70234-07	70234-07	70234-07	70234-07

# 584 CONTROLS

## Handlebars

### A. STREET SLAMMER BAR\*

Comfort and attitude in one. This Street Slammer drag bar with 7" integrated risers offers a stylish alternative to separate curved risers, bars and handlebar clamp combinations, and reduces the stretch required to reach traditional straight bars. This 1-1/4" fat bar is factory drilled to accept hidden control wires for a clean custom look. Available in brilliant chrome or satin black finishes.

Fits '06-'07 FXDB, '08-later FXDF, '01-'05 FXDL, '99-later FXDWG, '00-later FXST, FXSTB, FXSTC, FXSTD, **FXGW, FXGWC**, FLSTC, FLSTN, FLSTF, FLSTFB and '03-later FLHR, FLHRC, FLHRS models. All models require separate purchase of additional installation components. Does not fit '08 ABS equipped models, Heated Hand Grips, Hydraulic Clutch Kits, Handlebar Mounted Gauges, Road Tech™ Radio, Softail® Nacelle Kit P/N 67907-96C or Sidecar-equipped models.

**55975-08A** Chrome. **\$259.95**

**55985-10** Satin Black. **\$259.95**

#### Shown with:

#### STREET SLAMMER HANDLEBAR COVER

Required for installation of Street Slammer Handlebar P/N 55975-08A or 55985-10 on '03-later Road King® models. (FLHRS models also require separate purchase of Wind Deflector Adapter P/N 58157-07.) All models require separate purchase of additional installation components.

**55854-07** Chrome. **\$29.95**

**55876-10** Gloss Black. **\$29.95**

#### Also available:

#### STREET SLAMMER WIND DEFLECTOR ADAPTER

**58157-07** **\$29.95**

Required on '04-'07 FLHRS models equipped with Street Slammer Handlebar and Handlebar Cover P/N 55854-07.



A. STREET SLAMMER BAR – CHROME (SHOWN ON DYNA LOW RIDER)



A. STREET SLAMMER BAR – SATIN BLACK (SHOWN ON FAT BOY)



A. STREET SLAMMER BAR – CHROME (SHOWN ON ROAD KING)

\*NOTE: Installation of some handlebars and risers may require a change in clutch and/or throttle cable and brake hose for some models. Handlebar height is regulated in many states. Check state or local laws before installation.

Notice: The prices appearing in this catalog are the manufacturer's suggested retail prices. Actual retail prices may vary.

## Street Slammer Handlebar (55975-08A Chrome / 55985-10 Satin Black)

	OEM Stock	Stainless Steel Braided	Diamondback™	Diamond-Black
<b>2001-2005 FXDL</b>				
Clutch Cables	Stock 38666-00	38674-03	38851-09	38818-10
Throttle / Idle Cables	Stock 56356-96 / 56355-96	56579-02A	56805-05A	38918-09
Brake Lines	Stock 44794-01	44793-01	Upper 42903-07 / Lower 42371-07	Upper 48922-10 / Lower 48920-10
<b>1999-2005 FXDWG</b>				
Clutch Cables	38666-00	38674-03	38851-09	38818-10
Throttle / Idle Cables	Stock 56356-96 / 56355-96	56579-02A	56805-05A	38918-09
Brake Lines	Not available	44890-04A	Upper 42903-07 / Lower 42366-07	Upper 48922-10 / Lower 48924-10
Front Directional Mounting Kit	68266-03	68266-03	68266-03	68266-03
Clutch Cable Guide Kit	46699-05	46699-05	46699-05	46699-05
<b>2006-2008, 2010 FXDWG &amp; 2006-2007 FXDB</b>				
Clutch Cables	Not available	Not available	38851-09	38818-10
Throttle / Idle Cables	Stock 56356-96A / 56355-96A	56579-02A	56805-05A	38918-09
Brake Lines	Not available	Not available	Upper 42903-07 / Lower 42108-07	Upper 48922-10 / Lower 48926-10
Front Directional Mounting Kit	68266-03	68266-03	68266-03	68266-03
Clutch Cable Guide Kit	46699-05	46699-05	46699-05	46699-05
<b>2008-later FXDF</b>				
Clutch Cables	Not available	Not available	38850-09	38877-09A
Throttle / Idle Cables	56356-96 / 56355-96	56579-02A	56805-05A	38918-09
Brake Lines	Not available	Not available	Upper 45007-08 / Lower 42112-08A	Upper 48929-10 / Lower 48928-10
Front Directional Mounting Kit	68266-03	68266-03	68266-03	68266-03
Clutch Cable Guide Kit	46699-05	46699-05	46699-05	46699-05
<b>2000-later FXST &amp; FXSTC</b>				
Clutch Cables ('00-'06 models)	38665-00	56411-03	38847-09	38874-10
Clutch Cables ('07-'10 models)	38665-07B	Not available	38848-09	38941-09A
Throttle / Idle Cables	56431-98	56345-03A	56808-05A	38947-09
Brake Lines	Not available	44890-04A	Upper 42760-07 / Lower 42366-07	Upper 48932-10 / Lower 48924-10
Front Directional Mounting Kit	68266-03	68266-03	68266-03	68266-03
<b>2000-2009 FXSTB</b>				
Clutch Cables ('00-'06 models)	Stock 38665-00	56411-03	38847-09	38874-10
Clutch Cables ('07-'09 models)	Stock 38665-07B	Not available	38848-09	38941-09A
Throttle / Idle Cables	Stock 56431-98	56345-03A	56808-05A	38947-09
Brake Lines	Not available	44890-04A	Upper 42760-07 / Lower 42366-07	Upper 48932-10 / Lower 48924-10
<b>2000-2007 FXSTD</b>				
Clutch Cables ('00-'06 models)	38665-00	56411-03	38847-09	38874-10
Clutch Cables ('07 models)	38665-07B	Not available	38848-09	38941-09A
Throttle / Idle Cables	56633-06 / 56634-06	Not available	38781-06	38947-09
Brake Lines	Not available	44890-04A	Upper 42760-07 / Lower 42366-07	Upper 48932-10 / Lower 48924-10
Front Directional Mounting Kit	68266-03	68266-03	68266-03	68266-03
<b>2000-later FLSTC &amp; FLSTN</b>				
Clutch Cables ('00-'06 models)	38665-00	56411-03	38847-09	38874-10
Clutch Cables ('07-'10 models)	38665-07B	Not available	38848-09	38941-09A
Throttle / Idle Cables	56431-98	56345-03A	56808-05A	38947-09
Brake Lines	Not available	44890-04A	Upper 42764-07 / Lower 42371-07	Upper 48934-10 / Lower 48920-10
<b>2000-later FLSTF</b>				
Clutch Cables ('00-'06 models)	38665-00	56411-03	38847-09	38874-10
Clutch Cables ('07-'10 models)	38665-07B	Not available	38848-09	38941-09A
Throttle / Idle Cables	56431-98	56345-03A	56808-05A	38947-09
Brake Lines	Not available	44890-04A	Upper 42764-07 / Lower 42371-07	Upper 48934-10 / Lower 48920-10
Front Directional Mounting Kit	68266-03	68266-03	68266-03	68266-03
<b>2010-later FLSTFB</b>				
Clutch Cable	38664-07B	56414-03	38850-09	38877-09A
Throttle / Idle Cables	56433-98 / 56432-98	56344-03A	56807-05A	38954-09
Brake Lines	Not available	44890-04A	Upper 42764-07 / Lower 42371-07	Upper 48934-10 / Lower 48920-10
Front Directional Mounting Kit	68266-03	68266-03	68266-03	68266-03
<b>2003-2007 FLHR &amp; FLHRC</b>				
Clutch Cables ('03-'06 models)	Stock 38667-00	38660-03	38921-09	38967-10
Clutch Cables ('07 models)	Stock 38667-07	Not available	38921-09	38967-10
Throttle / Idle Cables	Stock 56523-02 / 56522-02 or 56376-02 / 56237-99A	56616-03	56809-05	55723-10
Brake Lines	Not available	45212-97B	Upper 44206-08 / Lower 45818-07	Upper 48940-10 / Lower 48938-10
Handlebar Cover Kit (Chrome)	55854-07	55854-07	55854-07	55854-07
Handlebar Cover Kit (Gloss Black)	55876-10	55876-10	55876-10	55876-10
<b>2004-2007 FLHRS</b>				
Clutch Cables ('03-'06 models)	Stock 38667-00	38660-03	38921-09	38967-10
Clutch Cables ('07 models)	Stock 38667-07	Not available	38921-09	38967-10
Throttle / Idle Cables	56523-02 / 56522-02 or 56376-02 / 56237-99A	56616-03	56809-05	55723-10
Brake Lines	Not available	45510-04	Upper 44206-08 / Lower 45818-07	Upper 48940-10 / Lower 48938-10
Handlebar Cover Kit	55854-07	55854-07	55854-07	55854-07
Wind Deflector Adapter Kit	58157-07	58157-07	58157-07	58157-07
<b>2008-later FLHR &amp; FLHRC</b>				
Clutch Cables	Stock 38667-08A	Not available	38921-09	38967-10
Brake Lines ('08-later models NON-ABS)	Not available	Not available	Upper 45094-08 / Lower 44907-08	Upper 48944-10 / Lower 48942-10
Brake Lines ('09-later models WITH ABS)	Not available	Not available	Upper 44162-09 / Lower 41825-08	Upper 48995-10 / Lower 48946-10
Handlebar Cover Kit (Chrome)	55854-07	55854-07	55854-07	55854-07
Handlebar Cover Kit (Gloss Black)	55876-10	55876-10	55876-10	55876-10
Twist Grip Sensor Kit	32310-08	32310-08	32310-08	32310-08

# 586 CONTROLS

## Handlebars

### A. SWINGBACK HANDLEBAR\*

The pull-back curves of this one-of-a-kind custom handlebar set your bike apart from the others. The sweeping one-piece chrome-plated bar offers a laid-back riding position, and the narrow width has a traditional drag bar feel. Designed to accommodate internal wiring, the webbed riser conceals the connections at the triple tree for a clean custom look.

**56039-03A** **\$299.95**

Fits '99-later FXDWG, '06-'07 FXDB, and '00-later FXST, FXSTB, FXSTC, FXSTD, FLSTF, FLSTFB and FLSTC models. All models require separate purchase of additional installation components. Does not fit with Heated Hand Grips, Hydraulic Clutch Kits, handlebar mounted gauges, Road Tech™ Radio or Softail® Nacelle Kit P/N 67907-96B.



*Notice: The prices appearing in this catalog are the manufacturer's suggested retail prices. Actual retail prices may vary.*

**A. SWINGBACK HANDLEBAR – SHOWN ON DYNA WIDE GLIDE**

#### Swingback Handlebar (56039-03A)

	OEM Stock	Stainless Steel Braided	Diamondback™	Diamond-Black
<b>1999-2005 FXDWG</b>				
Clutch Cables	Stock 38661-00	56590-02	38854-09	38916-09A
Throttle / Idle Cables	Stock 56356-96 / 56355-96	56579-02A	56805-05A	38918-09
Brake Lines	Not available	45783-02	Use Measurement Tool	Not available
<b>2006-2008 FXDWG &amp; 2006-2007 FXDB</b>				
Clutch Cables	38788-06B	Not available	38852-09	Not available
Throttle / Idle Cables	56343-01 / 56342-01	56344-03A	56807-05A	Not available
Brake Lines	Not available	45783-02	Use Measurement Tool	Not available
<b>2000-later FXST</b>				
Clutch Cables ('00-'06 models)	38664-00	56414-03	38850-09	38877-09A
Clutch Cables ('07-'10 models)	38664-07A	Not available	38850-09	38877-09A
Throttle / Idle Cables	Stock 56343-01 / 56342-01	56344-03A	56807-05A	Not available
Brake Lines	Not available	45783-02	Use Measurement Tool	Not available
<b>2000-2009 FXSTB</b>				
Clutch Cables ('00-'06 models)	38664-00	56414-03	38850-09	38877-09A
Clutch Cables ('07-'09 models)	38664-07A	Not available	38850-09	38877-09A
Throttle / Idle Cables	56343-01 / 56342-01	56344-03A	56807-05A	Not available
Brake Lines	Not available	45783-02	Use Measurement Tool	Not available
Switch Wire Extension (10") – Left ('00-'06 models)	72150-03	72150-03	72150-03	72150-03
Switch Wire Extension (10") – Right ('00-'06 models)	72151-03	72151-03	72151-03	72151-03
Switch Wire Extension (10") – Left & Right ('07-'09 models)	70234-07	70234-07	70234-07	70234-07
<b>2007-later FXSTC</b>				
Clutch Cables	38664-07A	Not available	38850-09	38877-09A
Throttle / Idle Cables	56343-01 / 56342-01	56344-03A	56807-05A	Not available
Brake Lines	Not available	45783-02	Use Measurement Tool	Not available
<b>2000-2007 FXSTD</b>				
Clutch Cables ('00-'06 models)	Stock 38664-00	56414-03	38850-09	38877-09A
Clutch Cables ('07 models)	Stock 38664-07A	Not available	38850-09	38877-09A
Throttle / Idle Cables	56633-06 / 56634-06	Not available	38781-06	38947-09
Brake Lines	Not available	45783-02	Use Measurement Tool	Not available
Turn Signal Wire Extension	72137-03	72137-03	72137-03	72137-03
Switch Wire Extension (4") – Left ('00-'06 models)	72140-03	72140-03	72140-03	72140-03
Switch Wire Extension (4") – Right ('00-'06 models)	72141-03	72141-03	72141-03	72141-03
Switch Wire Extension (4") – Left & Right ('07 models)	70229-07	70229-07	70229-07	70229-07
Mount Spacer (Qty 2)	6740	6740	6740	6740
<b>2000-2008 FLSTC</b>				
Clutch Cables ('00-'06 models)	Stock 38666-00	38674-03	38851-09	38818-10
Clutch Cables ('07-'08 models)	Stock 38666-07A	Not available	38851-09	38818-10
Throttle / Idle Cables	Stock 56343-01 / 56342-01	56344-03A	56807-05A	Not available
Brake Lines	Not available	45783-02	Use Measurement Tool	Not available
<b>2009-later FLSTC</b>				
Clutch Cables	Not available	Not available	38851-09	38818-10
Throttle / Idle Cables	Not available	56344-03A	56807-05A	Not available
Brake Lines	Not available	45783-02	Use Measurement Tool	Not available
<b>2000-later FLSTF</b>				
Clutch Cables ('00-'06 models)	Stock 38666-00	38674-03	38851-09	38818-10
Clutch Cables ('07-'10 models)	38666-07A	Not available	38851-09	38818-10
Throttle / Idle Cables	Stock 56343-01 / 56342-01	56344-03A	56807-05A	Not available
Brake Lines	Not available	45783-02	Use Measurement Tool	Not available





**B**

**B. MINI APE HANDLEBAR – SATIN BLACK**

**B. MINI-APE HANDLEBAR – SATIN BLACK\***

Raise your fists to the wind. This 12" high, 1" diameter Mini Ape Handlebar features a conservative rise and bend for rider comfort, and a satin black finish that complements the aggressive look of the Nightster™ and Street Bob® models.

**56075-07 \$69.95**

Fits '04-later XL883L, XL883N, XL1200L and XL1200N models. Also fits '06-later FXDB and '96-'05 FXDWG models with Original Equipment Handlebar P/N 58079-93. XL models require separate purchase of additional components.

**Mini-Ape Handlebar – Satin Black (56075-07)**

2004-later XL883L, XL1200L & XL1200N,  
2009-later XL883N

	OEM Stock	Stainless Steel Braided	Diamondback™	Diamond-Black
Clutch Cable	Not available	Not available	Not available	38911-09A
Throttle / Idle Cables	Not available	Not available	38906-07	38913-09
Brake Lines	Not available	Not available	Not available	46720-09
Riser Kit	Stock	Stock	Stock	Stock
Switch Wire Extension Kit (10") – Left & Right ('07-'09 models)	70234-07	70234-07	70234-07	70234-07
Turn Signal Wire Extension Kit	72137-03	72137-03	72137-03	72137-03

**1996-2005 FXDWG**

Clutch Cable ('00-'05 FXDWG)	Stock 38661-00	56590-02	38854-09	38916-09A
Clutch cables (1996-1999 FXDWG)	Stock 38602-92	56590-02	38854-09	38916-09A
Throttle / Idle Cables	Stock 56356-96A / 56355-96A	56579-02A	56805-05A	38918-09
Brake Lines	Stock 45112-96	45206-97B	Upper 42749-07 Lower 42366-07	Not available
Riser Kit	Stock	Stock	Stock	Stock

**2006-later FXDB**

Clutch cable	Stock 38789-06B	Not available	38854-09	38916-09
Throttle / Idle Cables	Stock 56356-96A / 56355-96A	56579-02A	56805-05A	38918-09
Brake Lines	Stock 42728-06	Not available	Not available	46740-09



**NEW**

**C**

**C. CROSS BONES NARROW BEACH HANDLEBAR – BLACK**

**C. CROSS BONES™ NARROW BEACH HANDLEBAR – BLACK**

These gloss black 1" handlebars are unique to the FL Softail® Springer® models. The narrow beach bar style captures the attitude of traditional beach bars, without the wide riding position. Finish the blacked-out look with complementing Diamond-Black cables and brake lines. Installation requires separate purchase of additional components.

**56940-09 \$69.95**

Fits '08-later FLSTSB models and '05-'07 FLSTSC models. Requires separate purchase of additional installation components.

**Cross Bones Black Narrow Beach Handlebar (56940-09)**

	Diamondback™	Diamond-Black
2005-2007 FLSTSC, 2008-later FLSTSB		
Clutch Cable	38850-09	38877-09A
Throttle / Idle Cables	56807-05A	38954-09
Brake lines	46942-06	48962-09
Turn signal relocation kit	68266-03	68266-03

\*NOTE: Installation of some handlebars and risers may require a change in clutch and/or throttle cable and brake hose for some models. Handlebar height is regulated in many states. Check state or local laws before installation.

Notice: The prices appearing in this catalog are the manufacturer's suggested retail prices. Actual retail prices may vary.

# 588 CONTROLS

## Handlebars

### A. FAT DRAG HANDLEBAR – SATIN BLACK

Complete the transition to the “dark side.” Elegant satin-black finished handlebar retains the comfortable contour of the Original Equipment bar, and complements the black finished hand controls and mirrors.

**55977-09** **\$169.95**

Fits '08-later FXDF, '10 FXDWG, and '99-later FXST and FXSTB models. Most models require separate purchase of additional components.



A. FAT DRAG HANDLEBAR – SATIN BLACK

#### Fat Drag Handlebar (55977-09)

2008-later FXDF	OEM Stock	Stainless Steel Braided	Diamondback™	Diamond-Black
Clutch Cables	Stock	Not available	38849-09	38940-09A
Throttle / Idle Cables	Stock	Not available	38781-06	38946-09
Brake Lines	Stock	Not available	Upper 44790-08 / Lower 42112-08A	Upper 48931-10 / Lower 48928-10
1999-later FXST & 1999-2009 FXSTB				
Clutch Cable	Not available	Not available	38848-09	38941-09A
Throttle/Idle Cables	Not available	Not available	38781-06	38946-09
Brake Lines	Not available	Not available	Not available	48972-09
Riser Kit	55996-09	55996-09	55996-09	55996-09
Turn signal relocation kit	58742-05 or 68952-98	58742-05 or 68952-98	58742-05 or 68952-98	58742-05 or 68952-98
2010-later FXDWG				
Clutch Cables	Not available	Not available	38851-09	38818-10
Throttle/Idle Cables	Not available	55715-07	38781-06	38946-09
Brake Lines	Not available	Not available	Upper 42784-07 / Lower 42108-07	Upper 42340-10 / Lower 48926-10

### B. PULL BACK HANDLEBAR FOR XL CUSTOM MODELS\*

This chrome handlebar is designed to bring the controls closer to the rider for increased comfort. Especially helpful for shorter riders or for riders that prefer a close-to-the-bar riding position.

**56021-04B** **\$99.95**

Fits '04-later XL883C and XL1200C models. Installation requires separate purchase of additional components.



B. PULL BACK HANDLEBAR FOR XL CUSTOM MODELS

#### Pull Back Handlebar (56021-04B)

2004-2006 XL883C & XL1200C	OEM Stock	Stainless Steel Braided	Diamondback™	Diamond-Black
Clutch Cables	Not available	38732-04	Not available	Not available
Throttle/Idle Cables	Not available	56340-04	Not available	Not available
Brake Lines	Not available	45113-03	Not available	Not available
2007-later XL883C & XL1200C				
Clutch Cable	Not available	38732-04	Not available	Not available
Throttle/Idle Cables	Not available	56360-09	38906-07	38913-09
Brake Lines	Not available	45113-03	Not available	Not available

### C. CHROME HANDLEBARS FOR SOFTAIL® MODELS\*

Chrome-plated handlebar is designed to be exact replacement for the Original Equipment handlebar.

**1. 56154-04** **\$69.95**

Fits Dyna® and Softail® models with P/N 56102-99 as Original Equipment.

**2. 55958-01** **\$69.95**

Fits '01-'06 FLSTF models.

### D. CHROME HANDLEBAR FOR SOFTAIL® DEUCE™ MODELS\*

Without sacrificing Softail® Deuce styling, this chrome handlebar replaces the stock polished bar and brings the grips an 1-1/2" closer to the rider, providing a relaxed, comfortable riding posture.

**56330-00** **\$69.95**

Fits '00-'07 FXSTD models. (Requires the separate purchase of Stainless Steel Brake Line Kit P/N 44815-00A.)

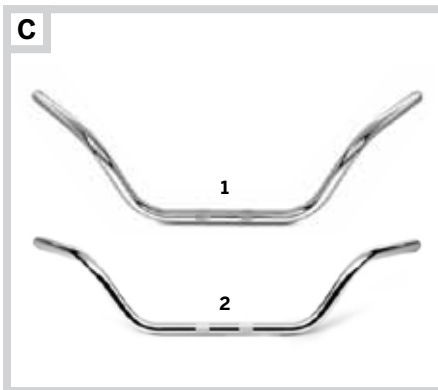

C. CHROME HANDLEBARS FOR SOFTAIL MODELS

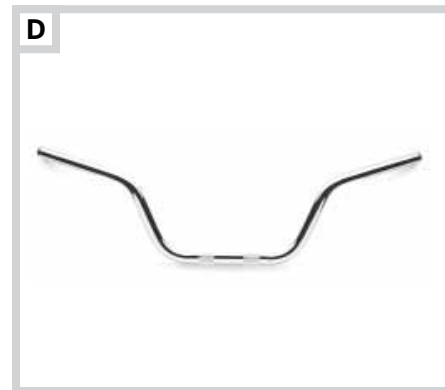

D. CHROME HANDLEBAR FOR SOFTAIL DEUCE MODELS



E

**E. DRAG HANDLEBAR FOR ROCKER MODELS**

**E. DRAG HANDLEBAR FOR ROCKER™ MODELS\***

Stretch out in style. This cool-looking highly polished bar is approximately 1.5" forward and 1.5" narrower than stock for an aggressive look, plus we have provided the space for you to tuck the wires inside the bar for a clean front end.

**56947-08** **\$79.95**  
Fits '08-later FXCW and FXCWC models.

**Drag Handlebar for FXCW/C (56947-08)**

2008-later FXCW & FXCWC

	OEM Stock	Stainless Steel Braided	Diamondback™	Diamond-Black
Clutch Cable	Stock 38666-07A	Not available	38851-09	38818-10
Throttle / Idle Cables	56432-98 / 56433-98	56345-03A	56808-05A	38947-09
Brake Lines	Not available	Not available	Upper 42768-07 / Lower 45770-08	Not available



F

**F. PULLBACK RISER AND HANDLEBAR KIT FOR FXSTB MODELS**

**F. PULLBACK RISER AND HANDLEBAR KIT FOR FXSTB MODELS\***

With a subtle curve that also adds an element of style, these pullback risers with flat bar bring the handlebars approximately 5" closer to the rider (as compared to stock FXSTB) without compromising the original styling of your Night Train® model. Perfect for riders without a long reach or for riders who prefer sitting a little straighter in the saddle. Designed for use on FXSTB models with stock cables.

**56029-00** Fits '99-later FXSTB models. **\$159.95**

**G. CHROME HANDLEBARS\***

Chrome-plated handlebars are designed to be exact replacements for the Original Equipment stainless steel handlebars.

**1. 56085-83T** **\$69.95**

Fits XL and FXD models equipped with P/N 56085-83 or 56004-00 as Original Equipment.

**2. 56082-83T** **\$69.95**

Fits XL and FXR models equipped with P/N 56082-83 as Original Equipment.

**3. 56079-93T** **\$69.95**

Fits FXDB and FXDWG models equipped with P/N 56079-93 as Original Equipment.

**4. 56081-82T** **\$69.95**

Fits FLHS, XL, FX, FXR, FXD and FXST models equipped with P/N 56081-82 as Original Equipment.

**5. 56556-95** ~~OBSOLETE~~ **\$69.95**

Fits XL1200, Deluxe, Hugger®, FXD, FXDL, FXR, FXRS, and FXSTC models equipped with Buckhorn Handlebar P/N 56081-82. (Does not fit models with Air Reservoir Style Handlebars.)

**6. 56055-01** ~~OBSOLETE~~ **\$69.95**

Fits '01-'05 FXDL models. (Does not fit models with Air Reservoir Style Handlebars.)

**7. 56563-95** **\$69.95**

Fits XL1200, Deluxe, Hugger, FXD, FXDL, FXRS, FXR models equipped with Buckhorn Handlebar P/N 56081-82. (Does not fit models with Air Reservoir Style Handlebars.)

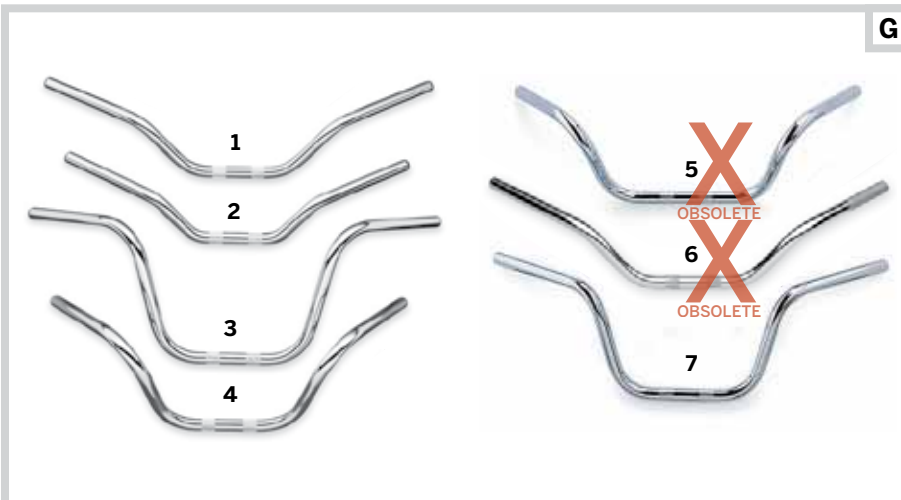

G

**G. CHROME HANDLEBARS**

\*NOTE: Installation of some handlebars and risers may require a change in clutch and/or throttle cable and brake hose for some models. Handlebar height is regulated in many states. Check state or local laws before installation.

Notice: The prices appearing in this catalog are the manufacturer's suggested retail prices. Actual retail prices may vary.

# 590 CONTROLS

## Handlebars

### A. CHROME ELECTRA GLIDE® HANDLEBAR\*

Original Equipment on the '08 CVO Electra Glide model, this high-quality chrome-plated handlebar is designed to be compatible for use with TGS equipped '08 Electra Glide models. Replace your stock polished bar with this 1", chrome handlebar that allows you to tuck the wires inside the bar for a clean, finished look.

**56036-08 \$149.95**

Fits '08-later Electra Glide® and Street Glide™ models. Does not fit Trike models. All models require separate purchase of additional components. FLHX and models with fairing mount mirrors require separate purchase of handlebar-mounted mirrors and Fairing Plugs P/N 732 (qty 2) and 735 (qty 2). Does not fit '08 ABS-equipped models or sidecar-equipped models.



**A. CHROME ELECTRA GLIDE HANDLEBAR**

### Chrome Electra Glide Handlebar (56036-08)

2008-later FLHT, FLHTC, FLHTCU & FLHX	OEM Stock	Stainless Steel Braided	Diamondback™	Diamond-Black
Clutch Cable	Stock <b>38667-08A</b>	Not available	38921-09	38967-10
Brake Lines ('08-later models NON-ABS)	Not available	Not available	Upper 44106-08 / Lower 44905-08	Not available
Brake Lines ('09-later models WITH ABS)	Not available	Not available	Upper 40958-09 / Lower 41825-09	Not available
Twist Grip Sensor Kit	32310-08	32310-08	32310-08	32310-08

### B. REDUCED REACH HANDLEBAR\*

This 1" diameter chrome bar has 2" more pullback compared to the stock Road King handlebar. Accepts internal wiring for a clean look. The neutral hand position is comfortable for the long haul, and the narrow width and pull-back design produces a major ergonomic change.

**56166-08 \$89.95**

Fits '08-later FLHR, FLHRC, FLTR and FLTRX models. Does not fit '08 ABS equipped models, Sidecar-equipped models, Heated Hand Grips with internal switch wiring, Hydraulic Clutch Kits, Handlebar Mounted Gauges or Road Tech™ Riser Mount Radio kit. All models require separate purchase of additional components for installation.

**56152-04B \$89.95**

Fits '02-'07 Road King models. Not compatible with sidecar-equipped models. All models require separate purchase of additional components for installation.



**B. REDUCED REACH HANDLEBAR ('02-'07 SHOWN)**

### Reduced Reach Handlebar (56166-08)

2008-later FLHR & FLHRC	OEM Stock	Stainless Steel Braided	Diamondback™	Diamond-Black
Clutch Cable	Stock <b>38667-08A</b>	Not available	38921-09	38967-10
Brake Lines ('08-later models NON-ABS)	Not available	Not available	Upper 44213-08 / Lower 44907-08	Not available
Brake Lines ('09-later models WITH ABS)	Not available	Not available	Upper 46711-09 / Lower 41825-09	Not available
Switch Wire Extension (5") – Left & Right*	70198-07 *	70198-07 *	70198-07 *	70198-07 *
Twist Grip Sensor Kit*	32310-08 *	32310-08 *	32310-08 *	32310-08 *

### 2008-later FLTR & FLTRX

Clutch Cable	Not available	Not available	38921-09	38967-10
Brake Lines ('08-later models NON-ABS)	Not available	Not available	Upper 44213-08 / Lower 44907-08	Not available
Brake Lines ('09-later models WITH ABS)	Not available	Not available	Upper 46711-09 / Lower 46049-09	Not available
Twist Grip Sensor Kit*	32310-08 *	32310-08 *	32310-08 *	32310-08 *

\*only req'd if internally-wiring switch harness

### Reduced Reach Road King Handlebar (56152-04B)

2002-2007 FLHR & FLHRC	OEM Stock	Stainless Steel Braided	Diamondback™	Diamond-Black
Clutch Cables ('02-'06 models)	Stock <b>38667-00</b>	38660-03	38921-09	38967-10
Clutch Cables ('07 models)	Stock <b>38667-07</b>	Not available	38921-09	38967-10
Throttle / Idle Cables	Stock <b>56523-02 / 56522-02 or 56376-02 / 56237-99A</b>	56616-03	56809-05	55723-10
Brake Lines	Stock <b>43350-96B</b>	45212-97B	Upper 44250-08 / Lower 45818-07	Not available
Switch Wire Extension Kit ('02-'03 models)	72187-05	72187-05	72187-05	72187-05
Switch Wire Extension Kit ('04-'06 models)	72184-04	72184-04	72184-04	72184-04
Switch Wire Extension Kit ('07-'08 models)	70198-07	70198-07	70198-07	70198-07

### 2004-2007 FLHRS

Clutch Cables ('04-'06 models)	Stock <b>38667-00</b>	38660-03	38921-09	38967-10
Clutch Cables ('07 models)	Stock <b>38667-07</b>	Not available	38921-09	38967-10
Throttle / Idle Cables	Stock <b>56295-03 / 56293-03 or 56555-04 / 56554-04</b>	56719-03	56810-05	Not available
Brake Lines	Not available	45510-04	Upper 44250-08 / Lower 45818-07	Not available

Notice: The prices appearing in this catalog are the manufacturer's suggested retail prices. Actual retail prices may vary.





**C. CHROME ROAD KING HANDLEBAR**

**C. CHROME ROAD KING® HANDLEBAR\***

Original Equipment on the '09 CVO Road Glide model, this high-quality 1" diameter chrome-plated handlebar offers a stylish alternative to your stock polished bar.

**56941-09 \$149.95**

Fits '08-later FLHR, FLHRC, FLTR and FLTRX models. Does not fit '08 ABS equipped models, Sidecar-equipped models, Heated Hand Grips with internal switch wiring, Hydraulic Clutch Kits, Handlebar Mounted Gauges or Road Tech Radio™ kit. All models require separate purchase of additional components for installation.

**Chrome Road King Handlebar (56941-09)**

	OEM Stock	Stainless Steel Braided	Diamondback™	Diamond-Black
<b>2008-later FLHR &amp; FLHRC</b>				
Clutch Cable	Not available	Not available	38921-09	38967-10
Brake Lines ('08-later models NON-ABS)	Not available	Not available	Upper 44213-08 / Lower 44907-08	Not available
Brake Lines ('09-later models WITH ABS)	Not available	Not available	Upper 46711-09 / Lower 41825-09	Not available
Twist Grip Sensor Kit	32310-08	32310-08	32310-08	32310-08
<b>2008-later FLTR &amp; FLTRX</b>				
Clutch Cable	Not available	Not available	38921-09	38967-10
Brake Lines ('08-later models NON-ABS)	Not available	Not available	Upper 44213-08 / Lower 44907-08	Not available
Brake Lines ('09-later models WITH ABS)	Not available	Not available	Upper 46711-09 / Lower 46049-09	Not available
Twist Grip Sensor Kit	32310-08	32310-08	32310-08	32310-08



**D. CHROME HIGH HANDLEBAR**

**D. CHROME HIGH HANDLEBAR\***

Designed to provide extra touring comfort for the Road King rider, this 1" diameter chrome bar is 2" higher and 1.5" narrower compared to the stock Road King handlebar.

**56180-08 \$89.95**

Fits '08-later FLHR, FLHRC, FLTR and FLTRX models. Does not fit with '08 ABS equipped models, Sidecar-equipped models, Heated Hand Grips with internal switch wiring, Hydraulic Clutch Kits, Handlebar Mounted Gauges or Road Tech Riser Mount Radio kit. All models require separate purchase of additional components for installation.

**Chrome High Pull Back Handlebar (56180-08)**

	OEM Stock	Stainless Steel Braided	Diamondback™	Diamond-Black
<b>2008-later FLHR &amp; FLHRC</b>				
Clutch Cables	Not available	Not available	38921-09	38967-10
Brake Lines ('08-later models NON-ABS)	Not available	Not available	Upper 44250-08 / Lower 44907-08	Not available
Brake Lines ('09-later models WITH ABS)	Not available	Not available	Upper 46727-09 / Lower 41825-09	Not available
Switch Wire Extension (5") – Left & Right*	70198-07 *	70198-07 *	70198-07 *	70198-07 *
Twist Grip Sensor Kit*	32310-08 *	32310-08 *	32310-08 *	32310-08 *
<b>2008-later FLTR &amp; FLTRX</b>				
Clutch Cable	Not available	Not available	38921-09	38967-10
Brake Lines ('08-later models NON-ABS)	Not available	Not available	Upper 44250-08 / Lower 44907-08	Not available
Brake Lines ('09-later models WITH ABS)	Not available	Not available	Upper 46727-09 / Lower 46049-09	Not available
Twist Grip Sensor Kit*	32310-08 *	32310-08 *	32310-08 *	32310-08 *



**E. HERITAGE STYLE HANDLEBAR**

**E. HERITAGE STYLE HANDLEBAR\***

Designed to provide extra touring comfort for the Road King or Road Glide rider, this 1" diameter polished stainless steel bar has 3" more pullback compared to the stock Road King handlebar.

Fits '08-later FLHR, FLHRC, FLTR and FLTRX models. All models require separate purchase of additional components. Does not fit '08 ABS-equipped models. Does not fit models with Sidecar, Heated Hand Grips with internal switch wiring, Hydraulic Clutch Kits, Handlebar Mounted Gauges, or Road Tech Riser Mount Radio.

**55864-09 Satin Black. \$79.95**  
**56902-08 Chrome. \$79.95**

**FLHR Heritage-Style Handlebar (56902-08 Chrome / 55864-09 Satin Black)**

	OEM Stock	Stainless Steel Braided	Diamondback™	Diamond-Black
<b>2008-later FLHR &amp; FLHRC</b>				
Clutch Cable	Stock	Not available	38921-09	38967-10
Brake Lines ('08-later models NON-ABS)	Stock	Not Available	Upper 42461-08 / Lower 44907-08	Not available
Brake Lines ('08 models WITH ABS)	Stock	Not available	Not available	Not available
Brake Lines ('09-later models WITH ABS)	Stock	Not Available	Upper 40958-09 / Lower 41825-09	Not available
Switch Wire Extension (5") – Left & Right*	70198-07 *	70198-07 *	70198-07 *	70198-07 *
Twist Grip Sensor Kit*	32310-08 *	32310-08 *	32310-08 *	32310-08 *
<b>2008-later FLTR &amp; FLTRX</b>				
Clutch Cable	Stock	Not available	38921-09	38967-10
Brake Lines ('08-later models NON-ABS)	Stock	Not Available	Upper 44213-08 / Lower 44907-08	Not available
Brake Lines ('08 models WITH ABS)	Stock	Not available	Not available	Not available
Brake Lines ('09-later models WITH ABS)	Stock	Not Available	Upper 46711-09 / Lower 46049-09	Not available
Twist Grip Sensor Kit*	32310-08 *	32310-08 *	32310-08 *	32310-08 *

\*only req'd if internally-wiring switch harness

# 592 CONTROLS

## Handlebars

### A. TALLBOY® HANDLEBAR\*

This 1" chrome-plated handlebar is shaped to provide a comfortable reach for a rider with longer arms. Handlebar is approximately 1.5" taller and 2" further from the rider than the Original Equipment Electra Glide® handlebar.

**56184-08 \$149.95**

Fits '08-later Electra Glide® and Street Glide™ models. Does not fit Trike models. All models require separate purchase of additional components. FLHX and models with fairing mount mirrors require separate purchase of handlebar-mounted mirrors and Fairing Plugs P/N 732 (qty 2) and 735 (qty 2). Does not fit '08 ABS-equipped models or sidecar-equipped models.

**56964-07 \$149.95**

Fits '97-'07 Electra Glide and Street Glide models. All models require separate purchase of additional components. FLHX and models with fairing mount mirrors require separate purchase of handlebar mounted mirrors and Fairing Plugs P/N 732 (qty 2) and 735 (qty 2). Does not fit models equipped with Heated Hand Grips with internal switch wiring, Hydraulic Clutch Kits, or Sidecar.

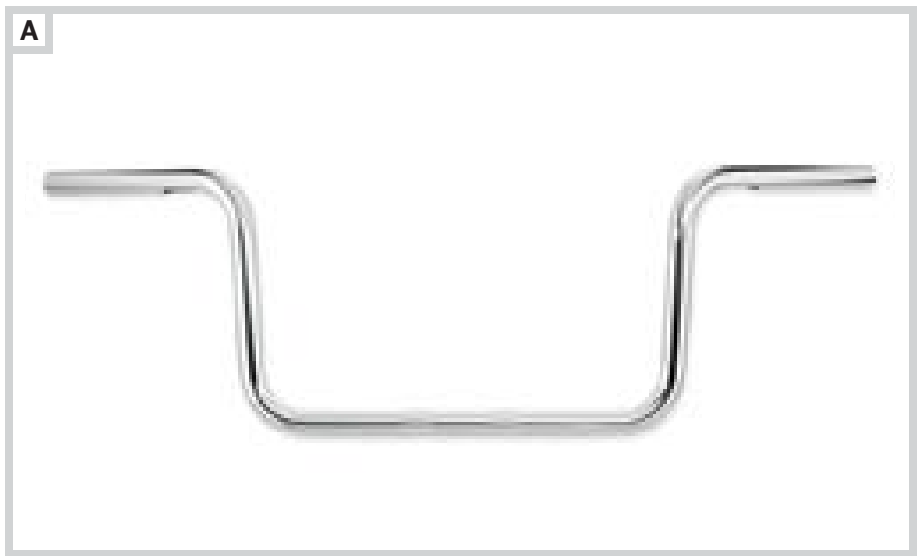

A. TALLBOY HANDLEBAR

#### Tallboy Handlebar (56184-08)

2008-later FLHT, FLHTC, FLHTCU & FLHX	OEM Stock	Stainless Steel Braided	Diamondback™	Diamond-Black
Clutch Cable	Not available	Not available	38922-09	Not available
Brake Lines ('08-later models NON-ABS)	Not available	Not available	Upper 42428-08 / Lower 44905-08	Not available
Brake Lines ('09-later models WITH ABS)	Not available	Not available	Upper 46336-09 / Lower 41825-09	Not available
Twist Grip Sensor Kit*	32310-08 *	32310-08 *	32310-08 *	32310-08 *

\*only req'd if internally-wiring switch harness

#### Tallboy Handlebar (56964-07)

##### 1997-2001 FLHTCI

Clutch Cable	38649-98	Not available	Not available	Not available
Throttle Cable	38650-98	Not available	Not available	Not available
Idle Cable	38652-98	Not available	Not available	Not available
Brake Lines	Not available	45212-97B	Not available	Not available

##### 1997-2001 FLHT & FLHTC

Clutch Cable	38649-98	Not available	Not available	Not available
Throttle Cable	56357-96	Not available	Not available	Not available
Idle Cable	56424-98	Not available	Not available	Not available
Brake Lines	Not available	45212-97B	Not available	Not available

##### 1997 FLHTCU

Clutch Cable	38649-98	Not available	Not available	Not available
Throttle Cable	56357-96	Not available	Not available	Not available
Idle Cable	56071-98	Not available	Not available	Not available
Brake Lines	Not available	45212-97B	Not available	Not available

##### 1997-2001 FLHTCUI

Clutch Cable	38649-98	Not available	Not available	Not available
Throttle Cable	38650-98	Not available	Not available	Not available
Idle Cable	38651-98	Not available	Not available	Not available
Brake Lines	Not available	45212-97B	Not available	Not available

##### 2002-2007 FLHT/I, FLHTC/I & FLHTCU/I

Clutch Cable ('02-'06 models)	38649-98	Not available	38922-09	Not available
Clutch Cable ('07 models)	38649-07	Not available	38922-09	Not available
Throttle Cable	Not available	Not available	38778-05	Not available
Idle Cable	Not available	Not available	38778-05	Not available
Brake Lines	Not available	45212-97B	Upper 42399-08 / Lower 45820-07	Not available

\*NOTE: Installation of some handlebars and risers may require a change in clutch and/or throttle cable and brake hose for some models. Handlebar height is regulated in many states. Check state or local laws before installation.

Notice: The prices appearing in this catalog are the manufacturer's suggested retail prices. Actual retail prices may vary.

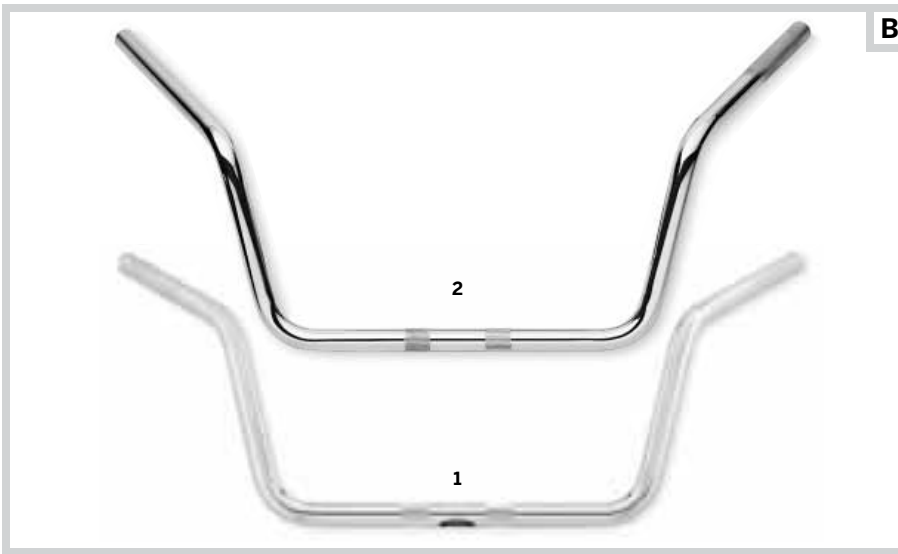

**B. TOURING PULL BACK HANDLEBARS**

**B. TOURING PULL BACK HANDLEBARS\***

These high-quality, polished stainless steel handlebars are designed to bring the controls 2" closer to the rider for increased comfort. Especially helpful for shorter riders or those with short arms.

**1. 56176-08 \$149.95**

Fits '08-later Electra Glide® and Street Glide™ models. Does not fit Trike models. All models require separate purchase of additional components. FLHX and models with fairing mount mirrors require separate purchase of handlebar-mounted mirrors and Fairing Plugs P/N 732 (qty 2) and 735 (qty 2). Does not fit sidecar-equipped models.

**2. 55914-98 \$149.95**

Fits '97-'07 Electra Glide and Street Glide models. All models require separate purchase of additional components. FLHX and models with fairing mount mirrors require separate purchase of handlebar mounted mirrors and Fairing Plugs P/N 732 (qty 2) and 735 (qty 2). Does not fit models equipped with Heated Hand Grips with internal switch wiring, Hydraulic Clutch Kits, or Sidecar.

**Touring 2" Pull Back Handlebar (56176-08)**

2008-later FLHT, FLHTC, FLHTCU & FLHX	OEM Stock	Stainless Steel Braided	Diamondback™	Diamond-Black
Clutch Cable	Not available	Not available	38922-09	Not available
Brake Lines ('08-later models NON-ABS)	Not available	Not available	Upper 44213-08 / Lower 44905-08	Not available
Brake Lines ('08 models WITH ABS)	Upper 41678-08 Stock Lower 40612-08	Not available	Not available	Not available
Brake Lines ('09-later models WITH ABS)	Not available	Not available	Upper 46711-09 / Lower 41825-09	Not available
Twist Grip Sensor Kit *	32310-08 *	32310-08 *	32310-08 *	32310-08 *

\*only req'd if internally-wiring switch harness

**Touring 2" Pull Back Handlebar (55914-98)**

1997-2001 FLHTCI	OEM Stock	Stainless Steel Braided	Diamondback™	Diamond-Black
Clutch Cable	38649-98	Not available	Not available	Not available
Throttle Cable	38650-98	Not available	Not available	Not available
Idle Cable	38652-98	Not available	Not available	Not available
Brake Lines	Not available	45212-97B	Not available	Not available

**1997-2001 FLHT & FLHTC**

Clutch Cable	38649-98	Not available	Not available	Not available
Throttle Cable	56357-96	Not available	Not available	Not available
Idle Cable	56424-98	Not available	Not available	Not available
Brake Lines	Not available	45212-97B	Not available	Not available

**1997 FLHTCU**

Clutch Cable	38649-98	Not available	Not available	Not available
Throttle Cable	56357-96	Not available	Not available	Not available
Idle Cable	56071-98	Not available	Not available	Not available
Brake Lines	Not available	45212-97B	Not available	Not available

**1997-2001 FLHTCUI**

Clutch Cable	38649-98	Not available	Not available	Not available
Throttle Cable	38650-98	Not available	Not available	Not available
Idle Cable	38651-98	Not available	Not available	Not available
Brake Lines	Not available	45212-97B	Not available	Not available

**2002-2007 FLHT, FLHTC & FLHTCU**

Clutch Cable ('02-'06 models)	38649-98	Not available	38922-09	Not available
Clutch Cable ('07 models)	38649-07	Not available	38922-09	Not available
Throttle/Idle Cable	38650-98/56730-03	Not available	38778-05	Not available
Brake Lines	Not available	45212-97B	Upper 44213-08 / Lower 45820-07	Not available

\*NOTE: Installation of some handlebars and risers may require a change in clutch and/or throttle cable and brake hose for some models. Handlebar height is regulated in many states. Check state or local laws before installation.

Notice: The prices appearing in this catalog are the manufacturer's suggested retail prices. Actual retail prices may vary.

# 594 CONTROLS

## Handlebars

### A. CHROME ROAD KING® HIGH HANDLEBAR\*

Designed to provide extra comfort for the Road King rider, this chrome bar is 4-1/2 inches higher and 2 inches narrower than the stock handlebar found on '96-'99 Road King models and 3-1/2 inches higher and 1-1/2 inches narrower than stock handlebar on '00-'01 Road King models. Many models require no additional cables or hoses for installation.

**55954-00** **\$79.95**  
Fits '96-'07 Road King® and '02-'07 Road Glide® models.



**A. CHROME ROAD KING HIGH HANDLEBAR**

### Chrome Road King High Handlebar (55954-00)

	OEM Stock	Stainless Steel Braided	Diamondback™	Diamond-Black
<b>1996-2001 FLHR &amp; FLHRC</b>				
Clutch Cable	Stock 38667-00	38660-03	38921-09	38967-10
Throttle / Idle Cables	Stock 56523-02 / 56522-02 or 56376-02 / 56237-99A	56616-03	Not Available	Not available
Brake Lines	Stock 43350-96B	45212-97B	Upper 44306-08 / Lower 45818-07	Not available
<b>2002-2007 FLHR &amp; FLHRC</b>				
Clutch Cables ('02-'06 models)	Stock 38667-00	38660-03	38921-09	38967-10
Clutch Cables ('07 models)	Stock 38667-07	Not available	38921-09	38967-10
Throttle / Idle Cables	Stock 56523-02 / 56522-02 or 56376-02 / 56237-99A	56616-03	56810-05	Not available
Brake Lines	Stock 43350-96B	45212-97B	Upper 44306-08 / Lower 45818-07	Not available
Switch Wire Extension Kit ('02-'03 models)	72187-05	72187-05	72187-05	72187-05
Switch Wire Extension Kit ('04-'06 models)	72184-04	72184-04	72184-04	72184-04
Switch Wire Extension Kit ('07 models)	70198-07	70198-07	70198-07	70198-07
<b>2004-2007 FLHRS</b>				
Clutch Cables ('04-'06 models)	Stock 38667-00	38660-03	38921-09	38967-10
Clutch Cables ('07 models)	Stock 38667-07	Not available	38921-09	38967-10
Throttle / Idle Cables	Stock 56295-03 / 56293-03 or 56555-04 / 56554-04	56719-03	56810-05	Not available
Brake Lines	Not available	45510-04	Upper 44306-08 / Lower 45818-07	Not available
<b>2002-2007 FLTR</b>				
Clutch Cables ('02-'06 models)	Stock 38667-00	38660-03	38921-09	38967-10
Clutch Cables ('07 models)	Stock 38667-07	Not available	38921-09	38967-10
Throttle / Idle Cables	Stock 56295-03 / 56293-03 or 56555-04 / 56554-04	56719-03	56810-05	Not available
Brake Lines	Not available	45510-04	Upper 44306-08 / Lower 45818-07	Not available

### B. HERITAGE SOFTAIL® CLASSIC CHROME HANDLEBAR\*

Chrome-plated version of the stock bar. Replaces Original Equipment P/N 56569-86.

**56623-99** **\$69.95**  
Fits '86-later FLSTC models. '09-later models require separate purchase of cables and brake lines.



**B. HERITAGE SOFTAIL CLASSIC CHROME HANDLEBAR**

### Heritage Softail Classic Chrome Handlebar (56623-99)

	OEM Stock	Stainless Steel Braided	Diamondback™	Diamond-Black
<b>2009-later FLSTC</b>				
Clutch Cable	Not available	38674-03	38851-09	38818-10
Throttle/Idle Cables	Not available	56344-03A	56807-05A	Not available
Brake lines	Not available	41011-01	Upper 42770-07 / Lower 42371-07	Not available

\*NOTE: Installation of some handlebars and risers may require a change in clutch and/or throttle cable and brake hose for some models. Handlebar height is regulated in many states. Check state or local laws before installation.

Notice: The prices appearing in this catalog are the manufacturer's suggested retail prices. Actual retail prices may vary.



C

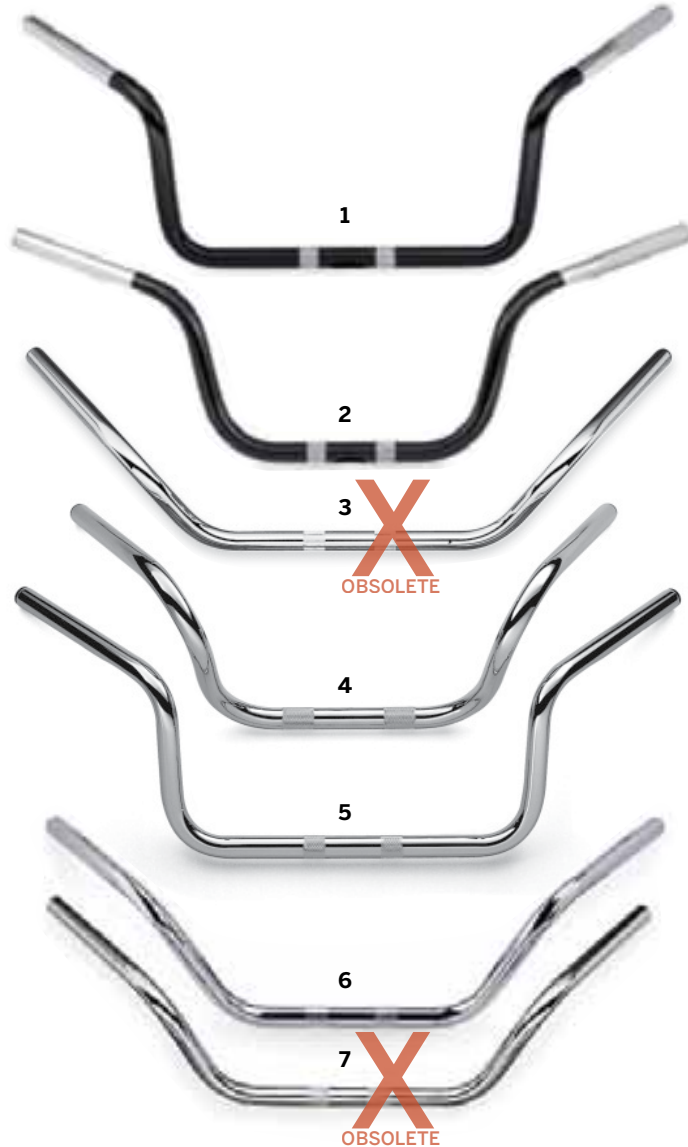

C. TOURING HANDLEBARS

## C. TOURING HANDLEBARS

### 1. Electra Glide® Satin Black Handlebar\*

**55861-09** Fits '08-later FLHT, FLHTC, FLHTCU and FLHX models. **\$79.95**

No additional cables or lines required. Dimensions: Tip to Tip 30.25"; Base Width 15.75"; Pull Back 6.25"; Knurl 3.50"; Rise 9.75".

**55865-09** Fits '97-'07 FLHT and FLHX models. No additional cables or lines required. Dimensions: Tip to Tip 30.25"; Base Width 15.75"; Pull Back 6.25"; Knurl 3.50"; Rise 9.75". **\$79.95**

**55862-09** Fits '08-later FLTR models. No additional cables or lines required. Dimensions: Tip to Tip 31.50"; Base Width 10.50"; Pull Back 9.50"; Knurl 3.14"; Rise 6.75". **\$79.95**

**55866-09** Fits '98-'07 FLTR models. No additional cables or lines required. Dimensions: Tip to Tip 31.50"; Base Width 10.50"; Pull Back 9.50"; Knurl 3.14"; Rise 6.75". **\$79.95**

**3. Fat Boy/Road King Chrome Handlebar\***

Chrome-plated handlebars are designed to be exact replacements for the Original Equipment stainless-steel handlebars. **OBSOLETE**

**55919-82T** Fits FLH, FLSTF and FLHR (except '08-later FLHR) models equipped with P/N 55919-82 as Original Equipment. **\$79.95**

**4. Springer® Softail® Chrome Handlebar\***

Chrome-plated version of the stock bar. Replaces Original Equipment P/N 56093-88A. **OBSOLETE**

**56624-99** Fits '88-'06 FXSTS models. **\$69.95**

**5. Electra Glide® Standard Chrome Handlebar\***

Chrome-plated version of the stock Electra Glide handlebar. Replaces Original Equipment P/N 55924-97. **OBSOLETE**

**56625-99** Fits '97-'07 FLHT and FLHX models. **\$79.95**

**6. Chrome Touring Handlebar\***

Our popular Road King® Touring Handlebar in chrome. Narrower and taller than stock bars for added comfort on long hauls.

**56557-95** Fits FLSTF, FLSTN, FLHR (except '08-later FLHR) models with P/N 55919-82 as Original Equipment. **\$79.95**

**7. Chrome FLSTF, FLSTN, FLHR Handlebar\***

Slightly narrower than the stock FLSTF, FLSTN and '99 FLHR handlebars (standard shape on '00-later Road King models). **OBSOLETE**

**56552-95** Fits FLSTF, FLSTN, FLHR (except '08-later FLHR) models with P/N 55919-82 as Original Equipment. **\$79.95**

**D. HANDLEBARS\***

Pick from a variety of handlebars to fit your riding style. These bars are made from high-quality steel for strength and durability.

**1. 55934-89** Buckhorn. Fits '88-'91 models with Air Reservoir. **\$74.95**

**2. 55934-92** Buckhorn. Fits '92-'03 models with Air Reservoir. **\$74.95**

**3. 56085-83A** Fits XR1000 and XLX883 models. **\$53.95**

**4. 56082-83** Fits XL883 models through '03. **\$53.95**

**5. 56110-98** Fits XL models (except XL883N and XL1200N). Stock on '98-'03 XL1200 Sport models. **\$56.95**

**6. 56081-82A** Buckhorn without Air Reservoir. **\$53.95**

**7. 55919-82** FLH models. **\$56.95**

**8. 56079-93** Ape Hangers. **\$59.95**

**9. 56569-86** FLST models (except FLSTS/I). **\$56.95**

**10. 55920-83B** Fits '83-'87 FLT/FLHT models. **\$74.95**

**56102-99** Stock on '99-later FXST and '06 FLST models. (not shown) **\$53.95**

\*NOTE: Installation of some handlebars and risers may require a change in clutch and/or throttle cable and brake hose for some models. Handlebar height is regulated in many states. Check state or local laws before installation.

Notice: The prices appearing in this catalog are the manufacturer's suggested retail prices. Actual retail prices may vary.

D

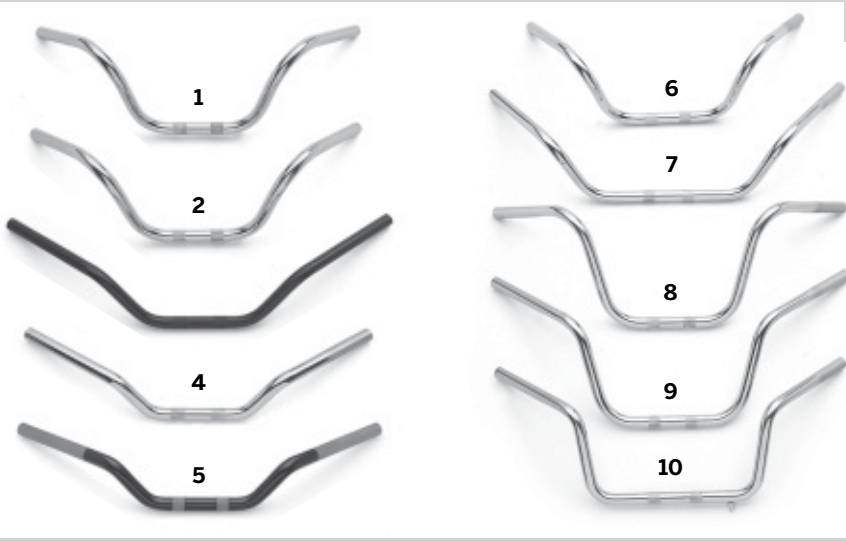

D. HANDLEBARS

# 596 CONTROLS

## Handlebar Risers & Hardware

### A. FAT BAR RISER KIT\*

Go phat with bold chrome-plated risers. Hidden fasteners create a clean, seamless look. Kit includes all necessary mounting hardware.

**56916-07** **\$109.95**

Fits most 1.25" handlebars. Does not fit Original Equipment FLSTC, FXDF, FLSTF, FLSTFB and FXDWG 1.25" handlebars. Does not fit with Softail Nacelle Kit P/N 67907-97B. All models require separate purchase of additional installation components. See your dealer for specific model requirements.



A. FAT BAR RISER KIT

### B. BLACK HANDLEBAR RISER KIT\*

Add a splash of darkness to your front end with these blacked out risers. First introduced on the FXDF model, these risers feature a gloss black finish that will look good with any black or chrome bar.

**55996-09** **\$129.95**

Fits most 1.25" handlebars. Does not fit Springer models. Requires separate purchase of additional components.



B. BLACK HANDLEBAR RISER KIT

### C. CURVED PULLBACK RISER\*

These chrome-plated Curved Pullback Risers provide a comfortable riding position for those who like the shape, width, and hand position of their current handlebar, but wish it was closer. For an ergonomically-friendly ride, these risers can be combined with a Harley-Davidson Reach® seat and Profile® Low suspension components to reduce arm stretch and to plant the feet firmly on the ground.

Fits most 1.25" handlebars. Does not fit Springer® models or '09-later FLSTC models. Installation may require separate purchase of handlebar clamp. Installation also may affect fitment of handlebar-mounted instruments.

**56269-09** 4" Curved Riser. **\$149.95**

**56267-09** 6" Curved Riser. **\$169.95**

\*NOTE: Installation of some handlebars and risers may require a change in clutch and/or throttle cable and brake hose for some models. Handlebar height is regulated in many states. Check state or local laws before installation.



C. CURVED PULLBACK RISER - 4"

### D. SLOTTED HANDLEBAR RISER KIT\*

These forged aluminum risers sweep back in a gentle curve to place a 1" handlebar in a comfortable riding position. The mirror-chrome finish adds a brilliant touch, and the slotted design complements billet mirror stems and slotted hand control levers.

**56296-05** **\$129.95**

Fits '99-'05 FXDL, FXDWG and '00-later Softail® models (except Springer, FXCW/C, FXSTB, FLSTC, FLSTSB and '07-later FLSTF). FXSTD models require separate purchase of (2) Spacer P/N 6740.



D. SLOTTED HANDLEBAR RISER KIT

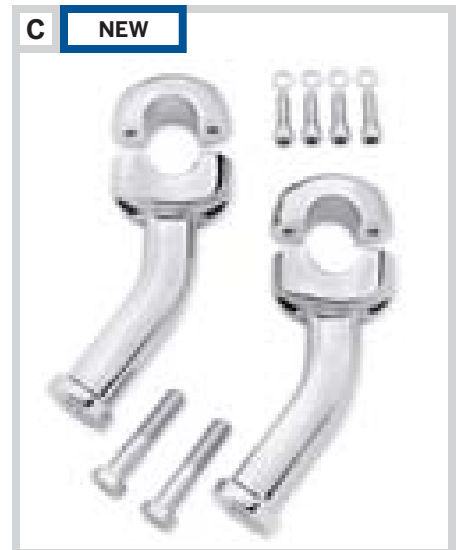

C. CURVED PULLBACK RISER - 6"

### E. DELUXE PULLBACK RISER AND CLAMP KIT\*

Inspired by the Softail Deluxe model, these curved pullback risers and matching handlebar clamp add a custom look to your bike. The chrome riser kit is a direct replacement for the aluminum curved risers found on Softail Standard and Dyna® Low Rider® models.

**56290-05** **\$159.95**

Fits '97-later FXST and FXSTC and '97-'05 FXDL models with stock or accessory 1" dia. handlebar. Does not fit with Road Tech™ Compass Kit.



E. DELUXE PULLBACK RISER AND CLAMP KIT

\*NOTE: Installation of some handlebars and risers may require a change in clutch and/or throttle cable and brake hose for some models. Handlebar height is regulated in many states. Check state or local laws before installation.

Notice: The prices appearing in this catalog are the manufacturer's suggested retail prices. Actual retail prices may vary.



**F. CHROME HANDLEBAR RISER KITS – STRAIGHT**



**F. CHROME HANDLEBAR RISER KITS – CURVED**



**G. CHROME HANDLEBAR RISER HARDWARE KIT**



**H. BILLET HANDLEBAR RISER HARDWARE**



**I. CHROME RISER CUP WASHER KIT**



**J. POLYURETHANE HANDLEBAR RISER BUSHINGS**

### F. CHROME HANDLEBAR RISER KITS\*

These chrome-plated Risers provide a comfortable riding position for those who like the shape, width, and hand position of their current 1" handlebar, but wish it was closer. For an ergonomically-friendly ride, these risers can be combined with a Harley-Davidson Reach® forward-position seat and Profile® Low suspension components to reduce arm stretch and to plant the feet firmly on the ground. Finish off the look with a Harley-Davidson decorative handlebar clamp kit.

Fits most 1" handlebars. Does not fit Springer® models. Installation may require separate purchase of handlebar clamp. Installation also may affect fitment of handlebar-mounted instruments.

<b>56066-82A</b>	4" Curved Risers.	<b>\$129.95</b>
<b>56063-82A</b>	4" Straight Risers.	<b>\$129.95</b>
<b>56266-09</b>	6" Curved Risers.	<b>\$119.95</b>
<b>56223-98</b>	6" Straight Risers.	<b>\$129.95</b>

### G. CHROME HANDLEBAR RISER HARDWARE KIT

Finish the show-winning look with brilliant chrome hardware. Manufactured to Original Equipment specifications, this kit replaces the zinc-plated exposed handlebar riser hardware with chrome-plated bolts and chrome lock washers.

**63027-05** **\$9.95**

Fits '91-later Dyna® models (except '08-later FXDB, FXDF and FXDSE/2) and '97-later FXST, FXSTB, FXSTC and FXSTD models. Also fits '93-'00 FXR models.

### H. BILLET HANDLEBAR RISER HARDWARE

Provides a highly polished and plated, machined steel, conical shaped washer. Chrome socket head cap screw is countersunk into the washer upon installation for a very clean look. Screws are also chrome-plated. Looks great with Original Equipment or billet triple trees.

**63026-05** **\$39.95**

Fits '91-later Dyna® models (except '08-later FXDB) and '97-later FXST, FXSTB, FXSTC and FXSTD models. Also fits '93-'00 FXR models.

### I. CHROME RISER CUP WASHER KIT

Add a finishing touch to the riser on your bike. This kit includes two styled and chrome-plated washers that replace the standard metal washers below the handlebar risers. Replaces Original Equipment P/N 56159-73.

**56486-01** **\$23.95**

Fits many XL (except '04-later XL), Dyna and Softail® models. See your Dealer for specific model application. (Does not fit with Polyurethane Handlebar Bushings P/N 56165-03.)

### J. POLYURETHANE HANDLEBAR RISER BUSHINGS

These Handlebar Riser Bushings replace the Original Equipment stacked rubber and zinc washer combination with a long-lasting polyurethane bushing and cover. The long-lasting one-piece bushing can reduce handlebar vibration.

**56298-03** **\$39.95**

Fits '83-later Touring models (except Trike). '83-'93 models require use of '94-later Riser Bolts P/N 3605.

**56165-03** **\$39.95**

Fits '97-'03 XL, '86-later Dyna (except FXDB) and Softail® (except Springer models and FXSTD) models. '86-'93 FL Softail models require use of '94-later Riser Bolts. Will not fit with Chrome Riser Cup Washer Kit P/N 56486-01.

\*NOTE: Installation of some handlebars and risers may require a change in clutch and/or throttle cable and brake hose for some models. Handlebar height is regulated in many states. Check state or local laws before installation.

Notice: The prices appearing in this catalog are the manufacturer's suggested retail prices. Actual retail prices may vary.

# 598 CONTROLS

## Handlebar Clamps

### A. CHROME HANDLEBAR CLAMP HARDWARE KIT

Finish the show-winning look with brilliant chrome hardware. Manufactured to Original Equipment specifications, this kit replaces the zinc-plated exposed handlebar clamp bolts with chrome-plated socket head cap screws.

**94451-05** **\$8.95**

Fits '94-later FXSTS, FXSTSB, FXSTD, FXSTDSE, FLSTS, FLSTSC, FLSTSB and '05-later FLSTN and FXSTSSE/2 models.

**94452-05** **\$8.95**

Fits '94-'06 FXDL, '06-FXD, FXDB, FXDC, FXD35, '94-'05 FXDWG, FXDWG2/3, FXR2/3, '94-later FXST, FXSTB, FXSTC, FLST, FLSTC, '94-'06 FLSTF and '93-'96 FLSTN models.

**94453-05** **\$8.95**

Fits '95-later XL models (except XL Custom, XL883N, XL1200L and XL1200N), and '94-'95 FXD, FXDC, FXDX, FXDXT and FXDS-CONV. models.

**94454-05** **\$8.95**

Fits XL1200L, XL1200N, '96-'06 XL883C and XL1200C, '07-later Dyna®, '00 FXR4, FLSTSE, and FLSTFSE/2 models.

### B. HANDLEBAR CLAMP BOLT COVERS

Complete the chrome hand control conversion. These thin-wall bolt covers are designed for easy installation over handlebar clamp bolts. The machined brass and chrome-plated covers are corrosion resistant, and the internal spring steel retention clip resists vibration and thermal cycling to securely hold the covers in place. Kit includes 4 covers.

**94413-04** **\$17.95**

Fits 5/16" socket head handlebar clamp bolts. (Does not fit Touring models.)

### C. BILLET HANDLEBAR CLAMPS

Machined from solid billet, this sleek clamp offers a simple style.

Fits '93-'05 FXDL, '93-'05 FXDWG models, '84-'99 FXSTC, '84-'08 FLSTC, '84-later FXST, FXSTB and '90-'06 FLSTF models with stock or accessory 1" dia. handlebars. Not compatible with Road Tech™ Radios.

**56052-00** Harley-Davidson. **\$49.95**

**56060-01** Willie G. Skull. **\$49.95**

### D. HANDLEBAR CLAMPS

Fits '74-later XL, FXD, FXR, FX and FX Softail® models with stock and accessory 1" dia. handlebars (except '06-later FXD, all FXSTD, FXSTS, FXSTSB, FLSTS, FXLR, '96-later XL Customs and '06-later XL883N, XL1200L and XL1200N, '07-later FXSTC and '99-later FXR).

**56178-92TA** Gold "Live to Ride". **\$32.95**

**56177-92TA** Chrome "Live to Ride". **\$24.95**

**56101-98** Flames. **\$32.95**

### E. CUSTOM HANDLEBAR CLAMPS

Fits '74-later XL, FXD, FXR, FX and FX Softail® models with stock and accessory 1" dia. handlebar (except '06-later FXD, all FXSTD, FXSTS, FXSTSB, FLSTS, FXLR, '96-later XL Customs and '06-later XL883N, XL1200L and XL1200N, '07-later FXSTC and '99-later FXR).

**56170-83TA** Classic Chrome. **\$19.95**

**56567-86B** Bar & Shield. **\$37.64**



**A. CHROME HANDLEBAR CLAMP HARDWARE KIT**



**B. HANDLEBAR CLAMP BOLT COVERS**



**C. BILLET HANDLEBAR CLAMP – HARLEY-DAVIDSON**



**C. BILLET HANDLEBAR CLAMP – WILLIE G. SKULL**



**D. HANDLEBAR CLAMPS**



**E. CUSTOM HANDLEBAR CLAMPS**

Notice: The prices appearing in this catalog are the manufacturer's suggested retail prices. Actual retail prices may vary.





**CHROME HAND CONTROL COMPONENTS**

### CHROME HAND CONTROL COMPONENTS

The flash of chrome. It's the first thing that everyone sees. And the one thing that everyone remembers. Dressing your bike's hand controls in chrome is one of the first steps in building a complete custom ride. After all, the hand controls are the one visual and physical connection you have with your bike every minute you are in the saddle. Harley-Davidson offers all the components you need to make the custom conversion.

A complete Chrome Hand Control makeover would include:

- Chrome Clutch Bracket and Master Cylinder Reservoir Kit
- Chrome Switch Housing Kit
- Chrome Switch Cap Kit
- Chrome Hand Control Levers
- Custom Hand Grips
- Custom Brake Lines and Control Cables

### F. CHROME CLUTCH BRACKET AND MASTER CYLINDER RESERVOIR KIT

Replace your stock painted aluminum controls with brilliant chrome, without compromising quality. This kit is manufactured from the Original Equipment components and includes Chrome Master Cylinder Cover. When combined with Chrome Switch Housing Kit, Chrome Switch Caps, and other Harley-Davidson® Genuine Motor Accessories, this front brake control kit provides a look that does more than stop your bike – it can stop traffic.

**45355-08** **\$329.95**  
Fits '08-later Dyna® and Softail® models equipped with single disc front brakes.

**42307-07** **\$329.95**  
Fits '07-later XL models with single disc front brakes.

**42307-04** **\$349.95**  
Fits '04-'06 XL models with single disc front brakes.

**45284-99D** **\$329.95**  
Fits '96-'03 XL, '96-'05 Dyna® and Softail® models with single disc front brakes. (Does not fit models equipped with hydraulic clutch.)

**45281-99D** **\$329.95**  
Fits '96-'03 XL, '96-'05 Dyna, Softail and '96-'04 Touring models with dual disc front brakes. (Does not fit models equipped with hydraulic clutch.)

**45355-06A** **\$329.95**  
Fits '06-'07 Dyna and Softail models equipped with single disc front brakes. (Does not fit models equipped with hydraulic clutch.)

**46418-05A** **\$329.95**  
Fits '05-'07 Touring and '06 Dyna and Softail models with dual disc front brakes. (Does not fit models equipped with hydraulic clutch.)

**46112-02D** **\$399.95**  
Fits '02-'05 VRSC™ models. Also fits hydraulic clutch-equipped '96-'05 Dyna, Softail and '96-'04 Touring models with dual disc front brakes.

**42100-06A** **\$639.95**  
Fits '06-later VRSC™ models.

**42117-08** **\$384.95**  
Fits '08-later Touring models. (Does not fit models equipped with hydraulic clutch.)



**F**

**F. CHROME CLUTCH BRACKET AND MASTER CYLINDER KIT – '06-LATER DYNA/SOFTAIL STYLE**



**F**

**F. CHROME CLUTCH BRACKET AND MASTER CYLINDER KIT – '07-LATER SPORTSTER STYLE**



**F**

**F. CHROME CLUTCH BRACKET AND MASTER CYLINDER KIT – '08-LATER TOURING STYLE**



**F**

**F. CHROME CLUTCH AND BRAKE MASTER CYLINDER KIT – '06-LATER VRSC STYLE**

*Notice: The prices appearing in this catalog are the manufacturer's suggested retail prices. Actual retail prices may vary.*

# 600 CONTROLS

## Hand Controls & Levers

### A. CHROME SWITCH HOUSING KIT

Convert your housings from black to chrome with this complete kit. Includes left, right, upper and lower housings. No switches or wiring required. Installation instructions included.

**70222-96B \$139.95**  
Fits '96-later VRSC™, XL, XR, Dyna®, Softail®, and FLHR Road King® models. Does not fit FXSTDSE and FLHRSEI2 models.

**70223-96B \$149.95**  
Fits '96-later FLHT, FLHTC, FLHX, FLTRX and FLHXXX models without cruise control.

**70228-96C \$149.95**  
Fits '96-later FLHTCU, FLHTK, FLTR and FLHTCUTG models and '02-later FLHRC models. Also fits '02-later FLHR models equipped with cruise control.

**71813-09 \$149.95**  
Fits '96-later FLHT, FLHTC, FLHX, FLTRX and FLHXXX models equipped with cruise control.



A. CHROME SWITCH HOUSING KIT



A. CHROME SWITCH HOUSING KIT

### B. CHROME SWITCH CAP KIT

Not satisfied until everything you see is chrome? These Chrome Switch Cap Kits will add style to one of the most visible areas of your bike, the switches. Shaped for the same ergonomic feel as the Original Equipment hand control switches, these caps replace the stock black caps without re-wiring. The chrome switch caps complement other chrome hand control accessories (Chrome Master Cylinder Kit, Chrome Hand Levers, Chrome Switch Housings, and Chrome Master Cylinder Cover) to complete the custom look.

**71803-03 \$19.95**  
Fits '96-later FLHT, FLHTC, FLHX, FLTRX and FLHXXX models without cruise control.

**71802-03 \$23.95**  
Fits '96-later FLHTCU, FLHTK, FLHTCUTG and FLTR models.

**71804-03 \$18.95**  
Fits '96-later XL, XR, Dyna, Softail and FLHR models, '02-later VRSC models, and '98-01 FLHRC models. FLHR models equipped with cruise control use Kit P/N 71808-03.

**71808-03 \$19.95**  
Fits '02-later FLHRC models and FLHR models equipped with cruise control.

**71816-09 \$23.95**  
Fits '96-later FLHT, FLHTC, FLHX, FLTRX and FLHXXX models equipped with cruise control.



B. CHROME SWITCH CAP KIT  
(SHOWN WITH CHROME SWITCH HOUSING)



B. CHROME SWITCH CAP KIT  
(71816-09 SHOWN)

### C. CHROME MASTER CYLINDER COVER

Includes one chrome-plated cover, gasket, and decal. Easily installed with included stainless steel screws.

**42123-08 \$59.95** Fits '08-later Touring models.

### D. CHROME MASTER CYLINDER COVER KIT

Includes one chrome-plated cover, gasket, and decal. Easily installed with included stainless steel screws.

**45078-96D \$34.95**  
Fits '96-'03 XL, '02-'05 VRSC, '96-'05 Dyna, Softail and '96-'04 Touring models.

**46424-05B \$34.95**  
Fits '05-'07 Touring, '06-later Dyna and Softail models.

**42313-07 \$39.95** Fits '07-later XL models.

**42313-04 \$39.95** Fits '04-'06 XL models.



C. CHROME MASTER CYLINDER COVER –  
'08-LATER TOURING

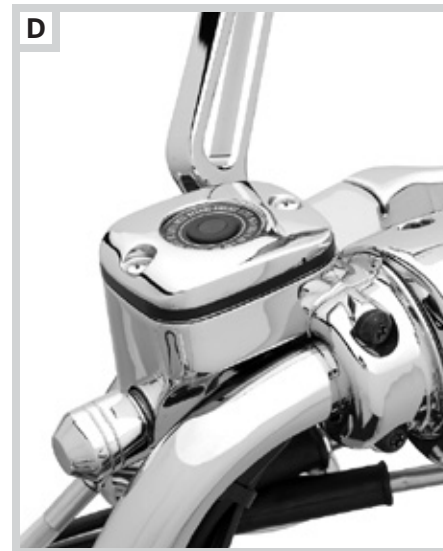

D. CHROME MASTER CYLINDER COVER –  
MULTI-FIT

Notice: The prices appearing in this catalog are the manufacturer's suggested retail prices. Actual retail prices may vary.

# CONTROLS 601

Hand Controls & Levers



E

**E. BLACK MASTER CYLINDER COVER**

## E. BLACK MASTER CYLINDER COVER

Identical to the Original Equipment Brake Master Cylinder Cover, this kit can be used to match your Hydraulic Clutch Master Cylinder to the stock black controls. Kit includes one cover, gasket, decal and mounting screws.

**46423-05B**

**\$29.95**

Fits '05-'07 Touring, '06-later Dyna® and Softail® models.

## F. HANDLEBAR RESERVOIR COVER SET

This kit includes a chrome-plated clutch bracket, handlebar control clamps, master cylinder cover and hardware to completely finish chroming the hand controls. Combine with chrome-plated Switch Housing Kit P/N 70222-96B to finish the look. Cannot be used with Auxiliary Lighting Kits.

**46099-98**

**\$74.95**

Fits '96-'03 XL models and '96-later Dyna®, Softail® and '96-'07 Touring models with dual disc front brakes. (Does not fit VRSC™ models or models equipped with hydraulic clutch.)

**46098-98**

**\$74.95**

Fits '96-'03 XL models and '96-later Dyna and Softail models with single disc front brakes. (Does not fit models equipped with hydraulic clutch.)

## G. BILLET CLUTCH CABLE ADJUSTER DUST COVER

Replace the black rubber clutch cable boot with brilliant chrome. Machined from billet aluminum, this two-piece "ball-milled" dust cover offers a striking contrast to Original Equipment black cables, and a natural finishing touch when installing a braided clutch cable. Easy-to-install with included hardware.

**64108-03**

**\$49.95**

Fits '00-later XL, Dyna® and Softail® models (except FLTSE). '00-'03 XL models require installation of Clutch Cable Clamp P/N 91147-02, and '04-later XL models require installation of Clutch Cable Clamp P/N 91249-04 (sold separately).

## H. CHROME THROTTLE AND IDLE CABLE ADJUSTER COVERS

Replace the black rubber throttle and idle cable boots with brilliant chrome. This two-piece "ball-milled" dust cover offers a striking contrast to Original Equipment black cables, and a natural finishing touch when installing braided cables. Easy-to-install with included hardware.

**64115-04**

**\$59.95**

Fits '96-'07 Touring models (except FLHRS with Original Equipment handlebars) and '96-later FXSTB and FLSTC, and '05-later FLSTN. Will fit '05-later Softail models equipped with separate purchase of a Front Turn Signal Relocation Kit.



F



F

**F. HANDLEBAR RESERVOIR COVER SET  
(SHOWN WITH CHROME CLUTCH FERRULE AND BANJO BOLT COVER KIT)**



G

**G. BILLET CLUTCH CABLE  
ADJUSTER DUST COVER**



H

**H. CHROME THROTTLE AND IDLE CABLE  
ADJUSTER COVERS**

Notice: The prices appearing in this catalog are the manufacturer's suggested retail prices. Actual retail prices may vary.

# 602 CONTROLS

## Hand Controls & Levers

### A. CHROME HAND CONTROL LEVER KIT

Continue the chrome theme with these Hand Control Levers. Cast from aluminum, these levers feature a custom finish designed to match the accessory chrome hand controls or complement Original Equipment-style black components. Clutch anti-rattle clip and new pivot bushing included.

**45075-08** Fits '08-later Dyna® and Softail® models. **\$99.95**

**38843-08** Fits '08-later Touring models. **\$139.95**

**45075-07** Fits '96-'03 XL models and '96-'07 Dyna®, Softail® and Touring models. (Does not fit police models, VRSC™ models, or models equipped with hydraulic clutch.) **\$99.95**

**44992-07** Fits '04-later XL and XR models. **\$109.95**

**46114-07** Fits '02-'05 VRSC models and '96-'06 Dyna, Softail and Touring models equipped with hydraulic clutch. **\$85.95**

**42270-06A** Fits '06-later VRSC models. **\$159.95**



A. CHROME HAND CONTROL LEVER

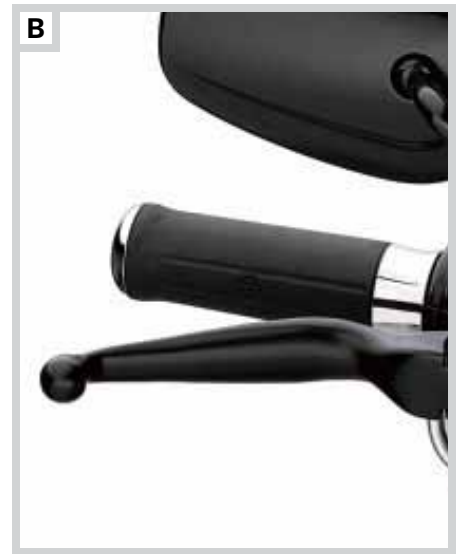

B. BLACK HAND CONTROL LEVER

### B. BLACK HAND CONTROL LEVER KIT

Grab some black with these levers – a natural fit for black accessory handlebars or to further the blacked-out look of your motorcycle. A clutch anti-rattle clip and new pivot bushings are included.

**44994-08** Fits '08-later Dyna and Softail models. **\$99.95**

**38845-08** Fits '08-later Touring models. **\$139.95**

**44994-07** Fits '96-'03 XL models and '96-'07 Dyna, Softail and Touring models. (Does not fit police models, VRSC models, or models equipped with hydraulic clutch.) **\$99.95**

**46944-07A** Fits '04-later XL and XR models. **\$79.95**

**46157-03** Fits '02-'05 VRSC models and '96-'06 Dyna, Softail and Touring models equipped with hydraulic clutch. **\$99.95**

**42275-07A** Fits '06-later VRSC models. **\$99.95**



C. FLAME HAND CONTROL LEVER – CHROME

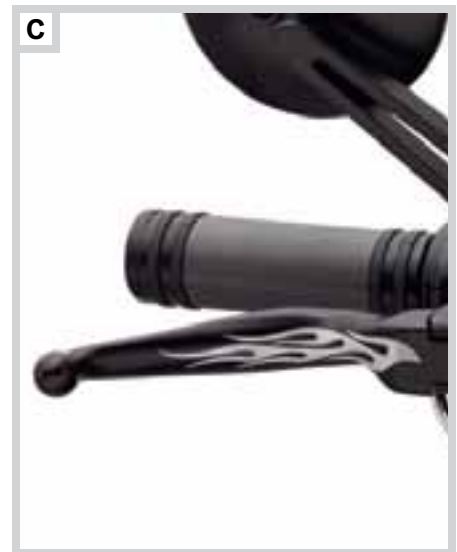

C. FLAME HAND CONTROL LEVER – BLACK

### C. FLAME HAND CONTROL LEVER KIT

A custom look almost too hot to touch. These chrome-plated or satin black hand control levers feature an etched flame design that rips across the surface from tip to grip.

Fits '08-later Dyna and Softail models.

**46710-08** Chrome. **\$149.95**

**42535-08** Black. **\$139.95**

Fits '96-'03 XL models and '96-'07 Dyna, Softail and Touring models. (Does not fit police, VRSC, or models equipped with hydraulic clutch.)

**46710-07** Chrome. **\$149.95**

**38935-08** Black. **\$139.95**

### D. SKULL HAND CONTROL LEVER KIT

Styled to complement the Harley-Davidson Skull Collection. The sinister skull logo and horizontal bars have been deep-etched into the hand lever for a custom look that stretches from pivot to tip.

Fits '08-later Dyna and Softail models.

**46982-08** Chrome. **\$149.95**

**41793-08** Black. **\$139.95**

Fits '96-'03 XL models and '96-'07 Dyna, Softail, and Touring models. (Does not fit police, VRSC, or models equipped with hydraulic clutch.)

**46982-07** Chrome. **\$149.95**

**38933-08** Black. **\$139.95**



D. SKULL HAND CONTROL LEVER – CHROME

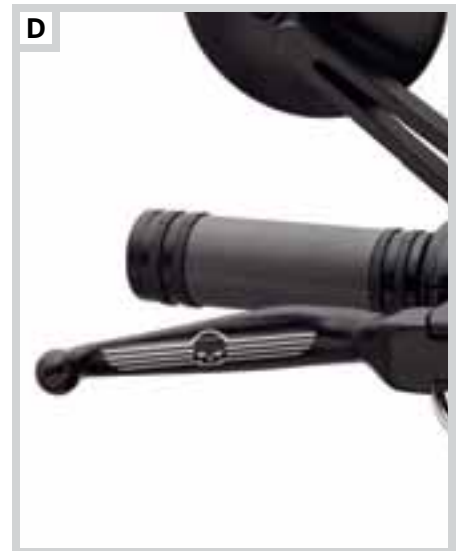

D. SKULL HAND CONTROL LEVER KIT – BLACK

*Notice: The prices appearing in this catalog are the manufacturer's suggested retail prices. Actual retail prices may vary.*



# CONTROLS 603

Hand Controls & Levers



**E. SLOTTED HAND CONTROL LEVER**

## E. SLOTTED HAND CONTROL LEVER KIT

Add that stripped-down custom look to your handlebar with these Slotted Chrome Hand Control Levers. Finished to a mirror-like shine, these billet-look levers place a touch of brilliance in the palm of your hand.

**45459-08** Fits '08-later Dyna® and Softail® models. **\$139.95**

**38853-08** Fits '08-later Touring models. **\$154.95**

**45459-07** Fits '96-'03 XL models and '96-'07 Dyna, Softail® and Touring models. (Does not fit police models, VRSC™ models, or models equipped with hydraulic clutch.) **\$139.95**

**45533-02** ~~OBSELETE~~ **\$123.95**  
Fits '02-'05 VRSC models and '96-'06 Dyna, Softail and Touring models equipped with hydraulic clutch.

**34648-07** Fits '06-later VRSC models. **\$159.95**

## F. BUCKSHOT HAND CONTROL LEVER KIT

Give a squeeze to these hot chrome custom hand levers. Loaded with "on target" style, these perforated levers are forged for added strength. The visual appeal shines through the counter-bored holes, and the finger notch offers a smooth, firm feel. A great match with Aileron grips, these Buckshot levers also complement any custom grip collection.

**45430-07** Fits '96-'03 XL models and '96-'07 Dyna®, Softail® and Touring models. (Does not fit police models, VRSC™ models, or models equipped with hydraulic clutch.) **\$159.95**



**F. BUCKSHOT HAND CONTROL LEVER**

## G. CHROME HAND CONTROL LEVER KIT WITH INSERTS

A custom finish to stock or accessorized hand controls. These mirror-chrome levers complement accessory Chrome Switch Housings and Master Cylinder Covers, and the contrasting satin finish "Harley-Davidson" scripted inserts add a finishing touch. Compatible with Scripted Hand Lever Inserts.

**45166-07** Fits '96-'03 XL models, and '96-'07 Dyna®, Softail®, and Touring models. (Does not fit police, VRSC™, or models equipped with hydraulic clutch.) **\$119.95**

## H. SCRIPTED HAND LEVER INSERT

Let the citizens know what you are riding. These satin-finished Hand Lever Inserts allow you to personalize the controls to your individual model. The easy-to-install inserts are the ideal complement to our Scripted Gear Shift Linkages.

Fits models equipped with Custom Hand Control Lever P/Ns 45166-07, 45459-07, 45459-08 and 45166-04.

**44527-02** "Road King" Script. (pair) **\$7.95**

**44534-02** "Dyna" Script. (pair) **\$7.95**

**44535-02** "Fat Boy" Script. (pair) **\$7.95**

**44529-02** "Softail" Script. (pair) **\$7.95**



**G. CHROME HAND CONTROL LEVER WITH INSERTS**



**H. SCRIPTED HAND LEVER INSERT**

# 604 CONTROLS

## Hand Controls & Levers

### A. CHROME BANJO BOLT KIT

Replace the Original Equipment 12-point zinc finish brake line hardware with brilliant chrome custom tapered banjo bolts.

**41842-06** **\$27.95**

Fits '91-'03 XL, '91-later Dyna® (except FXDF), '95-later Softail®, and '99-'00 FXR models equipped with single disc front brake. Does not fit with Banjo Bolt Cover Kit P/N 32715-98. Kit includes one 7/16" banjo bolt, three 3/8" banjo bolts and eight sealing washers.

**41844-06** **\$27.95**

Fits '02-'05 VRSCA and VRSCB models and '93-'07 Touring models. Does not fit with Banjo Bolt Cover P/N 32715-98. Kit includes three 3/8" banjo bolts and six sealing washers.

### B. CHROME BANJO BOLT KIT

Replace the Original Equipment zinc finish brake line hardware with brilliant chrome custom banjo bolts.

**41843-08** **\$44.95**

Fits '06-later VRSC™ models and '08-later Touring models.

### C. CHROME CLUTCH FERRULE AND BANJO BOLT COVER KIT

Die-cast chrome covers provide a custom look to your stock banjo bolts and handlebar clutch ferrule. Fits clutch ferrule on handlebar and banjo bolts on brake master cylinders and calipers. Installs in seconds.

**32714-98A** **\$27.95**

Fits '84-later models with stock master cylinder and calipers (except '02-later VRSC™, '08-later Touring and '04-later XL models). Will not fit models equipped with hydraulic clutch.



A. CHROME BANJO BOLT KIT



A. CHROME BANJO BOLT KIT



B. CHROME BANJO BOLT KIT



B. CHROME BANJO BOLT KIT



C. CHROME CLUTCH FERRULE AND BANJO BOLT COVER KIT

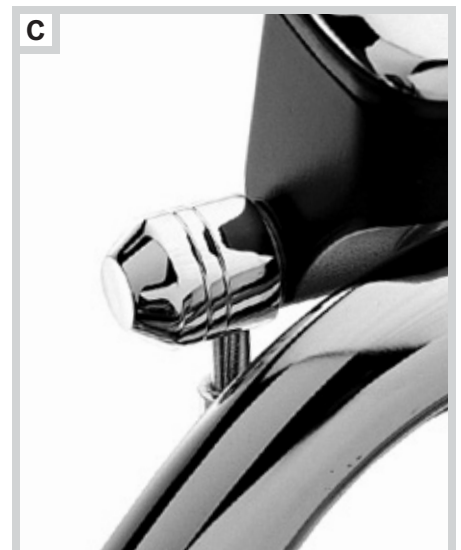

C. CHROME CLUTCH FERRULE AND BANJO BOLT COVER KIT

*Notice: The prices appearing in this catalog are the manufacturer's suggested retail prices. Actual retail prices may vary.*

# CONTROLS 605

Hand Controls & Levers



**D. AUXILIARY ACCESSORY SWITCH HOUSING KIT – CHROME (SHOWN WITH AUXILIARY ON/OFF SWITCH)**



**D. AUXILIARY ACCESSORY SWITCH HOUSING KIT – BLACK (SHOWN WITH AUXILIARY ON/OFF SWITCH)**



**E. CHROME SWITCH CAP KIT – AUXILIARY ON/OFF SWITCH CAP**



**F. REDUCED EFFORT CLUTCH KIT**



**G. HANDLEBAR SWITCH CONTROL KIT**

## D. AUXILIARY ACCESSORY SWITCH HOUSING KIT

Keep your eyes on the road and your hands on the grips with these easy-to-reach Auxiliary Accessory Switch Housings. Available for left and right hand control clusters, these housings will allow you to install up to six switches (when two housings are used) to control various electrical devices. Available in black to match Original Equipment switch housings or a bright chrome finish to complement accessory Chrome Switch Housing Kits. All necessary mounting hardware is included. Switches sold separately.

Fits '96-later VRSC™, XL, XR, Dyna®, Softail® and Touring models (except Trike). Does not fit models equipped with Large Diameter Handlebars or Tour-Pak® Mounted CD Changer P/N 77184-01. '04-later XL and XR models require separate purchase of (2) Screw P/N 3832M.

**70213-02C** Chrome Left Side. **\$34.95**

**70248-02B** Black Left Side. **\$34.95**

Fits '96-later VRSC™, XL, XR, Dyna®, Softail® and '96-'07 Touring models. Does not fit models equipped with Large Diameter Handlebars or Tour-Pak® Mounted CD Changer P/N 77184-01. '04-later XL and XR models require separate purchase of (2) Screw P/N 3832M.

**70255-02B** Chrome Right Side. **\$34.95**

**Shown with:**

## AUXILIARY ON/OFF SWITCH KIT

Styled to match the Original Equipment hand controls. These Auxiliary On/Off switches allow you to control additional electrical accessories with the touch of a finger when installed in the Auxiliary Accessory Switch Housing. Switches sold individually.

**71718-02** **\$13.95**

Fits Auxiliary Accessory Switch Housing Kits P/N 70255-02B, 70256-02, 70213-02C, and 70248-02B.

## E. CHROME SWITCH CAP KIT – AUXILIARY ON/OFF SWITCH CAP

Replace the stock black caps without re-wiring. The Chrome Switch Caps complement other chrome hand control accessories to complete the custom look.

**71656-07** **\$9.95**

Fits models equipped with Auxiliary On/Off Switch Kit P/N 71718-02. Kit contains one chrome On/Off Switch Cap and two chrome plugs for use with auxiliary switch housings equipped with P/N 71718-02.

## F. REDUCED EFFORT CLUTCH KIT

Kit includes a new clutch spring and inner/outer ramps that significantly reduce clutch lever effort. Original Equipment on '06-later Twin Cam-equipped models.

**36808-05** **\$44.95**

Fits '99-'05 Twin Cam-equipped models. Stock on '06-later Twin Cam-equipped models. This kit is not compatible with Screamin' Eagle® Performance Parts.

## G. HANDLEBAR SWITCH CONTROL KIT

Updated for use with '07-later models equipped with clutch interlock system. This exclusive Harley-Davidson kit simplifies the switch to custom style handlebars. Kit features the Original Equipment left and right switch housings, 60" wiring harness, and all necessary hardware.

**70239-07** **\$159.95**

Fits '96-later XL, XR, Dyna® and Softail® models (except '07-later FLSTF). Also fits '96-later Touring models without cruise control or radio controls.

# 606 CONTROLS

## Control Cables

### A. BILLET BRAKE LINE CLIP

It's the details that count. Replace the Original Equipment black brake line clamp with this beautifully chrome-plated billet aluminum clip. Sized for Original Equipment or accessory braided brake lines, these "ball-milled" clips mount in the factory position for easy installation. Kit includes chrome-plated mounting hardware.

**91336-03** **\$21.95**

For Original Equipment Brake Lines. Fits '00-'07 FXST, FXSTB, FXSTC, FXSTD, and FXDWG models equipped with Original Equipment Brake Lines.

**91364-03** **\$21.95**

Fits '00-later FXST, FXSTB, FXSTC, FXSTD, and FXDWG models equipped with Braided Brake Lines. Also fits '08-later FXST, FXSTB, FXSTC and FXDWG with Original Equipment Brake Lines.

**91369-03** **\$21.95**

Fits '00-later XL and Dyna® (except FXDWG) models equipped with Braided Brake Lines. Also fits '08-later Dyna models (except FXDWG) with Original Equipment brake lines.

**92006-05** **\$38.95**

For Original Equipment Brake Lines. Fits '97-'07 FLST, FLSTC, FLSTF, and FLSTN models. (two per kit)



A. BILLET BRAKE LINE CLIP

### B. CHROME CLUTCH CABLE CLIP

It's all in the details. This high-polish chrome-plated clip replaces the plastic clutch cable clip on the frame tube, and locks the cable in place for a custom look. Kit includes chrome cable clip, chrome backing plate, and chrome hardware for easy installation.

**91360-03** **\$29.95**

Fits '00-later Softail® models (except FXCW/C, and FXSTSSE3).

### C. CHROME BILLET CLUTCH CABLE CLAMP

The perfect addition to braided or stock black clutch cables. This Clutch Cable Clamp is machined from aluminum billet, and polished and plated for a lasting shine. The clamp is designed to grip the cable and the frame down tube, adding a custom look to the front of your cycle.

**91147-02** **\$39.95**

Fits models with 1-1/4" diameter front frame down tube (except Touring, '04-later XL, XR and '06-later Dyna models).

**91252-03** **\$39.95**

Fits models with 1-1/8" diameter front frame down tube ('84-'08 Touring models and '84-'99 Softail models).

**38804-07** **\$39.95**

Fits models with 1-1/2" diameter front frame down tube. Fits '06-later Dyna models. Stock on FXDSE and FXDFSE/2 models.

**91249-04** **\$39.95**

Fits '04-later XL, and '09-later Touring models with 1-3/8" diameter front frame down tube.

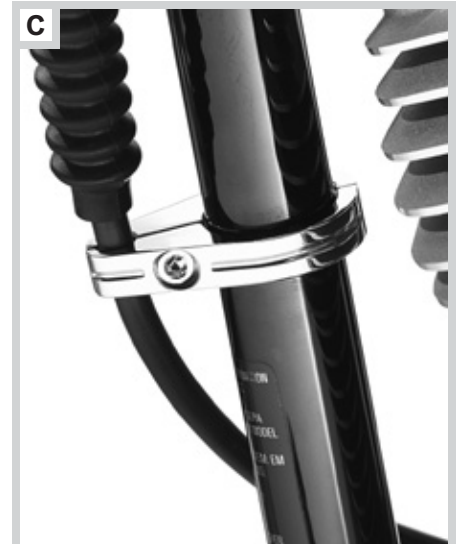

B. CHROME CLUTCH CABLE CLIP

C. CHROME BILLET CLUTCH CABLE CLAMP

### D. CHROME THROTTLE CABLE CLIP

Tie up the loose ends to complete your custom ride. When matched to Original Equipment black cables or available braided cables, these chrome-plated clips link the throttle and idle cables with brilliant chrome.

**91274-04** **\$29.95**

Fits '84-later models (except '08-later Touring).



D. CHROME THROTTLE CABLE CLIP

Notice: The prices appearing in this catalog are the manufacturer's suggested retail prices. Actual retail prices may vary.



# CONTROLS 607

Control Cables



**E. DIAMONDBACK BRAIDED CONTROL CABLES**

## CUSTOM BRAIDED CONTROL CABLES

Dress your bike for maximum custom impact. Harley-Davidson offers a choice of three braided cable finishes to match your customizing style. All cables include a clear anti-yellowing outer jacket, providing superior scuff protection and easy maintenance.

### E. DIAMONDBACK™ BRAIDED CABLES

The signature, Harley-Davidson exclusive, Diamondback braid provides a splash of chrome to your custom bike. The brilliant metallic finish blends perfectly with mirrored-chrome handlebars and controls, or provides a stark contrast to “blacked out” options. Diamondback cables feature highly polished chrome fittings and a micro-fine wire braiding that perfectly match the weave pattern of Diamondback Braided Brake Lines. Available in stock length and alternate (plus) lengths for custom applications.

### F. DIAMOND-BLACK BRAIDED CABLES

Introducing new Diamond-Black Braided Control Cables. Unlike others, Diamond-Black braided cables utilize a black braided wire providing a deeper, truer, black finish, while still allowing you to see the premium braided appearance from a distance. Fittings are matched in black chrome to give you the very best sinister look for your ride. Available in select stock length and custom length applications.



**F. DIAMOND-BLACK BRAIDED CONTROL CABLES**

### G. STAINLESS STEEL BRAIDED CABLES

Get the traditional custom look of stainless steel, by upgrading your Original Equipment black cables to braided stainless steel. Smooth, consistent stainless steel braiding and polished fittings at the handlebar provide for a fit and finish second to none. Available in select stock length and custom length applications.

#### TO SELECT THE CORRECT CABLE KIT:

For Original Equipment Applications (stock handlebars and risers): Locate the model and year of vehicle on pages 610-611. Applicable stock length part numbers are listed for each available finish.

For Custom Applications (custom handlebars and/or risers), available Diamondback alternate length cables are listed in the corresponding platform tables on pages 608-609. If you require assistance in determining the appropriate alternate length for your application, ask your Harley-Davidson® Dealer.

#### Need Help?

Visit your local Harley-Davidson Dealer. They have the tools and expertise to select the correct cables and brake lines for your custom application. Your dealer can measure and test-fit cables and lines to determine the proper length and fittings to ensure smooth operation and interference-free routing.



**G. STAINLESS STEEL BRAIDED CONTROL CABLES**



Notice: The prices appearing in this catalog are the manufacturer's suggested retail prices. Actual retail prices may vary.

# 608 CONTROLS

## Control Cables



### CLUTCH CABLES – STAINLESS

Platform	Adjuster Position "B"	Total Length "C"	Stainless Steel Kit	Price		
SPORTSTER	23.52"	52.75"	38629-02	\$79.95	—	—
	23.52"	54.75"	38727-04	\$79.95	—	—
	23.52"	57.75"	38732-04	\$79.95	—	—
	23.52"	60.75"	38734-04	\$79.95	—	—
	26.0"	57.25"	38750-05	\$79.95	—	—
SOFTAIL DYNA	32.95"	57.69"	56411-03	\$79.95	—	—
	32.95"	62.69"	56414-03	\$79.95	—	—
	32.95"	64.69"	38674-03	\$79.95	—	—
	32.95"	68.69"	56590-02	\$79.95	—	—
TOURING	25.4"	62.69"	38660-03	\$79.95	—	—

### CLUTCH CABLES – DIAMONDBACK & DIAMOND-BLACK

Platform	Adjuster Position "B"	Total Length "C"	Diamondback™ Kit	Price	Diamond-Black Kit	Price
SPORTSTER	23.52"	54.75"	38737-09	\$99.95	—	—
	26.0"	57.25"	38745-09	\$99.95	38939-09A	\$99.95
	26.0"	61.75"	—	—	38911-09A	\$99.95
SOFTAIL DYNA	31.5"	57.69"	38847-09	\$99.95	38874-10	\$99.95
	31.5"	58.69"	38848-09	\$99.95	38941-09A	\$99.95
	31.5"	60.69"	38849-09	\$99.95	38940-09A	\$99.95
	31.5"	62.69"	38850-09	\$99.95	38877-09A	\$99.95
	31.5"	64.69"	38851-09	\$99.95	38818-10	\$99.95
	31.5"	66.69"	38852-09	\$99.95	38875-09A	\$99.95
	31.5"	68.69"	38854-09	\$99.95	38916-09A	\$99.95
	31.5"	70.69"	38856-09	\$99.95	—	—
	31.5"	72.69"	38857-09	\$99.95	—	—
	31.5"	74.69"	38858-09	\$99.95	—	—
	31.5"	76.69"	38859-09	\$99.95	—	—
	31.5"	78.69"	38860-09	\$99.95	—	—
	TOURING	25.4"	62.69"	38921-09	\$99.95	38967-10
25.4"		64.69"	38922-09	\$99.95	—	—
25.4"		66.69"	38923-09	\$99.95	—	—
25.4"		68.69"	38924-09	\$99.95	—	—
25.4"		70.69"	38925-09	\$99.95	—	—
25.4"		72.69"	38926-09	\$99.95	—	—

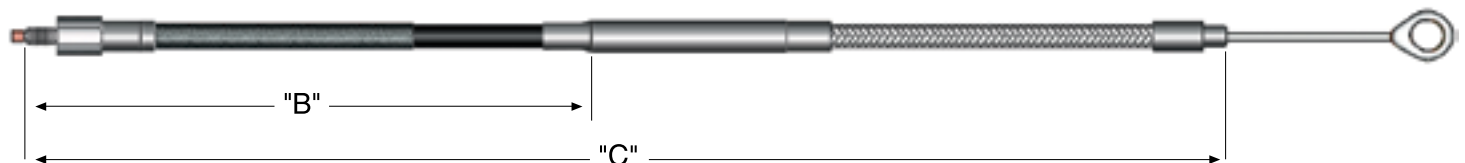

Notice: The prices appearing in this catalog are the manufacturer's suggested retail prices. Actual retail prices may vary.

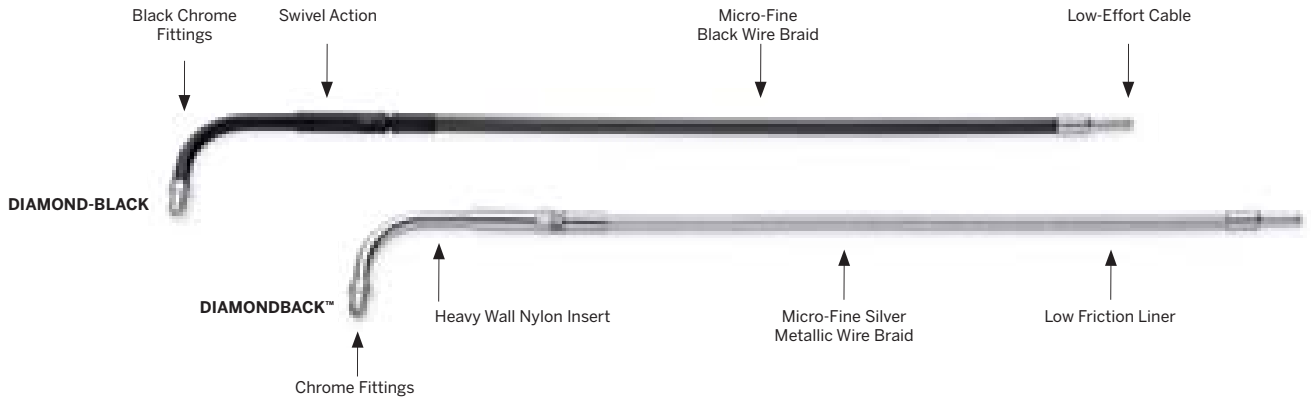

## THROTTLE / IDLE CABLES

Platform	Angle	Length	Stainless Steel Kit	Price	Diamondback™ Kit	Price	Diamond-Black Kit	Price
VRSC	70°	29.5"	56595-03A	\$129.95	—	—	—	—
SPORTSTER	45°	28.5"	56564-02	\$129.95	56715-06	\$139.95	—	—
	45°	30.5"	—	—	56726-07	\$139.95	38945-09	\$139.95
	45°	31.5"	56340-04	\$129.95	—	—	—	—
	45°	32.5"	56360-09	\$129.95	38906-07	\$139.95	38913-09	\$139.95
	45°	34.5"	56723-04	\$118.95	—	—	—	—
SOFTAIL DYNA	90°	26.5"	56345-03A	\$129.95	56808-05A	\$139.95	38947-09	\$139.95
	90°	28.5"	—	—	38781-06	\$139.95	38946-09	\$139.95
	90°	30.5"	56344-03A	\$129.95	56807-05A	\$139.95	38954-09	\$149.95
	90°	32.5"	56579-02A	\$129.95	56805-05A	\$139.95	38918-09	\$139.95
	90°	34.5"	56350-03A	\$129.95	55700-07	\$139.95	38957-09	\$149.95
	90°	36.5"	—	—	55703-07	\$139.95	—	—
	90°	38.5"	—	—	55706-07	\$139.95	—	—
	90°	40.5"	—	—	55709-07	\$149.95	—	—
	90°	42.5"	—	—	55712-07	\$149.95	—	—
	70°	32.5"	56720-03	\$129.95	—	—	—	—
	TOURING*	90°	39.5"	56616-03	\$139.95	56809-05	\$149.95	55723-10
90°		41.0"	56719-03	\$139.95	56810-05	\$149.95	—	—
90°		43.5"	—	—	55749-07	\$149.95	—	—
90°		45.5"	—	—	55750-07	\$149.95	—	—
90°		47.5"	—	—	55751-07	\$149.95	—	—
90°		49.5"	—	—	55752-07	\$149.95	—	—
70°		39.0"	56775-04	\$139.95	38778-05	\$149.95	—	—
70°		41.0"	56457-00A	\$129.95	55733-07	\$149.95	—	—
70°		43.0"	—	—	55734-07	\$149.95	—	—
70°		45.0"	—	—	55735-07	\$149.95	—	—
70°		47.0"	—	—	55736-07	\$149.95	—	—
70°		49.0"	—	—	55737-07	\$149.95	—	—

\*'08-later Touring models do not use Throttle/Idle cables.

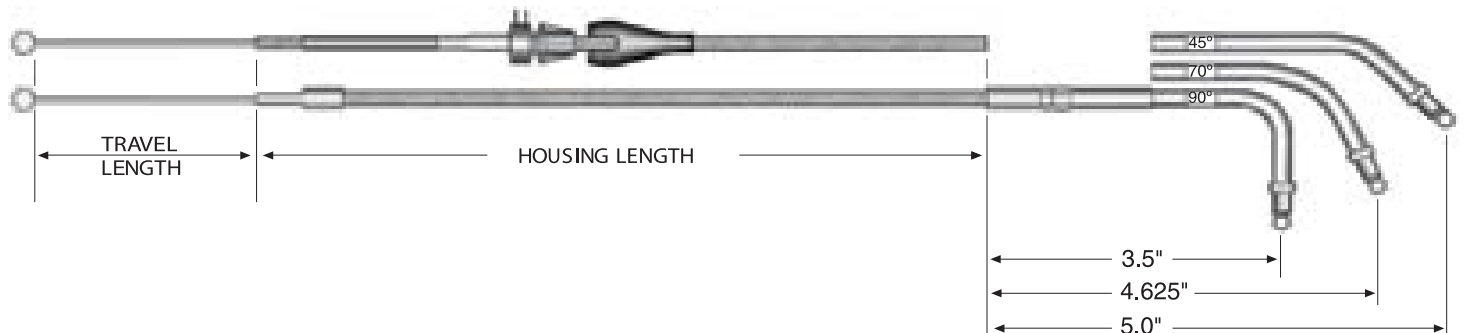

Notice: The prices appearing in this catalog are the manufacturer's suggested retail prices. Actual retail prices may vary.

# 610 CONTROLS

Control Cables

## ORIGINAL EQUIPMENT APPLICATIONS

VRSC	From – To	CLUTCH CABLES				THROTTLE/IDLE CABLES			
		Original Equipment (Black)	Stainless Steel	Diamondback™	Diamond-Black	Original Equipment (Black)	Stainless Steel	Diamondback™	Diamond-Black
VRSCA	2002 – 2006	—	—	—	—	56388-01	56595-03A	—	—
VRSCAW	2007 – 2010	—	—	—	—	56388-01	56595-03A	—	—
VRSCB	2004 – 2005	—	—	—	—	56545-04	56611-04	—	—
VRSCD	2006 – 2008	—	—	—	—	56545-04	56611-04	—	—
VRSCR	2005 – 2007	—	—	—	—	56545-04	56611-04	—	—
VRSCX	2007	—	—	—	—	56986-07	—	—	—
VRSCF	2009 – 2010	—	—	—	—	56388-01	56595-03A	—	—
<b>SPORTSTER</b>									
XL1200	1996 – 1999	38620-96	—	—	—	56307-96	—	—	—
	2000	38663-00	—	—	—	56307-96	—	—	—
	2001 – 2003	38662-00	—	—	—	56307-96	—	—	—
XL1200C	1996 – 1998	38619-86A	38629-02	—	—	56381-96	—	—	—
	1999	38619-86A	38629-02	—	—	56398-96	56564-02	56715-06	—
	2000	38662-00	38629-02	—	—	56398-96	56564-02	56715-06	—
	2001 – 2003	38663-00	38727-04	—	—	56398-96	56564-02	56715-06	—
	2004 – 2006	38699-04C	38727-04	38737-09	—	56398-96	56564-02	56715-06	—
XL1200L	2007 – 2010	38699-04C	—	38737-09	—	56883-07	56360-09	56726-07	38945-09
	2006	38702-05C	38750-05	38745-09	38939-09A	56398-96	56564-02	56715-06	—
	2007 – 2010	38702-05C	38750-05	38745-09	38939-09A	56883-07	56360-09	56726-07	38945-09
XL1200N	2007 – 2010	—	—	38745-09	38939-09A	—	—	56726-07	38945-09
XL1200R	2004 – 2006	38699-04C	38727-04	38737-09	—	56398-96	56564-02	56715-06	—
	2007 – 2010	38699-04C	38727-04	38737-09	—	56883-07	56360-09	56726-07	38945-09
XL1200S	1996 – 2003	—	38629-02	—	—	56398-96	56564-02	56715-06	—
XL50	2007	38699-04C	38727-04	38737-09	—	56883-07	56360-09	56726-07	38945-09
XL883	1996 – 1999	38619-86A	—	—	—	56398-96	56564-02	56715-06	—
	2000	38662-00	—	—	—	56398-96	56564-02	56715-06	—
	2001 – 2003	38663-00	—	—	—	56398-96	56564-02	56715-06	—
	2004 – 2006	38699-04C	—	38737-09	—	56398-96	56564-02	56715-06	—
	2007 – 2009	38699-04C	—	38737-09	—	56883-07	56360-09	56726-07	38945-09
XL883C	1996 – 1998	38620-96	38629-02	—	—	—	—	—	—
	1999	38620-96	38629-02	—	—	56398-96	56564-02	56715-06	—
	2000 – 2003	38662-00	38727-04	—	—	56398-96	56564-02	56715-06	—
	2004 – 2006	38699-04C	38727-04	38737-09	—	56398-96	56564-02	56715-06	—
	2007 – 2010	38699-04C	—	38737-09	—	56883-07	56360-09	56726-07	38945-09
XL883L	2005 – 2006	38702-05C	38750-05	38745-09	38939-09A	56398-96	56564-02	56715-06	—
	2007 – 2010	38702-05C	38750-05	38745-09	38939-09A	56883-07	56360-09	56726-07	38945-09
XL883N	2009 – 2010	—	—	38745-09	38939-09A	—	—	56726-07	38945-09
XL883R	2002 – 2003	38663-00	38629-02	—	—	56307-96	—	—	—
	2005	38699-04C	38727-04	38737-09	—	—	—	—	—
	2006	38699-04C	38727-04	38737-09	—	56398-96	56564-02	56715-06	—
	2007	—	—	38737-09	—	56883-07	56360-09	56726-07	38945-09
XLH883HUG	1996 – 1999	38620-96	—	—	—	56307-96	—	—	—
	2000	38663-00	—	—	—	56307-96	—	—	—
	2001 – 2003	38662-00	—	—	—	56307-96	—	—	—
<b>DYNA</b>									
FXD	1996 – 1999	38602-92A	38674-03	38854-09	38916-09A	56329-96A	56579-02A	56805-05A	38918-09
	2000 – 2005	38666-00	56590-02	38851-09	38818-10	56329-96A	56579-02A	56805-05A	38918-09
	2006 – 2010	38787-06C	—	38851-09	38818-10	56632-06	—	38781-06	38946-09
FXD35	2006	38788-06C	—	38852-09	38875-09A	56412-06	56344-03A	56807-05A	38954-09
	2006 – 2010	—	—	38854-09	38916-09A	56329-96A	—	56805-05A	38918-09
FXDC	2005	38666-00	38674-03	38851-09	38818-10	56329-96A	56579-02A	56805-05A	38918-09
	2006	38787-06C	—	38851-09	38818-10	56632-06	—	38781-06	38946-09
	2007 – 2010	38787-06C	—	38852-09	38875-09A	56412-06	56344-03A	56807-05A	38954-09
FXDF	2008 – 2010	—	—	38849-09	38940-09A	—	—	38781-06	38946-09
	2008 – 2010	—	—	38849-09	38940-09A	—	—	38781-06	38946-09
FXDL	1996 – 1999	38602-92A	38674-03	38854-09	38916-09A	56329-96A	56579-02A	56805-05A	38918-09
	2000	38661-00	56590-02	38854-09	38916-09A	56329-96A	56579-02A	56805-05A	38918-09
	2001 – 2005	38666-00	56590-02	38851-09	38818-10	56329-96A	56579-02A	56805-05A	38918-09
	2006 – 2010	38788-06C	—	38852-09	38875-09A	56412-06	56344-03A	56807-05A	38954-09
FXDS-CONV	1996 – 1999	38602-92A	56590-02	38854-09	38916-09A	56329-96A	56579-02A	56805-05A	38918-09
	2000	38661-00	56590-02	38854-09	38916-09A	56329-96A	56579-02A	56805-05A	38918-09
FXDWG	1996 – 1999	38602-92A	56590-02	38854-09	38916-09A	56329-96A	56579-02A	56805-05A	38918-09
	2000 – 2005	38661-00	56590-02	38854-09	38916-09A	56329-96A	56579-02A	56805-05A	38918-09
	2006 – 2008	38789-06C	—	38854-09	38916-09A	56329-96A	56579-02A	56805-05A	38918-09
	2010	38787-06C	—	38852-09	38875-09A	56412-06	56344-03A	56807-05A	38954-09
FXDX	1999	—	38674-03	56843-05	—	—	—	56805-05A	38918-09
	2000 – 2005	—	38674-03	38851-09	38818-10	—	—	56805-05A	38918-09
FXDXT	2001 – 2003	38666-00	38674-03	38851-09	38818-10	56329-96A	56579-02A	56805-05A	38918-09



CLUTCH CABLES

THROTTLE/IDLE CABLES

SOFTAIL	From – To	CLUTCH CABLES				THROTTLE/IDLE CABLES				
		Original Equipment (Black)	Stainless Steel	Diamondback™	Diamond-Black	Original Equipment (Black)	Stainless Steel	Diamondback™	Diamond-Black	
FLST	2006	38666-00	38674-03	38851-09	38818-10	56338-01	56344-03A	56807-05A	38954-09	
	2009 – 2010	—	38674-03	—	—	—	—	—	—	
FLSTC	1996 – 1999	38607-87A	38674-03	38850-09	38877-09A	56338-96	56344-03A	56807-05A	38954-09	
	2000 – 2001	38666-00	38674-03	38851-09	38818-10	56338-96	56344-03A	56807-05A	38954-09	
	2002 – 2006	38666-00	38674-03	38851-09	38818-10	56338-01	56344-03A	56807-05A	38954-09	
	2007 – 2010	38666-07B	56414-03	38851-09	38818-10	56338-01	56344-03A	56807-05A	38954-09	
FLSTF	1996 – 1999	38607-87A	38674-03	38850-09	38877-09A	56338-96	56344-03A	56807-05A	38954-09	
	2000 – 2001	38664-00	38674-03	38851-09	38818-10	56338-96	56344-03A	56807-05A	38954-09	
	2002 – 2006	38666-00	56414-03	38851-09	38818-10	56338-01	56344-03A	56807-05A	38954-09	
	2007 – 2010	38666-07B	38674-03	38851-09	38818-10	56338-01	56344-03A	56807-05A	38954-09	
FLSTFB	2010	38664-07B	38674-03	38851-09	38818-10	56338-01	56344-03A	56807-05A	38954-09	
FLSTN	1996	38607-87A	—	38850-09	38877-09A	56338-96	56344-03A	56807-05A	38954-09	
	2005 – 2006	38664-00	—	38850-09	38877-09A	56338-01	56344-03A	56807-05A	38954-09	
	2007	38664-07B	—	38850-09	38877-09A	56338-01	56344-03A	56807-05A	38954-09	
	2008 – 2010	38664-07B	—	38850-09	38877-09A	56338-01	56344-03A	—	—	
FLSTS	1997 – 1999	38607-87A	38674-03	38850-09	38877-09A	56338-96	56344-03A	56807-05A	38954-09	
	2000 – 2001	38666-00	38674-03	38851-09	38818-10	56338-96	56344-03A	56807-05A	38954-09	
	2002 – 2003	38666-00	56414-03	38851-09	38818-10	56338-01	56344-03A	56807-05A	38954-09	
	2008 – 2010	—	—	38852-09	38875-09A	—	—	55700-07	38957-09	
FLSTSB	2005 – 2007	—	38674-03	38851-09	38818-10	56338-01	56344-03A	56807-05A	38954-09	
FLSTSC	2008 – 2009	—	—	38851-09	38818-10	—	—	56807-05A	38954-09	
FXCW	2008 – 2010	—	—	38851-09	38818-10	—	—	56807-05A	38954-09	
FXST	1999	38607-87A	38674-03	38850-09	38877-09A	56338-96	56344-03A	56807-05A	38954-09	
	2000 – 2001	38666-00	38674-03	38851-09	38818-10	56338-96	56344-03A	56807-05A	38954-09	
	2002 – 2006	38666-00	38674-03	38851-09	38818-10	56338-01	56344-03A	56807-05A	38954-09	
	2007 – 2010	38666-07B	56414-03	38851-09	38818-10	56338-01	56344-03A	56807-05A	38954-09	
	2000 – 2006	38665-00	56411-03	—	—	56431-98	56345-03A	56808-05A	38947-09	
FXSTB	2007 – 2009	38665-07B	—	38848-09	38941-09A	56431-98	56345-03A	56808-05A	38947-09	
	1996 – 1999	38607-87A	56414-03	38850-09	38877-09A	56338-96	56344-03A	56807-05A	38954-09	
	2007 – 2010	38666-07B	—	38851-09	38818-10	56933-07A	56579-02A	56805-05A	38918-09	
FXSTC	2000 – 2001	38664-00	56414-03	38850-09	38877-09A	56338-96	56344-03A	56807-05A	38954-09	
	2002 – 2006	38664-00	56414-03	38850-09	38877-09A	56338-01	56344-03A	56807-05A	38954-09	
	2007	38664-07B	56414-03	38850-09	38877-09A	56338-01	56344-03A	56807-05A	38954-09	
	1996 – 1998	38607-87A	38674-03	38850-09	38877-09A	—	56720-03	—	—	
FXSTD	1999	38607-87A	38674-03	38850-09	38877-09A	56322-96	56720-03	—	—	
	2000 – 2003	38666-00	38674-03	38851-09	38818-10	56322-96	56720-03	—	—	
	2004 – 2006	38666-00	56414-03	38851-09	38818-10	56322-96	56344-03A	—	—	
	1996 – 1997	38617-95	—	—	—	56338-96	56344-03A	56807-05A	38954-09	
TOURING	FLHR	1996 – 1999	38601-89	38660-03	38921-09	38967-10	—	—	—	—
		2000 – 2001	38667-00	38660-03	38921-09	38967-10	—	—	—	—
		2002 – 2006	38667-00	38660-03	38921-09	38967-10	—	56616-03	56809-05	55723-10
		2007 – 2010	38667-07	38660-03	38921-09	38967-10	—	56616-03	56809-05	55723-10
	FLHRC	1996 – 1997	38667-00	—	38921-09	38967-10	—	—	—	—
		1998 – 1999	38601-89	—	38921-09	38967-10	—	—	—	—
		2000 – 2001	38667-00	—	38921-09	38967-10	—	—	—	—
		2002 – 2006	38667-07	—	38921-09	38967-10	—	—	56809-05	55723-10
		2007 – 2010	—	—	38921-09	38967-10	—	—	56809-05	55723-10
	FLHRS	1996 – 2003	38667-00	38660-03	38921-09	38967-10	—	—	—	—
		2004 – 2006	38667-07	38660-03	38921-09	38967-10	—	56719-03	56810-05	—
		2007 – 2008	—	—	38921-09	38967-10	—	56719-03	56810-05	—
FLHT	1996 – 1999	38601-89	38660-03	38921-09	38967-10	56327-96	—	—	—	
	2000 – 2001	38667-00	38660-03	38921-09	38967-10	56327-96	—	—	—	
	2002 – 2005	38667-00	38660-03	38921-09	38967-10	56524-02	56775-04	38778-05	—	
	2006	38667-00	38660-03	38921-09	38967-10	56366-02	56775-04	38778-05	—	
	2007 – 2010	38667-07	38660-03	38921-09	38967-10	56366-02	56775-04	38778-05	—	
FLHTC	1996 – 1999	38601-89	38660-03	38921-09	38967-10	—	—	—	—	
	2000 – 2001	38667-00	38660-03	38921-09	38967-10	—	—	—	—	
	2002 – 2006	38667-00	38660-03	38921-09	38967-10	—	56775-04	38778-05	—	
	2007 – 2010	38667-07	38660-03	38921-09	38967-10	—	56775-04	38778-05	—	
FLHTCU	1996 – 2001	—	—	38921-09	38967-10	—	—	—	—	
	2002 – 2010	—	—	38921-09	38967-10	—	—	38778-05	—	
FLHX	2006	38667-07	38660-03	38921-09	38967-10	56366-02	56775-04	38778-05	—	
	2007 – 2010	—	—	38921-09	38967-10	56366-02	56775-04	38778-05	—	
FLTCU	1996	38601-89	38660-03	38921-09	38967-10	56357-96	56457-00A	—	—	
FLTR	1996 – 1997	38667-00	38660-03	38921-09	38967-10	—	56457-00A	—	—	
	1998 – 1999	38667-07	38660-03	38921-09	38967-10	—	56457-00A	—	—	
	2000 – 2001	38667-00	38660-03	38921-09	38967-10	—	—	—	—	
	2002 – 2006	—	38660-03	38921-09	38967-10	—	56775-04	38778-05	—	
	2007 – 2009	—	—	38921-09	38967-10	—	56775-04	38778-05	—	
FLTRX	2010	—	—	38921-09	38967-10	—	56775-04	38778-05	—	

CONTROLS

# 612 CONTROLS

## Brake Lines

### CUSTOM BRAIDED BRAKE LINE KITS

Dress your bike for maximum custom impact and performance. Harley-Davidson offers a choice of three braided brake line finishes, and two different design configurations, to match your customizing needs. All brake lines meet or exceed all DOT requirements.

#### A. DIAMONDBACK™ BRAIDED BRAKE LINES

The signature Harley-Davidson exclusive Diamondback braid provides a splash of chrome to your custom bike. Diamondback Brake Lines feature highly polished chrome fittings and a micro-fine wire braiding that perfectly match the weave pattern on Diamondback Braided Control Cables. Available in "Modular" and "1-Piece" brake line configurations.

#### B. DIAMOND-BLACK BRAIDED BRAKE LINES

Introducing new Diamond-Black Braided Brake Lines. Unlike others, Diamond-Black braided brake lines utilize a black braided wire providing a deeper, truer, black finish, while still allowing you to see the premium braided appearance from a distance. Available in "Modular" and "1-Piece" brake line configurations.

#### C. STAINLESS STEEL BRAIDED BRAKE LINES

Get the traditional custom look of stainless steel, by upgrading your Original Equipment black brake lines to braided stainless steel. Smooth, consistent stainless steel braiding and polished chrome fittings provide for a fit and finish second to none. Available in "1-Piece" brake line configurations.

### BRAKE LINE CONFIGURATIONS

Braided brake lines are available in two designs: 1-Piece and Modular lines.

#### "1-Piece" Brakes

Feature continuous brake lines that are specific to a stock length, and/or to a specific accessory handlebar application. "1-Piece" Brake Lines come in both single disc and dual disc configurations. "1-Piece" Brake Lines have pre-assembled/ crimped banjo fittings for easy installation and to ensure the correct fit for the specific application.

#### Modular Brake Lines

Feature a 2-piece design that provides maximum versatility for both stock and alternate (plus) length brake line applications. Modular Brake Lines come in single and dual disc configurations and require a separate purchase of both a lower and an upper brake line for installation. The common lower line is shared with specific models, while the variable length upper lines work with models depending on single disc (Dyna/Softail, except FXDF) or dual disc (Touring/FXDF) application. Upper brake lines come completely assembled in lengths up to +10" over the stock configuration and can be ordered with 0°, 35°, and 90° banjo angles to accommodate almost any handlebar configuration. A single JIC connection at the lower triple tree fastens the lines together and automatically orients the banjo fittings to ensure proper installation.



A. DIAMONDBACK BRAIDED BRAKE LINE KIT



B. DIAMOND-BLACK BRAIDED BRAKE LINE KIT



C. STAINLESS STEEL BRAIDED BRAKE LINE KIT

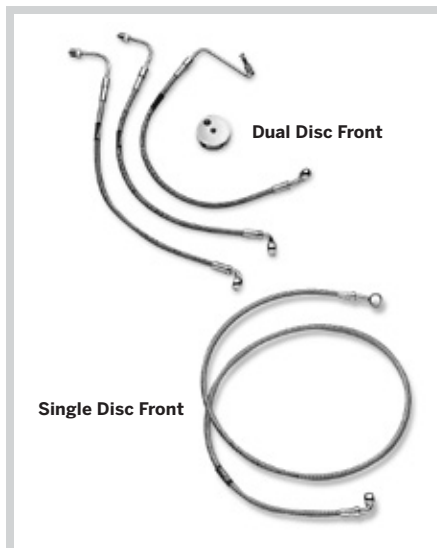

"1-PIECE" BRAKE LINES  
(STAINLESS SHOWN)



MODULAR BRAKE LINE SINGLE DISC FRONT  
(DIAMONDBACK SHOWN)

Notice: The prices appearing in this catalog are the manufacturer's suggested retail prices. Actual retail prices may vary.

## 1-PIECE FRONT BRAKE LINES

SPORTSTER	From - To	Oem Stock (Black)	Stainless Steel	Price	Diamondback™	Price	Diamond-Black	Price
XL1200	1988 - 2003	45121-96A	45202-97B	\$61.95	—	—	—	—
XL1200C	1999 - 2003	45121-96A	45201-97B	\$69.95	—	—	—	—
	2004 - 2010	45449-04B	45489-04	\$69.95	46930-06	\$79.95	46779-09	\$84.95
XL1200L	2006 - 2010	46411-05D	—	—	46936-06	\$79.95	—	—
XL1200N	2007 - 2010	45449-04B	45489-04	\$69.95	46930-06	\$79.95	46779-09	\$84.95
XL1200R	2004 - 2007	45319-04C	45409-04	\$139.95	—	—	—	—
XL50	2007	45449-04B	45489-04	\$69.95	46930-06	\$79.95	46779-09	\$84.95
XL883	1992 - 2003	45121-96A	45201-97B	\$69.95	—	—	—	—
	2004 - 2009	46400-04B	45496-04	\$69.95	46934-06	\$79.95	—	—
XL883C	1999 - 2003	45121-96A	45201-97B	\$69.95	—	—	—	—
	2004 - 2010	45449-04B	45489-04	\$69.95	46930-06	\$79.95	46779-09	\$84.95
XL883L	2005 - 2010	46411-05D	—	—	46936-06	\$79.95	—	—
XL883N	2009 - 2010	45449-04B	45489-04	\$69.95	46930-06	\$79.95	46779-09	\$84.95
XL883R	2002 - 2003	45194-99A	45287-99C	\$139.95	—	—	—	—
	2005 - 2007	45319-04C	45409-04	\$139.95	—	—	—	—
XLH883HUG	1988 - 2003	45121-96A	45201-97B	\$69.95	—	—	—	—
XRI200	2008 - 2010	42942-08A	45851-08	\$129.95	—	—	—	—

DYNA								
FXD	1995 - 1999	45121-96A	45202-97B	\$61.95	—	—	—	—
	2000 - 2005	45291-00A	45202-00A	\$69.95	—	—	—	—
FXDB	2006 - 2010	—	—	—	—	—	46740-09	\$84.95
FXDC	2005	45291-00A	45202-00A	\$69.95	—	—	—	—
FXDF	2008 - 2010	—	—	—	—	—	46790-09	\$199.95
FXDL	2001 - 2005	44794-01	44793-01	\$69.95	—	—	—	—
FXDWG	1993 - 2005	45112-96A	45206-97B	\$69.95	—	—	—	—
	2010	—	—	—	—	—	—	—
FXDX	1999 - 2005	45194-99A	45287-99C	\$139.95	—	—	—	—
FXDXT	2001 - 2003	45194-99A	45287-99C	\$139.95	—	—	—	—

FXR								
FXR	1988 - 1994	45121-96A	45202-97B	\$61.95	—	—	—	—
FXRS	1988 - 1992	45121-96A	45202-97B	\$61.95	—	—	—	—

SOFTAIL								
FLST	2006	42317-06A	46011-01	\$69.95	—	—	—	—
FLSTC	1988 - 1999	42305-96	45210-97B	\$79.95	—	—	—	—
	2000 - 2010	42317-06A	46011-01	\$69.95	—	—	—	—
FLSTF	1990 - 1999	42303-96	45210-97B	\$79.95	—	—	—	—
	2000 - 2010	42317-06A	46011-01	\$69.95	—	—	—	—
FLSTFB	2010	42314-05A	44892-05	\$89.95	—	—	—	—
FLSTN	1993 - 1996	42303-96	45210-97B	\$79.95	—	—	—	—
	2005 - 2010	42314-05A	44892-05	\$89.95	—	—	—	—
FLSTS	1997 - 2003	45091-97	45209-97B	\$69.95	44901-05	\$79.95	—	—
FLSTSB	2008 - 2010	45139-08	—	—	—	—	48970-09	\$89.95
FLSTSC	2005 - 2007	45139-05B	44894-05	\$89.95	46942-06	\$79.95	48962-09	\$89.95
FXST	1999 - 2010	45199-99A	44813-00A	\$69.95	—	—	—	—
FXSTB	1999 - 2009	45250-98B	45264-98B	\$69.95	—	—	46791-09	\$84.95
FXSTC	1984 - 1999	45112-96A	45206-97B	\$69.95	—	—	—	—
FXSTD	2000 - 2007	45119-00B	44815-00A	\$69.95	—	—	—	—
FXSTS	1988 - 2003	45110-96	45208-97B	\$61.95	—	—	—	—
	2004 - 2006	45115-95B	45209-97B	\$69.95	44901-05	\$79.95	—	—
FXSTSB	1995 - 1997	45115-95B	45209-97B	\$69.95	44901-05	\$79.95	—	—

TOURING								
FLHR	1994 - 2007	43350-96C	45212-97B	\$139.95	44877-05	\$149.95	—	—
FLHRC	1998 - 2007	43350-96C	45212-97B	\$139.95	44877-05	\$149.95	—	—
FLHRS	2004 - 2007	43374-04A	45510-04	\$139.95	46695-06	\$149.95	—	—
FLHT	1996 - 2007	43349-96B	45441-03	\$139.95	46697-06	\$149.95	—	—
FLHTC	1996 - 2007	43349-96B	45441-03	\$139.95	46697-06	\$149.95	—	—
FLHTCU	1996 - 2007	43349-96B	45441-03	\$139.95	46697-06	\$149.95	—	—
FLHX	2006 - 2007	43349-96B	45441-03	\$139.95	46697-06	\$149.95	—	—
FLTR	1998 - 2007	43350-96C	45212-97B	\$139.95	44877-05	\$149.95	—	—

VRSC								
VRSCB	2004 - 2005	44463-04	44716-04	\$112.95	—	—	—	—

## REPLACEMENT REAR BRAKE LINES

SPORTSTER	From - To	Oem Stock (Black)	Stainless Steel	Price	Diamondback	Price
ALL XL	1988 - 2003	44438-87C	44800-00A	\$59.95	—	—
	2004 - 2010	44429-06B	45499-04	\$119.95	—	—
XRI200	2008 - 2010	42975-08A	45868-08A	\$99.95	—	—

DYNA						
ALL DYNA except FXDWG/2/3 & FXDSE	2000 - 2007	40956-00B	44801-00A	\$59.95	44889-05	\$69.95
	2008 - 2010	42142-08	—	—	45754-08	\$69.95

SOFTAIL						
FL SOFTAIL & FXSTD	2000 - 2006	45133-04B or	44803-00B	\$88.95	44881-05	\$99.95
FX SOFTAIL except FXSTD	2000 - 2005	45133-04A	44803-00B	\$88.95	44881-05	\$99.95
	2006	46649-06	46652-06	\$88.95	46650-06	\$99.95
All Softail	2008 - 2010	42261-08A	—	—	45755-08	\$99.95

NOTE: There are no rear break lines for 2007 Softail models.

# 614 CONTROLS

## Brake Lines

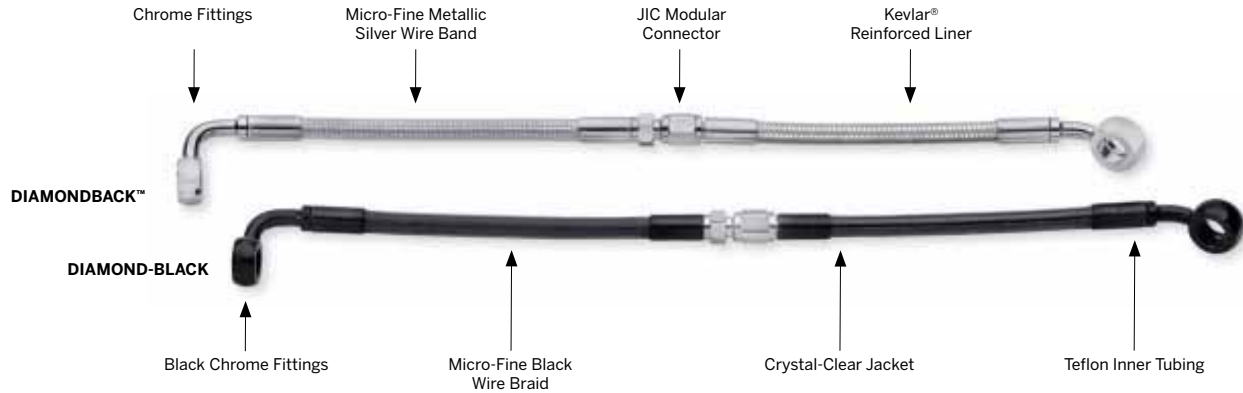

### FRONT MODULAR BRAKE LINES

DYNA	From – To	Diamondback™		Diamond-Black		Upper Line	
		Lower Line	Upper Line	Lower Line	Upper Line	Length	Banjo Angle
FXD	2006 – 2010	42110-07	42387-07	—	—	22"	0°
FXD35	2006	42110-07	44962-07	—	—	25"	0°
FXDB	2006 – 2010	42110-07	42752-07	—	—	28"	0°
FXDC	2006	42110-07	42387-07	—	—	22"	0°
	2007 – 2010	42110-07	44962-07	—	—	25"	0°
FXDF	2008 – 2010	42112-08A	44790-08	48928-10	48931-10	18"	90°
FXDL	2001 – 2005	42371-07	42766-07	48920-10	48936-10	22"	35°
	2006 – 2010	42110-07	44964-07	—	—	25"	35°
FXDWG	1999 – 2005	42366-07	42749-07	48924-10	—	26"	0°
	2006 – 2008	42108-07	42752-07	48926-10	—	28"	0°
	2010	42108-07	42903-07	48926-10	48922-10	24"	90°

### SOFTAIL

FLST	2006	42371-07	42770-07	48920-10	—	24"	35°
FLSTC	2000 – 2008	42371-07	42770-07	48920-10	—	24"	35°
	2009 – 2010	42371-07	42749-07	48920-10	—	26"	0°
FLSTF	2000 – 2010	42371-07	44964-07	48920-10	—	25"	35°
FLSTFB	2010	42371-07	42764-07	48920-10	48934-10	21"	35°
FLSTN	2005 – 2010	42371-07	42770-07	48920-10	—	24"	35°
FXCW	2008 – 2009	45770-08	42772-07	—	—	26"	35°
FXCWC	2008 – 2010	45770-08	42772-07	—	—	26"	35°
FXST	1999 – 2010	42366-07	42770-07	48924-10	—	24"	35°
FXSTB	1999 – 2009	42366-07	42379-07	48924-10	—	20"	0°
FXSTC	2007 – 2010	42366-07	42749-07	48924-10	—	26"	0°
FXSTD	2000 – 2007	42366-07	42770-07	48924-10	—	24"	35°

### TOURING (non-ABS)

FLHR	1996 – 2007	45818-07	42439-08	48938-10	—	22"	0°
	2008 – 2010	44907-08	42461-08	48942-10	—	23"	0°
FLHRC	1996 – 2007	45818-07	42439-08	48938-10	—	22"	0°
	2008 – 2010	44907-08	42461-08	48942-10	—	23"	0°
FLHRS	2004 – 2007	45818-07	42439-08	48938-10	—	22"	0°
FLHT	1996 – 2007	45820-07	44106-08	—	—	18"	35°
	2008 – 2010	44905-08	44106-08	—	—	18"	35°
FLHTC	1996 – 2007	45820-07	44106-08	—	—	18"	35°
	2008 – 2010	44905-08	44106-08	—	—	18"	35°
FLHTCU	1996 – 2007	45820-07	44106-08	—	—	18"	35°
	2008 – 2010	44905-08	44106-08	—	—	18"	35°
FLHX	2006 – 2007	45820-07	44106-08	—	—	18"	35°
	2008 – 2010	44905-08	44106-08	—	—	18"	35°
FLTR	1998 – 2007	45818-07	42439-08	48938-10	—	22"	0°
	2008 – 2010	44907-08	44213-08	48942-10	—	21"	35°
FLTRX	2010	44907-08	44213-08	48942-10	—	21"	35°

### TOURING (ABS equipped)

FLHR	2009 – 2010	41825-09	46711-09	48946-10	—	34"	35°
FLHRC	2009 – 2010	41825-09	46711-09	48946-10	—	34"	35°
FLHT	2009 – 2010	41825-09	40958-09	48946-10	—	32"	35°
FLHTC	2009 – 2010	41825-09	40958-09	48946-10	—	32"	35°
FLHTCU	2009 – 2010	41825-09	40958-09	48946-10	—	32"	35°
FLHX	2009 – 2010	41825-09	40958-09	48946-10	—	32"	35°
FLTR	2009	46049-09	46711-09	—	—	34"	35°
FLTRX	2010	46049-09	46711-09	—	—	34"	35°



**INSTRUCTIONS FOR FINDING STOCK AND ALTERNATE LENGTH MODULAR BRAKE LINES:**

1. Find your model and year on the chart below for the stock fitment.
2. The stock Diamondback Modular Front lower and upper brake lines are listed along with the length and banjo angle for reference.
3. Alternate lengths for Diamondback upper lines are listed on the next page according to 0°, 35°, and 90° banjo configurations. (If you require assistance determining the appropriate alternate length and banjo angle for your application, ask your Harley-Davidson Dealer.)

NOTE: Diamondback Modular Brake Lines require both upper and lower brake line kits for installation. Subsequent changes due to handlebar modifications may only require a new upper line.

For alternate length and banjo angle upper brake lines, see the chart on the next page. Proper routing may require a different banjo angle from that used for stock fitment.

**SOFTAIL & DYNA**

**Modular Upper & Lower Brake Lines for Multi-Length Program**

Upper Brake Line Kits/Brake Lines						
Diamondback		Diamond-Black		Length	Banjo Angle (0.445" Bore)	
Kit P/N	Price	Kit P/N	Price			
42373-07	\$59.95	—	—	18"	0°	
42377-07	\$59.95	—	—	19"		
42379-07	\$59.95	—	—	20"		
42385-07	\$59.95	—	—	21"		
42387-07	\$59.95	—	—	22"		
42395-07	\$59.95	—	—	23"		
42485-07	\$59.95	—	—	24"		
44962-07	\$59.95	—	—	25"		
42749-07	\$59.95	—	—	26"		
42752-07	\$64.95	—	—	28"		
42754-07	\$64.95	—	—	30"		
42756-07	\$64.95	—	—	32"		
44953-07	\$64.95	—	—	34"		
42758-07	\$59.95	—	—	18"		35°
42760-07	\$59.95	48932-10	\$59.95	19"		
42762-07	\$59.95	—	—	20"		
42764-07	\$59.95	48934-10	\$59.95	21"		
42766-07	\$59.95	48936-10	\$59.95	22"		
42768-07	\$59.95	—	—	23"		
42770-07	\$59.95	—	—	24"		
44964-07	\$59.95	—	—	25"		
42772-07	\$59.95	—	—	26"		
42774-07	\$64.95	—	—	28"		
42776-07	\$64.95	—	—	30"		
42778-07	\$64.95	—	—	32"		
44955-07	\$64.95	—	—	34"		
42780-07	\$59.95	—	—	18"	90°	
42782-07	\$59.95	—	—	19"		
42784-07	\$59.95	42340-10	\$59.95	20"		
42786-07	\$59.95	—	—	21"		
42788-07	\$59.95	—	—	22"		
42791-07	\$59.95	—	—	23"		
42903-07	\$59.95	48922-10	\$59.95	24"		
44966-07	\$59.95	—	—	25"		
42905-07	\$59.95	—	—	26"		
42907-07	\$64.95	—	—	28"		
42909-07	\$64.95	—	—	30"		
42911-07	\$64.95	—	—	32"		
44957-07	\$64.95	—	—	34"		

Lower Brake Line Kits/Brake Lines					
Diamondback		Diamond-Black		Length	Banjo Angle (0.385" Bore)
Kit P/N	Price	Kit P/N	Price		
42366-07	\$59.95	48924-10	\$59.95	22.75"	78°
FX Softail		FX Softail			
42371-07	\$59.95	48920-10	\$59.95	20.25"	
FL Softail		FL Softail			
42108-07	\$59.95	48926-10	\$59.95	24.00"	
FXDWG		FXDWG			
42110-07	\$59.95	—	—	21.50"	
FXD/B/C/L					
45770-08	\$59.95	—	—	23.25"	
FXCW/C					

**TOURING & DYNA FXDF (Dual Disk)**

**Modular Upper & Lower Brake Lines for Multi-Length Program**

Upper Brake Lines						
Diamondback		Diamond-Black		Length	Banjo Angle (10Mm Bore)	
Kit P/N	Price	Kit P/N	Price			
42393-08	\$59.95	—	—	18"	0°	
42396-08	\$59.95	—	—	19"		
42399-08	\$59.95	—	—	20"		
42428-08	\$59.95	—	—	21"		
42439-08	\$59.95	—	—	22"		
42461-08	\$59.95	—	—	23"		
42484-08	\$59.95	—	—	24"		
42527-08	\$64.95	—	—	26"		
42548-08	\$64.95	—	—	28"		
42599-08	\$64.95	—	—	30"		
44081-09	\$64.95	—	—	32"		
46336-09	\$64.95	—	—	34"		
46566-09	\$64.95	—	—	36"		
44106-08	\$59.95	—	—	18"		35°
44138-08	\$59.95	—	—	19"		
44206-08	\$59.95	48940-10	\$59.95	20"		
44213-08	\$59.95	—	—	21"		
44250-08	\$59.95	—	—	22"		
44259-08	\$59.95	—	—	23"		
44306-08	\$59.95	—	—	24"		
44340-08	\$64.95	—	—	26"		
44355-08	\$64.95	—	—	28"		
44461-08	\$64.95	—	—	30"		
40958-09	\$64.95	—	—	32"		
46711-09	\$64.95	—	—	34"		
46727-09	\$64.95	—	—	36"		
44790-08	\$59.95	48931-10	\$59.95	18"	90°	
45007-08	\$59.95	48929-10	\$59.95	19"		
45082-08	\$59.95	—	—	20"		
45094-08	\$59.95	48944-10	\$59.95	21"		
45131-08	\$59.95	—	—	22"		
45134-08	\$59.95	—	—	23"		
45150-08	\$59.95	—	—	24"		
45223-08	\$64.95	—	—	26"		
45251-08	\$64.95	—	—	28"		
45260-08	\$64.95	—	—	30"		
44162-09	\$64.95	48995-10	\$64.95	32"		
46743-09	\$64.95	—	—	34"		
46747-09	\$64.95	—	—	36"		

Lower Brake Lines					
Diamondback		Diamond-Black		Length	Banjo Angle
Kit P/N	Price	Kit P/N	Price		
44907-08	\$129.95	48942-10	\$129.95	15.25"	90°
FLHR/C, FLTR/X					
44905-08	\$129.95	—	—	15.25"	90°
FLHT/C/CU/X					
42112-08A	\$129.95	48928-10	\$129.95	18.54"	78°
FXDF		FXDF			
45818-07	\$129.95	48938-10	\$129.95	16.10"	78°
FLHR/FLTR					
45820-07	\$129.95	—	—	16.10"	78°
FLHT/FLHX					
41825-09	\$249.95	48946-10	\$249.95	14.84"	90°
46049-09	\$249.95	—	—	13.93"	90°

CONTROLS

Notice: The prices appearing in this catalog are the manufacturer's suggested retail prices. Actual retail prices may vary.



# GPS & AUDIO

*Enhance your riding experience with the latest "Infotainment" technology. Road Tech™ GPS and Boom! Audio™ music and communications options put you in touch with your passenger and with the world around you.*

## CONCERT HALL SOUND



**BOOM! BAGGER™ PREMIUM SPEAKERS**  
*These waterproof 5¼" two-way speakers provide wide-range low distortion sound that's 25% louder than Original Equipment speakers at the same volume setting.*

Comparison of Useable Speaker Frequency Response\*

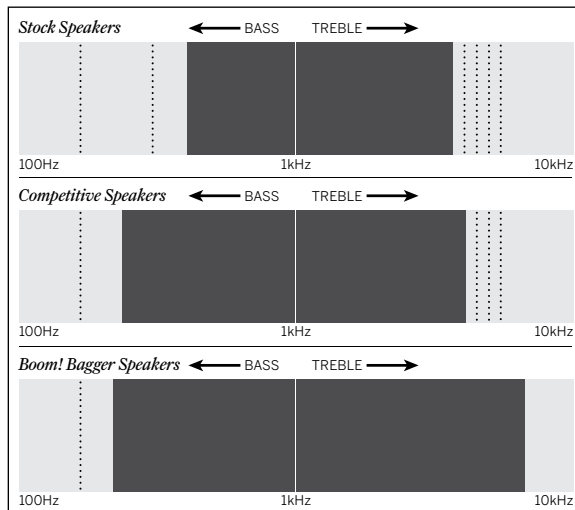

\*based on +/- 6dB from nominal response



### BOOM! AUDIO™ PREMIUM STEREO HEADSET

*Access your music, navigation and voice communications while wearing a ¾ or full-face helmet. This headset is comfortable, lightweight and easy to install with an adjustable microphone and quick-disconnect plug.*

## ROAD TECH™ ZŪMO® 660 GPS NAVIGATOR

Take a ride on a new route and explore the open road with the Road Tech™ zūmo® 660. This motorcycle-friendly navigator was built to lead you on all of your two- (or three-) wheeled adventures. Whether you're on a weekday ride just across town or a weeklong trip to an annual rally with friends, the zūmo 660 is ready to show you the way. Just because your bike's parked doesn't mean your day is done. The zūmo 660 also pulls double duty as an in-car navigator when you're on four wheels instead of two. In addition, the zūmo 660 also includes a carrying case, vehicle mount and power cable.



92115-09 \$749.95

Fits '96-later VRSC™ (except VRSCR), XL, XR, Dyna®, Softail® and Touring models with separate purchase of Handlebar Mount P/N 92378-09 or Fairing Mount P/N 92238-09. Also fits most automobile windshields or dash.

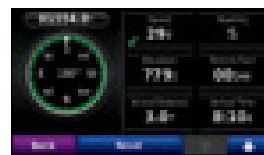
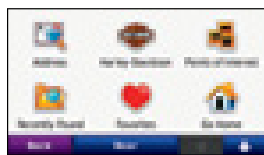

### WIDE SCREEN

Touch-screen access to programming, 3-D and overhead maps and digital dashboard.

## MOTORCYCLE-FRIENDLY DESIGN

- Glove-friendly touchscreen with easy scroll design
- Built-in Harley® Dealer Database
- Rugged vibration-tested and approved mounts
- Unique black finish
- Kit includes Automotive Mounting Kit
- Two-year warranty

### DESIGNED BY BIKERS FOR BIKERS

Featuring a bright 4.3" touch-screen color display, the Road Tech zūmo 660 puts all the information you need in an easy-to-read format as you travel down the road. The zūmo 660 also has a glove-friendly intuitive interface that makes entering information as easy as shifting gears. In addition, the wide sunlight-readable display makes for easy navigation — day or night. And with a rugged waterproof black case, the zūmo 660 was built for life on the road.

### GO YOUR OWN WAY

Pick your path and hit the streets. The zūmo 660 is ready to go right out of the box. It's preloaded with City Navigator® NT street maps and millions of points of interest (POIs) that include motels, restaurants, gas stations, ATMs and more. In addition, the zūmo 660 offers 3-D building view (where available) and lane assist with street sign view to show you more of your surroundings and make sure that you'll always know the right lane at the right time.

### KEEP IN TOUCH

The zūmo 660 features Bluetooth® wireless technology so you can stay in touch while you're on the move. With it, you're free to safely talk on your phone without having to remove your gloves or helmet. Simply connect your zūmo 660 to your Bluetooth-enabled headset or helmet and then pair with your cell phone to make and receive calls on the go. And with spoken street names functionality, the zūmo 660 will also transmit voice prompts to your headset for worry-free navigation.

### STAY ENTERTAINED

Have a long ride planned? The zūmo 660 is your all-in-one entertainment center. Featuring an on-board MP3 player and advanced Bluetooth A2DP technology, you'll enjoy crisp and clean stereo sound with your compatible headset. The motorcycle mount also comes standard with a headphone jack so you can connect to your headphones.

### PLAN & SHARE YOUR RIDES

Found the perfect backroad to share with your riding buddies? Or perhaps you're planning a cross-country trip and looking to avoid as much interstate as possible. With the zūmo 660's powerful trip planning tools, you can create your custom routes via Ride Planner at [barley-davidson.com](http://barley-davidson.com) and then transfer your saved route directly to your zūmo. When you return home, you can load your photos from your day's events to share with your friends.

# ROAD TECH™ GPS NAVIGATION



## ROAD TECH™ ZŪMO® 550 GPS NAVIGATOR

Throw away your maps and hit the road with the rugged Road Tech™ zūmo® GPS Navigator. Developed for Harley-Davidson by Garmin®, the motorcycle-friendly features make it easy to operate while in the saddle.

92357-08A

\$799.95

Fits '96-later XL, XR, Dyna®, Softail® and Touring and '02-later VRSC™ models (except VRSCR) with separate purchase of Handlebar Mount Kit P/N 92365-08 or Fairing Mount Kit P/N 92366-08. Also fits most automobile windshields or dash.

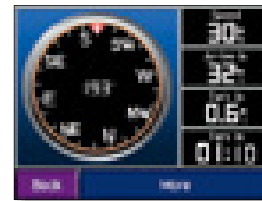
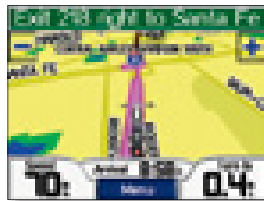
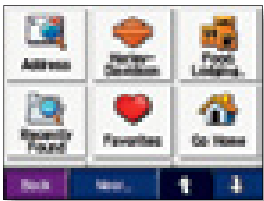

### LARGE SCREEN

Touch-screen access to programming, 3-D and overhead maps and digital dashboard.

## MOTORCYCLE-FRIENDLY DESIGN

- Glove-friendly touchscreen with left-handed controls
- Built in Harley® Dealer Database
- Rugged vibration-tested and approved mounts
- Two-year warranty
- Kit includes automotive mount
- Unique black finish with Bar & Shield logo

### NAVIGATE THE OPEN ROAD

Ready to go, the Road Tech zūmo is preloaded with City Navigator® NT street maps and a large point of interest (POI) database that includes Harley-Davidson® and Buell® Dealers, motels, restaurants, fuel, ATMs and more. Simply enter a destination, and the Road Tech zūmo leads you there with turn-by-turn voice directions and street names. The Road Tech zūmo also features a rechargeable lithium-ion battery for use away from the bike.

### LISTEN TO A LITTLE MUSIC

Road Tech zūmo features SD card expansion that makes it easy to transfer MP3 music files to your unit. Just plug in your Boom! Audio™ Music Headsets, and enjoy music while navigating. As you approach a turn, the music volume automatically lowers as your turns are announced.

### ADD TRAFFIC, WEATHER & RADIO

When plugged into the "Aux" input on the Advanced Audio Radio, the Road Tech zūmo can play music and report navigation commands through the motorcycle's speakers. With an optional XM® subscription and XM antenna, you can listen to music, sports and talk radio, check the weather and avoid traffic tie-ups when you travel the United States. All while you are navigating to your destination. Enjoy music at the same time as you follow the route to your next destination. As you approach a turn, the music volume automatically lowers as your turns are announced.

### TALK & LISTEN WIRELESSLY

Road Tech zūmo is equipped with Bluetooth® wireless technology, so you can talk on the phone safely without removing your gloves or helmet. Connect zūmo to your headset/helmet and cell phone to make and receive hands-free calls. You can even call ahead to POIs with the zūmo Bluetooth interface. In addition, zūmo transmits navigation voice prompts to your headset so you can listen wirelessly.

### PLAN YOUR TRIPS & SHARE YOUR RIDES

Road Tech zūmo makes it easy to plan your next trip and share routes with your riding buddies. Plan your route on Harley-Davidson Ride Planner® before you start, map out your food and fuel stops, the local attractions, and transfer your route to zūmo and go. At the end of the day, share your favorite places and rides with other zūmo riders, and review your travels in Google™ Earth. SD memory card expansion makes route sharing a breeze. When you return home, you can load your photos from your day's events to share with your friends.





NEW

A

**A. ROAD TECH ZŪMO 660  
FAIRING MOUNT KIT**



A

**A. ROAD TECH ZŪMO 550  
FAIRING MOUNT KIT**



NEW

B

**B. ROAD TECH ZŪMO 660  
HANDLEBAR MOUNT KIT**



B

**B. ROAD TECH ZŪMO 550  
HANDLEBAR MOUNT KIT**



C

**C. ROAD TECH ZŪMO 550  
AUTOMOTIVE MOUNTING KIT**



D

**D. ROAD TECH ZŪMO 550  
XM ANTENNA KIT**

### A. ROAD TECH™ ZŪMO® FAIRING MOUNT KIT

This installation kit is designed to allow fairing mounting of the Road Tech zūmo GPS System on specified Harley-Davidson models. Positioned for convenient viewing by both the rider and passenger, the Mounting Kit easily accepts the slide-in connection cradle for the Road Tech zūmo GPS System. Kit includes bracket and all required hardware. Installation requires drilling through inner fairing.

**92238-09** For zūmo 660 GPS **\$39.95**

Fits '96-later Electra Glide®, Street Glide® and Trike models equipped with Road Tech zūmo 660 GPS unit. Does not fit with Road Tech XM Satellite Radio P/N 76390-05A, '06-'10 CVO Electra Glide models or models equipped with Fairing Dash Pad P/N 58262-05. Does not fit with Windshield bags.

**92366-08** For zūmo 550 GPS **\$39.95**

Fits '96-later Electra Glide®, Street Glide® and Trike models equipped with Road Tech zūmo 550 GPS unit. Does not fit with Road Tech XM Satellite Radio P/N 76390-05A, '06-'10 CVO Electra Glide models or models equipped with Fairing Dash Pad P/N 58262-05. Does not fit with Windshield bags.

### B. ROAD TECH ZŪMO HANDLEBAR MOUNT KIT

This installation kit is designed for handlebar mounting of the Road Tech zūmo GPS System on specified Harley-Davidson models. Mounted to the left-side handlebar control clamp, the bracket accepts the slide-in connection cradle for the Road Tech zūmo GPS System.

**92378-09** For zūmo 660 GPS. **\$79.95**

Fits '96-later XL, XR, Dyna®, Softail®, Road King®, Road Glide® and '02-later VRSC™ models (except VRSCR) equipped with Road Tech zūmo 660 GPS unit. XL and XR models require additional purchase of (2) Screw P/N 4669M. Does not fit with Road Tech Satellite Radio, Left Hand Auxiliary Switch Housing or Clutch Lever Bracket Clamp Clock or Thermometer.

**92365-08** For zūmo 550 GPS. **\$79.95**

Fits '96-later XL, XR, Dyna, Softail, Road King®, Road Glide® and '02-later VRSC models (except VRSCR) equipped with Road Tech zūmo 550 GPS unit. XL and XR models require additional purchase of (2) Screw P/N 4669M. Does not fit with Road Tech Satellite Radio, Left Hand Auxiliary Switch Housing or Clutch Lever Bracket Clamp Clock or Thermometer.

### C. ROAD TECH ZŪMO 550 AUTOMOTIVE MOUNTING KIT

This docking station allows the Road Tech zūmo GPS Navigation System to be used in your auto or truck. The sturdy mount with integrated speaker and volume control is held firmly to the windshield by a lever-actuated suction cup, and the cradle provides a slide-in connection for the Road Tech zūmo. The integrated bracket connects to the wiring harness, and is equipped with a positive-lock for mounting and electrical power. Kit includes windshield mount and a 12-volt cigarette-lighter style power plug. Available in the United States only.

**92364-08** For zūmo 550 GPS. **\$119.95**

Fits most automobile windshields or dash. NOTE: Laws regarding windshield mount accessories vary from place to place. Some state and local governments prohibit or restrict the use of suction mounts on the windshield or windows of a motor vehicle. Please check with local authorities and obey all applicable laws and regulations.

### D. ROAD TECH ZŪMO 550 XM ANTENNA KIT

The compact, all-in-one antenna delivers XM Radio and XM Nav Traffic® and basic weather information to the Road Tech zūmo. With subscription(s) to XM services, you can check the weather and avoid traffic backups all while listening to over 170 channels of music, sports, news and talk entertainment. Enjoy music at the same time as you follow the route to your next destination. As you approach a turn, the music volume automatically lowers as the turns are announced. Setting up the antenna is fast and easy. Simply position the antenna where it has a clear view of the sky and connect it directly to the USB port on your unit. Then choose the XM subscription that best fits your needs.

**92382-08A** For zūmo 550 GPS. **\$249.95**

Fits '96-later Electra Glide, Street Glide, Road Glide and Trike models equipped with Road Tech zūmo 550 Navigator P/N 92357-08A.

## 620 GPS & AUDIO

Boom! Audio™

### A. BOOM! AUDIO™ ROAD TECH™ XM® SATELLITE RADIO – HANDLEBAR MOUNT

Over 170 channels to satisfy any taste in music, news, sports, talk, and entertainment. The convenient handlebar-mounted receiver features large buttons that allow easy access, even while wearing gloves. Twenty pre-set stations allow easy access to your favorite channels. The multi-line LCD screen is easy to read, and features an adjustable backlight for maximum daylight and nighttime visibility. XM unit can be connected to the auxiliary input in most fairing-mount or Road Tech Riser Mount radios for concert-hall sound, or used with mini-plug headsets. The complete kit includes XM receiver, adjustable handlebar mount, compact antenna and antenna mount, and all wiring and installation hardware. Kit also includes automotive adapter plate and 12-volt power source for in-car use. (Requires separate purchase of compatible automobile installation kit – visit [shop.xmradio.com](http://shop.xmradio.com) for more information.) Activation and monthly subscription service required with additional fee. For a limited time, your first three months of service are free.

**76390-05A** **\$249.95**

Fits '96-later Dyna®, Softail® and Touring models. Can be used with Original Equipment fairing mount radio, Road Tech Riser Mount Radio, or Road Tech Stereo Headset. Not compatible with Handlebar Mount GPS Navigation System, left-hand Auxiliary Switch Housing, or Clutch Lever Mounted Clock or Thermometer.



A. BOOM! AUDIO ROAD TECH XM SATELLITE RADIO – HANDLEBAR MOUNT

**XM® for everyone** With over 170 channels of digital-quality sound, including 100% commercial-free music and the best in news, sports, talk and more, XM Radio will satisfy any taste. And because it's on satellite, you won't lose the signal while crossing the country.

### B. BOOM! AUDIO TANK POUCH

This portable music system pouch is designed for motorcycle use. The Neoprene jacket offers hard-core protection for your portable music device, while the built-in magnets hold the pouch securely to the fuel tank. The clear play-through window permits touch-screen control, and the anti-skid interior insert allows the pouch to accommodate players of various sizes. Simply plug in your headphones or connect your in-dash Advanced Audio Radio with an auxiliary cable, and enjoy your music collection. Two access ports are provided for headphone and output cables. Works well with many MP3 and other personal music players, but should not be used with hard-disk memory players. Window measurement: 2.5" W x 4" H.

**91003-10** Multi-fit. **\$39.95**



B. BOOM! AUDIO TANK POUCH

### C. BOOM! AUDIO FULL HELMET MUSIC HEADSET

This headset uses high-quality speakers to give a well-rounded sound experience. The speakers are cushioned for a comfortable fit against the ear. This headset can be used with the Road Tech XM® Satellite Radio, Road Tech Radio, Road Tech Radar Detector, Road Tech Navigation Systems, and most personal music players.

**76530-07** Fits helmets with speaker pockets. **\$99.95**

### D. ROAD TECH EAR BUD SPEAKER KIT

Convenient in-ear speaker. When plugged into the earphone jack on the GPS mount, the navigation system will speak commands without disturbing others. The comfortable Ear Bud Speaker Kit features an in-line quick disconnect to simplify use with a helmet.

**91771-04** **\$16.95**

Fits with Road Tech Navigation Devices.



C. BOOM! AUDIO FULL HELMET MUSIC HEADSET



D. ROAD TECH EAR BUD SPEAKER KIT

*Notice: The prices appearing in this catalog are the manufacturer's suggested retail prices. Actual retail prices may vary.*



**D. ADVANCED AUDIO AM/FM/CD RADIO KIT  
BY HARMAN KARDON**

**HARLEY-DAVIDSON® ADVANCED AUDIO SYSTEM  
BY HARMAN/KARDON®**

The Harley-Davidson Advanced Audio System by Harman/Kardon® can turn your Touring motorcycle into a rolling "infotainment" center. The Advanced Audio system is an exciting collection of integrated audio and information components designed to combine the maximum number of features with an easy-to-use interface. Designed for plug-and-play integration of accessory components, the Advanced Audio Radio unit utilizes the easy-to-read LCD display and the hand control switches to access the most often used features.

**D. ADVANCED AUDIO AM/FM/CD RADIO KIT  
BY HARMAN/KARDON**

Upgrade your Electra Glide® Standard model to the latest in mobile communications technology. The Advanced Audio Radio is the first step to a total entertainment experience. Compatible with other Advanced Audio accessories, the radio features a menu-driven display that provides easy access to the many standard and available features. The radio features 6 AM and 10 FM radio presets, integrated weather band with weather alert warnings, and a single disc CD player that is compatible with CD/CDR/CDRW and MP3 format discs. MP3 compression technology allows each CD to hold up to 10 hours of music. The two fairing-mount speakers (included) are powered by a 20-watt per channel internal amplifier, and the Automatic Volume Control adjusts the volume to compensate for motorcycle speed. The complete Advanced Audio Radio Kit includes everything your dealer needs to install the AM/FM/WB/CD unit in the fairing of a 2006 or later Electra Glide Standard model. Dealer installation is required, labor cost not included.

**76412-06** **\$999.95**

Fits '06-later Electra Glide® Standard models.

'06-'08 models require Frame Mount Antenna P/N 76325-06, '09 models require Antenna Frame Mount Kit P/N 76556-09 and separate purchase of antenna. '06-later models with Tour-Pak® require Tour-Pak Antenna Kit P/N 76251-98A

**E. BOOM! AUDIO HIGH PERFORMANCE BOOM!  
BAGGER™ FAIRING SPEAKERS**

Capture every note. Boom! Bagger High Performance Speakers are designed for maximum performance in the harsh motorcycle environment. Two-way speaker design with separate full-range element and grill-mounted tweeter provides improved high frequency response that helps cut through the road and wind noise. Increased speaker sensitivity provides 25% louder output than Original Equipment speakers at the same volume setting, resulting in reduced distortion for improved clarity at speed. Speakers mount in the Electra Glide style fairing with no modifications. Complete kit includes two-way speaker design with separate custom grill-mounted tweeters, electronic crossovers, and plug and play wiring connections. (Available September 2009)

**77181-10** **\$149.95**

Fits '06-later fairing mount speakers on Electra Glide and Trike models equipped with Advanced Audio System.

**Also available (not shown):**

**BOOM! AUDIO SYSTEM WIRING HARNESS (not shown)**  
Allows installation of XM® Satellite Radio components on ULTRA models.

**70164-06** **\$89.95**

Fits '06-later FLHTCU, FLHTK and FLHTCUTG models equipped with Advanced Audio Radio.

Allows installation of Bike-to-Bike Communications, Intercom, XM® Satellite Radio, or Rear Speaker components.

**70169-06** **\$129.95**

Fits '06-later FLHT, FLHX, FLHTC and FLTR models equipped with Advanced Audio Radio.

Allows installation of XM Satellite Radio Kit on ULTRA models. Does not provide connections for additional components.

**70172-06** **\$49.95**

Fits '06-later FLHTCU, FLHTK and FLHTCUTG models equipped with Advanced Audio Radio.



**E. BOOM! AUDIO HIGH PERFORMANCE BOOM! BAGGER FAIRING SPEAKERS**

*Notice: The prices appearing in this catalog are the manufacturer's suggested retail prices. Actual retail prices may vary.*

## 622 GPS & AUDIO

Boom! Audio™

### A. BOOM! AUDIO™ REAR SPEAKER KIT

Add concert-hall sound to your motorcycle. Advanced Audio Rear Speaker Kit includes rear speakers, rear pods, and passenger controls for rear headset volume, CB PTT, and radio tuning. Dealer installation is required, labor cost not included.

**77155-06** **\$439.95**

Fits '06-later Touring models equipped with an Advanced Audio Radio and a rigid mount King Tour-Pak® luggage system. Requires installation of Wiring Harness P/N 70169-06.

### B. BOOM! AUDIO HIGH OUTPUT SOUND SYSTEM

When loud just isn't loud enough. The high-output amplifier provides a 40-watt per channel boost to the Advanced Audio Sound System for distortion-free sound, even at freeway speeds. Amplifier is installed beneath the rigid mount Tour-Pak to save storage space.

**76418-06A** **\$399.95**

Fits '06-later Touring models equipped with an Advanced Audio Radio and rigid mount Tour-Pak luggage system. Compatible with 2- and 4-speaker systems. Requires separate purchase of Wiring Harness P/N 70169-06.

### C. BOOM! AUDIO XM® SATELLITE RADIO KIT

Don't lose the radio reception in the middle of your favorite song. XM Satellite Radio allows you to listen to the same channel as you cross the country. With over 150 digital channels, you'll always find a program that satisfies your taste for music, news and sports. Your radio display provides information regarding artist name, song title, and channel information so you will always know what program you are listening to. 15 channel presets allow you to quickly access your favorite programming. Subscription service required with additional monthly fee. For a limited time, your first three months of service are free.

**76404-06** **\$499.95**

Fits '06-later Touring models equipped with an Advanced Audio Radio. Requires installation of appropriate Wiring Harness and Antenna Bracket P/N 76456-06 (FLH models) or 76316-06A (FLTR models).

### D. BOOM! AUDIO BIKE-TO-BIKE (B2B) COMMUNICATIONS KIT

Communicate with your friends on any of 40 channels. Easy-to-use handlebar controls allow PTT and adjust squelch levels for maximum performance and reception quality. Integrated CB System will mute the radio while in transmit or receive mode. Bike-to-Bike system allows you and your passenger to talk with other riders, even when you are miles apart.

**76416-06C** **\$299.95**

Fits '06-later Touring models equipped with an Advanced Audio Radio. Requires installation of Wiring Harness P/N 70169-06, CB Antenna Mounting Kit P/N 76415-06 or 76410-09 (frame mount) or 76414-06 or 76400-09 (Tour-Pak mount), Communications Switch Kit P/N 77173-06, 77173-07 or 77173-08. '06-'07 FLHX models also require the following items: Fuel Tank Console P/N 61270-98A, Tank Console Gasket P/N 71294-89, Tank Console Screw P/N 3652, Tank Console Nut P/N 7964, Adhesive Clip P/N 10120, Adhesive Clip P/N 10103, Tank Pod Mounting Screws P/N 2462 (quantity 3), FLHT Trim Piece P/N 52447-96, Grommet P/N 59778-06, and a CB Pod Trim Badge and separate purchase of microphone. '08-later FLHX models also require Fuel Tank Console P/N 61270-08, and Clips P/N 10103 and 10120 (The Console Screws, Fuel Door, Gasket, mounting bracket will all need to be reused).



A. BOOM! AUDIO REAR SPEAKER KIT



B. BOOM! AUDIO HIGH OUTPUT SOUND SYSTEM



C. BOOM! AUDIO XM SATELLITE RADIO KIT



D. BOOM! AUDIO BIKE-TO-BIKE (B2B) COMMUNICATIONS KIT

Notice: The prices appearing in this catalog are the manufacturer's suggested retail prices. Actual retail prices may vary.



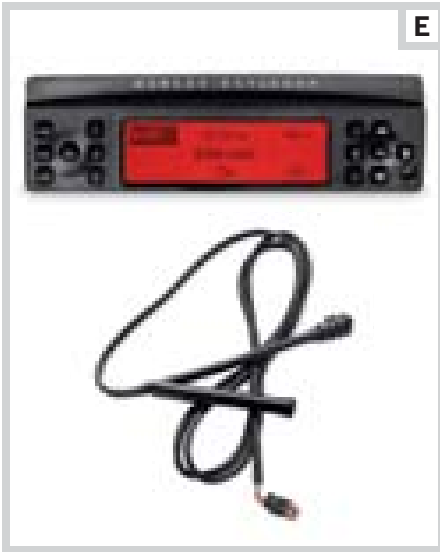

**E. BOOM! AUDIO MUSIC AND INTERCOM KIT – TOUR-PAK MODELS**



**F. BOOM! AUDIO COMMUNICATIONS SWITCH KIT**



**G. BOOM! AUDIO MUSIC AND INTERCOM KIT – RIDER POSITION (SHOWN WITH OPTIONAL BOOM! AUDIO HEADSET)**



**G. BOOM! AUDIO MUSIC AND INTERCOM KIT – PASSENGER POSITION (SHOWN WITH OPTIONAL BOOM! AUDIO HEADSET)**

**E. BOOM! AUDIO™ MUSIC AND INTERCOM KIT – TOUR-PAK® MODELS**

Keep the lines of communication open. This easy-to-use voice activated intercom system allows the rider and passenger to communicate without resorting to hand signals. Independent volume controls allow rider and passenger to adjust the sound to comfortable levels. The integrated system automatically lowers the radio volume when the intercom is in use.

**76440-06 \$89.95**

Fits '06-later Touring models equipped with an Advanced Audio Radio and a rigid mount Tour-Pak® luggage system. Requires installation of Intercom System Flash P/N 76441-06/DT, Wiring Harness P/N 70169-06, Rear Speaker Kit P/N 77155-06, Communications Switch Kit P/N 77173-06, 77173-07 or 77173-08.

**F. BOOM! AUDIO COMMUNICATIONS SWITCH KIT**

Allows the use of a Harley-Davidson helmet headset on Touring models that are not equipped with the helmet headset interface. This kit contains Console Pod Assembly, Left-Hand Control Switch Assembly and Fairing Speaker Switch.

**77173-08 \$254.95**

Fits '08-later Touring models equipped with an Advanced Audio Radio System.

**G. BOOM! AUDIO MUSIC AND INTERCOM KIT**

Add headphone-access music and rider-to-passenger communication to your Advanced Audio System-equipped Touring bike. The stock radio can be programmed to enable the integrated intercom mode that works flawlessly as you ride down the road, and this wiring kit includes the addition of front- and rear-communications ports to bikes without rear speaker pods or Tour-Pak luggage. Discrete tank and rear fender pods accept 7-pin plugs for rider and passenger headsets that allow the rider and passenger to listen to infotainment programming without disturbing the neighbors. The rear port features a separate volume control, so both rider and passenger can adjust the sound to comfortable levels.

This kit also permits installation of a detachable Tour-Pak to your rear-speaker-equipped Ultra and Ultra Limited models. By relocating the headphone jack and the push-to-talk control from the speaker pod to the rear fender, full radio and communications function is retained when you remove the Tour-Pak.

**Bike-to-Bike Communication Feature:**

The Boom! Audio Music And Intercom Kit enables high quality, high range, hassle free Bike-to-Bike communications with the purchase of Communication Kit P/N 76416-06C, Wiring Harness P/N 70169-06, and model specific CB Antenna. This will allow you and your passenger to talk to other riders, even when you are miles apart.

Kit includes rider and passenger plug in pods, fairing speaker/headset switch, left-side hand control with push-to-talk switch, and required mounting hardware. Works with full- or half-helmet headsets (sold separately).

**77107-09 \$399.95**

Fits '07-later Touring vehicles equipped with Advanced Audio Radio. Requires installation of Intercom System Flash P/N 76441-06/DT. Models equipped with Advanced Audio XM Satellite Radio P/N 76404-06 and/or Advanced Audio Bike-to-Bike Communications Kit P/N 76416-06C should use Advanced Audio Intercom Add-On Kit P/N 77108-09.

**77108-09 \$379.95**

Fits '07-later Touring vehicles equipped with Advanced Audio Radio and Advanced Audio Bike-to-Bike Communications and/or Advanced Audio XM Satellite Radio Kit with Wiring Harness P/N 70169-06. Requires installation of Intercom System Flash P/N 76441-06/DT.

## 624 GPS & AUDIO

Boom! Audio™

### A. BOOM! AUDIO™ HALF HELMET MUSIC AND COMMUNICATIONS HEADSET

This comfortable headset is designed to allow full music and communication function while wearing a half helmet. Lightweight, durable neck bow wraps around the ear and across the back of the neck, and fits comfortably below the shell of most half helmets. Great-sounding foam-covered on-ear stereo headphone cups reduce wind noise while allowing you to hear surrounding traffic. The adjustable boom microphone with wind sock has been optimized for superior clarity when connected to Harley-Davidson intercom and Bike-to-Bike communications equipment, and the quick-disconnect plug allows you to step away from the motorcycle without removing the headset. A clothing clip (*not shown*) is included for added comfort and reduced ear fatigue. The coiled cord permits freedom of movement in the saddle. The 7-pin DIN plug can be connected to the front and rear communications ports, allowing both rider and passenger access to the music, navigation, and voice communications features of the motorcycle.

**76572-09** 7 pin DIN Connector. **\$119.95**

Fits '98-later FLHTCU, FLHTK, and FLHTCUTG models. Also fits with vehicles equipped with Communication Switch Kit P/N 77173-08 or Intercom Kit P/N 77107-09.

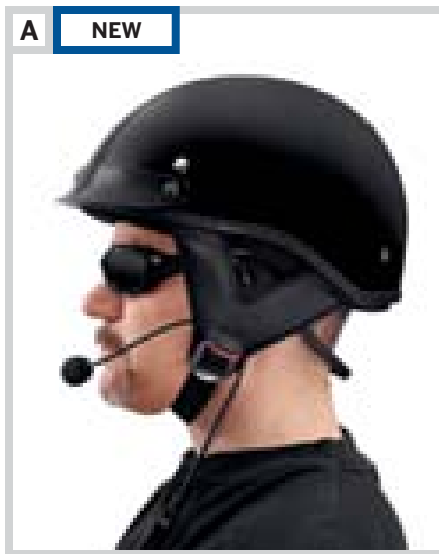

A. BOOM! AUDIO HALF HELMET MUSIC AND COMMUNICATIONS HEADSET

### B. BOOM! AUDIO HALF HELMET MUSIC HEADSET

Listen to music or navigation system directions while wearing a half helmet. This comfortable headset features a lightweight, durable neck bow that wraps around the ear and across the back of the neck and fits comfortably below the shell of most half helmets. The great-sounding foam-covered on-ear stereo headphone cups reduce wind noise while allowing you to hear surrounding traffic, and the quick-disconnect plug allows you to step away from the motorcycle without removing the headset. A clothing clip is included for added comfort and reduced ear fatigue. The coiled cord permits freedom of movement in the saddle, and the 1/8" (3.5mm) plug can be connected to the Road Tech zūmo, Road Tech XM® Satellite Radio, and other MP3 players and portable stereo devices.

**76569-09** 1/8" (3.5mm) Mini Plug Connector. **\$79.95**

Fits Road Tech™ zūmo, Road Tech XM Satellite Radio, and other electronic devices with 1/8" (3.5mm) stereo mini jack output.



B. BOOM! AUDIO HALF HELMET MUSIC HEADSET

### C. BOOM! AUDIO FULL HELMET PREMIUM MUSIC AND COMMUNICATIONS HEADSET

Introduced as standard equipment on the '10 Ultra motorcycles, this comfortable headset is designed to allow full communication function while wearing a 3/4 or full-face helmet. The stylish plug module clamps to the base of the helmet, and positions the adjustable wind sock-equipped boom microphone for the best sound quality. Great-sounding foam-covered stereo speakers comfortably fit into ear pockets in the helmet, and the fine wires are easy to hide beneath the helmet liner for a clean installation. The quick-disconnect plug allows you to step away from the motorcycle without removing the helmet, and the coiled cord permits freedom of movement in the saddle. The 7-pin DIN plug can be connected to the front and rear communications ports, allowing both rider and passenger access to the music, navigation, and voice communications features of your motorcycle, and the microphone has been optimized for superior clarity when connected to Harley-Davidson intercom and Bike-to-Bike communications equipment.

**77117-10** **\$189.95**

Fits '98-later Touring models equipped with a communication module.



C. BOOM! AUDIO FULL HELMET PREMIUM MUSIC AND COMMUNICATIONS HEADSET

Notice: The prices appearing in this catalog are the manufacturer's suggested retail prices. Actual retail prices may vary.



**D. BOOM! AUDIO FULL HELMET MUSIC AND COMMUNICATION HEADSET**



**E. ROAD TECH HAND-HELD CB MICROPHONE KIT**



**F. BOOM! AUDIO HIGH-PERFORMANCE SPEAKER KIT--'98-'05 MODELS**



**G. ROAD TECH SHORTY CB ANTENNA (SHOWN WITH SHORTY AM/FM ANTENNA)**



**H. ROAD TECH SHORTY AM/FM ANTENNA**

**D. BOOM! AUDIO™ FULL HELMET MUSIC AND COMMUNICATION HEADSET**

Helmet headset has a boom microphone, speakers and coiled cord with weather resistant DIN connectors.

**77147-91C** **\$199.95**

Fits '91-'97 Ultra models with CB/Intercom Systems.

**77122-99** **\$19.95**

Replacement headset cord (not shown) for use with Kit P/N 77147-91C.

**Replacement Headset Cord (not shown)**

**77148-91** **\$23.35**

Replacement cord for 77147-91, 77147-91A and 77147-91B.

Not for use with 77147-91C.

**77126-98** **\$3.95**

Windsock for headset.

**E. ROAD TECH™ HAND-HELD CB MICROPHONE KIT**

Comes complete with handlebar mounting bracket and all necessary hardware.

**76312-98** **\$99.95**

Fits '98-later FLHTCUI, FLHTK, FLHTCUTG, models and '98-later FLTR models equipped with CB Radio Kit P/N 76331-98. (Does not retrofit earlier models.)

**F. BOOM! AUDIO HIGH-PERFORMANCE SPEAKER KIT**

Add brilliance to your '98-'05 H-D® sound system through the simple installation of these enhanced speakers. Each speaker has its own ferro-fluid-cooled tweeter and a two-way coaxial design for an improved range of sound. Your stock sound system truly comes alive and can be heard like never before. Upgrade both your front and rear speakers.

**77181-01** **\$75.99**

Fits all '98-'05 FLHT and FLTR, FLHTC, FLHTCUTG. Stock on '01-'05 FLT, FLTR, FLHT, FLHTC, FLHTCUI models. (pair)

**G. ROAD TECH SHORTY CB ANTENNA**

This compact antenna is only 19" tall, and is a stylish change from the Original Equipment whip antenna. The low-profile antenna simplifies covering the bike for storage. Easy-to-install, the Shorty Antenna screws on to the factory antenna mount.

**76386-09** **\$29.95**

Fits '09-later Touring models equipped with Bike-to-Bike Communication. May require model specific mounting bracket if installed on a model without a Tour-Pak.

**76386-08** **\$29.95**

Fits '98-'08 Touring models equipped with Bike-to-Bike Communication. May require model specific mounting bracket if installed on a model without a Tour-Pak.

**H. ROAD TECH SHORTY AM/FM ANTENNA**

This compact antenna is only 19" tall, and is a stylish change from the Original Equipment whip antenna. The low-profile antenna simplifies covering the bike for storage. Easy-to-install, the Shorty Antenna screws on to the factory antenna mount.

**76388-08** **\$29.95**

Fits '98-later Touring models equipped with radio.

# 626 GPS & AUDIO

Road Tech™

## A. CB ANTENNA KIT – TOUR-PAK® MOUNT

The CB Antenna Kit mounts an antenna on a Tour-Pak® luggage system. Kit includes Original Equipment style CB antenna, all necessary mounting brackets, cable hardware, and instructions. Fits all Tour-Pak luggage systems.

**76400-09 \$89.95**

Fits '09-later Touring models with Tour-Pak luggage. Includes Fiberglass CB Antenna P/N 76250-09.

**76414-06 \$109.95**

Fits '06-'08 Touring models with Tour-Pak luggage. Includes wire whip style CB Antenna P/N 76250-98.

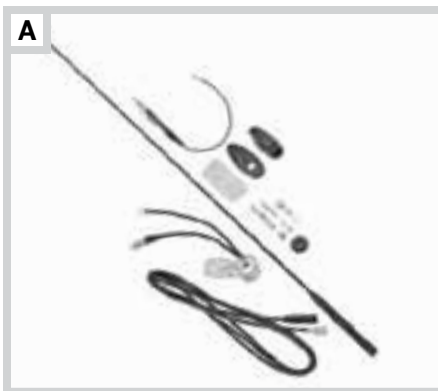

A. CB ANTENNA KIT – TOUR-PAK MOUNT

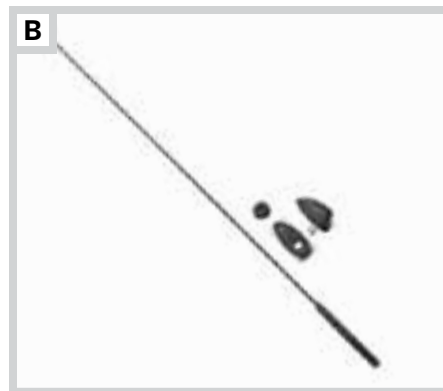

B. AM/FM ANTENNA KIT – TOUR-PAK MOUNT

## B. AM/FM ANTENNA KIT – TOUR-PAK MOUNT

The AM/FM Antenna Kit mounts an antenna on a Tour-Pak® luggage system. Kit includes Original Equipment style Fiberglass AM/FM Antenna P/N 76503-08, all necessary mounting brackets, cable hardware, and instructions. Fits all Tour-Pak luggage systems.

**76251-98A \$44.95**

Fits '98-later Touring models with Tour-Pak luggage.

## C. CB ANTENNA KIT – FRAME MOUNT

Will enable the installation of a CB antenna on the right side of a fender. Kit includes CB antenna and mounting brackets.

**76410-09 \$89.95**

Fits '09-later FLHX, FLTR, and FLTRX models. Does not fit FLHXSE and FLTRSE models. Includes Fiberglass CB Antenna P/N 76250-09.

**76415-06 \$109.95**

Fits '06-'08 FLHX and FLTR models. Includes wire whip style CB Antenna P/N 76341-98.

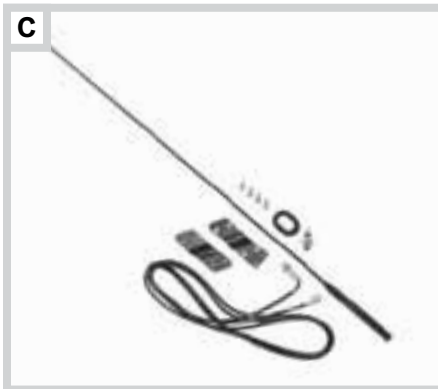

C. CB ANTENNA KIT – FRAME MOUNT



D. CB ANTENNA KIT FOR ROAD GLIDE – FRAME MOUNT

## E. ANTENNA RELOCATION KIT, AM/FM

This Antenna Relocation Kit allows you to easily switch between your detachable Tour-Pak® luggage, a detachable passenger backrest, or the clean look of a stock FLHT or FLTR.

**76556-09 \$69.95**

Fits '09-later FLHT, FLHTC, FLHX, FLTR and FLTRX models. Does not fit FLTRSE or FLHXSE models.

**76326-00A \$99.95**

Fits all '98-'08 FLHT, FLHX and FLTR models.

## F. ANTENNA RELOCATION KIT FOR FLTR/FLHX WITH DETACHABLE TWO-UP LUGGAGE RACK

Relocate your AM/FM antenna for use with Detachable Two-Up Luggage Rack.

**76561-09 \$24.95**

Fits '09-later FLHX, FLTR, and FLTRX models (except FLTRSE3/4 and FLHXSE) equipped with Detachable Two-Up Luggage Rack P/N 54215-09. Does not fit with Nostalgic Saddlebag Guard Rail Kit P/N 91286-09.

**76208-07 \$24.95**

Fits '97-'08 FLTR and FLHX equipped with Detachable Two-Up Luggage Rack P/N 53743-97 and Two-Up Detachable Docking Hardware Kit P/N 53804-06.



E. ANTENNA RELOCATION KIT, AM/FM ('09-LATER MODELS)



E. ANTENNA RELOCATION KIT, AM/FM ('98-'08 MODELS)



F. ANTENNA RELOCATION KIT FOR FLTR/FLHX WITH DETACHABLE TWO-UP LUGGAGE RACK

Notice: The prices appearing in this catalog are the manufacturer's suggested retail prices. Actual retail prices may vary.





# LIGHTING

*Whether you want to grab a little more attention on the boulevard or light up the desolate highway, accessory lighting gives you options. From Euro-inspired projector beam headlamps to auxiliary turn signals, you can equip your bike to stand up to the dark. But it also helps you stand out from the crowd. Electra-Glo™ lighting adds visual impact, and decorative trim rings, headlamp visors, and license plate frames add a personal touch.*

## **HORNS, LIGHTING AND LICENSE PLATE MOUNTS**



### REAR LIGHTING

*Improve the rear profile of your ride by adding the right combination of rear lighting elements. Options like LED tail lamps integrate form and function while bullet rear turn signals complement the lighting style set by the front end for a clean, consistent look.*



### PREMIUM AIR HORN

*Easy to hear and impossible to ignore. The Premium Air Horn is one of the loudest motorcycle horns available and tuned to mimic a truck horn to grab attention. The self-contained compressor and horn bell are designed for durability and easy installation.*

# 628 LIGHTING

## Headlights – Bulbs

### LET THERE BE LIGHT

Featuring the latest in reflector optic design, Harley-Davidson® Original Equipment headlamps and accessory Dual Bulb Halogen Headlamps offer low-beam performance that is superior to traditional sealed beam bulbs. The wide curb-to-curb low beam pattern provides a great around-town view. Cruising down the back roads, Dual Bulb High Intensity Discharge (HID) or Dual Bulb Halogen headlamps add extra punch down the center of the lane, all while maintaining their excellent low-beam performance.

### A. HIGH INTENSITY DISCHARGE (HID) DUAL BULB HEADLAMP KIT\*

Cut through the darkness. The Harley-Davidson High Intensity Discharge Headlamp Kit features a true HID (Xenon) low beam bulb that projects a curb-to-curb spread of "blue/white" light. Compared to the yellow light of a traditional halogen bulb, the HID lamp produces a "Daylight Color Impression" that appears more natural to the user.

The HID Dual Bulb Headlamp assembly features unique advanced optics with separate low and high beam reflectors dedicated to focus the light for optimal illumination. The HID low beam is always illuminated, providing a wide pool of light, and the separate halogen high beam bulb adds a focused shaft of light down the center of the lane.

The HID Dual Bulb Headlamp is not just a high-performance bulb, it's a complete lighting system. The system includes the HID bulb, an electronic starter, and a ballast system. The bulb is a complex tube that replaces the filament with arc-producing electrodes. The starter allows quick ignition of the arc, and the ballast converts incoming power to the high voltage needed to maintain the glow. The Xenon-filled HID bulb is resistant to vibration, and has a life expectancy of up to 10 times that of a halogen bulb. The headlamp kit is DOT approved for use in all 50 states.

The complete Headlamp Kit includes the shock and vibration resistant housing HID low beam bulb, halogen high beam bulb, starter, waterproof ballast, and all necessary wiring.

**68094-06C** **\$524.95**

Fits '96-later Electra Glide®, Street Glide®, and Trike models.

**68043-06B** **\$524.95**

Fits '02-later Road King® models.

NOTE: HG-Lamp contains Mercury. Manage in accordance with disposal laws.

### B. DUAL BULB HALOGEN HEADLAMP KIT

The Dual Bulb Halogen Headlamp features advanced reflector optics and separate bulbs for high and low beam functions. The euro-inspired projector beam styling combines a state-of-the-art look with a CAD designed faceted reflector bowl that is optimized for crisp patterns and light cut-off. The single upper bulb functions in low beam, and both upper and lower bulbs operate in high beam. The low beam setting produces a wide curb-to-curb light pattern, and the high beam adds focused light down the center of the lane without compromising width. Kit includes housing, 55-watt low beam halogen lamp, 35-watt high beam halogen lamp and all necessary mounting hardware. Does not meet ECE regulations.

**67864-04A** **\$164.95**

Fits '94-later Electra Glide®, Road King® and Trike models, and '94-later FL Softail® models equipped with Chrome Headlight Nacelle Kit P/N 67907-96B. Kit includes mounting ring assembly.

**67863-04A** **\$129.95**

Fits '91-later FLSTC, FLSTF, and FLSTN models. Does not fit models equipped with Chrome Headlight Nacelle Kit P/N 67907-96B.

\*NOTE: It is possible to overload your motorcycle's charging system by adding too many electrical accessories. If your combined electrical accessories operating at any one time consume more electrical current than your vehicle's charging system can produce, the electrical consumption can discharge the battery and cause vehicle electrical system damage. Ask your dealer for advice about the amount of current consumed by additional electrical accessories.

Notice: The prices appearing in this catalog are the manufacturer's suggested retail prices. Actual retail prices may vary.



**High Intensity Discharge (HID) – Dual Bulb Headlamp (7") Birds Eye View, (shown in feet)**

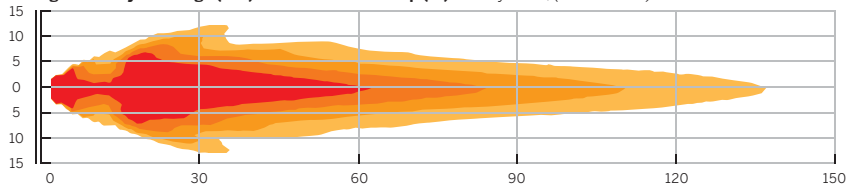

**A. HIGH INTENSITY DISCHARGE (HID) DUAL BULB HEADLAMP KIT – ELECTRA GLIDE SHOWN**



**Dual Bulb Halogen Headlamp (7") Birds Eye View, (shown in feet)**

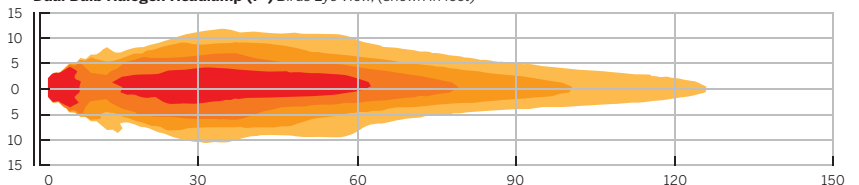

**B. DUAL BULB HALOGEN HEADLAMP KIT – ROAD KING/FL SOFTAIL WITH HEADLIGHT NACELLE SHOWN**



C

### C. HALOGEN HEADLAMPS – CLEAR SMOOTH LENS WITH REFLECTOR OPTICS

Original Equipment on '05-later Harley-Davidson® models, these headlamps feature crystal clear lenses, mirror-finish reflector optics, and replaceable halogen bulb.

**68297-05** 5-3/4" Domestic. **\$89.95**  
Fits '00-later XL, XR, Dyna® (except FXDF), FX Softail® and '05 VRSCB models equipped with 5-3/4" headlamp. '00-'04 Dyna (except FXDWG) models require Adapter Ring P/N 67883-04.

**68335-05** 5-3/4" HDI Left Dip. **\$98.00**  
Fits '00-later XL, Dyna, FX Softail and '05 VRSCB HDI models equipped with 5-3/4" headlamp. All '00-'04 Dyna (except FXDWG), '04 XL883 and '04 1200R HDI models require Adapter Ring P/N 67883-04. '00-'04 XL883C and XL1200C HDI models require Adapter Ring P/N 67603-94. Some '00-'04 FXSTD/I, FXSTS/I and FLSTS/I models may also require Adapter Ring P/N 67603-94. See your Dealer for details.

**68341-05** 5-3/4" HDI Right Dip. **\$98.00**  
Fits '00-later XL, Dyna, FX Softail and '05 VRSCB HDI models equipped with 5-3/4" headlamp. All '00-'04 Dyna (except FXDWG), '04 XL883 and '04 1200R HDI models require Adapter Ring P/N 67883-04. '00-'04 XL883C and XL1200C HDI models require Adapter Ring P/N 67603-94. Some '00-'04 FXSTD/I, FXSTS/I and FLSTS/I models may also require Adapter Ring P/N 67603-94. See your Dealer for details.

**68342-05** 7" Domestic. **\$94.95**  
Fits '00-later FL Softail and Touring models equipped with 7" headlamp. Some '00-'04 Touring models may require an updated Retaining Ring P/N 67726-71A for installation. See your Dealer for details.

**68344-05** 7" HDI Left Dip. **\$102.00**  
Fits '00-later FL Softail and Touring HDI models equipped with 7" headlamp. Some '00-'04 HDI Touring models may require updated Retaining Ring P/N 67726-71A and Mounting Ring P/N 67732-71B for installation. See your Dealer for details.

**68345-05** 7" HDI Right Dip. **\$102.00**  
Fits '00-later FL Softail and Touring HDI models equipped with 7" headlamp. Some '00-'04 HDI Touring models may require updated Retaining Ring P/N 67726-71A and Mounting Ring P/N 67732-71B for installation. See your Dealer for details.

**67775-01C** FLTR Domestic. **\$197.00**  
Fits '00-'09 FLTR models.

### D. PERFORMANCE HEADLAMP BULB

This Xenon gas-filled replacement headlamp bulb lights the way with a whiter, more natural light. The coating on the lamp shows a slight blue tint to the oncoming traffic.

**67074-02** **\$23.95**  
Fits all models with replaceable headlamp bulb (except '02-later VRSCA, '04 VRSCB, '06-later VRSCR, VRSCX, VRSCF, XR and models equipped with Dual Bulb Halogen Headlamp Kit P/N 67864-04 or 67863-04).

Notice: The prices appearing in this catalog are the manufacturer's suggested retail prices. Actual retail prices may vary.

Original Equipment – Halogen Headlamps With Reflector Optics (7") Birds Eye View, (shown in feet)

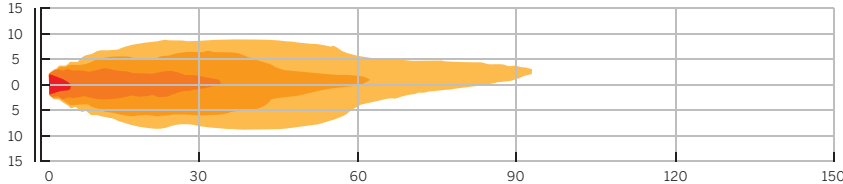

### C. HALOGEN HEADLAMPS – CLEAR SMOOTH LENS WITH REFLECTOR OPTICS (SHOWN WITH AUXILIARY LAMP BULB KIT – CLEAR LENS AND VERTICAL REFLECTOR OPTICS)



D

### D. PERFORMANCE HEADLAMP BULB



# 630 LIGHTING

Headlights – Auxiliary

## A. AUXILIARY LIGHTING KIT\*

There's a lot of road on this planet, and these chrome lamps will light the way. Just add the desired lamp bulb kit (*sold separately*) to complete the installation. The kit includes the chrome lamp housings, and the chrome mounting brackets that match the contour of the triple tree and highlight the headlamp. Kit comes complete with the necessary wiring, switch and hardware for installation. Can be used with Turn Signal Relocation Kit P/N 68603-01. Bulbs sold separately.

**69284-05** **\$289.95**

Fits '88-later XL and '91-'05 Dyna® models (except FXDWG, FXDS-CONV., and FXDXT). Also fits '88-'94 FXR, FXRS, FXLR models. ('88-'97 XL883, '88-'96 XL883 Deluxe, '96-'97 XL1200S, '88-'94 FXRS-SP and '91-'92 FXDB-S require Turn Signal Relocation Kit P/N 68603-01.) Will not fit FXR models equipped with engine guards or Front Directional Signal Relocation Kit P/N 68517-94A.

**69285-05** **\$289.95**

Fits '93-'05 FXDWG and '84-later FXST, FXSTC and FXSTB models.

**68605-08** Fits '06-later Dyna models. **\$289.95**

**Also available:**

### TURN SIGNAL RELOCATION KIT

This kit relocates the turn signals to the passing lamp bracket, and allows the use of a Detachable Windshield. Kit includes all necessary hardware required for installation.

**68603-01** **\$39.95**

Fits '88-later XL, '91-'05 Dyna, and '84-later FXST, FXSTC and FXSTB Softail® models equipped with Auxiliary Lighting Kits.

**Also available:**

### WINDSHIELD DOCKING HARDWARE AND TURN SIGNAL RELOCATION KIT

Required for installation of Detachable Windshields on FXDWG and FXST models equipped with Passing Lamps. Includes windshield mounting hardware and turn signal relocation hardware.

**58361-03** **\$74.95**

Fits '93-'05 FXDWG and '84-later FXST, FXSTC, FXSTB models equipped with Auxiliary Lighting Kits.



**A. AUXILIARY LIGHTING KIT – SPORTSTER/DYNA  
(SHOWN WITH AUXILIARY LAMP BULB KIT – CLEAR WITH LENS OPTICS)**



**A. AUXILIARY LIGHTING KIT – FX SOFTAIL/DYNA WIDE GLIDE  
(SHOWN WITH SMOKED AUXILIARY LAMP BULB KIT AND TURN SIGNAL RELOCATION KIT)**



**A. AUXILIARY LIGHTING KIT – '06-LATER DYNA MODELS  
(SHOWN WITH CLEAR LENS WITH HALOGEN AUXILIARY BULB KIT)**

\*NOTE: It is possible to overload your motorcycle's charging system by adding too many electrical accessories. If your combined electrical accessories operating at any one time consume more electrical current than your vehicle's charging system can produce, the electrical consumption can discharge the battery and cause vehicle electrical system damage. Ask your dealer for advice about the amount of current consumed by additional electrical accessories.

Notice: The prices appearing in this catalog are the manufacturer's suggested retail prices. Actual retail prices may vary.



# LIGHTING 631

Headlights – Auxiliary



B

**B. AUXILIARY LIGHTING KIT – FL SOFTAIL  
(SHOWN WITH CLEAR LENS WITH HALOGEN BULB KIT AND TURN SIGNAL RELOCATION KIT)**

## **B. AUXILIARY LIGHTING KIT – FL SOFTAIL® MODELS\***

Function and style in one. This Auxiliary Lighting Kit features polished chrome mounting brackets and a tubular crossbar contoured to accent the headlamp. Kit includes chrome lamp housings and all required wiring, toggle switch, and hardware. All you need to add is your choice of bulb type, and you'll light up the open road. *(Bulbs sold separately.)*

**69287-07** **\$229.95**  
Fits '00-later FLSTF and '06 FLST models.

## **Shown with: TURN SIGNAL RELOCATION KIT FOR AUXILIARY LIGHTING KITS**

Easy-to-install, this kit relocates the turn signals from the handlebars to the auxiliary lamp chrome mounting bracket. Provides a clean look to the front end of the motorcycle by removing wires and lights from the handlebar area. Kit includes turn signals for auxiliary lamps, mounting bracket and all necessary hardware.

Fits Softail models equipped with Auxiliary Lighting Kit P/N 69287-07.

<b>68413-99</b>	Domestic.	<b>\$99.95</b>
<b>68412-99</b>	International.	<b>\$99.95</b>

## **C. DELUXE AUXILIARY LIGHTING KIT – FL SOFTAIL MODELS\***

Shaped by the wind. These billet-look mounting brackets hug the contour of the Smooth Chrome Triple Tree Cover (included). Separate purchase of the sealed lamp is required to allow the flexibility to choose from four different styles. *(Bulbs sold separately.)*

Fits '00-later FLSTF and '06 FLST models. Compatible with Nostalgic Windshield Kit P/Ns 57140-05, 57181-05 and 57141-05 only. Will not fit with Chrome Headlamp Nacelle Kit P/N 67907-96B.

<b>68669-05</b>	Domestic.	<b>\$394.95</b>
<b>68670-05</b>	International.	<b>\$394.95</b>

## **D. AUXILIARY LIGHTING KIT – SPRINGER® MODELS\***

Chrome mounting bracket nicely accents Springer® front end and offers an integrated factory installed appearance. Just add the desired lamp kit *(sold separately)* to complete the installation. The kit includes the chrome lamp housings, chrome mounting brackets, and all necessary wiring, switch and hardware for installation. Designed to fit with or without Windshields and Horn Kit P/N 69036-88A. Cannot be used with Handlebar Reservoir Cover Set P/Ns 46098-98 or 46099-98. *(Bulbs sold separately.)*

**69286-05A** **\$229.95**  
Fits '88-later FXSTS, FXSTSB and '05-later FLSTSB, FLSTSC models.



C

**C. DELUXE AUXILIARY LIGHTING KIT – FL SOFTAIL MODELS  
(SHOWN WITH CLEAR LENS WITH HALOGEN BULB KIT)**



D

**D. AUXILIARY LIGHTING KIT – SPRINGER MODELS  
(SHOWN WITH CLEAR LENS WITH HALOGEN BULB KIT)**

\*NOTE: It is possible to overload your motorcycle's charging system by adding too many electrical accessories. If your combined electrical accessories operating at any one time consume more electrical current than your vehicle's charging system can produce, the electrical consumption can discharge the battery and cause vehicle electrical system damage. Ask your dealer for advice about the amount of current consumed by additional electrical accessories.

Notice: The prices appearing in this catalog are the manufacturer's suggested retail prices. Actual retail prices may vary.

# 632 LIGHTING

Headlights – Auxiliary

## A. CUSTOM AUXILIARY LIGHTING BRACKET KIT

Shaped by the wind, these Custom Auxiliary Lighting Brackets blend into the curving contours of the Road King® nacelle or the Electra Glide® fairing. The chrome-plated brackets serve as stylized mounting points for the passing lamp housings and available bullet style turn signals, adding a smooth look that eliminates the cross brace and flat side supports of the Original Equipment installation.

**69818-06** **\$299.95**

Fits '06-later FLHX and FLHXXX models. Kit includes passing lamp housings, retaining rings, chrome mounting brackets, auxiliary lamp switch and hardware. Auxiliary Lamp Bulbs and Bullet Turn Signal Kits sold separately.

**69227-04A** **\$289.95**

Fits '97-later Electra Glide® models (except FLHX and Trike) and '04-later FLHRS models. '94-later Road King® models equipped with windshield require separate purchase of Hardware Kit P/N 69235-04. For installation on FLHRS models that do not presently have a windshield, but wish to install a windshield, the additional purchase of Hardware Kit P/N 69234-04 is required. Kit includes passing lamp housings, chrome mounting brackets and hardware. Installation requires the reuse of Original Equipment sealed beam lamps and retaining rings. Bullet Turn Signal Kits sold separately.

**Shown with:**

### CUSTOM AUXILIARY LAMP BRACKET TURN SIGNAL KIT

Add your choice of Bullet Style Turn Signals to the Custom Passing Lamp Bracket. Select from amber, clear, or smoked lens turn signal kits to complement your custom direction. Kit includes left and right bullet turn signal housing, two lenses, and two front bulbs.

Fits '94-later FLHR models and '97-later FLHT and FLHX models equipped with Custom Auxiliary Forward Lamp Bracket Kits.

**69230-04** Amber Lens, Clear Bulb, Domestic. **\$64.95**

**69229-04** Clear Lens, Amber Bulb, Domestic. **\$64.95**

**69228-04** Smoked Lens, Amber Bulb, Domestic. **\$64.95**

**Shown with:**

### CUSTOM AUXILIARY LAMP BRACKET HARDWARE KIT

Add Custom Passing Lamp Brackets to your Road King model.

**69235-04** **\$9.95**

Required to install the Custom Auxiliary Lighting Bracket Kit P/N 69227-04A on '94-later Road King models equipped with a Detachable Windshield.

**69234-04** **\$16.95**

Required to install the Custom Auxiliary Lighting Bracket Kit P/N 69227-04A on FLHRS models not presently equipped with a windshield, but wish to install a windshield at the same time or in the future.

## B. AUXILIARY LIGHTING KIT – ROAD KING CUSTOM

Add traditional style and function to the Road King® Custom with an Auxiliary Lighting Kit. Kit includes chrome lamp housings, tubular chrome mounting bracket, chrome triple tree mounting plates, windshield docking hardware, and all required wiring and installation hardware. All you need to add is your choice of bulb style. (Bulbs sold separately.)

**69289-05** **\$229.95**

Fits '04-later FLHRS models. (Will fit with windshields.)



**A. CUSTOM AUXILIARY LIGHTING BRACKET KIT – ELECTRA GLIDE (SHOWN WITH TURN SIGNAL KIT AND HARDWARE KIT)**



**A. CUSTOM AUXILIARY LIGHTING BRACKET KIT – ROAD KING (SHOWN WITH TURN SIGNAL KIT AND HARDWARE KIT)**



**B. AUXILIARY LIGHTING KIT – ROAD KING CUSTOM (SHOWN WITH CLEAR LENS OPTICS AUXILIARY BULBS)**

Notice: The prices appearing in this catalog are the manufacturer's suggested retail prices. Actual retail prices may vary.



C

C. ENGINE GUARD-MOUNTED FOG LAMPS

### C. ENGINE GUARD-MOUNTED FOG LAMPS

Uniquely styled halogen fog lamps feature a 55-watt bulb and clear lens with a faceted inner reflector. The beautifully polished and chrome-plated housings are designed to bolt easily onto most Harley-Davidson® front engine guards. Kit comes complete with a pair of fog lamps, fused harness, relay and switch.

**68913-98B \$164.95**

Fits most models equipped with 1-1/4" diameter Engine Guards. Will not fit '98-later FLTR models, '06-later VRSCR models equipped with Engine Guard, '04-later XL and XR models equipped with Engine Guard, '00-later Softail® models equipped with Nostalgic Engine Guard or Mustache Engine Guard. Will not fit Touring models equipped with Fairing Lower, Splash Shields, or Mustache Engine Guard, or any model equipped with Handlebar Reservoir Cover Set P/N 46098-98 or 46099-98.

### D. AUXILIARY LAMP BULB KITS

Available in 4 lens styles, these sealed beam bulbs are a direct replacement for Original Equipment or accessory Auxiliary Lighting Kits.

Fits models equipped with Original Equipment or accessory Auxiliary Lighting Kits. Sold in pairs.

#### 1. Smoked with Lens Optics

**68273-03A \$59.95**

#### 2. Clear Lens with Halogen Bulb

**68208-98A \$69.95**

#### 3. Clear with Lens Optics

**69294-05A \$49.95**

#### 4. Clear Lens and Vertical Reflector Optics

**68348-05 \$69.95**



D

D. AUXILIARY LAMP BULB KITS

### E. BAR & SHIELD LOGO AUXILIARY LAMP COVERS

Add a degree of protection and style to your auxiliary lighting with these slip-on Bar & Shield Lamp Covers. The vinyl covers hug the contours of the lamp, and help deflect bugs and dirt from the lamp trim ring for easy cleaning. The elastic bands and hooks hold the covers firmly in place. Kit includes right and left cover.

**67593-05 \$19.95**

Fits models with Original Equipment or accessory H-D Auxiliary Lighting Kits. Does not fit with Passing Lamp Visors.



E

E. BAR & SHIELD LOGO AUXILIARY LAMP COVERS

Notice: The prices appearing in this catalog are the manufacturer's suggested retail prices. Actual retail prices may vary.



# 634 LIGHTING

## Headlights – Housings

### A. BILLET HEADLAMP SHELL

Add style and substance to the front fork with this bullet-shaped Headlamp Shell. Manufactured from billet aluminum, this extended headlamp housing recesses the headlamp for a true custom appearance. The mirror-finish chrome surfaces and the close-fitting inner trim ring create the appearance of a one-piece design. Kit includes chrome-plated mounting hardware and a custom billet mount.

**67704-03** **\$329.95**

Fits '00-later FXST, FXSTB, FXSTC and FXSTD models, '99-'05 FXDWG models and '02-later VRSC™ models (except VRSCF) equipped with Installation Bracket P/N 68211-05. (Does not fit International models.)

### B. BULLET HEADLAMP KIT

Light the way to a custom look. This mirror-chrome Bullet Headlamp Kit features a high-tech deep drawn aluminum housing that is precision machined for a perfect contour and surface finish. The visor-style shell adds a unique profile to the bike's front end, and the complete kit includes a smooth lens lamp assembly with a replaceable halogen bulb.

Fits '96-later XL1200C, '98-later XL883C, '94-later FXDWG, '06-later FXD, FXDL, FXDC, FXDB, FXD35, FXDSE, FXDF, '99-'00 FXR2/3/4, '84-'99 FXSTC, '99-later FXST, FXSTB, FXSTC, '08-later FXCW/C and '00-'07 FXSTD models. Installation requires separate purchase of appropriate Headlamp Mounting System P/N 68595-06 or 69611-06.

**68593-06** 5-3/4" **\$329.95**

**69851-06** 4-1/2" **\$309.95**

#### Shown with:

#### HEADLAMP MOUNTING SYSTEM FOR BULLET HEADLAMP

Chrome-plated headlamp mounts are designed to position the Bullet Headlamp Kit in the proper location for specific vehicle applications. The mount is machined from solid steel for performance and durability, and is polished and plated for a superior custom look.

**68595-06** Short Mount. **\$41.95**

Fits '94-'05 FXDWG, '84-'99 FXSTC, '99-later FXST, FXSTB, FXSTC, '08-later FXCW/C and '00-'07 FXSTD models.

**69611-06** Tall Mount. **\$41.95**

Fits '96-later XL1200C, '98-later XL883C, '06-later FXD, FXDL, FXDC, FXDB, FXD35, FXDWG, FXDSE, FXDF and '99-'00 FXR2/3/4 models. Also fits '00-later Softail models equipped with Custom Inverted Front Fork Kit.



A. BILLET HEADLAMP SHELL



B. 5-3/4" BULLET HEADLAMP AND MOUNTING KIT



B. 4-1/2" BULLET HEADLAMP AND MOUNTING KIT

Notice: The prices appearing in this catalog are the manufacturer's suggested retail prices. Actual retail prices may vary.





**C. DUAL HEADLAMP KIT**

**C. DUAL HEADLAMP KIT**

First introduced on the Fat Bob® model, this unique Dual Headlamp housing adds a slimmed-down custom look to the Wide Glide® model's stretched front end. Complete kit includes headlamp housing, headlamp bulbs and mounting hardware.

Fits '06-'08 FXDWG models.

<b>69797-08</b>	Domestic.	<b>\$349.00</b>
<b>69802-08</b>	International.	<b>\$349.00</b>

**D. CHROME HEADLAMP HOUSING KIT**

Complete your custom transformation with this beautifully polished and chrome-plated headlamp housing. Manufactured from Original Equipment components, this chrome housing replaces the black headlamp shell. When combined with a headlamp trim ring or visor, this accessory is an economical alternative to billet-style headlamp housings.

**69620-04A** **\$64.95**

Fits '04-later XL models (except XL Custom). Also fits '09-later XR models, '02-'05 FXD, FXDL and FXDX models and '05 VRSCB models. Wiring is pre-installed with quick connectors for easy installation.

**E. CHROME HEADLAMP BRACKET**

Replace stock aluminum with this chrome-plated visor eyebrow, one part of a perfectly chromed front end.

**69709-00** **\$59.95**

Fits '92-later XL models (except XL Custom) and '93-'05 Dyna models (except FXDWG).

**F. CHROME HEADLIGHT COVER**

Cover the Original Equipment aluminum headlamp eyebrow with this polished and chrome-plated cover.

**67871-85TA** With Cutout. **\$19.95**

Fits '60-later XL models (except '96-later XL Custom), '91-'05 FXDL, '71-later FX and FXR models (except FXWG and FXST).

**67884-90TA** Without Cutout. (not shown) **\$19.95**

Fits XL models (except '96-later XL Custom) and FXR models with indicator lights mounted in speedometer bracket and '91-'05 Dyna models (except FXDWG).

**G. CONTOURED HEADLAMP TRIM RING**

Add an integrated look to your headlamp. The Contoured Headlamp Trim Ring, introduced on the Screamin' Eagle® Road King® model, is designed to visually reduce the space between the headlamp bulb and the headlamp housing for a sleek, custom style. The bright chrome finish matches the headlamp housing for a factory original look.

**69604-03** **\$34.95**

Fits '83-later Touring models (except Tour Glide, Road Glide® and Trike), and '86-later FL Softail® models with Headlight Nacelle P/N 67907-96B.



**D. CHROME HEADLAMP HOUSING KIT (SHOWN WITH HEADLAMP TRIM RING)**



**E. CHROME HEADLAMP BRACKET**



**F. CHROME HEADLIGHT COVER**



**G. CONTOURED HEADLAMP TRIM RING**

Notice: The prices appearing in this catalog are the manufacturer's suggested retail prices. Actual retail prices may vary.

# 636 LIGHTING

## Headlights – Trim Rings

### A. TRIM RING COLLECTION

This chrome-plated Headlamp Trim Ring extends forward, giving the headlamp assembly a "frenched" look reminiscent of classic hot rod car designs by recessing the headlamp and adding the appearance of depth. Functions as a direct replacement for the Original Equipment trim ring, except when used with P/N 69627-99, where it easily installs over the Original Equipment trim ring. (Does not fit with Accessory Headlamp Visor or Passing Lamp Visor.)

**1. 69627-99** Headlamp. **\$36.95**  
Fits '83-later Touring models (except Tour Glide™ and Road Glide®). Fits '94-later FLHR models and '86-later FL Softail® models with Chrome Headlight Nacelle P/N 67907-96B. (Does not fit with Fairing Bra P/N 57800-00.)

**2. 69622-99B** Passing Lamp. **\$49.95**  
Fits '62-later models equipped with Original Equipment or accessory Auxiliary Lamp Kits. (sold in pairs)

**3. 69740-01** Turn Signal – Flat Lens. **\$39.95**  
Fits flat lens turn signals on front and rear of '88-later Touring (except FLHX, FLHRS, '04-later FLTR and Trike), rear of '94-later FLSTC, '94-'97 FLSTN and '06 FLST models. Also fits FL Softail models with front Turn Signal Relocation Kit P/N 68413-99 or 68412-99.

**69626-99** Headlamp. **\$36.95**  
Fits '94-later FLST, FLSTC, FLSTF and FLSTN models.

**69623-99A** Headlamp. **\$31.95**  
Fits '94-99 FXSTC, '94-later FXLR, FXST, FXSTB, '94-later Dyna® models (except FXDF), and '04-later XL883, XL1200L, XL883L, XL883N, XL883R, XL1200N and XL1200R models and '05 VRSCB models. Also fits '08-later FLSTSB.

**69624-99A** Headlamp. **\$31.95**  
Fits '07-later FXSTC, '96-later XL1200C, XL883C, '99 FXR, '93-later FXSTS, '95-'97 FXSTSB, '97-'03 FLSTS, '05-later FLSTSC, and '00-'07 FXSTD.

**69972-08** Headlamp. **\$31.95**  
Fits '08-later FXCW and FXCWC models.



**A. TRIM RING COLLECTION  
(HEADLAMP, PASSING LAMP AND TURN SIGNAL TRIM RINGS) – ROAD KING**



**A. HEADLAMP TRIM RING – SOFTAIL STANDARD**



**A. HEADLAMP TRIM RING – DYNA LOW RIDER**



**A. HEADLAMP TRIM RING – XL883 HUGGER**



**A. HEADLAMP TRIM RING – FXCWC**

*Notice: The prices appearing in this catalog are the manufacturer's suggested retail prices. Actual retail prices may vary.*



B

## B. VISOR STYLE TRIM RING COLLECTION

These chrome-plated Visor Style Trim Rings recess the headlamp into the housing, and add a traditional “eyebrow” design to the headlamp shell. The trim ring stretches the profile of the bike for a long, lean appearance. Add matching Visor Style Passing Lamp and Turn Signal Trim Rings for a true custom look.

**1. 69733-05** Headlamp. **\$41.95**

Fits '83-later Touring models (except Tour Glide™ and Road Glide®). Fits '94-later FLHR models and '86-later FL Softail® models with Chrome Headlight Nacelle P/N 67907-96B. (Does not fit with Fairing Bra P/N 57800-00.)

**2. 69732-05** Passing Lamp. **\$54.95**

Fits '62-later models equipped with Original Equipment or accessory Auxiliary Lamp Kits. (sold in pairs)

**3. 69749-05** Turn Signal – Flat Lens. **\$44.95**

Fits flat lens turn signals on front and rear of '88-later Touring (except FLHX, FLHRS, '04-later FLTRI and Trike), rear of '94-later FLSTC, '94-'97 FLSTN and '06 FLST models. Also fits FL Softail models with front Turn Signal Relocation Kit P/N 68413-99 or 68412-99.

**69734-05** Headlamp. **\$41.95**

Fits '94-later FLST, FLSTC, FLSTF, and FLSTN models.

**69735-05** Headlamp. **\$36.95**

Fits '94-'99 FXSTC, '94-later FXLR, FXST, FXSTB models, '94-later Dyna® models (except FXDF), and '04-later XL883, XL883L, XL883N, XL1200L, XL1200N, XL883R and XL1200R models and '05 VRSCB models. Also fits '08-later FLSTSB.

**69738-05** Headlamp. **\$36.95**

Fits '07-later FXSTC, '96-later XL1200C, XL883C, '99 FXR, '93-later FXSTS, '95-'97 FXSTSB, '97-'03 FLSTS, '05-later FLSTSC, and '00-'07 FXSTD.

**69973-08** **\$36.95**

Fits '08-later FXCW and FXCWC models.

**B. VISOR STYLE TRIM RING COLLECTION  
(HEADLAMP, PASSING LAMP AND TURN SIGNAL TRIM RINGS) – ROAD KING**



B

**B. VISOR STYLE TRIM RING – SOFTAIL DELUXE**



B

**B. VISOR STYLE TRIM RING – XL/DYNA**



B

**B. VISOR STYLE TRIM RING – XL CUSTOM**



B

**B. VISOR STYLE TRIM RING – FXCWC**

# 638 LIGHTING

## Headlights – Visors

### A. THE SKULL COLLECTION LAMP VISORS

Add a little attitude to your ride. Styled to complement Harley-Davidson Skull accessory items, the menacing raised skull with black-filled eyes leaps from a field of chrome. This complete collection of Lamp Visors dresses your bike for a true custom look.

**69793-07** Headlamp. **\$24.95**  
Fits 7" Headlamp. (Does not fit with Accessory Headlamp Trim Rings.)

**69794-07** Headlamp. **\$21.95**  
Fits 5-3/4" Headlamp. (Does not fit Springer, XL883C, XL1200C, or models with Accessory Headlamp Trim Rings.)

**69795-07** Passing Lamp. **\$26.95**  
Fits all Passing Lamps. ('87-later models require Passing Lamp Trim Rings P/N 68775-93TA.) (Does not fit with Passing Lamp Trim Rings P/N 69622-99B or 69732-05.) (pair)

**69791-07** Flat Lens Turn Signal. **\$24.95**  
Fits '86-later FLHR (except FLHRS), FLHT, FLT, and FLSTC (front) models and '86-'01 FLST models. (pair)

**69792-07** Flat Lens Turn Signal. **\$24.95**  
Fits '88-'96 FLTC (front) and '86-later FLHR (except FLHRS), FLHT, FLT, FLSTC, and FXRT (rear) models and '86-'01 FLST models. (pair)

### B. CLASSIC CHROME LAMP VISORS

**67752-77T** Headlamp. **\$14.95**  
Fits 7" Headlamp. Use Installation Kit P/N 67761-96. (Does not fit with Accessory Headlamp Trim Rings.)

**67750-88T** Headlamp. **\$15.95**  
Fits 5-3/4" Headlamp including '05 VRSCB models. (Does not fit Springer, XL883C and XL1200C models or models with Accessory Headlamp Trim Rings.)

**67783-78T** Passing Lamp. **\$18.95**  
Fits all Passing Lamps ('87-later models require Passing Lamp Trim Rings P/N 68775-93TA.) (Does not fit with Passing Lamp Trim Rings P/N 69622-99B or 69732-05.) (pair)

**67734-88T** Turn Signal. **\$17.95**  
Fits '86-later FLHR (except FLHRS), FLHT, FLT, and FLSTC (front) models and '86-'01 FLST models. (pair)

**67737-88T** Turn Signal. **\$17.95**  
Fits '88-'96 FLTC (front) and '86-later FLHR (except FLHRS), FLHT, FLT, FLSTC, and FXRT (rear) models and '86-'01 FLST models. (pair)

#### Also available:

#### ROAD KING® HEADLAMP VISOR MOUNTING KIT

Allows 7" headlamp visors to be mounted on Road King motorcycle.

**67761-96** **\$4.95**  
Fits '94-later FLHR. Visor and Trim Ring not included.

#### PASSING LAMP TRIM RINGS

Replaces Original Equipment P/N 68725-62. Required for proper installation of H-D Passing Lamp Visors on '87-later models (except FXSTD).

**68775-93TA** **\$23.95**



A. THE SKULL COLLECTION LAMP VISORS



B. CLASSIC CHROME LAMP VISORS

Notice: The prices appearing in this catalog are the manufacturer's suggested retail prices. Actual retail prices may vary.



# LIGHTING 639

Headlights – Visors



C

C. "EAGLE WING" LOGO LAMP VISORS

## C. "EAGLE WING" LOGO LAMP VISORS

<b>67791-91T</b>	Headlamp. Fits 7" Headlamp. (Does not fit with Accessory Headlamp Trim Rings.)	<b>\$27.95</b>
<b>67751-91T</b>	Headlamp. Fits 5-3/4" Headlamp. (Does not fit Springer, XL883C, XL1200C models or models with Accessory Headlamp Trim Rings.)	<b>\$26.95</b>
<b>67796-91T</b>	Passing Lamp. Fits Passing Lamps. ('87-later models require Passing Lamp Trim Rings P/N 68775-93TA.) (Does not fit with Passing Lamp Trim Rings P/N 69622-99B or 69732-05.) (pair) (not shown)	<b>\$29.95</b>
<b>67913-95T</b>	Sport Turn Signal. Fits '86-'01 XL, FXR, Softail®, and '91-'01 Dyna® models (except '01 FXDX, FXDXT, FXSTD, FLST and FXRT models.) (pair)	<b>\$34.95</b>
<b>68103-96</b>	Flat Lens Turn Signal. Fits models equipped with Flat Lens Turn Signal Kits P/N 68431-95 and P/N 68432-95. (pair)	<b>\$25.95</b>
<b>67735-91T</b>	Flat Lens Turn Signal. Fits '86-later FLHR (except FLHRS), FLHT, FLT, and FLSTC (front) models and '86-'01 FLST models. (pair)	<b>\$29.95</b>
<b>67738-91T</b>	Flat Lens Turn Signal. Fits '88-'96 FLTC (front) and '86-later FLHR (except FLHRS), FLHT, FLT, FLSTC, and FXRT (rear) models and '86-'01 FLST models. (pair)	<b>\$29.95</b>

## D. FREIGHT TRAIN CHROME HEADLIGHT NACELLE

If the chrome from this nacelle seems to reflect the image of the 1960s FL models, that's because the spirit of the past is built right in. Bold locomotive styling adds visual strength to the bike's profile, and stretches the rider's view to the horizon when looking over the headlamp. Coupled with the separate purchase of the Chrome Nacelle Hardware Kit P/N 67897-96B, the Nacelle fits with an existing H-D® windshield and/or passing lamps. Kit includes hardware required for installation of the Nacelle with a detachable windshield without passing lamps. Separate Hardware Kit is required when installing Nacelle with passing lamps or rigid mount windshield. For an even bolder look, add a Headlamp Trim Ring P/N 69627-99 or 69733-05.

<b>67907-96C</b>	Fits '86-later FLST, FLSTF, FLSTFB and FLSTC models. '07-later FLSTF and FLSTFB requires separate purchase of Riser Kit P/N 56789-05. '09-later FLSTC requires separate purchase of Riser Kit P/N 46809-09.	<b>\$399.95</b>
------------------	--	-----------------

### Also available:

<b>RISER KIT FOR FREIGHT TRAIN HEADLIGHT NACELLE</b>	Required for installation of Freight Train Headlamp Nacelle.	
<b>46809-09</b>	Fits '09-later FLSTC models equipped with Freight Train Headlight Nacelle Kit P/N 67907-96C.	<b>\$59.95</b>
<b>56789-05</b>	Fits '07-later FLSTF and FLSTFB models equipped with Freight Train Headlight Nacelle Kit P/N 67907-96C.	<b>\$119.95</b>



NEW

D

D. FREIGHT TRAIN CHROME HEADLIGHT NACELLE

Notice: The prices appearing in this catalog are the manufacturer's suggested retail prices. Actual retail prices may vary.

# 640 LIGHTING

## Turn Signals

### A. MINI-BULLET LED TURN SIGNAL KIT

Take a new direction in lighting. Bright, fast-acting LED turn signal elements are housed in a mirror chrome-plated mini bullet housing for definitive style. The compact turn signals tuck in tight to the hand controls and the small size trims the rear profile for a custom look. Available with clear, smoked or amber lenses, kit includes front and rear signals and the required controller. Vehicle-specific mounting kit sold separately. NOTE: These signals were designed to meet European lighting requirements and are ECE approved. As part of the ECE requirements, the front turn signals do not operate as running lamps; they only operate as directional lamps. These turn signals do not conform to DOT requirements for North America because the lens diameter is smaller than DOT minimum requirements. The turn signal diameter is too small.

Fits '02-later VRSC (except VRSCF), '08-later XR, '04-later XL (except XL883N and XL1200N), '02-later Dyna® (except '09-later FXDWG and FXDB), '00-'07 FXSTD, and '02-later FXST, FXSTB, FXSTC, FXSTS, FLSTF, FLSTS, FLSTSB and FLSTSC models. Installation requires separate purchase of appropriate Mounting Kit. Intended for use on HDI models only.

**69474-07** Chrome Housing, Amber Lens. **\$214.95**

**69475-07** Chrome Housing, Smoked Lens. **\$214.95**

**69476-07** Chrome Housing, Clear Lens. **\$214.95**

Fits '02-later VRSC™ (except VRSCF) and '08-later XR models. Installation requires separate purchase of appropriate Mounting Kit. Intended for use on HDI models only.

**68863-08** Black Housing, Smoked Lenses. **\$214.95**

### MOUNTING KIT FOR MINI-BULLET LED TURN SIGNALS

Kit includes the wiring harness, mounting brackets, and hardware required to install Mini-Bullet Turn Signals on a specified model.

**69593-08A** Chrome. **\$99.95**

Required for installation of Mini-Bullet LED Turn Signal Kits P/N 69474-07, 69475-07 or 69476-07 on '02-later VRSC models.

**69590-07** Chrome. **\$99.95**

Required for installation of Mini-Bullet LED Turn Signal Kits P/N 69474-07, 69475-07, or 69476-07 on '04-later XL models.

**69591-07** Chrome. **\$99.95**

Required for installation of Mini-Bullet LED Turn Signal Kits P/N 69474-07, 69475-07, or 69476-07 on '02-later Dyna models (except '09-later FXDWG and FXDB).

**69592-07** Chrome. **\$99.95**

Required for installation of Mini-Bullet LED Turn Signal Kits P/N 69474-07, 69475-07, or 69476-07 on '00-'07 FXSTD models.

**70492-07** Chrome. **\$99.95**

Required for installation of Mini-Bullet LED Turn Signal Kits P/N 69474-07, 69475-07, or 69476-07 on '02-later FXST, FXSTB, FXSTC, FXSTS, FLSTF, FLSTS and FLSTSC models.

**69926-08** Black. **\$89.95**

Required for installation for Mini-Bullet LED Turn Signal Kits P/N 68863-08 on '08-later XR models.



A. MINI-BULLET LED TURN SIGNAL KIT – REAR SMOKED LENSES



A. MINI-BULLET LED TURN SIGNAL KIT – FRONT AMBER LENS



A. MINI-BULLET LED TURN SIGNAL KIT – BLACK

Notice: The prices appearing in this catalog are the manufacturer's suggested retail prices. Actual retail prices may vary.



B

**B. FLAMED TURN SIGNALS – FRONT, SMOKED**



B

**B. FLAMED TURN SIGNALS – REAR, SMOKED**



B

**B. FLAMED TURN SIGNALS**



C

**C. BULLET STYLE TURN SIGNAL KIT**

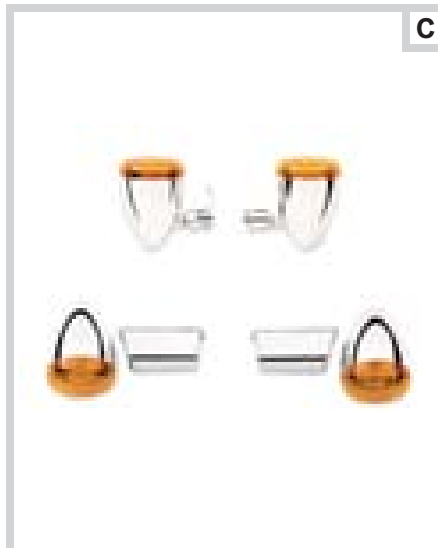

C

**C. BULLET STYLE TURN SIGNAL KIT**

## B. FLAMED TURN SIGNALS

Turn up the heat on your custom ride. The mirror-chrome visor-style turn signals feature a raised flame design that flows across the surface. Available with amber or smoked lenses, the kit includes both front and rear turn signals and wiring.

Fits '02-later VRSC™ models (except VRSCR and VRSCF). Installation of front turn signals requires separate purchase of Turn Signal Relocation Kit P/N 57205-05. Installation of rear turn signals requires separate purchase of Turn Signal Installation Kit P/N 69895-08. Also fits '05-'06 VRSCSE/2 models with Original Equipment turn signal mounts.

Fits '02-later XL models (except XL883N and XL1200N). Installation of front turn signal requires separate purchase of Directional Relocation Kit P/N 68517-94A or 68266-03.

Fits '01-'02 FXDWG2/3 and '02-later Dyna® models (except FXDXT, 09-later FXDB and FXDWG). Also fits '07-'08 FXDSE/2, '08-later FXDF and FXDFSE models with Original Equipment turn signals. Installation of front turn signals requires separate purchase of model-specific Turn Signal Relocation Kit P/N 68517-94A, 68564-06, 68952-98, 58742-05, 68266-03 or 58350-96 depending on year and model.

Fits '02-later FXSTB, '03 FXSTDSE, '07-'08 FXSTSSE/2, '05-'06 FLSTFSE/2 and '05-'07 FLSTS/C models with Original Equipment turn signal mounts. Fits '00-later FXST, FXSTC and FXSTD models. Installation of front turn signal requires separate purchase of model-specific Directional Relocation Kit P/N 68952-98, 58742-05, 68266-03 or 58350-96 depending on year and model. Fits '02-later FLSTF models. Installation of front turn signal requires separate purchase of Turn Signal Relocation Kit P/N 68266-03.

<b>69844-08</b>	Amber – Domestic.	<b>\$149.95</b>
<b>69945-08</b>	Smoked – Domestic.	<b>\$149.95</b>
<b>69845-08</b>	Amber – HDI.	<b>\$149.95</b>
<b>69960-08</b>	Smoked – HDI.	<b>\$149.95</b>

**Also available:**

### REAR FLAMED TURN SIGNAL MOUNTING KIT FOR VRSC MODELS

Installs the rear turn signals from the Flamed Turn Signal Kits onto VRSC models.

**69895-08** **\$59.95**

Required for installation of Rear Flamed Turn Signals P/N 69844-08, 69845-08, 69945-08 or 69960-08 on '02-later VRSC models (except VRSCF). (Not required for '05 VRSCSE and '06 VRSCSE2 models.)

## C. BULLET STYLE TURN SIGNAL KITS

Add a radical touch to your bike with these Bullet Style Turn Signals. Inspired by the Softail® Deuce™ motorcycle, this reflector-optic Bullet Turn Signal Kit gives your bike a whole new attitude. Kit includes housings, lenses, and supports.

**68005-99** **\$149.95**

Fits '00-'01 Softail® models (except FLSTC), '90-'01 Sportster® models and '91-'01 Dyna models. Will not fit with XL Saddlebag P/Ns 90342-98A or 90598-96B. (Stock on '01 FXDX and FXDXT and '00-later FXSTD.)

**68007-99** **\$149.95**

Fits '88-'99 Softail models (except FLSTC).

Notice: The prices appearing in this catalog are the manufacturer's suggested retail prices. Actual retail prices may vary.

# 642 LIGHTING

## Turn Signals

### A. CUSTOM TOURING FRONT BULLET TURN SIGNAL KIT

Add the lean, stripped-down look of the FLHX models to your Electra Glide® or Road King® motorcycle. Complete kit replaces the Original Equipment passing lamps and flat lens turn signal mounts with streamlined bullet-style turn signals. The chrome-plated brackets serve as stylized mounting points for the turn signals, and conceal the wiring for a clean, custom appearance. Kit includes amber lenses and clear bulbs.

Fits '94-later Road King® models. Will not fit models equipped with Non-Vented Fairing Lower.

**69577-06** Domestic. **\$149.95**

Fits '96-later FLHT and FLHTC, and '05-later FLHTCU, FLHTK and FLHTCUTG models. Will not fit models equipped with Non-Vented Fairing Lower.

**69492-05** Domestic. **\$129.95**

### B. BULLET STYLE TURN SIGNAL KIT

Streamline the styling by replacing the front and rear flat lens turn signal lamps with sleek bullet signals. The bullet-shaped housings attach to the Original Equipment turn signal mounting brackets. The kit includes two front and two rear turn signal assemblies and the necessary hardware for installation.

Fits '94-later FLHT, FLHTC, FLHTCU, FLHR, FLHRC models (except Trike), '98-'03 FLTR models and '96-later FLSTC, '93-'96 FLSTN models.

**69147-03** **\$129.95**

Clear Lens and Amber Bulb, Domestic.

**69153-03** **\$129.95**

Smoked Lens and Amber Bulb, Domestic.

**69063-03** **\$129.95**

Amber Lens and Clear Bulb, Domestic.

#### Also available:

### BULLET STYLE TURN SIGNAL CONVERSION KIT – AUXILIARY LAMP BAR MOUNTED

Add sleek bullet style front turn signals to your auxiliary lamp-equipped Fat Boy® model. This kit only includes the 2 bullet-style turn signal housings and 2 mounting brackets that allow the signals to be mounted under the auxiliary lamps. Simply replace the handlebar-mounted signals with the auxiliary lamp mount housings, and re-install the Original Equipment bulbs and lenses.

Fits '02-later FLSTF and '06 FLST models equipped with Auxiliary Lamp Kit P/N 69287-07.

**69079-04** Without Lenses, Domestic. **\$64.95**

### C. CHROME FRONT TURN SIGNAL MOUNT KIT

Chrome left and right turn signal mounting bracket with swivel adjustment. Fits models equipped with handlebar mounted bullet front turn signals.

**68266-03** **\$64.95**

Fits XL (except '04-later XL), Dyna® and Softail® models equipped with handlebar mounted bullet-style turn signals. Stock on '05-later FLSTSC models and '10 FXDWG.

### D. CHROME TURN SIGNAL SWIVEL ASSEMBLY KIT

Add a subtle chrome detail to match your own chrome accessories with this swivel kit, a durable stylish replacement for the stock zinc-plated swivel.

**68185-00** **\$19.95**

Fits '88-'03 XLH883, XLH883 Hugger®, XL1200S, XL1200C; '88-later FXR, FXRS, FXLR; '91-'08 FXDWG, '91-later FXD, FXDL, FXDX and FXDXT; '88-later FXSTC, FXSTS, FLSTF, FXST, FXSTB, FXSTD, FXSTSB and '97-'03 FLSTS models. (Does not fit with Turn Signal Relocation Kits or '03 FXSTDSE or '03 FLHRSEI2.)



**A. CUSTOM TOURING FRONT BULLET TURN SIGNAL KIT – ELECTRA GLIDE**



**A. CUSTOM TOURING FRONT BULLET TURN SIGNAL KIT – ROAD KING**



**B. BULLET STYLE TURN SIGNAL KIT – FRONT SMOKED LENSES**



**B. BULLET STYLE TURN SIGNAL KIT – REAR SMOKED LENS**



**C. CHROME FRONT TURN SIGNAL MOUNT KIT**



**D. CHROME TURN SIGNAL SWIVEL ASSEMBLY KIT**

*Notice: The prices appearing in this catalog are the manufacturer's suggested retail prices. Actual retail prices may vary.*





E

**E. FRONT DIRECTIONAL RELOCATION KIT**



NEW

F

**F. FRONT DIRECTIONAL RELOCATION KIT – GLOSS BLACK**

**E. FRONT DIRECTIONAL RELOCATION KIT**

This kit includes the required hardware and wiring to move the front directional from the handlebar to the lower triple clamp.

**68517-94A** **\$28.95**  
Fits '88-later XL and '91-'05 Dyna® models (except FXDWG and FXDXT).

**F. FRONT DIRECTIONAL RELOCATION KIT – GLOSS BLACK**

Complete the blacked-out look. This kit includes the required hardware and wiring to move the front directional lamps from the handlebar to the lower triple clamp.

**68643-09** **\$28.95**  
Fits '88-later XL and '91-'05 Dyna models (except FXDWG and FXDXT).

**G. TURN SIGNAL RELOCATION KIT**

Styled to blend with the lower triple clamp. This chrome-plated Turn Signal Relocation Kit moves the Original Equipment bullet-style turn signals from the handlebar to the front fork for a clean, streamlined look. Kit includes left and right mounting stalk and all required hardware.

**69433-08** **\$64.95**  
Fits '08-later Dyna models (except FXDSE/2).

**68564-06** **\$28.95**  
Fits '06-'07 Dyna models (except FXDSE/2).

**58742-05** **\$44.95**  
Fits '93-'05 FXDWG, '86-later FXST, FXSTC, FXSTB, and '00-'07 FXSTD models.

**H. FRONT TURN SIGNAL RELOCATION KIT FOR FX SOFTAIL® AND DYNA® WIDE GLIDE® MODELS**

Allows the relocation of the front turn signal from the handlebar to the front forks, paving the way for use of a variety of custom and flat profile handlebars.

**68952-98** **\$59.95**  
Fits '84-later FXST, FXSTB, FXSTC, and '93-'05 FXDWG models.



G

**G. TURN SIGNAL RELOCATION KIT – '08-LATER DYNA**



G

**G. TURN SIGNAL RELOCATION KIT – '06-'07 DYNA**



G

**G. TURN SIGNAL RELOCATION KIT – '06-'07 DYNA MODELS**



H

**H. FRONT TURN SIGNAL RELOCATION KIT FOR FX SOFTAIL AND DYNA WIDE GLIDE MODELS**

Notice: The prices appearing in this catalog are the manufacturer's suggested retail prices. Actual retail prices may vary.

# 644 LIGHTING

## Turn Signals

### A. NARROW MOUNTING KIT FOR REAR TURN SIGNALS

Tuck the rear turn signals close to the fender struts. These sleek chrome-plated turn signal mounts move the Original Equipment bullet turn signals 1 inch closer to the rear fender for a custom narrow profile.

**69820-06** **\$36.95**

Fits '02-later FXD, FXDC, FXDL, FXDX, FXD35, '07-'08 FXDB, '02-'05 FXDWG models, '02-later FLSTF, FLSTS, FLSTSC models, and '02-'05 FXST, FXSTS, and FXSTB models. Will not fit with saddlebags.

### B. REAR TURN SIGNAL RELOCATION KIT

Tuck the rear turn signals close to the fender struts. The sleek chrome-plated brackets work with Original Equipment bullet turn signals to add a flowing touch to the fender.

**90395-00** Fits '00-'07 FXSTD models. **\$39.95**

### C. LIGHTED CHROME DIRECTIONAL BAR\*

Chrome-plated bar provides a custom look with complete integration. LED light pods provide auxiliary lighting for both brake and tail light. NOTE: Must only be used as auxiliary lighting.

**68143-98A** **\$129.95**

Fits '86-later FLSTC, '93-'96 FLSTN; '91-'08 FLT, FLHT, FLHS, FLHR (except FLHRS and FLHX), '09-later FLHRC, FLHTC, FLHTCU, FLHTK, and '98-'03 FLTR models. Directional Lamps not included.

### D. BULLET REAR TURN SIGNAL BAR KIT

Give your bike a new sporting attitude with the Bullet Turn Signal Kit. The chrome-plated bar and bullet turn signal housings provide a custom look, and the narrow profile places the signal lamps between the saddlebag and the rear fender for a sleek appearance.

Fits '99-'08 Touring models (except FLHX), '09-later FLHRC, FLHTC, FLHTCU, FLHTK and '99-'08 FLST and FLSTC Softail® models. Will not fit FLSTC models with '00-later Original Equipment Heritage Classic Saddlebags.

**68615-04** Domestic. **\$149.95**

**68617-04** International. **\$149.95**

### E. CHROME LICENSE PLATE/LIGHT KIT\*

Tubular license plate housing includes dual filament (running lights/brake) and supplementary rear lights. Includes all mounting hardware. These lights should be installed as supplemental only.

**68230-97B** **\$194.95**

Fits '97-'08 FLHTC and FLHTCU models. Also fits '97-'08 FLHT, Road King® (except FLHRS) and '98-'03 FLTR models equipped with Four-Channel Luggage Rack P/N 53341-97A.



A. NARROW MOUNTING KIT FOR REAR TURN SIGNALS



B. REAR TURN SIGNAL RELOCATION KIT



C. LIGHTED CHROME DIRECTIONAL BAR



D. BULLET REAR TURN SIGNAL BAR KIT



E. CHROME LICENSE PLATE/LIGHT KIT



**\*WARNING:** Disconnecting your DOT requirement brake lamp could reduce your visibility to others and result in death or serious injury.

NOTE: It is possible to overload your motorcycle's charging system by adding too many electrical accessories. If your combined electrical accessories operating at any one time consume more electrical current than your vehicle's charging system can produce, the electrical consumption can discharge the battery and cause vehicle electrical system damage. Ask your dealer for advice about the amount of current consumed by additional electrical accessories.

Notice: The prices appearing in this catalog are the manufacturer's suggested retail prices. Actual retail prices may vary.



Rear Directional Bar 13"

Narrow Bar 10"

F. CHROME REAR DIRECTIONAL MOUNTING BAR



F. NARROW CHROME DIRECTIONAL BAR



G. AUXILIARY BRAKE LIGHT/RUNNING LIGHT/TURN SIGNAL CONVERSION KIT – FLAT LENS STYLE



G. AUXILIARY BRAKE LIGHT/RUNNING LIGHT/TURN SIGNAL CONVERSION KIT – FLAT LENS STYLE



G. AUXILIARY BRAKE LIGHT/RUNNING LIGHT/TURN SIGNAL CONVERSION KIT – BULLET LENS STYLE

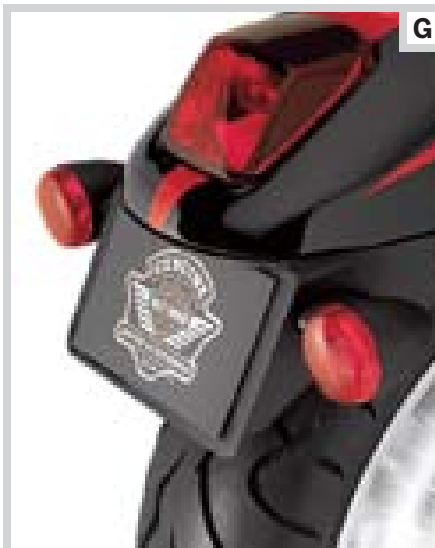

G. AUXILIARY BRAKE LIGHT/RUNNING LIGHT/TURN SIGNAL CONVERSION KIT – BULLET LENS STYLE – VRSC

## F. CHROME REAR DIRECTIONAL MOUNTING BAR

Rear directional mounting bar is cast from a very durable zinc-aluminum alloy, has been drilled and tapped for 5/16 inch mounting fasteners and is chrome-plated for a beautiful finish. (Lamp assemblies and mounting fasteners not included.)

**68510-74C** \$73.50

Fits '86-later FLST, FLSTC, '93-'96 FLSTN, and '74-'84 FLH models. (Does not fit FLSTS.)

### Shown with:

#### NARROW CHROME DIRECTIONAL BAR

Enhance the rear profile of your Softail® or Touring model with this Narrow Chrome Directional Bar that enhances the visual proportions of the bike. At 10 inches wide, this die-cast, chrome-plated bar is 3 inches shorter than the stock bar and features the same great quality.

**68611-98** \$48.95

Fits '86-later FLST, FLSTC and '93-'96 FLSTN models and '91-'08 Touring models (except '04-'08 FLHRS and FLTR models). Also fits '09-later FLHRC, FLHTC, FLHTCU and FLHTK models. (Does not fit with Flat Lens Turn Signal Module P/N 91699-99A.)

## G. AUXILIARY BRAKE LIGHT/RUNNING LIGHT/TURN SIGNAL CONVERSION KIT

Turn signal module adds an auxiliary brake light and running light function to your existing turn signals for auxiliary rear lighting. Red lenses glow when the headlamp is on, and increase in intensity when brakes or turn signals are activated. Easy-to-install, the kit simply plugs into your existing wiring harness. Red turn signal lenses are included. Meets DOT requirements.

**69461-06A** Flat Lens Style. \$59.95

Fits '96-later Softail® models and '97-'08 Touring models (except FLHX) equipped with Original Equipment flat lens style turn signals. Also fits '09-later FLHRC, FLHTC, FLHTCU and FLHTK models. (Does not fit with Narrow Chrome Directional Bar P/N 68611-98.)

**69465-06** Bullet Lens Style. \$59.95

Fits '00-'07 FXSTD models. (Does not fit with saddlebags.)

**69462-06A** Bullet Lens Style. \$59.95

Fits '02-'03 XL, '02-later Dyna® (except FXDXT and '09-later FXDB and FXDWG), and '02-later Softail (except FXSTD/I) models with stock bullet-style turn signals. (NOTE: Not intended for use on '04-later FLHX, FLHRS, FLTR, FLHTCSE models, '05-later FLSTN models or models equipped with Bullet Turn Signal Bar Kit P/N 68615-04 or 68617-04. If installed on these models, the system will function properly but will not meet the DOT minimum separation requirements for a red tail light to red turn signal.)

**69463-06** Bullet Lens Style. \$59.95

Fits '04-later XL models (except XL883N and XL1200N).

**69580-07** Bullet Lens Style. \$59.95

Fits '07-later VRSC models equipped with stock bullet turn signals.

**69464-06** Bullet Lens Style. \$59.95

Fits '02-'06 VRSC models equipped with stock bullet turn signals.

NOTE: It is possible to overload your motorcycle's charging system by adding too many electrical accessories. If your combined electrical accessories operating at any one time consume more electrical current than your vehicle's charging system can produce, the electrical consumption can discharge the battery and cause vehicle electrical system damage. Ask your dealer for advice about the amount of current consumed by additional electrical accessories.

Notice: The prices appearing in this catalog are the manufacturer's suggested retail prices. Actual retail prices may vary.

# 646 LIGHTING

## Turn Signals

### A. TURN SIGNAL LENS KIT – SMOKED AND CLEAR

Add a unique touch to your bike. These Turn Signal Lens Kits replace the amber lenses for a clean front and rear appearance. Available in clear and smoked versions, the kit includes 4 lenses and 4 amber bulbs. Meets DOT requirements.

Fits '86-later models with Flat Turn Signal Lenses.

<b>69307-02</b>	Clear – Flat Lens.	<b>\$37.95</b>
<b>69308-02</b>	Smoked – Flat Lens.	<b>\$37.95</b>

Fits '00-later models (except VRSC™, XL883N and XL1200N) with Bullet Turn Signals. Will also fit V-Rod® models equipped with Chrome Turn Signal Kits P/N 69374-05 or 69065-05.

<b>69303-02</b>	Clear – Bullet Lens.	<b>\$37.95</b>
<b>69304-02</b>	Smoked – Bullet Lens.	<b>\$37.95</b>

Fits '02-later VRSC models (except VRSCF). Will not fit V-Rod models equipped with Chrome Turn Signal Kits P/N 69374-05 or 69065-05. (See P/N 69303-02 and 69304-02.)

<b>69315-02</b>	Smoked – Bullet Lens.	<b>\$37.95</b>
-----------------	-----------------------	----------------

Fits '01-earlier models equipped with dome lens style turn signals. This kit includes 2 lenses and 2 amber bulbs. Meets DOT requirements. (not shown)

<b>69306-02</b>	Smoked – Dome Lens.	<b>\$37.95</b>
-----------------	---------------------	----------------

Fits '08-later FXCW, FXCWC, XL883N and XL1200N models.

<b>69226-09</b>	Clear.	<b>\$19.95</b>
<b>69208-09</b>	Smoked.	<b>\$19.95</b>

### B. LED FENDER TIP LENS

Add a custom look to the fender tip lens on your bike. Clear or smoked lenses replace the Original Equipment lenses, and self-contained LED lamp replaces the bulb.

#### Front Fender

Fits '80-later FLHT, FLT, FLHS, FLHR '86-'08 FLSTC and '93-'96 FLSTN models. Does not fit models with clean front fender.

<b>59337-09</b>	Clear.	<b>\$18.95</b>
<b>59338-09</b>	Smoked.	<b>\$18.95</b>

#### Rear Fender (not shown)

Fits '80-'08 FLHT, FLT, FLHS, FLHR '86-'08 FLSTC and '93-'96 FLSTN models.

<b>59448-09</b>	Clear.	<b>\$18.95</b>
<b>59336-09</b>	Smoked.	<b>\$18.95</b>

#### Front and Rear Fender

Fits '80-'08 FLHT, FLT, FLHS, FLHR, models, '86-'08 FLSTC, and '93-'96 FLSTN models. Does not fit FLST, FLSTS, FLSTSB, FLSTSC, FLHRS, FLHX and FLTR models, or models equipped with clean front fender.

<b>59380-05</b>	Smoked.	<b>\$39.95</b>
<b>59381-05</b>	Clear.	<b>\$39.95</b>



A. TURN SIGNAL LENS KIT – FLAT LENS, CLEAR



A. TURN SIGNAL LENS KIT – FLAT LENS, SMOKED



A. TURN SIGNAL LENS KIT – BULLET LENS, CLEAR



A. TURN SIGNAL LENS KIT – BULLET LENS, SMOKED



B. LED FENDER TIP LENS – CLEAR



B. LED FENDER TIP LENS – SMOKED

Notice: The prices appearing in this catalog are the manufacturer's suggested retail prices. Actual retail prices may vary.





C

**C. TURN SIGNAL VISOR TRIM RING – BULLET STYLE, SMOKED LENS**



C

**C. TURN SIGNAL VISOR TRIM RING – FLAT STYLE**



C

**C. TURN SIGNAL TRIM RING – BULLET STYLE, SMOKED LENS**



C

**C. TURN SIGNAL TRIM RING – FLAT STYLE**



NEW

D

**D. BLACK TURN SIGNAL VISOR TRIM RING – BULLET FRONT WITH SMOKED LENS AND AMBER BULB**



NEW

D

**D. BLACK TURN SIGNAL VISOR TRIM RING – BULLET REAR WITH RED LENS**

### C. TURN SIGNAL TRIM RINGS

Trim ring contour matches the turn signal housing and extends out past the lens for a sleek appearance. These easy-to-install chrome-plated trim rings look great alone, or in combination with Headlamp Trim Rings. Available in Visor Style for a nostalgic look, or in Trim Ring style for contemporary "frenched" contour. Sold in pairs.

#### Bullet Front or Rear, Amber Lenses

Fits models equipped with bullet style turn signals (except VRSC™, XL883N, XL1200N and FXCW/C rear signals and rear of models with Auxiliary Turn Signal Brake Light Kit P/Ns 69465-06, 69463-06 or 69462-06A).

<b>69756-05</b>	Visor Ring Style.	<b>\$31.95</b>
<b>69739-01</b>	Trim Ring Style.	<b>\$31.95</b>

#### Bullet Front, Smoked Lenses with Amber Bulbs

Fits models equipped with front bullet style turn signals (except XL883N and XL1200N).

<b>69758-05</b>	Visor Ring Style.	<b>\$34.95</b>
<b>69752-04</b>	Trim Ring Style.	<b>\$34.95</b>

#### Bullet Rear, Smoked Lenses with Amber Bulbs

Fits models equipped with rear bullet style turn signals (except VRSC, XL883N, XL1200N, FXCW/C, '09-later FXDB, FXDWG, and models equipped with Auxiliary Turn Signal Brake Light Kit P/Ns 69465-06, 69463-06 or 69462-06A).

<b>69759-05</b>	Visor Ring Style.	<b>\$34.95</b>
<b>69753-04</b>	Trim Ring Style.	<b>\$34.95</b>

#### Bullet Front, Clear Lenses with Amber Bulbs

Fits models equipped with front bullet style turn signals (except XL883N and XL1200N).

<b>69760-05</b>	Visor Ring Style.	<b>\$34.95</b>
<b>69754-04</b>	Trim Ring Style.	<b>\$34.95</b>

#### Bullet Rear, Clear Lenses with Amber Bulbs

Fits models equipped with rear bullet style turn signals (except VRSC, XL883N, XL1200N, FXCW/C, '09-later FXDB, FXDWG, and models equipped with Auxiliary Turn Signal Brake Light Kit P/Ns 69465-06, 69463-06 or 69462-06A).

<b>69761-05</b>	Visor Ring Style.	<b>\$34.95</b>
<b>69755-04</b>	Trim Ring Style.	<b>\$34.95</b>

#### Bullet Rear, Red Lenses

Fits rear of all models equipped with bullet style turn signals (except VRSC and International models) and Auxiliary Brake Light Kit P/Ns 69465-06 or 69462-06.

<b>69757-05</b>	Visor Ring Style.	<b>\$31.95</b>
<b>69736-02</b>	Trim Ring Style.	<b>\$31.95</b>

#### Flat Lens Turn Signal (without lens)

Fits flat lens turn signals on front and rear of '88-later Touring (except FLHX, FLHRS, '04-later FLTR and Trike), rear of '94-later FLSTC, '94-'97 FLSTN and '06 FLST models. Also fits FL Softail models with front Turn Signal Relocation Kit P/N 68413-99 or 68412-99.

<b>69749-05</b>	Visor Ring Style.	<b>\$44.95</b>
<b>69740-01</b>	Trim Ring Style.	<b>\$39.95</b>

### D. BLACK TURN SIGNAL VISOR TRIM RING

Visor-shaped trim rings add a traditional look to the contemporary style of the bullet turn signal. These easy-to-install black finish trim rings are available with smoked or red lenses to match your customizing direction (sold in pairs).

**73342-09** Bullet Front with Smoked Lens and Amber Bulb. **\$34.95**

Fits '08-later XL883N, XL1200N and FLSTSB models.

**73343-09** Bullet Rear with Smoked Lens and Amber Bulb. **\$34.95**

Fits '09-later FLSTSB models.

**73344-09** Bullet Rear with Red Lens. **\$31.95**

Fits '08-later XL883N and XL1200N models. Also fits FLSTSB models equipped with Auxiliary Turn Signal and Brake Light Kit P/N 69462-06A.

# 648 LIGHTING

## Tail & Brake Lamps

### A. LED TAIL LAMP WITH BAR & SHIELD LOGO

Combine LED technology and contemporary styling for a bright new look. Featuring a full array of 20 fast-acting red LED lamps, this brilliant running and brake lamp will grab everyone's attention. Designed to fit the contour of both bobtail and full rear fenders, the smoked or red lens Bar & Shield logo-accented tail lamp complements any custom direction. The available black or chrome surrounds are wrapped with a clear housing for a mirror-like finish. Easy plug-in connection to the Original Equipment wiring harness.

Fits '99-later XL (except XL883N and XL1200N), '99-later Dyna® (except '09-later FXDB and FXDWG), '03-later FXST, FXSTS, FXSTB, and FXSTC, '00-later FLST, FLSTF, FLSTSB and FLSTC, and '99-'08 Touring models (except FLHX, FLHTCSE2, FLHRSE3/4 and models equipped with License Plate Relocation Kit P/N 53702-04). Also fits '09-later FLHRC, FLHTC, FLHTCU and FLHTK (except Trike) models.

<b>68085-08</b>	Red Lens with Chrome Housing.	<b>\$139.95</b>
<b>68087-08</b>	Smoked Lens with Black Housing.	<b>\$139.95</b>
<b>68086-08</b>	Smoked Lens with Chrome Housing.	<b>\$139.95</b>

Fits '06-'09 FLHX, FLHTCSE2, and FLHRSE3/4 models, '09-later FLHR, FLHT and FLTR, and models equipped with License Plate Relocation Kit P/N 53702-04.

<b>68117-08</b>	Smoked Lens with Chrome Housing.	<b>\$139.95</b>
<b>68118-08</b>	Smoked Lens with Black Housing.	<b>\$139.95</b>
<b>68116-08</b>	Red Lens with Chrome Housing.	<b>\$139.95</b>

### B. REAR FENDER TIP LIGHT-AUXILIARY RUNNING LIGHT/BRAKE LIGHT

Upgrade your Touring model's Original Equipment fender tip light from a single-mode running light to a dual-mode running and brake light. The brilliant lamp glows red in the running mode, and increases in intensity when the brakes are applied. The available smoked or red lenses complement any styling direction. Easy-plug-in connection to the Original Equipment wiring harness.

Fits '09-later FLHTC, FLHTCU and FLHTK models.

<b>59685-10</b>	Red.	<b>\$94.95</b>
<b>59776-10</b>	Smoked.	<b>\$94.95</b>



**A. LED TAIL LAMP – SMOKED LENS WITH BLACK HOUSING (ON)**



**A. LED TAIL LAMP – SMOKED LENS WITH BLACK HOUSING (OFF)**



**A. LED TAIL LAMP – RED LENS WITH CHROME HOUSING**



**A. LED TAIL LAMP – SMOKED LENS WITH CHROME HOUSING**



**B. REAR FENDER TIP LIGHT-AUXILIARY RUNNING LIGHT/BRAKE LIGHT**



**B. REAR FENDER TIP LIGHT-AUXILIARY RUNNING LIGHT/BRAKE LIGHT**

Notice: The prices appearing in this catalog are the manufacturer's suggested retail prices. Actual retail prices may vary.





**C. TRI-BAR LED TAIL LIGHT – OFF**



**C. TRI-BAR LED TAIL LIGHT – ON**



**D. TRI-BAR LIGHTED REAR FENDER EXTENSION KIT**



**E. TRI-BAR LIGHT UPGRADE – AUXILIARY RUNNING LIGHT/BRAKE LIGHT**



**F. CUSTOM LED TAIL LAMP – CLEAR (ON)**



**F. CUSTOM LED TAIL LAMP – RED**

## C. TRI-BAR LED TAIL LIGHT

Featured on the '07-later Screamin' Eagle® Springer® Softail® model, this bobtail fender-styled tail lamp features fast-reacting LED lamps behind a smoked outer lens. Internally masked to form three distinct light bands, the smoked lens glows red in the running mode, and rapidly increases in intensity when the brakes are applied. The lamp assembly fills the fender opening for a custom look, and the minimalist license plate bracket continues the streamlined appearance. Easy plug-in connection to the Original Equipment wiring harness. DOT and TUV Approved.

**69817-07A \$239.95**

Fits '06-later FXST, FXSTB, FXSTC, FXSTS and FLSTSB models. Original Equipment on '07-'08 FXSTSSE models. Will fit with Bobtail Fender Racks P/N 53979-07A and 56452-07A when used with Installation Kit P/N 59320-07A. Does not fit with Bobtail Fender Rack P/N 56452-07, 60161-06 or 53979-07.

**68546-09 \$239.95**

Fits '08-later FXDF models. Original Equipment on FXDFSE.

## D. TRI-BAR LIGHTED REAR FENDER EXTENSION KIT

Add a "tail-dragger" look to the rear fender. The Tri-Bar Rear Fender Extension wraps the trailing edge of the fender in chrome, and the integrated Tri-Bar LED light bands add a practical touch. The three smoked light bands glow red in the running mode, and increase in intensity when the brakes are applied. The complete kit includes the chrome-plated ABS housing, fast-acting LED lamp assembly, and all necessary installation hardware.

**91066-07 \$179.95**

Fits '99-'08 FLHRC, FLHRS and FLTR models.

**91067-07 \$179.95**

Fits '99-'08 FLHR, FLHT, FLHTC, and FLHTCU models. (Does not fit FLHRSE2/3/4 models.)

## E. TRI-BAR LIGHT UPGRADE – AUXILIARY RUNNING LIGHT/BRAKE LIGHT

Upgrade the Original Equipment Tri-Bar fender light from a single-mode running light to a dual-mode running and brake light. The three smoked light bands glow red in the running mode, and increase in intensity when the brakes are applied.

**68358-07A \$97.95**

Fits '06-'09 FLHX models.

**67774-10 \$129.95**

Fits '10 FLHX and FLTRX models (except HDI models).

## F. CUSTOM LED TAIL LAMP

Function and style in one. 23 brilliant red LED lamps are set in a mirror-finished chrome inner reflector. The "diamond cut" facets shape and direct the light, and add a style all their own. Available with a red or clear outer lens, the installed lens adds a red metallic or chrome finishing touch to the rear fender. Easy plug-in connection to the Original Equipment wiring harness. Meets DOT and TUV requirements.

Fits '02-later VRSC™ models (except VRSCF) and '00-'07 FXSTD models.

**69366-07 Red Lens with Chrome Reflector. \$134.95**

**69367-07 Clear Lens with Chrome Reflector. \$134.95**

# 650 LIGHTING

## Tail & Brake Lamps

### A. SISSY BAR AUXILIARY BRAKE AND TAIL LAMP\*

This high-mounted Sissy Bar Auxiliary LED Lamp operates as a supplemental rear running light and brake light. The one-piece lamp assembly features an upper and lower arc-shaped lens that surrounds the sissy bar medallion plate, and the fast-acting LED lamp produces a red neon-like glow that is bound to get you noticed. The kit includes an adapter harness that connects to the vehicle wiring harness and features a quick-disconnect that allows a detachable sissy bar to be easily removed from the vehicle.

Fits '99-later XL models, '96-later Dyna® models, and '96-later Softail® models equipped with a Medallion Plate-Style Sissy Bar Upright. Will not fit with Backrest Pads that have mounting brackets that match the contour of the sissy bar medallion. Will not fit with sissy bar mounted storage bags. Some Touring and Bucket Backrest pads require separate purchase of Sissy Bar Lamp Mounting Bracket Kit P/N 59545-04.

**59470-06** Smoked Lens. **\$84.95**  
**59429-04** Red Lens. **\$84.95**

#### Sissy Bar Lamp Mounting Bracket Kit (not shown)

Required to install Sissy Bar Auxiliary Brake and Tail Lamp on models equipped with Touring and Bucket Passenger Backrest P/N 51667-98, 51132-98, 51130-98, 52348-97, 52347-97, or 52350-97.

**59545-04** **\$25.45**



A. SISSY BAR AUXILIARY BRAKE AND TAIL LAMP – RED LENS



A. SISSY BAR AUXILIARY BRAKE AND TAIL LAMP – SMOKED LENS

### B. TOUR-PAK® SIDE MARKER LIGHT KIT – SMOKED

This wrap-around smoked lens Side Marker Light Kit adds a splash of light to the lower edge of the Tour-Pak luggage system. Kit replaces the chrome side trim along the lower edge of the Tour-Pak on Electra Glide® Classic models, or replaces the Original Equipment red lens featured on Ultra Classic® Electra Glide® and Tri Glide™ models. The smoked lens remains stealthy while the ignition is off, but glows red when the lights are switched on. Complete kit includes left and right smoked lens housings, wiring harness, and all required installation hardware.

**54352-09** **\$119.95**  
 Fits '06-later FLHTC, FLHTCU, FLHTCUTG, and Touring models equipped with '06-later-style King Tour-Pak Luggage.



B. TOUR-PAK SIDE MARKER LIGHT KIT – SMOKED



B. TOUR-PAK SIDE MARKER LIGHT KIT – SMOKED (ON)

### C. TOUR-PAK® SIDE MARKER LIGHT KIT – RED\*

This wrap-around Side Marker Light Kit replaces the chrome side trim along the lower edge of the Electra Glide Classic Tour-Pak luggage system with a slash of light. Original Equipment on the '06-later FLHTCU, FLHTK, and FLHTCUTG models, this complete kit includes left and right lens housings, wiring harness, and all required installation hardware.

**69494-06** **\$119.95**  
 Fits '06-later FLHTC models and Touring models equipped with '06-later-style King Tour-Pak® Luggage.

### D. KING TOUR-PAK® BRAKE/TAIL LAMP KIT\*

Dual filament bulbs provide both brake and tail lamp. Meets DOT requirements. Includes template to assist in cutting out lens housing openings, step-by-step instructions, wiring and all necessary mounting hardware. Dealer installation recommended.

**68172-06** **\$214.95**  
 Fits '06-later King Tour-Pak. (NOTE: Kit accommodates single antenna applications.)

**68012-88E** **\$214.95**  
 Fits '88-'05 King Tour-Pak. (NOTE: Kit accommodates single antenna applications.)

NOTE: Original Equipment on Ultra Classic Models



C. TOUR-PAK SIDE MARKER LIGHT KIT – RED



D. KING TOUR-PAK BRAKE/TAIL LAMP KIT



**\*WARNING:** Disconnecting your DOT requirement brake lamp could reduce your visibility to others and result in death or serious injury.

NOTE: It is possible to overload your motorcycle's charging system by adding too many electrical accessories. If your combined electrical accessories operating at any one time consume more electrical current than your vehicle's charging system can produce, the electrical consumption can discharge the battery and cause vehicle electrical system damage. Ask your dealer for advice about the amount of current consumed by additional electrical accessories.

Notice: The prices appearing in this catalog are the manufacturer's suggested retail prices. Actual retail prices may vary.





**E. CHROME TAIL LIGHT COLLAR**



**E. CHROME TAIL LIGHT COLLAR – FLHX MODELS**



**F. CLASSIC CHROME TAIL LIGHT VISOR**



**G. SKULL COLLECTION TAIL LIGHT VISOR**



**H. EAGLE WING LOGO TAIL LIGHT VISOR**



**I. CHROME TAIL LIGHT COVER**



**J. LONG-LIFE TAIL LAMP BULB**

**E. CHROME TAIL LIGHT COLLAR**

This chrome-plated ABS tail light collar dramatically changes the appearance of your rear fender. The collar is easy-to-install, and the kit includes all mounting hardware.

**68311-01** **\$31.95**  
 Fits '03-later XL (except XL883N and XL1200N), Dyna (except FXDWG and '09-later FXDB), FLSTF, '03-'08 Touring (except FLHX), '09-later FLHRC, FLHTC, FLHTCU and FLHTK models with Original Equipment tail lamp.

**68332-08** **\$31.95**  
 Fits '06-'09 FLHX, '09-later FLHR, FLHT and '06-'09 FLTR models with Original Equipment tail lamp. Also fits Touring models equipped with Bullet Turn Signal and License Plate Relocation Kit P/N 53702-04A.

**F. CLASSIC CHROME TAIL LIGHT VISOR**

**68006-83T** **\$17.95**  
 Fits '73-later models (except XL883N, XL1200N, FXWG, FXDF, FX Softail, FLSTS, FLSTSB, FLSTN, FLHX, VRSC and FXDWG models). Does not fit '09-later FLHR, FLTR and FXDB.

**68012-88T** **\$17.95**  
~~Fits '80-later FXWG, FXDF, FX Softail (except FXSTD and FXCW/C), FLSTS, and FXDWG models.~~

**G. SKULL COLLECTION TAIL LIGHT VISOR**

**69787-07** **\$23.95**  
 Fits '06-later FLHX models with Original Equipment tail lamp, '09 FLHR and FLTR models, and Touring models equipped with Bullet Turn Signal and License Plate Relocation Kit P/N 53702-04A.

**69790-07** **\$23.95**  
 Fits '73-later models (except XL883N, XL1200N, FXWG, FXDF, FX Softail, FLSTS, FLSTSB, FLSTN, FLHX, VRSC™ and FXDWG models). Does not fit '09-later FLHR, FLTR and FXDB.

**H. "EAGLE WING" LOGO TAIL LIGHT VISOR**

Mirror-finish chrome visor dresses the tail light in style. The raised Bar & Shield logo is surrounded with eagle wings, and is available in all-chrome or with gold two-tone highlights.

Fits '73-later models (except XL883N, XL1200N, FXWG, FXDF, FX Softail, FLSTS, FLSTSB, FLSTN, FLHX, VRSC and FXDWG models). Does not fit '09-later FLHR, FLTR and FXDB.

**68011-91T** Gold Two-tone. **\$28.95**  
**68011-88T** Chrome. **\$19.95**

Fits '06-later FLHX models, and Touring models equipped with Bullet Turn Signal and License Plate Relocation Kit P/N 53702-04A. (not shown)

**69920-07** Chrome. **\$19.95**

**I. CHROME TAIL LIGHT COVER**

Dress your tail lamp in style. This chrome-plated Tail Light Cover follows the contour of the lens for a custom look. Self-adhesive backing for easy installation.

**68478-05** **\$26.95**  
 Fits '02-'06 VRSC models and '07-'08 VRSCD and VRSCR models with 180mm rear tire.

**J. LONG-LIFE TAIL LAMP BULB**

Your tail lamp is one of your most important visibility features. This design features a long-lasting 12-volt bulb that passes stringent H-D vibration tests.

Fits '65-early '03 H-D models, late '03-later VRSC (except VRSCF), '03-'07 FXSTD models and '05-later FLSTN models.

**68168-89A** Domestic. **\$3.95**  
**68169-90A** International. **\$4.95**

*Notice: The prices appearing in this catalog are the manufacturer's suggested retail prices. Actual retail prices may vary.*

## 652 LIGHTING

LED Lights

### Step Into the Light

Believe it or not, chrome isn't the brightest accessory you can use to customize your ride. Harley-Davidson offers a variety of lighting options that can add the perfect finishing touch to nearly any part of your bike.

**NEW**



#### ELECTRA GLO™ LIGHT POD KIT\*

Light up the night. These compact LED Light Pods radiate a neon-like glow to accent almost any part of the motorcycle. Featuring a solid-state circuit board sealed against the weather, these self-adhesive lights can be placed under the tank, behind the air cleaner, or almost anywhere your imagination takes you. Electra Glo LED lighting draws minimal amperage, allowing lights to be left on for hours when parked. Light Pods connect directly to the motorcycle wiring harness, and the one-way wiring simplifies installation.

The complete kit includes 6 light pods, basic wiring in a selection of lengths, adhesive wire ties, and a compact on/off switch with rheostat to control the lighting intensity. Available Expansion Kits provide plug-in installation of additional lighting.

Fits all models. Lights are intended for display use only. Some local regulations prohibit using colored lights during vehicle operation on public streets.

<b>67679-09</b>	Amber.	<b>\$169.95</b>
<b>67680-09</b>	Red.	<b>\$169.95</b>
<b>67695-09</b>	Blue.	<b>\$189.95</b>
<b>67701-09</b>	Purple.	<b>\$189.95</b>

#### Also available:

#### ELECTRA GLO LIGHT POD EXPANSION KIT\*

Highlight additional areas of your custom motorcycle. Expansion Kit features simple plug-in installation to the basic Electra Glo Light Pod Kit. Kit contains 4 Light Pods and basic wiring assortment.

<b>67610-09</b>	Amber.	<b>\$119.95</b>
<b>67620-09</b>	Red.	<b>\$119.95</b>
<b>67671-09</b>	Blue.	<b>\$129.95</b>
<b>67678-09</b>	Purple.	<b>\$129.95</b>

\*NOTE: It is possible to overload your motorcycle's charging system by adding too many electrical accessories. If your combined electrical accessories operating at any one time consume more electrical current than your vehicle's charging system can produce, the electrical consumption can discharge the battery and cause vehicle electrical system damage. Ask your dealer for advice about the amount of current consumed by additional electrical accessories.

Notice: The prices appearing in this catalog are the manufacturer's suggested retail prices. Actual retail prices may vary.

NOTE: Some local regulations prohibit using colored lights during vehicle operation on public streets. May not conform to local lighting regulations.



AMBER



RED



BLUE

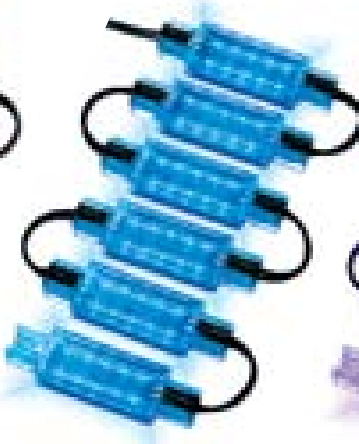

PURPLE

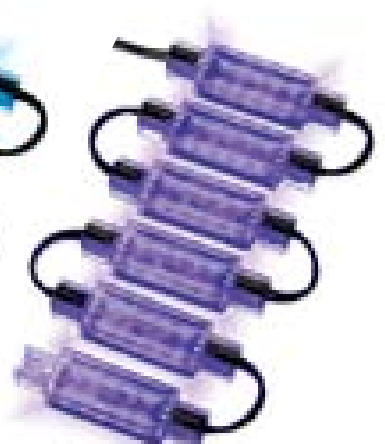

# 654 LIGHTING

## LED Lights

### A. ILLUMINATED FAIRING ACCENT TRIM\*

Sweeping chrome trim dresses the Electra Glide fairing for a distinctive, yet functional look. Smoked lenses hide amber LED lamps that glow as running lamps when the ignition is on, and function as auxiliary directional indicators when the turn signals are activated. Fairing Accent Trim looks great by itself, and is styled to complement the available Illuminated Windshield Trim and Illuminated Mirrors. The wiring is concealed inside the fairing for a clean, custom appearance. Complete kit includes all necessary installation hardware. Trim may cover pinstripes or two-tone paint lines on some vehicles. Check appearance prior to installation.

**69290-09** **\$199.95**

Fits '97-later Electra Glide®, Street Glide® and Trike models.

### B. ILLUMINATED LED WINDSHIELD MOLDING KIT\*

Smoked lenses hide bands of four amber LED lamps that glow as running lamps when the ignition is on, and the two outer clusters function as auxiliary directional indicators when the turn signals are activated. The wiring is concealed inside the fairing for a clean, custom appearance. Complete kit includes all necessary mounting hardware.

**57335-08** **\$189.95**

Fits '97-later Electra Glide®, Street Glide® and Trike models.

### C. ELECTRA GLO™ LIGHT RINGS\*

Roll on the rays of light with this accessory for Touring models. Featuring outer and inner bands of colored LED lights, this trim ring attaches to the rotor cover illuminating the entire wheel, while providing auxiliary side lighting as well. Installs easily with pre-applied adhesive backing. Requires the installation of Caliper/Rotor Cover Kit P/Ns 43175-98, 43068-89A, 42230-00 or 43149-95.

Fits '97-'07 Touring models equipped with Caliper/Rotor Cover Kits P/Ns 43175-98, 43149-95, 42230-00 or 43068-89A.

**46748-02A** **\$199.95**

Amber outer color, Amber inner color.

**46750-02A** **\$199.95**

Amber outer color, Purple inner color.

### D. LIGHTED FORK SLIDER COVERS\*

Highlighted by a triple row of amber running lights, these fork slider covers are the perfect complement to the Chrome Caliper Rotor Covers. Includes all necessary mounting brackets and hardware, wiring harness, and instructions.

**46732-00** **\$189.95**

Fits '00-'07 Touring models with Caliper Rotor Cover Kit P/N 42230-00. Does not fit with Chrome Wind Deflectors P/N 58121-85B.



A. ILLUMINATED FAIRING ACCENT TRIM (SHOWN WITH LED WINDSHIELD MOLDING)



B. ILLUMINATED LED WINDSHIELD MOLDING KIT



C. ELECTRA GLO LIGHT RINGS (SHOWN WITH CALIPER ROTOR COVER)



D. LIGHTED FORK SLIDER COVERS

\*NOTE: It is possible to overload your motorcycle's charging system by adding too many electrical accessories. If your combined electrical accessories operating at any one time consume more electrical current than your vehicle's charging system can produce, the electrical consumption can discharge the battery and cause vehicle electrical system damage. Ask your dealer for advice about the amount of current consumed by additional electrical accessories.

Notice: The prices appearing in this catalog are the manufacturer's suggested retail prices. Actual retail prices may vary.





E

**E. ELECTRA GLO RIDER FOOTBOARD EDGE LIGHT KIT**

**E. ELECTRA GLO™ RIDER FOOTBOARD EDGE LIGHT KIT\***

Add a rim of neon-like light to the rider footboard. This integrated red LED light and lens assembly hugs the bottom of the rider footboard, and is held in place by the footboard insert isolation mounting system. The soft red glow acts as an auxiliary side marker light, and casts a subtle pool of light to the ground below. The perfect complement to the Electra Glo Lighted Passenger Footboard Cover P/N 50541-03. Kit includes left and right footboard lights, wiring harness and all necessary installation components. NOTE: Some local regulations prohibit using colored lights during vehicle operation on public streets. May not conform to local lighting regulations.

**50743-04 \$99.95**

Fits '91-later FLSTC, FLSTF, FLSTS, and FLSTSC models, '93-'96 FLSTN models, and '94-later Touring models equipped with traditional D-shaped rider footboards.

**F. ELECTRA GLO™ LIGHTED PASSENGER FOOTBOARD COVER KIT\***

This innovative LED light kit covers the bottom side of the passenger footboard. When the passenger footboard is folded in the up position, the light will shine to the side and act as an auxiliary side marker light. When the board is folded down, the light illuminates the ground with a pool of soft light. Kit includes a pair of LED lamps with red lenses, chrome covers with Bar & Shield logo, chrome hardware, and all necessary installation components. NOTE: Some local regulations prohibit using colored lights during vehicle operation on public streets. May not conform to local lighting regulations.

**50541-03 \$169.95**

Fits '84-later Touring and Softail® models equipped with traditional D-shaped passenger footboards.

**G. ELECTRA GLO™ LIGHT RAILS\***

Molded housings incorporate wave-soldered circuit boards with tungsten filament bulbs for enhanced illumination. Precision-molded Lexan® polycarbonate lenses lined with light-diffusing panels offer consistent, even light dispersion. Assembled and wired for bolt-on and plug-in installation. Kit includes bracketry, hardware, and instructions.

**68682-09 \$579.95**

Fits '09-later Road King® and Electra Glide® (except Trike) models equipped with hard saddlebags. Installation on models not factory-equipped with saddlebag guards requires separate purchase of Saddlebag Guard Rail Kit P/N 90892-09.

**90531-93 \$579.95**

Fits '94-'08 FLTCU, FLHTCU, FLHTC and '98-'03 FLTR models. Will not fit '06-'08 FLHX models.

NOTE: Installation on '93 FLHS and '94-'96 FLHR models requires Saddlebag Guard Kit P/N 90839-93A, installation on '97-later FLHT and FLHR (except '98-later FLHRC and FLHRS) models requires Saddlebag Guard Kit P/N 91216-97. Must be purchased separately. To install on '93-'96 models equipped with accessory Triple Saddlebag Rail Kit P/N 90845-93A, Left and Right Outer Guard Rail Clamps P/N 90919-93 and P/N 90917-93 are required and must be purchased separately.



F

**F. ELECTRA GLO LIGHTED PASSENGER FOOTBOARD COVER KIT**



G

**G. ELECTRA GLO LIGHT RAILS**

\*NOTE: It is possible to overload your motorcycle's charging system by adding too many electrical accessories. If your combined electrical accessories operating at any one time consume more electrical current than your vehicle's charging system can produce, the electrical consumption can discharge the battery and cause vehicle electrical system damage. Ask your dealer for advice about the amount of current consumed by additional electrical accessories.

Notice: The prices appearing in this catalog are the manufacturer's suggested retail prices. Actual retail prices may vary.

# 656 LIGHTING

## LED Lights

### A. MIRROR WITH AUXILIARY RUNNING LIGHT AND DIRECTIONAL INDICATOR\*

Function and style in one package. This forged mirror combines a traditional swept shape with a contemporary addition – forward-facing auxiliary lighting. Smoked lenses hide bands of amber LED lamps that glow as running lamps when the ignition is on, and add a fast-acting auxiliary directional indicator when the turn signals are activated. The forward-facing eye-level lamps command additional attention from oncoming traffic. Both mirrors flash when the emergency hazard lights are activated. The wiring is concealed in the housing and stem, and is easily connected to the Original Equipment wiring harness.

Fits '97-later models (except VRSCF). (pair)

<b>92059-07</b>	Chrome.	<b>\$299.95</b>
<b>92068-08</b>	Satin Black.	<b>\$299.95</b>

### B. ELECTRA-GLO™ LIGHTED HAND GRIP END CAP KIT

Style and functionality in one. These chrome hand grip end caps feature built-in LED lighting that operates as an auxiliary running light and supplemental directional indicator. The directional indicator functions in an “on-and-off” flash mode for superior contrast and visibility. The end cap features an interchangeable inner lens with 3 logo styles: Bar & Shield Logo, Skull, and Radial.

**56870-06** **\$64.95**

Fits '96-later models (except '08-later Touring) equipped with the following Hand Grips: Contoured Chrome and Rubber Custom Hand Grips P/N 56459-01A; Chrome and Rubber Horizontal Hand Grips P/N 56246-96A, 56263-96A, 56241-96 and 56258-96; Flame Hand Grips P/N 56518-02; Diamond Plate Hand Grips P/N 56618-04 and 56688-04; Smooth Leather Hand Grips P/N 56197-98A and 56291-98; Custom Print Leather Hand Grips P/N 56596-02A, 56600-98A, 56604-98A and 56199-98A.



**A. MIRROR WITH AUXILIARY RUNNING LIGHT AND DIRECTIONAL INDICATOR – CHROME**



**A. MIRROR WITH AUXILIARY RUNNING LIGHT AND DIRECTIONAL INDICATOR – SATIN BLACK**



**B. ELECTRA-GLO LIGHTED HAND GRIP END CAP KIT – RADIAL (OFF)**



**B. ELECTRA-GLO LIGHTED HAND GRIP END CAP KIT – RADIAL**



**B. ELECTRA-GLO LIGHTED HAND GRIP END CAP KIT – BAR & SHIELD**



**B. ELECTRA-GLO LIGHTED HAND GRIP END CAP KIT – SKULL**

\*Harley-Davidson Motor Company cannot test and make specific fitment recommendations concerning every possible mirror and handlebar combination. Therefore, after installing new mirrors or handlebars, and before operating the motorcycle, check to ensure that the mirrors provide the operator a clear view to the rear.

Notice: The prices appearing in this catalog are the manufacturer's suggested retail prices. Actual retail prices may vary.



C

### C. TOUR-PAK® LUGGAGE AND SADDLEBAG INTERIOR LIGHT KIT

Don't be left in the dark. This bright convenience lamp kit turns night-time into day when you open your Tour-Pak or saddlebag. A brilliant white LED light pod mounts inside the Tour-Pak to illuminate the interior, and the two available LED light pods mount to the bottom of the Tour-Pak to cast light inside the open saddlebags. Each LED light pod features a soft-touch micro switch for ease of activation, and a 5 minute auto shut-off timer to prevent battery drain. Complete 3-Light Kit is available, or you can start with the 1-Light Tour-Pak Light Kit and add two Saddlebag lamps at a later time. Kit includes quick-disconnect wiring harness and installation hardware.

#### 3-Light Tour-Pak and Saddlebag Light Kit

**54331-04** **\$119.95**

Fits '93-later Touring models (except Trike) equipped with rigid or detachable King or Chopped Tour-Pak Luggage.

#### 1-Light Tour-Pak Light Kit

**54332-04B** **\$89.95**

Fits '93-later Touring models (except Trike) equipped with rigid or detachable King or Chopped Tour-Pak Luggage.

#### Saddlebag Light Expansion Kit

**54333-04** **\$33.95**

Fits '93-later Touring models (except Trike) equipped with rigid or detachable King or Chopped Tour-Pak Luggage and 1-Light Tour-Pak Light Kit (54332-04, (2 required)).

~~OBsolete~~

### D. UTILITY LIGHT

Powered by four AAA batteries, this compact utility light is great for inside saddlebags, Tour-Pak® components or anywhere else you need more light. Attached with hook and loop fasteners, the light is easy-to-install, and easy to take on and off for convenient use. It features a high-intensity bulb, a recessed switch to prevent accidental operation and a lens with a molded-in Bar & Shield logo. (Batteries not included.)

**90270-99** Universal fitment. **\$23.95**

Approximate size: 3-1/4" x 3" x 3/4".

C. TOUR-PAK LUGGAGE AND SADDLEBAG INTERIOR LIGHT KIT



C

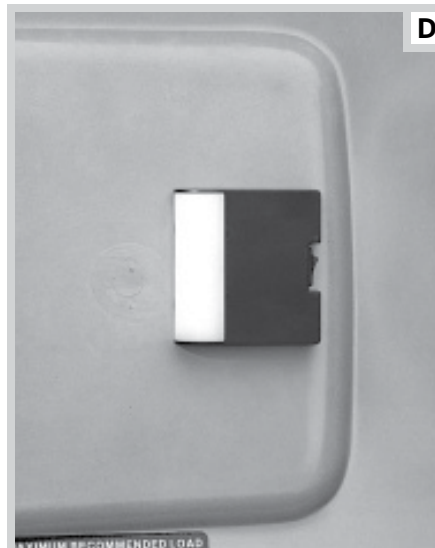

D

C. TOUR-PAK LUGGAGE AND SADDLEBAG INTERIOR LIGHT KIT

D. UTILITY LIGHT

Notice: The prices appearing in this catalog are the manufacturer's suggested retail prices. Actual retail prices may vary.

# 658 LIGHTING

## Horns & Horn Covers

### A. PREMIUM AIR HORN KIT\*

Sit up and get noticed. This Premium Air Horn is one of the loudest motorcycle horns available. The compact design has the compressor attached directly to the horn assembly, eliminating the need for separate mounting of the compressor and air hoses. The horn features an integrated chrome cover for a stylish look. Separate purchase of a vehicle-specific installation kit is required.

**69423-05** **\$139.95**

Fits '02-later VRSC™, '04-later XL, XR, '96-later Dyna®, '00-later Softail® (except FLSTS, FXCW/C and FLSTSC), and '99-later Touring models. Requires separate purchase of vehicle-specific Installation Kit.

#### Shown with:

#### PREMIUM AIR HORN INSTALLATION KIT

Required for installation of Premium Air Horn Kit P/N 69423-05 on specific models.

**69412-07** Fits '02-later VRSC models. **\$74.95**

**69415-05A** **\$59.95**

Fits '04-later XL models (except XL1200 Custom), and '08-later XR models.

**69422-05** **\$59.95**

Fits '04-later XL1200 Custom models.

**69404-05** **\$59.95**

Fits '96-later Dyna models (except FXDWG).

**69421-05** Fits '96-later FXDWG models. **\$59.95**

**69408-05** **\$64.95**

Fits '00-later Softail models (except FLSTS, FLSTSC and FXCW/C).

**69400-05A** Fits '99-later Touring models. **\$64.95**



A. PREMIUM AIR HORN AND INSTALLATION KIT



A. PREMIUM AIR HORN AND INSTALLATION KIT

\*NOTE: It is possible to overload your motorcycle's charging system by adding too many electrical accessories. If your combined electrical accessories operating at any one time consume more electrical current than your vehicle's charging system can produce, the electrical consumption can discharge the battery and cause vehicle electrical system damage. Ask your dealer for advice about the amount of current consumed by additional electrical accessories.

Notice: The prices appearing in this catalog are the manufacturer's suggested retail prices. Actual retail prices may vary.



# LIGHTING 659

Horns & Horn Covers



**B. SMOOTH HORN COVER**



**C. AIR WING HORN COVER**



**D. WRINKLE BLACK HORN COVER**



**E. BAR & SHIELD LOGO HORN COVER**



**F. CLASSIC HORN**



**G. CHROME HORN KIT**

## **B. SMOOTH HORN COVER**

Add a custom touch to your ride. Styled to complement the Smooth Air Cleaner Cover P/N 29153-07, this compact round horn cover features a mirror-chrome finish. Mounts easily to the stock horn cover bracket.

**68189-07** **\$37.95**

Fits '93-later models with side-mounted horn (except VRSC™ models).

## **C. AIR WING HORN COVER**

This exclusive Air Wing chrome-plated horn cover is styled to complement the Harley-Davidson® Billet Air Cleaner Cover, and is a stylish replacement for the Original Equipment horn cover. Mounts easily to stock horn cover bracket.

**69167-02A** **\$46.95**

Fits '93-later models with side-mounted horn (except VRSC models).

## **D. WRINKLE BLACK HORN COVER**

This powder coated horn cover is the perfect start in converting your powertrain to a striking "blacked out" look. Manufactured from Original Equipment components, this cover is painted on the factory production line to ensure a matching wrinkle black finish.

**69039-09** **\$37.95**

Fits '93-later models with side-mounted horn (except VRSC models).

## **E. BAR & SHIELD LOGO HORN COVER**

Complement your engine fins with this chrome-plated horn cover with engraved inserts, which feature a Bar & Shield emblem accented by a black background. Easily mounts to stock horn bracket.

**69166-01A** **\$46.95**

Fits '93-later models with side-mounted horn (except VRSC models).

## **F. CLASSIC HORN**

Early style 12V horn features nostalgic Harley-Davidson Bar & Shield logo on chrome cover. To be used as an auxiliary horn only. Do not disconnect your Original Equipment horn.

**69036-88A** Classic Horn Kit. **\$79.95**

Fits '88-later FXSTS models (does not fit FLSTS or FLSTSC). Includes chrome mounting bracket and acorn nuts.

**69005-85T** Classic Horn. **\$39.95**

Horn only.

## **G. CHROME HORN KIT**

Convert your stock Sportster horn to the look of a Big Twin.

**69112-95D** **\$89.95**

Fits '92-later XL883, XL883H, XL883C, XL883L, XL833R, XL1200, XL1200L, XL1200N and XL1200R models.

Notice: The prices appearing in this catalog are the manufacturer's suggested retail prices. Actual retail prices may vary.

# 660 LIGHTING

## License Plate Mounts

### A. FRAMED LAYBACK LICENSE PLATE MOUNT

Wrap your license plate in chrome. This mirror-finish license mount tips the plate back for a sleek appearance, and conceals the mounting hardware for a custom look. The front frame covers the license holes, and the mirror-smooth back plate hides the unfinished rear of the plate. Kit accepts plates measuring to 7-1/4" x 4-1/4" (184 x 108mm). Kit includes installation hardware and rear fender reflector.

**60193-07** Fender Top. **\$59.95**

Fits license plate up to 7-1/4" x 4-1/4". Fits models with a three-hole rear fender mount license plate bracket. (Does not fit XL883N, XL1200N, FLSTS, FXCW, FXCWC, FXDS-CONV., FXDXT, '09-later FXDB, '10 FXDWG, '00-'01 FXDX, Touring, VRSC™ models or models with a Bobtail Rear Fender.) (Check for clearance before installing with rear fender rack.)

**60210-07** Touring. **\$59.95**

Fits '99-'08 Road King®, Road Glide® and Electra Glide® Standard models with 7-1/4" x 4-1/4" license plate.



A. FRAMED LAYBACK LICENSE PLATE MOUNT – TOURING



A. FRAMED LAYBACK LICENSE PLATE MOUNT – FENDER TOP

### B. LAYBACK LICENSE PLATE MOUNT

Showcase your laid-back attitude by replacing the stand-up license-plate mount. Chrome-plated die-cast mount tips the license plate back for a low-profile style. Kit accepts plates measuring to 7-1/4" x 4-1/4" (184 x 108mm). Kit includes chrome-plated license mounting hardware, installation hardware, and rear fender reflector.

**60280-07** Fender Top. **\$41.95**

Fits license plate up to 7-1/4" x 4-1/4". Fits models with a three-hole rear fender mount license plate bracket. (Does not fit XL883N, XL1200N, FLSTS, FXCW, FXCWC, FXDS-CONV., FXDXT, '09-later FXDB, '10 FXDWG, '00-'01 FXDX, Touring, VRSC™ models or models with a Bobtail Rear Fender.) (Check for clearance before installing with rear fender rack.)

**60277-07** Touring. **\$39.95**

Fits '99-'08 Road King®, Road Glide® and Electra Glide® Standard models with 7-1/4" x 4-1/4" license plate.

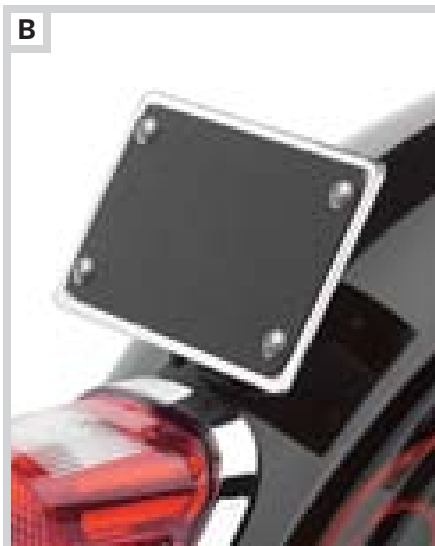

B. LAYBACK LICENSE PLATE MOUNT – FENDER TOP



B. LAYBACK LICENSE PLATE MOUNT – TOURING

### C. LAYBACK LICENSE PLATE AND TURN SIGNAL RELOCATION KIT

This kit combines our popular Layback License Plate Mount with an integrated turn signal bar to add a stylish slant to the rear fender. Kit relocates the Original Equipment bullet-style turn signals from the fender strut to the turn signal bar to allow clearance for saddlebags. This kit is a stylish alternative to Turn Signal Relocation Kit P/N 68732-02A, and includes all necessary mounting hardware.

**60215-06** **\$79.95**

Fits '04-later XL models (except XL883N and XL1200N) and '02-later Dyna® models (except FXDWG, FXDF and '09-later FXDB).

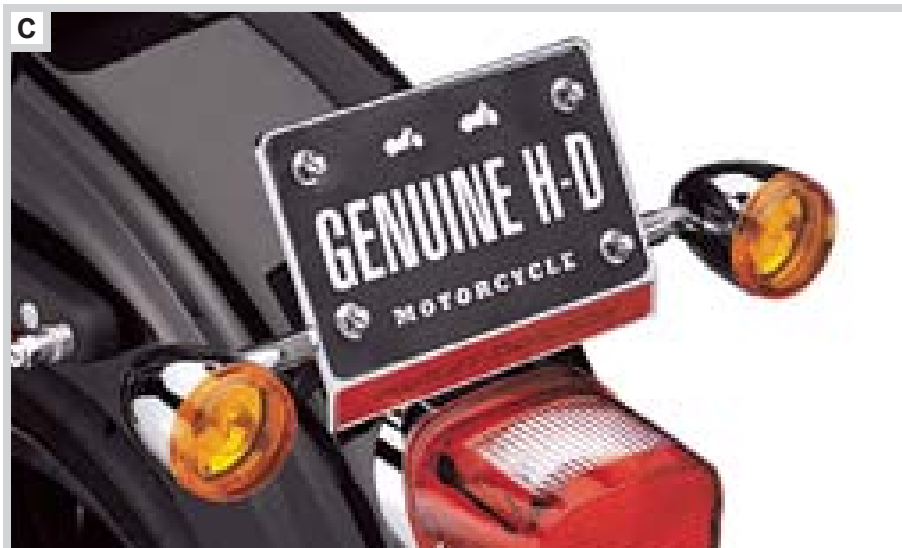

C. LAYBACK LICENSE PLATE AND TURN SIGNAL RELOCATION KIT

Notice: The prices appearing in this catalog are the manufacturer's suggested retail prices. Actual retail prices may vary.



**D. BULLET REAR TURN SIGNAL BAR AND LICENSE PLATE RELOCATION KIT**



**D. BULLET REAR TURN SIGNAL BAR AND LICENSE PLATE RELOCATION KIT**

Accent the long and lean look of your Touring bike. This complete kit moves your license plate from the support bar to the rear fender tail for a true custom look. The kit includes a Bullet Turn Signal Bar with integrated down-lighting for the license plate, bullet turn signals, chrome rear fender tip, and decorative trim to cover the original license plate mounting holes.

**53702-04A** **\$249.95**  
Fits '99-'08 Touring models. '99-early '03 models require the separate purchase of Tail Light Socket P/N 68370-03A.

**E. CHROME LICENSE PLATE MOUNT**

Show off your tail. This chrome-plated cover fits over the stock fender mount license plate bracket. This mirror-finished cover features a custom reflector with "Harley-Davidson" graphics. Includes mounting hardware for cover and license plate.

**59720-01A** **\$37.95**  
Fits '99-'08 FXDWG, '00-later FXSTD, FXST, FXSTB, FXSTC, FLSTSB, FXSTS and XL and Dyna® models equipped with H-D® Bobtail Fender Kits.

**F. LOUVERED LICENSE BACKING PLATE**

**59899-88T** **\$19.95**  
Fits license plates with a 5-3/4" x 2-3/4" center-to-center hole mounting pattern (except XR, XL883N, XL1200N, '10 FXDWG, FXCW/C and Trike models).

**G. SMOOTH LICENSE BACKING PLATE**

Cover the back of your license plate for the complete custom transformation. This polished stainless steel License Backing Plate looks great with or without a frame. Kit includes chrome-plated stainless steel mounting hardware.

**60041-04** **\$23.95**  
Fits license plates with a 5-3/4" x 2-3/4" center-to-center hole mounting pattern (except XR, XL883N, XL1200N, '10 FXDWG, FXCW/C and Trike models).

**H. CHROME LICENSE PLATE BRACKET**

**59983-75T** **\$19.95**  
Fits '76-'84 FL models, '71-later FX, FXR (except FXST, FXWG), and '75-later XL models (except XL1200N and XL883N).

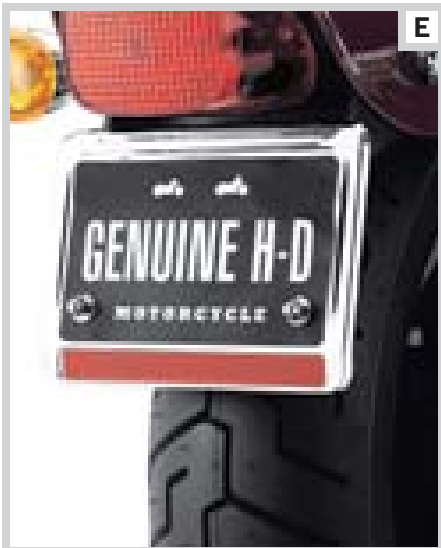

**E. CHROME LICENSE PLATE MOUNT - BOBTAIL FENDER SHOWN**



**F. LOUVERED LICENSE BACKING PLATE**



**G. SMOOTH LICENSE BACKING PLATE**



**H. CHROME LICENSE PLATE BRACKET**

*Notice: The prices appearing in this catalog are the manufacturer's suggested retail prices. Actual retail prices may vary.*

# 662 LIGHTING

## License Plate Mounts

### A. BILLET LICENSE PLATE FRAME

Make a custom statement. Manufactured from billet aluminum, this mirror-polished license plate frame features hidden hardware and bright chrome backing plate for a clean look. The kit includes "Harley-Davidson", "Sportster", "Fat Boy" and "Road King" logo engraved inserts for the ultimate finishing touch. Chrome-plated stainless steel mounting hardware included.

**60060-04** **\$74.95**

Fits 7-1/4" x 4-1/4" license plates (except XR and Trike models equipped with Layback License Plate Mounting Kits and Side-Mount License Plates).

### B. USA LICENSE PLATE FRAME

Ride with pride. This chrome-plated license plate frame combines color-filled Bar & Shield logos with multi-color red, white and blue "USA" lettering to remind everyone where your Harley-Davidson® motorcycle was born. Includes chrome-plated stainless steel mounting hardware.

**60065-03** **\$21.95**

Fits license plates up to 7-1/4" x 4-1/4" (except XR, XL883N, XL1200N, FXCW/C, '10 FXDWG, and Trike models).

### C. CHROME HARLEY-DAVIDSON® LICENSE PLATE FRAME

Make your plate shine with this chrome-plated license plate frame, featuring a black paint-filled "Harley-Davidson" logo. Includes chrome-plated stainless steel mounting hardware.

**60051-01** **\$21.95**

Fits license plates up to 7-1/4" x 4-1/4" (except XR, XL883N, XL1200N, FXCW/C, '10 FXDWG, and Trike models).

**60050-01** **\$21.95**

Fits license plates up to 8-1/4" x 4-3/4" (except XR, XL883N, XL1200N, FXCW/C, '10 FXDWG, and Trike models).

### D. CHROME "HARLEY-DAVIDSON" SCRIPT LICENSE PLATE FRAME

If a license plate is required, you might as well make it look good. This decorative, chrome-plated license plate frame has three-dimensional twist contours, a black "Harley-Davidson" script and a DOT compliant reflector. Stainless steel mounting hardware included.

**59141-98** **\$24.95**

Fits license plates up to 7-1/4" x 4-1/4" (except XR, XL883N, XL1200N, FXCW/C, '10 FXDWG, and Trike models).

### E. CHROME LICENSE PLATE FRAME

**59863-94T** **\$14.95**

Fits license plates up to 7-1/4" x 4-1/4" (except XR, XL883N, XL1200N, FXCW/C, '10 FXDWG, and Trike models).



A. BILLET LICENSE PLATE FRAME



A. BILLET LICENSE PLATE FRAME



B. USA LICENSE PLATE FRAME

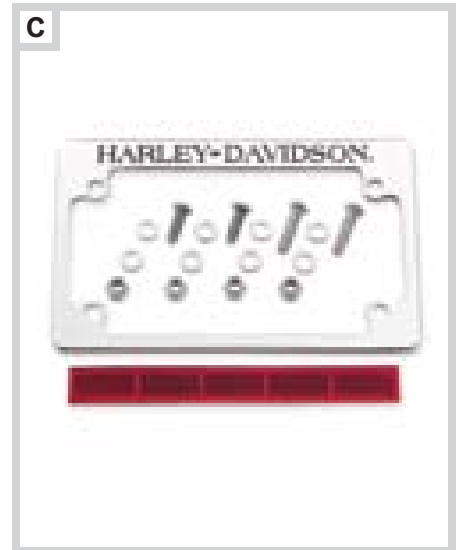

C. CHROME HARLEY-DAVIDSON LICENSE PLATE FRAME



D. CHROME "HARLEY-DAVIDSON" SCRIPT LICENSE PLATE FRAME



E. CHROME LICENSE PLATE FRAME

Notice: The prices appearing in this catalog are the manufacturer's suggested retail prices. Actual retail prices may vary.





**F. SKULL LICENSE PLATE MOUNTING HARDWARE**



**G. BAR & SHIELD LOGO LICENSE PLATE MOUNTING HARDWARE KIT**

**F. SKULL LICENSE PLATE MOUNTING HARDWARE**

Leave them looking at your "attitude". This complete license plate hardware kit features chrome-plated skull-shaped bolts with sinister black-filled eyes. The hardware is installed with a special open wrench to reduce the possibility of license plate theft. Kit includes four skull bolts, nuts, lock washers and the special wrench.

**94546-05** Universal (except Trike). **\$25.95**

**G. BAR & SHIELD LOGO LICENSE PLATE MOUNTING HARDWARE KIT**

Proudly display the Bar & Shield. The Bar & Shield logo shaped bolt heads on this unique chrome-plated stainless steel License Plate Mounting Kit stand out from the pack. The hardware is installed with a custom Bar & Shield logo shaped wrench, reducing the possibility of license plate theft. The kit includes four lock nuts, washers, bolts and the special wrench.

**94114-02** Universal (except Trike). **\$19.95**

**H. WILLIE G.® SKULL COLLECTION LICENSE PLATE HARDWARE KIT**

Your bike has an attitude front to back, and the final view they see should reflect it. This chrome-plated hardware kit features a skull logo set off by a black background. Sold in sets of four, includes 1/4"-20 x 3/4" fasteners with lock nuts and washers.

**41170-03** Universal (except Trike). **\$19.95**



**H. WILLIE G. SKULL COLLECTION LICENSE PLATE HARDWARE KIT**



**I. BAR & SHIELD LOGO LICENSE PLATE HARDWARE KIT**

**I. BAR & SHIELD LOGO LICENSE PLATE HARDWARE KIT**

This chrome-plated hardware kit features white Bar & Shield logos, set off by a black background. Sold in sets of four, these 1/4"-20 x 3/4" fasteners include lock nuts and washers.

**41161-01** Universal (except Trike). **\$19.95**

**J. LICENSE PLATE MOUNTING KIT WITH BUTTON HEAD SCREWS**

Kit contains two chrome button head screws, two chrome acorn nuts, two chrome flat washers and two chrome lock washers.

**94109-95** Universal fitment. **\$6.95**

**K. LICENSE PLATE MOUNTING KIT**

Kit contains two chrome 1/4-inch acorn nuts, two chrome 1/4-20 screws, and two chrome 1/4-inch lockwashers. Made in the U.S.A.

**94135-93T** Universal fitment. **\$5.95**



**J. LICENSE PLATE MOUNTING KIT WITH BUTTON HEAD SCREWS**



**K. LICENSE PLATE MOUNTING KIT**

*Notice: The prices appearing in this catalog are the manufacturer's suggested retail prices. Actual retail prices may vary.*

# WHEELS

*Upgrading your wheels is one of the quickest ways to overhaul the look of your bike. But your wheels shouldn't just look good; it's important that they stand up to the rigors of the road. Forged, cast or laced, you'll ride comfortably knowing Harley-Davidson® custom wheels meet the highest standards of performance and durability.*

## CHOOSE YOUR CUSTOM DIRECTION

### CHROME

*Chrome wheels always get instant attention. Adding a new set of wheels is the perfect way to kick off a custom effort or put on the finishing touches. We have both classic and contemporary styles to fit the character of your ride, so choose what'll work best with what you have in mind.*

### BLACK

*Black wheels set an aggressive tone for the rest of your bike. They're the perfect way to finalize your full-out Dark Custom™ effort or add a touch of black to balance the overall style direction of your ride. See which wheels speak loudest to you and watch as they instantly transform your bike's attitude.*

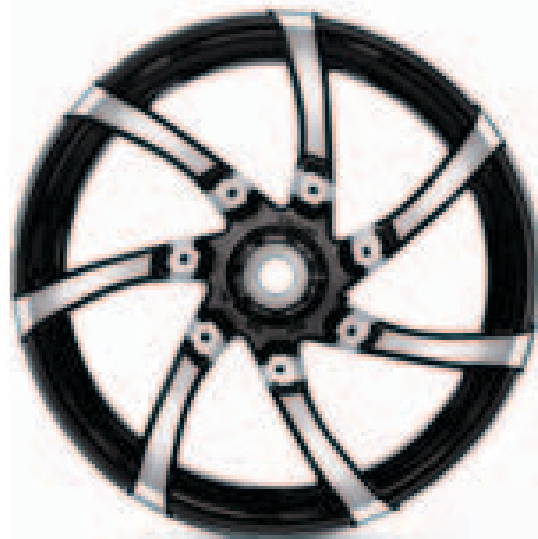

## STRENGTH AND STYLE

*From a visual perspective, the wheels, sprocket and brake rotors make up almost half of the motorcycle's profile, and set the styling direction for the whole bike. Choose wisely. Harley-Davidson® Forged, Cast and Laced wheels undergo thousands of hours of real-world testing to meet the highest standards of performance and durability. All Harley-Davidson wheels have been certified to perform to our tough vehicle standards for handling.*

### SEEING THE DIFFERENCE

#### FORGED WHEELS (BLADE FORGED WHEEL SHOWN)

**Performance Under Pressure** One-piece forged wheels are manufactured by squeezing a solid billet of aerospace-grade 6061-T6 aluminum under extreme pressure. The resulting material is very strong, so the final wheel design can have a lighter, more open style. The forging process aligns the metal grain for maximum strength, and the nonporous surface takes chrome like no other.

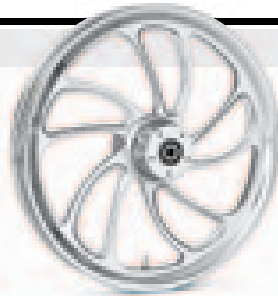

#### CAST WHEELS (REAPER CAST WHEEL SHOWN)

**Liquefied Metal** One-piece cast wheels are manufactured by pouring molten aircraft-grade aluminum into a wheel-shaped mold. This casting method allows the wheel design to feature hollow spokes and hubs for lighter weight, and permits incorporating styled surface textures that add visual interest. The casting process produces a wheel surface that is ideal for machining and polishing, and accepts both chrome and painted finishes for a distinctive look. Available in a wide variety of styles, cast wheels are an affordable customizing option.



### ORDERING PROCESS

#### CUSTOM WHEEL ORDERING PROCESS

**Step 1:** Select a wheel part number for your specific fitment.

**Step 2:** Select the wheel installation kit for your specific application (model, year and front or rear). Note: If your model is not specified in the wheel fitment, a wheel installation kit will not make the wheel fit your model.

**Step 3:** Refer to the instruction sheet included in your wheel kit to determine the necessary parts required from the installation kit.

**Step 4:** Use only Harley-Davidson approved tires. Using non-approved tires, tires from different manufacturers, or tires with non-matching tread patterns on the same motorcycle can adversely affect handling and stability.

#### WHEEL INSTALLATION KITS

Once you select your wheel style, select the Wheel Installation Kit designed specifically for your motorcycle. Kit includes the bearings and spacers required for installation.

### WHEEL INSTALLATION KITS

**43833-07** Front, 3/4" axle. **\$69.95**

Fits '00-'07 XL models, '00-'03 Dyna® models, '00-'05 FXDWG models, '00-'06 Softail® (except FLSTS and FLSTSC), and '08-later FLSTSB models.

**43848-08** Front, 1" axle. **\$69.95**

Fits '02-'07 VRSC™ models, '04-'07 Dyna models (except '04-'05 FXDWG) and '00-'07 Touring models.

**43851-08A** Front, 25mm axle. **\$69.95**

Fits '08-later FXDF, FXDWG, '07-later Softail models (except FLSTSC, FLSTSB, FXCW and FXCWC), '08-later Touring models (except Trike) with 16" or 17" front wheels without ABS brakes, and '09-later Sidecar.

**41452-08A** Front, 25mm axle. **\$69.95**

Fits '08-later XL and '08-later FXCW and FXCWC models.

**41455-08B** Front, 25mm axle. **\$69.95**

Fits '08-later VRSC models without ABS brakes, '08-later Dyna models (except FXDWG and FXDF) and '08-later Touring models (except Trike) with 18" front wheels without ABS brakes.

**41454-08A** Front, 25mm axle, ABS. **\$69.95**

Fits '08-later VRSC models with ABS brakes and '08-later Touring models (except Trike) with ABS brakes.

**43854-08** Rear, 3/4" axle. **\$69.95**

Fits '00-'04 XL models, '00-'05 Dyna models, '00-'07 Softail models and '00-'01 Touring models.

**43861-08** Rear, 1" axle. **\$69.95**

Fits '02-'07 VRSC models, '05-'07 XL models, '06-'07 Dyna models, and '02-'07 Touring models.

**43878-08** Rear, 25mm axle. **\$69.95**

Fits '08-later XL models, '08-later Softail models (except FXCW and FXCWC) and '08 Touring models without ABS brakes.

**41451-08** Rear, 25mm axle. **\$69.95**

Fits '08-later Dyna models.

**41453-08B** Rear, 25mm axle, ABS. **\$69.95**

Fits '08-later VRSC models with ABS brakes and '08-later Touring models (except Trike) with ABS brakes.

**41456-08B** Rear, 25mm axle. **\$69.95**

Fits '08-later VRSC models without ABS brakes, '08-later FXCW, FXCWC and '09-later Touring models (except Trike) without ABS brakes.

# 666 WHEELS

Reactor Collection

## A. REACTOR FIVE-SPOKE CUSTOM WHEEL

The five slim spokes of this custom wheel dramatically change the look of the VRSC™ motorcycle. Available in mirror-chrome or gloss black, the "ball-milled" spokes radiate from the unique center hub to blend with the machined rim, opening the bike for a light, sporting profile. The smooth curving rim, highlighted with machined grooves, adds to the true custom look without compromising strength or performance. The raised bosses on the hub carry the Original Equipment floating brake rotors, and add to the clean appearance of the installed wheel.

### 19" Front

Fits '02-later VRSC models. Requires separate purchase of model-specific Wheel Installation Kit. '07 VRSCX, '08 VRSCAW Anniversary models, and other models equipped with laced front wheels also require additional purchase of (2) Front Brake Rotors P/N 44553-06A.

**43219-08** Chrome. **\$1,119.95**

**43501-08** Gloss Black/Orange Stripe. **\$1,119.95**

### 18" Rear (240 Tire)

Fits '07-later VRSC models (except '07-'08 VRSCD and '07 VRSCR). Requires separate purchase of model-specific Wheel Installation Kit.

**43728-08** Chrome. **\$1,399.95**

**43616-08** Gloss Black/Orange Stripe. **\$1,399.95**

### 18" Rear (180/55 Tire)

Fits '02-'06 VRSCA and VRSCB models, '06-'08 VRSCD and '05-'07 VRSCR models. Requires separate purchase of model-specific Wheel Installation Kit.

**43215-08** Chrome. **\$1,199.95**



A. REACTOR FIVE-SPOKE CUSTOM WHEEL – CHROME



A. REACTOR FIVE-SPOKE CUSTOM WHEEL – GLOSS BLACK/ORANGE STRIPE

Notice: The prices appearing in this catalog are the manufacturer's suggested retail prices. Actual retail prices may vary.





**B**

**B. REACTOR FIVE-SPOKE CUSTOM WHEEL – GLOSS BLACK/ORANGE STRIPE (SHOWN WITH REACTOR BILLET SPROCKET AND COMPENSATOR BOWL)**

**B. REACTOR BILLET SPROCKET**

Styled to complement the Reactor Custom Wheels for VRSC™ models, the five thin spokes mirror the design of the wheel and add a light profile to the rear of the bike.

Fits '07-later VRSC models (except VRSCR). Separate purchase of bearing is required (P/N 40670-06 for '07 models and P/N 9254 for '08-later models).

<b>40161-09</b>	Chrome.	<b>\$499.95</b>
<b>40162-09</b>	Gloss Black/Orange Stripe.	<b>\$499.95</b>

Fits '02-'06 VRSC models (except '06 VRSCSE2). Also fits '07 VRSCR models.

<b>40229-04</b>	Chrome.	<b>\$499.95</b>
-----------------	---------	-----------------

**C. REACTOR SPROCKET COMPENSATOR BOWL**

Show off the back of your Reactor Wheel and Sprocket combination. This chrome-plated Sprocket Compensator Bowl replaces the Original Equipment painted part, and dresses up the view when you look through the open design of the Reactor Five-Spoke Custom Wheel. Kit reuses Original Equipment compensator cushion.

Fits '07-later VRSC™ models (except VRSCR) equipped with Reactor Five-Spoke Custom Rear Wheel.

<b>40169-09</b>	Gloss Black.	<b>\$49.95</b>
<b>40168-09</b>	Chrome.	<b>\$49.95</b>

Fits '02-'06 VRSC models (except '06 VRSCSE2) and '07 VRSCR and '07-'08 VRSCD models equipped with Reactor Five-Spoke Custom Wheel.

<b>40541-05</b>	Chrome.	<b>\$49.95</b>
-----------------	---------	----------------

**D. BLACK 5-SPOKE CAST ALUMINUM WHEEL**

Dress your V-Rod® in the latest style. First introduced on the 2008 Night Rod®, these black and polished 5-Spoke Wheels add a touch of attitude to your early VRSC™ model.

<b>43634-08</b>	19" Front.	<b>\$342.00</b>
-----------------	------------	-----------------

Fits '02-'07 VRSC models. Requires separate purchase of model-specific Wheel Installation Kit P/N 43848-08. '07 VRSCX models and other models equipped with laced front wheel also require additional purchase of (2) Front Brake Rotors P/N 44553-06A.

<b>43635-08</b>	18" Rear (180/55 Tire).	<b>\$342.00</b>
-----------------	-------------------------	-----------------

Fits '02-'06 VRSCA and VRSCB models and '06-'07 VRSCD and VRSCR models. Does not fit models equipped with 240mm rear tire. Requires separate purchase of model-specific Wheel Installation Kit P/N 43861-08.



**B**

**B. REACTOR BILLET SPROCKET – CHROME**



**B**

**B. REACTOR BILLET SPROCKET – GLOSS BLACK/ORANGE STRIPE**



**C**

**C. REACTOR SPROCKET COMPENSATOR BOWL – CHROME AND GLOSS BLACK**



**D**

**D. BLACK 5-SPOKE CAST ALUMINUM WHEEL**

*Notice: The prices appearing in this catalog are the manufacturer's suggested retail prices. Actual retail prices may vary.*

# 668 WHEELS

Magnum 5 Collection

## A. MAGNUM 5 CUSTOM WHEEL

Click off the safety and pull the trigger for a true custom ride. The bold, brawny design is inspired by the steel of a large-frame revolver. This one-piece cast aluminum wheel features high-impact styling, with 15 individual spokes that converge to form five distinct columns. The cast-in "rivets" visually tie the oval cross-section spokes to the rim and the hub. Finished in brilliant chrome, these wheels hit the styling target like a high-velocity bullet. All Genuine Motor Accessory wheels have been certified by Harley-Davidson to perform to our tough vehicle standards for handling, quality and durability. Requires separate purchase of model-specific Wheel Installation Kits.

### 21" Front

Fits '00-later FXST, FXSTD (except FXSTDSE), FXSTS, FXSTB, FXSTC and FXDWG models.

**40806-09** Chrome. **\$549.95**

### 19" Front

Fits '06-later Dyna® models (except FXDWG, FXDF and FXDFSE/2). Installation on models equipped with Original Equipment laced wheel will require separate purchase of Floating Brake Rotor P/N 42040-06. Does not fit with chrome Front Wheel Spacer Kit P/N 41420-08.

**43621-09** Chrome. **\$549.95**

### 17" Rear

Fits '08-later FXST, FXSTB, and FXSTC models.

**40803-09** Chrome. **\$549.95**

Fits '06-later Dyna models (except FXDF) and '00-'07 FXSTD models.

**43636-09** Chrome. **\$549.95**



A. MAGNUM 5 CUSTOM WHEEL – CHROME 19"



A. MAGNUM 5 CUSTOM WHEEL – CHROME 21"



See pages 685 for matching Sprocket Covers.

Notice: The prices appearing in this catalog are the manufacturer's suggested retail prices. Actual retail prices may vary.

# WHEELS 669

*Typhoon Collection*

NEW

B



**B. TYPHOON CUSTOM WHEEL – MIRROR CHROME 21"**

## B. TYPHOON CUSTOM WHEELS

An intense storm is brewing. Nine arching spokes spin outward from the hub and blend seamlessly with the rim to add forward motion, even while standing still. The flat profile spokes and carved webs add visual intensity, and the available mirror chrome or cut back black finishes let you tailor your bike to fit the mood. These cast aluminum wheels have undergone hundreds of hours of real-world testing to meet the highest standards of performance and durability. Requires separate purchase of model-specific Wheel Installation Kits.

### 21" Front

Fits '00-later FXST, FXSTD (except FXSTDSE), FXSTS, FXSTB, FXSTC and '00-later FXDWG and '08 FXDSE2 models.

<b>40882-08</b>	Mirror Chrome.	<b>\$549.95</b>
<b>40141-10</b>	Cut Back Black.	<b>\$449.95</b>

### 19" Front

Fits '06-later Dyna® models (except FXDWG, FXDF and FXDFSE/2). Installation on models equipped with Original Equipment laced wheel will require separate purchase of model-specific floating brake rotor. See I-Sheet for part number. Does not fit with chrome Front Wheel Spacer Kit P/N 41420-08.

<b>44615-08</b>	Mirror Chrome.	<b>\$549.95</b>
<b>40774-10</b>	Cut Back Black.	<b>\$449.95</b>

### 17" Rear

Fits '08-later FXST, FXSTB, and FXSTC models.

<b>40884-08</b>	Mirror Chrome.	<b>\$549.95</b>
<b>40156-10</b>	Cut Back Black.	<b>\$449.95</b>

### 17" Rear

Fits '06-later Dyna models (except FXDF) and '00-'07 FXSTD models.

<b>44617-08</b>	Mirror Chrome.	<b>\$549.95</b>
<b>40776-10</b>	Cut Back Black.	<b>\$449.95</b>

NEW

B



**B. TYPHOON CUSTOM WHEEL – CUT BACK BLACK 21"**

WHEELS



See pages 685 for matching Sprocket Covers.

Notice: The prices appearing in this catalog are the manufacturer's suggested retail prices. Actual retail prices may vary.

# 670 WHEELS

Agitator Collection

## A. AGITATOR CUSTOM WHEEL

Get ready to stir things up. The seven forward-facing spokes of these Agitator Wheels dig deep into the soul for maximum custom impact. Spiraling from the custom hub, the flat profile spokes blend to the edge of the 18" rim, minimizing the profile of the wheel and adding an open look that's easy to see around the matching floating brake rotors. Available in your choice of Mirror Chrome or Contrast Chrome finish, these wheels will set the stage for your custom direction. The black and chrome Contrast Chrome finish was developed by Harley-Davidson to add a sinister look to your custom ride, while the fully-polished mirror-chrome option throws flashes of light with every movement. These cast aluminum wheels have undergone hundreds of hours of real-world testing to meet the highest standards of performance and durability. Requires separate purchase of model-specific Wheel Installation Kit.

### 18" Front

Fits '09-later Touring models (except Trike). Requires separate purchase of 18" Tire, and Floating Brake Rotors P/N 48981-10 and 49000-10. See your Dealer for details.

**40268-10** Contrast Chrome. **\$499.95**

Fits '09-later Road King® and Road Glide® models. Requires separate purchase of 18" Tire and Floating Brake Rotors P/N 48981-10 and 49000-10. See your Dealer for details.

**47957-10** Mirror Chrome. **\$749.95**

### 18" Rear

Fits '09-later Touring models (except Trike). Requires separate purchase of Tire and model-specific wheel Installation Kit. See your Dealer for details.

**40225-10** Contrast Chrome. **\$499.95**

Fits '09-later Road King and Road Glide models. Requires separate purchase of 18" Tire and model-specific wheel installation kit. See your Dealer for details.

**47951-10** Mirror Chrome. **\$749.95**

### Shown with:

#### AGITATOR FLOATING BRAKE ROTORS

Fits '09-later Touring models (except Trike) equipped with Agitator Custom Front Wheel P/N 40268-10 or 47957-10.

**48981-10** Front Right. **\$149.95**

**49000-10** Front Left. **\$149.95**

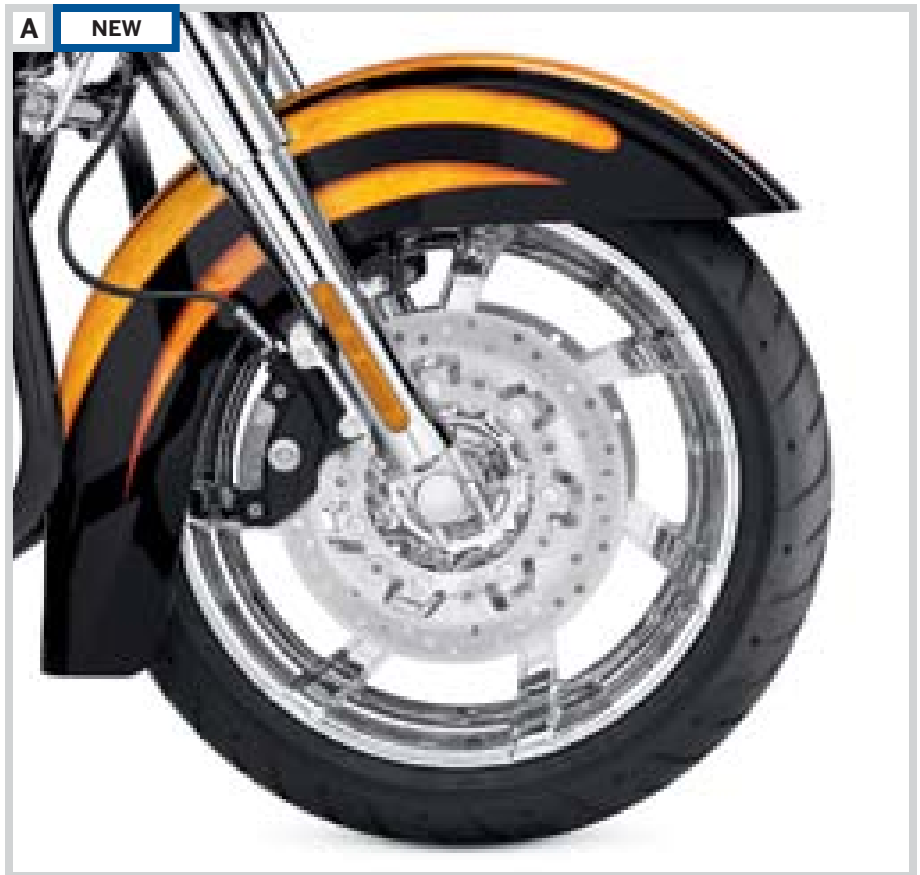

A. AGITATOR CUSTOM WHEEL – MIRROR CHROME



A. AGITATOR CUSTOM WHEEL – CONTRAST CHROME

Notice: The prices appearing in this catalog are the manufacturer's suggested retail prices. Actual retail prices may vary.



NEW

B



**B. STINGER CUSTOM WHEEL – 18" SOFTAIL**

**B. STINGER CUSTOM WHEEL**

Scratch your customizing itch. This cutting edge 5-spoke Stinger wheel is designed to draw your eye and hold your attention. The spiral spokes radiate from the fluted hub imparting a sense of motion, and their slim cross section creates an open and airy profile. These fully polished and mirror-chrome finished 18" wheels feature a deeply notched rim that adds visual interest, and can be accented with matching Stinger Sprockets and custom wave-accented floating brake rotors. These cast aluminum wheels have undergone hundreds of hours of real-world testing to meet the highest standards of performance and durability. Requires separate purchase of model-specific Wheel Installation Kit.

**18" Front**

Fits '08-later FXDF and FXDFSE models. Requires separate purchase of Tire and model-specific wheel Installation Kit. See your Dealer for details.

**47831-10 \$749.95**

Fits '08-later FLSTF, FLSTFB and FLSTSB models. Requires separate purchase of Tire and model-specific wheel Installation Kit. See your Dealer for details. FLSTSB fitments require separate purchase of Spacer Kit P/N 41533-10.

**41503-10 \$749.95**

**18" Rear**

Fits '08-later FXDF and FXDFSE models. Requires separate purchase of Tire and model-specific wheel Installation Kit. See your Dealer for details.

**47835-10 \$749.95**

Fits '08-later FLSTF, FLSTFB and FLSTSB models. Requires separate purchase of Tire and model-specific wheel Installation Kit. See your Dealer for details.

**41509-10 \$749.95**

**Shown with:**

**STINGER CUSTOM FLOATING BRAKE ROTORS**

Complete the custom look with these front and rear Stinger Floating Rotors, styled to complement the Stinger Wheels. The chrome-plated steel inner spider features spiral spokes and cut-outs to match the wheel, and is mounted to a premium quality stainless steel outer rotor. Both front and rear rotors come complete with new mounting hardware.

**48993-10 Front Left. \$189.95**

Fits '00-later Softail® models.

**48977-10 Front Left. \$189.95**

Fits '06-later Dyna® models with barrel-shaped wheel hub. (Available September 2009)

**48978-10 Front Right. \$189.95**

Fits '06-later Dyna models with dual disc brakes and barrel-shaped wheel hub. (Available September 2009)

**48979-10 Rear. \$189.95**

Fits '00-later Dyna and Softail models.

**Also available:**

**STINGER BILLET SPROCKET**

Designed to complement the Stinger wheel's styling, these custom sprockets are manufactured from 6061-T6 forged billet aluminum, and precision machined to exacting Original Equipment standards. Harley-Davidson® custom sprockets are finished with a proprietary process that combines the decorative chrome with a wear resistant surface applied to the teeth. The sprockets feature a five year tooth wear warranty.

**37833-10 \$399.95**

Fits '07-later Dyna models. Does not fit Japanese models.

**37834-10 \$399.95**

Fits '07-later FXST, FXSTB, FXSTC, FLSTF, FLSTFB and FLSTSB models. Does not fit Japanese models.

NEW

B



**B. STINGER CUSTOM WHEEL – 18" DYNA**

WHEELS

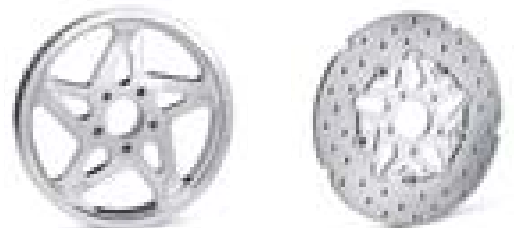

Notice: The prices appearing in this catalog are the manufacturer's suggested retail prices. Actual retail prices may vary.

## 672 WHEELS

28 Spoke & Roulette Wheels

### A. 28-SPOKE WHEEL – CHROME CONTRAST

Add the brilliance of chrome without changing the distinctive custom style of your Touring motorcycle. Original Equipment on the '10 Electra Glide Ultra Limited model, this meticulously polished and chrome-plated version of the Original Equipment 28-spoke cast aluminum wheel casts glowing reflections, even while standing still. These wheels are finished with a revolutionary process where the wheels are painted gloss black, machined and polished, and then the exposed surfaces are plated for a brilliant contrast. These cast aluminum wheels have undergone hundreds of hours of real-world testing to meet the highest standards of performance and durability. Requires separate purchase of model-specific Wheel Installation Kit.

Fits '09-later Touring models (except Trike). Requires separate purchase of model-specific wheel Installation Kit.

<b>42195-10</b>	17" Front.	<b>\$499.95</b>
<b>42196-10</b>	16" Rear.	<b>\$499.95</b>



A. 28-SPOKE WHEEL – CHROME CONTRAST

### B. ROULETTE CUSTOM WHEEL

When you take this wheel for a spin, you're always a winner. Stunning mirror-chrome cast wheel features eleven slim spokes that blend with the rim for eye-catching style. The unique spoke shape stands proud on the rim's edge, mimicking the pockets on a roulette wheel. The surface catches and reflects light, just as the raised ridges deflect the spinning roulette ball. Complementing brake rotors are available for a custom look. Requires separate purchase of model-specific Wheel Installation Kit.

Fits '09-later Touring models (except Trike).

<b>42171-09</b>	17" Front.	<b>\$749.95</b>
<b>42170-09</b>	16" Rear.	<b>\$749.95</b>



B. ROULETTE CUSTOM WHEEL – 17"

Notice: The prices appearing in this catalog are the manufacturer's suggested retail prices. Actual retail prices may vary.

# WHEELS 673

Nine-Spoke & Switchblade Wheels



NEW

C

C. CHROME NINE-SPOKE CAST WHEEL

## C. CHROME NINE-SPOKE CAST WHEEL

Add a splash of chrome. These fully polished wheels are styled to match the popular nine-spoke design featured on traditional Touring models. More than just a chrome-plated Original Equipment Touring Wheel, these wheels utilize tooling developed specifically for chrome-plating to give a near perfect finish without the "waves" created when polishing the Original Equipment cast wheel. The rib on the Original Equipment wheel spoke has been removed to provide a smooth uninterrupted look, and countless hours of polishing result in a superior finish. Special masking was developed to prevent plating contamination inside bolt holes and bearing bores. All Genuine Motor Accessory wheels have been certified by Harley-Davidson to perform to our tough vehicle standards for handling, quality and durability. Wheel kits require separate purchase of model-specific Wheel Installation Kit.

### 17" Front

**41886-09** **\$549.95**

Fits '09-later Touring models (except Trike).  
Also fits '09-later sidecars.

### 16" Front

**41880-07** **\$549.95**

Fits '00-later FLST, FLSTC, FLSTN, and '00-'06 FLSTF models (except '06 FLSTFSE2).

**41886-07** **\$549.95**

Fits '00-'08 Touring models. Also fits '09-later FLHRC models.

### 16" Rear

**41889-09** **\$749.95**

Fits '09-later Touring models (except Trike).

**41883-07** **\$549.95**

Fits '03-'07 FLST, FLSTN, FLSTC, '03-'06 FLSTF (except FLSTFSE2), and '03-'05 FXST, FXSTB and FXSTS models.

**41889-07** **\$549.95**

Fits '00-later XL models, '00-'05 Dyna models, '00-'02 Softail models (except FXSTD), and '00-'08 Touring models.

**40789-08** **\$549.95**

Fits '08-later FLSTN and FLSTC models.



NEW

D

D. SWITCHBLADE CUSTOM WHEEL – MIRROR CHROME

## D. SWITCHBLADE CUSTOM WHEEL – MIRROR CHROME

Add the brilliance of chrome without changing the distinctive custom style of your Dyna motorcycle. This meticulously polished and chrome-plated version of the Original Equipment 10-spoke cast aluminum wheel casts glowing reflections, even while standing still. These wheels, chromed to the same strict standards you have come to expect from Harley-Davidson, are plated using custom masking that provides contamination-free bolt holes and bearing bores. This allows the installed bearings to fit as precisely as on our Original Equipment wheels, so you can be confident these wheels will ride as smooth as they look. Requires separate purchase of model-specific Wheel Installation Kit.

**40359-10** 19" Front. **\$449.95**

Fits '08-later Dyna® models (except FXDWG and FXDF).

Requires separate purchase of model-specific Wheel

Installation Kit. Installation on models equipped with

Original Equipment laced wheel will require separate

purchase of model-specific floating brake rotor.

See I-Sheet for part number.

**40386-10** 17" Rear. **\$449.95**

Fits '08-later Dyna models (except FXDWG and FXDF).

WHEELS

Notice: The prices appearing in this catalog are the manufacturer's suggested retail prices. Actual retail prices may vary.

# 674 WHEELS

Reaper Collection

## A. REAPER CUSTOM WHEEL

Step out from behind the black shroud. Brilliant chrome-plated cast wheels feature a forward slashing scythe design that radiates from the compact center hub. Honed to a "razor's edge", the five curved blade spokes blend with the rim to provide a look of continuous motion. Cast of premium quality aluminum, the polished hub, spokes and rim are polished to a mirror finish before they are drenched in chrome. Matching sprockets are available for a complete custom look. Requires separate purchase of model-specific Wheel Installation Kit.

**40778-08** 21" Front. **\$749.95**

Fits '00-later FXST, FXSTD (except FXSTDSE), FXSTS, FXSTB, FXSTC and '00-later FXDWG models.

**40790-09** 18" Front. **\$749.95**

Fits '04-later Touring models (except Trike). Requires separate purchase of 18" Tire and Brake Rotors. See your dealer or the instruction sheet for specific part numbers.

**41983-08** 19" Front. **\$749.95**

Fits '06-later Dyna® models (except FXDWG and FXDF). Installation on models equipped with Original Equipment laced wheel will require separate purchase of model-specific floating brake rotor. See I-Sheet for part number.

**40779-08** 17" Front. **\$749.95**

Fits '08-later FLSTF and FLSTFB models. Recommend separate purchase of Floating Brake Rotor.

**40802-08** 17" Rear. **\$749.95**

Fits '08-later FXST, FXSTB, FXSTC, FLSTF, and FLSTFB models.

**41981-08** 17" Rear. **\$749.95**

Fits '06-later Dyna models (except FXDF) and '00-'07 FXSTD models.

**40792-09** 16" Rear. **\$749.95**

Fits '09-later Touring models (except Trike).



A. REAPER CUSTOM WHEEL – 21"



A. REAPER CUSTOM WHEEL – 18"

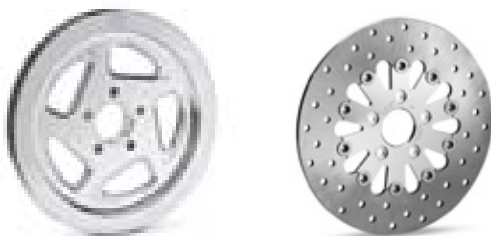

See pages 686-689 for matching Rotors and Sprockets.

Notice: The prices appearing in this catalog are the manufacturer's suggested retail prices. Actual retail prices may vary.



# WHEELS 675

Revolver Collection



B

B. REVOLVER TEN-SPOKE CUSTOM WHEEL – 21"

## B. REVOLVER TEN-SPOKE CUSTOM WHEEL

The ten slim spokes and the mirror-finish chrome hub dramatically alter the look of your custom motorcycle. The "ball-milled" spokes radiate from the unique revolver cylinder-shaped hub, and blend with the smooth rim for a light, open look. Forged from 6061 aircraft aluminum, the mirror-finish chrome surfaces resist the elements and are easy to maintain. Complete the custom look by adding complementing Revolver Brake Rotors and Revolver Sprockets. Requires separate purchase of model-specific Wheel Installation Kit.

**40743-07** 21" Front. **\$1,199.95**  
Fits '00-later XL and '00-'05 Dyna® models (except FXDWG).

**40744-07** 21" Front. **\$1,199.95**  
Fits '00-later FXST, FXSTD (except FXSTDSE), FXSTS, FXSTB, FXSTC and '00-later FXDWG models.

**40738-07** 19" Front. **\$1,199.95**  
Fits '00-later XL and '00-'05 Dyna models (except FXDWG).

**40721-08** 16" Front. **\$1,199.95**  
Fits '00-'08 Touring models. Also fits '09-later FLHRC models.

**40720-07** 16" Front. **\$1,199.95**  
Fits '00-later FLST, FLSTC, FLSTN, and '00-'06 FLSTF models (except '06 FLSTFSE2).

**40839-08** 17" Rear. **\$1,249.95**  
Fits '08-later FXST, FXSTB, FXSTC, FLSTF, and FLSTFB models.

**41734-08** 17" Rear. **\$1,249.95**  
Fits '07 FXST, FXSTB, FXSTC and FLSTF models.

**40756-08** 16" Rear. **\$1,249.95**  
Fits '08-later FLSTN and FLSTC models.

**40722-08** 16" Rear. **\$1,249.95**  
Fits '03-'07 FLST, FLSTN, FLSTC, '03-'06 FLSTF (except FLSTFSE2), and '03-'05 FXST, FXSTB and FXSTS models.

**40723-08** 16" Rear. **\$1,249.95**  
Fits '00-later XL models, '00-'05 Dyna models, '00-'02 Softail® (except FXSTD), and '00-'08 Touring models.



B

B. REVOLVER TEN-SPOKE CUSTOM WHEEL – 16"

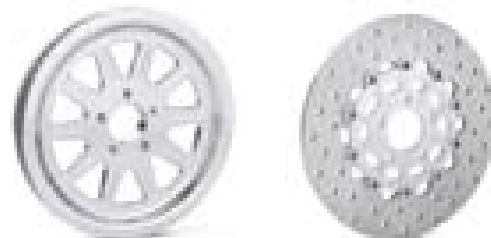

See pages 686–689 for matching Rotors and Sprockets.

Notice: The prices appearing in this catalog are the manufacturer's suggested retail prices. Actual retail prices may vary.

# 676 WHEELS

Blade Collection

## A. BLADE CUSTOM WHEEL

Slash your way to the front of the custom pack. Slick custom wheel design features ten slim spokes that flow from the center hub and spiral rearward to blend with the outer rim. Forged for strength from 6061 aluminum, the mirror-polished surface is chrome-plated for a brilliant shine. The forged surfaces resist the elements, and are easy to clean and maintain. Complete the custom look with a complementing Blade Billet Sprocket and brake rotors. Requires separate purchase of model-specific Wheel Installation Kit.

**21" Front**  
**41681-07** **\$1,199.95**  
 Fits '00-later FXST, FXSTD (except FXSTDSE), FXSTS, FXSTB, FXSTC and '00-later FXDWG models.

**18" Front**  
**40818-08** **\$1,199.95**  
 Fits '04-later Touring models (except Trike). Requires separate purchase of 18" Tire and Brake Rotors. See your dealer or the instruction sheet for specific part numbers.

**17" Front**  
**42191-07** Fits '07 FLSTF models. **\$1,199.95**  
**42191-08** **\$1,199.95**  
 Fits '08-later FLSTF and FLSTFB models.

**16" Front**  
**40820-08** **\$1,199.95**  
 Fits '00-'08 Touring models. Also fits '09-later FLHRC models.

**40822-08** **\$1,199.95**  
 Fits '00-later FLST, FLSTC, FLSTN, and '00-'06 FLSTF models (except '06 FLSTFSE2).

**18" Rear**  
**42091-09** **\$1,399.95**  
 Fits '09-later Touring models (except Trike). Requires separate purchase of 18" tire. See your local dealer or the instruction sheet for specific part number.

**17" Rear**  
**40701-08** **\$1,249.95**  
 Fits '08-later FXST, FXSTB, FXSTC, FLSTF, and FLSTFB models.

**41567-08** **\$1,249.95**  
 Fits '07 FXST, FXSTB, FXSTC and FLSTF models.

~~**41680-08** **\$1,249.95**~~ **OBSOLETE**  
~~Fits '06 FXST, FXSTB, FXSTS and '06 FLSTFSE models.~~

**16" Rear**  
**40814-08** **\$1,249.95**  
 Fits '08-later FLSTN and FLSTC models.

**40816-08** **\$1,249.95**  
 Fits '00-'05 Dyna® models, '00-'02 Softail® (except FXSTD), and '00-'08 Touring models.



A. BLADE CUSTOM WHEEL – 21"



See pages 686–689 for matching Rotors and Sprockets.



A. BLADE CUSTOM WHEEL – 17"



A. BLADE CUSTOM WHEEL – 18"

Notice: The prices appearing in this catalog are the manufacturer's suggested retail prices. Actual retail prices may vary.



**B. ROAD WINDER CUSTOM WHEEL – 21"**



**B. ROAD WINDER CUSTOM WHEEL – 19" (DYNA SHOWN)**



**B. ROAD WINDER CUSTOM WHEEL – 19"**

## B. ROAD WINDER CUSTOM WHEEL

Take your custom ride in a new direction. The directional spokes of the one-piece Road Winder wheel add the look of forward motion even while standing still. The slim spokes open the wheel visually, and showcase the available matching brake rotors and sprockets. Forged from 6061 aluminum, the mirror-finish chrome surface and rim-edge details are easy to maintain and offer great resistance to the elements. Matching brake rotors and sprockets are available for a complete custom look. Requires separate purchase of model-specific Wheel Installation Kit.

**44634-07** 21" Front. **\$1,199.95**  
Fits '00-later FXST, FXSTD (except FXSTDSE), FXSTS, FXSTB, FXSTC and '00-later FXDWG models.

**44666-07** 21" Front. **\$1,199.95**  
Fits '00-later XL and '00-'05 Dyna® models (except FXDWG).

**44689-08** 19" Front. **\$1,199.95**  
Fits '06-later Dyna models (except FXDWG, FXDF and FXDFSE/2). Installation on models equipped with Original Equipment laced wheel will require separate purchase of model-specific floating brake rotor. Does not fit with chrome Front Wheel Spacer Kit P/N 41420-08.

**44659-07** 19" Front. **\$1,199.95**  
Fits '00-later XL, '00-'05 Dyna (except FXDWG) and '08-later FXCW and FXCWC models. Does not fit with Chrome Front Wheel Spacer Kit P/N 41522-08.

**44612-07** 18" Front. **\$1,199.95**  
Fits '04-'08 Touring models. Requires separate purchase of 18" Tire and Brake Rotors. See your dealer or the instruction sheet for specific part numbers.

**41406-08** 17" Front. **\$1,199.95**  
Fits '08-later FLSTF and FLSTFB models.

**41406-07** 17" Front. **\$1,199.95**  
Fits '07 FLSTF models.

**44632-07** 16" Front. **\$1,199.95**  
Fits '00-later FLST, FLSTC, FLSTN, and '00-'06 FLSTF models (except '06 FLSTFSE2).

**44633-08** 16" Front. **\$1,199.95**  
Fits '00-'08 Touring models. Also fits '09-later FLHRC models.

**43199-09** 18" Rear. **\$1,399.95**  
Fits '08-later FXCW and FXCWC models.

**44654-07** 17" Rear. **\$1,249.95**  
Fits '00-'07 FXSTD and '06-later Dyna models (except FXDF).

**43387-08** 17" Rear. **\$1,249.95**  
Fits '08-later FXST, FXSTB, FXSTC, FLSTF, and FLSTFB models.

**42137-08** 17" Rear. **\$1,249.95**  
Fits '07 FXST, FXSTB, FXSTC and FLSTF models.

**41655-08** 17" Rear. **\$1,249.95**  
Fits '06 FXST, FXSTB, FXSTS, and '06 FLSTFSE models.

**44636-08** 16" Rear. **\$1,249.95**  
Fits '00-'05 Dyna, '00-'02 Softail® (except FXSTD), and '00-'08 Touring models.

**44637-08** 16" Rear. **\$1,249.95**  
Fits '03-'07 FLST, FLSTN, FLSTC, '03-'06 FLSTF (except FLSTFSE2), and '03-'05 FXST, FXSTB and FXSTS models.

**40758-08** 16" Rear. **\$1,249.95**  
Fits '08-later FLSTN and FLSTC models.



See pages 686–689 for matching Rotors and Sprockets.

Notice: The prices appearing in this catalog are the manufacturer's suggested retail prices. Actual retail prices may vary.



# 678 WHEELS

Slotted Six-Spoke Collection

## A. SLOTTED SIX-SPOKE WHEEL

A dramatic look that breaks the mold in motorcycle wheel styling. Available in black or chrome, this stylish custom wheel incorporates the strength of twelve spokes into the illusion of a lightweight six spoke design. Textured fingerlike slots radiate from the center to the uniquely rounded smooth finishes on the inner and outer rim. The combination of polished and textured finishes on the spokes, rim and hub fool the eye and add to the sleek appearance, while the premium quality cast aluminum construction reduces weight without compromising strength. Matching brake rotors and sprockets are available for a complete custom look. All Genuine Motor Accessory wheels have been certified by Harley-Davidson to perform to our tough vehicle standards for handling, quality and durability. Requires separate purchase of model-specific Wheel Installation Kit.

### 21" Front

Fits '00-later FXST, FXSTD (except FXSTDSE), FXSTS, FXSTB, FXSTC and '00-later FXDWG and '08 FXDSE2 models.

<b>43924-07</b>	Textured Chrome.	<b>\$549.95</b>
<b>43925-07</b>	Textured Black.	<b>\$399.95</b>
<b>43973-08</b>	Mirror Chrome.	<b>\$749.95</b>

Fits '00-later XL and '00-'05 Dyna® models (except FXDWG).

<b>44055-07</b>	Textured Chrome.	<b>\$549.95</b>
<b>44056-07</b>	Textured Black.	<b>\$399.95</b>

### 19" Front

Fits '06-later Dyna models (except FXDWG and FXDF). Installation on models equipped with Original Equipment cast wheel will require separate purchase of Floating Brake Rotor P/N 42040-06.

<b>43538-09</b>	Mirror Chrome.	<b>\$749.95</b>
<b>43549-09</b>	Textured Chrome.	<b>\$549.95</b>
<b>43577-09</b>	Textured Black.	<b>\$399.95</b>

Fits '00-later XL and '00-'05 Dyna models (except FXDWG).

<b>44058-07</b>	Textured Chrome.	<b>\$549.95</b>
<b>44057-07</b>	Textured Black.	<b>\$399.95</b>

### 16" Front

Fits '00-'08 Touring models. Also fits '09-later FLHRC models.

<b>43920-08</b>	Textured Chrome.	<b>\$549.95</b>
<b>43921-08</b>	Textured Black.	<b>\$399.95</b>

Fits '00-later FLST, FLSTC, FLSTN, and '00-'06 FLSTF models (except '06 FLSTFSE2).

<b>43918-07</b>	Textured Chrome.	<b>\$549.95</b>
<b>43919-07</b>	Textured Black.	<b>\$399.95</b>

### 16" Rear

Fits '03-'07 FLST, FLSTN and FLSTC, '03-'06 FLSTF (except FLSTFSE2) and '03-'05 FXST, FXSTB and FXSTS models.

<b>43930-08</b>	Textured Chrome.	<b>\$549.95</b>
<b>43931-08</b>	Textured Black.	<b>\$399.95</b>

Fits '00-later XL models, '00-'05 Dyna models, '00-'02 Softail® models (except FXSTD), and '00-'08 Touring models.

<b>43928-08</b>	Textured Chrome.	<b>\$549.95</b>
<b>43929-08</b>	Textured Black.	<b>\$399.95</b>

Fits '08-later FLSTN and FLSTC models.

<b>40825-08</b>	Textured Chrome.	<b>\$549.95</b>
<b>40827-08</b>	Textured Black.	<b>\$399.95</b>

### 17" Rear

Fits '00-later FXSTD and '06-later Dyna models (except FXDF).

<b>43934-07</b>	Textured Chrome.	<b>\$549.95</b>
<b>43942-07</b>	Textured Black.	<b>\$399.95</b>
<b>43972-08</b>	Mirror Chrome.	<b>\$749.95</b>



Mirror Chrome

Textured Chrome

Textured Black



A. SLOTTED SIX-SPOKE WHEEL – 21"



A. TEXTURED BLACK SLOTTED SIX-SPOKE WHEEL – 19"



A. TEXTURED BLACK SLOTTED SIX-SPOKE WHEEL – 16"

See pages 686–689 for matching Rotors and Sprockets.

Notice: The prices appearing in this catalog are the manufacturer's suggested retail prices. Actual retail prices may vary.



NEW

B



Mirror Chrome

Textured Chrome

Textured Black



**B. MIRROR CHROME THUNDERSTAR CUSTOM WHEEL – 19"**



B

**B. TEXTURED BLACK THUNDERSTAR CUSTOM WHEEL – 21"**



B

**B. TEXTURED CHROME THUNDERSTAR CUSTOM WHEEL – 21"**

## B. THUNDERSTAR™ CUSTOM WHEEL

Impressive styling and performance all rolled into one, these premium quality cast aluminum wheels are named for their striking five-spoke design. Available in three different finishes, these wheels offer a captivating style. The Mirror Chrome wheels feature chrome-plated polished surfaces for a glass-smooth look, and the Textured Chrome wheels feature complementing chrome-plated polished spokes and textured webs for a light-grabbing finish. For a sinister look, the Textured Black wheels feature satin-finish machined spokes and matte-black textured webs. Finish the look by adding matching ThunderStar floating brake rotors.

Branded with the signature Bar & Shield logo boldly cast into the spoke, these ThunderStar Custom Wheels are without a doubt, a genuine H-D exclusive. All Genuine Motor Accessory wheels have been certified by Harley-Davidson to perform to our tough vehicle standards for handling, quality and durability. Requires separate purchase of model-specific Wheel Installation Kit.

### 21" Front

Fits '00-later FXST, FXSTD (except FXSTDSE), FXSTS, FXSTB, FXSTC and '00-later FXDWG.

<b>43975-07</b>	Textured Chrome.	<b>\$549.95</b>
<b>43773-07</b>	Textured Black.	<b>\$399.95</b>
<b>43602-07</b>	Mirror Chrome.	<b>\$749.95</b>

### 19" Front

Fits '00-later XL and '00-'05 Dyna® models (except FXDWG).

<b>44323-07</b>	Textured Chrome.	<b>\$549.95</b>
<b>44322-07</b>	Textured Black.	<b>\$399.95</b>
<b>44282-07</b>	Mirror Chrome.	<b>\$749.95</b>

### 17" Front

Fits '09-later Touring models (except Trike and '10 FLHX).

<b>40943-09</b>	Textured Chrome.	<b>\$549.95</b>
<b>40996-09</b>	Textured Black.	<b>\$399.95</b>
<b>40966-09</b>	Mirror Chrome.	<b>\$749.95</b>

### 16" Front

Fits '00-later FLST, FLSTC, FLSTN, and '00-'06 FLSTF models (except '06 FLSTFSE2).

<b>43978-07</b>	Textured Chrome.	<b>\$549.95</b>
<b>43771-07</b>	Textured Black.	<b>\$399.95</b>
<b>43609-07</b>	Mirror Chrome.	<b>\$749.95</b>

Fits '00-'08 Touring models. Also fits '09-later FLHRC models.

<b>43573-08</b>	Textured Chrome.	<b>\$549.95</b>
<b>43575-08</b>	Textured Black.	<b>\$399.95</b>
<b>43703-08</b>	Mirror Chrome.	<b>\$749.95</b>

### 16" Rear

Fits '08-later FLSTN and FLSTC models.

<b>40831-08</b>	Textured Chrome.	<b>\$549.95</b>
<b>40833-08</b>	Textured Black.	<b>\$399.95</b>
<b>40835-08</b>	Mirror Chrome.	<b>\$749.95</b>

Fits '09-later Touring models (except Trike).

<b>40880-09</b>	Textured Chrome.	<b>\$549.95</b>
<b>40885-09</b>	Textured Black.	<b>\$399.95</b>
<b>40881-09</b>	Mirror Chrome.	<b>\$749.95</b>

Fits '00-later XL models, '00-'05 Dyna models, '00-'02 Softail® models (except FXSTD), and '00-'08 Touring models.

<b>43979-08</b>	Textured Chrome.	<b>\$549.95</b>
<b>43780-08</b>	Textured Black.	<b>\$399.95</b>
<b>43649-08</b>	Mirror Chrome.	<b>\$749.95</b>

Fits '03-'07 FLST, FLSTN, FLSTC, '03-'06 FLSTF (except FLSTFSE2), and '03-'05 FXST, FXSTB and FXSTS models.

<b>43794-08</b>	Textured Chrome.	<b>\$549.95</b>
<b>43795-08</b>	Textured Black.	<b>\$399.95</b>
<b>44544-08</b>	Mirror Chrome.	<b>\$749.95</b>

See pages 686–689 for matching Rotors and Sprockets.

Notice: The prices appearing in this catalog are the manufacturer's suggested retail prices. Actual retail prices may vary.

# 680 WHEELS

Detonator Collection

## A. DETONATOR® THREE-SPOKE CUSTOM WHEEL

Own the open road. The rounded "liquid metal" look of these exclusive three-spoke Detonator Wheels are sure to stop onlookers in their tracks. Created from 6061 aluminum, the wheel design and the edge details are forged on an 8,000 ton press at Alcoa Aluminum resulting in a surface that is tight, smooth, and takes a chrome finish like a mirror. Matching brake rotors and sprockets are available for a complete custom look. Requires separate purchase of model-specific Wheel Installation Kit.

### 21" Front

**44556-07** **\$1,199.95**

Fits '00-later FXST, FXSTD (except FXSTDSE), FXSTS, FXSTB, FXSTC and '00-later FXDWG.

**44661-07** **\$1,199.95**

Fits '00-later XL and '00-'05 Dyna® models (except FXDWG).

### 19" Front

**44660-07** **\$1,199.95**

Fits '00-later XL and '00-'05 Dyna models (except FXDWG).

### 16" Front

**44550-07** **\$1,199.95**

Fits '00-later FLST, FLSTC, FLSTN, and '00-'06 FLSTF models (except '06 FLSTFSE2).

**44552-08** **\$1,199.95**

Fits '00-'08 Touring models. Also fits '09-later FLHRC models.

### 17" Rear

**44566-07** **\$1,249.95**

Fits '00-later FXSTD and '06-later Dyna models (except FXDF).

### 16" Rear

**44562-08** **\$1,249.95**

Fits '03-'07 FLST, FLSTN, FLSTC, '03-'06 FLSTF (except FLSTFSE2), and '03-'05 FXST, FXSTB and FXSTS models.

**44560-08** **\$1,249.95**

Fits '00-later XL models, '00-'05 Dyna models, '00-'02 Softail® models (except FXSTD), and '00-'08 Touring models.

**44604-08** **\$1,249.95**

Fits '08-later FLSTN and FLSTC models.



A. DETONATOR THREE-SPOKE CUSTOM WHEEL – 21"



A. DETONATOR THREE-SPOKE CUSTOM WHEEL – 16"



See pages 686–689 for matching Rotors and Sprockets.

Notice: The prices appearing in this catalog are the manufacturer's suggested retail prices. Actual retail prices may vary.

# WHEELS 681

Fang & Mirror Disc Wheels



B

## B. FANG CUSTOM WHEEL

Something to sink your teeth into. This custom disc wheel features a unique contrast chrome and black finish. First, the cast wheel is painted to a deep luster, then it is machined to expose the bare metal, and finally chrome-plated for a brilliant shine. This reverse process leaves crisp contrast lines without the rough masking lines of some other painted chrome wheels. Chrome-plated bolt-in "saber fang" inserts add a finishing touch. Requires separate purchase of model-specific Wheel Installation Kit.

**43265-09** 16" Front. **\$749.95**  
Fits '08-later FXDF models (except Japanese models).

**43268-09** 16" Rear. **\$749.95**  
Fits '08-later FXDF models (except Japanese models).

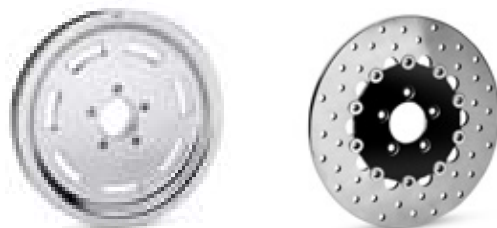

See pages 686–689 for matching Rotors and Sprockets.

B. FANG CUSTOM WHEEL – 16"



C

## C. MIRROR CHROME SOLID DISC WHEEL

Reflect your good taste in the Mirror Chrome Solid Disc Wheel. The glass-smooth surface shines with the uninterrupted vista of chrome. You'll draw attention because nothing detracts from the flowing curves. The mirror-like surface is almost like glass, with a "see through" look you'll want to reach out and touch. Requires separate purchase of model-specific Wheel Installation Kit.

**16" Front**  
**41271-07** **\$749.95**  
Fits '00-later FLST, FLSTC, FLSTN, and '00-'06 FLSTF models (except '06 FLSTFSE2).

**41274-08** **\$749.95**  
Fits '00-'08 Touring models. Also fits '09-later FLHRC models.

**16" Rear**  
**41262-08** **\$749.95**  
Fits '00-later XL models, '00-'05 Dyna® models, '00-'02 Softail models (except FXSTD), and '00-'08 Touring models.

**40829-08** **\$749.95**  
Fits '08-later FLSTN and FLSTC models.

**41265-08** **\$749.95**  
Fits '03-'07 FLST, FLSTN, FLSTC, '03-'06 FLSTF (except FLSTFSE2), and '03-'05 FXST, FXSTB and FXSTS models.



See pages 686–689 for matching Rotors and Sprockets.

C. MIRROR CHROME SOLID DISC WHEEL – 16"

WHEELS

Notice: The prices appearing in this catalog are the manufacturer's suggested retail prices. Actual retail prices may vary.

# 682 WHEELS

## Disc Wheels

### A. SLOTTED FAT BOY® CHROME WHEEL

Add the brilliance of chrome without changing the distinctive style of the Fat Boy motorcycle. The polished rim and textured disc are divided by a ring of slots that open the wheel for a flash of light. Requires separate purchase of model-specific Wheel Installation Kit.

#### 16" Front

**41022-07 \$449.95**

Fits '00-later FLST, FLSTC, FLSTN, and '00-'06 FLSTF models (except '06 FLSTFSE2).

#### 16" Rear

**41261-08 \$449.95**

Fits '03-'07 FLST, FLSTN, FLSTC, '03-'06 FLSTF (except FLSTFSE2), and '03-'05 FXST, FXSTB and FXSTS models.

**41017-00 \$559.00**

Fits '00-'04 XL models, '00-'05 Dyna® models, '00-'02 Softail® models (except FXSTD and FLSTS) and '00-'01 Touring models. Includes spacers and bearings. Does not require Wheel Installation Kit.

**41013-95 \$559.00**

Fits '86-'99 XL, Softail, FXR and '91-'99 Dyna® models. Includes spacers and bearings. Does not require Wheel Installation Kit.

### B. POLISHED SPUN ALUMINUM DISC WHEEL

Born at the drag strip, the look of the spun aluminum wheel has been the hot rodder's favorite for decades. The flat polished surface and surrounding circle of rivets reflect light and motion and add a subtle mirror effect to the front and back of the bike. Spun aluminum wheels include correct bearings and spacers for the application, and are ready for bolt-on installation.

**41312-04 16" Front. \$849.95**

Fits '00-'06 FLST, FLSTC, FLSTN, and '00-'06 FLSTF models (except '06 FLSTFSE2).

**41313-04 16" Rear. \$849.95**

Fits '03-'07 FLST, FLSTN and FLSTC, '03-'06 FLSTF (except FLSTFSE2) and '03-'05 FXST, FXSTB and FXSTS models.



A. SLOTTED FAT BOY CHROME WHEEL – 16"



B. POLISHED SPUN ALUMINUM DISC WHEEL – 16"

Notice: The prices appearing in this catalog are the manufacturer's suggested retail prices. Actual retail prices may vary.



# WHEELS 683

Laced Wheels



C

C. CHROME 80-SPOKE LACED CUSTOM WHEEL – 16"

## C. CHROME 80-SPOKE LACED CUSTOM WHEEL

Add a contemporary custom look to a nostalgic motorcycle. These classic laced wheels feature 80 chrome-plated spokes set in a traditional 4-cross spoke pattern. The chrome-plated steel rim and aluminum hub are laced with chrome-plated steel spokes and nipples. Each wheel includes rubber rim strip. Requires separate purchase of model-specific Wheel Installation Kit.

### 21" Front

**41203-05** **\$724.95**  
Fits '00-'07 FXST, FXSTD (except FXSTDSE), FXSTS, FXSTB, FXSTC and '00-'07 FXDWG models.

### 16" Front

**42958-07** **\$724.95**  
Fits '00-later FLST, FLSTC, FLSTN, and '00-'06 FLSTF models (except '06 FLSTFSE2).

**42952-04** **\$724.95**  
~~Fits '00-'07 Touring models. Includes spacers and bearings. Does not require Wheel Installation Kit.~~

### 16" Rear

**42962-08** **\$724.95**  
Fits '03-'07 FLST, FLSTN and FLSTC, '03-'06 FLSTF (except FLSTFSE2) and '03-'05 FXST, FXSTB and FXSTS models.

**40750-08** **\$724.95**  
Fits '08-later FLST, FLSTN and FLSTC models.

**42959-04** **\$724.95**  
Fits '00-'04 XL models, '00-'05 Dyna® models, '00-'02 Softail® models (except FXSTD and FLSTs) and '00-'01 Touring models. Includes spacers and bearings. Does not require Wheel Installation Kit.

**42954-04** **\$724.95**  
Fits '05-'07 XL and '02-'07 Touring models. Includes spacers and bearings. Does not require Wheel Installation Kit.

## D. CHROME PROFILE LACED WHEEL

Laced wheels are available for many Harley-Davidson® models. See your dealer for specific applications.



D

D. CHROME PROFILE LACED WHEEL – 16"

# 684 WHEELS

## Custom Wheels

### A. CHROME LACED WHEEL

Laced wheels are available for many Harley-Davidson models. See your dealer for specific applications.

### B. CHROME SOLID DISC FORGED WHEEL

Sweeping curves and brilliant chrome plating add a dramatic look to the back of your fat tire Softail model. The mirror finish deep wheel reflects your good taste and custom attitude. Requires separate purchase of model-specific Wheel Installation Kit.

**40842-08** 17" Rear. **\$1,199.95**  
Fits '08-later FXST, FXSTB, FXSTS, and FLSTF models.

**OBSOLETE**

### C. SOLID FAT BOY® CHROME WHEEL

Meticulously chrome-plated, this polished version of the '00-'06 Original Equipment cast aluminum satin-finish Fat Boy wheel adds a distinctive custom touch. Requires separate purchase of model-specific Wheel Installation Kit.

**41031-07** 16" Front. **\$499.95**  
Fits '00-later FLST, FLSTC, FLSTN, and '00-'06 FLSTF models (except '06 FLSTFSE2).

**41026-08** 16" Rear. **\$499.95**  
Fits '00-later XL models, '00-'05 Dyna models, '00-'02 Softail models (except FXSTD), and '00-'08 Touring models.

**41260-08** 16" Rear. **\$499.95**  
Fits '03-'07 FLST, FLSTN, FLSTC, '03-'06 FLSTF (except FLSTFSE2), and '03-'05 FXST, FXSTB and FXSTS models.

### D. CHROME WHEEL FOR SOFTAIL® DEUCE™ MODELS

Add the brilliance of chrome without changing the distinctive custom style of the Softail Deuce model. This meticulously polished and chrome-plated version of the Original Equipment solid rear wheel retains the raised rib design and casts glowing reflections, even while standing still. Requires separate purchase of model-specific Wheel Installation Kit.

**41174-07** 17" Rear. **\$749.95**  
Fits '00-'07 FXSTD and '06-later Dyna® models (except FXDF).

### E. CAST ROAD KING® CUSTOM WHEEL

Original Equipment on the Road King Custom model. These slotted disc wheels feature a polished outer rim and a textured center disc for a distinctive look. Wheels come without bearings.

**41154-04** 16" Front. **\$499.00**  
Fits '00-'08 Touring models.

**41180-04A** 16" Rear. **\$499.00**  
Fits '02-'08 Touring models.

### F. BLACK CAST SLOTTED DISC WHEEL

Original Equipment on Street Glide™ FLHX models. These Slotted Disc Wheels feature a black center and a contrasting machined rim that add an aggressive look to your Touring motorcycle. Wheels come without bearings.

**41285-09** 17" Front. **\$499.00**  
Fits '09-later Touring models (except Trike).

**41285-06** 16" Front. **\$499.00**  
Fits '00-'08 Touring models.

**41288-09** 16" Rear. **\$499.00**  
Fits '09-later Touring models (except Trike).

**41288-06A** 16" Rear. **\$499.00**  
Fits '02-'08 Touring models.



A. CHROME LACED WHEEL – 16"



B. CHROME SOLID DISC FORGED WHEEL – 17" REAR, 6" WIDE



C. SOLID FAT BOY CHROME WHEEL



D. CHROME REAR WHEEL FOR SOFTAIL DEUCE MODELS



E. CAST ROAD KING CUSTOM WHEEL



F. BLACK CAST SLOTTED DISC WHEEL ('00-'08 SHOWN)

Notice: The prices appearing in this catalog are the manufacturer's suggested retail prices. Actual retail prices may vary.

# WHEELS 685

Sprocket Covers



NEW

G

G. MAGNUM 5 SPROCKET COVER – CHROME



NEW

G

G. MAGNUM 5 SPROCKET COVER – SATIN BLACK



H

H. TYPHOON SPROCKET COVER – CHROME



H

H. TYPHOON SPROCKET COVER – SATIN BLACK



I

I. CHROME SPROCKET COVER



NEW

J

J. CHROME "BIG SPOKE" SPROCKET COVER

## G. MAGNUM 5 SPROCKET COVER

Styled to match the distinctive Magnum 5 Custom Wheel. Available in mirror-chrome or satin black, this Sprocket Cover gives the appearance of having a custom sprocket at a fraction of the cost. Cover is easy-to-install with Original Equipment hardware, or add the Chrome Hardware Kit P/N 94773-07 to your Dyna® or Softail® model for a finished look (sold separately).

Fits '06-later Dyna models.

<b>40120-09</b>	Chrome.	<b>\$54.95</b>
<b>40122-10</b>	Satin Black.	<b>\$54.95</b>

Fits '07-later Softail and '07 Touring models.

<b>40121-09</b>	Chrome.	<b>\$54.95</b>
<b>40123-10</b>	Satin Black.	<b>\$54.95</b>

## H. TYPHOON SPROCKET COVER

Styled to match the distinctive Typhoon Custom Wheel. Available in mirror chrome or satin black, this Sprocket Cover gives the appearance of having a custom sprocket at a fraction of the cost. Cover easily bolts on using the stock hardware, or for a finished look, add the Chrome Hardware Kit P/N 94773-07 (sold separately).

Fits '07-later Softail models.

<b>40150-08</b>	Chrome.	<b>\$49.95</b>
<b>40155-08</b>	Satin Black.	<b>\$49.95</b>

Fits '07-later Dyna models.

<b>40142-08</b>	Chrome.	<b>\$49.95</b>
<b>40154-08</b>	Satin Black.	<b>\$49.95</b>

## I. CHROME SPROCKET COVER

This Sprocket Cover gives the appearance of having a chrome sprocket at a fraction of the cost. It matches the styling of the Original Equipment sprocket, and bolts on using the stock hardware.

**37757-07** **\$49.95**

Fits '07-later Softail (except FXCW/C) and '07 Touring models.

**91347-00** **\$49.95**

Fits '00-'06 Softail models.

## J. CHROME "BIG SPOKE" SPROCKET COVER

Muscle rules. Big, beefy spokes define the distinctive hot rod styling, and the small trapezoidal openings are reminiscent of the Detroit's street performance wheels of the late 60s. The chrome plated steel cover disguises the Original Equipment sprocket, and complements both stock and custom wheels. Easy-to-install, this cover provides the look of a billet sprocket at a fraction of the cost.

**40124-10** **\$49.95**

Fits '04-later XL models.

Notice: The prices appearing in this catalog are the manufacturer's suggested retail prices. Actual retail prices may vary.



# 686 WHEELS

*Pulleys & Sprockets*

## **BILLET SPROCKETS**

Designed to complement the wheel's styling, these custom sprockets are manufactured from 6061-T6 forged billet aircraft aluminum, and precision machined to exacting Original Equipment standards. Harley-Davidson custom sprockets are finished with a proprietary process that combines the decorative chrome with a wear resistant surface applied to the teeth. The sprockets feature a five-year tooth wear warranty.



**Slotted Six-Spoke**



**Detonator®**



**Chrome ThunderStar™**



**Road Winder**



**Mirror Chrome Disc**



**Revolver**



**Reaper**



**Mirror Disc**



**Fang**





**Black ThunderStar™**



**Blade**



**Stinger**

## SPROCKETS

Style	Fits '04-later XL and '09-later XR models (except Japanese models)		Fits '00-'05 Dyna® models		Fits '07-later Dyna models (except Japanese models)		Fits '04-'06 Touring models	
	Part No.	Price	Part No.	Price	Part No.	Price	Part No.	Price
Slotted Six-Spoke	40418-04	\$399.95	40451-01	\$399.95	40451-07	\$399.95	—	—
Detonator	<del>OBSOLETE 40413-04</del>	<del>\$399.95</del>	—	—	—	—	—	—
Chrome ThunderStar	—	—	40096-00	\$399.95	—	—	40435-04	\$399.95
Black ThunderStar	—	—	<del>OBSOLETE 40526-00</del>	<del>\$399.95</del>	—	—	—	—
Road Winder	<del>OBSOLETE 40482-04</del>	<del>\$399.95</del>	40478-03	\$399.95	40478-07	\$399.95	—	—
Revolver	40282-05	\$399.95	—	—	—	—	—	—
Reaper	—	—	—	—	37709-09	\$399.95	—	—
Fang	—	—	—	—	40410-09	\$399.95	—	—
Stinger	—	—	—	—	37833-10	\$399.95	—	—

Style	Fits '00-'06 Softail® models (except '06 FXST, FXSTB, FXSTS and FLSTFSE). FXSTD models require Spacer Kit P/N 29786-01		Fits '06 FXST, FXSTB and FXSTS models		Fits '07-later FXST, FXSTB, FXSTC, FLSTF, FLSTFB and FLSTSB models (except Japanese models)		Fits '07 FXSTD and FLSTSC, '07-later FLSTC and FLSTN and '08-later FXCW and FXCWC models (except Japanese models)	
	Part No.	Price	Part No.	Price	Part No.	Price	Part No.	Price
Slotted Six-Spoke	40447-01	\$399.95	—	—	—	—	40447-07	\$399.95
Detonator	40455-02	\$399.95	—	—	—	—	—	—
Chrome ThunderStar	40126-00	\$399.95	—	—	—	—	40126-07	\$399.95
Black ThunderStar	—	—	—	—	—	—	<del>OBSOLETE 40530-07</del>	<del>\$399.95</del>
Road Winder	40474-03	\$399.95	40698-06	\$399.95	37793-07	\$399.95	40474-07	\$399.95
Mirror Chrome Disc	46624-03	\$399.95	—	—	—	—	—	—
Revolver	—	—	—	—	40134-07	\$399.95	—	—
Blade	—	—	—	—	37785-07	\$399.95	37800-08	\$399.95
Reaper	—	—	—	—	40445-08	\$399.95	—	—
Stinger	—	—	—	—	37834-10	\$399.95	—	—
Mirror Disc	—	—	—	—	—	—	40228-07	\$399.95

WHEELS

Notice: The prices appearing in this catalog are the manufacturer's suggested retail prices. Actual retail prices may vary.

# 688 WHEELS

## Brake Rotors

### FLOATING AND POLISHED BRAKE ROTORS

Complete the custom look with floating or polished brake rotors, styled to complement Original Equipment or custom wheels. Floating rotors feature a steel inner carrier that is shaped to accent the wheel, and the polished and drilled stainless steel outer disc is precision riveted in place. Polished Original Equipment rotors feature a brilliant mirror finish.



ThunderStar™



Classic Chrome



Slotted Six-Spoke



Chrome



Vivid Black



Classic Black



Revolver



Polished ('08-later Touring)



Polished



**LightningStar™**



**Teardrop**



**Reaper**



**Detonator®**



**Road Winder**



**Blade**

**ROTORS**

	<b>Front</b> <i>Fits '00-later XL, XR and Softail® (except Springer models), '00-'07 Touring models and '00-'05 Dyna® models.</i>		<b>Front</b> <i>Fits '08-later Touring models (except Trike).</i>		<b>Front</b> <i>Fits all '84-'99 models. Front rotors must be installed with Brake Pad Kit P/N 44063-83C (sold separately).</i>		<b>Rear</b> <i>Fits '00-later XL, Dyna and Softail and '00-'07 Touring models. Separate purchase of Brake Rotor Hub Plate P/N 43837-00 is required when installing on FXSTD 17-inch wheels.</i>		<b>Rear</b> <i>Fits '87-'99 XL and Dyna models, '87-'94 FXR and '99 FXR2/3 and '87-'99 Softail models. Rear rotors must be installed with Brake Pad Kit P/N 44209-87C (sold separately).</i>	
<b>Style</b>										
ThunderStar	<b>44365-00</b>	<b>\$149.95</b>	<b>44940-08</b>	<b>\$149.95</b>	—	—	<b>44366-00</b>	<b>\$149.95</b>	—	—
Classic Chrome	<b>44821-00</b>	<b>\$139.95</b>	—	—	—	—	<b>44822-00</b>	<b>\$139.95</b>	—	—
Slotted Six-Spoke	<b>45118-06</b>	<b>\$189.95</b>	—	—	—	—	<b>45047-06</b>	<b>\$189.95</b>	—	—
LightningStar	<b>44819-00</b>	<b>\$149.95</b>	—	—	—	—	—	—	—	—
Teardrop	<b>44367-00</b>	<b>\$139.95</b>	<b>44942-08</b>	<b>\$139.95</b>	—	—	<b>44368-00</b>	<b>\$139.95</b>	—	—
Chrome	<b>44360-00</b>	<b>\$139.95</b>	<b>44944-08</b>	<b>\$139.95</b>	<b>44101-95</b>	<b>\$139.95</b>	<b>44359-00</b>	<b>\$139.95</b>	<b>44108-95</b>	<b>\$139.95</b>
Classic Black*	<b>46778-09</b>	<b>\$129.95</b>	—	—	—	—	<b>46777-09</b>	<b>\$129.95</b>	—	—
Vivid Black	<b>44358-00</b>	<b>\$129.95</b>	<b>44947-08</b>	<b>\$129.95</b>	<b>44100-95</b>	<b>\$129.95</b>	<b>44357-00</b>	<b>\$129.95</b>	<b>44102-95</b>	<b>\$129.95</b>
Detonator	<b>44856-02</b>	<b>\$149.95</b>	—	—	—	—	<b>44857-02</b>	<b>\$149.95</b>	—	—
Road Winder – Left Side	<b>44700-03</b>	<b>\$189.95</b>	—	—	—	—	—	—	—	—
Road Winder – Right Side	<b>44703-03</b>	<b>\$189.95</b>	—	—	—	—	<b>44706-03</b>	<b>\$189.95</b>	—	—
Revolver	<b>46640-07</b>	<b>\$189.95</b>	—	—	—	—	<b>46641-07</b>	<b>\$189.95</b>	—	—
Blade – Left Side	<b>42155-07</b>	<b>\$199.95</b>	—	—	—	—	<b>42158-07</b>	<b>\$199.95</b>	—	—
Blade – Right Side	<b>42156-07</b>	<b>\$199.95</b>	—	—	—	—	<b>42158-07</b>	<b>\$199.95</b>	—	—
Polished – Left Side	<b>41830-05</b>	<b>\$139.95</b>	<b>44950-08</b>	<b>\$149.95</b>	—	—	<b>41832-05</b>	<b>\$139.95</b>	—	—
Polished – Right Side	<b>41831-05</b>	<b>\$139.95</b>	<b>44959-08</b>	<b>\$149.95</b>	—	—	<b>41832-05</b>	<b>\$139.95</b>	—	—
Reaper – Left Side	<b>44411-09</b>	<b>\$189.95</b>	—	—	—	—	—	—	—	—
Reaper – Right Side	—	—	—	—	—	—	<b>44421-09</b>	<b>\$189.95</b>	—	—

*Notice: The prices appearing in this catalog are the manufacturer's suggested retail prices. Actual retail prices may vary.*

# 690 WHEELS

Brake & Pulley Hardware

## A. CHROME BRAKE DISC HARDWARE KIT

It's the details, like this chrome hardware kit, that really get your bike noticed. These button head screws add a unique, chrome-plated finish to the Original Equipment or accessory floating brake rotors. Kit includes 5 chrome-plated bolts manufactured to factory specifications to ensure fit and performance.

**46646-05** Front. **\$12.95**

Fits '90-later models (except VRSC™, XR, '06-later Dyna® models with cast wheel option and '07-later FLHRSE3/4). Dual disc models require purchase of two kits.

**46647-05** Rear. **\$13.95**

Fits '92-later models (except XR and Trike).

## B. REAR SPROCKET BOLT COVER KIT

These chrome-plated covers with internal spring clips hide the Original Equipment sprocket bolts for a clean, custom look. Set of 5 covers.

**43876-04** **\$38.95**

Fits '93-later Softail®, '99-later Touring (except Trike) and '04-later XL models with Original Equipment 7/16" hex head sprocket mounting bolts (5/8" hex across the flats).

## C. CHROME HARDWARE KIT FOR REAR BELT SPROCKET – HEX HEAD

This kit includes highly-polished, chrome-plated, grade 8 hex-head screws with chrome-plated washers, providing an extra custom accent. The perfect addition to the chrome sprocket. Made from the same Original Equipment bolts to ensure product integrity. Also works with chrome belt sprocket covers and Original Equipment sprockets.

**94773-07** **\$29.95**

Fits '07-later Dyna® and Softail® models.

**94773-00A** **\$29.95**

Fits '00-'06 Softail and '00-'05 Dyna models.

**94708-98** **\$29.95**

Fits '93-'99 Softail, '93-'99 Dyna, '91-later XL models.

## D. CHROME SOCKET HEAD CAP SCREW HARDWARE KIT FOR REAR BELT SPROCKET

It's the details, like this chrome hardware kit, that really get your bike noticed. These Socket Head Cap Screws offer a unique, chrome-plated look to the rear belt sprocket. Includes chrome-plated washers and grade 8 hardware to ensure product integrity.

**43245-07** Fits '07-later Softail models. **\$29.95**

**43245-00A** **\$29.95**

Fits '00-'06 Softail models (except FXSTDSE and FXSTDSE2).

## E. CHROME-PLATED ABS VALVE STEM CAPS

A special chrome touch with special graphics. Will not seize on valve stems and includes O-rings for reliable seal. Sold in pairs.

Universal fitment. Also fits suspension air valves.

**1. 41146-97** Gold "H-D" Logo Outline on Black. **\$7.95**

**2. 41144-97** Color Bar & Shield Logo. **\$7.95**

**3. 41145-97** **\$7.95**

White Bar & Shield Logo Outline on Black.

**4. 41171-03** White Skull Logo on Black. **\$7.95**

## F. CHROME-PLATED BRASS VALVE STEM CAPS

The beauty of chrome with the durability of machined brass, featuring a laser-etched Bar & Shield logo painted black. Available with a traditional, unique fluted or rugged acorn shaped cylinder. Will not seize on valve stems and includes O-rings for reliable seal. Sold in pairs.

Universal fitment. Also fits suspension air valves.

**1. 41149-98** **\$12.95**

Fluted Cylinder with Bar & Shield Logo.

**2. 41148-98** **\$12.95**

Acorn Nut with Bar & Shield Logo.

**3. 41150-98** **\$12.95**

Acorn Nut with Grooved Cylinder with Bar & Shield Logo.



A. CHROME BRAKE DISC HARDWARE KIT



B. REAR SPROCKET BOLT COVER KIT



C. CHROME HARDWARE KIT FOR REAR BELT SPROCKET – HEX HEAD



D. CHROME SOCKET HEAD CAP SCREW HARDWARE KIT FOR REAR BELT SPROCKET



E. CHROME-PLATED ABS VALVE STEM CAPS



F. CHROME-PLATED BRASS VALVE STEM CAPS

Notice: The prices appearing in this catalog are the manufacturer's suggested retail prices. Actual retail prices may vary.



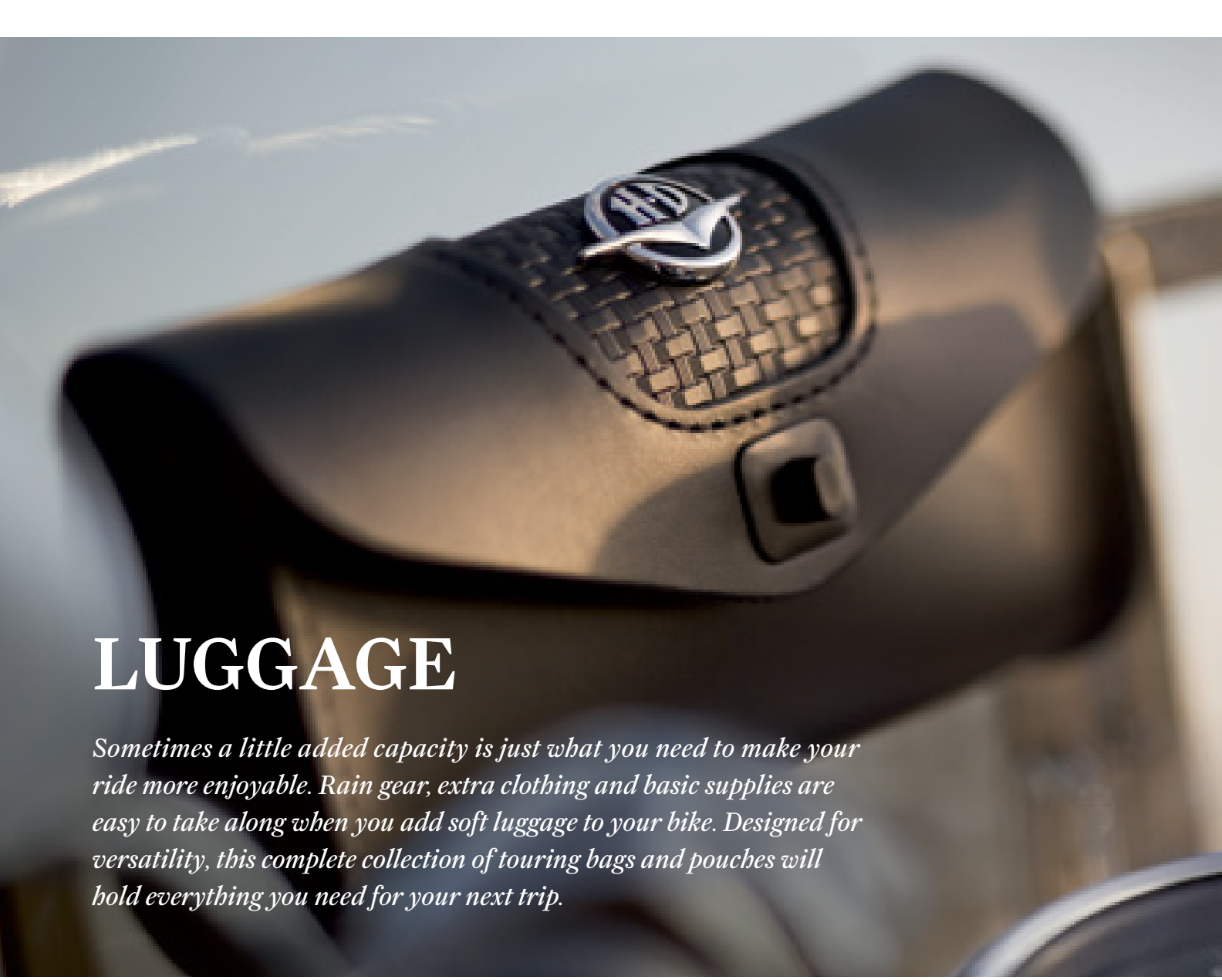

# LUGGAGE

*Sometimes a little added capacity is just what you need to make your ride more enjoyable. Rain gear, extra clothing and basic supplies are easy to take along when you add soft luggage to your bike. Designed for versatility, this complete collection of touring bags and pouches will hold everything you need for your next trip.*

## HAVE ENOUGH SPACE FOR ANY RIDE



### SISSY BAR BACKPACK

*For a day at the office, or for an afternoon wandering a swap meet, this convenient backpack makes the grade. Complete with a padded laptop pocket, mesh water bottle side pockets and rain cover, this backpack attaches to most sissy bars for on-and-off convenience.*

### PREMIUM TOUR-PAK® RACK BAG

*Just because you're out on the road, doesn't mean you have to sacrifice convenience or style. This new rack bag features ballistic nylon construction, interior and exterior pockets, a built-in rain cover and quick-disconnect clips and shoulder strap to make moving into the hotel a breeze.*



# MULTI-FIT *TOURING LUGGAGE COLLECTION*

## GEAR UP FOR THE ROAD

*Available to fit a variety of backrest and upright configurations, these bags are equipped with four separate backrest pad pockets to ensure the best possible fit. This is the most versatile luggage to ever hit the motorcycle scene. From small bags and overnights to touring bags and a complete luggage system, this collection adds convenience and comfort when used either together or individually.*

*All bags are manufactured from high-quality, water-resistant, UV-resistant polyester and are custom-designed to fit your sissy bar. They also feature PVC rubber handles and easy-access pouches that make touring a snap. Special stiffeners are built in to hold shape even when the bags are empty.*



# LUGGAGE 693

Sissy Bar & Rack Bags



**A. MULTI-FIT TOURING LUGGAGE SYSTEM WITH DAY BAG**

## A. MULTI-FIT TOURING LUGGAGE SYSTEM WITH DAY BAG

This two-bag system is made from high-quality, foam-backed water-resistant materials designed to retain their shape. The bag combination features 4 exterior side pockets for storage, 1 large front zippered pocket with a removable tool roll, 2 interior pockets (1 mesh, 1 soft cotton) and an interior key hook. The Bar & Shield logo and the built-in rain cover add reflective surfaces for maximum visibility. The Day Bag can be stored inside the Touring Bag when not in use. The bags can be used together or separately to match your storage needs. The Tour Bag is 16" W x 10" D x 19" T, and the smaller Day Bag is 16" W x 10" D x 10" T. Luggage capacity: Touring Bag – 2600 cubic inches; Day Bag – 1300 cubic inches.

**94734-09** **\$229.95**  
Installation requires a sissy bar upright, backrest pad, and luggage rack (if not mounting luggage on passenger pillion).

## B. MULTI-FIT ULTRA TOURING BAG

This large Ultra Touring Bag is ideal for the long haul. It features a built-in black PVC liner that prevents water intrusion on long trips and helps keep the bag rigid. Large easy-access side pockets offer added convenience. The reflective Bar & Shield logo adds style during the day and visibility at night. Dimensions: 22" W x 11" D x 19" T, Luggage capacity: 3800 cubic inches.

**94743-09** **\$224.95**  
Installation requires a sissy bar upright, backrest pad, and luggage rack (if not mounting luggage on passenger pillion).

## C. MULTI-FIT OVERNIGHT BAG

Designed to carry like a suitcase, this Overnight Bag is the perfect size for the shorter trip. The high-quality, foam-backed water-resistant material helps the bag maintain its shape. The Bar & Shield logo and built-in rain cover add reflective surfaces for maximum visibility. The bag features 2 exterior side pockets for storage, 2 interior pockets (1 mesh, 1 soft cotton), and interior key hook. The bag measures 18" W x 10.5" D x 12" T. Luggage capacity: 1900 cubic inches.

**94787-09** **\$119.95**  
Installation requires a sissy bar upright, backrest pad, and luggage rack (if not mounting luggage on passenger pillion).

## D. MULTI-FIT ULTRA OVERNIGHT BAG

This medium-sized Ultra Overnight Bag features a built-in black PVC liner that prevents water intrusion and helps keep the bag rigid, even when empty. Large easy-access side pockets offer added convenience. The Bar & Shield logo and built-in rain cover add reflective surfaces for maximum visibility. Dimensions: 22" W x 10.5" D x 13" T, Luggage capacity: 2400 cubic inches.

**94758-09** **\$199.95**  
Installation requires a sissy bar upright, backrest pad, and luggage rack (if not mounting luggage on passenger pillion).



**A. MULTI-FIT TOURING LUGGAGE SYSTEM WITH DAY BAG**



**B. MULTI-FIT ULTRA TOURING BAG**



**C. MULTI-FIT OVERNIGHT BAG**



**D. MULTI-FIT ULTRA OVERNIGHT BAG**

Notice: The prices appearing in this catalog are the manufacturer's suggested retail prices. Actual retail prices may vary.

# 694 LUGGAGE

Sissy Bar & Rack Bags

## A. PASSENGER PILLION-MOUNTED ULTRA TOURING BAG

Pack everything you need for that long, solo ride across the country. This large touring bag is designed to fit the passenger seat of Harley® Touring models. The bag includes a water-resistant polyethylene liner that helps the bag retain its shape even when empty. Straps to the saddlebag guards and Tour-Pak® mounting rack for convenient installation. The Bar & Shield logo and built-in rain cover add reflective surfaces for maximum visibility. Dimensions: 17" W x 10" D x 19" T. Luggage capacity: 2800 cubic inches.

**94788-01A** **\$199.95**

Fits '97-later Touring models equipped with King, Ultra or Chopped Tour-Pak® Luggage and Saddlebag Guards.



**A. PASSENGER PILLION-MOUNTED ULTRA TOURING BAG**



**B. TOUR-PAK RACK BAG – POLYESTER SHOWN**

## B. TOUR-PAK® RACK BAG

This bag mounts conveniently to your Tour-Pak® luggage rack, eliminating the need for bungee cords or tie downs that can scratch paint. Hook-and-loop flaps hold the bag to the rack, so installation and removal is a snap. The foam-backed, water-resistant material helps the bag retain its shape for easy loading, and the Bar & Shield logo and built-in rain cover features a reflective stripe for added visibility. The bag includes 2 exterior side pockets for storage, 2 interior pockets (1 mesh, 1 soft cotton), and an interior key hook. The bag is 21" W x 11.5" D x 12" T. Luggage capacity: 2500 cubic inches.

Fits Tour-Pak lids equipped with Air Wing Tour-Pak Rack P/N 79179-08, Premium Tour-Pak Luggage Rack P/N 53665-87, FLHTCUSE Tour-Pak Luggage Rack P/N 79125-06 and Contoured Luggage Rack P/N 79148-06A.

**94776-09** Leather. **\$259.95**

**94806-09** Polyester. **\$139.95**



**C. RACK BAG FOR VRSC AND ROCKER MODELS**



**D. RACK BAG FOR SOFTAIL DEUCE MODELS**

## C. RACK BAG FOR VRSC™ AND ROCKER™ MODELS

Designed for easy removal, this Rack Bag is the perfect size for the shorter trip. The high-quality foam-backed water-resistant material helps the bag maintain its shape. The Bar & Shield logo and built-in rain cover add reflective surfaces for maximum visibility. The bag features 2 exterior side pockets for storage, 2 interior pockets (1 mesh, 1 soft cotton), and interior key hook. The bag measures 16" W x 11" D x 11" T. Luggage capacity: 1800 cubic inches.

**98923-09** **\$139.95**

Fits VRSC™ and FXCW models equipped with a sissy bar upright, backrest pad, and luggage rack (if not mounting luggage on passenger pillion).

## D. RACK BAG FOR SOFTAIL® DEUCE™ MODELS

The perfect accessory for cruising around town or taking short trips on your Softail Deuce model. Constructed with a polyethylene liner to keep out water and help it retain its shape, this bag carries like a suitcase for your convenience. Custom designed to fit the Softail Deuce Passenger Upright and Rack. The Bar & Shield logo and built-in rain cover add reflective surfaces for maximum visibility. Dimensions: 16" W x 10.5" D x 12" T. Luggage capacity: 1700 cubic inches.

**98870-00B** **\$149.95**

Fits '00-'07 FXSTD models equipped with Passenger Sissy Bar Upright P/N 51114-00 and Luggage Rack P/N 53806-00, and Passenger Backrest P/Ns 52549-00 and 51534-00.



**E. SNAP BAG**



**F. WATERPROOF PVC LUGGAGE LINER**

## E. SNAP BAG

This practical bag snaps onto D-rings provided on all of the bags in the Touring Luggage System and Bag Collection. It's perfect for eyeglasses, driver's license, credit cards, toll booth money and everything else you need quickly but don't want to search through your pockets to find. The Snap Bag is also easily attached to your belt when you leave your bike.

**94735-98A** Universal. **\$39.95**

## F. WATERPROOF PVC LUGGAGE LINER

Keep your critical belongings bone dry with this Waterproof PVC Liner. The hook-and-loop strip attaches to the interior of most luggage pieces. Clear sides keep your items viewable and easy to grab in a hurry.

**88265-06** Universal. **\$19.95**

Notice: The prices appearing in this catalog are the manufacturer's suggested retail prices. Actual retail prices may vary.



# LUGGAGE 695

Sissy Bar & Rack Bags



G



H

**G. CUSTOM-FIT TOURING LUGGAGE SYSTEM WITH DAY BAG**

**H. CUSTOM-FIT OVERNIGHT BAG**

G. TOURING LUGGAGE SYSTEM	Pocket Style "A"	Pocket Style "A"	Pocket Style "B"	Pocket Style "B"	Pocket Style "B"
Pocket width	7.25"	7.25"	10.0"	11.0"	14.0"
Backrest pad height	7.5"	8.0"	9.0"	9.0"	10"
Backrest thickness	2.5"	2.5"	2.5"	2.5"	2.5"
Bottom of pocket to mounting surface	4.0"	6.0"	4.0"	4.0"	4.0"
Touring Luggage System part number	94727-09 \$229.95	94731-09 \$229.95	94728-09 \$229.95	94729-09 \$229.95	94733-09 \$229.95

H. OVERNIGHT BAG	Pocket Style "A"	Pocket Style "A"	Pocket Style "B"	Pocket Style "B"	Pocket Style "B"
Pocket width	7.25"	7.25"	10.0"	11.0"	14.0"
Backrest pad height	7.5"	8.5"	9.0"	8.5"	8.75"
Backrest thickness	2.5"	2.5"	2.5"	2.5"	2.5"
Bottom of pocket to mounting surface	3.0"	4.0"	4.0"	4.5"	4.0"
Overnight Bag part number	94719-09 \$119.95	94723-09 \$119.95	94720-09 \$119.95	94721-09 \$119.95	94725-09 \$119.95

## G. CUSTOM-FIT TOURING LUGGAGE SYSTEM WITH DAY BAG

This two-bag system is made from high-quality, foam-backed water-resistant materials designed to retain their shape. Designed for model-specific applications, the quick-release buckets and custom-fit backrest sleeve hold the bag firmly in position. The bag combination features 4 exterior side pockets for storage, 1 large front zippered pocket with a removable tool roll, 2 interior pockets (1 mesh, 1 soft cotton) and an interior key hook. The Bar & Shield logo and the built-in rain cover add reflective surfaces for maximum visibility. The Day Bag can be stored inside the Touring Bag when not in use. The bags can be used together or separately to match your storage needs. The Tour Bag is 16" W x 10" D x 19" T, and the smaller Day Bag is 16" W x 10" D x 10" T. Luggage capacity: Touring Bag – 2600 cubic inches; Day Bag – 1300 cubic inches.

## H. CUSTOM-FIT OVERNIGHT BAG

Designed to carry like a suitcase, this Overnight Bag is the perfect size for the shorter trip. Designed for model-specific applications, the quick-release buckets and custom-fit backrest sleeve hold the bag firmly in position. The high-quality, foam-backed water-resistant material helps the bag maintain its shape. The Bar & Shield logo and built-in rain cover add reflective surfaces for maximum visibility. The bag features 2 exterior side pockets for storage, 2 interior pockets (1 mesh, 1 soft cotton), and interior key hook. The bag measures 18" W x 10.5" D x 12" T. Luggage capacity: 1900 cubic inches.

## CHOOSING THE RIGHT POCKET LUGGAGE STYLE FOR YOUR RACK AND BACKREST

**STEP 1:** Take measurements of Backrest Pad, Upright or Luggage Rack while installed on vehicle;

- Backrest Pad Width
- Pad Height
- Pad Thickness
- Bottom of Pad down to Pillion or Luggage Rack surface

**STEP 2:** Select appropriate pocket style that corresponds to Backrest shape (Style A or B).

**STEP 3:** Use chart to the left to find a bag that fits measurements.

If there is not a bag that fits your measurements, please see Multi-Fit Luggage selection.

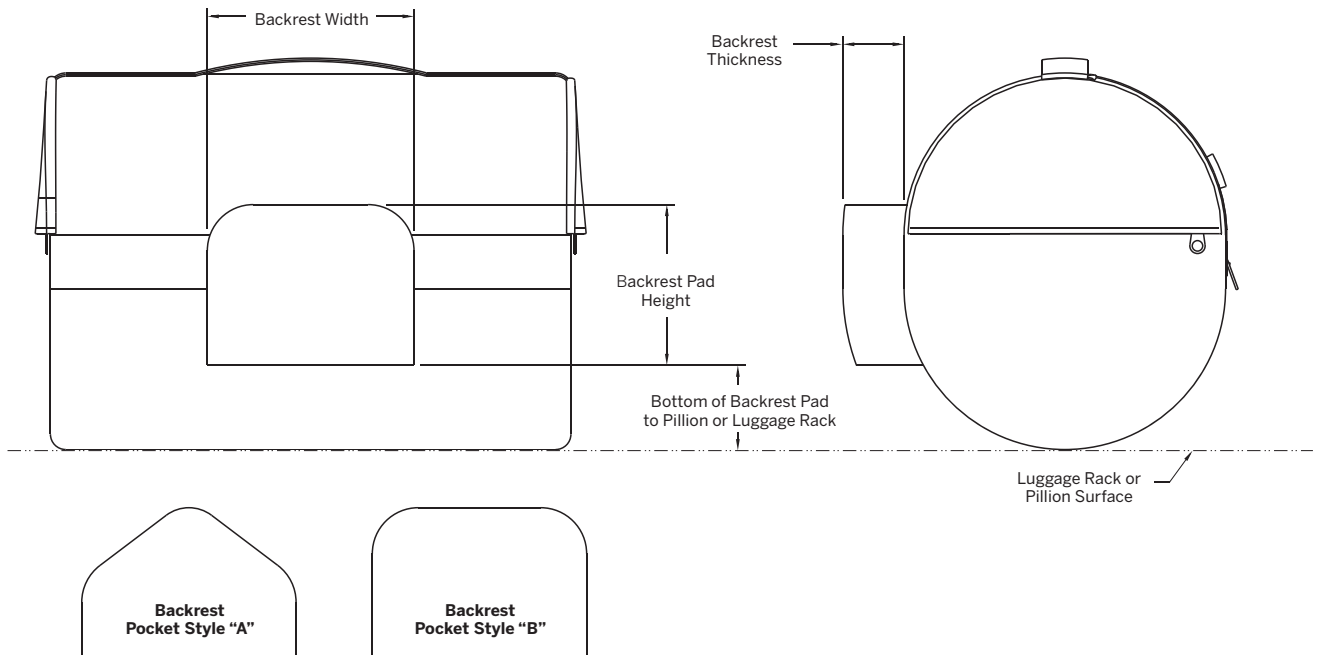

LUGGAGE

Notice: The prices appearing in this catalog are the manufacturer's suggested retail prices. Actual retail prices may vary.

# 696 LUGGAGE

Sissy Bar & Rack Bags

## A. PREMIUM TOUR-PAK® RACK BAG

Finally, a durable and sturdy Premium Rack Bag that is tasteful enough to carry into a nice hotel. This versatile bag is manufactured from durable UV and water-resistant 1680 denier ballistic nylon, and features reflective piping for added visibility. The heavy-duty zippers open to reveal a large storage space with three zippered interior mesh pockets. The bag features two zippered exterior pockets for convenient access to maps, sunscreen, and other roadside essentials, and a built-in rain cover with reflective stripe to help you survive that sudden downpour. The Premium Bag mounts to the luggage rack with quick-disconnect clips, and the comfortable handle and removable shoulder strap make the move from the parking lot to the hotel room a breeze. The Premium Bag is finished with a Harley-Davidson® script logo. Dimensions: 20.5" W x 9.5" T x 13" D. Luggage capacity: 2000 cubic inches.

**94807-09 \$229.95**

Fits models equipped with Tour-Pak® Luggage Racks (except Mini Rack P/N 53100-96). Also fits Premium Sidecar Luggage Rack P/N 53669-89.



A. PREMIUM TOUR-PAK RACK BAG

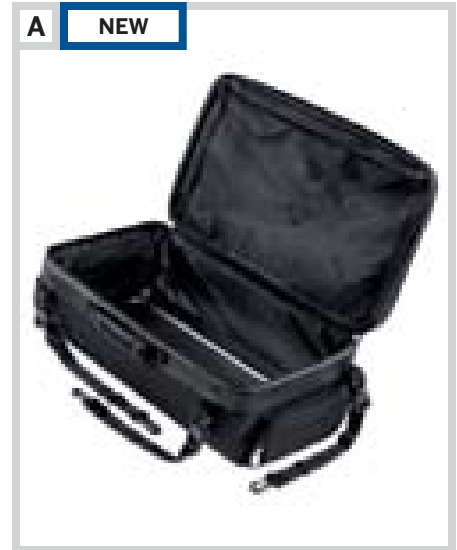

A. PREMIUM TOUR-PAK RACK BAG

## B. EXPANDABLE LUGGAGE RACK DUFFEL BAG

Urethane-coated 1000 denier nylon with a full-length zipper that wraps around the side gusset panels. Hook-and-loop fasteners attach to luggage rack tubing. Unique shoulder strap doubles as a mounting band. Main compartment zipper is covered by a protective flap secured with hook-and-loop closure. Fully expanded: 12.25" H x 12" W x 19.5" L. Not expanded: 8" H. Maximum recommended load is 10 lbs.

**91753-92 \$99.95**

For use on Premium Tour-Pak® Luggage Rack P/N 53665-87 and Airwing Rack P/N 79179-08.



B. EXPANDABLE LUGGAGE RACK DUFFEL BAG



C. UNIVERSAL LUGGAGE RACK BAG

## C. UNIVERSAL LUGGAGE RACK BAG

This versatile bag is water-resistant, foam-backed Cordura® material that holds its shape and is easy-to-install. Features embroidered "Harley-Davidson" script logo and quick-disconnect buckle.

**98868-98 \$99.95**

Fits Softail (except FXSTD), FXDWG models equipped with H-D® Bobtail Fender Racks or XL models equipped with Four-Channel Luggage Racks.

## D. BOBTAIL FENDER RACK DUFFEL BAG

Constructed of durable vinyl and nylon, this bag features a convenient carrying handle and chrome tie-down D-rings on each side.

**98835-92 \$89.95**

Fits Softail® (except FXSTD), FXDWG models equipped with H-D® Bobtail fender racks or XL models equipped with Four-Channel Chrome Luggage Racks.



D. BOBTAIL FENDER RACK DUFFEL BAG

## E. MESSENGER BAG SISSY BAR LUGGAGE

Tapered "messenger" style bag easily mounts to the sissy bar, and adds needed storage space to your custom ride. The heavy leather lid with embossed Bar & Shield logo features a traditional strap and buckle look, but conceals quick-disconnect clips for easier access. The rigid back shell helps the bag maintain its shape, and the built-in water-resistant polyester liner with drawstring closure keeps items dry inside. Dimensions: 10" W x 12" T x 9.5" D. Luggage capacity: 925 cubic inches. Installation requires a sissy bar upright, backrest pad, and bobtail luggage rack.

**94792-08 \$159.95**

Fits FLSTSB and FX Softail models (except FXCW/C, FXSTD and FXSTSSE3) equipped with Bobtail Luggage Rack, Passenger Backrest Pad, and One-Piece Sissy Bar Upright P/N 52729-08, 51853-07, or Original Equipment FXSTC Upright.



E. MESSENGER BAG SISSY BAR LUGGAGE

Notice: The prices appearing in this catalog are the manufacturer's suggested retail prices. Actual retail prices may vary.

F



F. UNIVERSAL DELUXE SIDE LOADING ROLLER BAG

## F. UNIVERSAL DELUXE SIDE LOADING BAG

Designed to fit on the passenger pillion, this universal mount Deluxe Luggage Bag is constructed of durable Climashield® Plus fabric with Color Lok®. Manufactured for life on the road, the bag features inside bound seams, a wire-reinforced welt, and a self-contained water shedding rain cover. The bag includes comfortable rubber handles, Duraflex® glove-friendly buckles, and external mesh and flap pockets. A large 1.8 cubic foot interior features organizer pockets for small items, and zippered pockets for easy packing. The Deluxe Side Loading Roller Bag features a telescopic pull handle, easy-to-control roller-blade wheels, and a large side opening for easy access, even when strapped to the passenger pillion.

Fits '82-later XL, '91-later Dyna®, '84-later Softail® (except FXCW/C), '02-later VRSC™ and '97-later Touring models equipped with sissy bar upright, backrest pad and saddlebag guards or Tour-Pak. Does not fit with mini or short uprights, narrow pillions (less than 6" wide) or Tour-Pak® speakers.

<b>98949-06</b>	Side Loading Roller Bag.	<b>\$229.95</b>
<b>98945-04A</b>	Side Loading Bag.	<b>\$209.95</b>

## G. SISSY BAR BACKPACK

Keep your stuff with you when you're on the road. This backpack straps securely to the passenger backrest and provides convenient storage on your way to work. The interior features a padded laptop pocket with a secure strap for safe transportation, and the convenient mesh side pockets hold water bottles or anything you need easy access to. The padded backpack straps stow in their own storage pocket, and the wide "hook-and-loop" strap mount fits many backrest and luggage rack combinations. Includes rain cover for all weather protection. Dimensions: 18" T x 14" W x 13" D. Luggage capacity: 1600 cubic inches.

<b>94751-08</b>		<b>\$149.95</b>
Installation requires a sissy bar upright, backrest pad, and luggage rack (if not mounting luggage on passenger pillion). Does not fit with mini or short sissy bar uprights.		

G



G. SISSY BAR BACKPACK – SHOWN MOUNTED

G



G. SISSY BAR BACKPACK – SHOWN WITH STRAPS

Notice: The prices appearing in this catalog are the manufacturer's suggested retail prices. Actual retail prices may vary.

# 698 LUGGAGE

## Sissy Bar & Fork Bags

### A. LEATHER FORK BAG

Sized to fit models with wide forks. Features embroidered Bar & Shield logo and full-length hook-and-loop closure over zipper. The inside is plushly lined.

**91782-95** **\$59.95**

Fits '84-later FXST Softail® models (except Springer®, FXCW/C and FXSTD) and '93-'08 Dyna® Wide Glide® models.

### B. LICENSE PLATE BAG

The perfect accessory for storing small items, this bag mounts quickly to the license plate bracket of your motorcycle. A zippered pocket and embroidered "Harley-Davidson" logo add the finishing touches.

**64267-00** **\$49.95**

Fits XL (except XL883N and XL1200N), Dyna® (except FXDB, FXDF and '10 FXDWG), and Softail® models without Bobtail fenders or luggage racks (except FXCW/C). Does not fit with Layback License Plate Mounting Kits.

### C. LEATHER SISSY BAR BAGS

This Sissy Bar Bag is an easy way to add extra storage. High-quality molded-leather construction holds its shape and is a convenient place to store quick-access items. Features a turn-buckle closure for a snug fit.

Fits most Harley-Davidson® Medallion/Insert Style Sissy Bar Uprights, Luggage Racks and Pad. Will not fit with Mini, Short, VRSC™, XR, or FXSTD Uprights. Will not fit with backrest-pad mounted luggage.

**52997-98** Bar & Shield Logo Concho. **\$89.95**

**52998-98** Chrome Studs. **\$89.95**

### D. LEATHER SISSY BAR/TOOL BAG

Heavy full-grain Latigo leather is specially tanned, oiled, and waxed to withstand the elements. Identified with a custom Harley-Davidson® concho. 4" x 4" x 11".

**91772-85A** **\$89.95**

For use with FXDWG (except '10 FXDWG with Original Equipment Sissy Bar) and FXSTC models only.

### E. LEATHER SISSY BAR BAG

Manufactured of durable full-grain Latigo leather and decorated with bright, chrome-plated studs.

**91051-94** Studded. **\$89.95**



A. LEATHER FORK BAG



B. LICENSE PLATE BAG



C. LEATHER SISSY BAR BAG – BAR & SHIELD LOGO CONCHO



C. LEATHER SISSY BAR BAG – CHROME STUDS



D. LEATHER SISSY BAR/TOOL BAG



E. LEATHER SISSY BAR BAG

Notice: The prices appearing in this catalog are the manufacturer's suggested retail prices. Actual retail prices may vary.



# LUGGAGE 699

Sissy Bar & Fork Bags



F

F. HANDLEBAR/FORK BAGS



G

G. SOFT LEATHER HANDLEBAR/FORK BAG

## F. HANDLEBAR/FORK BAGS

Constructed of durable synthetic leather with embossed "H-D Eagle Wing" logo. Looks great on sissy bar uprights, handlebars, and front forks.

If used in front fork application, fits '84-later FLSTC Softail® models and '93-later FXDWG Dyna® models. '82-'89 FXR models require Directional Relocation Kit P/N 90504-82A.

**91743-87T** 11-inch length. **\$29.95**  
**91744-87T** 8-inch length. **\$24.95**

## G. SOFT LEATHER HANDLEBAR/FORK BAG

Features include embroidered logos, full-length hook-and-loop closure over zipper, and plush nylon pile inside lining. Features silver "Harley-Davidson" logo.

**91773-85** **\$59.95**  
 If used in front fork application, fits '84-later FLSTC Softail® models and '93-later FXDWG Dyna® models. '82-'89 FXR models require Directional Relocation Kit P/N 90504-82A.

## H. FORK BAG

Add a touch of leather up front with this functional Fork Bag. Styled to complement the Softail® Rocker™ model's fuel tank badge and accessory saddlebags, the embossed Bar & Shield logo makes a simple statement. The durable mounting bracket helps keep the bag in place, and the heavyweight leather will last for years to come.

**92352-08** **\$79.95**  
 Fits '08-later FXCW and FXCWC models.

## I. CD HOLDER

A great accessory for your in-dash CD or Tour-Pak® mounted CD changer. This convenient CD case holds up to 12 CDs and fits neatly in the storage box of FLHT models, or in the inner fairing box of FLTR models.

**58481-02** Universal. **\$9.95**

## J. HERITAGE LEATHER TOURING BAG

Styled to match Heritage Softail Classic models, this bag features chrome spots, buckles, and heavy-duty wide leather straps. With quick-disconnect clips for easy removal and 720 cubic inches of storage space, this bag is as convenient as it is cavernous.

**98864-97** **\$299.95**  
 Fits Softail models equipped with Luggage Rack P/N 53465-87B, 56465-86A or 53713-96.

## K. SADDLEBAG COOLER

Turn your saddlebag into a refrigerator. The insulating liner keeps cold in, and the convenient zipper closure makes packing a snap. The shape fits easily into most hard and soft saddlebags, and has room for up to twelve 12-oz. soda cans.

**94185-01** Square. **\$39.95**  
 Fits '93-later Touring models equipped with stock saddlebags, '86-later FLSTC and '97-later FLSTS models equipped with stock leather saddlebags.

**94184-01** Slant. **\$39.95**  
 Fits '93-later Touring models equipped with Color-Matched Hard Saddlebags.



H

H. FORK BAG



I

I. CD HOLDER

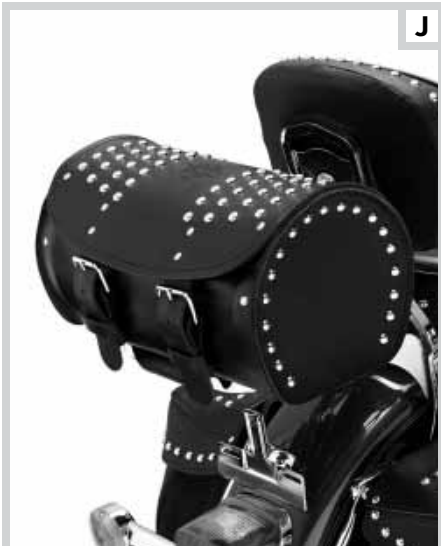

J

J. HERITAGE LEATHER TOURING BAG



K

K. SADDLEBAG COOLER – SQUARE AND SLANT

LUGGAGE

Notice: The prices appearing in this catalog are the manufacturer's suggested retail prices. Actual retail prices may vary.

# 700 LUGGAGE

## Windshield Bags

### A. LEATHER THREE-POCKET FAIRING POUCH

Add convenient extra storage space to the inside of your fairing with this Leather Fairing Pouch, featuring three easily accessible, individual storage pockets with embossed "Harley-Davidson" logo on top of center pouch.

**58900-98B** **\$109.95**

Fits '96-later Electra Glide® and FLHTCUTG models (except FLHX and FLHXXX). Does not fit with Wind Deflectors P/N 57185-05, 58207-04 or 58204-98. Does not fit with fairing mounted GPS navigation units.

### B. TWO-POCKET FAIRING POUCH

Convenient storage space right at your fingertips. Sized to fit with low-profile windshields and wind deflectors, this Two-Pocket Fairing Pouch is ideal for storing cell phones and sunglasses while you are on the road. Hook-and-loop closures keep the embossed leather flaps securely closed. Easy-to-install.

**58928-08** **\$99.95**

Fits '98-later Electra Glide, FLHTCUTG, Street Glide®, and Trike models. Does not fit with fairing mounted GPS navigation units.

### C. ELECTRA GLIDE® LEATHER FAIRING POUCH

Easily installed inner fairing pouch is designed to hold sunglasses, cigarettes, etc. All-leather construction around a molded ABS plastic base for shape retention. Has an easy-to-use full-length hook-and-loop closure and features a black embroidered Bar & Shield logo on the lid.

**58248-96** **\$79.95**

Fits '96-later Electra Glide and FLHTCUTG models (except FLHX and FLHXXX). Does not fit with Wind Deflectors P/N 58207-04 or 58204-98. Does not fit with fairing mounted GPS navigation units.



A. LEATHER THREE-POCKET FAIRING POUCH



B. TWO-POCKET FAIRING POUCH



C. ELECTRA GLIDE LEATHER FAIRING POUCH

*Notice: The prices appearing in this catalog are the manufacturer's suggested retail prices. Actual retail prices may vary.*

# LUGGAGE 701

Windshield Bags



D

D. THREE-POCKET WINDSHIELD POUCH

## D. THREE-POCKET WINDSHIELD POUCH

Add convenient storage space up front where you need it. This easy-to-install windshield pouch features three easily accessible storage pockets sized for cell phones, glasses and other small items. The center pouch is accented with an embossed "Harley-Davidson" Script for a finishing touch.

**58904-03** **\$109.95**

Fits King-Size windshields (except Springer® and Rigid Mount King Size windshields) and Road King® windshields (except Wind Deflector and Adjustable Height windshields).

## E. TWO-POCKET WINDSHIELD POUCH

Add convenient storage space up front where you need it. This easy-to-install windshield pouch features two easily accessible storage pockets sized for cell phones, glasses and other small items. Hook-and-loop closures allow easy one-handed opening. Both pouches are accented with an embossed "Harley-Davidson" logo for a finishing touch.

**57203-07** **\$99.95**

Fits King-Size or Compact windshields. Does not fit FLSTSB, FXDWG or FXSTD models. Does not fit Rigid-Mount, Super Sport, Nostalgic or Flamed windshields.

## F. DETACHABLE HANDBAG FOR WINDSHIELDS

Combine the on-bike storage of a windshield bag with the take-along convenience of a handbag. Constructed of leather and nylon, this durable and spacious bag features a zippered inside pocket for cell phones, PDAs, digital cameras, wallets or sunglasses. The convenient mounting system allows easy attachment to the windshield, and the quick-detach buckle lets you take it with you when you leave your bike. The purse-length leather shoulder strap and the smooth leather flap with embossed Bar & Shield logo offer the styling flexibility to complement any Harley-Davidson® motorcycle or MotorClothes® fashion design. Maximum capacity 2.5 lbs.

**58402-04** **\$79.95**

Fits King-Size windshields (except Nostalgic, Flame, and Skull with Wings King-Size), and Compact windshields (except FXSTD, Flame, and Skull with Wings). Does not fit 100th Anniversary logo windshields, models equipped with handlebar mount gauges, or Road Tech™ Riser Mount Radio.



E

E. TWO-POCKET WINDSHIELD POUCH



F

F. DETACHABLE HANDBAG FOR WINDSHIELDS

Notice: The prices appearing in this catalog are the manufacturer's suggested retail prices. Actual retail prices may vary.

## 702 LUGGAGE

### Windshield Bags

#### A. FAT BOY® WINDSHIELD BAG WITH DIE-CAST CONCHO

With a '00-'06 style "Fat Boy" logo concho and a leather laced lid, this bag provides classic Fat Boy® styling and convenient storage. It's the ideal accessory for Fat Boy Saddlebags P/Ns 91536-00A and 90320-00B.

**56626-99 \$79.95**

Fits King-Size windshields (except Nostalgic, Flame, and Skull with Wings King-Size), and Compact windshields (except FXSTD, Flame, and Skull with Wings). Does not fit 100th Anniversary logo windshields, models equipped with handlebar mount gauges, or Road Tech™ Riser Mount Radio.

#### B. WINDSHIELD BAG FOR ROAD KING® CUSTOM MODELS

Styled to complement the Road King Custom, this Windshield Bag features a stitched leather over leather design that forms the sweeping curves that match the Original Equipment seat and saddlebags. Convenient turn latch closure allows easy access, even while wearing gloves.

**57014-04 \$89.95**

Fits King-Size windshields (except Nostalgic, Flame, and Skull with Wings King-Size), and Compact windshields (except FXSTD, Flame, and Skull with Wings). Does not fit 100th Anniversary logo windshields, models equipped with handlebar mount gauges, or Road Tech™ Riser Mount Radio.

#### C. HERITAGE SPRINGER® LEATHER WINDSHIELD BAG – BLACK TRIM

Convenience with '97-'03 Heritage Springer styling. Easy-to-install.

**52931-99 \$79.95**

Fits King-Size windshields (except Nostalgic, Flame, and Skull with Wings King-Size), and Compact windshields (except FXSTD, Flame, and Skull with Wings). Does not fit 100th Anniversary logo windshields, models equipped with handlebar mount gauges, or Road Tech Riser Mount Radio.



A. FAT BOY WINDSHIELD BAG WITH DIE-CAST CONCHO



B. WINDSHIELD BAG FOR ROAD KING CUSTOM MODELS



C. HERITAGE SPRINGER LEATHER WINDSHIELD BAG – BLACK TRIM



# LUGGAGE 703

Windshield Bags



**D. WINDSHIELD BAG FOR SOFTAIL CUSTOM MODELS**



**E. WINDSHIELD BAG FOR FAT BOY MODELS**



**F. WINDSHIELD BAG FOR SOFTAIL DELUXE MODELS**



**G. WINDSHIELD BAG FOR SOFTAIL SPRINGER CLASSIC MODELS**



**H. LEATHER WINDSHIELD BAG WITH BAR & SHIELD LOGO**



**I. ROAD KING LEATHER WINDSHIELD BAG**



**J. EMBOSSED BAR & SHIELD LOGO LEATHER WINDSHIELD BAG**



**K. ROAD KING CLASSIC LEATHER WINDSHIELD BAG**

**D. WINDSHIELD BAG FOR SOFTAIL® CUSTOM MODELS**

This heavy-weight windshield bag features a leather strap and chrome buckle for maximum style. Turn-buckle closure allows easy access to the contents.

**57220-07A** **\$99.95**

Fits King-Size windshields (except Flame, and Skull with Wings King-Size), and Compact windshields (except FXSTD, Flame, and Skull with Wings). Does not fit 100th Anniversary logo windshields, models equipped with handlebar mount gauges, or Road Tech™ Riser Mount Radio.

**E. WINDSHIELD BAG FOR FAT BOY® MODELS**

Highly stylized with a leather embossed lid, this convenient Windshield Bag features decorative chrome spots and Spanish lacing. Easy-to-install, this leather bag includes simple hook-and-loop closure for one-handed access.

**57216-07A** **\$99.95**

Fits King-Size windshields (except Flame, and Skull with Wings King-Size), and Compact windshields (except FXSTD, Flame, and Skull with Wings). Does not fit 100th Anniversary logo windshields, models equipped with handlebar mount gauges, or Road Tech Riser Mount Radio.

**F. WINDSHIELD BAG FOR SOFTAIL® DELUXE MODELS**

This leather windshield bag features an embossed winged Bar & Shield logo and weave pattern insert. Bag includes turn-buckle closure for fast access to glasses, cell phone and other small items.

**57207-05A** **\$89.95**

Fits King-Size windshields (except Flame, and Skull with Wings King-Size), and Compact windshields (except FXSTD, Flame, and Skull with Wings). Does not fit 100th Anniversary logo windshields, models equipped with handlebar mount gauges, or Road Tech Riser Mount Radio.

**G. WINDSHIELD BAG FOR SOFTAIL®**

**SPRINGER® CLASSIC MODELS**

Leather windshield bag features basket-weave textured lid and turn-buckle latch for easy access. Styled to complement the Softail Springer Classic seat and accessory saddlebags.

**57239-05A** **\$79.95**

Fits King-Size windshields (except Flame, and Skull with Wings King-Size), and Compact windshields (except FXSTD, Flame, and Skull with Wings). Does not fit 100th Anniversary logo windshields, models equipped with handlebar mount gauges, or Road Tech Riser Mount Radio.

**H. LEATHER WINDSHIELD BAG WITH BAR & SHIELD LOGO**

Extra storage. Extra style. Extra miles. Accented with decorative chrome studs and an embossed Bar & Shield logo.

**58298-87** **\$79.95**

Fits King-Size windshields (except Nostalgic, Flame, and Skull with Wings King-Size), and Compact windshields (except FXSTD, Flame, and Skull with Wings). Does not fit 100th Anniversary logo windshields, models equipped with handlebar mount gauges, or Road Tech Riser Mount Radio.

**I. ROAD KING® LEATHER WINDSHIELD BAG**

Accented with decorative black studs and an embroidered Road King V-Logo. Easy installation.

**58297-94** **\$79.95**

Fits King-Size windshields (except Nostalgic, Flame, and Skull with Wings King-Size), and Compact windshields (except FXSTD, Flame, and Skull with Wings). Does not fit 100th Anniversary logo windshields, models equipped with handlebar mount gauges, or Road Tech Riser Mount Radio.

**J. EMBOSSED BAR & SHIELD LOGO LEATHER WINDSHIELD BAG**

Styling details include embossed Bar & Shield logo. Fabricated of black domestic steerhide.

**58308-95** **\$79.95**

Fits King-Size windshields (except Nostalgic, Flame, and Skull with Wings King-Size), and Compact windshields (except FXSTD, Flame, and Skull with Wings). Does not fit 100th Anniversary logo windshields, models equipped with handlebar mount gauges, or Road Tech Riser Mount Radio.

**K. ROAD KING CLASSIC LEATHER WINDSHIELD BAG**

Features textured leather insert and H-D® concho.

**58189-98** **\$89.95**

Fits King-Size windshields (except Nostalgic, Flame, and Skull with Wings King-Size), and Compact windshields (except FXSTD, Flame, and Skull with Wings). Does not fit 100th Anniversary logo windshields, models equipped with handlebar mount gauges, or Road Tech Riser Mount Radio.

LUGGAGE

# 704 LUGGAGE

## Storage Tubes & Bungees

### A. COIN HOLDER

This item will come in handy at the toll booths. No more fumbling for change. Change holder detaches quickly and can be attached to your belt or stowed in a saddlebag when away from your bike.

**98200-88T** \$19.95  
Clamp mount. Fits 7/8" to 1" handlebar.

### B. BILLET STORAGE TUBE

Machined from 6061 billet aluminum, this finely detailed Billet Storage Tube offers a convenient storage location for essential tools, sunglasses (2" versions), or registration papers. The mirror-chrome "ball-milled" tube features water-resistant threaded and O-ring sealed end caps on both ends for convenient access. The billet mounting clamp is adjustable for position, and allows interference-free installation on the front down tube of the specified models. Available in three sizes for every storage need. Includes all necessary mounting hardware.

Fits '00-'03 XL, '00-'05 Dyna® and '00-later Softail® models.

**64120-06** Mini. \$129.95  
7.5" long x 1" diameter.

**64100-03** Medium. \$159.95  
7" long x 2" diameter.

**64101-03** Large. \$169.95  
10" long x 2" diameter.

### C. BLACK BUNGEE CORDS

**98196-85T** 18" length. \$2.95

**98197-85T** 24" length. \$2.95

**98198-85T** 30" length. \$2.95

**98199-85T** 24" length - 4 hook. \$4.95

#### Chrome Bungee Nuts

**98184-90T** 3/8" - 24 thread. (pair) \$6.95

**98185-90T** 3/8" - 16 thread. (pair) \$6.95

### D. BLACK CARGO NETS

These versatile nets feature vinyl-coated attaching hooks to hold your cargo securely. For helmets, small packages, etc. Works great with chrome bungee nuts.

**97008-07** 12" x 12" - 4 hook. \$6.95

**98170-88T** 15" x 15" - 6 hook. \$7.95

**98169-88T** 18" x 18" - 6 hook. \$8.95



A. COIN HOLDER



B. BILLET STORAGE TUBE - LARGE



B. BILLET STORAGE TUBE - MEDIUM



B. BILLET STORAGE TUBE - MINI



C. BLACK BUNGEE CORDS



D. BLACK CARGO NETS

Notice: The prices appearing in this catalog are the manufacturer's suggested retail prices. Actual retail prices may vary.



**E. POW/MIA FLAG KIT**



**F. AMERICAN FLAG KIT**



**G. DECORATIVE CONCHOS**



**H. "HARLEY-DAVIDSON/U.S.A." CUSTOM CONCHO AND LEATHER ROSETTE AND LACING STRAP**



**I. DECORATIVE SPOTS**



**J. SADDLEBAG SNAP REPAIR KIT**

## E. POW/MIA FLAG KIT

Show support for the American POW and MIA military forces with this flag and mast kit. Flags are made with high-quality nylon for durability. Available in sissy bar mount or Tour-Pak® Luggage Carrier/Saddlebag mount versions. (Flags are designed for parade use only and will not withstand high-speed use.)

**94901-03** **\$29.95**  
Fits Color-Matched Tour-Pak® Luggage Carriers and fiberglass saddlebags. Does not fit Leather Tour-Pak Luggage. Works great on cars and trucks too!

**94900-03** **\$29.95**  
Fits Sissy Bars (except Mini and Short Uprights with Backrest Pads).

**94902-03** Replacement POW/MIA flag only. **\$15.95**

## F. AMERICAN FLAG KIT

Whether showing your patriotism or your love of Harley® motorcycles, showing your colors is easier than ever with quality flag and mast kits. Flags are made with high-quality nylon for durability. Available in sissy bar mount or Tour-Pak® Luggage Carrier/Saddlebag mount. (Flags are designed for parade use only and will not withstand high-speed use.)

**94626-98** **\$29.95**  
Fits Color-Matched Tour-Pak Luggage Carriers and fiberglass saddlebags. Does not fit Leather Tour-Pak Luggage. Works great on cars and trucks too!

**94616-98** **\$29.95**  
Fits Sissy Bars (except Mini and Short Uprights with Backrest Pads).

**94625-98** Replacement flag only. **\$15.95**

## G. DECORATIVE CONCHOS

Stylish Harley-Davidson® conchos can customize anything, from saddlebags and seats to tank pouches and tool bags. Includes Rosette & Lacing Strap.

**91877-97** Package quantity 1. **\$7.99**

## H. "HARLEY-DAVIDSON/U.S.A." CUSTOM CONCHO

Conchos are polished, nickel-plated, and identified with a recessed "Harley-Davidson Motorcycles - U.S.A." logo in contrasting black. Attaches securely with a tie wrap. Rosettes & Lacing Strap sold separately.

**91857-91** Package quantity 1. **\$5.99**

**Shown with:**

### LEATHER ROSETTE AND LACING STRAP FOR "HARLEY-DAVIDSON/U.S.A." CUSTOM CONCHO

Available in black, these leather accents can be used when attaching H-D custom conchos.

**91722-04** Package quantity 1. **\$13.95**

## I. DECORATIVE SPOTS

Make your own personal styling statement by identifying your leather jacket, cap, saddlebags, sissy bar bag, etc., with Decorative Spots that are made of rustproof, nickel-plated solid brass.

### Decorative Chrome Spots

**93023-88** Round 3/4". **\$25**

**93024-88** Round 1/2". **\$25**

**93025-88** Round 1/4". **\$20**

### Decorative Road King® Black Jeweled Spot (not shown)

**93036-95** Matches FLHR models. **\$1.15**

### Decorative Heritage Chrome Spot (not shown)

**93037-09** Matches FLSTC models. (Package quantity 1.) **\$1.50**

## J. SADDLEBAG SNAP REPAIR KIT

Features heavy-duty repair snaps and do-it-yourself tool for replacing broken snaps on saddlebags and leather clothing.

**90739-99** **\$15.95**

**Also available: (not shown)**

### SADDLEBAG STRAP REPAIR KIT

Features rivets and washers required for saddlebag strap repair. Kit includes 16 rivets (4 sizes) and 16 washers.

**88272-06** **\$9.99**



## CUSTOM SEAT PROGRAM

*No matter the stage of your custom effort, a personalized seat is the perfect thread to tie your bike's attitude together. Select the stitching pattern, leather inlay and thread color that best support your custom movement, and you'll have your personalized seat in just three weeks.*

[www.harley-davidson.com/customseat](http://www.harley-davidson.com/customseat)



# CUSTOM SEAT OPTIONS & ORDERING

Available in Brawler® solo and Sidekick® two-up designs, these custom saddles are styled to accent the lines of many Dyna®, Softail® and Touring models. Shaped from premium open-cell polyurethane foam, these seats provide maximum rider support, without being “too hard.” The fiberglass seat pan adds strength and flexibility, and the felt-covered underside protects the paint and bodywork. The high-quality fine-grained leather seating surfaces provide ultimate comfort, and the vinyl side panels add flexibility and durability for the long haul.

## SELECT A SEAT

### CUSTOM BRAWLER® SOLO SEAT

When it's time to go it alone, go solo in style. This premium quality cowhide leather saddle is designed to create a low and lean look.

#### Available for:

**51621-09** \$399.95

Fits '06-later Dyna® models. Seat width: 12.5"

**52246-08** \$399.95

Fits '07-later FLSTF, FLSTFB, FLSTSB and '06-later FXST, FXSTB, FXSTC and FXSTS models (except FXSTSSE/2/3). Seat width 12.5"

**51619-09** \$399.95

Fits '08-later Touring models (except Trike). Does not fit models equipped with Passenger Grab Rails. Does not accept Rider Backrest. Seat width 13.0"

**51800-09** \$399.95

Fits '97-'07 Road King® and FLHX models. Does not accept Rider Backrest. Seat width 13.0"



### CUSTOM SIDEKICK® TWO-UP SEAT

This premium cowhide leather seat hugs the frame for a low-slung look but adds back support for the rider and extra padding for the passenger.

#### Available for:

**51626-09** \$479.95

Fits '06-later Dyna® models. FXD and FXDB models require separate purchase of Passenger Footpegs and Passenger Footpeg Mounting Kit p/n 50210-06. Seat width: 12.5"; pillion width: 6"

**52193-08** \$479.95

Fits '07-later FLSTF, FLSTFB, FLSTSB and '06-later FXST, FXSTB, FXSTC and FXSTS models (except FXSTSSE/2/3). Seat width 12.5"; pillion width 6.5"

**51620-09** \$479.95

Fits '08-later Touring models (except Trike). Does not fit models equipped with Passenger Grab Rails. Does not accept Rider Backrest. Seat width 13.5"; pillion width 6.5"

**51745-09** \$479.95

Fits '97-'07 Road King® and FLHX models. Does not accept Rider Backrest. Seat width 13.5"; pillion width 6.5"



## SELECT A STITCH PATTERN & COLOR

### AVAILABLE THREAD COLORS

Saddle | Yellow | Orange | Red | Black Cherry | Blue | Green | Grey | Titanium | Black



ACCENDO



TORRENS



CREAMATOR



REQUIEM



SOLUS



DEVIL TAIL



TERREO



WILLIE G. SKULL

## SELECT AN INLAY MATERIAL & COLOR

### INLAY MATERIALS

01. Blue Alligator
02. Black Alligator
03. Charcoal Alligator
04. Orange Alligator
05. Yellow Alligator
06. Red Alligator
07. Green Cowhide
08. Burgundy Ostrich
09. Red Ostrich
10. Grey Snakeskin

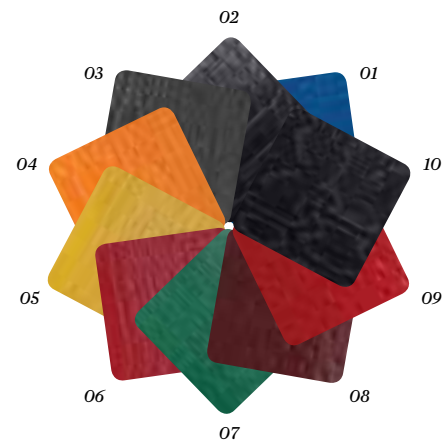

The realistic Alligator, Ostrich and Snakeskin textures are embossed in natural cowhide leather.



## DESIGN IT YOURSELF

We make it simple. Log on to design your seat and watch it come to life. Select the pattern, the inlay and the color, then bring the specs to your dealer and have your seat in hand in just three weeks. Your dealer has a useful swatch book of all inlay materials and stitching options to help you make your choices.

[www.harley-davidson.com/customseat](http://www.harley-davidson.com/customseat)

### STEP 1: SELECT A SEAT

Choose from the Brawler® solo or the Sidekick® two-up seat.

### STEP 2: SELECT A STITCH PATTERN & COLOR

Choose from eight different flame, skull, or tribal designs, stitched in your choice of ten different colors that complement your bike's paint and pinstripes.

### STEP 3: SELECT AN INLAY MATERIAL & COLOR

Embossed leather inlays are available in ten colors and styles to match your bike's personality.

### STEP 4: PRINT IT OUT

Print out your design, take it to your Harley® dealership, and you'll have your seat in just three weeks.



NOTE: Harley-Davidson® custom seats feature color-matched stitching and/or stylized surfaces for maximum customization. As with all genuine cowhide leather, these surfaces are not designed for long-term exposure to inclement weather and should be protected with a Harley-Davidson Seat Rain Cover or Motorcycle Storage Cover (sold separately).



A close-up photograph of a Harley-Davidson motorcycle fuel tank. The tank is a dark, metallic color with a prominent, circular, brushed metal logo in the center. The logo features a skull in the middle, surrounded by the words "HARLEY-DAVIDSON" in a circular arrangement. The background is blurred, showing other parts of the motorcycle and some bokeh light effects.

## PAINT & BODYWORK

*Are you classic and understated, hard-core and brash, or simple and tough? Find the paint scheme that strikes the right balance between attitude and subtlety, or take it to the extremes. All Harley-Davidson® Color Shop paint sets put a premium on depth of design, paint quality and finish. To maintain exclusivity, sets are introduced just twice a year and quantities are strictly limited.*

# PAINT & BODYWORK **OPTIONS**

## SELECTING CUSTOM PAINT

*The most visible piece of any customizing strategy is custom paint. The paint's design, depth and richness set the tone for the rest of the accessories, and the finish sets your bike apart from the crowd. Sets are distributed in limited numbers to Harley-Davidson® dealers worldwide, so you shouldn't see the same design parked next to you on Main Street. But don't be disappointed if your dealer doesn't have the paint set you crave in stock. They may be able to help you locate the set by accessing the dealer-exclusive Parts Locator system.*

*Harley-Davidson hand-picks our custom painters and continually monitors their painting process and finish quality to guarantee your satisfaction. Color Shop custom paint sets begin with virgin factory sheet metal, and we apply only the finest primers, paints and coatings to achieve the richest, fade-free finish.*

---

### LIMITED CUSTOM PAINT

Building a work of art, literally. Limited Custom Paint sets feature exclusive, limited-edition designs, hand-painted to offer superior depth and detail. Styled to complement specific motorcycle models, the colors and curves work to showcase the lines of the bike. Each show-quality paint scheme is numbered to provide you with the ultimate in exclusivity.

**The Color Shop Commitment:** *We stand behind each Color Shop set with an unmatched two-year Harley-Davidson® warranty, and we will provide replacement Limited and Core Series painted parts for seven years following the introduction of a custom paint design.*



---

### CORE CUSTOM PAINT

A legend in the making. The Core Series features a collection of custom designs styled to complement the heritage of the motorcycle model. Pearl, candy and metallic finishes are combined with exclusive logos to create a unique statement. Available year round, Core, Edge Flame, and Personal Accents paint sets are available for a wide variety of models.

**The Color Shop Commitment:** *We stand behind each Color Shop set with an unmatched two-year Harley-Davidson® warranty, and we will provide replacement Limited and Core Series painted parts for seven years following the introduction of a custom paint design.*





---

**CALIFORNIA KID CUSTOM PAINT**

This classic paint scheme brings a timeless style to contemporary motorcycles. The design features the vivid base color accented with color-fade flames and complementing pinstripes that have been used on all things custom, from cars to motorcycles. The California Kid design is available as a sheet metal exchange program only.

***The Color Shop Commitment:** We stand behind each Color Shop set with an unmatched two-year Harley-Davidson® warranty, and we will provide replacement Limited and Core Series painted parts for seven years following the introduction of a custom paint design.*

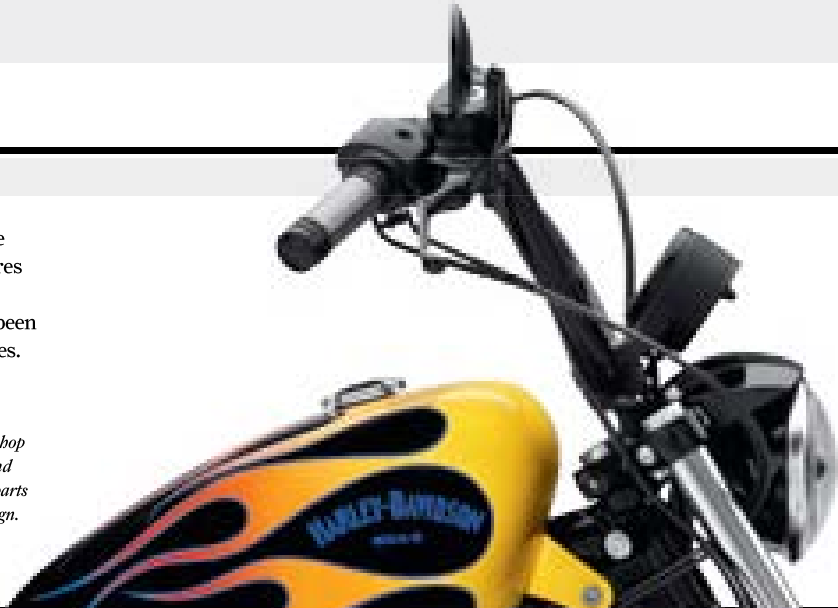

---

**SPECTRUM CUSTOM PAINT**

Through Spectrum Custom Color Creation, you have the freedom to select from an almost unlimited combination of colors. Color-match to current or discontinued Harley-Davidson® paint schemes, or select from an endless number of automotive-style color combinations. Supply your own sheet metal or buy a replacement set; either way you can create your own look.

***The Color Shop Commitment:** We stand behind each Color Shop set with an unmatched two-year Harley-Davidson® warranty, and we will provide replacement Limited and Core Series painted parts for seven years following the introduction of a custom paint design.*



---

**COLOR-MATCHED BODYWORK**

Create your own unique profile. Bobtail or Chopped fenders, front spoilers, air cleaner covers and headlamp visors are available to give your bike a clean, custom look. Available in Vivid Black or primed and ready for your own paint, these accessories are manufactured to the same quality standards as the Original Equipment bodywork on your factory bike.





# 714 COLOR SHOP

Limited Series Custom Paint

## COLOR SHOP LIMITED SERIES – NIGHT

Lay waste to the light. The denim finish shows off its versatility with old school red pin striping and silver flames. Airbrushed shadows add a layer of depth as the silver fire breaks out of the black base. Hand laid white-hot detailing sheds a little light on an otherwise dark world.

Available starting September 2009 – see your Dealer for availability.

For a finishing touch, order the matching custom framed wall hanging to decorate your den or garage. Hand painted by the same artists that worked on your bike, the framed sheet-metal canvas reflects the unique design of your ride.



COLOR SHOP LIMITED SERIES – NIGHT (SHOWN ON DYNA® STREET BOB®)

Available to fit:

### Nighster® and Iron 883™

Fits '10 XL883N and XL1200N models (except Canada and Mexico models).

Fits '10 XL883N and XL1200N models for Canada and Mexico.

### Dyna® Street Bob®

Fits '09-'10 FXDB models.

### Dyna Wide Glide®

Fits '10 domestic FXDWG models.

Fits '10 non-U.S. FXDWG models.

### Dyna Fat Bob®

Fits '08-'10 FXDF models.

### Softail® Custom and Night Train®

Fits '08-'09 FXSTB and '08-'10 FXSTC models. Models for non-U.S. markets require separate purchase of Dampening Kit P/N 60834-07.

### Softail Cross Bones™

Fits '08-'10 FLSTSB models. Models for non-U.S. markets require separate purchase of Dampening Kit P/N 60834-07.

### Limited Design Framed Artwork

## NIGHT

95767-10DDK

\$2,399.95

95776-10DDK

\$1,650.00

95723-10DDK

\$2,499.95

95734-10DDK

\$2,499.95

95777-10DDK

\$1,650.00

95760-10DDK

\$2,499.95

95703-10DDK

\$2,499.95

95764-10DDK

\$2,599.95

94534-10DDK

\$999.95

Notice: The prices appearing in this catalog are the manufacturer's suggested retail prices. Actual retail prices may vary.



COLOR SHOP LIMITED SERIES – NIGHT (SHOWN ON ROAD KING®)

Available to fit:

	NIGHT
<b>Road King® Classic</b> Fits '09-'10 FLHRC models.	95716-10DDK \$3,299.95
<b>Road King</b> Fits '09-'10 FLHR models.	95717-10DDK \$4,699.95
<b>Road Glide®</b> Fits '10 FLTRX models (except Canada and Mexico models).	95722-10DDK \$5,549.95
<b>Street Glide®</b> Fits '09-'10 FLHX models (except Canada and Mexico models).	95756-10DDK \$5,549.95
<b>Road Glide</b> Fits '10 Canada and Mexico FLTRX models.	95714-10DDK \$5,549.95
<b>Street Glide</b> Fits '09-'10 Canada and Mexico FLHX models.	95715-10DDK \$5,549.95

Notice: The prices appearing in this catalog are the manufacturer's suggested retail prices. Actual retail prices may vary.

# 716 COLOR SHOP

Limited Series Custom Paint

## COLOR SHOP LIMITED SERIES – BURN

Set the streets on fire. Vivid Black flames doused with red candy paint lick at the gloss black base that cover your ride from end to end. Rich shadow detail gives the impression of a blaze consuming itself in a never-ending circle of smoldering intensity. The hand-lettered Harley-Davidson ignites even the coldest passerby.

Available starting August 2009 – see your Dealer for availability.

For a finishing touch, order the matching custom framed wall hanging to decorate your den or garage. Hand painted by the same artists that worked on your bike, the framed sheet-metal canvas reflects the unique design of your ride.



COLOR SHOP LIMITED SERIES – BURN (SHOWN ON SOFTAIL® CUSTOM)

Available to fit:

	BURN
<b>Nightster® and Iron 883™</b> Fits '10 XL883N and XL1200N models (except Canada and Mexico models).	95767-10DDF \$2,399.95
Fits '10 XL883N and XL1200N models for Canada and Mexico.	95776-10DDF \$1,650.00
<b>Dyna® Street Bob®</b> Fits '09-'10 FXDB models.	95723-10DDF \$2,499.95
<b>Dyna Wide Glide®</b> Fits '10 domestic FXDWG models.	95734-10DDF \$2,499.95
Fits '10 non-U.S. FXDWG models.	95777-10DDF \$1,650.00
<b>Dyna Fat Bob®</b> Fits '08-'10 FXDF models.	95760-10DDF \$2,499.95
<b>Softail® Custom and Night Train®</b> Fits '08-'09 FXSTB and '08-'10 FXSTC models. Models for non-U.S. markets require separate purchase of Dampening Kit P/N 60834-07.	95703-10DDF \$2,499.95
<b>Fat Boy®</b> Fits '08-'10 FLSTF and FLSTFB models. Models for non-U.S. markets require separate purchase of Dampening Kit P/N 60832-07.	95710-10DDF \$2,599.95
<b>Softail Cross Bones™</b> Fits '08-'10 FLSTSB models. Models for non-U.S. markets require separate purchase of Dampening Kit P/N 60834-07.	95764-10DDF \$2,599.95
<b>Limited Design Framed Artwork</b>	94534-10DDF \$999.95

Notice: The prices appearing in this catalog are the manufacturer's suggested retail prices. Actual retail prices may vary.

**COLOR SHOP LIMITED SERIES – TRUST ME**

Let's make a deal. Sharp tribal devil tails dance across the bike as hollow pinstripe flames scream in silence. Airbrushed and paint flecked, Old Scratch leads the way looking for the next lost soul. A gothic Harley-Davidson script dresses the tank while "Trust Me" is splayed on the rear fender.

Available starting December 2009 – see your Dealer for availability.

For a finishing touch, order the matching custom framed wall hanging to decorate your den or garage. Hand painted by the same artists that worked on your bike, the framed sheet-metal canvas reflects the unique design of your ride.



COLOR SHOP LIMITED SERIES – TRUST ME (SHOWN ON DYNA® STREET BOB®)

Available to fit:

**Nightster® and Iron 883™**

Fits '10 XL883N and XL1200N models (except Canada and Mexico models).

Fits '10 XL883N and XL1200N models for Canada and Mexico.

**Dyna® Street Bob®**

Fits '09-'10 FXDB models.

**Dyna Wide Glide®**

Fits '10 domestic FXDWG models.

Fits '10 non-U.S. FXDWG models.

**Dyna Fat Bob®**

Fits '08-'10 FXDF models.

**Softail® Custom and Night Train®**

Fits '08-'09 FXSTB and '08-'10 FXSTC models. Models for non-U.S. markets require separate purchase of Dampening Kit P/N 60834-07.

**Softail Cross Bones™**

Fits '08-'10 FLSTB models. Models for non-U.S. markets require separate purchase of Dampening Kit P/N 60834-07.

**Limited Design Framed Artwork**

**TRUST ME**

95767-10DDI

\$2,399.95

95776-10DDI

\$1,650.00

95723-10DDI

\$2,499.95

95734-10DDI

\$2,499.95

95777-10DDI

\$1,650.00

95760-10DDI

\$2,499.95

95703-10DDI

\$2,499.95

95764-10DDI

\$2,599.95

94534-10DDI

\$999.95

Notice: The prices appearing in this catalog are the manufacturer's suggested retail prices. Actual retail prices may vary.



# 718 COLOR SHOP

Limited Series Custom Paint

## COLOR SHOP LIMITED SERIES – CHANCE

Luck be a lady tonight. In the tradition of 1940s bomber art, this hand-painted beauty delivers the goods with detailed shadowing and rockabilly-inspired style. Airbrushed highlights bring the graphic to life while dominos spelling out Harley-Davidson let the chips fall where they may. Fenders feature an airbrushed spade.

Available starting October 2009 – see your Dealer for availability.

For a finishing touch, order the matching custom framed wall hanging to decorate your den or garage. Hand painted by the same artists that worked on your bike, the framed sheet-metal canvas reflects the unique design of your ride.



COLOR SHOP LIMITED SERIES – CHANCE (SHOWN ON SOFTAIL® DELUXE)

Available to fit:

	CHANCE
<b>Softail® Custom and Night Train®</b> Fits '08-'09 FXSTB and '08-'10 FXSTC models. Models for non-U.S. markets require separate purchase of Dampening Kit P/N 60834-07.	95703-10DDD \$2,899.95
<b>Heritage Softail Classic</b> Fits '08-'10 FLSTC models. Models for non-U.S. markets require separate purchase of Dampening Kit P/N 60832-07.	95709-10DDD \$2,999.95
<b>Fat Boy®</b> Fits '08-'10 FLSTF and FLSTFB models. Models for non-U.S. markets require separate purchase of Dampening Kit P/N 60832-07.	95710-10DDD \$2,999.95
<b>Softail Deluxe</b> Fits '08-'10 FLSTN models. Models for non-U.S. markets require separate purchase of Dampening Kit P/N 60833-07.	95726-10DDD \$2,999.95
<b>Softail Cross Bones™</b> Fits '08-'10 FLSTSB models. Models for non-U.S. markets require separate purchase of Dampening Kit P/N 60834-07.	95764-10DDD \$2,999.95
<b>Limited Design Framed Artwork</b>	94534-10DDD \$999.95

Notice: The prices appearing in this catalog are the manufacturer's suggested retail prices. Actual retail prices may vary.

**COLOR SHOP LIMITED SERIES – RAZE**

Search and destroy. Strictly business, the Candy Root Beer basecoat looks wet enough to drink. Candy Tangerine grind flames across the tank and fenders finished in a transparent orange gloss demolish anything brave enough to get close, while vibrant orange pinstripes bear the mark of a professional. A Bar & Shield logo in motion cuts the competition down to size.

Available starting October 2009 – see your Dealer for availability.

For a finishing touch, order the matching custom framed wall hanging to decorate your den or garage. Hand painted by the same artists that worked on your bike, the framed sheet-metal canvas reflects the unique design of your ride.



COLOR SHOP LIMITED SERIES – RAZE (SHOWN ON FAT BOY®)

Available to fit:

RAZE

**Heritage Softail® Classic**

Fits '08-'10 FLSTC models. Models for non-U.S. markets require separate purchase of Dampening Kit P/N 60832-07.

95709-10DDL  
\$2,599.95

**Fat Boy®**

Fits '08-'10 FLSTF and FLSTFB models. Models for non-U.S. markets require separate purchase of Dampening Kit P/N 60832-07.

95710-10DDL  
\$2,599.95

**Softail Deluxe**

Fits '08-'10 FLSTN models. Models for non-U.S. markets require separate purchase of Dampening Kit P/N 60833-07.

95726-10DDL  
\$2,599.95

**Limited Design Framed Artwork**

94534-10DDL  
\$999.95

Notice: The prices appearing in this catalog are the manufacturer's suggested retail prices. Actual retail prices may vary.

# 720 COLOR SHOP

Limited Series Custom Paint

## COLOR SHOP LIMITED SERIES – BACKLASH

The enemy of my enemy is my friend. Worlds collide when denim and gloss work together to settle an old score. Metal flake runs rampant through the silver and slate marble gloss set inside a field of calm but unmistakable blood-red denim. The airbrushed skull and crossbones smile back in silent approval.

Available starting August 2009 – see your Dealer for availability.

For a finishing touch, order the matching custom framed wall hanging to decorate your den or garage. Hand painted by the same artists that worked on your bike, the framed sheet-metal canvas reflects the unique design of your ride.



COLOR SHOP LIMITED SERIES – BACKLASH (SHOWN ON FAT BOY®)

Available to fit:

### Heritage Softail® Classic

Fits '08-'10 FLSTC models. Models for non-U.S. markets require separate purchase of Dampening Kit P/N 60832-07.

### Fat Boy®

Fits '08-'10 FLSTF and FLSTFB models. Models for non-U.S. markets require separate purchase of Dampening Kit P/N 60832-07.

### Softail Deluxe

Fits '08-'10 FLSTN models. Models for non-U.S. markets require separate purchase of Dampening Kit P/N 60833-07.

### Limited Design Framed Artwork

### BACKLASH

95709-10DDG  
\$3,099.95

95710-10DDG  
\$3,099.95

95726-10DDG  
\$3,099.95

94534-10DDG  
\$999.95

Notice: The prices appearing in this catalog are the manufacturer's suggested retail prices. Actual retail prices may vary.

**COLOR SHOP LIMITED SERIES – PUNISHMENT**

It's time to pay the piper. Hot scalloped tribal flames promote discipline, and the blood-red pinstripes leave a lasting impression. Demon skulls emerge from the molten-detailed orange set against a rich gloss black base, while a giant tribal skull leads the retribution charge from the front fender.

Available starting November 2009 – see your Dealer for availability.

For a finishing touch, order the matching custom framed wall hanging to decorate your den or garage. Hand painted by the same artists that worked on your bike, the framed sheet-metal canvas reflects the unique design of your ride.



COLOR SHOP LIMITED SERIES – PUNISHMENT (SHOWN ON SOFTAIL® DELUXE)

Available to fit:

	PUNISHMENT
<b>Heritage Softail® Classic</b> Fits '08-'10 FLSTC models. Models for non-U.S. markets require separate purchase of Dampening Kit P/N 60832-07.	<b>95709-10DDE</b> <b>\$2,999.95</b>
<b>Fat Boy®</b> Fits '08-'10 FLSTF and FLSTFB models. Models for non-U.S. markets require separate purchase of Dampening Kit P/N 60832-07.	<b>95710-10DDE</b> <b>\$2,999.95</b>
<b>Softail Deluxe</b> Fits '08-'10 FLSTN models. Models for non-U.S. markets require separate purchase of Dampening Kit P/N 60833-07.	<b>95726-10DDE</b> <b>\$2,999.95</b>
<b>Limited Design Framed Artwork</b>	<b>94534-10DDE</b> <b>\$999.95</b>

Notice: The prices appearing in this catalog are the manufacturer's suggested retail prices. Actual retail prices may vary.



## 722 COLOR SHOP

Limited Series Custom Paint

### COLOR SHOP LIMITED SERIES – SINGE

Don't get too close. Classic looks with a twist, a vivid black base lets the sunglow orange scallops sear into the night sky. The hand-painted red clay pinstripes keep the style feeling clean, while ever-so-slight white accents pick up on natural lighting. Plenty hot.

Available starting November 2009 – see your Dealer for availability.

For a finishing touch, order the matching custom framed wall hanging to decorate your den or garage. Hand painted by the same artists that worked on your bike, the framed sheet-metal canvas reflects the unique design of your ride.



COLOR SHOP LIMITED SERIES – SINGE (SHOWN ON ROAD KING®)

Available to fit:

	SINGE
<b>Road King®</b> Fits '09-'10 FLHR models.	95717-10DDH \$4,699.95
<b>Road Glide®</b> Fits '10 FLTRX models (except Canada and Mexico models).	95722-10DDH \$5,549.95
<b>Street Glide®</b> Fits '09-'10 FLHX models (except Canada and Mexico models).	95756-10DDH \$5,549.95
<b>Road Glide</b> Fits '10 Canada and Mexico FLTRX models.	95714-10DDH \$5,549.95
<b>Street Glide</b> Fits '09-'10 Canada and Mexico FLHX models.	95715-10DDH \$5,549.95
<b>Limited Design Framed Artwork</b>	94534-10DDH \$999.95

Notice: The prices appearing in this catalog are the manufacturer's suggested retail prices. Actual retail prices may vary.

**COLOR SHOP LIMITED SERIES – FLOW**

Free form expression. Outlined in red metallic candy paint, the long interwoven tendril black flames over the charcoal base draw the onlooker’s eye from one end of the motorcycle to the other – and never let go. Meanwhile, the knock-out Harley-Davidson script lets everyone know exactly how you like to relax.

Available starting December 2009 – see your Dealer for availability.

For a finishing touch, order the matching custom framed wall hanging to decorate your den or garage. Hand painted by the same artists that worked on your bike, the framed sheet-metal canvas reflects the unique design of your ride.



COLOR SHOP LIMITED SERIES – FLOW (SHOWN ON STREET GLIDE®)

Available to fit:

	FLOW
<b>Road King® Classic</b> Fits '09-'10 FLHRC models.	95716-10CZU \$3,299.95
<b>Road King</b> Fits '09-'10 FLHR models.	95717-10CZU \$4,699.95
<b>Road Glide®</b> Fits '10 FLTRX models (except Canada and Mexico models).	95722-10CZU \$5,549.95
<b>Street Glide®</b> Fits '09-'10 FLHX models (except Canada and Mexico models).	95756-10CZU \$5,549.95
<b>Road Glide</b> Fits '10 Canada and Mexico FLTRX models.	95714-10CZU \$5,549.95
<b>Street Glide</b> Fits '09-'10 Canada and Mexico FLHX models.	95715-10CZU \$5,549.95
<b>Limited Design Framed Artwork</b>	94534-10CZU \$999.95

Notice: The prices appearing in this catalog are the manufacturer’s suggested retail prices. Actual retail prices may vary.

# 724 COLOR SHOP

Limited Series Custom Paint

## COLOR SHOP LIMITED SERIES – PRIMO

The cream of the crop. Brilliant lace webbed yellow and orange basecoat stops traffic with deeply textured detail. In a show of force, gloss black scallops make a sharp and bold appearance from the ground up. To finish it off, hot-rod pinstripes detail the fender and saddlebag lids, while a knocked-out Harley-Davidson script adds to the craftsmanship.

Available starting October 2009 – see your Dealer for availability.

For a finishing touch, order the matching custom framed wall hanging to decorate your den or garage. Hand painted by the same artists that worked on your bike, the framed sheet-metal canvas reflects the unique design of your ride.



COLOR SHOP LIMITED SERIES – PRIMO (SHOWN ON ROAD GLIDE)

Available to fit:

	PRIMO
<b>Road King</b> Fits '09-'10 FLHR models.	95717-10DDJ \$4,699.95
<b>Road Glide</b> Fits '10 FLTRX models (except Canada and Mexico models).	95722-10DDJ \$5,649.95
<b>Street Glide</b> Fits '09-'10 FLHX models (except Canada and Mexico models).	95756-10DDJ \$5,599.95
<b>Road Glide</b> Fits '10 Canada and Mexico FLTRX models.	95714-10DDJ \$5,649.95
<b>Street Glide</b> Fits '09-'10 Canada and Mexico FLHX models.	95715-10DDJ \$5,599.95
<b>Limited Design Framed Artwork</b>	94534-10DDJ \$999.95

Notice: The prices appearing in this catalog are the manufacturer's suggested retail prices. Actual retail prices may vary.

## COLOR SHOP CORE SERIES – PURGATORY

Make your individual statement. Hand-painted designs and rich finishes flow from one end of the bike to the other, and set your ride apart from the rest. Available throughout the year, Core Series Color Sets are covered by a two-year factory warranty when installed within 60 days of purchase of a new Harley-Davidson motorcycle. See Custom Coverage Program for complete warranty details.

Reap what you've sown. Matte black scallops atone for their sins in a world fired by denim charcoal. Hand painted jet-black pinstripes lay on top of a satin clear-coat, and add depth and dimension to the place between heaven and hell. The impact is vintage style living in the darkest dimension.



COLOR SHOP CORE SERIES – PURGATORY (SHOWN ON DYNA FAT BOB)

Available to fit:

	PURGATORY
<b>Dyna Street Bob</b> Fits '09-'10 FXDB models.	95723-10DDC \$2,199.95
<b>Dyna Wide Glide</b> Fits '10 domestic FXDWG models.	95734-10DDC \$2,199.95
Fits '10 non-U.S. FXDWG models.	95777-10DDC \$1,500.00
<b>Dyna Fat Bob</b> Fits '08-'10 FXDF models.	95760-10DDC \$2,199.95
<b>Softail Cross Bones</b> Fits '08-'10 FLSTSB models.	95764-10DDC \$2,299.95
<b>Nightster and Iron 883</b> Fits '10 XL883N and XL1200N models (except Canada and Mexico models).	95767-10DDC \$2,199.95
Fits '10 XL883N and XL1200N models for Canada and Mexico.	95776-10DDC \$1,500.00
<b>Softail Custom and Night Train</b> Fits '08-'09 FXSTB and '08-later FXSTC models. Models for non-U.S. markets require separate purchase of Dampening Kit P/N 60834-07.	95703-10DDC \$2,299.95

Notice: The prices appearing in this catalog are the manufacturer's suggested retail prices. Actual retail prices may vary.



# 726 COLOR SHOP

Core Series Custom Paint

## COLOR SHOP CORE SERIES – DEVOUR

Make your individual statement. Hand-painted designs and rich finishes flow from one end of the bike to the other, and set your ride apart from the rest. Available throughout the year, Core Series Color Sets are covered by a two-year factory warranty when installed within 60 days of purchase of a new Harley-Davidson motorcycle. See Custom Coverage Program for complete warranty details.

Too much is never enough. The aggressive engine-turned grind technique scores the tank and fenders all the way down to bare sheet metal, and stands in contrast against the shimmer of black pearl. Add a Willie G. Skull logo, and cover it all with a wet-look deep crystal clear coat for a refined industrial look that eats at the heart of every bystander.



COLOR SHOP CORE SERIES – DEVOUR  
(SHOWN ON DYNA STREET BOB)



COLOR SHOP CORE SERIES – DEVOUR (SHOWN ON SOFTAIL CROSS BONES)

Available to fit:

	DEVOUR
<b>Softail Custom and Night Train</b> Fits '08-'09 FXSTB and '08-later FXSTC models. Models for non-U.S. markets require separate purchase of Dampening Kit P/N 60834-07.	95703-10DDB \$2,199.95
<b>Fat Boy</b> Fits '08-'10 FLSTF and FLSTFB models.	95710-10DDB \$2,199.95
<b>Dyna Street Bob</b> Fits '09-'10 FXDB models.	95723-10DDB \$2,199.95
<b>Dyna Wide Glide</b> Fits '10 domestic FXDWG models.	95734-10DDB \$2,199.95
Fits '10 non-U.S. FXDWG models.	95777-10DDB \$1,500.00
<b>Dyna Fat Bob</b> Fits '08-'10 FXDF models.	95760-10DDB \$2,199.95
<b>Softail Cross Bones</b> Fits '08-'10 FLSTSB models.	95764-10DDB \$2,199.95
<b>Nightster and Iron 883</b> Fits '10 XL883N and XL1200N models (except Canada and Mexico models).	95767-10DDB \$2,199.95
Fits '10 XL883N and XL1200N models for Canada and Mexico.	95776-10DDB \$2,199.95

**PERSONAL ACCENTS FUEL TANK AND BODYWORK – CUTLOOSE**

Cut your motorcycle loose. The Color Shop Personal Accents bodywork is designed to replace the Original Equipment monochrome and decal parts with custom designed versions. The fuel tank and bodywork are a perfect match for the Original Equipment paint colors. The design features a field of air-brushed “real fire” flames, and the available fuel tank and horn cover add black graffiti-style “Harley-Davidson” script logos. Start with a fairing or fuel tank for a splash of color, or add it all for a complete custom look.



CHOPPED TOUR-PAK®



KING TOUR-PAK®



FLHT SHOWN WITH REAL FIRE FLAME



FLHT SHOWN WITH GREEN FLAME

Available to fit:

	Green Flame over Vivid Black		Real Fire over Vivid Black	
<b>Fuel Tank, Front Fender, 2 Side Covers</b> Fits '09-'10 FLHT and FLHX models.	95758-09CXN	\$2,499.95	95758-09CST	\$2,499.95
<b>Fuel Tank, Front Fender, 2 Side Covers</b> Fits '08 FLHT and FLHX models.	95758-08CXN	\$2,499.95	95758-08CST	\$2,499.95
<b>Fuel Tank</b> Fits '08-'10 FLHR and FLHRC models.	61268-08CXN	\$1,299.95	61268-08CST	\$1,299.95
<b>Fuel Tank</b> Fits '08-'10 FLHT and FLHX models.	61356-08CXN	\$1,249.95	61356-08CST	\$1,249.95
<b>Outer Fairing</b> Fits '08-'10 FLHT and FLHX models.	58236-08CXN	\$724.95	58236-08CST	\$724.95
<b>Color-Matched Saddlebags*</b> Fits '08-'10 FLHR, FLHT and FLHX models.	95713-08CXN	\$1,399.95	95713-08CST	\$1,399.95
<b>King Tour-Pak***</b> Fits '09-later FLHR, FLHT, FLHX and FLTR models.	53963-09CXN	\$1,349.95	53963-09CST	\$1,349.95
<b>Chopped Tour-Pak**</b> Fits '08-later FLHR, FLHT, FLHX and FLTR models.	53111-09CXN	\$1,349.95	53111-09CST	\$1,349.95

\*Saddlebag kit includes cover gasket, wear plates, grommets and replacement non-reuseable hardware only. Installation requires re-use of Original Equipment hinges, latches and mounting hardware, or separate purchase of FL Touring Saddlebag Hardware Kit P/N 90948-00.

\*\*Lock and Keys P/N 53194-07 (keyed to match) sold separately. Installation requires separate purchase of a Detachable or Rigid Tour-Pak mounting rack, detachable docking hardware, passenger backrest pad, and other model-specific hardware. See your Dealer for additional information.

Notice: The prices appearing in this catalog are the manufacturer's suggested retail prices. Actual retail prices may vary.

## 728 COLOR SHOP

Core Series Custom Paint

### EDGE FLAME PAINT SETS

Dress your custom bike ride in classic flames, with an “edgy” twist. The solid base color surrounds your bike for a stealthy look, and the complementing shadow flame outline adds depth and dimension. The Bar & Shield logo adds a proud testament to the spirit and legacy of Harley-Davidson® motorcycles. Each Edge Flame set includes a complete set of painted Original Equipment sheet metal and body panels.

#### EDGE FLAME PAINT SET – BLACK BASE WITH METALLIC RED FLAME



#### EDGE FLAME PAINT SET – GALAXY GREY BASE WITH SILVER FLAME

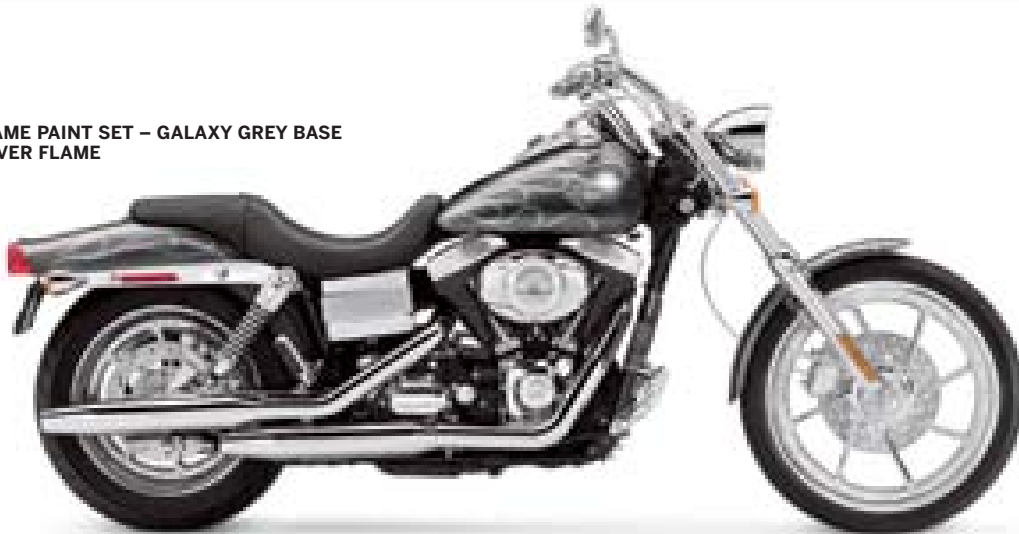

#### EDGE FLAME PAINT SET – BLACK BASE WITH METALLIC ORANGE FLAME



**EDGE FLAME PAINT SET – RED BASE WITH BLACK FLAME**



**EDGE FLAME PAINT SETS**

Available to fit:

	Black Base with Metallic Red Flame		Red Base with Black Flame		Black Base with Metallic Orange Flame		Galaxy Grey Base with Silver Flame	
Fits '07-'09 XL models (except XL1200N). Requires separate purchase of Bobtail Fender Installation Kit P/N 69714-04A. XL883, XL883L, XL883R and '07 XL1200R models require separate purchase of Large Tank Installation Kit P/N 62999-07 and XL Custom-style seat.	95737-08CSZ	\$1,899.95	95737-08CMC	\$1,899.95	95737-08CNW	\$1,899.95	95737-08CNX	\$1,899.95
Fits '06-'09 FXDL and '06-'08 FXDB models.	95731-08CSZ	\$1,899.95	95731-08CMC	\$1,899.95	95731-08CNW	\$1,899.95	95731-08CNX	\$1,899.95
Fits '06-'07 FXDWG models.	—	—	95734-07CMC	\$1,899.95	95734-07CNW	\$1,899.95	95734-07CNX	\$1,899.95
Fits '08-'09 FXSTB and '08-'10 FXSTC models. Models for non-U.S. markets require separate purchase of Dampening Kit P/N 60834-07.	95703-08CSZ	\$1,899.95	95703-08CMC	\$1,899.95	95703-08CNW	\$1,899.95	95703-08CNX	\$1,899.95
Fits '08-'10 FLSTF and FLSTFB models. Models for non-U.S. markets require separate purchase of Dampening Kit P/N 60832-07.	95710-08CSZ	\$1,899.95	95710-08CMC	\$1,899.95	95710-08CNW	\$1,899.95	95710-08CNX	\$1,899.95
Fits '06-'07 FXST, FXSTB and FXSTC models. '07 models for non-U.S. markets require separate purchase of Dampening Kit P/N 60834-07.	—	—	95703-07CMC	\$1,899.95	95703-07CNW	\$1,899.95	<b>OBSOLETE</b> 95703-07CNX — \$1,899.95	
Fits '07 FLSTF models. '07 models for non-U.S. markets require separate purchase of Dampening Kit P/N 60832-07.	—	—	95710-07CMC	\$1,899.95	95710-07CNW	\$1,899.95	<b>OBSOLETE</b> 95710-07CNX — \$1,899.95	
Fits '09-'10 FLHR models. Includes Color-Matched Hard Saddlebags.*	95717-09CSZ	\$3,699.95	95717-09CMC	\$3,699.95	95717-09CNW	\$3,699.95	95717-09CNX	\$3,699.95
Fits '09-'10 FLHRC models.	95716-09CSZ	\$2,199.95	95716-09CMC	\$2,199.95	95716-09CNW	\$2,199.95	95716-09CNX	\$2,199.95
Fits '08 Road King® models. Color-Matched Hard Saddlebags sold separately.	95716-08CSZ	\$2,199.95	95716-08CMC	\$2,199.95	95716-08CNW	\$2,199.95	95716-08CNX	\$2,199.95
Fits '03-'07 Road King models. Color-Matched Hard Saddlebags sold separately.	—	—	95716-07CMC	\$2,199.95	95716-07CNW	\$2,199.95	95716-07CNX	\$2,199.95
Color-Matched Hard Saddlebag Kit for Edge Flame Road King Paint Set.*	95713-08CSZ	\$1,399.95	95713-07CMC	\$1,399.95	95713-07CNW	\$1,399.95	95713-07CNX	\$1,399.95

\*Saddlebag kit includes cover gasket, wear plates, grommets and replacement non-reuseable hardware only. Installation requires re-use of Original Equipment hinges, latches and mounting hardware, or separate purchase of FL Touring Saddlebag Hardware Kit P/N 90948-00.

Notice: The prices appearing in this catalog are the manufacturer's suggested retail prices. Actual retail prices may vary.



# ***SHEET METAL EXCHANGE PROGRAM***

## **THE HARLEY-DAVIDSON® COLOR SHOP SHEET METAL EXCHANGE PROGRAM OFFERS YOU MORE THAN JUST A CUSTOM PAINT JOB.**

It's your opportunity to create timeless art on wheels. The program will allow you to repaint your motorcycle's sheet metal to match classic designs from years past, or to create unique color combinations that match contemporary color palettes. You supply the sheet metal and the color choices, and we return a completed paint set, finished to legendary Harley-Davidson® quality standards.

Color Shop Sheet Metal Exchange is available in two different programs, California Kid Custom Paint and Spectrum Custom Paint.

*The Color Shop Sheet Metal Exchange Program allows you to refresh weather-worn bodywork with a precise match to the original finish. It also permits you to dramatically change the look of a used police or civilian motorcycle to match your color taste. The Sheet Metal Exchange Program is available exclusively from your participating Harley-Davidson dealer.*



**CALIFORNIA KID PAINT SET – BLACK WITH GALAXY GREY TO SILVER FADE WITH ORANGE PINSTRIPES**



**CALIFORNIA KID PAINT SET – BLACK WITH GALAXY GREY TO SILVER FADE WITH BLUE PINSTRIPES**



CALIFORNIA KID PAINT SETS	Available to fit:	Black with Galaxy Grey to Silver Fade with Orange Pinstripes		Black with Galaxy Grey to Silver Fade with Blue Pinstripes	
		Part Number	Price	Part Number	Price
<b>Set of Three</b> Front fender, tank, rear fender.	'04-later XL models, '00-later Softail® models and '95-later Dyna® models.	94496	\$1,649.95	94491	\$1,649.95
<b>Set of Five</b> Front fender, tank, 2 side covers, rear fender.	'95-later Road King® models without saddlebags.	94497	\$1,799.95	94492	\$1,799.95
<b>Set of Seven</b> Front fender, air box, 2 radiator covers, 2 side covers, rear fender.	'02-later VRSCA and VRSCB models.	—	—	—	—
<b>Set of Nine</b> Front fender, tank, 2 side covers, 2 saddlebags, 2 saddlebag lids, rear fender.	'95-later Road King models with hard saddlebags.	94498	\$2,799.95	94493	\$2,799.95
<b>Set of Ten</b> Front fender, outer fairing, tank, 2 side covers, 2 saddlebags, 2 saddlebag lids, rear fender.	'04-later Electra Glide® Standard, Police Electra Glide and Road Glide® models.	94499	\$3,599.95	94494	\$3,599.95
<b>Set of Eleven</b> Front fender, outer fairing, tank, 2 side covers, 2 saddlebags, 2 saddlebag lids, rear fender, rear fender skirt.	'06-later FLHX models.	94500	\$3,649.95	94495	\$3,649.95

COLOR SHOP

Prices are for paint only – sheet metal is supplied or purchased separately by the customer.

Notice: The prices appearing in this catalog are the manufacturer's suggested retail prices. Actual retail prices may vary.

# 732 COLOR SHOP

Sheet Metal Exchange Program

**CALIFORNIA KID PAINT SET – BLACK WITH YELLOW TO ORANGE FADE FLAMES**



**CALIFORNIA KID PAINT SET – BLACK WITH GREEN TO BLUE FADE FLAMES**



**CALIFORNIA KID PAINT SETS**

*Available to fit:*

**Black with Yellow to Orange Fade Flames**

**Black with Green to Blue Fade Flames**

<b>Set of Three</b> Front fender, tank, rear fender.	'04-later XL models, '00-later Softail® models and '95-later Dyna® models.	<b>94282</b>	<b>\$1,649.95</b>	<b>94266</b>	<b>\$1,649.95</b>
<b>Set of Five</b> Front fender, tank, 2 side covers, rear fender.	'95-later Road King® models without saddlebags.	<b>94283</b>	<b>\$1,799.95</b>	<b>94267</b>	<b>\$1,799.95</b>
<b>Set of Seven</b> Front fender, air box, 2 radiator covers, 2 side covers, rear fender.	'02-later VRSCA and VRSCB models.	<b>94284</b>	<b>\$1,949.95</b>	<b>94268</b>	<b>\$1,949.95</b>
<b>Set of Nine</b> Front fender, tank, 2 side covers, 2 saddlebags, 2 saddlebag lids, rear fender.	'95-later Road King models with hard saddlebags.	<b>94285</b>	<b>\$2,799.95</b>	<b>94269</b>	<b>\$2,799.95</b>
<b>Set of Ten</b> Front fender, outer fairing, tank, 2 side covers, 2 saddlebags, 2 saddlebag lids, rear fender.	'04-later Electra Glide® Standard, Police Electra Glide and Road Glide® models.	<b>94336</b>	<b>\$3,599.95</b>	<b>94337</b>	<b>\$3,599.95</b>
<b>Set of Eleven</b> Front fender, outer fairing, tank, 2 side covers, 2 saddlebags, 2 saddlebag lids, rear fender, rear fender skirt.	'06-later FLHX models.	<b>94501</b>	<b>\$3,649.95</b>	<b>94502</b>	<b>\$3,649.95</b>

*Notice: The prices appearing in this catalog are the manufacturer's suggested retail prices. Actual retail prices may vary.*

*Prices are for paint only – sheet metal is supplied or purchased separately by the customer.*

**CALIFORNIA KID PAINT SET – SILVER WITH RED METALLIC FLAME AND BLACK PINSTRIPE**



**CALIFORNIA KID PAINT SET – BLACK WITH RED METALLIC FLAME AND BLUE PINSTRIPE**



**CALIFORNIA KID PAINT SETS**

*Available to fit:*

		Silver with Red Metallic Flame and Black Pinstripe		Black with Red Metallic Flame and Blue Pinstripe	
<b>Set of Three</b> Front fender, tank, rear fender.	'04-later XL models, '00-later Softail® models and '95-later Dyna® models.	94584	\$1,649.95	94583	\$1,649.95
<b>Set of Five</b> Front fender, tank, 2 side covers, rear fender.	'95-later Road King® models without saddlebags.	94586	\$1,799.95	94585	\$1,799.95
<b>Set of Seven</b> Front fender, air box, 2 radiator covers, 2 side covers, rear fender.	'02-later VRSCA and VRSCB models.	—	—	—	—
<b>Set of Nine</b> Front fender, tank, 2 side covers, 2 saddlebags, 2 saddlebag lids, rear fender.	'95-later Road King models with hard saddlebags.	94588	\$2,799.95	94587	\$2,799.95
<b>Set of Ten</b> Front fender, outer fairing, tank, 2 side covers, 2 saddlebags, 2 saddlebag lids, rear fender.	'04-later Electra Glide® Standard, Police Electra Glide and Road Glide® models.	94590	\$3,599.95	94589	\$3,599.95
<b>Set of Eleven</b> Front fender, outer fairing, tank, 2 side covers, 2 saddlebags, 2 saddlebag lids, rear fender, rear fender skirt.	'06-later FLHX models.	94592	\$3,649.95	94591	\$3,649.95

COLOR SHOP

Prices are for paint only – sheet metal is supplied or purchased separately by the customer.

Notice: The prices appearing in this catalog are the manufacturer's suggested retail prices. Actual retail prices may vary.



# ***SPECTRUM CUSTOM COLOR PROGRAM***

## **TAP INTO A QUARTER-CENTURY OF LEGENDARY HARLEY-DAVIDSON® DESIGN AND STYLING EXPERTISE.**

The Spectrum Custom Color Program allows you to draw from virtually every standard color and logo combination offered by the factory since 1979. Select from classic two-tone panel designs, color schemes, and decal or medallion logos to make your dream come alive. You have the freedom to select from an almost unlimited combination of colors to color-match current or historic Harley-Davidson® models, or you can select from an endless number of automotive-style color choices.

You can supply your own Original Equipment undamaged sheet metal, or buy a replacement primed set; either way, you can create your own look and still get the high quality you expect from a factory-painted Harley® motorcycle.

This program is available exclusively through your participating Harley-Davidson® dealer. The dealer can help you create your design, choose your colors, and select a decal or silk-screen graphic to finish the look.



## THE HARLEY-DAVIDSON® SPECTRUM CUSTOM PAINT PROGRAM\*

The Spectrum Custom Paint Program allows you to have your Harley® motorcycle painted to match any color scheme you can imagine. Start with your own sheet metal, or buy a replacement set. You can have individual fenders and tanks painted, or order complete sets, using the part numbers shown below. If the customer's existing sheet metal is being used, it is the customer's responsibility to submit original condition, undamaged parts in a timely manner. See your Dealer for details.

You can choose your main color, panel color, top coat, and pinstripes. You can specify a "clear," "pearl" or "candy" finish top coat. The top coat is a special paint that will work with the main and panel colors to create different effects.

Shown on these two pages are just a few of the unlimited color options available. Mix & match colors from vintage bikes, classic cars, or any other monochrome or two-tone paint scheme you can think of.

### Spectrum Custom Paint Rework\*

<b>98645</b>	Repair Charge. (per piece)	<b>\$69.95</b>
<b>98646</b>	Strip/Prime Charge. (per piece)	<b>\$99.95</b>
<b>94479</b>	Wide Tire Fender for use with P/N 43820-05. (per piece)	<b>\$1,599.95</b>

SPECTRUM CUSTOM PAINT SETS*	Available to fit:	Solid Color with Decals		Solid Color with Decals and Pinstripes		Solid Candy Color with Decals		Solid Candy Color with Decals and Pinstripes		Two Tone Colors (Standard or Candy Color) with Decals and Pinstripes	
		Part #	Price	Part #	Price	Part #	Price	Part #	Price	Part #	Price
<b>Set of Three</b> Painting of front fender, tank and rear fender.	Sportster®, Dyna® and '00-later Softail® models.	<b>98300A</b>	<b>\$749.95</b>	<b>98300B</b>	<b>\$849.95</b>	<b>98300C</b>	<b>\$949.95</b>	<b>98300D</b>	<b>\$1,049.95</b>	<b>98300E</b>	<b>\$1,449.95</b>
<b>Set of Four</b> Painting of front fender, left and right tank and rear fender.	'84-'99 Softail models.	<b>98400A</b>	<b>\$899.95</b>	<b>98400B</b>	<b>\$1,149.95</b>	<b>98400C</b>	<b>\$1,199.95</b>	<b>98400D</b>	<b>\$1,399.95</b>	<b>98400E</b>	<b>\$1,999.95</b>
<b>Set of Five</b> Painting of front fender, tank, 2 side covers and rear fender.	'94-later FLHRC/1 and FLHRS models.	<b>94026A</b>	<b>\$1,099.95</b>	<b>94026B</b>	<b>\$1,149.95</b>	<b>94026C</b>	<b>\$1,299.95</b>	<b>94026D</b>	<b>\$1,349.95</b>	<b>94026E</b>	<b>\$1,499.95</b>
<b>Set of Nine</b> Painting of front fender, tank, 2 side covers, 2 saddlebags, 2 saddlebag lids and rear fender.	'94-later FLHR/1 models.	<b>94027A</b>	<b>\$1,949.95</b>	<b>94027B</b>	<b>\$2,099.95</b>	<b>94027C</b>	<b>\$2,249.95</b>	<b>94027D</b>	<b>\$2,399.95</b>	<b>94027E</b>	<b>\$2,949.95</b>

\*Prices are for paint only – sheet metal is supplied or purchased separately by the customer.



SPORTSTER® 1200 LOW SHOWN IN TWO-TONE PINK AND VIVID BLACK WITH DECAL AND PINSTRIPE

COLOR SHOP

Notice: The prices appearing in this catalog are the manufacturer's suggested retail prices. Actual retail prices may vary.

# 736 COLOR SHOP

Spectrum Custom Color Program

FAT BOY® SHOWN IN SOLID VIVID BLACK WITH MEDALLIONS\*



CROSS BONES™ SHOWN IN SOLID OLIVE WITH MEDALLIONS\*



Main Color:	Metallic Gold
Panel Color:	Black
Top Coat:	Clear
Pinstripes:	Bright Gold

Main Color:	Brilliant Red
Panel Color:	Black
Top Coat:	Clear
Pinstripes:	Bright Gold/Bright Orange

Main Color:	Bright Orange
Panel Color:	Black
Top Coat:	Clear
Pinstripes:	Brilliant Gold

Main Color:	Dark Turquoise
Panel Color:	Black Ice
Top Coat:	Clear
Pinstripes:	Medium Silver/Silver

Notice: The prices appearing in this catalog are the manufacturer's suggested retail prices. Actual retail prices may vary.

ROAD KING® SHOWN IN VIVID BLACK WITH MEDALLIONS\*



HERITAGE SOFTAIL® CLASSIC SHOWN IN INCA GOLD WITH MEDALLIONS\*



Main Color:	Birch White
Panel Color:	Sapphire Metallic
Top Coat:	Violet Pearl
Pinstripes:	Brilliant Blue/Bright Gold

Main Color:	Silver Metallic
Panel Color:	Purple Metallic
Top Coat:	Candy Tangerine
Pinstripes:	Bright Gold/Tomato Red

Main Color:	Silver Metallic
Panel Color:	Purple Metallic
Top Coat:	Candy Red
Pinstripes:	Bright Gold/Tomato Red

Main Color:	Silver Metallic
Panel Color:	Purple Metallic
Top Coat:	Candy Green
Pinstripes:	Gambia/Bright Gold

COLOR SHOP

\*Medallions are not included. See page 746 or your Dealer for medallion and decal selection.

Notice: The prices appearing in this catalog are the manufacturer's suggested retail prices. Actual retail prices may vary.



# 738 COLOR SHOP

## Spoilers

### A. SPORTSTER® FRONT SPOILER\*

The wedge shape of the spoiler accents the lean and narrow look of the Sportster model. Injection molded from high-impact material and available primed, or color-matched to original factory applied finishes. Kit includes all mounting hardware.

Fits '04-later XL models. Will not fit with Engine Guards.

<b>58882-04BDK</b>	Primed.	<b>\$119.95</b>
<b>58882-04DH</b>	Vivid Black.	<b>\$199.95</b>

### B. DYNA® FRONT SPOILER\*

With a scooped shape designed to accent the long, lean Dyna models, this sporty custom addition is injection molded from high-impact materials. Available primed or color-matched to original factory applied finishes. Includes all mounting hardware.

#### Without Polished Insert

Fits '91-'03 Dyna models. Works with Engine Guard P/N 49007-90A on FXD, FXDL and FXDB models. Will fit with Chrome Voltage Regulator Cover P/N 74577-97. Will not fit on FXDWG, FXDX, FXDXT and FXDS models with Engine Guard P/N 49010-93. Will not fit '96-'03 California models equipped with an evaporative canister. Does not fit with Dyna Leather Tool Roll P/N 91714-97A.

<b>58593-97</b>	Primed.	<b>\$114.95</b>
-----------------	---------	-----------------

#### With Polished Insert

Fits '06-later Dyna models. Will fit with Chrome Voltage Regulator Cover P/N 74667-06. Does not fit with engine guards. Does not fit California models equipped with evaporative emissions canister. Does not fit with Dyna Tool Roll P/N 91714-97A. Will not fit with Oil Cooler Kits.

<b>58042-08BDK</b>	Primed.	<b>\$124.95</b>
<b>58042-08DH</b>	Vivid Black.	<b>\$199.95</b>

Fits '95-'05 Dyna models. Will fit with Chrome Voltage Regulator Cover P/N 74577-97 or 74593-04. Fits with Engine Guard P/N 49007-90A on FXD, FXDL and FXDB models. Will not fit FXDWG, FXDX, FXDXT and FXDS models equipped with Engine Guard P/N 49010-93. Will not fit California models equipped with an evaporative emission canister. Does not fit with Dyna Tool Roll P/N 91714-97A.

<b>58042-04BDK</b>	Primed.	<b>\$124.95</b>
<b>58042-04DH</b>	Vivid Black.	<b>\$199.95</b>

### C. SOFTAIL® FRONT SPOILER\*

This color-matched front spoiler is made from injection-molded, high-impact composite materials and styled with a racy, custom appearance. Also available primed, ready for your custom paint design. Includes the necessary hardware for quick and easy installation.

Fits '07-later FX Softail, FLSTSB and FLSTF models with oval voltage regulator. Will not fit with Premium Oil Cooler Kit P/N 26157-07 and 26136-05, or Chrome Voltage Regulator Cover. Will not fit with engine guards.

<b>57040-08</b>	Primed.	<b>\$179.95</b>
<b>57040-08DH</b>	Vivid Black.	<b>\$279.95</b>

Fits '01-'06 FX Softail and FLSTF models with oval voltage regulator. Will not fit with Premium Oil Cooler Kit P/N 26157-07, 26136-05 or Chrome Voltage Regulator Cover. Will not fit with engine guards.

<b>57040-01</b>	Primed.	<b>\$124.95</b>
<b>57040-01DH</b>	Vivid Black.	<b>\$279.95</b>

### D. BULLET FRONT SPOILER\*

Add a long, lean, and stretched look without modifying the frame. The deep chin spoiler flows into side rails that cover the frame tubes all the way back to the swingarm. Easy-to-install, this kit contains all necessary mounting hardware.

Fits '07-later FX Softail models. Will not fit with Premium Oil Cooler Kit P/N 26157-07 or 26136-05. Will not fit with engine guards.

<b>57039-08BDK</b>	Primed.	<b>\$274.95</b>
<b>57039-08DH</b>	Vivid Black.	<b>\$379.95</b>

Fits '01-'06 FX Softail models. Will not fit with Premium Oil Cooler Kit P/N 26157-07 or 26136-05. Will not fit with engine guards.

<b>57039-03BDK</b>	Primed.	<b>\$274.95</b>
<b>57039-03DH</b>	Vivid Black.	<b>\$379.95</b>



**A. SPORTSTER FRONT SPOILER – VIVID BLACK**



**B. DYNA FRONT SPOILER WITHOUT POLISHED INSERT – PRIMED (CUSTOM PAINTED)**



**B. DYNA FRONT SPOILER WITH POLISHED INSERT – VIVID BLACK**



**C. SOFTAIL FRONT SPOILER – PRIMED (CUSTOM PAINTED)**

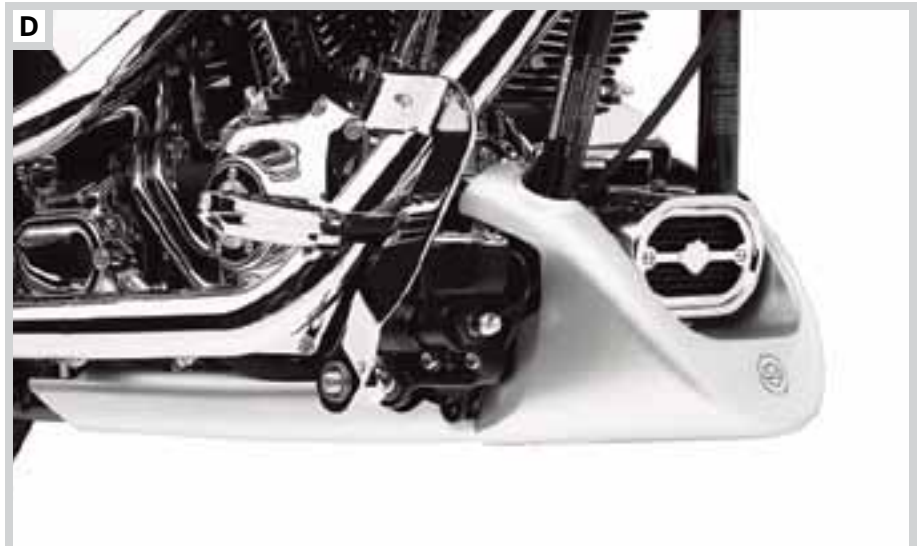

**D. BULLET FRONT SPOILER – PRIMED (CUSTOM PAINTED)**

\*NOTE: This product is a "Paint to Order" accessory. Please allow for an average of 5 weeks delivery for this item.



E

**E. HEADLAMP VISOR KIT (SPORTSTER AND DYNA) – VIVID BLACK**



E

**E. HEADLAMP VISOR KIT (FXST AND FXDWG) – VIVID BLACK**

**E. HEADLAMP VISOR KITS\***

Add an element of racy style to stock headlamps with these visors. Available in prime or Vivid Black Harley-Davidson® paint.

Fits '95-later XL models (except XL Custom), '95-'05 Dyna® models (except FXDXT, FXDWG), '82-'94 FXR and FXRS models.

<b>68129-97</b>	Primed.	<b>\$114.95</b>
<b>68129-98DH</b>	Vivid Black.	<b>\$214.95</b>

Fits '84-'99 FXST, FXSTC and '91-'05 FXDWG models.

<b>68971-98B</b>	Primed.	<b>\$114.95</b>
------------------	---------	-----------------

**F. DETACHABLE QUARTER FAIRING KIT\***

Sleek, racy styling and sweeping lines define this innovative fairing. The quarter fairing-sized detachable design gives your bike a whole new sporty look that can be changed in an instant. Available in primed or Vivid Black finishes, the fairing is interchangeable with Detachable Windshields, giving you plenty of options for cruising or touring. Plus, the windshield has a two-position adjustment feature for flexibility.

Fits '88-later XL, FXR and '95-'05 Dyna models (except XL Custom, FXLR, FXDWG and FXDXT). Requires the installation of Detachable Docking Hardware Kit P/N 58164-96A.

<b>57070-98</b>	Primed.	<b>\$264.95</b>
<b>57070-97DH</b>	Vivid Black.	<b>\$394.95</b>

**G. COLOR-MATCHED SPORTSTER® SIDE COVER KIT\***

This accessory kit is an easy way to give your Sportster model a unique monochrome look. Painted to match current factory colors, the kit includes the left side battery cover, right side oil tank cover, and oil filler bezel. Easy-to-install for a quick splash of color.

Fits '04-later XL models.

<b>66263-09CWR</b>	Big Purple Flake.	<b>\$169.95</b>
<b>66263-05BPS</b>	Black Cherry Pearl.	<b>\$169.95</b>
<b>66263-10BYM</b>	Black Denim.	<b>\$169.95</b>
<b>66263-09CWL</b>	Black Ice.	<b>\$169.95</b>
<b>66263-10DBP</b>	Black Ice Denim.	<b>\$169.95</b>
<b>66263-05BPY</b>	Black Pearl.	<b>\$169.95</b>
<b>66263-04BHT</b>	Brilliant Silver.	<b>\$169.95</b>
<b>66263-08CPF</b>	Candy Red Sunglo.	<b>\$169.95</b>
<b>66263-05BPO</b>	Chopper Blue.	<b>\$169.95</b>
<b>66263-08CPL</b>	Copperhead Pearl.	<b>\$169.95</b>
<b>66263-08CPH</b>	Copper Pearl.	<b>\$169.95</b>
<b>66263-08COZ</b>	Crimson Red Sunglo.	<b>\$169.95</b>
<b>66263-08CPC</b>	Dark Blue Pearl.	<b>\$169.95</b>
<b>66263-06BXT</b>	Deep Cobalt.	<b>\$169.95</b>
<b>66263-06BXY</b>	Fire Red Pearl.	<b>\$169.95</b>
<b>66263-09CWA</b>	Flame Blue Pearl.	<b>\$169.95</b>
<b>66263-04BHX</b>	Glacier White Pearl.	<b>\$169.95</b>
<b>66263-08CPJ</b>	Golden Glow.	<b>\$169.95</b>
<b>66263-04BBP</b>	Impact Blue.	<b>\$169.95</b>
<b>66263-07CHY</b>	Jake Blue.	<b>\$169.95</b>
<b>66263-04BJK</b>	Lava Red Sunglo.	<b>\$169.95</b>
<b>66263-09CWT</b>	Light Candy Root Beer.	<b>\$169.95</b>
<b>66263-04XE</b>	Luxury Blue.	<b>\$169.95</b>
<b>66263-06BNR</b>	Mirage Orange Pearl.	<b>\$169.95</b>
<b>66263-08COS</b>	Olive Pearl Denim.	<b>\$169.95</b>
<b>66263-07CGP</b>	Pacific Blue Pearl.	<b>\$169.95</b>
<b>66263-07CGR</b>	Pewter Pearl.	<b>\$169.95</b>
<b>66263-08CPK</b>	Purple Haze.	<b>\$169.95</b>
<b>66263-04NZ</b>	Racing Orange.	<b>\$169.95</b>
<b>66263-09CYS</b>	Red Hot Sunglo.	<b>\$169.95</b>
<b>66263-05BPV</b>	Rich Sunglo Blue.	<b>\$169.95</b>
<b>66263-10DBJ</b>	Scarlet Red.	<b>\$169.95</b>
<b>66263-04BHS</b>	Sierra Red.	<b>\$169.95</b>
<b>66263-04BJL</b>	Smokey Gold.	<b>\$169.95</b>
<b>66263-07CGT</b>	Suede Blue Pearl.	<b>\$169.95</b>
<b>66263-08CPE</b>	Sunset Yellow Pearl.	<b>\$169.95</b>
<b>66263-07CGS</b>	White Gold Pearl.	<b>\$169.95</b>
<b>66263-05BPZ</b>	Yellow Pearl.	<b>\$169.95</b>



F

**F. DETACHABLE QUARTER FAIRING KIT – VIVID BLACK**



G

**G. COLOR-MATCHED SPORTSTER SIDE COVER KIT – OIL TANK COVER, SMOKEY GOLD**



G

**G. COLOR-MATCHED SPORTSTER SIDE COVER KIT – BATTERY COVER, SMOKEY GOLD**

\*NOTE: This product is a "Paint to Order" accessory. Please allow for an average of 5 weeks delivery for this item.

Notice: The prices appearing in this catalog are the manufacturer's suggested retail prices. Actual retail prices may vary.

# 740 COLOR SHOP

Air Cleaners

## A. AIR CLEANER COVERS FOR TWIN CAM MODELS\*

Fits '99-'06 Twin Cam models. Customer must inspect Original Equipment cover to determine if notch is present.

<b>29585-06BDK</b>	Primed (without notch).	<b>\$59.95</b>
<b>29585-03DH</b>	Vivid Black (without notch).	<b>\$79.95</b>

Fits '07 Dyna® and '07-'10 Softail® (except FLSTSB) and Touring models.

<b>29585-10BDK</b>	Primed.	<b>\$59.95</b>
<b>29585-07DH</b>	Vivid Black.	<b>\$79.95</b>

Fits '08-later Dyna models.

<b>29193-10BDK</b>	Primed.	<b>\$59.95</b>
<b>29193-08DH</b>	Vivid Black.	<b>\$79.95</b>

## B. AIR CLEANER COVERS FOR SPORTSTER® MODELS\*

Fits '04-later XL models.

<b>29084-10BDK</b>	Primed.	<b>\$59.95</b>
<b>29084-04DH</b>	Vivid Black.	<b>\$79.95</b>

## C. WRINKLE BLACK HORN COVER

This powder coated horn cover is the perfect start in converting your powertrain to a striking blacked-out look. Manufactured from Original Equipment components, this cover is painted on the factory production line to ensure a matching wrinkle black finish.

<b>69039-09</b>		<b>\$29.95</b>
Fits '93-later models with side-mounted horn (except VRSC models).		



**A. AIR CLEANER COVER FOR TWIN CAM MODELS ('99-'06 MODEL SHOWN) – VIVID BLACK**



**A. AIR CLEANER COVER FOR TWIN CAM MODELS ('07-LATER SOFTAIL MODEL SHOWN) – PRIMED (CUSTOM PAINTED)**



**A. AIR CLEANER COVER FOR TWIN CAM MODELS ('08-LATER DYNA SHOWN) – PRIMED (CUSTOM PAINTED)**



**B. AIR CLEANER COVER FOR SPORTSTER MODELS – VIVID BLACK**



**C. WRINKLE BLACK HORN COVER**

\*NOTE: This product is a "Paint to Order" accessory. Please allow for an average of 5 weeks delivery for this item.

Notice: The prices appearing in this catalog are the manufacturer's suggested retail prices. Actual retail prices may vary.





D

**D. SPORT FRONT FENDER – PRIMED (CUSTOM PAINTED)**

**D. SPORT FRONT FENDER\***

The custom double arch Sport Front Fenders are contoured to match the stock rear fender. Available in Vivid Black or primed finish, each fender includes internal mounting plates and hardware for installation.

Fits '88-later XL and '91-'05 Dyna® models equipped with 39mm front forks. Will not fit FXDWG models.

<b>59496-97</b>	Primed.	<b>\$124.95</b>
<b>59496-97DH</b>	Vivid Black.	<b>\$229.95</b>

**E. FL SOFTAIL® CLEAN FRONT FENDER**

An empty canvas for customizers, this fender has no holes, mounts with existing hardware/brackets and is offered in primed finish.

<b>59054-96</b>		<b>\$181.44</b>
Fits '86-later FLSTC, FLSTN and FLSTF models.		

**F. FL TOURING CLEAN FRONT FENDER**

With no holes, this fender provides the starting point for customization. Offered in primed finish and ready to bolt onto existing brackets.

<b>59045-00B</b>		<b>\$298.87</b>
Fits '94-later FLHR models and '89-later FLT, FLHT models.		

**G. STREET STALKER® FRONT FENDER KIT**

The smooth curves of the Street Stalker Front Fender easily create a clean, custom front-end look. Made from high-impact, injection-molded composite materials. Includes mounting hardware.

Fits '86-later FLSTC and FLSTF models.

<b>59397-98</b>	Primed.	<b>\$134.95</b>
<b>59397-03DH</b>	Vivid Black.	<b>\$199.95</b>



E

**E. FL SOFTAIL CLEAN FRONT FENDER**



F

**F. FL TOURING CLEAN FRONT FENDER**



G

**G. STREET STALKER FRONT FENDER KIT – VIVID BLACK**

*\*NOTE: This product is a "Paint to Order" accessory. Please allow for an average of 5 weeks delivery for this item.*

*Notice: The prices appearing in this catalog are the manufacturer's suggested retail prices. Actual retail prices may vary.*



# 742 COLOR SHOP

## Rear Fenders

### A. CHOPPED REAR FENDER FOR SPORTSTER MODELS\*

Complete "bolt-on" fender kit includes everything you need to convert your '04-later Sportster model to the chopped rear fender look. Available in Vivid Black or Primed finish, this kit can be installed with simple tools and requires no frame modifications or fabrication. The chopped fender eliminates the traditional tail lamp, and replaces the Original Equipment rear turn signals with "stop-turn-tail" lights for a clean, stripped-down appearance. All you need to add is a Side Mount or under-fender mount license plate bracket (*sold separately*).

Fits '07-'09 XL Models (Stock on XL1200N and XL883N). Requires separate purchase of Side Mount License Plate Assembly P/N 60318-07. NOTE: Laws regarding the location of the license plate vary from place to place. Please check with local authorities and obey all applicable laws and regulations.

**60236-09BEO** Primed. **\$419.95**

**60236-09DH** Vivid Black. **\$499.95**

Fits '04-'06 and '10 XL Models (Stock on XL1200N and XL883N). Requires separate purchase of Side Mount License Plate Assembly P/N 60318-07. NOTE: Laws regarding the location of the license plate vary from place to place. Please check with local authorities and obey all applicable laws and regulations.

**60236-10BEO** Primed. **\$419.95**

**60236-10DH** Vivid Black. **\$499.95**

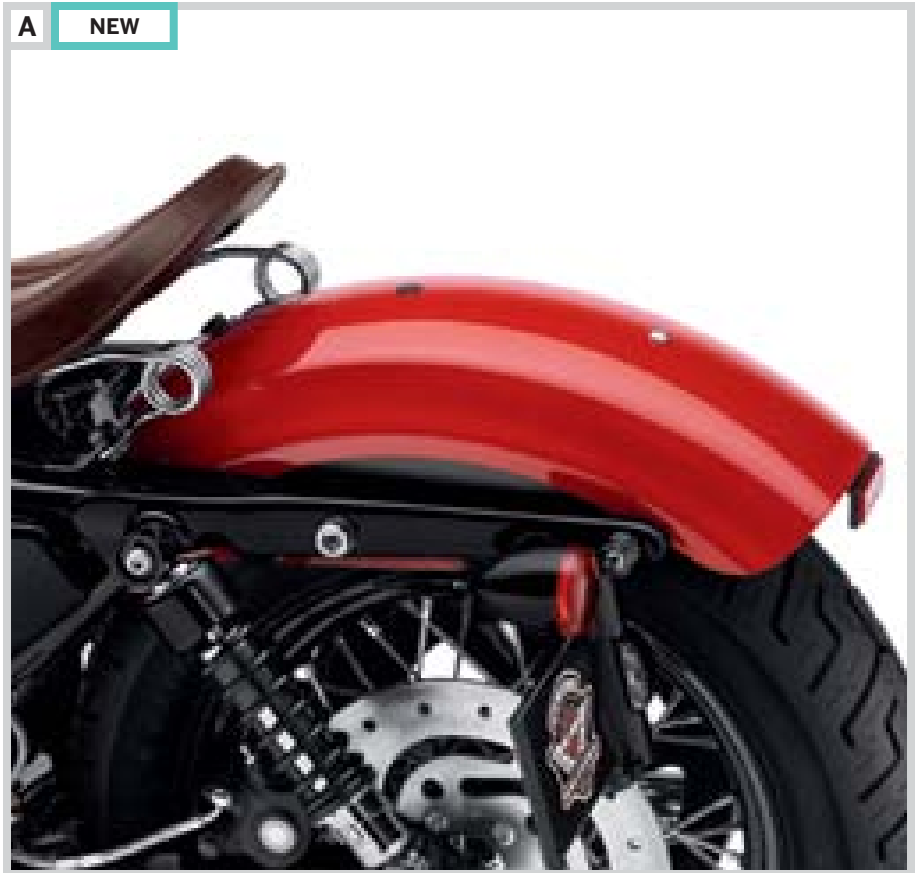

A. CHOPPED REAR FENDER FOR SPORTSTER MODELS – PRIMED (CUSTOM PAINTED)

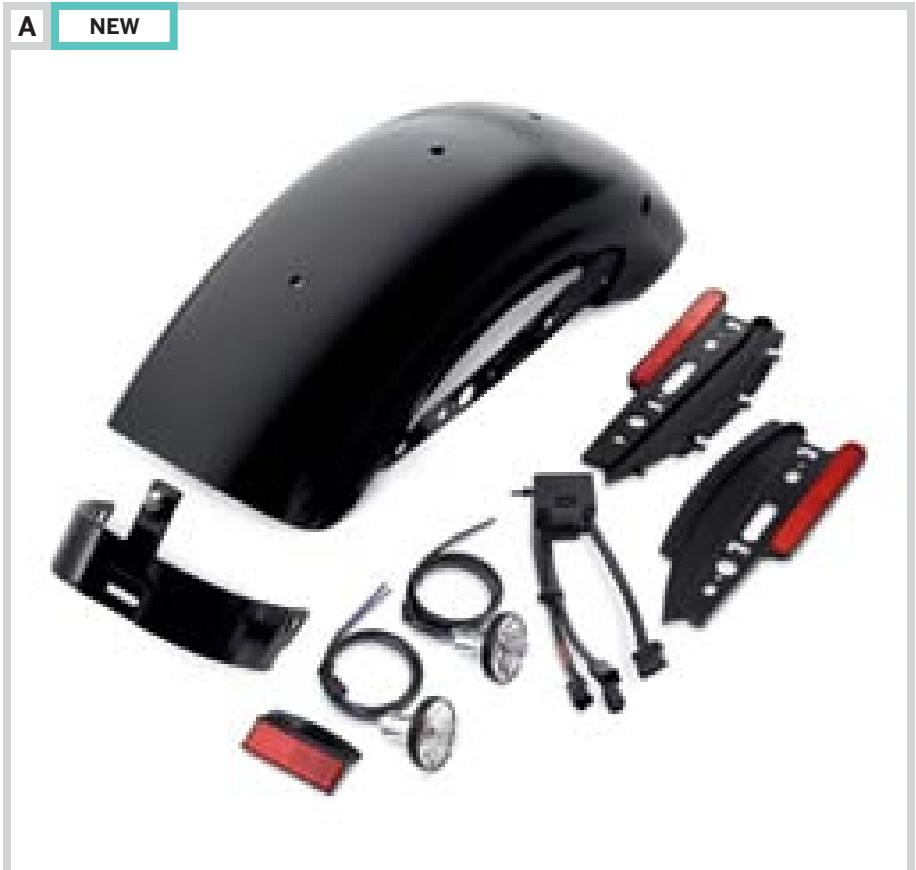

A. CHOPPED REAR FENDER FOR SPORTSTER MODELS – PRIMED

\*NOTE: This product is a "Paint to Order" accessory. Please allow for an average of 5 weeks delivery for this item.

Notice: The prices appearing in this catalog are the manufacturer's suggested retail prices. Actual retail prices may vary.



**B. BOBTAIL FENDER KIT FOR SPORTSTER MODELS – VIVID BLACK**

**B. BOBTAIL FENDER KIT FOR SPORTSTER® MODELS\***

Get all the custom attitude without the big bike expense. The radically styled Bobtail fender adds a pure custom back-end to the muscled XL family.

Fits '07-'09 XL models (except XL883N and XL1200N). Requires separate purchase of Sportster Bobtail Fender Installation Kit P/N 69714-04B. Will not fit with leather saddlebags.

<b>59985-07</b>	Primed.	<b>\$179.95</b>
<b>60052-07DH</b>	Vivid Black.	<b>\$349.95</b>

Fits '04-'06 and '10-later XL models. Requires separate purchase of Sportster Bobtail Fender Installation Kit P/N 69714-04B. Will not fit with leather saddlebags.

<b>59985-04</b>	Primed.	<b>\$179.95</b>
<del><b>60052-04DH</b></del>	<del>Vivid Black.</del>	<del><b>\$349.95</b></del>

**SPORTSTER BOBTAIL FENDER INSTALLATION KIT (not shown)**

Required for installation of Bobtail Fender Kit on XL models.

<b>69714-04B</b>		<b>\$99.95</b>
Fits '04-later XL models (except XL883N and XL1200N).		
<b>69704-00</b>	Domestic.	<b>\$49.95</b>
Fits '99-'03 XL models.		
<b>60081-00</b>	International.	<b>\$49.95</b>
Fits '99-'03 XL models.		



**C. BOBTAIL FENDER KIT FOR SPORTSTER MODELS – PRIMED (CUSTOM PAINTED)**

**C. BOBTAIL FENDER KIT FOR SPORTSTER® MODELS\***

Get all the custom attitude without the big bike expense. The radically styled Bobtail fender adds a pure custom back-end to the muscled XL family.

Fits '99-'03 XL models. Requires separate purchase of Installation Kit P/Ns 69704-00 or 60081-00.

<b>60025-01</b>	Primed.	<b>\$179.95</b>
<b>60025-01DH</b>	Vivid Black.	<b>\$259.95</b>

**D. BOBTAIL REAR FENDER KIT FOR DYNA MODELS\***

Change the look and the attitude of your Dyna motorcycle with a Bobtail Rear Fender. Standard on the Dyna® Wide Glide® model. This sleek upturned fender adds style to the rear of your bike.

Available to fit:

Fits '06-later FXD, FXDC, FXDL, '06-'08 FXDB models. Stock on '06-'08 FXDWG models. Requires separate purchase of Installation Kit P/N 69710-06.

<b>59925-06</b>	Primed.	<b>\$180.00</b>
<b>59925-06DH</b>	Vivid Black.	<b>\$349.95</b>

**DYNA BOBTAIL REAR FENDER INSTALLATION KIT (not shown)**

Required for installation of Bobtail Fender Kit on Dyna models.

<b>69710-06</b>		<b>\$249.95</b>
Fits '06-later FXD, FXDC, FXDL, and '06-'08 FXDB models. Stock on '06-'08 FXDWG models.		



**D. BOBTAIL REAR FENDER KIT FOR DYNA MODELS – PRIMED (CUSTOM PAINTED)**

\*NOTE: This product is a "Paint to Order" accessory. Please allow for an average of 5 weeks delivery for this item.

Notice: The prices appearing in this catalog are the manufacturer's suggested retail prices. Actual retail prices may vary.

# 744 COLOR SHOP

## Sportster Fuel Tanks

### A. COLOR-MATCHED LARGE CAPACITY FUEL TANK FOR SPORTSTER® MODELS\*

Featuring the radical styling of the Sportster® Custom motorcycle, this large fuel tank holds up to 4.5 gallons of fuel. Great for cross-country cruising, the tank is formed and painted as only Harley-Davidson can. The larger tank gives the XL883 Standard, XL883L and XL1200R models a bigger, beefier profile.

Fits '07-later XL models. Installation Kit P/N 62999-07 is required for installation on models not originally equipped with Large Capacity Tank. XL883, XL883L, XL883N, XL883R, XL1200N and '07 XL1200R models require separate purchase of XL883C/XL1200C style seat.

Fits '04-'06 XL models. Installation Kit P/N 62999-04 is required for installation on models not originally equipped with Large Capacity Tank. Will not fit with stock seat. Requires separate purchase of XL883C/XL1200C style seat.

**Sportster Large Tank Installation Kit** (not shown)  
Required for installation of Large Capacity Fuel Tank on XL models.

**62999-07** **\$129.95**  
Fits '07-later XL883, XL883L, XL883N, XL883R, XL1200N and '07 XL1200R models. Kit includes Fuel Line Assembly, Fuel Pump Seal and Docking Hardware.

**62999-04** **\$24.95**  
Fits '04-'06 XL883 STD, XL883L and XL1200R models.



**A. COLOR-MATCHED LARGE CAPACITY FUEL TANK FOR SPORTSTER MODELS – TWO TONE WITH MEDALLION**

### COLOR-MATCHED FUEL TANKS\*

Solid Color/Panel	Large Fuel Tank with Medallion <i>Fits '04-'06 XL models</i>		Large Fuel Tank with Medallion <i>Fits '07-later XL models</i>	
	Part #	Price	Part #	Price
Black Cherry Pearl	62732-05BPS	\$649.95	62732-07BPS	\$649.95
Black Denim	—	—	62732-10BYM	\$649.95
Black Pearl	62732-05BPY	\$649.95	62732-07BPY	\$649.95
Brilliant Silver	62732-04BHT	\$649.95	—	—
Brilliant Silver Denim	—	—	62732-10COV	\$649.95
Brilliant Silver Pearl	—	—	62732-10BHT	\$649.95
Candy Red Sunglo	—	—	62732-08CPF	\$649.95
Chopper Blue	62732-05BPO	\$649.95	—	—
Crimson Red Sunglo	—	—	62732-08COZ	\$649.95
Deep Cobalt	62732-06BXT	\$649.95	62732-07BXT	\$649.95
Glacier White Pearl	62732-06BHX	\$649.95	—	—
Fire Red Pearl	62732-06BXY	\$649.95	62732-07BXY	\$649.95
Flame Blue Pearl	—	—	62732-09CWA	\$649.95
Impact Blue	62732-04BBP	\$649.95	—	—
Mirage Orange Pearl	62732-06BNR	\$649.95	<del>62732-07BNR</del>	<del>\$649.95</del>
Pacific Blue Pearl	—	—	62732-07CGP	\$649.95
Pewter Pearl	—	—	62732-07CGR	\$649.95
Racing Orange	62732-04NZ	\$649.95	—	—
Red Hot Sunglo	—	—	62732-09CYS	\$649.95
Scarlet Red	—	—	62732-10DBJ	\$649.95
Sierra Red	62732-04BHS	\$649.95	—	—
Smokey Gold	62732-04BJL	\$649.95	—	—
Sunset Yellow Pearl	—	—	62732-08CPE	\$649.95
Vivid Black	62732-04DH	\$649.95	62732-07DH	\$649.95
White Gold Pearl	—	—	62732-07CGS	\$649.95

Two-Tone Color with Striping Base Color	Inner/Outer Pinstripe	Large Fuel Tank with Decal <i>Fits '04-'06 XL models</i>		Large Fuel Tank with Medallion <i>Fits '04-'06 XL models</i>		Large Fuel Tank with Medallion <i>Fits '07-later XL models</i>	
		Part #	Price	Part #	Price	Part #	Price
Black Ice Denim	Proper Purple Pinstripe	—	—	—	—	62732-10DBR	\$649.95
Deep Cobalt	Light Cobalt	—	—	62732-06BYC	\$649.95	—	—
Fire Red Pearl	Medium Silver	—	—	62732-06BXZ	\$649.95	—	—
Vivid Black	Silver Pinstripe	—	—	—	—	62732-10BJM	\$649.95
Anniversary Copper Pearl/Vivid Black	Pale Gold/Orange	—	—	—	—	62732-08COR	\$649.95
Brilliant Silver Denim/Black Denim	Black/H-D Orange Pinstripe	—	—	—	—	62732-10COW	\$649.95
Chopper Blue/Brilliant Silver	Blue/Burgundy	61195-05BPX	\$649.95	62732-05BPX	\$649.95	—	—
Crimson Red Sunglo/Candy Red Sunglo	Red/Pale Gold	—	—	—	—	62732-08CPR	\$649.95
Fire Red Pearl/Vivid Black	Tomato Red	61195-06BYA	\$649.95	62732-06BYA	\$649.95	—	—
Impact Blue/Vivid Black	Burgundy/Medium Silver	61195-04BJD	\$649.95	62732-04BJD	\$649.95	—	—
Luxury Blue/Impact Blue	Burgundy/Blue	61195-04BJC	\$649.95	—	—	—	—
Olive Pearl/Vivid Black	Bright Gold/Burgundy	—	—	—	—	62732-08CGZ	\$649.95
Pacific Blue Pearl/Vivid Black	Blue/Medium Silver	—	—	—	—	62732-08CPW	\$649.95
Rich Sunglo Blue/Chopper Blue	Blue/Medium Silver	61195-05BPW	\$649.95	—	—	—	—
Sierra Red/Brilliant Silver	Tomato Red/Pale Gold	61195-04BJE	\$649.95	62732-04BJE	\$649.95	—	—

\*NOTE: This product is a "Paint to Order" accessory. Please allow for an average of 5 weeks delivery for this item.

B

**B. PAINTS**

Touch-up paint is available in handy 1/2-ounce applicator bottles for all late model Harley-Davidson® motorcycles. Aerosol and quart containers are also available. See your Authorized Harley-Davidson® Dealer for a complete listing of paint.

NOTE: Due to the broad selection of custom paint colors, touch-up paints are not available for custom colors.

NOTE: Quart containers of Harley-Davidson® Acrylic Urethane paint and urethane activator material are designed for application only by professional, trained personnel using proper equipment under controlled conditions, and they are not intended for sale to the general public.

NOTE: Quart containers of Harley-Davidson Acrylic Urethane paint and lacquers are not available in California.

**Black Texture**

'95-later Engine and Transmission.

<b>98605BF*</b>	Touch-Up Pen.	<b>\$11.00</b>
<b>98600BF*</b>	Touch-Up Bottle.	<b>\$11.95</b>
<b>98606BF</b>	Aerosol.	<b>\$19.60</b>

**Silver Bead Blast**

'98-later Engine and Transmission.

<b>98600BY*</b>	Touch-Up Bottle.	<b>\$11.95</b>
<b>98606BY</b>	Aerosol.	<b>\$19.60</b>

**Black Wrinkle**

'94-earlier Engine and Transmission.

<b>98603CJ</b>	Quart.	<b>\$44.30</b>
----------------	--------	----------------

**Clear Coat**

Used to fill in clear coating over chips and surface scratches.

<b>98600EK*</b>	Touch-Up Bottle.	<b>\$11.95</b>
<b>98606EK</b>	Aerosol.	<b>\$19.60</b>
<b>98609EK</b>	Quart. Two-Part Urethane.	<b>\$80.30</b>

**Silver**

<b>98600BXR*</b>		<b>\$11.95</b>
------------------	--	----------------

V-Rod® Engine Head Silver. Touch-up.

<b>98606BXR</b>		<b>\$19.60</b>
-----------------	--	----------------

V-Rod Engine Head Silver. Aerosol.

<b>98600BXS*</b>		<b>\$11.95</b>
------------------	--	----------------

V-Rod Crankcase Silver. Touch-up.

<b>98606BXS</b>		<b>\$19.60</b>
-----------------	--	----------------

V-Rod Crankcase Silver. Aerosol.

**Black Leather Touch-Up Pens**

A convenient way to fix scratches, scuffed and worn pouches, saddlebags, seats and other leather products. Just touch-up the damaged area, wipe off excess, let dry and then buff with a soft cloth to blend color.

<b>98605AX*</b>		<b>\$11.00</b>
-----------------	--	----------------

**Black Frame Paint Touch-up Pen**

Dispensed from an easy-to-use paint pen, this paint is an easy way to touch-up minor nicks and scratches.

<b>93936*</b>		<b>\$5.25</b>
---------------	--	---------------

\*NOTE: Price shown is price per each bottle or pen. There are two bottles or pens per package.

**C. DECALS**

Use your imagination for the many uses of Genuine Harley-Davidson® Decals. A large variety of others in many different designs and colors are available through your Harley-Davidson Dealer. Ask your Dealer for more information.

Notice: The prices appearing in this catalog are the manufacturer's suggested retail prices. Actual retail prices may vary.

COLOR SHOP



B. PAINTS

C



C. DECALS



# 746 COLOR SHOP

## Medallions

### A. FUEL TANK NAMEPLATE AND ADAPTER KITS

For those of you with nostalgia in mind, our popular fuel tank trims fit a wide selection of early models. In addition, we now offer adapter kits for later models. The adapter kits come with all necessary hardware for installation of fuel tank trim on later models. Adapter Kit Brackets are self-adhesive to accommodate most universal applications. All trim and adapter kits are sold in pairs.

**1. 61769-47T** Fits all '47-'50 models. **\$39.95**

**Adapter Kit for P/N 61769-47T**

**61783-92T** Fits Fat Bob® fuel tanks. **\$18.95**  
Adapter Kit for use with P/N 61769-47T.

**2. 61776-61T** Fits '61-'62 FL models. **\$44.95**

**Adapter Kit for P/N 61776-61T**

**61740-90T** Fits Fat Bob fuel tanks. **\$18.95**  
For use with P/N 61776-61T.

**3. 61773-58T** Fits '58 Big Twin and XL models. **\$34.95**  
Black, Gold, and Silver.

**3. 61773-57T** Fits '57 Big Twin and XL models. **\$34.95**  
Red, White, Gold, and Silver.

**Adapter Kit for P/Ns 61773-58T and 61773-57T**

**61780-91T** For use on flat surfaces. **\$18.95**

For use with P/N 61773-58T and P/N 61773-57T.

**61781-91T** For use on curved surfaces. **\$18.95**

For use with P/N 61773-58T and P/N 61773-57T.

**4. 61775-59T** Fits Fat Bob fuel tanks. **\$39.95**

**Adapter Kit for P/N 61775-59T**

**61742-93T** Fits Fat Bob fuel tanks. **\$18.95**  
For use with P/N 61775-59T.

**5. 61769-40T** Fits '36-'46 Big Twin models. **\$39.95**

**Adapter Kit for P/N 61769-40T**

**61785-92T** Fits Fat Bob fuel tanks. **\$18.95**  
For use with P/N 61769-40T.

**6. 61774-51T** **\$39.95**  
Fits '51-'54 Big Twin and '52-'54 K models.

**Adapter Kit for P/N 61774-51T**

**61784-92T** Fits Fat Bob fuel tanks. **\$18.95**  
For use with P/N 61774-51T.

**7. 61777-63T** Fits '63-'65 FL and XL models. **\$34.95**

**Adapter Kit for P/N 61777-63T**

**61782-91T** Fits Fat Bob fuel tanks. **\$18.95**  
For use with P/N 61777-63T.

**8. 61771-66TB** **\$34.95**  
Fits '66-'71 FL, XL models and '71 FX models.

**Adapter Kit for P/N 61771-66TB**

**61741-93T** Fits Fat Bob fuel tanks. **\$18.95**  
For use with P/N 61771-66TB.

### B. FUEL TANK NAMEPLATE AND ADAPTER KITS – '55-'56 "V-LOGO"

This is the latest piece in our line of authentic nameplate reproductions. These nameplates are offered in two versions: Chrome and Gold.

Fits Fat Bob Fuel Tanks.

**61814-55T** Chrome. (pair) **\$39.95**

**Adapter Kit for P/Ns 61814-55T and 61841-94T**

Self-adhesive adapter brackets easily accommodate most universal applications. For use with '55-'56 Medallion P/N 61814-55T.

**61840-94T** (pair) **\$18.95**

### C. SPECIAL EDITION MEDALLION

Special Edition Medallion with Harley-Davidson logo. Adhesive backing for easy installation.

Fits '96-later Electra Glide® inner fairing and other flat surfaces.

**14813-03** Peace Officer – Nickel Finish. **\$14.95**

**14814-03** Firefighter – Brass Finish. **\$14.95**



A. FUEL TANK NAMEPLATE AND ADAPTER KITS



B. FUEL TANK NAMEPLATE AND ADAPTER KITS – '55-'56 V-LOGO

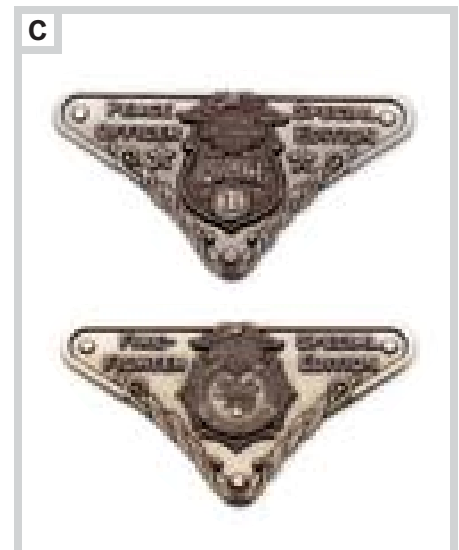

C. SPECIAL EDITION MEDALLION – PEACE OFFICER AND FIREFIGHTER

Notice: The prices appearing in this catalog are the manufacturer's suggested retail prices. Actual retail prices may vary.



D. DECORATIVE MEDALLIONS

**D. DECORATIVE MEDALLIONS**

Display a touch of attitude. Ideal for use on plate-style sissy bar uprights and battery covers, the adhesive backing on these high-quality cast medallions allows easy installation on most flat surfaces. The medallions are available in black accented chrome or antique nickel finishes. The Oval Bar & Shield logo and the Bar & Shield with Wings medallions look great with Chrome Backrest Mount P/Ns 52527-01 and 52531-01.

- 1. Skull – Antique Nickel**  
91720-02 Size 3-5/8" x 3". **\$19.95**
- 2. Skull – Chrome**  
91718-02 Size 3-5/8" x 3". **\$19.95**
- 3. Skull with Wings – Antique Nickel**  
91732-02 Size 5" x 1-1/2". **\$19.95**
- 4. Skull with Wings – Chrome**  
91723-02 Size 5" x 1-1/2". **\$19.95**
- 5. Bar & Shield Logo with Wings – Chrome**  
91745-02 Size 4" x 1-1/2". **\$17.95**
- 6. Oval with Bar & Shield Logo – Chrome**  
91716-02 Size 3-3/8" x 1-1/2". **\$17.95**



E. SELF-ADHESIVE MEDALLIONS AND SISSY BAR UPRIGHT INSERTS

**E. SELF-ADHESIVE MEDALLIONS AND SISSY BAR UPRIGHT INSERTS**

Works great on derby covers, timer covers, medallion plate-style sissy bar uprights and chrome battery covers.

- Made In U.S.A. Eagle**
- 1. 99000-77** Large Medallion. **\$19.95**
- 2. 32510-77** Small Medallion. **\$15.95**

~~**Made in U.S.A. Eagle**  
99025-89 **\$21.95**  
Fits '89-'07 Touring models with Console Fuel Door. (not shown)~~

- Bar & Shield Logo**
- 3. 91815-85** Large Medallion. **\$19.95**
- 4. 91816-85** Small Medallion. **\$15.95**
- Eagle with Bar & Shield Logo**
- 5. 91811-85** Large Medallion. **\$19.95**
- 6. 91810-85** Small Medallion. **\$15.95**
- Sissy Bar Upright Insert**  
Fits low and tall insert-style H-D® Sissy Bar Uprights.
- 7. 91807-85** Eagle with Bar & Shield Logo. **\$27.95**

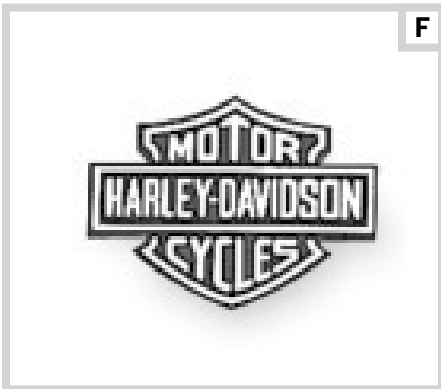

F. METAL ADHESIVE-BACKED LOGO



G. EAGLE FAIRING DECAL

**F. METAL ADHESIVE-BACKED LOGO**

All you do is choose the style you like, select a Timer or Derby Cover, and affix the medallion to the cover. Works great on medallion, plate-style sissy bar uprights and chrome battery covers.

- 99352-82Z** Bar & Shield Logo. Universal. **\$7.95**

**G. EAGLE FAIRING DECAL**

Gives your fairing that custom look. Multi-colored. Made in the U.S.A.

- Eagle decal fits FL, FLH and FLHT fairings.
- 14093-84** Black Background. **\$39.95**



H. CHROME "LIVE TO RIDE" LOGO UNIVERSAL MEDALLION



I. GOLD "LIVE TO RIDE" LOGO UNIVERSAL MEDALLION

**H. CHROME "LIVE TO RIDE" LOGO UNIVERSAL MEDALLIONS**

These self-adhesive medallions are made of durable ABS plastic, and look great on sissy bars, battery covers, Tour-Pak® luggage carriers, saddlebags, etc.

- 99027-87T** 3-1/2-inch. **\$18.95**
- 99028-87T** 2-1/2-inch. **\$16.95**

**I. GOLD "LIVE TO RIDE" LOGO UNIVERSAL MEDALLIONS**

These self-adhesive medallions are made of durable ABS plastic, and look great on sissy bars, battery covers, Tour-Pak® luggage carriers, saddlebags, etc.

- 99027-90T** 3-1/2-inch. **\$23.95**
- 99028-90T** 2-1/2-inch. **\$21.95**

Notice: The prices appearing in this catalog are the manufacturer's suggested retail prices. Actual retail prices may vary.



# SECURITY & STORAGE

*Storage and the parking space out front aren't always as safe as you'd like. Moisture and accidents can damage your bike's finish in the garage, while common thieves are always eyeballing your pride and joy. You've put too much into your motorcycle to not give yourself the peace of mind that comes with a protective cover and security system. Protect your investment and defend your ride.*





**A. HARLEY-DAVIDSON SECURITY SYSTEM PAGER RECEIVER II – BATTERY POWERED**

**A. HARLEY-DAVIDSON® SECURITY SYSTEM PAGER RECEIVER II**

Designed to complement the Smart Siren II, this Pager Receiver can be linked to the vehicle with no additional installation. The Pager Receiver II monitors the Security System operation, and features multi-color LED indicators to display unique codes for arming, disarming and trigger modes. The Range Confirmation Signal (RCS) confirms and displays the signal reception. Hi-efficiency FM circuitry provides excellent reception, even in buildings and parking garages. Maximum effective range is up to 1/2 mile. The Pager Receiver II features selectable vibration or audible modes. The silent paging mode feature allows selectable programming trigger modes to avoid activating the siren.

**Pager Receiver II – Battery Powered**

The convenient built-in ultra-bright white LED flashlight helps light the way. The compact, lightweight receiver can be carried in your pocket, or the receiver holster can be clipped to a belt up to 1-3/4 inches wide. Kit includes receiver, holster, and one 3V lithium battery. Operates in conjunction with the Security System Fob and Smart Siren II.

**91660-06** **\$69.95**  
Fits all models equipped with the Harley-Davidson Security System Smart Siren II. Certified for use in North America.

**66378-06** **\$2.95**  
CR2450 3v Lithium Replacement Battery.

**Pager Receiver II – Rechargeable**

The compact, lightweight receiver can be carried in your pocket or clipped to a belt. Kit includes receiver and UL-listed battery charger (AC-DC with Output of DC 4.5V 50mA for North America). Operates in conjunction with the Security System Fob and Smart Siren II.

**91672-07** **\$79.95**  
Fits all models equipped with the Harley-Davidson Security System Smart Siren II. Certified for use in North America.



**A. HARLEY-DAVIDSON SECURITY SYSTEM PAGER RECEIVER II – RECHARGEABLE**

**B. HARLEY-DAVIDSON® SECURITY SYSTEM PAGER**

The Harley-Davidson Security System Pager with Range Confirmation Signal (RCS) offers advanced paging surveillance. The pager monitors the Security System operation and can display unique codes for arming, disarming and trigger modes using an alphanumeric LED display window. The pager is designed to operate in conjunction with the Security System Key Fob and operate with the Smart Siren, or as a silent paging system only. The Range Confirmation Signal (RCS) feature allows you to check and confirm that you are within range to receive a vehicle security signal when detected while the Security System is armed. A unique multi-code learning feature allows you to monitor up to three vehicles with a single pager receiver. The pager's high output 4-watt digital transmitter has exceptional range and a built-in backup power supply. The transmitter will continue to operate even if the wires are cut or the vehicle battery is disconnected. The transmitter does not require batteries. The pager's receiver incorporates a unique alphanumeric LED display window that displays the Security System arming modes and trigger signals with selectable vibration or audible modes. The message memory display stores and displays the last six messages. The receiver holster includes an attachment clip that accepts belts up to 1-3/4 inches wide. The pager's receiver requires two "AAA" size alkaline batteries (*not included*). Certified for use in North America, United Kingdom, Australia and Singapore.

**91665-03** **\$195.95**

Fits '04-later XL, XR, '96-later Dyna®, '00-later Softail®, and '97-later Touring models equipped with the Harley-Davidson Factory Security System. ('96-'03 Dyna and '04-later XL models not equipped with Smart Siren require additional installation hardware. '96-'03 Dyna models require Bracket P/N 70470-01A and (4) Screw 2501A. '04-later XL models require: Bracket P/N 70474-04A, (2) Spacer 5775, (2) Screw 3462, (2) Lock Nut 94028-92T. '04-'05 XL models require Siren Harness P/N 91702-04, and '06-later XL models require Siren Harness P/N 91734-06.) Certified for use in North America, United Kingdom, Australia and Singapore.

**Replacement/Additional Security System Pager Receiver**  
Requires two "AAA" size alkaline batteries (*not included*).

**91660-03** **\$69.95**  
**OBSOLETE**  
All models equipped with the Security System Pager.



**B. HARLEY-DAVIDSON SECURITY SYSTEM PAGER**



**B. HARLEY-DAVIDSON SECURITY SYSTEM PAGER**

*Notice: The prices appearing in this catalog are the manufacturer's suggested retail prices. Actual retail prices may vary.*



# 750 SECURITY & STORAGE

## Security Systems

### A. H-D® SMART SECURITY SYSTEM – '07-LATER MODELS

The H-D Smart Security System offers automatic self-arming and hands-free disarming for vehicle electronic security functions for your '07-later Harley motorcycle. The Hands Free Fob communicates directly on its own unique and individualized frequency with the Hands Free Security Module and Antenna. Attach the Hands Free Fob to your vehicle ignition key ring. As you upright your vehicle or switch the ignition on, the Hands Free Fob will communicate the Security System "disarm" command allowing you to start your vehicle. After riding your vehicle, park and switch the ignition off with your key. Within 5 seconds the Security System will automatically self-arm, disabling your vehicle starter, ignition and electronic fuel injection (EFI). The rider may also disarm the system by keying a previously entered personal code on the turn signal switches. A flashing status indicator informs the rider that the Smart Security System is armed or disarmed. The Smart Security System allows configuration to include the Transport Mode or Extended Storage Mode. The Smart Security System includes: Hands Free Security Module (Integrated Security Sensor and Turn Signal Module), Hands Free Fob, Antenna Module, Antenna Harness and Antenna Mount (Dyna models).

#### Also available:

#### H-D SMART SECURITY SYSTEM HANDS FREE FOB

Replacement/Additional Hands Free Fob.

**68926-07** **\$39.95**

Fits '07-later models equipped with H-D Smart Security System.

**66373-06** **\$1.95**

CR2032 3v Lithium Replacement Battery.

### B. H-D FACTORY SECURITY SYSTEM – '06-EARLIER MODELS

Equip your '06-earlier Harley-Davidson® VRSC™, Sportster®, Dyna®, Softail® or Touring model with the security system designed and approved by The Harley-Davidson Motor Company.

When armed, the Security System disables the starter and ignition while monitoring the electrical system and vehicle motion with adjustable sensitivity. Minor disturbances trigger a momentary warning; major ones an unbroken thirty-second alarm, after which the Security System returns to monitoring. A distinctive four-way flasher pattern is the alarm signal. An optional self-powered Smart Siren Kit adds a piercing scream that sounds even if the battery cable is cut.

The Security System is armed and disarmed with a remote control waterproof key fob utilizing state-of-the-art rolling code technology. If the key fob is not available, the rider may arm or disarm the system by keying a previously entered personal code on the turn signal switches. A flashing status indicator informs the rider that the Security System is armed or disarmed.

When armed in the Transport Mode, the Security System disables the starter and ignition, but monitors only the electrical system, not vehicle motion. The vehicle may be moved but electrical tampering triggers an alarm.

An Extended Storage Mode keeps the battery from discharging when the Security System is armed for extended periods of time.

The Security System is compatible with FL Touring models equipped with approved TLE/Ultra Sidecars when the system is configured as described in the SIDE CAR OWNER'S MANUAL.

#### H-D Factory Security System Includes:

- Security Module (Integrated Security Sensor, and Turn Signal Module)
- Remote Control Waterproof Key Fob
- Pocket-Sized Operation Manual

#### Also available:

#### REPLACEMENT/ADDITIONAL REMOTE CONTROL WATERPROOF KEY FOB

**68926-00** **\$39.95**

Fits models equipped with H-D Factory Security System, North America.

**68927-00** **\$39.95**

Fits models equipped with H-D Factory Security System, International (except Japan).

**66373-06** **\$1.95**

CR2032 3v Lithium Replacement Battery.



A. H-D SMART SECURITY SYSTEM – '07-LATER MODELS



A. H-D SMART SECURITY SYSTEM – '07-LATER MODELS



B. H-D FACTORY SECURITY SYSTEM – '06-EARLIER MODELS

Notice: The prices appearing in this catalog are the manufacturer's suggested retail prices. Actual retail prices may vary.

C



Security System Smart Siren II



Security System Smart Siren

### C. H-D® SECURITY SYSTEM SMART SIREN II

Security and convenience in one. The Harley-Davidson® Smart Siren II combines the functionality of the smart siren and pager transmitter into one easy-to-install unit. Featuring a built-in back-up power supply, the siren and transmitter functions will continue to operate even if the wires are cut or the vehicle battery is disconnected. When combined with the Pager Receiver II (sold separately), the integrated FM transmitter can warn of tampering up to 1/2 mile away. Smart Siren II features an enhanced sound chamber, a redesigned internal battery access cover, and ultra low power consumption during the standby mode. When activated, the Security System Fob arm and disarm commands are confirmed with a blink feature and '07-later models can be programmed to emit a chirp. Smart Siren II is certified for use in North America.

### H-D FACTORY SECURITY SYSTEM SMART SIREN KIT

Add an additional level of security with this battery-operated siren. The replaceable internal battery provides continued security if main battery is disconnected. This high-powered siren has a piercing sound, and has built-in plug-type connector for easy connection to the wiring harness.

#### Smart Siren Kit Contains:

- Smart Siren
- Mounting Bracket
- Additional Brackets & Mounting Hardware

### SMART SIREN BATTERY REPLACEMENT KIT (not shown)

Replacement Battery Kit for Harley-Davidson® Factory Security System Smart Siren includes replacement nickel metal hydride battery, foam pad, siren seal, cover and instructions.

**69018-00 \$19.95**

## C. H-D SECURITY SYSTEM SMART SIREN

### H-D® SECURITY SYSTEMS, NORTH AMERICA

Model Year	Model Family	Motorcycle Security System		Smart Siren Kit		Smart Siren II Kit**	
2007-2010	VRSC (except VRSCF)	68207-07	\$299.95	68328-02	\$84.95	68328-06A	\$89.95
2009-2010	VRSCF	91684-08	\$299.95	68328-02	\$84.95	68328-06A	\$89.95
2002-2006	VRSC/A/B/D	68200-00D	\$269.95	68328-02	\$84.95	68328-06A	\$89.95
2006	VRSCR	68207-00D	\$269.95	68328-02	\$84.95	68328-06A	\$89.95
2007-2010	FL Touring	68200-07*	\$299.95	68328-02	\$84.95	68328-06A	\$89.95
2002-2006	FL Touring	68200-00D*	\$269.95	68328-02	\$84.95	68328-06A	\$89.95
2001	FL Touring	68200-00D*	\$269.95	68317-01A	\$89.95	68317-06	\$99.95
1997-1999	FL Touring	69176-02***	\$269.95	68317-01A	\$89.95	68317-06	\$99.95
2007-2010	Dyna	68207-07	\$299.95	68328-02	\$84.95	68328-06A	\$89.95
2002-2006	Dyna	68207-00D	\$269.95	68328-02	\$84.95	68328-06A	\$89.95
2001-2003	Dyna	68200-00D	\$269.95	68318-01A	\$89.95	68318-06	\$99.95
2007-2010	Softail (except FXCW)	68207-07	\$299.95	68328-02	\$84.95	68328-06A	\$89.95
2008-2010	FXCW/C	91684-08	\$299.95	68328-02	\$84.95	68328-06A	\$89.95
2002-2006	Softail	68207-00D	\$269.95	68328-02	\$84.95	68328-06A	\$89.95
2001-2002	Softail	68207-00D	\$269.95	68319-01	\$99.95	68319-06A	\$99.95
2007-2010	XL/XR	68200-07	\$299.95	68352-04B	\$99.95	68352-06B	\$99.95
2004-2006	XL	68200-00D	\$269.95	68352-04B	\$99.95	68352-06B	\$99.95

\*P/N 88115-03 Bank Angle Switch Kit (sold separately) and Security System P/N 68200-00D and 68200-07 are required for use on 2000-2008 FL Touring models equipped with a TLE/Ultra Sidecar.

\*\*Pager function requires Remote Pager Receiver II P/N 91660-06 or 91672-07 (sold separately).

\*\*\*Installation of P/N 69176-02 on '97-'99 Touring models requires separate purchase of Installation Kit P/N 68346-01.

Notice: The prices appearing in this catalog are the manufacturer's suggested retail prices. Actual retail prices may vary.

# 752 SECURITY & STORAGE

## Locks & Keys

### A. KEYED-TO-MATCH INDIVIDUAL REPLACEMENT LOCK PROGRAM

In the past, replacing a lock required the time and expense of re-keying a new lock or replacing all of the locks on your bike. Our Keyed-to-Match program eliminates that hassle and allows you to order an exact replacement based on your lock's key code, right down to the quality you would expect from a stock Harley-Davidson® lock. Just ask your Dealer to refer to Bulletin Number 658B and they'll take care of your needs – lock, stock and barrel.

### B. SECURITY CHAIN & PADLOCK<sup>1,2</sup>

Maximum protection for your motorcycle. This premium quality trapezoidal hex link thru-hardened steel chain is surrounded by an exclusive Bar & Shield logo nylon webbing to provide protection from scratching. The padlock features a hardened steel shackle to resist cutting, and a new high-security disc-style cylinder with blade-style key. The lock features a rotating dust cover to protect the cylinder, and a molded nylon casing to prevent scratching. Kit includes key registration and replacement service.\* Security chain length: 5'. Chain and padlock weight: 11.5 lbs.

**46091-98B** Universal. **\$129.95**



A. KEYED-TO-MATCH REPLACEMENT LOCKS



B. SECURITY CHAIN & PADLOCK

### C. H-D® CABLE LOCKS<sup>1,2</sup>

#### 1. H-D 12mm Accessory Cable Lock

A less bulky, multi-purpose cable lock great for securing helmets, leathers and other items. 6' length, braided steel cable with vinyl cover and H-D® branded snap-shut keyway. Key registration\* and replacement service is available.

**46090-98** Universal. **\$18.99**

#### 2. H-D 15mm Super Hard Wire Cable Lock

Braided tempered steel with vinyl cover for frame and wheel protection, and a snap-shut cylinder with H-D branded lock head. 6' in length, 2.75 lbs. Key registration\* and replacement service is available.

**46088-98** Universal. **\$49.99**

#### 3. H-D 20mm Super Hard Wire Cable Lock

Braided tempered steel with vinyl cover for frame and wheel protection, and a snap-shut cylinder with H-D branded lock head. 6' in length, 2.9 lbs. Key registration\* and replacement service is available.

**46089-98** Universal. **\$61.99**

\*Key Registration and Replacement Service: This service is provided by the lock manufacturer. Information is included in the product packaging.



C. H-D CABLE LOCKS

### D. DISC BRAKE LOCK AND REMINDER CORD<sup>1</sup>

Designed to prevent roll-away theft, this lock provides security protection and resists cutting and chisel attacks. Hardened drop forged steel lock features a new dual-reinforced high-security disc-style cylinder and blade-style key. The compact and sleek design is finished in brilliant chrome-plated finish and features a machined Bar & Shield logo. Kit includes a high visibility reminder cord that loops from the lock to the handlebar, acting as a visual indication that your lock is still engaged, and features key registration and replacement service.

**46086-98A** **\$46.95**

Fits front brake rotor on '83-later models, except those with 19-inch laced front wheels. Does not fit front brake rotor on VRSC™ models equipped with solid disc wheels.



D. DISC BRAKE LOCK AND REMINDER CORD



D. DISC BRAKE LOCK AND REMINDER CORD



**<sup>1</sup>WARNING:** Remove lock before operating motorcycle. Failure to remove lock could result in death or serious injury.



**<sup>2</sup>WARNING:** Chain or cable is to be used as a theft deterrent only. Use for towing, lifting, or any other purpose could result in death or serious injury.

Notice: The prices appearing in this catalog are the manufacturer's suggested retail prices. Actual retail prices may vary.

# SECURITY & STORAGE 753

Locks & Keys



E

**E. LOCK REMINDER CORD**



F

**F. HIGH SECURITY PADLOCK**

**E. LOCK REMINDER CORD<sup>1</sup>**

Remember to remove your Disc or Fork Lock before beginning your ride with this high visibility Reminder Cord. Flexible, coiled, bright orange cord loops from external lock to handlebar, acting as a visual indication that your lock is still engaged.

**46318-04** Universal. **\$4.95**

**F. HIGH SECURITY PADLOCK<sup>1</sup>**

Premium quality, commercial grade padlock features a tough, hardened boron alloy shackle and dual ball bearing locking mechanism. Steel lock body is enclosed in high-tech black Xenoy<sup>®</sup>, offering exceptional weather resistance.

**45721-96A** Universal. **\$31.95**

**G. HARLEY-DAVIDSON<sup>®</sup> BAR & SHIELD LOGO PADLOCK<sup>1</sup>**

Our best-selling lock of all time. A beautiful lock with a long, proven history of success. Chrome-plated and case-hardened.

**45737-72A** Universal. **\$21.95**

**Shown with:**

**BAR & SHIELD LOGO LEATHER PADLOCK POUCH**

Leather pouch provides a handy place to store your padlock. It has a snap flap, embossed Bar & Shield logo, and it is sized to hold a variety of padlocks. Two heavy-duty tie straps are included.

**45789-92** Universal. **\$29.95**



G

**G. BAR & SHIELD LOGO PADLOCK AND LEATHER PADLOCK POUCH**



H

**H. UNIVERSAL MOUNT HELMET LOCK**

**H. UNIVERSAL MOUNT HELMET LOCK<sup>1</sup>**

Designed to be installed on any 7/8" to 1-1/4" diameter tubing such as engine guards, saddlebag guards, and frame tubes. Conveniently secures helmets. To be used only when motorcycle is parked and locked.

**45732-86** **\$18.95**

Fits all models (except VRSC™ and '04-later XL and XR models).

**I. FAIRING LOWER LOCKING GLOVE BOX DOORS SET**

Keyed-to-match security. Add secured storage to your fairing lowers. This locking glove box door kit replaces the Original Equipment flexible snap-on covers, and provides convenient, weather resistant storage for documents, cell phones, and sun glasses. The kits are "keyed to match" to your motorcycle ignition barrel style keys, for "one key" convenience. This locking door kit is an ideal companion of the fitted glove box liner kit, P/N 58714-06. Kit includes left and right locking door assemblies and door frames.

**57411-08** **\$195.95**

Fits '91-later Touring models equipped with Electra Glide<sup>®</sup> Ultra style fairing lowers. Also fits accessory fairing lowers, vented and non vented. Does not fit with Glove Box Door Pouch P/N 57400-06.



I

**I. FAIRING LOWER LOCKING GLOVE BOX DOORS SET**

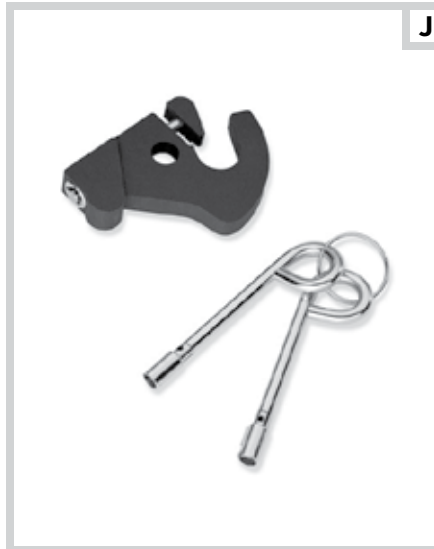

J

**J. DETACHABLES LOCK**

**J. DETACHABLES LOCK\***

This unique lock replaces the cam-lock on your Harley-Davidson<sup>®</sup> Detachable accessories, providing additional security and peace-of-mind when parking your vehicle. Kit includes two extended-reach barrel-style keys for easy access to the lock. Designed exclusively by Harley-Davidson. Key registration\* and replacement service is available.

Fits all models equipped with Detachable Sideplates, Racks and Tour-Pak<sup>®</sup> Luggage Carriers (except '09-later Touring models equipped with Detachable Solo Tour-Pak Rack).

**46063-98** Single. **\$46.95**

~~**46106-00** Set of Two. **\$89.95**~~ **OBSOLETE**

\*Key Registration and Replacement Service: This service is provided by the lock manufacturer. Information is included in the product packaging.



**WARNING:** Remove lock before operating motorcycle. Failure to remove lock could result in death or serious injury.

Notice: The prices appearing in this catalog are the manufacturer's suggested retail prices. Actual retail prices may vary.



# 754 SECURITY & STORAGE

## Locks & Keys

### A. KEYED-TO-MATCH CUSTOM KEYS

#### 1. Commemorative CVO™ Ignition Key

Celebrate the exclusive nature of your Harley-Davidson® CVO™ (Custom Vehicle Operations) motorcycle with this commemorative ignition key. Keyed-to-match your ignition and fork lock, this hand-polished brass key features a prismatic Bar & Shield logo set in a black field surrounded by "Custom Vehicle Operations" script. Available to CVO vehicle owners only, the key is made-to-order and delivered in a leatherette gift box. See your Dealer for ordering information.

**71031-04** Available to CVO motorcycle owners only. **\$89.95**

#### 2. Skull Ignition Keys

Keyed-to-match your ignition and fork lock, this key features the Harley-Davidson Skull logo in bright nickel with black accents. Key is delivered in a leatherette gift box. Keys can be ordered through your Harley-Davidson dealer and will be keyed-to-match your bike.

**71040-04** Barrel Style. **\$59.95**  
Fits '91-later models with barrel style key.

**71041-04** Blade Style. **\$59.95**  
Fits '94-later XL models with blade style key.

#### 3. Bar & Shield Logo Ignition Keys

Keyed-to-match your ignition and fork lock, this key features the Harley-Davidson Bar & Shield logo with an antique brass finish. In time and with use the key will continue to develop a patina and character. Key is delivered in a leatherette gift box. Keys can be ordered through your Harley-Davidson dealer and will be keyed-to-match your bike.

**71038-04** Barrel Style. **\$59.95**  
Fits '91-later models with barrel style key.

**71039-04** Blade Style. **\$59.95**  
Fits '94-later XL models with blade style key.

### B. REMOTE CONTROL GARAGE DOOR OPENER KIT

Operate your automatic garage door opener without leaving your motorcycle seat or fumbling in your pocket for the remote control. Compatible with most brands of automatic openers, this kit allows you to operate your door by cycling the bike's high-beam switch. The hidden transmitter splices into your bike's wiring harness and is powered by your vehicle battery, so there are no transmitter batteries to replace. When your key is switched off the transmitter is disabled, providing added garage security if you park your bike outside. The signal is sent to the in-garage receiver that plugs into a standard 110-volt outlet and is wired to the automatic opener. The receiver's rolling code technology provides additional security. Kit includes one transmitter and one receiver. Individual components are available to equip additional motorcycles and garages.

**91558-01A** **\$129.95**  
Fits '02-later VRSC™, '94-later XL, '08-later XR, '96-later Dyna® and Softail®, '94-later Touring and Trike models.

#### 1. Remote Control Garage Door Opener Transmitter

This kit allows owners of the Remote Garage Door Opener P/N 91558-01A to equip each of their Harley-Davidson® motorcycles with a remote transmitter.

**91561-01A** **\$69.95**  
For use with Remote Garage Door Opener P/N 91558-01A.

#### 2. Remote Control Garage Door Opener Receiver

This additional receiver permits the owner of the Remote Garage Door Opener P/N 91558-01A to operate more than one garage door opener from a single transmitter.

**91562-01** **\$69.95**  
For use with Remote Garage Door Opener P/N 91558-01A.

#### 3. Remote Control Garage Door Opener Key Fob

Operate your Harley-Davidson® Remote Garage Door Opener from your car. This Key Fob fits on your key ring, and works with the rolling code technology of the receiver to provide added security. Because up to eight devices can be programmed for use with a single Remote Garage Door Opener Receiver, everyone in your family can have access. Two buttons can be set for use on multiple Remote Garage Door Openers. Indicator light shows Fob is working. Batteries included.

**91569-01** **\$49.95**  
For use with Remote Garage Door Opener Kit P/N 91558-01A.



A. KEYED-TO-MATCH CUSTOM KEYS

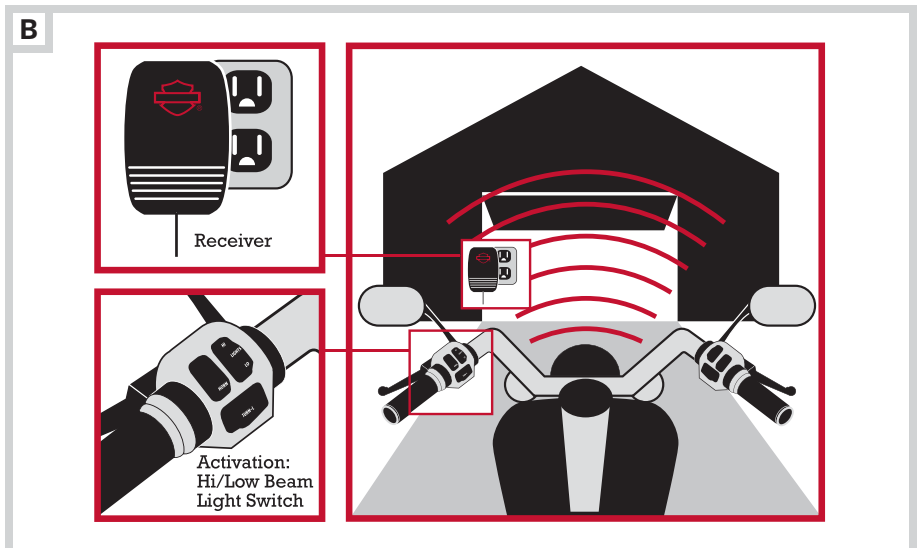

B. REMOTE CONTROL GARAGE DOOR OPENER KIT



B. REMOTE CONTROL GARAGE DOOR OPENER KIT

# SECURITY & STORAGE 755

Motorcycle Covers



C

C. MOTORCYCLE SUPER SHIELD COVER



D

D. PREMIUM COTTON INDOOR STORAGE COVER



E

E. BREATHABLE INDOOR STORAGE COVER



F

F. INDOOR/OUTDOOR MOTORCYCLE COVER WITHOUT EAGLE LOGO



F

F. INDOOR/OUTDOOR MOTORCYCLE COVER WITH EAGLE LOGO – TOURING



NEW

G

G. INDOOR/OUTDOOR TRIKE COVER

## C. MOTORCYCLE SUPER SHIELD COVERS

This premium, heavy-duty motorcycle cover is constructed of a resilient 2-layer fabric. The outside layer is durable, fade resistant, urethane-coated polyester that resists water, dirt and stains. Internal layer is a sturdy, yet soft tricot material, providing a paint-friendly, soft to the touch finish. Double stitched and heat sealed, taped seams provide strength and superior water resistance. Venting system allows for breathability and accommodates longer-term storage. Additional features include heat resistant exhaust panels, elastic edges, securing strap/grommets, and a deluxe storage bag. The covers are accented with a silver Harley-Davidson Bar & Shield logo. Touring version comes with hook-and-loop secured openings to accommodate dual antennas.

**98744-09 \$179.95**

Fits Softail®, Dyna® Wide Glide®, and VRSC™ models.

**98743-09 \$189.95**

Fits Touring models (except Trike).

## D. PREMIUM COTTON INDOOR STORAGE COVERS

We take these indoor covers one step further. Additional processing provides a softer nap to the heavyweight 8-oz. cotton. The premium cotton material is breathable, allowing moisture to escape when your bike is in storage. Accented with an embroidered Bar & Shield logo, this cover features elastic edges and includes a convenient storage bag.

**91687-98 \$129.95**

Fits Sportster®, Dyna models (except FXDWG).

**91686-98 \$129.95**

Fits Softail, Dyna Wide Glide, and VRSC models.

**91685-98 \$129.95**

Fits Touring models (except Trike).

## E. BREATHABLE INDOOR STORAGE COVER

Constructed from soft, non-abrasive polyester that is breathable, allowing condensation to escape when your bike is in storage (not waterproof). Features elastic edges, silk-screened Eagle logo, and includes a convenient storage pouch. A great choice when storing your motorcycle indoors for extended periods of time.

**98716-87B \$79.95**

Fits all models (except Trike).

## F. INDOOR/OUTDOOR MOTORCYCLE COVERS

Our most versatile covers, these all-weather, indoor/outdoor covers are made of a tough, lightweight 300 denier, fade resistant polyester. The urethane-coated material and double stitched seams, provide excellent strength and water resistance. Venting system allows for breathability and accommodates longer-term storage. Exhaust heat shield panel(s) protect the covers from hot exhaust systems. Additional features include a protective windshield liner (for Softail/VRSC and Touring versions), securing strap, elastic edges, and a convenient storage pouch. Touring versions come with hook-and-loop secured openings to accommodate dual antennas.

### Indoor/Outdoor Motorcycle Covers without Eagle Logo

**98721-90B \$99.95**

Fits Sportster, Dyna models (except FXDWG).

**98722-90C \$109.95**

Fits Touring models (except Trike).

### Indoor/Outdoor Motorcycle Covers with Eagle Logo

**98705-85VB \$99.95**

Fits Sportster®, Dyna® models (except FXDWG).

**98724-92C \$104.95**

Fits Softail®, Dyna Wide Glide®, and VRSC™ models.

**98715-85VC \$109.95**

Fits Touring models (except Trike).

## G. INDOOR/OUTDOOR TRIKE COVER

This all-weather, indoor/outdoor cover is made of a tough, lightweight 300 denier, fade resistant polyester. The urethane-coated material and double stitched seams provide excellent strength and water resistance. Venting system allows condensation to escape during long-term storage. Exhaust heat shield panels protect the cover from hot exhaust systems. Additional features include a protective windshield liner, securing strap, elastic edges, and a convenient storage pouch. Trike Covers feature hook-and-loop secured openings to accommodate dual antennas and a silk-screened Eagle logo.

**83845-09 \$149.95**

Fits '09-later Trike models.

STORAGE

NOTE: H-D® motorcycle covers are not designed to be used while trailering. Using an H-D motorcycle cover while trailering may cause the cover to tear, possibly causing damage to the cover and motorcycle.

Notice: The prices appearing in this catalog are the manufacturer's suggested retail prices. Actual retail prices may vary.

# 756 SECURITY & STORAGE

## Motorcycle Covers

### A. OASIS DAY COVER

Protect your bike from the elements when you are out on the road. Lightweight and compact for travel, this easy-to-store cover rolls into the built-in zippered bag. Made from soft, 150-weight polyester, this black and orange water repellent fabric dries quickly for a quick get away. Custom fit cover features an elastic band around the bottom hem, and the four footboard stirrups ensure a snug fit. The "Harley-Davidson" script and Bar & Shield logo prominently stand out on the fabric.

**98717-06** **\$89.95**

Fits Touring models (except Road Glide®) equipped with Tour-Pak® luggage.



A. OASIS DAY COVER

### B. SIDECAR COVER WITH EAGLE LOGO\*

Constructed from tough, lightweight, 250 denier water-repellent polyester. Matches Harley-Davidson® touring-style motorcycle cover, but is specifically sized to cover the body and windshield of your sidecar. Includes protective windshield liner, silkscreened Eagle logo, and elastic edging for a secure fit.

**98725-91** Fits all H-D® sidecars. **\$79.95**

### C. JIFFY STAND COASTER

Designed for use beneath the jiffy stand, this polypropylene coaster prevents the stand from sinking into soft surfaces such as dirt, asphalt and grass.

**94647-98** **\$5.95**

Fits motorcycles equipped with a sidestand.



B. SIDECAR COVER WITH EAGLE LOGO

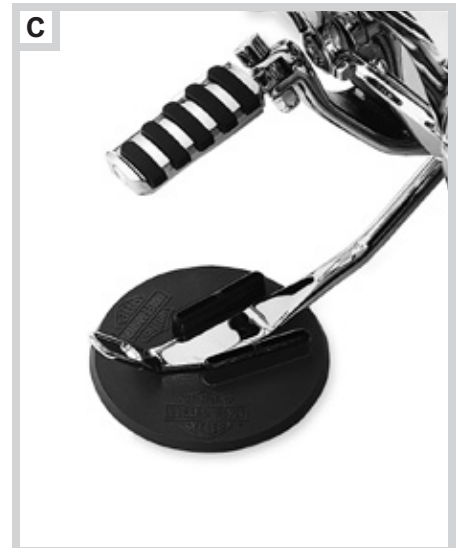

C. JIFFY STAND COASTER

### D. COTTON WINDSHIELD STORAGE BAG

This bag is constructed of breathable cotton material and is designed for a scratch-free storage area. The outside of the bag features an embroidered Bar & Shield logo to match the cotton cycle covers.

**95982-98B** **\$69.95**

Fits all Harley-Davidson® windshields.

### E. SOFT STORAGE BAG FOR FAIRING LOWERS

Protect your fairing lowers when they are removed for hot weather riding. This convenient storage bag features a heavy-weight 10 oz. cotton exterior and sturdy carrying handle. Dual zippers open to expose a soft felt interior with a sturdy divider for left and right lowers, and two zippered pouches for loose hardware storage. A classic embroidered Bar & Shield logo adorns the bag's exterior.

**95983-07** **\$79.95**

Fits all styles of Harley-Davidson Fairing Lower.



D. COTTON WINDSHIELD STORAGE BAG



E. SOFT STORAGE BAG FOR FAIRING LOWERS



**\*WARNING:** Do not use with someone riding inside. Doing so could result in death or serious injury.

NOTE: H-D® motorcycle covers are not designed to be used while trailering. Using an H-D motorcycle cover while trailering may cause the cover to tear, possibly causing damage to the cover and motorcycle.

Notice: The prices appearing in this catalog are the manufacturer's suggested retail prices. Actual retail prices may vary.

# SECURITY & STORAGE 757

Motorcycle Covers



F

F. HARLEY BUBBLE

## F. HARLEY® BUBBLE

The Harley Bubble is designed to constantly flow filtered air over the bike, providing a dust-free, condensation-free environment that greatly decreases the chances of corrosion during storage. The bike stays clean, dry, and best of all, can be viewed even while it's being stored. For indoor and North American use only. 110-volt only.

**94646-98** Fits models with Windshields and Tour-Pak® Luggage Carriers. Does not fit Trike or models equipped with a sidecar. **\$299.00**

**94662-98** Fits Sport and Cruising models. **\$289.00**

### Replacement Air Intake Filter for Harley® Bubble

**94688-00** Fits both Touring and Sport Harley Bubbles. **\$8.95**

## G. SERVICE COVERS

Protect the finish on your tank and fenders while performing routine service on your motorcycle. These custom shaped covers feature an easy-to-clean black vinyl outer surface and a soft non-abrasive fleece inner liner. Fuel tank covers feature built-in magnets to prevent the cover from sliding, convenient mesh pockets to keep small parts from rolling away, and a clear paperwork window for notes and instruction sheets. Fender covers feature soft elastic bands to keep the covers firmly in place. To complete the look, the cover features a nostalgic Harley-Davidson logo that will look great in any garage.

**94640-08** Large Fuel Tank. Fits Dyna®, FXR, Softail® and Touring models. **\$29.95**

**94642-08** Sportster® 3.5 Gallon Fuel Tank. Fits XL models with 3.5 gallon peanut tank. **\$29.95**

**94645-08** Sportster 4.5 Gallon Fuel Tank. Fits XL models with 4.5 gallon tank. **\$29.95**

**94644-08** VRSC™ Air Box. Fits VRSC models (except VRSCF). **\$29.95**

**94641-08** Large Front Fender. Fits FL Softail and Touring models. **\$29.95**

**94643-08** Small Front Fender. Fits XL, XR, Dyna, FXR and FX Softail models. **\$29.95**



G

G. SERVICE COVERS – LARGE FUEL TANK



G

G. SERVICE COVERS – SPORTSTER 3.5 GALLON TANK



G

G. SERVICE COVERS – LARGE FENDER



G

G. SERVICE COVERS – SMALL FENDER

STORAGE

Notice: The prices appearing in this catalog are the manufacturer's suggested retail prices. Actual retail prices may vary.



# 758 SECURITY & STORAGE

## Motorcycle Lifts & Tie-Downs

### A. MOTORCYCLE SERVICE LIFT

This lift raises and lowers motorcycles by a hand crank, allowing you to elevate the motorcycle up to 19" off the ground. A friction disc helps hold the lift in place and wheels make it easy to roll into storage. Minimum clearance for lift is 4-1/2 inches. Tie-downs must be used with Lift. Recommend using Hog Ties® P/N 94649-98 and/or Hog Ties with Integrated Soft Hooks P/N 94672-99. Frame Protectors P/N 94675-99 also recommended.

**94653-98** **\$379.95**

Fits all Harley-Davidson® V-Twin models (except Trike and models equipped with a Sidecar). Twin Cam-equipped Dyna® models require Adapter Kit P/N 98965-99 for proper fitment.

#### Also available:

#### FRAME PROTECTORS

Use these Frame Protectors to protect the underside of your motorcycle when using any lift. A must for Softail® models to provide the clearance necessary to keep lift pressure on the frame and not the shock absorbers. Universal and customizable to fit any V-Twin Harley-Davidson® motorcycle.

**94675-99** Fits all 1-1/4" frame tubes. (pair) **\$15.95**

#### TWIN CAM-EQUIPPED DYNA® MODEL MOTORCYCLE SERVICE LIFT ADAPTER KIT (not shown)

Provides the necessary clearance of the oil tank that allows the Motorcycle Service Lift P/N 94653-98 to be used on '99-later Dyna models equipped with the Twin Cam engine.

**98965-99** **\$24.95**

### B. HOG TIES® STRAPS WITH INTEGRATED SOFT HOOKS

This version of the popular Hog Ties tie-down has integrated Soft Hooks along with the standard coated steel hooks, allowing you a choice of either the soft or steel hook against the motorcycle. It is especially useful for avoiding pinching of brake lines, wiring or other parts that can be damaged by steel hooks. Features sturdy buckles with cast Harley-Davidson Bar & Shield logo.

**94672-99** Fits all models. (pair) **\$42.95**

### C. HOG TIES STRAPS AND HOG TIES SOFT HOOKS

#### 1. Hog Ties® Straps

Made and designed specifically for Harley-Davidson® motorcycles, these are among the sturdiest tie-downs on the market. Each tie-down is a full 1-1/2 inches wide for unbelievable holding strength, with sturdy buckles that feature the Harley-Davidson Bar & Shield logo. At least 50% wider and 50% stronger than a standard tie-down. Don't trust your Harley-Davidson® motorcycle to anything less.

**94649-98** Fits all models. (pair) **\$39.95**

#### 2. Hog Ties Soft Hooks

New, wider Soft Hooks to be used in conjunction with the super strong Hog Ties Straps. These Soft Hooks prevent scratching of handlebars, fairings, etc. and have a whopping 5,700 pounds of tensile strength.

**94650-98** Fits all models. (pair) **\$8.95**



A. MOTORCYCLE SERVICE LIFT



B. HOG TIES STRAPS WITH INTEGRATED SOFT HOOKS



C. HOG TIES STRAPS AND HOG TIES SOFT HOOKS

# SECURITY & STORAGE 759

Motorcycle Tie-Downs



**D. AN CRA RAT-PACK RATCHET STYLE TIE-DOWNS**



**E. AN CRA RED SNAPPER TIE-DOWNS**



**F. AN CRA TIE-DOWNS**



**G. AN CRA SOFT-HOOK EXTENSIONS**



**H. AN CRA WHEEL TIE-DOWN STRAPS**



**I. AN CRA BOLT-ON FITTING KIT**



**J. BLACK BUNGEE CORDS AND CHROME BUNGEE NUTS**



**K. BLACK CARGO NETS**

**D. AN CRA® RAT-PACK RATCHET STYLE TIE-DOWNS**

The Ankra ratcheting buckle allows you to quickly and easily secure your load.

**98187-90T** (pair) **\$34.95**

**E. AN CRA RED SNAPPER TIE-DOWNS**

The Red-Snapper is a motorcycle tie-down with the extra assurance of a self-locking end hook. Tension strength is 1,200 pounds straight pull and 2,400 pounds loop pull.

**98190-85T** (pair) ~~**OBSOLETE**~~ **\$26.95**

**F. AN CRA TIE-DOWNS**

Features the Ankra cam-buckle that protects the webbing while providing a secure non-slip grip. This 66-inch long motorcycle tie-down is rated at 1,200 pounds straight pull and 2,400 pounds looped tension.

**98186-84T** Black. (pair) **\$24.95**

**98189-85T** Red. (pair) **\$24.95**

**98183-90T** Orange. (pair) **\$24.95**

**G. AN CRA SOFT-HOOK EXTENSIONS**

Black Soft Hook acts as a tie-down extension, keeps hooks away from delicate surfaces, and is available in two loop lengths, 12 inches and 18 inches. Each Soft-Hook has an assembly strength of 3,000 pounds.

**98192-85T** 12 inches. (pair) **\$6.95**

**98193-85T** 18 inches. (pair) **\$7.95**

**H. AN CRA® WHEEL TIE-DOWN STRAPS**

These wheel tie-down straps are 36 inches long and have a loop strength of 300 pounds. The straps are made of one-inch tough polypropylene webbing and have a spring-loaded nickel-plated buckle.

**98191-85T** (pair) ~~**OBSOLETE**~~ **\$11.95**

**I. AN CRA® BOLT-ON FITTING KIT**

The Ankra Bolt-On Fitting Kit is a quick disconnect, positive-locking tie-down ring that can be mounted anywhere. When not in use, the locking ring assembly can be quickly and easily removed from the contoured aluminum base, leaving no protruding hardware. The Ankra tie-down fitting is rated at 4,000 pounds upward pull strength and 2,000 pounds side (90°) pull strength.

**98194-85T** ~~**OBSOLETE**~~ **\$14.95**

**J. BLACK BUNGEE CORDS**

**98196-85T** 18" length. **\$2.95**

**98197-85T** 24" length. **\$2.95**

**98198-85T** 30" length. **\$2.95**

**98199-85T** 24" length - 4 hook. **\$4.95**

**Inset photo:**

**CHROME BUNGEE NUTS**

**98184-90T** 3/8" - 24 thread. (pair) **\$6.95**

**98185-90T** 3/8" - 16 thread. (pair) **\$6.95**

**K. BLACK CARGO NETS**

These versatile nets feature vinyl-coated attaching hooks to hold your cargo securely. For helmets, small packages, etc. Works great with chrome bungee nuts.

**97008-07** 12" x 12" - 4 hook. **\$6.95**

**98170-88T** 15" x 15" - 6 hook. **\$7.95**

**98169-88T** 18" x 18" - 6 hook. **\$8.95**



# CLEANING & MAINTENANCE

*Cleaning and servicing your bike is both essential and rewarding. Just remember: avoid using “auto parts store” brand parts and cleaning supplies. Genuine Harley-Davidson® service parts are engineered to maintain the integrity of your ride, and oils, lubes and cleaning supplies are formulated for the unique surfaces and operating conditions of your motorcycle.*



## SOLVING COMMON CLEANING ISSUES

- ✔ Before applying any protective or cosmetic product, you should always start off by washing your motorcycle with Sunwash® Concentrate.
- ✔ Don't detail your bike in the direct light of the day. Sun-warmed clearcoat and hot surfaces may streak and swirl when drying.
- ✔ To soften melted-on boot marks and tar from exhaust pipes, put a generous dab of Harley® Glaze on the spot and let it set for a few minutes. Then scrape away the gunk with an H-D® softcloth.
- ✔ The natural acid in bug splatter is damaging to surface finishes, so be sure to act quickly. Apply Harley-Davidson® Bug Remover, wait a minute to soften the residue, and rinse away the debris.
- ✔ Don't have time for a complete detailing session? Use Harley Gloss or Harley Spray Cleaner & Polish for quick jobs.



### TIRES & TIRE CARE

Certified by Harley-Davidson, model-specific Dunlop® and Michelin® tires have been subjected to rigorous handling and reliability testing. And Harley® Black Protectant shields the sidewalls from harmful UV rays.

## MAINTENANCE ON THE OUTSIDE

### BATTERIES & CHARGERS

Extend the life of your Harley® AGM battery with an easy-to-use charger. Designed to maintain a full charge between rides, the quick-connect harnesses provide a simple plug-in connection.



### MAINTENANCE TOOLS

Harley offers a complete line of tools that make life on the road a little easier. Tire gauges and compact tool kits are easy to pack and help keep your bike ready for the next day's ride.

## MAINTENANCE ON THE INSIDE

### OIL & LUBRICANTS (RIGHT)

Tested and certified for Harley-Davidson® engines, oils like Screamin' Eagle® SYN3® Lubricant are formulated to provide superior protection in high-temperature, air-cooled engines.



### OIL FILTERS (LEFT)

Clean oil is the lifeblood of your engine. For maximum protection, you should always follow recommended oil service intervals, and replace the filter with Harley SuperPremium5™ oil filters.





# 762 MAINTENANCE

## Surface Care Products

### A. HARLEY-DAVIDSON® BIKE WASH KIT

Bike Wash Kit includes the essentials required to clean your bike.

- *Sunwash® Concentrated Cleaner* that is formulated to promote sheeting action that prevents hard water spots, and rinses clean even on hot sunny days. Biodegradable.
- *Bug Remover* spray that melts away bugs without damaging metal, plastic or painted surfaces. Biodegradable.
- *Wash Mitt* that features premium quality wool-blended material with extra-dense pile for scrubbing power and durability. Machine washable.
- *Soft Detailing Pad* that helps remove debris without scratching surface finishes. Easy-to-grip Bar & Shield logo shape.
- *Soft Drying Towel* that is safe for use on all surface finishes. Synthetic material is extra absorbent and dries without streaking.
- *Microfiber Detailing Cloth* that can be used for washing, cleaning or buffing. The cloth can be used wet or dry, and is safe for use on all surface and finishes.

94701-09

\$49.95

### B. HARLEY-DAVIDSON® DETAILING KIT

Detailing Kit includes the essentials to make your bike shine.

- *Harley® Glaze® Polish & Sealant* spray that protects against fading and the oxidizing effects of acid rain and harsh airborne pollutants. The durable, breathable, clear poly-sealant with UV protection is safe for use on most painted and chrome-plated surfaces. (Not for use on matte, semi-gloss and wrinkle finish paints.) Biodegradable.
- *Harley Gloss* spray that produces a high-gloss finish in the shortest amount of time. The non-abrasive spray also provides UV protection. Biodegradable.
- *Bright Metal Polish* paste that is formulated with micro-abrasives to refurbish and refinish metal motorcycle parts that have lost their original luster.
- *Bright Chrome Cleaner* paste that is non-abrasive and formulated to ensure maximum shine on chrome-plated surfaces.
- *Swirl & Scratch Treatment* spray that removes fine scratches and swirls in one easy step.
- *Spray Cleaner & Polish* aerosol waterless quick cleaner/detailer that floats dirt and dust off the surface for a quick and easy cleanup.
- *Softcloth* disposable towels that are designed to protect painted surfaces and minimize residual lint while waxing and polishing.

94702-09

\$49.95



A. HARLEY-DAVIDSON BIKE WASH KIT

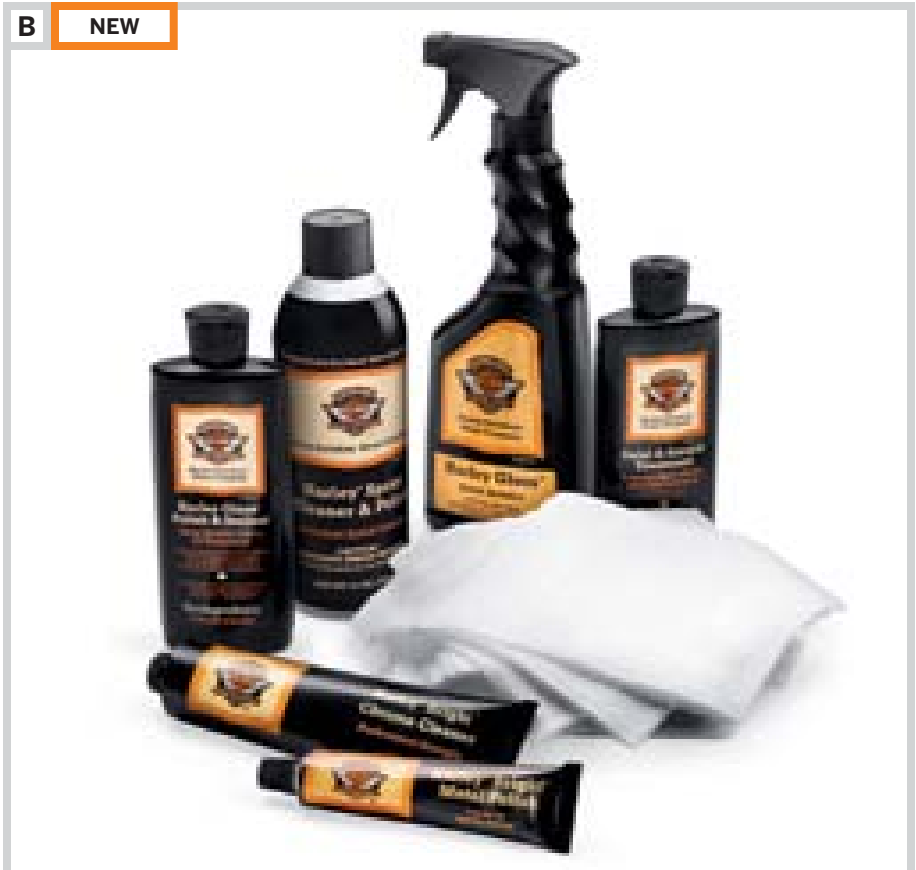

B. HARLEY-DAVIDSON DETAILING KIT

Notice: The prices appearing in this catalog are the manufacturer's suggested retail prices. Actual retail prices may vary.

NEW

C

## MAINTENANCE 763

Surface Care Products



C. HARLEY-DAVIDSON WHEEL CARE KIT

**C. HARLEY-DAVIDSON® WHEEL CARE KIT**

Wheel Care Kit includes the essentials to keep your wheels and tires spotless.

- *Wheel & Tire Cleaner* spray that cleans wheels, tires and whitewalls in seconds. Biodegradable.
- *Soft Detailing Pad* that helps remove debris without scratching surface finishes. Easy-to-grip Bar & Shield logo shape.
- *Wheel and Spoke Brush* is tapered to reach into tight spaces, and features all natural fibers attached to a polypropylene-coated base to prevent scratching.
- *Softstrips* untreated cloths that are sized to get cleaning and polishing compounds into hard-to-clean areas. Ideal for wheel spokes and cylindrical surfaces.
- *Harley® Black* pigmented polymer formulation that provides UV protection and restores the luster to black tire sidewalls. Biodegradable.

94703-09

**\$49.95****D. HARLEY-DAVIDSON® CLEANING BUCKET WITH MULTI-POCKET APRON**

The perfect way to keep your bike and garage clean at the same time, this 3.5 gallon cleaning bucket makes motorcycle maintenance easy. It features a handy 9-pocket mesh apron that is sewn to fit high-quality Harley-Davidson® detailing products (*sold separately*) and a sturdy handle for added convenience.

94811-10

Universal.

**\$39.95**

D

D. HARLEY-DAVIDSON CLEANING BUCKET  
SHOWN WITH HARLEY SURFACE CARE PRODUCTS (SOLD SEPARATELY)

Notice: The prices appearing in this catalog are the manufacturer's suggested retail prices. Actual retail prices may vary.

# 764 MAINTENANCE

## Surface Care Products

### A. HARLEY-DAVIDSON® SURFACE CLEANERS

#### 1. Harley-Davidson® Bug Remover

Remove bugs with little effort. Bugs have natural acids in their systems that can prove to be very damaging to motorcycle finishes if not removed. Harley-Davidson Bug Remover melts away bugs without damaging metal, plastic or painted surfaces. Biodegradable.

**94657-98** 8-oz. Pump Spray. **\$4.95**

#### 2. Harley-Davidson® Sunwash® Cleaner Concentrate

This revolutionary cleaner lets riders wash their bikes where they want to in the sun. Most bike wash products can be used only on cool days or in the shade. Harley-Davidson Sunwash Cleaner has a unique formulated sheeting action that prevents hard water spots and rinses clean even on hot days in the sun. Biodegradable.

**94659-98** 8-oz. Bottle. **\$4.95**

#### 3. Harley-Davidson® Wheel & Tire Cleaner

The road provides plenty of nasty elements that can be potentially damaging to the finish of motorcycle wheels. Harley-Davidson Wheel & Tire Cleaner cleans wheels, tires and whitewalls in seconds. Recommended for use on Harley-Davidson black-coated exhaust pipes and mufflers. Biodegradable.

**94658-98** 16-oz. Spray Bottle. **\$7.95**

### B. HARLEY-DAVIDSON® SURFACE BRIGHTENERS

#### 1. Harley-Davidson® Swirl & Scratch Treatment

Designed to remove those annoying fine scratches and swirls, this unique compound contains non-rigid abrasives that provide good initial leveling action on clearcoat and slowly become less aggressive while being buffed. This staging of grit size provides the benefits of a several step process in one convenient bottle. Biodegradable.

**94655-98** 8-oz. Bottle. **\$5.95**

#### 2. Harley® Glaze Polish & Sealant

For use on all painted surfaces (except denim, semi-gloss and wrinkle) and chrome-plated finishes. Harley Glaze polish and sealant is three products in one bottle. A durable, breathable, clear poly-sealant with UV protection to protect against fading and the oxidizing effects of acid rain and harsh airborne pollutants. An ultrafine leveling agent to level and remove fine scratches and minor blemishes in clear coat finishes. A cleaner to handle tar, tree sap, stains and pollutants. Easy to apply and hand buff for a deep, glass-like finish. Biodegradable.

**99701-84** 8-oz. Bottle. **\$6.95**

#### 3. Harley® Gloss

This easy-to-apply mist produces the highest possible gloss finish in the shortest amount of time, yet is non-abrasive and provides UV protection. Can be used on paint, clear coats, chrome, powder-coats, Lexan®, vinyl and plastic. Contains no waxes, silicones, oils or hydrocarbon solvents. Will not remove Harley Glaze polish and sealant. Biodegradable.

**94627-98** 16-oz. Spray Bottle. **\$9.95**

### C. HARLEY® SPRAY CLEANER & POLISH

New and improved, this aerosol waterless quick cleaner/detailer is perfect for those times when the motorcycle is too clean to wash and too dirty to ride. Floats dirt and dust off the motorcycle surfaces, allowing for quick and easy cleaning and detailing. The spray also reduces static attraction to dust and leaves a great shine plus UV protection. Provides a convenient way to keep your bike looking clean, especially when touring.

**99817-99B** 12-oz. Aerosol Can. **\$5.95**

### D. HARLEY® BLACK TIRE SIDEWALL PROTECTANT

Black pigmented polymer formulation provides UV protection and restores the luster to black tire sidewalls. Recommended as a base coat before applying color with Tire Lettering Pen P/N 98625 or 98619. Biodegradable.

**94628-05** 16-oz. Bottle. **\$14.95**



A. HARLEY-DAVIDSON SURFACE CLEANERS



B. HARLEY-DAVIDSON SURFACE BRIGHTENERS



C. HARLEY SPRAY CLEANER & POLISH



D. HARLEY BLACK TIRE SIDEWALL PROTECTANT



E

**E. HARLEY BRIGHT METAL POLISH AND CHROME CLEANER**



F

**F. HARLEY PRESERVE BARE ALUMINUM PROTECTANT**



G

**G. WINDSHIELD WATER REPELLENT TREATMENT**



H

**H. HARLEY CARE STARTER KIT**



NEW

I

**I. HARLEY REJUVENATOR TREATMENT FOR BLACK LEATHER**



J

**J. LEATHER DRESSING**

**E. HARLEY® BRIGHT™ METAL POLISH**

Professional strength micro-abrasive polish formulated to refurbish/refinish metal motorcycle parts that have lost their original finish. Recommended for use on polished aluminum or polished stainless steel surfaces that are not clear coated. Do not use on any painted, chromed or plated surfaces, or decorative brushed aluminum/brushed stainless steel finishes. Follow instructions on tube and always use a clean Harley Softcloth.

**99725-89** 2-oz. Tube. **\$9.95**

**Also shown:**

**HARLEY® BRIGHT CHROME CLEANER**

This easy to use, professional strength, non-abrasive cleaner is formulated to ensure maximum shine on chrome-plated surfaces. It is detergent resistant for long-lasting brightness and can also be used to clean decorative brushed aluminum/stainless steel finishes.

**94683-99** 5.3-oz. Tube. **\$9.95**

**F. HARLEY® PRESERVE™ BARE ALUMINUM PROTECTANT**

Provides superior corrosion control for bare aluminum surfaces by forming a protective polymeric coating. The long-lasting formula is detergent and UV-resistant, and is compatible with Harley-Davidson approved painted surfaces. The convenient dispensing container includes 20 disposable wipes for easy treatment application. Ideal for bare aluminum machined wheels. Should not be applied to mirror-polished surfaces or areas that will achieve operating temperatures greater than 300 degrees Fahrenheit.

**99845-07** Universal. **\$14.95**

**G. WINDSHIELD WATER REPELLENT TREATMENT**

Approved for use on Harley-Davidson® model Lexan® windshields. Enhance visibility during wet-weather riding. Reduces the surface tension of water, allowing the water to bead and dissipate from the windshield by the airflow during riding. The convenient dispensing container includes ten disposable wipes for easy application of the treatment. You can repeat application of the treatment as necessary. Not recommended for use on face shields. Not for use as an anti-fog product.

**99841-01** 10 Wipes. **\$6.95**

**H. HARLEY® CARE STARTER KIT**

It takes a while to create the ultimate biker's garage, but you have to start somewhere. The Harley Care Starter Kit is the perfect place. It includes four 2-ounce refillable sample bottles of high-quality, proven Harley-Davidson® cleaning products, including Sunwash®, Harley Gloss™, Wheel & Tire Cleaner and Bug Remover products. Whether you're an old hand at motorcycle maintenance or just beginning, these products are the best way to clean and detail your bike. (All cleaning products contained in this kit are biodegradable.)

**94671-99A** Four 2-oz. Bottles in Box. **\$9.95**

**I. HARLEY® REJUVENATOR TREATMENT FOR BLACK LEATHER**

Harley Rejuvenator black-pigmented leather treatment puts new life back into faded black leather seats and saddlebags. To re-color and condition weathered leather, just clean the surface and apply the treatment with a Harley Softcloth. Wipe off the excess, buff the leather surfaces to the desired shine, and your leather looks like new. For lasting weather protection, follow the application with Harley Leather Dressing P/N 98261-91V.

**98839-09** 6-oz. Container. **\$6.95**

**J. LEATHER DRESSING**

Harley-Davidson® Leather Dressing assures you the most effective weatherproofing and preservative action for your leather products such as saddlebags, tank panels, gear, and apparel. Specially formulated for smooth, oil-tanned leather.

**98261-91V** 6-oz. Jar. **\$6.95**

Notice: The prices appearing in this catalog are the manufacturer's suggested retail prices. Actual retail prices may vary.



# 766 MAINTENANCE

## Surface Care Products

### A. "LITTLE HARLEY HELPER" WASH SET

The little ones have been asking for a good way to show you how much they appreciate all those rides. Teach the little ones how to help care for your Harley® motorcycle with the "Little Harley Helper" Wash Set. Kit contains (1) H-D® youth-sized wash mitt, (1) H-D adult-size wash mitt, (1) 2-oz. starter bottle of H-D Sunwash®, and (1) H-D Soft Drying Towel packaged in a handy wash bucket with handle and lid. A great gift idea.

**94770-05** Universal. **\$19.95**

### B. HARLEY® GLAZE™ AND SOFTCLOTH SET

Three-in-one Harley Glaze polish and sealant cleans painted and chrome-plated surfaces, removes fine scratches, and seals the finish against fading and oxidizing. Harley-Davidson® Softcloth disposable towels are designed to clean and polish without scratching the surface. This handy boxed set includes a 2-oz starter bottle of Harley Glaze polish and sealant and four Harley-Davidson Softcloth towels.

**94681-03** Universal. **\$3.95**

### C. WASH MITT

This premium quality, wool-blended wash mitt features extra dense pile for scrubbing power and durability. Machine washable, this mitt attains the perfect level of absorbency and has a Bar & Shield logo sewn into the cuff. Including a thumb for added dexterity, this mitt is custom designed to be used with either hand and made specifically for washing Harley-Davidson® motorcycles.

**94760-99** Universal. **\$12.95**



A. "LITTLE HARLEY HELPER" WASH SET



B. HARLEY GLAZE AND SOFTCLOTH SET



C. WASH MITT

Notice: The prices appearing in this catalog are the manufacturer's suggested retail prices. Actual retail prices may vary.



**D. SOFT DETAILING PAD**



**E. WHEEL AND SPOKE BRUSH**



**F. SOFTSTRIPS**



**G. MICROFIBER DETAILING CLOTH**



**H. SOFT DRYING TOWEL**



**I. SOFTCLOTHS**

**D. SOFT DETAILING PAD**

You'll always have a soft touch with this foam detailing pad, which helps remove debris without scratching surface finishes. Easy-to-grip Bar & Shield logo shape features a laminated cleaning face.

**94790-01** Universal. **\$9.95**

**E. WHEEL AND SPOKE BRUSH**

The perfect partner for Harley-Davidson® Wheel & Tire Cleaner, this brush features all natural fibers attached to a base coated with polypropylene to prevent scratching. With a Bar & Shield logo branded into the handle, the brush has a cone shape for efficient cleaning and durable design that won't melt on hot surfaces.

**43078-99** Universal. **\$14.95**

**F. SOFTSTRIPS**

Designed for detailing cylindrical surfaces. Untreated for use with your favorite Harley-Davidson® detailing care product. Contains 9 Softstrips in three convenient widths: 1-1/4" x 24", 3/4" x 24", and 1/2" x 24".

**94680-99** Universal. **\$6.95**

**G. MICROFIBER DETAILING CLOTH**

Super soft and absorbent microfiber synthetic cloth is the multi-purpose choice for washing, cleaning or buffing. The cloth can be used wet or dry and is safe for use on all surfaces and finishes. This durable 16" square cloth is mildew-resistant and machine washable. Includes convenient storage container.

**94663-02** Universal. **\$9.95**

**H. SOFT DRYING TOWEL**

Made of synthetic material that is safe for use on all surface finishes. Ensures extra absorbency without streaking. Stays soft and supple even when dry. Durable, mildew-resistant and machine washable. 12" x 21" towel stores in a convenient container.

**94791-01** Universal. **\$9.95**

**I. SOFTCLOTHS**

Rags often cause scratches in paint, but these disposable towels are made of special material specifically designed not to scratch paint while greatly reducing the amount of lint left behind during waxing and polishing. To avoid contamination, these disposable towels come in a handy resealable bag.

**94656-98** One package contains 25 towels. **\$5.95**

Notice: The prices appearing in this catalog are the manufacturer's suggested retail prices. Actual retail prices may vary.

# 768 MAINTENANCE

## Surface Care Products

### A. S100® CYCLE CARE KIT

S100 offers a complete range of cleaning products specifically formulated for motorcycle finishes. This convenient kit includes the most popular S100 products in an easy to store carrying case. Kit contains S100 Total Cycle Cleaner (500ml) with sprayer and sponge, S100 Detail and Wax (10-oz aerosol), S100 Corrosion Protectant (7.2-oz aerosol), S100 Finish Restorer (3.5-oz) and S100 Drying Towel.

**94689-00** Universal. **\$59.95**

### B. S100 CYCLE CARE PRODUCTS

#### 1. S100 Wheel Cleaner

Specifically formulated to combat brake dust, road soils, and chain lube that can bake onto your wheels from the heat of braking. Gel formula stays where you spray it for super cleaning power. Does not contain acids or lye.

**99775-89T** 500ml. (16.9-fl. oz.) **\$9.49**  
Bottle with Sprayer.

#### 2. S100 Carnauba Wax

Doesn't powder or leave stains on plastics and wrinkle parts. Buffs out easily to a mirror-like finish.

**99982-96** 6.2-oz. Paste Wax. **\$16.95**

#### 3. S100 Detail + Wax

The ideal item for touch-up cleaning and waxing in one easy step. Removes bugs, dust and rain film. Carnauba and bees-wax formula leaves a brilliant, water-repellent shine. UV inhibitors help keep paint from fading.

**99729-94T** 10-oz. Aerosol Can. **\$9.95**

#### 4. S100 Engine Brightener

At last, a motorcycle care product specifically designed to rejuvenate those dull, grayed-out wrinkle black painted surfaces such as cylinders, crankcases, gauge housings, etc. S100's unique high-temp formulation increases its adhesion characteristics as the temperature rises, thus it will not rinse off easily and stands up to weather, heat and numerous washings. Includes functional metered nozzle extension tube for easy, controlled-spray application, even in hard to reach areas.

**99849-97** 4.5-oz. Aerosol Can. **\$9.95**

#### 5. S100 Finish Restorer

Brightens aluminum and stainless steel. Removes minor scratches from clear-coated paint, plastics, etc. Rubs out easily with no unpleasant odor.

**99776-91T** 3.56-oz. Tube. **\$9.95**

#### 6. S100 Corrosion Protectant

Protects your bike's exposed metal surfaces from rust and corrosion. Spray on and rub to a shine quickly and easily. May also be used on fittings, plastic and rubber to preserve and protect. Perfect for winter storage, too.

**99757-89T** 7.2-oz. Aerosol Can. **\$10.95**

#### 7. S100 Shine Enhancing Cleanser

Removes swirls, deep film, water and acid rain deposits. The perfect set-up for S100 Carnauba Wax.

**99983-96** 11.8-fl. oz. **\$9.95**



A. S100 CYCLE CARE KIT



B. S100 CYCLE CARE PRODUCTS

Notice: The prices appearing in this catalog are the manufacturer's suggested retail prices. Actual retail prices may vary.



**C. S100 TOTAL CYCLE CLEANER PRODUCTS**

**C. S100® TOTAL CYCLE CLEANER PRODUCTS**

Provides superior cleaning without resorting to harsh chemicals or solvents that can leave a dirt-attracting film or damage sensitive surfaces.

<b>1. S100® Total Cycle Cleaner – Starter Bottle</b>		
<b>99769-88T</b>	500ml. (16.9-fl. oz.)	<b>\$7.95</b>
<b>2. 1-Liter Bottle with Sprayer and Sponge</b>		
<b>99760-85T</b>	1 Liter. (33.8-fl. oz.)	<b>\$14.95</b>
<b>S100 1-Liter Refill</b>		
<b>99759-87T</b>	1 Liter. (33.8-fl. oz.) (Does not include Sprayer or Sponge.)	<b>\$12.95</b>
<b>3. 5-Liter Canister</b>		
<b>99761-86T</b>	5 Liters. (1.32 gal.)	<b>\$52.95</b>
<b>4. 5-Liter Heavy Duty Sprayer with 6-foot Hose</b>		
<b>99766-87T</b>		<b>\$5.95</b>

**D. S100 TOTAL CYCLE CLEANER, AEROSOL**

Clean up your act with the tough, foaming action of S100 Total Cycle Cleaner. Safe for use on all your motorcycle paint, chrome and aluminum.

<b>99664-01</b>	21-oz. Aerosol Can.	<b>\$11.95</b>
-----------------	---------------------	----------------

**E. S100 SPECIAL SURFACES CLEANER**

S100 Special Surface Cleaner is a quick, easy, anti-static, streak-free cleaning product for removing road grime, bugs and other contaminants without water from fairings, windshields, helmets and other plastic or polycarbonate surfaces. Shake well, spray on to saturate the surface, and wipe off for a clean smooth surface.

<b>99844-07</b>	Universal.	<b>\$9.95</b>
-----------------	------------	---------------

**F. S100 POLISHING SOAP**

Combine soap's ease of application with the power of a polish. S100 Polishing Soap brightens aluminum and stainless steel surfaces and removes minor stains from chrome. Not for use on painted or anodized surfaces. Biodegradable and non-toxic.

<b>99779-04</b>	10.6-oz. Jar with sponge applicator.	<b>\$10.95</b>
-----------------	--------------------------------------	----------------

**G. S100 DETAILING SWABS – BULK PACK**

Convenient bulk pack of S100 Detailing Swabs for cleaning and polishing every hard-to-reach area. Package contains 50 – 8" sturdy cotton swabs with oversize heads and flexible shafts in a handy storage package.

<b>99780-04</b>	Universal.	<b>\$10.95</b>
-----------------	------------	----------------



**D. S100 TOTAL CYCLE CLEANER, AEROSOL**



**E. S100 SPECIAL SURFACES CLEANER**



**F. S100 POLISHING SOAP**



**G. S100 DETAILING SWABS – BULK PACK**

Notice: The prices appearing in this catalog are the manufacturer's suggested retail prices. Actual retail prices may vary.



# 770 MAINTENANCE

Surface Care Products

## A. HARLEY-DAVIDSON® HOG® BLASTER™ MOTORCYCLE DRYER

Dry your bike in minutes with the HOG Blaster. This powerful dryer blows a stream of warm, dry, filtered air at 18,000 feet/minute, allowing you to cut your drying time up to 75%. The HOG Blaster reduces streaks and water spots because water can't hide in hard to reach places. No more annoying drips and runs when you move your bike. With an ergonomically friendly design for comfortable handling, the HOG Blaster features a durable all-steel outer shell, a 1.3 hp motor, and a grounded electrical cord. Kit includes blower unit, flexible hose, and 2 diffuser attachments. One-year manufacturer's warranty on blower unit.

**94651-09** Universal. **\$119.95**

## B. BIKE BRITE® BLUE BUSTER® POLISHING KIT

Polishes away blue discoloration from chrome motorcycle exhaust pipes without stripping away gloss or shine. Comes with rubbing gel and polishing disc which allows pipes to be polished without removal.

**99835-94T** Universal. **\$27.95**

## C. NOVUS® PLASTIC CLEANER/PROTECTANT AND SCRATCH REMOVER

Harley-Davidson® windshields are formed from Lexan® material. General Electric (manufacturer of Lexan®) recommends very few products for maintenance of your windshield. Novus® has been tested and approved by G.E. for use on Harley-Davidson® windshields. This combination of cleaner and polish is perfect for use on Lexan windshields, helmet face shields and LED Tail Lamps.

### Directions for use:

- Remove dried-on bugs with Harley® Bug Remover.
- Wash windshield with Harley-Davidson Sunwash®.
- Apply Novus products with a clean Harley® Softcloth.
- Follow directions on product label.

### Novus® No. 1 Cleaner/Protectant

This mild abrasive-free cleaner will leave plastic with a lustrous shine without scratching and will resist fogging, fingerprints, smudging and smears. Repels dust and eliminates static.

**99837-94T** 8-oz. **\$4.95**

### Novus® No. 2 Scratch Remover

If your Lexan® windshield or helmet face shield has minor scratches or is faded, Novus No. 2 will remove the damage. Easily applied polish buffs out for a long-lasting deep shine that resists aging, marking, and scratching.

**99836-94T** 8-oz. **\$5.95**



A. HARLEY-DAVIDSON HOG BLASTER MOTORCYCLE DRYER



B. BIKE BRITE BLUE BUSTER POLISHING KIT



C. NOVUS PLASTIC CLEANER/PROTECTANT AND SCRATCH REMOVER

Notice: The prices appearing in this catalog are the manufacturer's suggested retail prices. Actual retail prices may vary.



**D. FILL-N-GO FUEL TANK FUNNEL**

**D. FILL-N-GO FUEL TANK FUNNEL**

The Fill-N-Go fuel tank adapter eliminates fuel spills and splash back during fill-ups, and reduces time at the pump. Just insert the Fill-N-Go over the fuel pump nozzle, and begin filling-up. When the pump clicks off, your tank is full, with no need to top off the tank. Kit includes Fill-N-Go tank adapter and a convenient storage pouch.

**99894-09** Universal. **\$19.95**

**E. SADDLEBAG SNAP REPAIR KIT**

Features heavy-duty repair snaps and do-it-yourself tool for replacing broken snaps on saddlebags and leather clothing.

**90739-99** **\$15.95**

**F. SADDLEBAG STRAP REPAIR KIT**

Features rivets and washers required for saddlebag strap repair. Kit includes 16 rivets (4 sizes) and 16 washers.

**88272-06** **\$9.99**



**E. SADDLEBAG SNAP REPAIR KIT**

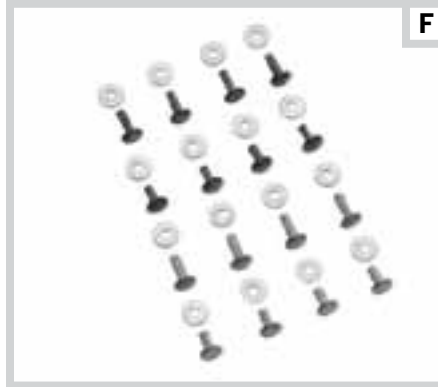

**F. SADDLEBAG STRAP REPAIR KIT**

**G. SEAT BUTTON REPAIR KIT**

Use to replace buttons on '85-later Pillow-Look Seats.

**52137-83** **\$7.95**

**H. TIRE LETTERING PEN**

Enhance your tire sidewall lettering by applying White paint. Acrylic ester resin paint provides excellent water resistance with improved color and gloss retention. Pump action paint dispensing pen with replaceable tips allows either outlining or filling the lettering. Includes two extra tips that can be shaped or trimmed to allow for customized paint flow. Harley® Black Tire Sidewall Protectant is recommended as a base coat before applying color with Tire Lettering Pen. 1/3 fluid oz.

**98636** Competition Yellow. **\$7.95**

**98619** Screamin' Eagle Orange. **\$7.95**

**98625** White. **\$7.95**



**G. SEAT BUTTON REPAIR KIT**



**H. TIRE LETTERING PEN - COMPETITION YELLOW**



**H. TIRE LETTERING PEN - SCREAMIN' EAGLE ORANGE**



**H. TIRE LETTERING PEN - WHITE**

Notice: The prices appearing in this catalog are the manufacturer's suggested retail prices. Actual retail prices may vary.

# 772 MAINTENANCE

## Battery Chargers

### HARLEY-DAVIDSON® BATTERY CHARGERS

Extend the life of your motorcycle battery with an easy-to-use Battery Charger or Battery Tender. Designed to maintain full charge during storage or between rides, all Harley-Davidson Battery Chargers include quick-disconnect harnesses for simple plug-in connection.

#### A. 1.25 AMP GLOBAL BATTERY CHARGER

A universal power supply unit enables the Global Battery Charger to properly charge and maintain all H-D 12-volt batteries. Advanced solid-state circuitry constantly monitors the battery's voltage without overcharging which causes damage. Switches to float mode automatically adjusting the charge rate up or down to keep the battery properly maintained for extended periods of time. Accepts worldwide voltage 100 to 240 VAC @ 50 to 60 Hz. Maximum charge rate of 1.25 Amperes. Kit includes a quick-disconnect 7.5 Amp fused Battery Charging Harness with ring terminals that can attach to the battery screw terminals for easy connection, and a 7.5 Amp fused alligator clip charging harness. 2 year manufacturer's warranty.

**99863-01B** \$69.95  
United States, Canada, Mexico and South America  
(except Argentina).



**A. 1.25 AMP GLOBAL BATTERY CHARGER**  
(TYPICAL RECHARGE TIME: 4-8 HOURS)

#### B. 1.25 AMP BATTERY CHARGING STATION

Keep all your bikes fully charged and ready to ride. Harley-Davidson Battery Charger Stations are designed to fully charge and maintain lead-acid motorcycle batteries, maintaining them at proper voltage. The 4-step Supersmart charging process (Initialization, Bulk, Absorption, Float) helps to prevent sulfation and reduces the effects of overcharging. Status indicator lights allow you to monitor the charging state of each connected battery. The Charging Station accepts worldwide voltage 100 to 240 VAC @ 50 to 60 Hz. Maximum charge rate of 1.25 Amperes.

The charger is sparkproof and reverse polarity protected, and features short-circuit protection to prevent damage from incorrect terminal connections. The durable, light-weight Charging Station is portable, but can be wall-mounted for added convenience. Kit includes quick-disconnect 7.5 Amp fused Battery Charging Harness with ring terminals and 7.5 Amp fused alligator clip charging harness for each battery output. 2 year manufacturer's warranty.

For 12-volt batteries.

**1. 99829-09** 2 Bank, Charging Station. \$129.95  
**2. 99847-09** 4 Bank, Charging Station. \$249.95



**B. 1.25 AMP BATTERY CHARGING STATION**  
(TYPICAL RECHARGE TIME: 4-8 HOURS)

#### C. BATTERY CHARGING HARNESS

Heavy-duty Battery Charging Harness with ring terminals and in-line 7.5 Amp fuse protection for attachment to a Harley-Davidson® 12-volt battery. The wiring harness utilizes a plug connector that is compatible with all Harley-Davidson® Battery Chargers equipped with black connectors. The ring terminals are attached to the battery with the harness routed to allow access for the plug connector attachment to a H-D® Battery Charger. The harness plug connector is protected with an attached weather-shield cap when not in use.

**94624-97B** Fits Harley-Davidson 12-volt batteries. \$7.95



**C. BATTERY CHARGING HARNESS**

#### D. BATTERY CHARGING EXTENSION LEAD

Is your motorcycle parking spot too far from your garage electrical outlet? Extend the reach of your Harley-Davidson Battery Charger with these convenient Extension Leads. Low-loss leads feature the same quick-disconnect two-prong plugs as found on the charger unit and the available charging harnesses.

For use with most Harley-Davidson Battery Chargers.

**99821-09** 12.5'. \$14.95  
**99828-09** 25'. \$19.95

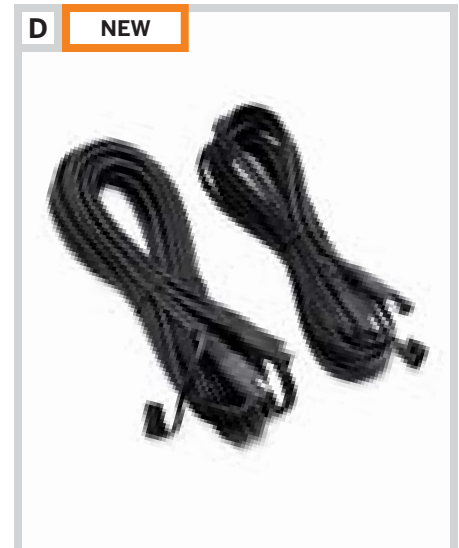

**D. BATTERY CHARGING EXTENSION LEAD**

*Notice: The prices appearing in this catalog are the manufacturer's suggested retail prices. Actual retail prices may vary.*



**E. 5 AMP GLOBAL BATTERY CHARGER**  
(TYPICAL RECHARGE TIME: 1-2 HOURS)



**F. 750mA SUPERSMART BATTERY TENDER**  
(TYPICAL RECHARGE TIME: 8-12 HOURS)



**G. 800mA WATERPROOF BATTERY TENDER, INTERNATIONAL**  
(TYPICAL RECHARGE TIME: 8-12 HOURS)

### E. 5 AMP GLOBAL BATTERY CHARGER

Professional charging performance in a compact package. The 5 Amp Global Battery Charger incorporates all the features of the 1.25 Amp Global Charger, and reduces typical recharging time to 1 to 2 hours. Maximum output charge rate is 5.0 Amperes. Compatible with 2-pin and 3-pin charging harnesses, the output current automatically switches between 5A and 2.5A, depending upon the type of harness used. The full 5A output current is available when used with 3-pin type harnesses and 2-pin charging harnesses are limited to 2.5A. The advanced solid-state circuitry constantly monitors and adjusts the voltage to maintain optimum battery energy levels without overcharging and automatically switches to float mode for maintaining charge over extended periods of time. The charger accepts worldwide input voltage 100 to 240 VAC @ 50 to 60 Hz. A universal power supply unit enables the 5 Amp Global Battery Charger to properly charge and maintain all H-D 12-volt batteries worldwide. Includes a specific power cord to accommodate regional variations in worldwide AC power configurations (refer to geographic fitment matrix). Charger features cable storage pocket and output leads equipped with 3-pin quick-disconnect that is compatible with the 7.5 Amp fused alligator clip charging harness and the Battery Charging Harness with ring terminals (included). 2 year manufacturer's warranty.

<b>99869-04</b>	United States, Canada, Mexico and South America (except Argentina).	<b>\$129.95</b>
<b>99874-04</b>	Europe.	<b>\$129.95</b>
<b>99943-04</b>	United Kingdom.	<b>\$129.95</b>
<b>99974-04</b>	Australia.	<b>\$129.95</b>

### F. 750mA SUPERSMART® BATTERY TENDER®

Many of the same features as the Global Battery Charger, but smaller and more economical. It's better than a trickle charger, because of the "smart" feature that turns itself on and off as needed, so your battery never overcharges. Accepts North American voltage (120V), supplied with 2-prong unpolarized plug. Output is 12 VDC @ 750 mA. Charger output lead is equipped with quick-disconnect black connectors. Kit includes a quick-disconnect 7.5 Amp fused Battery Charging Harness with ring terminals that can attach to the battery screw terminals for easy connection, and a 7.5 Amp fused alligator clip charging harness. 5 year manufacturer's warranty.

<b>94654-98B</b>	For 12-volt batteries.	<b>\$39.95</b>
------------------	------------------------	----------------

### G. 800mA WATERPROOF BATTERY TENDER, INTERNATIONAL

3-Step fully automatic charging (qualification, bulk charge, float), waterproof, vibration & shock resistant, spark proof, reverse polarity protected, LED Charge-Step indicator. 3 year manufacturer's warranty.

For 12-volt batteries.		
<b>99814-09</b>	Europe.	<b>\$49.95</b>
<b>99816-09</b>	U.K.	<b>\$49.95</b>
<b>99819-09</b>	Australia.	<b>\$49.95</b>
<b>99820-09</b>	Japan.	<b>\$49.95</b>

Global Battery Chargers Power Cord	Region	800mA P/N	1.25 AMPS P/N	5.0 AMPS P/N
	U.S., Canada, Mexico and South America (except Argentina)	N/A	99863-01B	99869-04
	Europe	99814-09	N/A	99874-04
	United Kingdom	99816-09	N/A	99943-04
	Australia	99819-09	N/A	99974-04

GLOBAL BATTERY CHARGER POWER CORD MATRIX

Notice: The prices appearing in this catalog are the manufacturer's suggested retail prices. Actual retail prices may vary.



# 774 MAINTENANCE

## Tools & Maintenance

### A. HARLEY-DAVIDSON®/SNAP-ON® TOOL KITS

These tool kits were developed specifically for Harley-Davidson by Snap-On® to perform the most functions with the least amount of tools and weight. Provides all the right tools, without compromising quality or damaging your motorcycle's hardware. Lifetime warranty.

#### H-D®/Snap-On Compact Tool Kit

Designed to provide the most tools in the least amount of space, this tool kit rolls into a compact pouch for easy transport.

**94684-00A** Universal. **\$199.95**  
Fits '00-later models (except FXR4 and VRSC™ models).

**94660-98** Universal. **\$189.95**  
Fits '99-earlier models.

#### H-D/Snap-On Softail® Tool Kit

Tailored to the Softail® motorcycle, this high-quality tool kit is compact to take anywhere, and shaped to fit Softail models equipped with teardrop-shaped tool box.

**94668-00** Universal. **\$169.95**  
Fits '00-later Softail® models.

**94661-98** Universal. **\$169.95**  
Fits '99-earlier Softail models.

### B. HARLEY-DAVIDSON® TOOL KIT

This is the ideal carry-along tool kit for your Harley-Davidson® motorcycle. The kit was developed to perform most service functions and weigh as little as possible to keep your load light.

**94819-02** **\$78.95**  
Fits '86-later XL, XR and '99-later Twin Cam-equipped models.

### C. TOOL KIT FOR VRSC™ MODELS

Designed specifically for the V-Rod® motorcycle, this is the ideal carry-along tool kit for your VRSC model. The kit includes the metric tools required to perform most service functions with the least amount of carrying weight.

**94820-02** Fits '02-later VRSC models. **\$89.95**

### D. FLT TOOL KIT

This kit is the ideal traveling companion. Standard on the Ultra Classic® Electra Glide® model, this kit is equipped to perform the basic "on-the-road" service functions for your Harley-Davidson® motorcycle. Made in the U.S.A.

**94435-02B** **\$89.95**  
Fits '02-later models (except VRSC™ models).

**94435-99** Fits '99-'01 Touring models. **\$94.00**

### E. 8-IN-1 SCREWDRIVER

Ideal tool for most of the screws on H-D® products. The unique 8-in-1 design conveniently stores all fittings within handle. Included are #40, 30, 27, and 25 Torx, #2 and 3 Phillips and 2 slotted driver bits. Quality engineered by Snap-On® with lifetime guarantee against breakage.

**94669-00** **\$19.95**



A. H-D/SNAP-ON COMPACT TOOL KIT FOR '00-LATER MODELS SHOWN



A. H-D/SNAP-ON SOFTAIL TOOL KIT FOR '00-LATER SOFTAIL MODELS SHOWN



B. HARLEY-DAVIDSON TOOL KIT



C. TOOL KIT FOR VRSC MODELS



D. FLT TOOL KIT



E. 8-IN-1 SCREWDRIVER



F

F. STYLUS PEN LIGHT – WHITE LENS



G

G. STAINLESS STEEL TRAYS WITH MAGNETIC BASE

**F. STYLUS® PEN LIGHT – WHITE LENS**

Put some light on the situation with the Stylus Pen Light with “Harley-Davidson” script. This pen light is waterproof with a 100,000 hour solid-state LED bulb. The light beam is visible from over one mile away, and has a momentary blink or constant-on switch.

**94843-01** Universal. **\$21.95**

**G. STAINLESS STEEL TRAYS WITH MAGNETIC BASE**

Convenient storage tray with a magnetic base secures small metallic parts during maintenance. Use it horizontally, vertically or upside down. The magnetic base is covered with a protective coating to prevent damage to surface finishes.

**94821-01** 4" Diameter. **\$8.95**

**94793-01** 6" Diameter. **\$10.95**

**H. COMPACT TIRE GAUGE AND TREAD DEPTH INDICATOR**

Combination dial air pressure and tread depth gauge provides easy access to the valve stem. A durable internal diaphragm provides accurate air pressure readings with a dual range indicator for 0-60 psi and 0-400 kPa readings. The pressure relief valve is activated by a push button to eliminate inner gauge air pressure after use. The integrated tire tread depth gauge features a dual-range color-coded indicator, calibrated in 1/32" (0-14/32") and millimeters (0-11mm), for monitoring tread wear. A protective rubber boot covers the housing to protect the gauge from impact and abrasion.

**75008-02A** Compact. **\$24.95**

**75137-98B** **\$29.95**

Compact with braided stainless steel lead.



H

H. COMPACT TIRE GAUGE AND TREAD DEPTH INDICATOR



I

I. TIRE GAUGE AND TREAD DEPTH INDICATOR WITH EMBOSSED LEATHER POUCH

**I. TIRE GAUGE AND TREAD DEPTH INDICATOR WITH EMBOSSED LEATHER POUCH**

Chrome-plated steel gauge housing with “Harley-Davidson” script and 90 degree air chuck. Dual range indicator for air pressure and tire tread depth readings. Calibrated for 10-50 psi and 0-32/32" tread depth readings. Rotate the indicator shaft 90 degrees in the housing for 70-345 kPa and 0-30mm tread depth readings. Complete with a Bar & Shield logo embossed leather pouch.

**75110-98B** Universal. **\$12.95**

**J. WHEEL BEARING REMOVAL AND INSTALLATION TOOL**

This unique tool permits easy installation and removal of sealed wheel bearings with standard wrenches – no press is required. The hardened steel tool is designed to protect the wheel and can be used with 1", .75" and 25mm I.D. bearings.

**94134-09** **\$289.95**

For use on '02-later VRSC™ and '00-later Sportster®, Dyna®, Softail® and Touring models.



NEW

J

J. WHEEL BEARING REMOVAL AND INSTALLATION TOOL

Notice: The prices appearing in this catalog are the manufacturer's suggested retail prices. Actual retail prices may vary.

# 776 MAINTENANCE

## Tools & Maintenance

### A. OIL FILTER REMOVAL WRENCH

This slip-resistant wrench, featuring a stainless steel band, is designed to make the removal of your oil filter much easier. Fits all models with spin-on oil filters.

**94686-00** **\$9.95**

### B. BELT TENSION TESTER TOOL

Use to check tension on secondary belt.

**40006-85** **\$29.95**

### C. SHOCK ADJUSTMENT SPANNER

The Universal Spanner is small enough to carry in a H-D® Tool Kit, and is designed to adjust the spring load on all mechanically adjustable H-D rear shock absorbers.

**94448-82B** **\$10.95**

For use on models with mechanically adjustable H-D rear shock adsorbers (except XR models).

### D. TIRE LEVER

~~This forged and hardened Tire Lever is extra long for increased leverage and features curved ends to prevent slipping off the rim and causing damage.~~

~~**94481-89T** **OBSOLETE** **\$13.50**~~

### E. COMBINATION AXLE WRENCH

Individual combination front and rear axle wrenches available for your model.

**1. 94696-08** 3/4" & 15/16" **\$10.95**  
Fits '99-'01 Touring and '00-'07 Softail® models.

**2. 94695-08** 3/4" & 36mm **\$10.95**  
Fits '02-'07 Touring models.

**3. 94697-08** 15/16" & 36mm **\$10.95**  
Fits '08-later Dyna®, Softail and Touring models.

### F. LOCTITE® 565 THREAD SEALANT

Formulated specifically for metal, tapered, pipe thread fittings, PST 565 cures rapidly to provide immediate low pressure sealing. Its controlled lubricity prevents galling, and it protects mated threaded areas from rust and corrosion. 565 can be used on fittings up to 2" (50mm) in diameter and has a temperature range of -65°F to 300°F (-54°C to 149°C). Disassembly possible with hand tools.

**1. 99818-97** 6 ml. Tube. **\$5.95**

### Anti-Seize Lubricant

An improved formulation to meet revision E of MIL-A-907E. It is a heavy-duty, high temperature anti-seize thread compound. It resists galling, corrosion and reduces wear in heavy pressure applications. This lubricant is based on a synthetic grease formulation containing graphite, aluminum, and copper and is sensor safe. It will not evaporate or harden when exposed to extreme heat or cold. Meets 1600°F temperature requirements.

**2. 98960-97** 1-oz. Tube. **\$4.95**

### G. HYLOMAR® GASKET AND THREAD SEALANT

Recommended for holding gaskets in place during engine assembly.

**99653-85** 3.5-oz. Tube. **\$16.95**



A. OIL FILTER REMOVAL WRENCH



B. BELT TENSION TESTER TOOL



C. SHOCK ADJUSTMENT SPANNER



D. TIRE LEVER



E. COMBINATION AXLE WRENCH



F. LOCTITE 565 THREAD SEALANT AND ANTI-SEIZE LUBRICANT



G. HYLOMAR GASKET AND THREAD SEALANT

Notice: The prices appearing in this catalog are the manufacturer's suggested retail prices. Actual retail prices may vary.

H



H. LOCTITE THREADLOCKER

## H. LOCTITE® THREADLOCKER

### 1. Loctite 271 Threadlocker and Sealant – Red

High prevailing strength threadlocker for heavy-duty applications. Especially well-suited for permanently locking studs and press fit assemblies. Adds 3000 PSI holding power on slip and press fit assemblies. Locks against vibration loosening. Requires extra effort or special tools for removal.

**99671-97** Red 6 ml. Tube. **\$6.95**

### 2. Loctite 290 Threadlocker and Sealant – Green

A penetrating grade threadlocking liquid. Green 290 wicks along the threads of pre-assembled fasteners to secure them in place. Also seals porosities in welds and metal parts. Ideal for fasteners ranging from #2 to 1/2" (2.2 to 12 mm) in size. Localized heating and hand tools are required for disassembly.

**99809-97** Green 6 ml. Tube. **\$7.95**

### 3. Loctite 222 MS Threadlocker and Sealant – Purple

(Formerly 222 Threadlocker) A low strength product that is perfect for small fasteners, #2 to 1/4" diameter (6mm), long engagement length fasteners and components requiring occasional adjustment. This purple threadlocker is applied to threaded parts before assembly. Disassembly possible with hand tools. 222 MS meets MIL-S-46163A.

**99811-97** Purple 6 ml. Tube. **\$7.95**

## I. LOCTITE® 243 THREADLOCKER AND SEALANT – BLUE

Worldwide replacement for 242® Threadlocker. A medium strength, general purpose thread locking adhesive, especially well-suited for fasteners between 1/4" and 3/4" diameter (6 to 20mm). Applied to threaded components before assembly, Blue 243 has controlled lubricity for accurate clamp loads. Disassembly possible with hand tools.

**99642-97** Blue 6 ml. Tube. **\$7.95**

## J. LOCTITE 262 THREADLOCKER AND SEALANT

Loctite 262 is a permanent, high break-away strength product designed for securing fasteners 3/8" to 1" in diameter that must withstand heavy shock, vibration, or extreme chemical or environmental conditions. Localized heating and hand tools are required for disassembly.

**94759-99** 6 ml. Tube. **\$6.95**

## K. LOCTITE® 272

Required to service the caliper pins on '04-later Sportster® models.

**98618-03** 10 ml. Bottle. **\$17.49**  
Fits '04-later XL models.

## L. LOCTITE® AND PIN GREASE

### 1. Loctite 7649 Cleaner / Primer

Use this product to ensure the most performance from Loctite brand thread sealants. Useful on all fasteners. Includes brush in cap and pump sprayer.

**98968-99** 1.75-oz. Bottle. **\$17.95**

### 2. Dow Corning® Moly 44 Brake Pin Grease

The same grease applied at the factory to brake pins is now available as a replacement product to be used with all Harley-Davidson® Brake Pins on Floating Calipers (except '04-later XL models).

**94674-99** 2 cc. Packet. **\$3.50**

I



I. LOCTITE 243 THREADLOCKER AND SEALANT – BLUE

J



J. LOCTITE 262 THREADLOCKER AND SEALANT

K



K. LOCTITE 272

L



L. LOCTITE AND PIN GREASE

Notice: The prices appearing in this catalog are the manufacturer's suggested retail prices. Actual retail prices may vary.



# BODYGUARD IN A BOTTLE

Introducing a breakthrough in powertrain protection – Screamin’ Eagle® SYN3® Full Synthetic Motorcycle Lubricant. For use in engines, transmissions and primary chaincases, it’s just the latest in a line of products formulated specifically to keep your Harley® motorcycle running strong, mile after mile.



## ENGINE OIL FAQ'S

### HOW OFTEN SHOULD I CHANGE MY MOTORCYCLE ENGINE OIL?

You should change your motorcycle engine oil and engine oil filter at the first 1,000-mile service interval and at every 5,000-mile service interval thereafter. If you ride your motorcycle hard, under dusty conditions, or in cold weather, the engine oil and filter should be changed more often. You should always change your engine oil and filter prior to winter storage (or any extended storage) so that your engine oil is clean and free of contaminants for this time period.

### CAN I GO LONGER BETWEEN OIL CHANGES BY CHANGING THE FILTER?

NO! The job of the oil filter is to remove dust, soot and other solid matter. Filters cannot remove water, gasoline or acids and cannot do the job of oil additives that have been used up. You should change your oil filter at the first 1,000-mile service interval and at every 5,000-mile service interval thereafter or prior to winter or extended storage periods.

### WHAT VISCOSITY GRADE SHOULD I USE IN MY HARLEY® MOTORCYCLE?

The recommended viscosity grade for all temperature conditions is SAE 20W50 Harley-Davidson Motor Oil. SAE 10W40 H-D Motorcycle Oil is also available and appropriate for low temperature climates. The SAE 50 H-D Motorcycle Oil is satisfactory in ambient temperatures of 60-80°F, and the SAE 60 H-D Motorcycle Oil in ambient temperatures above 80°F. SAE 20W50 covers the broadest range of operating temperatures.

		SAE 20W50			
0	20	40	60	80	100° F
-18	-6	4	16	27	28° C
SAE 10W40			SAE 50	SAE 60	

## SYN3 ENGINE, PRIMARY AND TRANSMISSION OIL FAQ'S

### WHAT ARE THE KEY BENEFITS TO USING SYN3® MOTORCYCLE LUBRICANT?

- SYN3 Lubricant offers improved film strength for superior wear protection at high temperatures, and improved deposit control for a cleaner engine, transmission, and primary chaincase.
- SYN3 Lubricant can be used in the engine, primary chaincase, and transmission.
- SYN3 Lubricant is formulated for reduced oil consumption, improved wear protection, high-temperature stability, and superior overall field performance.

### WHAT'S THE DIFFERENCE BETWEEN SYNTHETIC AND PETROLEUM-BASED LUBRICANTS?

Both synthetic and petroleum-based lubricants are derived from the same crude oils. But that's pretty much where the similarities end. Unlike their petroleum-based counterparts, which inherit physical components (including contaminants) of the source crude oil in the refining process, synthetic lubricants are manufactured from basestocks that are custom-designed from scratch to have desired properties for specific purposes, meaning that engineers have complete control of the lubricant from start to finish – at the molecular level.

### WHAT DOES SYN3® FULL SYNTHETIC MOTORCYCLE LUBRICANT DO FOR MY DRIVETRAIN?

SYN3® Full Synthetic Motorcycle Lubricant offers all the benefits of Genuine Harley-Davidson® 360 Motorcycle Oil, and:

- Offers superior wear protection at higher temperatures
- Keeps engines, transmissions and primary chaincases cleaner
- Meets the anti-wear lubricity requirements of all transmission gears
- Lubricates all primary chaincase components
- Delivers smooth, sure clutch operation
- Provides long-term protection of all internal components
- Improves seal and gasket performance
- Offers superior performance in high-output engines

### WHEN CAN I START USING SYN3 FULL SYNTHETIC MOTORCYCLE LUBRICANT?

Right away. SYN3® Full Synthetic Motorcycle Lubricant is approved for all stages of engine life, including the first service interval – which means it's not detrimental to engine break-in. You can even use it as a first fill upon delivery of a new motorcycle.

### SINCE SYN3 FULL SYNTHETIC MOTORCYCLE LUBRICANT IS A HIGH-PERFORMANCE LUBRICANT, CAN I WAIT LONGER BETWEEN CHANGES?

No. As with petroleum-based engine lubricants, you should drain and replace the synthetic motorcycle lubricant in your engine at every 5,000-mile service interval. You should also change your oil filter anytime the engine lubricant is changed. If you ride your motorcycle hard, under dusty conditions, or in cold weather, you should change your SYN3® Synthetic Motorcycle Lubricant and oil filter more often. You should always change your engine lubricant and filter prior to any extended storage so that your engine is clean and free of any contaminants during this time.

### TESTED-CERTIFIED SYN3® SERVICE INTERVALS:

#### Primary Chaincase

'84-later Big Twin models with wet-type diaphragm spring clutch. *Every 10,000 miles, or prior to winter or extended storage periods.*

#### Transmission

All Big Twin models. *Every 20,000 miles, or prior to winter or extended storage periods.*

#### Transmission

'70-earlier XL and K models. *Every 10,000 miles, or prior to winter or extended storage periods.*

#### Primary/Transmission

'71-later XL and '83-'84 XR1000 models. *Every 10,000 miles, or prior to winter or extended storage periods.*



A

**A. SCREAMIN' EAGLE SYN3 FULL SYNTHETIC MOTORCYCLE LUBRICANT, SAE 20W50**

**A. SCREAMIN' EAGLE® SYN3® FULL SYNTHETIC MOTORCYCLE LUBRICANT, SAE 20W50**

TESTED-CERTIFIED for use in Harley-Davidson® engine, primary chaincase and transmission applications, Screamin' Eagle® SYN3® Full Synthetic Lubricant makes changing and topping-off fluids a simple one-product process. Developed with a proprietary three synthetic basestock formula, Screamin' Eagle SYN3 Lubricant is formulated to provide for long-term protection and engine cleanliness requirements, and to provide superior high-temperature protection for high-output engines. SYN3 Lubricant is formulated to maintain the coefficient of friction for proper clutch operation and to provide the proper lubrication to the primary chain drive. In addition, SYN3 Lubricant is designed to provide the correct lubricity for the anti-wear requirements of transmission gears and for improved seal protection. This formula is approved by Harley-Davidson for use in all stages of engine life and is not detrimental to the break-in stage of engines.

**99824-03/00QT** Quart. **\$9.95**

Formulated for use in Harley-Davidson Engines, Transmissions and the following Primary Chaincase applications: '71-later XL, '83-'84 XR1000, and '84-later Big Twin models with wet-type diaphragm spring clutch.



NEW

B

**B. SCREAMIN' EAGLE SYNTHETIC BLEND MOTORCYCLE ENGINE OIL – SAE 20W50**

**B. SCREAMIN' EAGLE SYNTHETIC BLEND MOTORCYCLE ENGINE OIL – SAE 20W50**

Screamin' Eagle Synthetic Blend 20W50 motorcycle oil provides all the quality and protection of HD360 mineral-based oil, with the added benefit of improved high-temperature oil stability, improved oil flow at cold engine start-up, and improved viscosity under high engine load. Feel added confidence knowing that Screamin' Eagle Synthetic Blend Motor Oil was tested to Harley-Davidson Motor Company's rigorous standards and certified for use in your Harley-Davidson engine cavity. This oil is approved for use in all stages of engine life, including during engine break-in.

**99813-09** Quart. **\$7.95**

Formulated for use in Harley-Davidson engine cavity only.

**C. GENUINE HARLEY-DAVIDSON® H-D® 360 MOTORCYCLE OIL**

Harley-Davidson Genuine H-D 360 Motorcycle Oil is developed and tested for use in Harley-Davidson® motorcycles. Our unique additive package helps prevent engine wear and helps keep your engine cooler, cleaner, free of sludge, varnish and corrosion.

Harley-Davidson V-Twin motorcycles operate at higher temperatures than water-cooled automobiles, thus a specific high temperature additive package is necessary to protect the engine. Be assured, H-D 360 Oil can be trusted in a Harley-Davidson engine.

Available in SAE 10W40, SAE 20W50, SAE 50, and SAE 60. Refer to your Harley-Davidson owner's manual for the proper SAE grade recommendation based on the climate and temperature range you ride in.



C

**C. GENUINE HARLEY-DAVIDSON H-D 360 MOTORCYCLE OIL**

**99816-1040/00QT** Quart-SAE 10W40. **\$5.95**

**99816-2050/00QT** Quart-SAE 20W50. **\$5.95**

**99816-50/00QT** Quart-SAE 50. **\$5.95**

**99816-60/00QT** Quart-SAE 60. **\$5.95**

**99820-2050/00GL** Gallon-SAE 20W50. **\$23.80**

*Notice: Manufacturer suggested retail prices are subject to change. Please see [harley-davidson.com](http://harley-davidson.com) for the most current manufacturer suggested retail prices on any product listed in this catalog. Actual retail prices may vary.*

# 780 MAINTENANCE

Oil & Lube

## A. FORMULA+ TRANSMISSION AND PRIMARY CHAINCASE LUBRICANT

Developed with a proprietary mineral basestock formula, TESTED-CERTIFIED by Harley-Davidson Motor Company. Formulated to provide lubricity for the anti-wear requirements of transmission gears. Formulated to maintain the coefficient of friction for proper clutch operation and provide adequate lubrication to the primary chain. Approved for use in all stages of transmission and primary chaincase life. Not for use in the crankcase as a motor oil.

### TESTED-CERTIFIED Extended Service Intervals:

#### Primary Chaincase

'84-later Big Twin models with wet-type diaphragm spring clutch. Every 10,000 miles, or prior to winter or extended storage periods.

#### Transmission

All Big Twin models. Every 20,000 miles, or prior to winter or extended storage periods.

#### Primary/Transmission

'71-later XL and '83-'84 XR1000 models. Every 10,000 miles, or prior to winter or extended storage periods.

**99851-05** **\$7.29**

Formulated for use in Harley-Davidson Transmissions and the following Primary Chaincase applications: '71-later XL, '83-'84 XR1000, '08-later XR, and '84-later Big Twin models with wet-type diaphragm spring clutch.

## B. HARLEY-DAVIDSON® FORK OIL

Refer to Owner's Manual for required type.

**99880-73** Type B. 16-oz. Bottle. **\$4.95**

**99884-80** Type E. 16-oz. Bottle. **\$5.95**

## C. SCREAMIN' EAGLE® FORK OIL

### Performance

A heavier blended oil that provides extra damping in performance applications.

**99881-87** 16-oz. Bottle. **\$4.95**

### Racing

Designed and blended for the severe conditions on the race track. Not intended for street use.

**99909-93R** 16-oz. Bottle. **\$5.95**



A. FORMULA+ TRANSMISSION AND PRIMARY CHAINCASE LUBRICANT



B. HARLEY-DAVIDSON FORK OIL



C. SCREAMIN' EAGLE FORK OIL

Notice: The prices appearing in this catalog are the manufacturer's suggested retail prices. Actual retail prices may vary.



D

D. DOT 5 BRAKE FLUID



E

E. DOT 4 BRAKE FLUID

**D. DOT 5 BRAKE FLUID**

For use in all models (except '06-later VRSC™, '07-later XL, '08-later XR, '06-later Dyna® and Softail®, and '05-later Touring models).

<b>99902-77</b>	12-oz. Bottle.	<b>\$12.95</b>
<b>99901-77</b>	1 Gallon. (not shown)	<b>\$129.95</b>

**E. DOT 4 BRAKE FLUID**

For use in all '06-later VRSC, '07-later XL, '08-later XR, '06-later Dyna and Softail, and '05-later Touring models.

<b>99953-99A</b>	12-oz. Bottle.	<b>\$6.95</b>
------------------	----------------	---------------

**F. CHAIN LUBE PLUS**

High performance chain lube cleans as it protects. Can also be used on O-ring chains.

<b>99865-81A</b>	12-oz. Aerosol can.	<b>\$7.95</b>
------------------	---------------------	---------------

**G. GENUINE HARLEY-DAVIDSON® EXTENDED LIFE ANTIFREEZE AND COOLANT**

Formulated for the high-performing Revolution® engine, this antifreeze is pre-diluted with deionized water to eliminate cooling system contamination. Formulated to use at full strength (do not add water), this coolant provides exceptional heat transfer properties. Protects the entire cooling system against corrosion. Formula is silicate-free, phosphate-free, nitrate-free and borate-free. One gallon container.

<b>99822-02</b>	Fits '02-later VRSC models.	<b>\$19.95</b>
-----------------	-----------------------------	----------------

**H. HARLEY-DAVIDSON® HIGH-PERFORMANCE SEALANT – GRAY**

High-performance, room temperature vulcanized (RTV) silicone type liquid gasket is a low-odor, non-corrosive and non-conductive sensor-safe formula. Sealant allows high elongation when cured to absorb thermal and dynamic movement of the mating surfaces and is resistant to most chemicals and solvents. Temperature Range -76°F to 482°F (-60°C to 250°C). Approved for use as crankcase sealant on all Harley-Davidson powertrains.

<b>99650-02</b>	1.9-oz. (54g) tube.	<b>\$12.95</b>
-----------------	---------------------	----------------

**I. ELECTRICAL CONTACT LUBRICANT**

Ideal for use on multi-pin connectors, bulb bases, and battery terminals, this specially formulated Electrical Contact Lubricant offers excellent film strength that is resistant to water (including salt water). Prevents fretting corrosion in connectors that often occurs with temperature variations and vibration. Safe for use on tin, nickel, copper, brass, gold and silver contacts, the formula is compatible with electrical connector plastics and elastomers.

<b>99861-02</b>	1-oz. squeeze tube.	<b>\$12.95</b>
-----------------	---------------------	----------------



F

F. CHAIN LUBE PLUS



G

G. GENUINE HARLEY-DAVIDSON EXTENDED LIFE ANTIFREEZE AND COOLANT



H

H. HARLEY-DAVIDSON HIGH-PERFORMANCE SEALANT – GRAY



I

I. ELECTRICAL CONTACT LUBRICANT

Notice: The prices appearing in this catalog are the manufacturer's suggested retail prices. Actual retail prices may vary.



# 782 MAINTENANCE

## Oil & Lube

### A. WINTER IDLE BOOST

Formulated to reduce drivability problems, such as erratic idle and lack of power, which may occur during high humidity/low temperature riding conditions. NOTE: this product is not intended for fuel storage. Convenient metered dispensing bottle treats 16 gallons of fuel.

**99889-91A** 4-oz. Bottle. **\$5.95**

### B. GENUINE FUEL ADDITIVE

Formulated with Duralt® Fuel Compound which permits the use of lower octane fuels.

- Reduces octane requirement increase that normally occurs with mileage.
- Controls the formation of combustion chamber deposits.
- Lubricates upper cylinder and inhibits corrosion.
- Cleans fuel system.
- Improves fuel storage stability.
- Convenient metered dispensing bottle treats 40 gallons of fuel.

**99893-91A** 4-oz. Bottle. **\$6.95**

### C. BEARING GREASES

#### Special Purpose Grease

Factory Lubricant for '97-later Softail® and Dyna® steering head bearings. Do not use on wheel bearings.

**99857-97** 14-oz. Standard Grease Gun Cartridge. **\$9.95**

#### Wheel Bearing Grease

Recommended for wheel bearings, steering head bearings (other than '97-later Softail and Dyna) and rear swingarm bearings.

**99855-89** 1-lb. Can. **\$8.95**

**99856-92** 14-oz. Standard Grease Gun Cartridge. **\$7.95**

#### Poly-Oil (not shown)

Recommended for the engine compensator sprocket on primary belt drive models.

**99860-81** 2-oz. Tube. **\$3.95**

#### Hi-Temp Grease (not shown)

Recommended for use on the circuit breaker ignition cam, cam shaft, and advance mechanism.

**99862-72** 1/3-oz. Tube. **\$1.95**

### D. AEROSOL LUBES AND CLEANERS

#### 1. PJ1® Super Cleaner

**99878-87T** 13-oz. Aerosol can. **\$7.95**

#### 2. PJ1 Blue Label Chain Lube

**99875-86T** 5-oz. Aerosol can. **\$6.95**

#### Brake/Parts Cleaner (not shown)

**94564-98** 19-oz. Aerosol can. **\$6.95**

### E. HARLEY® LUBE

Harley Lube is a Harley-Davidson approved general lubrication oil that is perfect for lubricating clutch cables, Tour-Pak® hinges, hand levers, footboards, footpegs, and windshield clamps. Handy needle dispenser for precision application.

**94968-09** Universal. **\$5.95**

### F. SCREAMIN' EAGLE ASSEMBLY LUBE

Screamin' Eagle Assembly Lube provides superior protection during installation or servicing of internal engine components. Formulated with a high tackifier, this lubricant clings to parts and provides excellent start-up and break-in protection. It provides excellent corrosion resistance, and it won't drip off like common oil when you set coated parts aside to work on the rest of the engine. That's why we use it on all of our test engines. Don't start your re-built or serviced engine without it. Recommended applications: cams, gears, crankpins, piston wrist pins, oil pumps, valve guides, rocker arm and push rod tips, and roller tappet wheels.

**94971-09** Universal. **\$9.95**



A. WINTER IDLE BOOST



B. GENUINE FUEL ADDITIVE



C. BEARING GREASES



D. AEROSOL LUBES AND CLEANERS



E. HARLEY LUBE



F. SCREAMIN' EAGLE ASSEMBLY LUBE

Notice: The prices appearing in this catalog are the manufacturer's suggested retail prices. Actual retail prices may vary.

G

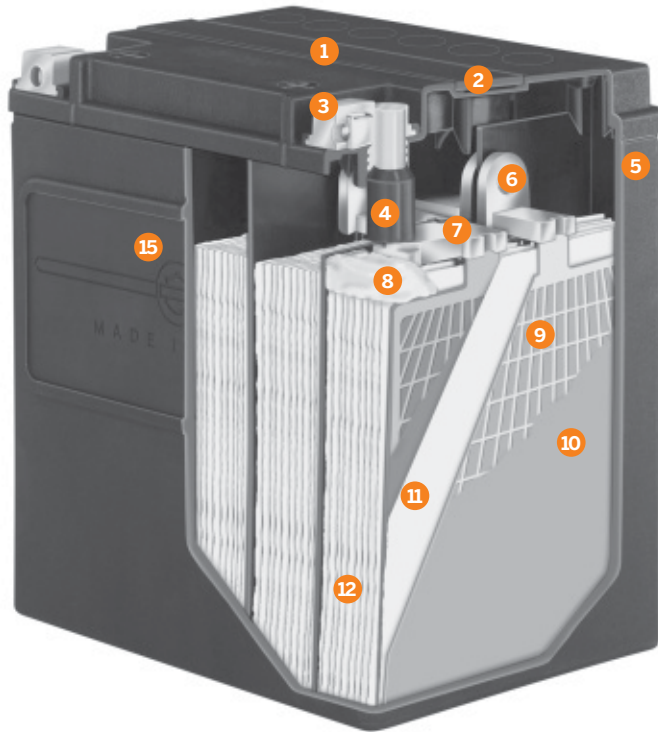

Motorcycle batteries built and rigorously tested to Harley-Davidson's exacting requirements. H-D® AGM battery ratings are determined by the strict regulations and testing of the Battery Council International.

## G. H-D® AGM\* ORIGINAL EQUIPMENT BATTERIES\*

Genuine H-D® Batteries offer the latest technology for higher cold cranking amps, long life and improved rechargeability. Featuring the latest AGM technology and great Harley-Davidson® graphics, these batteries are durable, long-lasting and trouble-free. Made in the U.S.A.

- 1 Completely sealed, valve regulated maintenance-free design eliminates acid spills and corrosion damage.
- 2 Re-engineered vent system is specially designed to minimize leakage.
- 3 Exclusive molded terminal design increases strength and durability.
- 4 Unique positive post bushing resists vibration damage and retards acid leaks and corrosion.
- 5 Heat sealed cover prevents electrolyte leakage and improves reliability.
- 6 Larger diameter through-partition welds direct more power to the starting motor.
- 7 Heavy top lead improves plate-to-lug adhesion for vibration resistance and long life.
- 8 Plates are lock-bonded together, reducing vibration damage for longer life.
- 9 Exclusive calcium/calcium alloy grids provide highest cranking amps and lowest self-discharge. Full frame, power path design directs more power to the terminals for quick, sure starts.
- 10 High density oxide provides maximum power-per-pound or dependable "high cycling" service.
- 11 Tear-resistant AGM\* separators protect plates, ensuring long life.
- 12 Exclusive demineralized electrolyte improves service life. Metered addition of electrolyte means no excess acid.
- 13 Positive terminal protector (*not shown*) protects against short circuits and sparks.
- 14 Stainless steel terminal bolts (*not shown*) won't rust or corrode.
- 15 Distinguished Harley-Davidson Bar & Shield is molded into case, for quick, confident recognition.

\*Absorbed Glass Mat

**65989-97C** Dual (Top and Side) Terminal Design. **\$99.95**  
Fits '97-'03 XL models, '97-later Dyna® and Softail® and '07-later VRSC (except '07 VRSCR) models.

**66010-97C** Dual (Top and Side) Terminal Design. **\$129.95**  
Fits '97-later FLHR, FLHT, and FLTR Touring models.

**65948-00A** **\$89.95**  
Fits '02-'06 VRSC™ and '07 VRSCR models.

**65958-04A** Fits '04-later XL and XR models. **\$89.95**

**65991-82B** **\$99.95**  
Fits '73-'94 electric start FX and FXR; '77-'78 XLCR, '79-'96 XL models; '84-'90 Softail models; '99-'00 FXR models. Replaces P/Ns 65991-82A and 65991-75C.

**66010-82B** **\$109.95**  
Fits '80-'96 FLHR, FLHT, and FLT Touring models.

**65989-90B** Fits '91-'96 Dyna and Softail models. **\$99.95**

NOTE: Battery dimensions of Harley-Davidson AGM Batteries P/Ns 65989-97A, 65989-90B and 65991-82B may not allow use of accessory side covers on XL and Dyna models.

### CONVENTIONAL BATTERIES\* (*not shown*)

**66006-29F** 6V. **\$69.95**  
Fits '64-earlier FL and '63-earlier GE models.

**66006-70** 12V. **\$44.95**  
Fits '70-later kickstart FX, and XLCH models.

### HEAVY-DUTY HIGH-CRANKING PREMIUM BATTERY\*

**66007-84** 12V. **\$104.95**  
Fits '65-'84 FL, FLH; '67-'78 XLH (except '77-'78 XLCR); '64-later GE models.

### FILLER GAPS

**66031-91** Green. **\$60**  
**66032-91** Yellow. **\$30**

**OBSOLETE**



## G. H-D AGM ORIGINAL EQUIPMENT BATTERIES



**\*WARNING:** Battery posts, terminals and related accessories contain lead compounds, chemicals known to the State of California to cause cancer and birth defects.

Notice: Manufacturer suggested retail prices are subject to change. Please see [harley-davidson.com](http://harley-davidson.com) for the most current manufacturer suggested retail prices on any product listed in this catalog. Actual retail prices may vary.

# 784 MAINTENANCE

## Oil Filters

### A. SUPERPREMIUM5™ OIL FILTER – 5 MICRON

Utilizing advances in synthetic media technology, the SuperPremium5™ Oil Filters are Tested-Certified to provide filtration to retain dust, soot and other solid matter with low internal pressure drop. Filter also includes internal pressure relief and anti-drain back valves.

Fits '99-later Twin Cam and Evolution® models, and can be used as an upgrade for any motorcycle that requires Oil Filter P/N 63796-77A, 63805-80A, 63812-90 or 63813-90.

<b>63798-99A</b>	Chrome.	<b>\$13.95</b>
<b>63731-99A</b>	Black.	<b>\$8.95</b>

### SuperPremium10™ Oil Filter – 10 Micron (not shown)

Fits '02-later VRSC models.

<b>63793-01K</b>	Black.	<b>\$8.95</b>
------------------	--------	---------------

### B. GENUINE HARLEY-DAVIDSON® OIL FILTERS

Consist of cured resin impregnated paper which removes harmful foreign particles from the oil. Metal end caps and thermal setting adhesive provide positive seals, preventing bypassing of contaminant-laden oil. Made in the U.S.A.

#### Spin-On

Fits '91-'98 Dyna models.

<b>63812-90</b>	Black, Extra Long.	<b>\$7.95</b>
<b>63813-90</b>	Chrome, Extra Long.	<b>\$12.95</b>

Fits late '82-'84 FLH-80 Classics, '82-'86 FXWG, FXSB, FXEF, '79-early '84 XL models.

<b>63782-80</b>	Chrome, Short.	<b>\$9.95</b>
<b>63810-80A</b>	Black, Short.	<b>\$6.95</b>

Fits '80-'98 FLT, FLHT, FLHR, '82-'94 FXR, '84-'98 Softails, '84-'95 FXRP, FLHTP, late '84-later XL and '08-later XR models.

<b>63796-77A</b>	Chrome, Long.	<b>\$9.95</b>
<b>63805-80A</b>	Black, Long.	<b>\$6.95</b>

#### Element

**63835-87T** In Oil Tank Cartridge.  
Fits '53-early '82 FL, FLH-80 Classics, '71-early '82 FX, '54-'78 KH, XL, and XLH models.

<b>63840-48A</b>	External type.	<b>\$9.95</b>
------------------	----------------	---------------

Fits '41-'64 FL models.

### CLASSIC MOTOR PARTS OIL FILTERS (not shown)

Quality filters at a great price.

<b>63837-92T</b>		<b>\$6.95</b>
------------------	--	---------------

Perf-form™ cartridge replaces P/N 63840-53 or 63835-87T with a cartridge type filter and spring.

<b>63813-90T</b>	Chrome, Spin-On, Extra Long.	<b>\$8.95</b>
------------------	------------------------------	---------------

Fits '91-'98 Dyna models. Low restriction.  
**63782-80T** — Chrome, Spin-On, Short.  
Fits '79-early '84 XL and late '82-'86 FL and FX models (except Softail® and FXR). Low Restriction.

<b>63796-77T</b>	Chrome, Spin-On, Long.	<b>\$7.95</b>
------------------	------------------------	---------------

Fits '80-'98 FLT, '82-'94 FXR, '84-'98 Softail, late '84-later XL and '08-later XR models. Low Restriction.



A. SUPERPREMIUM5 OIL FILTERS

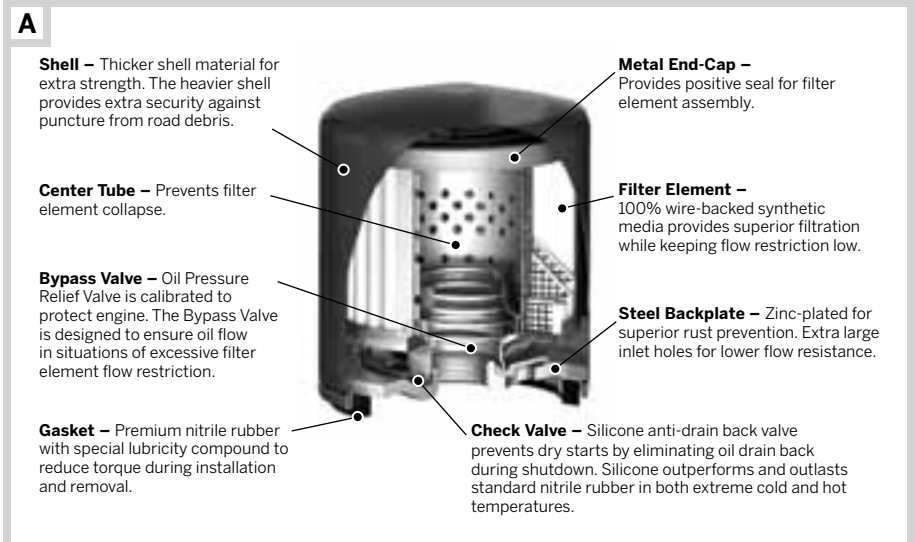

A. SUPERPREMIUM5 OIL FILTERS



B. GENUINE HARLEY-DAVIDSON OIL FILTERS

Notice: The prices appearing in this catalog are the manufacturer's suggested retail prices. Actual retail prices may vary.

C

## C. HARLEY-DAVIDSON® ORIGINAL EQUIPMENT AIR FILTER ELEMENTS

Late-model pleated paper type elements with aluminum backplates.

<b>29331-04</b>	Fits '04-later XL models.	<b>\$31.95</b>
<b>29377-08</b>	Fits '08-later XR models.	<b>\$26.95</b>
<b>29437-01</b>	Fits '02-later VRSC™ models.	<b>\$44.95</b>
<b>29461-99</b>	Fits '99-'06 carbureted Twin Cam-equipped models, '01-later EFI Softail® models (except FLSTSB) and '02-'07 EFI Touring and Dyna models.	<b>\$22.95</b>
<b>29633-08</b>	Fits '08-later Touring models.	<b>\$24.95</b>
<b>29191-08</b>	Fits '08-later Dyna models.	<b>\$24.95</b>
<b>29314-08</b>	Fits '08-later FLSTSB models.	<b>\$27.40</b>
<b>29462-99</b>	Fits '99-'01 EFI Twin Cam models (except '01 Softail models).	<b>\$25.95</b>
<b>29330-96</b>	Fits '96-'00 Evolution® 1340 models with carburetors.	<b>\$22.95</b>
<b>29291-95</b>	Fits '95-'99 Evolution 1340 models with electronic fuel injection (EFI).	<b>\$26.95</b>
<b>29259-91A</b>	Fits '91-'95 Evolution 1340 FLT, FLHT, FLHR, Softail® models, Dyna® models, and FXR models.	<b>\$22.95</b>
<b>29331-96</b>	Fits '88-'03 Evolution XL® models.	<b>\$24.95</b>
<b>29036-86</b>	Fits '86-'87 Evolution XL models.	<b>\$12.95</b>
<b>29259-89</b>	Fits '90 Evolution 1340 models.	<b>\$16.95</b>
<b>29259-86</b>	Fits '86-'89 Evolution 1340 models.	<b>\$12.95</b>
<b>29259-83A</b>	Fits '84-'85 Evolution 1340 Softail and FXR models.	<b>\$12.95</b>
<b>29036-72</b>	Fits '66-early '73 and '83-'85 XL, '71-early '75 FX, '67-early '75 FLH models.	<b>\$12.95</b>
<b>29255-78</b>	Fits '79-'82 XL, '82-'83 FXR, '80-'82 FLT, late '78-'84 FX/FLH models.	<b>\$12.95</b>
<b>29325-95A</b>	Fits '95-'03 Evolution XL and Evolution 1340 models. (International models only. See your Dealer.)	<b>\$24.95</b>

## D. K&N® AIR FILTER CARE PRODUCTS

**K&N Filter Care Service Kit** (not shown)

**99850-92T** Complete kit to clean and re-oil K&N-type air filters. Includes one 12-oz. bottle Air Filter Cleaner and one 6.5-oz. aerosol Air Filter Oil. **\$12.95**

**K&N Air Filter Oil**

**99882-88T** 12-oz. Aerosol. **\$8.95**

**K&N Air Filter Cleaner**

**99883-88T** 32-oz. with Sprayer. **\$11.95**

Notice: The prices appearing in this catalog are the manufacturer's suggested retail prices. Actual retail prices may vary.



C. HARLEY-DAVIDSON ORIGINAL EQUIPMENT AIR FILTER ELEMENTS

D



D. K&N AIR FILTER CARE PRODUCTS



# 786 MAINTENANCE

## Spark Plugs

### A. HARLEY-DAVIDSON® DOUBLE PLATINUM SPARK PLUGS

Double Platinum spark surfaces offer superior erosion resistance even after millions of sparks. H-D® Double Platinum plugs also feature a semiconductor suppressor, a triple-coated shell with special anti-seize coating, copper core center electrode for high thermal capacity and peak performance at all engine speeds, tapered center and platinum side electrodes for maximum combustibility. Special high alumina insulator provides self-adjusting temperature for maximum resistance to fouling. Harley-Davidson's longest lasting spark plugs.

**32364-04** (6R12PP) **\$7.95 each**  
Fits '86-later Evolution-equipped XL® models and '99-later Twin Cam-equipped models.

**32334-05** (10R12APP) **\$7.95 each**  
Fits '02-later VRSC models.

### B. HARLEY-DAVIDSON® GOLD SPARK PLUGS

A special thread and shell coating ensures quick and easy removal from aluminum heads and resists corrosion. A gold palladium insert extends life and improves resistance to corrosion. The tapered tip provides better spark exposure to air/fuel mixture and allows the mixture to flow more easily through gap area for maximum combustibility. Fouling resistance is improved with smaller diameter center electrode wire and insulator tip. Plus, a copper-cored ground electrode runs cooler for extended life.

**32365-04** (6R12G) **\$4.95 each**  
Fits '86-later XL and '99-later Twin Cam-equipped models or use in place of No. 6R12.

**32366-04** (4R5G) **\$4.95 each**  
Fits '71-'85 Sportster models or use in place of Nos. 3, 4R and 4R5.

**32367-04** (5R6AG) **\$4.95 each**  
Fits '75-'00 Shovelhead and Evolution 1340-equipped models or use in place of Nos. 5R6A and 5RL.

**32331-05** (10R12AG) **\$4.95 each**  
Fits '02-later VRSC™ models.

**27794-08** (10R12X) **\$4.95 each**  
Fits '08-later XR models.

### C. HARLEY-DAVIDSON ORIGINAL EQUIPMENT SPARK PLUGS

**32335-04** (10R12A) **\$3.95 each**  
Fits '02-later VRSC models.

**32342-04** (5R6A) **\$3.95 each**  
Fits '75-'00 Shovelhead and Evolution 1340-equipped models.

**32362-04** (6R12) **\$3.95 each**  
Fits '86-later Evolution-equipped XL models and '99-later Twin Cam-equipped models.

**32343-04** (5RL) **\$3.95 each**  
Fits '75-'84 Shovelhead 1200/1340-equipped models.

**32338-04** (4R5) Fits '71-'85 Iron Sportster. **\$3.95 each**

**32336-04** (4R) **\$3.95 each**  
Fits '54-'56 KH, '57-'70 XL-900, '71-'85 Iron Sportster, '48-'74 FLH/FX.

**32337-04** (3-4) Fits '48-'74 FLH/FX. **\$3.95 each**

**32339-04** (3) **\$3.95 each**  
Fits '48-'74 FLH/FX, '54-'56 KH, '57-'78 Iron Sportster.



A. HARLEY-DAVIDSON DOUBLE PLATINUM SPARK PLUGS



B. HARLEY-DAVIDSON GOLD SPARK PLUGS



C. HARLEY-DAVIDSON ORIGINAL EQUIPMENT SPARK PLUGS

Notice: The prices appearing in this catalog are the manufacturer's suggested retail prices. Actual retail prices may vary.

NEW

D



## D. SCREAMIN' EAGLE ST PERFORMANCE SPARK PLUG



Screamin' Eagle ST Spark Plugs feature double platinum coating for superior erosion resistance and extended life. The "V" trimmed ground electrode reduces shrouding of the flame front to promote flame propagation, and the fine wire center electrode enhances start ups and ignitability. Screamin' Eagle ST Plugs feature Ribbed Core Technology (RCT) that provides resistance to fouling, and are designed with Original Equipment-style noise suppression to prevent electrical interference with radios and CB communication equipment. Works great with racing applications where rich air fuel conditions are required. Unique style with Screamin' Eagle logo. (Sold in packages of two.)

### High Compression Applications

These plugs are designed for high performance applications involving modifications in high flow air cleaners, cam shafts, exhaust, performance heads, ignition components, higher compression ratios above Original Equipment configurations or engines specific for racing applications.

**32186-10** **\$15.95**

Fits '99-later Twin Cam-equipped models, '86-later XL and XR models, and 1340 Evolution models equipped with Screamin' Eagle Performance Cylinder Heads.

**32188-10** **\$15.95**

Fits '84-'99 Evolution 1340-equipped models, '75-'81 Shovelhead 74 and 80ci, and '83-'84 XR1000 models.

### Stock Compression Applications

Designed for modified engines including performance carburetors, high-flow air cleaners, cam shafts, exhaust systems and ignition systems in conjunction with stock compression ratios.

**32187-10** **\$15.95**

Fits '72-'85 XL1000 (except XR1000).

**32189-10** **\$15.95**

Fits '84-'99 Evolution® 1340-equipped models, '75-'81 Shovelhead 74 and 80ci models.

**32192-10** **\$15.95**

Fits '99-later Twin Cam-equipped models, and '86-later Evolution Sportster 883, 1100 and 1200 models.

*Notice: The prices appearing in this catalog are the manufacturer's suggested retail prices. Actual retail prices may vary.*

D. SCREAMIN' EAGLE ST PERFORMANCE SPARK PLUG

**Terminal construction** ensures solid watertight connection with standard or performance spark plug wires.

**Plated jacket** helps prevent corrosion in harsh weather and temperature conditions.

**RCT (Ribbed Core Technology)** provides improved resistance to plug fouling. The rib's proximity promotes spark discharge to the shell on plugs that are starting to foul, allowing the air/fuel charge in the cylinder to ignite and clear the plug.

**"V-trimmed" ground electrode** reduces shrouding to promote flame propagation.

**Built-in suppressor/resistor** reduces radio noise and interference.

**Fine Wire Center Electrode** promotes ignitability and enhances start up.

**Platinum pads** on both electrodes reduce gap erosion for longer plug life.

## MICHELIN® TIRES

Since 1889, Michelin® has been a leader in the tire industry. From introducing the world's first radial tire in 1946, to being the first to use radial motorcycle tires in race competition, Michelin has demonstrated its dedication to producing some of the world's most innovative tire products. A leader in racing technology, Michelin researches, tests, and develops tire solutions in the most demanding form of racing competition. Harley-Davidson® motorcycle riders benefit from that technology, as Michelin transfers track technology into Harley-Davidson motorcycle riding confidence and performance.

*Harley-Davidson has tested and certified the following tires for use on the listed fitments.*

**43258-07A** **\$119.95**  
19" Front – Scorcher 100/90-19 Blackwall with "Harley-Davidson" script. Fits '10 Dyna® models (except FXDF, FXDFSE and FXDWG models).

**43250-07A** **\$189.95**  
17" Rear – Scorcher 160/70-17 Blackwall with "Harley-Davidson" script. Fits '10 Dyna models (except FXDF, FXDFSE and FXDWG models).

**43304-07** **\$111.95**  
21" Front – Commander MH90-21 Blackwall. Fits '95-'05 FXST, FXSTC, FXSTB, FXSTS, '00-'07 FXSTD (except '04 FXSTDSE2), '06-'08 FXDWG and '04-'09 XL 883/1200 Custom models.

**40159-10** **\$115.95**  
19" Front – Commander 100/90-19 Blackwall. Fits '02-'10 Dyna (except FXDWG, '07-'08 FXDSE, '08-'10 FXDF) and '04-'10 XL (except Custom and XR1200) models.

**43303-07** **\$132.95**  
16" Front – Commander MT90B16 Blackwall. Fits '81-'08 FL Touring, '81-later FLSTC, FLSTF, FLSTN, FLSTS models (except '07-'08 FLHRSE, '07-later FLSTF and '05-later FLSTN). Also fits '81-'08 CLE/TLE/ Ultra Sidecar.

**43288-07** **\$156.95**  
16" Rear – Commander MT90B16 Blackwall. Fits '81-'03 FL Touring, FLSTC, FLSTF, FLSTS (except '03 FLSTS), '95-'02 FXSTC and FXSTS models.

**43284-07** **\$162.95**  
16" Rear – Commander MU85B16 Blackwall. Fits '04-'08 FL Touring (except '07-'08 FLHRSE) and '05-'10 FLSTN models.

**43252-07** **\$157.95**  
16" Rear – Commander 150/80-16 REINF Blackwall. Fits '02-'05 Dyna, '03-'05 Softail® (except FXSTD, FLSTS, FLSTN), '06-'10 FLSTC and '04-'10 XL models (except XR1200).

**40158-10** **\$183.95**  
17" Rear – Macadam 50 160/70-17 Blackwall. Fits '00-'07 FXSTD (except '04 FXSTDSE2) and '06-'10 Dyna (except '07-'08 FXDSE, '08-later FXDF) models.

NOTE: Harley-Davidson recommends the use of approved Michelin® and Dunlop® Tubes and Rim Bands.

### Michelin Inner Tubes

**41314-10** **\$27.95**  
17" Center Metal Valve. Fits 17" 160/70-17 and 180/60-17 tires and rims with Center Valve.

**41316-10** **\$26.95**  
19" Center Metal Valve. Fits 19" 100/90-19 tires and rims with Center Valve.

### Michelin Rim Bands

**41319-10** **\$3.95**  
4.5" x 17/18". Fits 17" Center Valve rims.

**41323-10** **\$3.95**  
1.6/2.0" x 18/19". Fits 19" Center Valve rims.

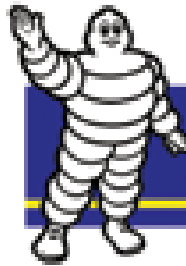

# MICHELIN



## COMMANDER TECHNICAL FEATURES

- 1 Aramid belts help control the centrifugal growth of the rear tire, for a consistent contact patch, excellent traction and even wear.
- 2 Rayon casing plies for a compliant ride and surefooted handling.
- 3 Tread pattern helps promote efficient water evacuation, even wear, and resistance to wandering over rain grooves.
- 4 Three casing plies for strength and durability.



**WARNING:** Use only Harley-Davidson approved tires. See a Harley-Davidson dealer. Using non-approved tires or mixing approved tires from different manufacturers on the same motorcycle, can adversely affect stability, which could result in death or serious injury.

*Notice: Manufacturer suggested retail prices are subject to change. Please see harley-davidson.com for the most current manufacturer suggested retail prices on any product listed in this catalog. Actual retail prices may vary.*



**21" Commander  
MH90 Front**

**19" Commander  
100/90 Front**

**16" Commander  
MT90B Front**

**16" Commander  
MT90B Rear**

**16" Commander  
MU85B Rear**

**16" Commander  
150/80 Rear**

### COMMANDER® TIRES

With their easy-steering profile, ultra-comfortable highway ride and distinctive styling, Michelin® Commander® tires combine a custom look with superb handling and precise steering. Yet Commander® tires help deliver the long mileage that serious riders expect.

- Rayon carcass plies instead of more-common polyester, for a remarkably compliant ride and stable handling.
- Kevlar® belts in rear Commander® tires, instead of less-costly fiberglass. Kevlar® helps control the centrifugal growth of the tire, promoting a large contact patch, excellent traction and even wear. Kevlar is a registered trademark of DuPont.
- High-density cord count in rear Commander® tires helps inhibit deformation of the casing.
- Unique tread pattern combines good looks with excellent water evacuation, even wear patterns, and resistance to wandering over rain grooves.
- Superb wet and dry grip.
- Remarkably stable and comfortable ride.



**19" Scorcher  
100/90 Front**

**17" Scorcher  
160/70 Front**

**17" Macadam 50  
160/70 Rear**

### MICHELIN® – HARLEY-DAVIDSON SCORCHER TIRES

The Scorcher is the first Michelin – Harley-Davidson co-branded tire. Featuring an exceptional combination of durability, comfort and handling, the Scorcher is factory-installed on many 2010 Dyna models, and can be installed as a replacement tire on other specified models. Tire features bold "Harley-Davidson" script on the sidewall.

### MACADAM® 50 TIRES

The Harley-Davidson approved Macadam® 50 tire offer riders excellent handling and uniform wear.

The 160/70-17 rear Macadam 50 tire was developed and approved specifically for the Harley-Davidson® Dyna® range of bikes, including certain Wide Glide®, Super Glide®, Low Rider® and Street Bob® models. Renowned for their durability and wet grip, Macadam 50 tires offer European-made quality and the reassurance that comes with Harley-Davidson approved fitment.



# 790 MAINTENANCE

## Tires

### DUNLOP® TIRES

Since 1984, DUNLOP Tires has provided Original Equipment and service replacement tires for Harley-Davidson® Motorcycles. DUNLOP is recognized as the world-leader in motorcycle tire design, engineering and manufacturing excellence.

Please refer to the tables on page 792 for proper fitment.

## **DUNLOP® HARLEY-DAVIDSON®** **T I R E S E R I E S**

### D407/D408 TOURING

The D407/D408 tire is constructed for '09-later FL Touring, select Softail, and specific Custom Vehicle Operations™ (CVO) models, and is available exclusively through Harley-Davidson Dealers. The rear tires feature Dunlop's advanced MT (Multi-Tread) technology.

- Tire features bold "Harley-Davidson" script on the sidewall.
- MT Multi-Tread rear tire incorporates a tough tread compound in the center that runs cooler to provide stability, excellent traction under braking and long life, and to each side is a section of lateral-grip compound that enhances traction at higher lean angles for great grip while cornering.
- Reinforced multi-layer tire carcass gives the tire strength for long life and provides stability at highway speeds and maximum lean angles.
- Bold, angled lateral grooves in the tread pattern evacuate water from the contact patch on wet roads.
- The D407/408 is available in blackwall, slim white-bar and wide-white sidewall styles.



**D407/D408 Touring Slim White Wall**

NOTE: Harley-Davidson recommends the use of approved Michelin® and Dunlop® Tubes and Rim Bands.



**WARNING:** Use only Harley-Davidson approved tires. See a Harley-Davidson dealer. Using non-approved tires or mixing approved tires from different manufacturers on the same motorcycle, can adversely affect stability, which could result in death or serious injury.

Notice: Manufacturer suggested retail prices are subject to change. Please see [harley-davidson.com](http://harley-davidson.com) for the most current manufacturer suggested retail prices on any product listed in this catalog. Actual retail prices may vary.



**D402  
Blackwall**



**D402  
Wide Whitewall**



**D402  
Engraved Wide Whitewall**

**D402 TOURING**

Built with a three-ply polyester casing with two fiber-glass belts, the D402 offers greater load-carrying capacity and stability.

- Computer-optimized tread profile with offset center groove improves rider confidence over rain grooves and steel-grated bridges, while reducing cupping for even wear.
- The D402 is available in blackwall, slim white-bar and wide-white sidewall styles.



**D401  
Blackwall**

**D401 CRUISER**

An advanced tread pattern and specifically formulated compound deliver outstanding grip in wet or dry weather and provide long tire life.

- D401 tires use bias or bias-belted construction and incorporate a computer-optimized tread profile to reduce cupping for even wear.



**GT502  
Blackwall**

**GT502 PERFORMANCE**

GT502 Performance Tires feature an optimized profile, contact patch and compound for superior grip in dry conditions, with solid grip during wet weather riding conditions.

**DUNLOP® TUBES**

Part Number	Price	Descriptions
<b>40558-82</b>	<b>\$27.95</b>	16-inch, MT/MU90-16 Side Metal Valve.
<b>40575-05</b>	<b>\$28.95</b>	16-inch, MT/MU90-16 Center Metal Valve. For Smooth Profile Laced Wheels.
<b>40592-09</b>	<b>\$27.95</b>	16-inch, 180/65-16 Center Metal Valve.
<b>40593-09</b>	<b>\$26.95</b>	17-inch, 130/80-17 Center Metal Valve.
<b>40502-06</b>	<b>\$27.95</b>	17-inch, 160/70-180/60-17 Center Metal Valve.
<b>41491-08</b>	<b>\$39.95</b>	17-inch, 200/55R17 Radial Center Metal Valve.
<b>41188-06</b>	<b>\$23.95</b>	19-inch, MJ/MM90-19 Center Metal Valve with Adapter Ring to fit Center Rubber Valve Rims.
<b>41007-07</b>	<b>\$32.95</b>	19-inch, 120/70R19 Radial Center Metal Valve.
<b>43140-80</b>	<b>\$23.95</b>	21-inch, MH90-21 Center Metal Valve.

**DUNLOP RIM BANDS**

Part Number	Price	Descriptions
<b>43164-05</b>	<b>\$2.95</b>	Fits 16-inch Center Valve Rims. For Smooth Profile Laced Wheels.
<b>43147-40</b>	<b>\$2.95</b>	Fits 16-inch, MT90-16 Side Valve Rims.
<b>43099-09</b>	<b>\$2.95</b>	Fits 16-inch, 180/65-16 Center Valve Rims.
<b>43101-06</b>	<b>\$3.95</b>	Fits 17-inch Center Valve Rims.
<b>40916-08</b>	<b>\$7.95</b>	Fits 17-inch Center Valve Radial Rims.
<b>43341-09</b>	<b>\$3.95</b>	Fits 17-inch, 130/80-17 Center Valve Rims.
<b>43145-47</b>	<b>\$2.95</b>	Fits 19-inch Center Valve Rims.
<b>41996-07</b>	<b>\$2.95</b>	Fits 19-inch Center Valve Radial Rims.
<b>43939-89</b>	<b>\$2.95</b>	Fits 21-inch Center Valve Rims.

*Notice: Manufacturer suggested retail prices are subject to change. Please see harley-davidson.com for the most current manufacturer suggested retail prices on any product listed in this catalog. Actual retail prices may vary.*

# 792 MAINTENANCE

## DUNLOP® • HARLEY-DAVIDSON® PERFORMANCE TIRES

Part Number	Price	Descriptions	Model Fitment
<b>40554-04</b>	<b>\$130.95</b>	19" Front, GT502F 100/90-19 Blackwall	'00-'01 FXDX, '02-later Dyna (except FXDWG, '07-later FXDSE, '08-later FXDF), '96-'03 XL1200 Sport, '04-later XL (except Custom and XR1200). Installation on '04-later XL models requires installation of matching GT502 Rear Tire P/N 40555-04.
<b>43117-09</b>	<b>\$134.95</b>	21" Front, GT502F 80/90-21 Blackwall	'96-'10 XL883C, XL1200C, '93-'10 FXDWG, '84-'07 FXST, FXSTB, FXSTC, FXSTD and FXSTS..
<b>40556-06</b>	<b>\$150.95</b>	16" Rear, GT502 130/90B16 Blackwall	'96-'03 XL1200 Sport.
<b>40555-04</b>	<b>\$180.95</b>	16" Rear, GT502 150/80B16 Blackwall	'00-'01 FXDX, '02-'05 Dyna, '03-'05 Softail (except FXSTD, FLSTS), '06-'08 FLSTC and '10 FLSTC, '04-later XL (except XR1200). Installation on '04-later XL models with 19" front wheel requires installation of matching GT502F Front Tire P/N 40554-04. Replacement tire for Harley-Davidson Wide Tire Kits P/N 43684-99A, 43685-00A, 44490-00A.
<b>43197-04B</b>	<b>\$259.95</b>	17" Rear, GT502 180/60B17 Blackwall	'10 FXDWG, '04 FXSTDSE2, Replacement Tire for Harley-Davidson Wide Tire Kits P/N 44075-04, 43705-06, 43768-06.

## DUNLOP® • HARLEY-DAVIDSON® TIRE SERIES

Original Equipment and recommended replacement tires.

Part Number	Price	Descriptions	Model Fitment
<b>43124-94A</b>	<b>\$184.95</b>	16" Front, D402F MT90B16 Wide Whitewall with Engraved "Harley-Davidson" Logo	'81-'08 FLH, FLHS, FLHR, FLHT, FLHX, FLT, FLSTC, FLSTN, FLSTF, FLSTS (except '07-'08 FLHRSE, '07-'10 FLSTF), '04-later TLE/Ultra Sidecar, '09-'10 FLSTN, FLSTSB, FLHXXX and FLHTCUTG.
<b>43118-92A</b>	<b>\$169.95</b>	16" Front, D402F MT90B16 Wide Whitewall	'81-'08 FLH, FLHS, FLHR, FLHT, FLHX, FLT, FLSTC, FLSTN, FLSTF, FLSTS (except '07-'08 FLHRSE, '07-'10 FLSTF), '04-later TLE/Ultra Sidecar, '09-'10 FLSTN, FLSTSB, FLHXXX and FLHTCUTG.
<b>43115-91A</b>	<b>\$181.95</b>	16" Front, D402F MT90B16 Slim White Stripe	'81-'08 FLH, FLHS, FLHR, FLHT, FLHX, FLT, FLSTC, FLSTN, FLSTF, FLSTS (except '07-'08 FLHRSE, '07-'10 FLSTF), '04-later TLE/Ultra Sidecar, '09-'10 FLSTN, FLSTSB, FLSTC, FLHXXX and FLHTCUTG.
<b>43022-91A</b>	<b>\$139.95</b>	16" Front, D402F MT90B16 Blackwall	'81-'08 FLH, FLHS, FLHR, FLHT, FLHX, FLT, FLSTC, FLSTN, FLSTF, FLSTS (except '07-'08 FLHRSE, '07-'10 FLSTF), '04-later TLE/Ultra Sidecar, '09-'10 FLSTN, FLSTSB, FLSTC, FLHXXX and FLHTCUTG.
<b>43218-08</b>	<b>\$150.95</b>	16" Front, D427F 130/90B16 Blackwall	'08-'10 FXDF, '09-'10 FXDFSE/2.
<b>43211-09</b>	<b>\$187.95</b>	16" Front, D408F 130/90B16 Wide Whitewall	'09-'10 FLHRC models and FLHRC/TLE Sidecar.
<b>41474-06B</b>	<b>\$175.95</b>	17" Front, D408F 140/75R17 Blackwall	'06 FLSTFSE2, '07-'10 FLSTF.
<b>43109-09A</b>	<b>\$166.95</b>	17" Front, D408F 130/80B17 Blackwall	'09-'10 FLTR, FLHR, FLHX, FLHT, FLHTC, FLHTCU, FLHTK, FLHTCUSE4/5 and TLE Sidecar (except FLHRC/TLE).
<b>43115-09A</b>	<b>\$181.95</b>	17" Front, D408F 130/80B17 Slim White Stripe	'09-'10 FLTR, FLHR, FLHX, FLHT, FLHTC, FLHTCU, FLHTK, FLHTCUSE4/5 and TLE Sidecar (except FLHRC/TLE).
<b>43371-07</b>	<b>\$181.95</b>	18" Front, D402F 130/70-18 Blackwall	'04-'08 FL Touring models equipped with 18" accessory Front Wheel (except '07-'08 FLHRSE).
<b>41999-07B</b>	<b>\$198.95</b>	18" Front, D408F 130/70R18 Blackwall	'07-'08 FLHRSE, '08-'09 FXSTSSE2, '10 FLSTSE.
<b>43229-08</b>	<b>\$174.95</b>	18" Front, D209F RP 120/70ZR18 Blackwall	'08-'10 XR1200 models.
<b>44026-09A</b>	<b>\$161.95</b>	18" Front, D408F 130/70B18 Blackwall	'09 FLTRSE, '10 FLHXSE.
<b>40567-90A</b>	<b>\$119.95</b>	19" Front, D401F 90/90-19 Blackwall	'81-'90 XL (except XR1000, XL1200), '81-'85 FX, '82-'83 FXR (except FXRT).
<b>41566-08B</b>	<b>\$116.95</b>	19" Front, D408F 90/90-19 Blackwall	'08-'10 FXCW, FXCWC.
<b>43112-91A</b>	<b>\$124.95</b>	19" Front, D401F 100/90-19 Blackwall	'91-'10 XL883 (except Custom), '88-'10 XL1200 (except Custom, Sport), '83-'84 XR1000, '83-later FXRT, '84-later FXR (except FXLR, FXR2), '91-'10 Dyna models (except FXDWG, '00-'01 FXDX, '07-'10 FXDSE, '08-'10 FXDF).
<b>43172-01B</b>	<b>\$181.95</b>	19" Front, D208F 120/70ZR19 Blackwall	'02-'10 VRSC models.
<b>43104-93A</b>	<b>\$119.95</b>	21" Front, D402F MH90-21 Blackwall	'96-'10 XL883/XL1200 Custom, '84-'07 FXST, FXSTC, FXSTB, FXSTS, FXSTD, '93-'08 FXDWG, '86-earlier FXWG, '94-earlier FXLR, '99 FXR2, '07-'08 FXDSE.
<b>43390-08A</b>	<b>\$119.95</b>	21" Front, D408F MH90-21 Blackwall	'08-'10 FXST, FXSTB, FXSTC.
<b>43125-94A</b>	<b>\$214.95</b>	16" Rear, D402 MT90B16 Wide Whitewall with Engraved "Harley-Davidson" Logo	'81-'03 FLH, FLHS, FLHR, FLHT, FLT, FLSTC, FLSTN, FLSTF, FLSTS, (except '03 FLSTS), '95-'02 FXSTC, FXSTS, '81-'03 Harley-Davidson Sidecar models CLE, RLE, TLE/Ultra.
<b>43119-92A</b>	<b>\$194.95</b>	16" Rear, D402 MT90B16 Wide Whitewall	'81-'03 FLH, FLHS, FLHR, FLHT, FLT, FLSTC, FLSTN, FLSTF, FLSTS, (except '03 FLSTS), '95-'02 FXSTC, FXSTS, '81-'03 Harley-Davidson Sidecar models CLE, RLE, TLE/Ultra.
<b>43114-91B</b>	<b>\$189.95</b>	16" Rear, D402 MT90B16 Slim White Stripe	'81-'03 FLH, FLHS, FLHR, FLHT, FLT, FLSTC, FLSTN, FLSTF, FLSTS, (except '03 FLSTS), '95-'02 FXSTC, FXSTS, '81-'03 Harley-Davidson Sidecar models CLE, RLE, TLE/Ultra.
<b>43102-91B</b>	<b>\$164.95</b>	16" Rear, D402 MT90B16 Blackwall	'81-'03 FLH, FLHS, FLHR, FLHT, FLT, FLSTC, FLSTN, FLSTF, FLSTS, (except '03 FLSTS), '99-'02 FXSTB, '95-'02 FXSTC, FXSTS, '81-'03 Harley-Davidson Sidecar models CLE, RLE, TLE/Ultra.
<b>43353-03</b>	<b>\$202.95</b>	16" Rear, D402 MU85B16 Wide Whitewall	'03 FLSTS, '04-'08 FLTR, FLHR, FLHT, FLHTC, FLHTCUI, (except '07-'08 FLHRSE), '05-'10 FLSTN, '09-'10 FLSTC.
<b>43332-04</b>	<b>\$195.95</b>	16" Rear, D402 MU85B16 Slim White Stripe	'03 FLSTS, '04-'08 FLTR, FLHR, FLHT, FLHTC, FLHTCUI, (except '07-'08 FLHRSE), '05-'10 FLSTN.
<b>43329-04</b>	<b>\$169.95</b>	16" Rear, D402 MU85B16 Blackwall	'03 FLSTS, '04-'08 FLTR, FLHR, FLHX, FLHT, FLHTC, FLHTCUI, (except '07-'08 FLHRSE), '05-'10 FLSTN.
<b>40565-91B</b>	<b>\$146.95</b>	16" Rear, D401 130/90B16 Blackwall	'81-'03 XL (except XL1200 Sport), '82-later FXR, FXRT, '84-'94 FXSTC, FXSTS, '91-'01 Dyna models (except '00-'01 FXDX).
<b>43264-02</b>	<b>\$165.95</b>	16" Rear, D401 150/80B16 Blackwall	'02-'05 Dyna, '03-'05 Softail (except FXSTD, FLSTS), '06-later FLSTC, '05-later FLSTSC, '04-later XL (except XR1200).
<b>43228-08</b>	<b>\$233.95</b>	16" Rear, D427 180/70B16 Blackwall	'08-'10 FXDF, '09-'10 FXDFSE/2.
<b>43329-09</b>	<b>\$231.95</b>	16" Rear, D407 180/65B16 Blackwall	'09-'10 FLTR, FLTRX, FLHR, FLHX, FLHT, FLHTC, FLHTCU, FLHTK and FLHTCUSE4/5 models.
<b>43332-09</b>	<b>\$241.95</b>	16" Rear, D407 180/65B16 Slim White Stripe	'09-'10 FLTR, FLTRX, FLHR, FLHX, FLHT, FLHTC, FLHTCU, FLHTK and FLHTCUSE4/5 models.
<b>43230-09</b>	<b>\$246.95</b>	16" Rear, D407 180/65B16 Wide Whitewall	'09-'10 FLHRC models.
<b>43169-00A</b>	<b>\$194.95</b>	17" Rear, K591 160/70B17 Blackwall	'00-'07 FXSTD (except '04 FXSTDSE2), '06-'10 Dyna (except '07-'08 FXDSE, '08-'10 FXDF).
<b>41998-07</b>	<b>\$192.95</b>	17" Rear, D407 170/60R17 Blackwall	'07-'08 FLHRSE, '07-'08 FXDSE.
<b>43242-06A</b>	<b>\$197.95</b>	17" Rear, D407 200/55R17 Blackwall	'06-'10 FXST, FXSTB, FXSTC, FXSTS, FLSTFSE2, '07-'10 FLSTF and '07-'08 FXSTSSE.
<b>43970-08</b>	<b>\$195.95</b>	17" Rear, D401 200/55R17 Blackwall	'08-'10 FLSTSB models.
<b>43231-08</b>	<b>\$220.95</b>	17" Rear, D209HD 180/55ZR17 Blackwall	'08-'10 XR1200 models.
<b>41771-10</b>	<b>\$209.95</b>	18" Rear, D408 200/50R18 Blackwall	'10 FLSTSE.
<b>43173-01</b>	<b>\$239.95</b>	18" Rear, D207 180/55ZR18 Blackwall	'02-'08 VRSC models (except '06 VRSCSE2, '07-'08 VRSCAW, VRSCDX, VRSCX and VRSCF).
<b>41688-08</b>	<b>\$249.95</b>	18" Rear, D407F 240/40R18 Blackwall	'08-'10 FXCW, FXCWC, '09 FXSTSSE3.
<b>41473-06</b>	<b>\$218.95</b>	18" Rear, D419 240/40R18 Blackwall	'06 VRSCSE2, '07-'10 VRSCAW, VRSCDX, VRSCX and VRSCF. Replacement Tire for Harley-Davidson Wide Tire Kit P/N 43687-06.
<b>44006-09</b>	<b>\$224.95</b>	18" Rear, D407 180/55B18 Blackwall	'09 FLTRSE, '10 FLHXSE.

## DUNLOP® • HARLEY-DAVIDSON® SIGNATURE TIRES

Part Number	Price	Descriptions	Model Fitment
<b>83324-09</b>	<b>\$102.95</b>	15" Rear, P205/65R15 Blackwall	'09 FLHTCUTG models.



**A**

**A. H-D ORIGINAL EQUIPMENT BRAKE PADS**

**A. H-D® ORIGINAL EQUIPMENT BRAKE PADS**

<b>42739-08</b>	Front.	<b>\$44.95</b>
Fits '08-later XR models.		
<b>42310-08</b>	Rear.	<b>\$40.95</b>
Fits '08-later XR models.		
<b>44082-08</b>	Front.	<b>\$41.95</b>
Fits '08-later Dyna® and Softail® (except Springer) models.		
<b>42298-08</b>	Rear.	<b>\$49.95</b>
Fits '08-later Dyna and Softail models.		
<b>42897-08</b>	Front.	<b>\$40.95</b>
Fits '08-later VRSC™ models.		
<b>41854-08</b>	Front.	<b>\$42.95</b>
Fits '08-later Touring models.		
<b>41852-08A</b>	Rear.	<b>\$49.95</b>
Fits '08-later Touring models.		
<b>44082-00D</b>	Front/Rear.	<b>\$43.95</b>
Fits front and rear brakes on '02-'03 XL, '00-'05 VRSC, '00-'07 Dyna® and Touring models. '00-'07 Softail® models (except front brakes on FXSTS and FLSTS Springer). Does not fit '06-'07 rear brakes on FXSTS, FXST, FXSTB, and FLSTFSE2 models.		
<b>46721-06A</b>	Rear.	<b>\$42.95</b>
Fits '06-later FXSTS, FXST, FXSTB, and FLSTFSE2 models.		
<b>42897-06A</b>	Front.	<b>\$40.95</b>
Fits '06-'07 VRSC models.		
<b>42850-06B</b>	Rear.	<b>\$40.95</b>
Fits '06-later VRSC models.		
<b>42831-04A</b>	Front.	<b>\$44.95</b>
Fits '04-later XL models.		
<b>42836-04A</b>	Rear.	<b>\$40.95</b>
Fits '04-'06 XL models.		
<b>42029-07</b>	Rear.	<b>\$40.95</b>
Fits '07-later XL models.		
<b>44209-87C</b>	Rear.	<b>\$51.95</b>
Fits late '87-'99 XL, FXR, Softail® and '91-'99 Dyna models.		
<b>43957-86E</b>	Rear.	<b>\$54.95</b>
Fits '86-'99 FLT, FLHT, FLHS, FLHR models.		
<b>44063-83C</b>	Front.	<b>\$41.95</b>
Fits '84-'99 XL, '84-'86 FX, '84-'99 Softail, '84-'99 FXR, '84-'99 FLT/FLHT/FLHR, '91-'99 Dyna, and '00-later FXSTS and FLSTS models.		
<b>44209-82A</b>	Rear.	<b>\$49.95</b>
Fits '82-early '87 XL, FXR and '84-early '87 Softail, '84-'86 FX models.		
<b>43957-80A</b>	Rear.	<b>\$69.95</b>
Fits '80-'85 FLT, FLHT, and '81-'84 FLH models.		
<b>44032-79A</b>	Rear.	<b>\$38.95</b>
Fits '79-'83 XL, '82-'83 FXR and late '78-'83 FX models.		
<b>43395-80A</b>	Front/Rear.	<b>\$41.95</b>
Fits '80-'83 FLT/FLHT front and '79-'81 XL rear.		
<b>44005-78A</b>	Front/Rear.	<b>\$42.95</b>
Fits front late '78-'83 FX, late '78-'80 FLH (rear) and fits late '78-'83 FX, late '78-'84 FLH (front).		
<b>44135-74A</b>	Front/Rear.	<b>\$49.95</b>
Fits front and rear '73-early '78 FX, '72-early '78 FLH and '73 XLH/XLCH (front).		



**B**

**B. EMERGENCY DRIVE BELT REPLACEMENT KITS**



**C**

**C. HIGH LOAD DRIVE BELT**

**B. EMERGENCY DRIVE BELT REPLACEMENT KITS**

For temporary replacement of secondary belt. Contains spliced belt, alignment fixture block, hardware, Allen wrenches, and instructions.

<b>40146-00</b>	Fits '00-'06 Softail® models.	<b>\$109.95</b>
<b>40112-97</b>	(139-Tooth).	<b>\$109.95</b>
Fits '97-'06 FL Touring models.		
<b>40100-85</b>	(136-Tooth).	<b>\$109.95</b>
Fits '85-'94 Domestic FXR models, '85-'96 Domestic FLT models, and '96 International FLT models.		
<b>40109-86</b>	(132-Tooth).	<b>\$109.95</b>
Fits '86-'92 and '94 Domestic Softails and '89-'93 International FLT and FXR models. Can also be used on '91-'06 Domestic and '91-'92 International Dyna models and '97-'06 International Dyna models, '94-'95 International FLT and '99-'00 FXR models and '00-'06 Dyna models with a 133-Tooth belt.		

**C. HIGH LOAD DRIVE BELT**

This high strength belt is manufactured to improve belt life due to the heavy duty loads required by the addition of a sidecar to the motorcycle.

<b>40130-03</b>	Fits '97-'03 FLT models.	<b>\$239.00</b>
-----------------	--------------------------	-----------------

Notice: The prices appearing in this catalog are the manufacturer's suggested retail prices. Actual retail prices may vary.



# 794 MAINTENANCE

Classic Motor Parts

## A. STOCK REPLACEMENT REAR DRIVE CHAINS

<b>40032-91</b>	Rear Drive, '86-'92 XL.	<b>\$127.00</b>
<b>40028-15E</b>	*Rear Drive, Duckworth. All V-Twin models.	<b>\$89.99</b>
<b>40029-15E</b>	*Rear Drive, Diamond. All V-Twin models.	<b>\$99.99</b>
<b>40021-79B</b>	*Rear Drive, Premium. All V-Twin models.	<del><b>\$149.99</b></del> <b>OBSOLETE</b>
<b>40025-77B</b>	*Rear Drive, Self Lube. All V-Twin models.	<b>\$99.99</b>

\*NOTE: Some applications require removal of links for proper installation.



A. STOCK REPLACEMENT REAR DRIVE CHAIN

## B. CLUTCH CABLES

<b>38599-80B</b>	Fits '80-early '83 FLT and FXR models.	<b>\$30.50</b>
<b>38601-89T</b>	Fits '89- <del>90</del> models.	<del><b>\$24.00</b></del> <b>OBSOLETE</b>
<b>38607-87TA</b>	Fits '87-'88 FLT, FLHT, and '87-'94 Softail™ models.	<del><b>\$24.00</b></del> <b>OBSOLETE</b>
<b>38618-52T</b>	Fits '52-'67 FL models with Buckhorn handlebar.	<b>\$19.45</b>
<b>38618-68TB</b>	Fits '71-'85 FX and '68-'84 FL models.	<del><b>\$18.90</b></del> <b>OBSOLETE</b>
<b>38619-57TA</b>	Fits '57-'60 models.	<del><b>\$21.50</b></del> <b>OBSOLETE</b>
<b>38619-71TB</b>	Fits '71-early '84 XL, XLCH, and '81-early '84 XLS models.	<del><b>\$19.75</b></del> <b>OBSOLETE</b>
<b>38619-86TA</b>	Fits '86-'95 XL models with low handlebar.	<del><b>\$24.00</b></del> <b>OBSOLETE</b>
<b>38621-86TA</b>	Fits '86-'95 XL models with Buckhorn handlebar.	<del><b>\$25.00</b></del> <b>OBSOLETE</b>
<b>38623-68T</b>	Cable bracket.	<b>\$2.55</b>



B. CLUTCH CABLES

## IDLE CONTROL CABLES

<b>56309-88</b>	Fits '88-'95 XL models.	<b>\$17.00</b>
<b>56323-81TA</b>	Fits '81-'84 FL, '81-'89 FX models (except Springer® and Fat Boy®), '81-'85 XL, '82-'83 FLT, and '82-'89 FXR and FXRS models (except Sport).	<b>\$17.90</b>
<b>56328-81TB</b>	Fits '81 and '84-'89 FLT models (except Ultra).	<b>\$17.00</b>
<b>56331-81T</b>	Fits '81 models.	<del><b>\$13.50</b></del> <b>OBSOLETE</b>

## THROTTLE CONTROL CABLES

<b>56308-88T</b>	Fits '88-'95 XL models.	<b>\$17.00</b>
<b>56313-76T</b>	Fits '76-'80 models.	<b>\$17.90</b>
<b>56314-78</b>	Fits late '76-'78 XL models.	<b>\$17.00</b>
<b>56324-81TA</b>	Fits '81 and '84 FL, '81-'89 FX (except Springer® and Fat Boy®), '81-'85 XL, '82-'83 FLT, and '82-'89 FXR and FXRS models (except Sport).	<b>\$17.90</b>
<b>56327-81TB</b>	Fits '81 and '84-'89 FLT models (except Ultra).	<b>\$17.00</b>
<b>56336-83T</b>	Fits '83-'89 FXRT, '87 FXLR, and '87-'89 FXRS-SP models.	<b>\$17.00</b>
<b>38634-75T</b>	Rear Brake Cables (not shown). Fits '75-'76 XL models.	<del><b>\$23.00</b></del> <b>OBSOLETE</b>



C. CHROME COIL COVER

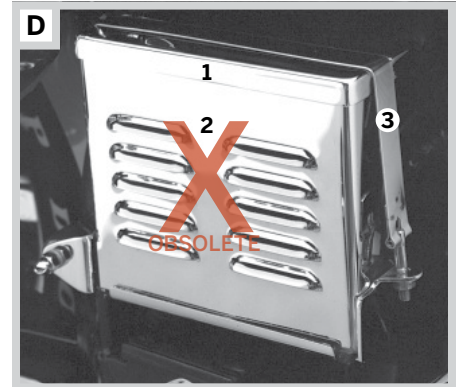

D. CHROME BATTERY TOP COVER, SIDE COVER, STRAP

## C. CHROME COIL COVER

<b>31606-65TA</b>	Fits '65-'84 FL and '71-'99 FX, FXST, FLST models (except '99 FXSTB).	<b>\$28.95</b>
-------------------	---	----------------

## D. CHROME BATTERY TOP COVER, SIDE COVER, STRAP

Fits '73-'85 FX (except FXST) and '82-'96 XL models.		
<b>Battery Top Cover</b>		
<b>1. 66367-73T</b>		<b>\$18.40</b>
<b>Battery Side Cover</b>		
<b>2. 66071-83T</b>	Louvered.	<del><b>\$30.75</b></del> <b>OBSOLETE</b>
<b>Battery Strap</b>		
<b>3. 66476-73T</b>		<b>\$17.40</b>

## E. CHROME BATTERY TOP COVERS

<b>1. 66369-70T</b>	Fits '71-'78 FX and '70-'78 XLCH models.	<b>\$14.15</b>
<b>2. 66370-65T</b>	Fits '65-'66 models.	<del><b>\$24.95</b></del> <b>OBSOLETE</b>

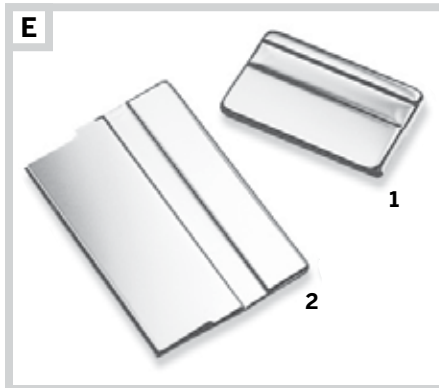

E. CHROME BATTERY TOP COVERS



F. BICYCLE-TYPE STARTER PEDAL

<b>F. BICYCLE-TYPE STARTER PEDAL</b>		
<b>33175-16T</b>	Fits '29-'67 models.	<del><b>\$33.90</b></del> <b>OBSOLETE</b>

Notice: The prices appearing in this catalog are the manufacturer's suggested retail prices. Actual retail prices may vary.

# QUICK INDEX

The following quick index will help you search the catalog by general product categories. For specific model and year search, visit [harley-davidson.com/customize](http://harley-davidson.com/customize), and click "Shop for your bike".

## VRSC™

Windshields	<b>24-25</b>
Seating	<b>26-28</b>
Backrests & Luggage Racks	<b>29-32</b>
Saddlebags & Luggage	<b>32-34</b>
Color-Matched Accessories	<b>34</b>
Engine Trim	<b>35-36</b>
Chassis Trim	<b>37</b>
Chassis Trim – Front End	<b>38-39</b>
Chassis Trim – Rear End	<b>40-41</b>
Wheels & Sprockets	<b>42-43</b>
Brakes	<b>44</b>
Engine Guards	<b>45</b>
Hand & Foot Controls	<b>46-50</b>
Horns, Lighting & License Plates	<b>50-53</b>

## SPORTSTER®

XR1200 Accessories	<b>64-65</b>
Windshields	<b>66-68</b>
Seating	<b>69-73</b>
Backrests & Luggage Racks	<b>74-79</b>
Saddlebags & Luggage	<b>80-83</b>
Color-Matched Accessories & Bodywork	<b>82, 84</b>
Engine & Chassis Trim	<b>85-93</b>
Chassis Trim – Front End	<b>94-96</b>
Chassis Trim – Rear End	<b>97-99</b>
Brakes	<b>99-100</b>
Suspension	<b>101</b>
Hand Controls	<b>102-105</b>
Foot Controls	<b>106-107</b>
Passenger & Highway Pegs	<b>107-108</b>
Engine Guards	<b>109</b>
Consoles & Gauges	<b>110-113</b>
Horns, Lighting & License Plates	<b>113-119</b>

## DYNA®

Windshields	<b>130-133</b>
Seating	<b>134-142</b>
Backrests & Luggage Racks	<b>143-150</b>
Saddlebags & Luggage	<b>151-156</b>
Color-Matched Accessories	<b>152</b>
Suspension	<b>157-159</b>
Chassis Trim – Front End	<b>160-165</b>
Chassis Trim – Rear End	<b>166-168</b>
Brakes	<b>169-170</b>
Chassis Trim & Bodywork	<b>171-173</b>
Hand Controls	<b>174-176</b>
Foot Controls	<b>177-179</b>
Passenger & Highway Pegs	<b>180-181</b>
Engine Guards	<b>182</b>
Consoles & Gauges	<b>182-191</b>

## SOFTAIL®

Windshields	<b>208-217</b>
Seating	<b>218-229</b>
Backrests & Luggage Racks	<b>230-242</b>
Saddlebags & Luggage	<b>243-257</b>
Color-Matched Accessories	<b>250-253</b>
Suspension	<b>258-259</b>
Chassis Trim – Front End	<b>260-270</b>
Chassis Trim – Rear End	<b>271-279</b>
Brakes	<b>280-282</b>
Chassis Trim	<b>283-287</b>
Hand Controls	<b>288-291</b>
Foot Controls	<b>292-299</b>
Engine Guards & Highway Pegs	<b>300-302</b>
Footpegs & Footboards	<b>303-307</b>
Consoles & Gauges	<b>308-321</b>

## TOURING

Windshields & Windshield Bags	<b>338-347</b>
Fairing Lowers	<b>348-351</b>
Wind Deflectors	<b>352</b>
Seating	<b>353-367</b>
Backrests & Racks	<b>368-375</b>
Tour-Pak® Luggage	<b>376-387</b>
Tour-Pak & Saddlebag Accessories	<b>388-403</b>
Luggage	<b>404-405</b>
Suspension	<b>406-407</b>
Chassis Trim – Front End	<b>408-414</b>
Chassis Trim – Rear End	<b>415</b>
Brakes	<b>416-418</b>
Chassis Trim	<b>419-423</b>
Hand Controls	<b>424-427</b>
Foot Controls	<b>428-431</b>
Engine Guards & Highway Pegs	<b>432-433</b>
Footboards & Footpegs	<b>434-438</b>
Fairing & Console Trim	<b>439-445</b>
Gauges	<b>446-455</b>
Trike Accessories	<b>456-459</b>
Sidecar Accessories	<b>460-461</b>

## SCREAMIN' EAGLE®

Screamin' Eagle Performance	<b>462-466</b>
Sportster® Performance Kits	<b>467</b>
Twin Cam Performance Kits	<b>468-470</b>
Evolution® 1340 Performance Kits	<b>470</b>
Air Cleaner Kits	<b>471-474</b>
Exhaust Systems	<b>475-491</b>
Engine & Transmission Components	<b>492-497</b>
Ignition	<b>498-499</b>
Decorative Accessories	<b>500</b>
Specialty Tools	<b>501-505</b>

## ENGINE PROGRAMS

Engine Remanufacturing	<b>506-507</b>
New Era Revolution®, Evolution® & Twin Cam Engines	<b>508-510</b>
Transmissions	<b>511</b>

## MULTI-FIT

Engine Trim & Collections	<b>512-523</b>
Engine & Transmission Covers	<b>524-533</b>
Carb & EFI Covers	<b>534-535</b>
Oil Level Dipsticks	<b>536-537</b>
Cylinder Head Covers	<b>538-539</b>
Air Cleaner Covers	<b>540-541</b>
Hardware	<b>542-547</b>
Hand Grips & Footpegs	<b>548-567</b>
Footboards	<b>568-569</b>
Highway Pegs	<b>570-571</b>
Mirrors	<b>572-575</b>
Handlebars	<b>576-595</b>
Handlebar Risers, Clamps & Hardware	<b>596-598</b>
Hand Controls & Levers	<b>599-605</b>
Control Cables & Brake Lines	<b>606-615</b>
GPS, Audio & Electronics	<b>616-626</b>
Lighting	<b>627-635</b>
Lighting Trim	<b>635-639</b>
Turn Signals	<b>640-647</b>
Tail & Brake Lamps	<b>649-651</b>
LED Lights	<b>652-657</b>
Horns	<b>658-659</b>
License Plate Accessories	<b>660-663</b>
Custom Wheels	<b>664-684</b>
Custom Sprockets	<b>685-687</b>
Brake Rotors	<b>688-690</b>
Luggage – Universal Fit	<b>691-694, 696-699</b>
Luggage – Custom Fit	<b>691, 695</b>
Windshield, Sissy Bar & Fork Bags	<b>698-705</b>

## CUSTOM SEAT PROGRAM

Colors & Options	<b>706-709</b>
------------------	----------------

## COLOR SHOP

Limited Series Custom Paint Sets	<b>710-724</b>
Core Series Custom Paint Sets	<b>725-729</b>
Sheet Metal Exchange Program	<b>730-733</b>
Spectrum Custom Color Program	<b>734-737</b>
Bodywork	<b>738-744</b>
Paints & Decals	<b>745-747</b>

## MAINTENANCE & SECURITY

Security Systems	<b>748-751</b>
Security Locks	<b>752-754</b>
Storage Covers	<b>755-757</b>
Motorcycle Lifts & Tie-Downs	<b>758-759</b>
Cleaning & Detailing Products	<b>760-771</b>
Battery Chargers	<b>772-773</b>
Tools & Maintenance	<b>774-777</b>
Oil & Lube	<b>778-782</b>
Batteries	<b>783</b>
Oil & Air Filters	<b>784-785</b>
Spark Plugs	<b>786-787</b>
Tires & Brakes	<b>788-793</b>
Classic Parts	<b>794</b>

# 796 PART#/PAGE# REFERENCE

8060	544	16161-99	508	25213-04	85	27505-10	468	29260-08	471	29782-07	467
8061	544	16177-99	508	25213-96B	85	27506-09	468	29264-08	472	29784-07	467
8062	544	16295-07A	86	25216-98	86	27508-09	468	29289-89T	520	29793-02C	470
8063	544	16309-04A	35	25231-04	86	27532-08	469	29289-90T	520	29823-04	89
8064	544	16318-01A	524	25233-04	86	27533-08	469	29291-95	785	29824-04	89
8065	544	16318-07A	524	25247-99	526	27534-10	470	29299-08	472	29833-06	541
8066	544	16326-02	524	25256-93A	527	27535-08	470	29314-08	785	29866-07A	468
8067	544	16326-07A	524	25268-84A	527	27536-08	470	29319-08	471	29888-06	474, 541
8071	544	16327-01A	524	25282-07	493	27539-08	470	29325-95A	785	29898-06	474, 541
8072	544	16327-06A	524	25284-08	493	27540-08	470	29328-99	520	29902-09	474, 541
8073	544	16330-08A	524	25285-08	493	27541-08	469	29330-96	785	29903-07A	470
8074	544	17048-98	490	25330-98	522	27543-08	469	29331-04	785	29904-07A	470
93936	745	17378-98	494	25331-10	516	27545-08	469	29331-96	785	29915-09	473
94266	732	17528-84A	527	25332-98	88	27557-08	469	29341-02	520	29929-07	474, 541
94267	732	17528-92	527	25333-10	89	27558-08	469	29351-95	545	29985-87	451
94268	732	17529-84A	527	25334-99A	521	27564-09	469	29377-08	785	29999-97B	451
94269	732	17529-92	527	25336-06	521	27565-09	469	29382-97A	500	31314-99	87
94282	732	17530-84B	527	25338-99A	522	27566-09	469	29383-97A	500	31335-03A	515
94283	732	17530-92	527	25340-99A	520	27794-08	786	29387-97B	470	31559-99A	515
94284	732	17537-07	85	25343-04A	88	27800-08A	468	29405-90T	89, 520	31606-65TA	794
94285	732	17537-96C	85	25364-01B	526	27801-08A	468	29406-08	471	31619-06A	515
94336	732	17538-96	85	25369-01B	526	27804-08	468	29408-08	473	31621-06A	515
94337	732	17551-04	85	25372-02A	520	27929-08	520	29415-99	521	31653-97	499
94479	735	17551-96	85	25391-84T	520	27935-08	520	29416-04	88	31709-04	173
94491	731	17572-99	527	25391-90T	520	27936-08	521	29417-04	519	31724-98	87, 533
94492	731	17573-99A	527	25393-98	521	27937-08	521	29419-98A	521	31737-99	173
94493	731	17618-99A	526	25397-95T	89	27938-08	522	29430-06	521	31765-04A	499
94494	731	17620-99	526	25398-95T	89	27939-08	519	29431-97	87, 534	31767-04	93
94495	731	17675-01B	494	25400-98	89	27956-10	516	29437-01	785	31783-00	87, 533
94496	731	17964-99	527	25440-04A	88	27957-10	89	29461-99	785	31901-08	499
94497	731	17966-99	527	25441-04A	519	27958-10	516	29462-99	785	31902-08	499
94498	731	17997-99A	494	25454-01	518	28716-10	472	29489-99C	471	31930-99B	499
94499	731	18013-03A	494	25460-04	85	28720-10	472	29490-09	473	31932-99B	499
94500	731	18088-02	532	25460-06	85	28721-10	473	29493-05	472	31937-99B	499
94501	732	18096-00A	532	25460-94	85	28722-10	473	29503-07	500	31939-99B	499
94502	732	18241-04	87	25539-06	86	28861-07A	495	29506-09	474, 541	31944-99B	499
94583	733	18248-99	532	25562-09	517	29006-09A	472	29510-05	471	31946-99B	499
94584	733	18262-00	532	25563-09	89	29017-09	472	29567-99	500	31956-04A	499
94585	733	18278-06	532	25913-99	544	29036-72	785	29585-03DH	740	31958-04A	499
94586	733	18404-08	494	26082-05B	514	29036-86	785	29585-06BDK	740	31963-89A	499
94587	733	18568-98	494	26151-07	514	29080-09	472	29585-07DH	740	31964-89B	499
94588	733	18572-07	494	26155-07	514	29084-04DH	740	29585-10BDK	740	31965-08	499
94589	733	19176-06C	510	26155-09	514	29084-10BDK	740	29586-06	471	31967-08	499
94590	733	19176-10	510	26157-07	514	29098-09	472	29600-00	545	31987-85B	499
94591	733	19255-05B	510	26321-99A	531	29119-08	471	29619-99	500	32042-07	532
94592	733	19256-05B	510	26792-01	36	29138-91	540	29620-99	500	32047-99A	522
98619	771	19258-06C	509	26808-04	36	29153-07	474, 540	29622-99	500	32077-07	532
98625	771	19259-06C	509	27040-88T	534	29170-08	471	29624-08	471	32092-98A	499
98636	771	19264-06C	510	27129-88T	534	29191-08	785	29633-08	785	32093-98A	499
98645	735	19293-06C	509	27351-96	534	29193-08DH	740	29642-04	88	32095-98A	499
98646	735	19293-10	509	27353-96	534	29193-10BDK	740	29703-00	545	32186-10	498, 787
13718-03	441	19296-06C	509	27477-04	495	29243-97	522	29745-00A	474, 541	32187-10	498, 787
13739-00	441	19569-10K	508	27483-07A	535	29253-08A	472	29748-00	541	32188-10	498, 787
14093-84	747	24004-03A	493	27501-09	468	29255-78	785	29754-01	540	32189-10	498, 787
14813-03	746	24226-01A	48	27501-10	468	29259-83A	785	29765-01	540	32192-10	498, 787
14814-03	746	25125-04A	89	27504-09	468	29259-86	785	29769-01	540	32303-08	499
16101-01	495	25127-04A	89	27504-10	468	29259-89	785	29770-01	36	32318-08	499
16160-99	508	25130-04A	88	27505-09	468	29259-91A	785	29773-02C	471	32325-08	499

32331-05	786	33044-03A	497	33920-00	294	36808-05	176, 289, 426, 605	38848-09	608	40141-10	669
32334-05	786	33045-03A	497	33920-07	294	37103-08	536	38849-09	608	40142-08	168, 685
32335-04	786	33100-03A	497	33930-09	107	37105-87A	527	38850-09	608	40146-00	793
32336-04	786	33101-03A	497	33946-05	556	37105-99	526	38851-09	608	40150-08	278, 685
32337-04	786	33102-03A	497	34016-08	178, 295	37116-06	526	38852-09	608	40154-08	168, 685
32338-04	786	33103-03A	497	34018-08	298, 431	37123-98A	536	38853-08	603	40155-08	278, 685
32339-04	786	33104-03	497	34023-08	296, 429	37135-06	526	38854-09	608	40156-10	669
32342-04	786	33105-03	497	34468-98A	527	37709-09	687	38856-09	608	40158-10	788
32343-04	786	33111-02	531	34469-01	527	37756-07	168	38857-09	608	40159-10	788
32359-00B	499	33118-10	511	34469-06B	526	37757-07	278, 415, 685	38858-09	608	40161-09	43, 667
32360-00B	499	33136-04	497	34469-99B	527	37785-07	687	38859-09	608	40162-09	43, 667
32362-04	786	33137-04	497	34521-06B	526	37793-07	687	38860-09	608	40168-09	43, 667
32364-04	786	33139-10	511	34535-00B	296, 429	37793-07	687	38874-10	608	40169-09	43, 667
32365-04	786	33175-16T	794	34539-00	178, 295	37800-08	687	38875-09A	608	40202-91B	101
32366-04	786	33395-04	106	34541-00	527	37833-10	671, 687	38877-09A	608	40225-10	670
32367-04	786	33395-06A	106	34551-09	49	37834-10	671, 687	38906-07	609	40228-07	687
32414-09	517	33397-07A	106	34555-01A	49	37875-86A	495	38911-09A	608	40229-04	43, 667
32415-09	89	33398-04	106	34558-05A	296, 429	37931-84	495	38913-09	609	40268-10	670
32510-77	747	33398-06A	106	34586-09	107	37938-08KA	496	38916-09A	608	40274-08	496
32519-10	516	33401-05	92	34601-02	558	37946-99	531	38918-09	609	40279-91A	99
32520-10	89	33695-03	177	34604-09	298, 431	37951-98	496	38921-09	608	40282-05	687
32565-97A	500	33695-93	177	34606-90T	85	37961-02	530	38922-09	608	40285-91B	101
32566-97A	500	33697-03A	177	34608-95	564	37970-03A	496	38923-09	608	40287-07	415
32571-98A	89, 521	33697-93	177	34615-94	106	37976-08	496	38924-09	608	40317-94	168, 278
32581-85T	89, 520	33698-07	297	34616-02	178, 295	37980-10	496	38925-09	608	40359-10	673
32581-90TB	89	33745-09	179	34617-03	560	37982-04	528	38926-09	608	40386-10	673
32584-88TA	523	33760-09	298, 431	34626-95	565	38002-04	495	38933-08	602	40410-09	687
32585-89T	520	33761-09	179	34627-99	562	38599-80B	794	38935-08	602	40413-04	687
32585-90T	520	33762-09	298, 431	34633-85T	566	38601-89T	794	38939-09A	608	40418-04	687
32590-98	521	33778-09	107	34635-90T	566	38607-87TA	794	38940-09A	608	40435-04	687
32662-99A	521	33801-09	298, 431	34648-07	47, 603	38618-52T	794	38941-09A	608	40445-08	687
32666-98	522	33807-09	298, 431	34664-04	557	38618-68TB	794	38945-09	609	40447-01	687
32668-98A	88, 522	33814-98A	299, 431	34669-09A	553	38619-57TA	794	38946-09	609	40447-07	687
32675-04A	88	33815-06	179	34680-03	560	38619-71TB	794	38947-09	609	40451-01	687
32677-01	518	33815-98A	179	34680-03	560	38619-86TA	794	38954-09	609	40451-07	687
32679-99A	523	33817-98A	299, 431	34689-04	561	38621-86TA	794	38957-09	609	40455-02	687
32689-99A	520	33819-98A	299, 431	34690-08	554	38623-68T	794	38967-10	608	40474-03	687
32690-99A	544	33823-09	298, 431	34699-04	561	38629-02	608	40006-85	776	40474-07	687
32698-02A	520	33825-00	292	34720-07	559	38634-75T	794	40021-79B	794	40478-03	687
32714-98A	604	33833-01A	48	34760-04	85, 523	38636-07	533	40025-77B	794	40478-07	687
32715-98	100, 170, 282	33838-09	179	34760-94	85	38660-03	608	40028-15E	794	40482-04	687
32729-07	87	33840-09	298, 431	34761-04A	85	38674-03	608	40029-15E	794	40502-06	791
32732-98	87	33851-09	431	34761-94	85, 523	38727-04	608	40032-91	794	40526-00	687
32743-99	500	33854-09	298	34822-08	493	38732-04	608	40054-01	505	40530-07	687
32744-99	500	33857-09	431	34823-08	501	38734-04	608	40063-05A	515	40541-05	43, 667
32745-99	539	33867-02	48	34840-09	107	38737-09	608	40096-00	687	40554-04	792
32747-99	539	33872-00	179	34848-09	179	38745-09	608	40100-85	793	40555-04	792
32753-01	532	33872-06	179	34850-09	298, 431	38750-05	608	40109-86	793	40556-06	792
32875-04	533	33876-07	297, 430	34856-06A	545	38752-04	497	40112-97	793	40558-82	791
32964-06	521	33878-04	179	34932-04	85	38753-04A	497	40120-09	168, 685	40565-91B	792
32972-04A	88	33884-09	298, 431	34932-96	85	38778-05	609	40121-09	278, 685	40567-90A	792
32975-04A	519	33891-98	106	34939-98	86	38781-06	609	40122-10	168, 685	40575-05	791
33005-06A	511	33892-98	106	34944-04	86	38792-05A	427	40123-10	278, 685	40592-09	791
33005-99	511	33907-01	292	34967-04	563	38804-07	176, 606	40124-10	98	40593-09	791
33006-06A	511	33909-08	293	35286-10	553	38818-10	608	40126-00	687	40595-06	168
33006-99	511	33915-09	298, 431	35471-05	297, 430	38843-08	425, 602	40126-07	687	40698-06	687
33034-03A	497	33917-09	179	35495-06	297	38845-08	425, 602	40130-03	461, 793	40701-08	676
33040-03A	497	33919-00	532	36783-87	495	38847-09	608	40134-07	687	40720-07	675



# 798 PART#/PAGE# REFERENCE

40721-08	675	41150-98	690	41580-03A	267	42047-06	280	42387-07	614, 615	42776-07	615
40722-08	675	41154-04	684	41581-03A	273	42047-08	169, 280	42393-08	615	42778-07	615
40723-08	675	41161-01	663	41583-03	267	42048-06	280	42395-07	615	42780-07	615
40734-07	675	41163-04	413	41583-07	267	42048-08	280	42396-08	615	42782-07	615
40738-07	675	41170-03	663	41596-00A	273	42053-05	44, 417	42399-08	615	42784-07	615
40743-07	675	41171-03	690	41597-00	165, 267	42054-05	44, 417	42428-08	615	42786-07	615
40744-07	675	41174-07	684	41597-07	267	42064-07	167	42439-08	614, 615	42788-07	615
40750-08	683	41180-04A	684	41610-02	413	42065-07	167	42447-96	106	42791-07	615
40756-08	675	41188-06	791	41616-02	95, 165	42069-08	277	42461-08	614, 615	42831-04A	793
40758-08	677	41202-08	276	41624-04	413	42070-07	100	42476-95	564	42836-04A	793
40774-10	669	41203-05	683	41625-04	267	42072-07	97	42478-95	564	42841-03	560
40776-10	669	41221-08	273	41653-05	97	42091-09	676	42482-95	565	42850-06B	793
40778-08	674	41260-08	684	41655-08	677	42100-06A	46, 599	42484-08	615	42897-06A	793
40779-08	674	41261-08	682	41661-06	277	42108-07	614, 615	42485-07	615	42897-08	793
40789-08	673	41262-08	681	41680-08	676	42110-07	614, 615	42527-08	615	42903-07	614, 615
40790-09	674	41265-08	681	41681-07	676	42112-08A	614, 615	42535-08	602	42905-07	615
40792-09	674	41271-07	681	41688-08	792	42114-06A	47	42548-08	615	42907-07	615
40802-08	674	41274-08	681	41704-09	167, 276	42117-08	424, 599	42554-03	560	42909-07	615
40803-09	668	41285-06	684	41705-09	167, 276	42123-08	424, 600	42555-04	557	42911-07	615
40806-09	668	41285-09	684	41706-09	167, 276	42134-06	264	42557-95	565	42930-07	106
40814-08	676	41288-06A	684	41734-08	675	42136-07	264	42560-09	553	42942-08	613
40816-08	676	41288-09	684	41771-10	792	42137-08	677	42599-08	615	42952-04	683
40818-08	676	41312-04	682	41775-04B	292, 428	42142-08	613	42617-99	178	42954-04	683
40820-08	676	41313-04	682	41777-05A	292, 428	42155-07	689	42623-00	555	42958-07	683
40822-08	676	41314-10	788	41793-08	602	42156-07	689	42629-00	555	42959-04	683
40825-08	678	41316-10	788	41800-08	296	42158-07	689	42632-07	295	42962-08	683
40827-08	678	41319-10	788	41805-08	295	42170-09	672	42638-00A	297, 429	42964-01A	49
40829-08	681	41323-10	788	41815-00	292	42171-09	672	42638-03	429	42975-08	613
40831-08	679	41360-08	39	41825-09	614, 615	42191-07	676	42638-08A	429	43013-09	97
40833-08	679	41361-08	165	41830-05	689	42191-08	676	42640-00	297	43022-91A	792
40835-08	679	41362-08	167	41831-05	689	42195-10	672	42640-03	296	43051-01	164, 413
40839-08	675	41367-08	43	41832-05	689	42196-10	672	42650-08	557	43059-04	165, 412
40842-08	684	41369-08	97	41842-06	99, 170, 281, 604	42204-04	50	42664-03A	177	43061-04	164, 412
40880-09	679	41370-08	95	41843-08	44, 416, 604	42230-00	417	42666-03	178	43062-04	164, 412
40881-09	679	41371-08	413	41844-06	44, 416, 604	42231-00	417	42677-05	296	43063-04	164, 413
40882-08	669	41378-08	273	41850-08	554	42235-00	417	42678-05A	558	43078-99	767
40884-08	669	41406-07	677	41852-08A	793	42261-08	613	42679-01	567	43099-09	791
40885-09	679	41406-08	677	41854-08	793	42270-06A	47, 602	42683-02	295	43101-06	791
40916-08	791	41409-06	165	41880-07	673	42275-07A	47, 602	42700-05	556	43102-91B	792
40943-09	679	41410-06	165	41880-07	673	42298-08	793	42701-05	556	43104-93A	792
40955-05	100, 170, 281	41420-08	165	41883-07	673	42303-00B	613	42705-04	106	43109-09A	792
40956-00A	613	41451-08	665	41886-07	673	42303-96	613	42710-04	561	43112-91A	792
40958-09	614, 615	41452-08A	665	41886-09	673	42305-00A	613	42711-04	561	43114-91B	792
40959-05	100, 170, 281	41453-08B	665	41888-07	673	42305-96	613	42712-04	434, 563	43115-09A	792
40966-09	679	41454-08A	665	41889-07	673	42307-04	104, 599	42739-08	793	43115-91A	792
40996-09	679	41455-08B	665	41889-09	673	42307-07	104, 599	42749-07	614, 615	43117-09	792
41007-07	791	41456-08B	665	41981-08	674	42310-08	793	42752-07	264, 614, 615	43118-92A	792
41017-00	682	41458-08	413	41983-08	674	42313-04	104, 600	42754-07	615	43119-92A	792
41017-95	682	41473-06	792	41996-07	791	42313-07	104, 600	42756-07	615	43124-94A	792
41022-07	682	41474-06B	792	41998-07	792	42314-05A	613	42758-07	615	43125-94A	792
41026-08	684	41491-08	791	41999-07B	792	42317-06A	613	42760-07	615	43132-08	167, 276
41031-07	684	41503-10	671	42002-08	169	42340-10	615	42762-07	615	43140-80	791
41088-09	266	41509-10	671	42008-09	553	42366-07	264, 614, 615	42764-07	614, 615	43145-47	791
41144-97	690	41522-08	267	42012-06A	44, 416	42371-07	614, 615	42766-07	614, 615	43147-40	791
41145-97	690	41536-05	170	42029-07	793	42373-07	615	42768-07	615	43161-97	267
41146-97	690	41566-08A	792	42030-05	44, 416	42377-07	615	42770-07	614, 615	43163-08A	38, 96, 164, 266, 412
41148-98	690	41567-08	676	42034-07	167	42379-07	614, 615	42772-07	264, 614, 615	43164-05	791
41149-98	690	41575-08	277	42035-06	169	42385-07	264, 615	42774-07	615		

43169-00A	792	43573-08	679	43924-07	678	44248-96	562	44617-08	669	44994-07	104, 175, 289, 425, 602
43172-01B	792	43575-08	679	43925-07	678	44250-08	615	44620-04	100	44994-08	175, 289, 602
43173-01	792	43577-09	678	43928-08	678	44254-01	276	44621-04	100	45002-98	165, 270
43197-04A	792	43580-04	97	43929-08	678	44256-01	276	44622-04	100	45007-08	615
43199-09	677	43602-07	679	43930-08	678	44257-01	167	44623-04	100	45023-02	165
43211-09A	792	43609-07	679	43931-08	678	44259-08	615	44632-07	677	45047-06	689
43215-08	42, 666	43616-08	42, 666	43934-07	678	44262-01	167	44633-08	677	45075-07	104, 175, 289, 425, 602
43218-08	792	43621-09	668	43939-89	791	44282-07	679	44634-07	677	45075-08	175, 289, 602
43219-08	42, 666	43634-08	43, 667	43942-07	678	44296-04	91	44636-08	677	45078-96D	47, 104, 174, 288, 424, 600
43221-08	276	43635-08	43, 667	43943-01	91, 539	44306-08	615	44637-08	677	45082-08	615
43228-08	792	43636-09	668	43957-80A	793	44322-07	679	44654-07	677	45091-97	613
43229-08	792	43649-08	679	43957-86E	793	44323-07	679	44659-07	677	45094-08	615
43230-09	792	43703-08	679	43970-08	792	44340-08	615	44660-07	680	45110-96A	613
43231-08	792	43705-06	159	43972-08	678	44345-09	277	44661-07	680	45112-96A	613
43235-08	275	43728-08	42, 666	43973-08	678	44346-06	167	44666-07	677	45115-95B	613
43242-06A	792	43759-00	169, 282	43975-07	679	44355-08	615	44689-08	677	45118-06	689
43245-00A	279, 690	43768-06	159	43978-07	679	44357-00	689	44700-03	689	45119-00B	613
43245-07	279, 690	43771-07	679	43979-08	679	44358-00	689	44703-03	689	45121-96A	613
43250-07A	788	43773-07	679	44005-78A	793	44359-00	689	44706-03	689	45131-08	615
43252-07	788	43779-09	159	44006-09	792	44360-00	689	44716-04	613	45133-04A	613
43258-07A	788	43780-08	679	44013-09A	417	44365-00	689	44729-09	417	45134-08	615
43260-98	100, 170, 282	43794-08	679	44026-09A	792	44366-00	689	44790-08	614, 615	45139-05A	613
43264-02	792	43795-08	679	44032-79A	793	44367-00	689	44793-01	613	45139-08	613
43265-09	681	43798-00	417	44055-07	678	44368-00	689	44794-01A	613	45143-88B	613
43268-09	681	43822-01	538	44056-07	678	44392-00A	44, 100, 169, 280, 416	44800-00A	613	45149-99C	292, 428
43280-01	566	43830-96	275	44057-07	678	44395-00A	100, 169, 280	44801-00A	613	45150-08	615
43284-07	788	43833-07	665	44058-07	678	44395-08	169, 280	44803-00B	613	45156-00	613
43288-07	788	43834-98	100, 170, 282	44063-83C	793	44411-09	689	44813-00A	613	45166-07	603
43303-07	788	43835-98	91, 538	44081-09	615	44421-09	689	44815-00A	613	45194-99	613
43304-07	788	43840-01	538	44082-00D	793	44429-06A	613	44819-00	689	45199-99B	613
43314-01	275	43841-01	538	44082-08	793	44432-04	91	44821-00	689	45201-97B	613
43329-04	792	43848-08	665	44093-96	281	44438-87B	613	44822-00	689	45202-00A	613
43329-09	792	43850-96	544	44095-96	281	44461-08	615	44856-02	689	45202-97B	613
43332-04	792	43851-08A	665	44100-95	689	44463-04	613	44857-02	689	45206-97B	613
43332-09	792	43854-08	665	44101-95	689	44473-02A	281, 418	44877-05	613	45208-97B	613
43341-09	791	43857-00	538	44102-95	689	44474-99	169, 281, 418	44881-05	613	45209-97B	613
43349-96B	613	43858-00	538	44103-02A	461	44476-99	169, 281, 418	44889-05	613	45210-97B	613
43350-96C	613	43859-00	538	44103-08	461	44477-99	169, 281, 418	44892-05	613	45212-97B	613
43353-03	792	43861-08	665	44103-09	461	44493-02	41	44894-05	613	45223-08	615
43367-00	282	43864-96	266, 413	44106-08	614, 615	44497-02	36	44901-05	613	45243-00	163, 265
43371-07	792	43868-99	539	44108-95	689	44508-01	167	44905-08	614, 615	45250-98B	613
43374-04A	613	43876-04	99, 279, 418, 690	44108-95	689	44527-02	603	44907-08	614, 615	45251-08	615
43378-04	96	43878-08	665	44110-04	100	44529-02	603	44940-08	689	45260-08	615
43387-08	677	43881-96	544	44114-07	39, 165, 267, 412	44534-02	603	44942-08	689	45264-98B	613
43390-08A	792	43884-96	91, 539	44116-07A	38, 96, 164, 266, 412	44535-02	603	44944-08	689	45275-98	95, 162
43395-80A	793	43890-93	91, 538	44117-07A	38, 96, 164, 266, 412	44539-02A	44, 280	44947-08	689	45281-99D	104, 174, 288, 424, 599
43422-09	167, 276	43894-90	266	44135-74A	793	44542-03	169, 281, 418	44950-08	689	45284-99D	104, 174, 288, 599
43428-09	38, 96, 164, 266, 412	43896-99	91, 538	44138-08	615	44544-08	679	44953-07	615	45287-99C	613
43429-02	276	43897-86B	275	44148-07A	38, 96, 164, 266, 413	44550-07	680	44955-07	615	45291-00A	613
43430-09	41	43899-86A	96, 164, 266, 412	44162-09	615	44552-08	680	44957-07	615	45305-98	162, 263
43462-00	275	43907-94	96, 165, 267, 412	44206-08	615	44556-07	680	44959-08	689	45310-98	263
43468-00	275	43911-95	91, 539	44209-82A	793	44560-08	680	44962-07	614, 615	45315-98	410
43501-08	42, 666	43918-07	678	44209-87C	793	44562-08	680	44964-07	614, 615	45318-99	428
43538-09	678	43919-07	678	44213-08	614, 615	44566-07	680	44966-07	615	45319-04C	613
43549-09	678	43920-08	678			44604-08	680	44970-07	293		
43553-00	169, 282	43921-08	678			44612-07	677	44972-08	293		
43556-04	97					44615-08	669	44992-07	104, 602		



50176-95	564	50602-89B	306	51060-08	306, 434, 568	51512-02	75, 145	51700-09	359	52036-08	142
50177-95	564	50603-40T	568	51072-09	362	51513-02	75, 145	51703-05	359	52038-08	228
50178-09	108, 180, 294, 437, 565	50603-74TA	568	51074-10	29, 72, 142	51514-02	75, 145	51704-05	357	52050-00	225, 238
50187-96	562	50610-86T	107	51076-10	228, 365	51515-02	75, 145	51711-06	147	52053-96	221
50190-96	562	50614-40TA	567	51078-10	29, 72, 142, 228, 365	51517-02	75, 145	51726-05	360	52060-98	365
50193-96	307, 438	50614-66T	567	51092-04	361	51518-02	145	51727-05	373	52061-98	365
50194-96	307, 438	50614-91A	567	51093-04A	361	51519-02	75, 145	51729-09	357	52062-98	365
50198-97B	437	50627-08	554	51099-02	238	51525-09	354	51732-10	146	52066-97C	355
50202-04	557	50631-04	434, 563	51102-01A	357	51526-09	354	51736-07	72	52067-08	355
50203-04	107	50634-05	305, 556	51112-00B	225	51527-09	355	51737-07	71	52069-98	221
50210-06	181	50643-82	567	51114-00	238	51533-04	71	51738-07	71	52087-98	235
50211-04	563	50646-82	567	51119-01A	30	51534-00	238	51739-07	72	52093-08	360
50212-98	108	50647-82	567	51120-01A	30	51535-06A	141	51744-07	73	52095-08	355
50214-98A	179	50683-04	568	51120-07	30	51538-00	71	51745-09	709	52099-09	357
50227-01	180, 294	50688-04	568	51126-01A	30	51538-04	71	51747-07	70	52105-93C	72
50233-00	303, 428	50695-08	554	51132-98	72, 76, 139, 140, 147, 235	51539-00	73	51749-07	70	52109-04	72
50246-00	307, 438	50704-04	561	51138-07	30	51539-04	73	51750-07	71	52112-04	72
50249-05	303	50710-04	561	51140-04A	30	51540-01A	139	51751-07	71	52124-09	144
50250-04	108	50713-04	561	51142-04A	30	51540-04	139	51762-06	226	52127-05	364
50251-01	428	50716-04	307, 435, 569	51144-02	238	51540-06	139	51763-07	227	52130-05	364
50270-02A	48	50743-04	655	51145-04A	30	51542-01B	360	51764-06	224	52137-83	771
50281-01	180, 294, 565	50752-04	307, 435, 569	51146-10	78	51544-01A	72	51770-09	359	52159-06	140
50295-02	560	50763-09	50, 107, 181, 437	51156-06	30	51546-04	73	51778-07	27	52193-08	709
50305-02	558	50768-07	436	51157-04A	359	51564-09	367	51780-07	27, 29	52198-03	70
50310-02	560	50782-91	307, 438	51161-10	146	51569-01	29	51781-07	28	52201-86B	389
50312-03	560	50787-09	303	51162-06	30	51570-00A	225	51782-07	31, 146, 239	52201-97A	363, 389
50347-03	292	50789-99B	436	51168-10	145	51579-05	372	51783-07	27, 29	52225-89	222
50357-04	307, 435, 569	50807-08	304, 435, 569	51177-06	30	51583-01	31	51787-08	222	52246-08	709
50358-04	557	50809-02A	49	51220-07	30	51587-05	236	51800-09	709	52265-01A	355
50359-04	557	50810-08	304, 435, 569	51313-07	30	51600-09	32	51801-07	225	52269-08	220
50360-04	48	50827-07A	433, 570	51322-08	306, 434, 568	51607-09	32	51804-02	141, 229, 365	52270-08	220
50363-05	305, 558	50828-07A	433, 570	51345-08	304, 568	51615-09	360	51810-05	73	52271-09	225
50370-04	561	50829-07A	432, 570	51353-06	136	51615-99C	360	51813-09	224	52274-94A	389
50377-07A	305	50830-07A	432, 570	51359-06	137	51617-99C	361	51830-06	227	52284-04	135
50378-07A	434	50832-07A	433, 570	51369-06	137	51619-09	709	51839-10	367	52284-06	135
50379-07A	435	50836-07	307, 438	51375-06	136	51620-09	709	51841-06	224	52284-96A	135
50396-05	305, 556	50855-09	301	51376-09	553	51621-09	709	51851-09	75, 145, 232	52288-04	138
50399-05	306	50863-09	49	51381-06	137	51622-07	234	51898-05A	227	52288-06	138
50399-07A	306	50865-09	301	51387-06A	219	51626-09	709	51902-09	222	52289-04	138
50400-05	306	50900-72TA	571	51393-06A	219	51630-06	360	51922-09	223	52292-00A	221
50400-07A	306	50903-85T	571	51397-06A	221	51630-09	360	51928-01	361	52292-94B	221
50409-04	434	50904-85T	571	51400-08	304, 568	51631-09A	367	51929-01	361	52295-94A	135
50420-05	563	50911-08	554	51401-07	220	51633-06	372	51933-01	139	52296-94B	70
50451-09	50, 108, 180, 294, 304, 437, 565	50915-90T	566	51404-10	141	51634-06	389	51933-04	139	52312-07	559
50454-09	304	50916-90T	566	51444-04A	354	51635-06	388	51933-06	139	52333-97D	363
50459-06	306	50932-08	303	51468-06A	224	51637-97	77, 142, 229, 365	51934-01	139	52335-97	363, 389
50460-06	306	50935-07	559	51469-06A	226	51638-97	77, 142, 229, 365	51936-08	220	52341-97D	363
50472-08	563	50957-02B	177, 301, 433, 570	51470-06A	226	51639-97	229, 365	51937-10	138	52347-97	235
50474-03	565	50964-98	571	51471-06	140	51640-06	234	51985-08	223	52348-97	235
50500-03	564	50968-07	559	51472-06	139	51642-06	234	51998-08	223	52359-04	135
50541-03	655	50976-99	555	51473-06A	139	51645-06	31	52004-25	222	52359-06	135
50549-08	554	50978-99	555	51474-06A	141	51667-98	76, 147	52006-47B	222	52359-97	135
50576-05	556	51000-02	50	51477-06	232	51676-96	141, 229	52017-08	73	52361-00A	221
50598-89T	567	51011-01	555	51481-08	222	51676-97A	73, 141, 229, 365	52018-08	228	52378-07	135
50599-89T	305, 569	51017-01	555	51507-04	72	51687-06	236	52023-01A	29	52379-04	70
50602-00A	306	51039-05	303	51509-04	72			52024-01	28	52381-04	70
								52031-96	388	52395-03	389
								52032-96	388	52408-07	372



# 802 PART#/PAGE# REFERENCE

52412-79A	76, 147, 235	52737-94A	75, 145, 232	53030-05	27	53111-09CWA	382	53149-06BYW	390	53155-05BRE	386
52423-09A	366	52738-94A	75, 145, 232	53036-05	27, 29	53111-09CWS	383	53149-06CAX	390	53155-05BRF	386
52442-04A	226	52739-83	75, 145	53040-05	364	53111-09CWV	383	53149-06GY	390	53155-05BRG	386
52447-96	364	52744-94	75, 145	53042-01A	140	53111-09CWW	383	53149-07CGP	390	53155-05BRH	386
52461-00A	221	52748-02	31	53042-04	140	53111-09CXN	727	53149-07CGR	390	53155-99AB	386
52464-09A	366	52749-85A	75, 145, 232	53048-06	374	53111-09CYN	382	53149-07CGS	390	53155-XU	386
52501-09A	366	52754-04	75, 145, 232	53050-04C	80	53111-09CYS	382	53149-07CGT	390	53172-05BSB	385
52512-02	235	52759-04	30	53051-09	358	53111-09CZB	383	53149-07CGV	390	53172-05BSE	385
52513-94	76, 146, 234	52777-85A	75, 145	53055-05A	255	53111-10BJN	382	53149-07CHG	390	53194-07	380
52517-94	76, 146, 234	52783-96B	144	53057-07A	378	53111-10CWB	382	53149-07CHH	390	53209-09	255
52527-01	77, 147, 237	52786-84B	231	53061-00B	246	53111-10CYT	383	53149-07CHY	390	53213-04BKK	383
52530-09A	367	52791-86A	231	53066-00C	254	53111-10DBJ	382	53149-07CHZ	390	53213-04BKM	383
52531-01	77, 147, 237	52796-09	150	53070-00A	436	53111-10DBM	383	53149-07CJA	390	53217-04BKA	386
52532-90	235	52804-08	239	53075-03	233, 251	53111-10DBN	382	53149-08CAS	390	53217-04BKB	386
52533-93A	227	52805-97B	370	53086-04	371	53111-10DBO	383	53149-08COZ	390	53217-04BKD	386
52534-93A	227	52806-94B	74	53092-08A	378	53111-10DBW	383	53149-08CPC	390	53217-05BRE	386
52540-09	232, 237	52825-05	371	53100-96	394	53111-10DBX	383	53149-08CPD	390	53217-05BRF	386
52544-05A	356	52849-04A	70	53111-03BDR	383	53111-10DCF	383	53149-08CPF	390	53217-05BRG	386
52545-84	76, 147, 235	52852-05	226	53111-03BDS	383	53111-10DCK	382	53149-08CPG	390	53217-99AB	386
52546-09A	366	52856-06	144	53111-03BFG	383	53111-10DCL	383	53149-08CPH	390	53246-09A	376
52555-94A	373	52859-04A	70	53111-03EU	383	53111-96DH	382	53149-08CPJ	390	53249-01B	401
52563-82	76, 147, 234	52866-06	144	53111-03LI	383	53111-99AB	383	53149-08CPK	390	53260-02	377
52572-09A	367	52872-01	83, 250	53111-04BHY	383	53111-99CF	383	53149-08CPL	390	53260-09A	376
52583-09A	367	52877-08	145	53111-04BHZ	382	53116-00KB	384	53149-08CRR	390	53270-06BPS	384
52587-09	367	52877-10	145	53111-04BJG	383	53116-00QH	384	53149-08CTF	390	53270-06BPY	384
52589-09	367	52886-98C	372	53111-04BJJ	383	53116-00ZQ	384	53149-09BYM	390	53270-06BXT	384
52591-09A	366	52892-98A	389	53111-04BJL	382	53116-01XE	384	53149-09CFZ	390	53270-06DTH	384
52593-09A	366	52898-98A	388	53111-04BKA	383	53116-02ZB	384	53149-09CWA	390	53270-07CHG	384
52596-09A	366	52900-09A	367	53111-05BPO	382	53116-03BDP	384	53149-09CWN	390	53270-07CHH	384
52609-05	356	52909-02	75, 145	53111-05BPR	382	53116-03BDT	384	53149-09CWR	390	53270-08CGS	384
52610-09	370	52912-00	227	53111-05BPS	382	53116-04BBN	384	53149-09CWT	390	53270-08COR	385
52612-95	76, 147, 235	52914-09A	367	53111-05BPT	383	53116-04BHS	384	53149-09CYE	390	53270-08COZ	384
52619-08	356	52915-07	227	53111-05BPV	382	53116-04BHT	384	53149-09CYS	390	53270-08CPC	384
52620-95	221	52916-04A	70	53111-05BPY	382	53116-04BHV	384	53149-09CZB	390	53270-08CPD	384
52621-09	388	52918-98B	355	53111-05BPZ	382	53116-04BHX	384	53149-09DAA	390	53270-08CPG	384
52626-04	76, 146, 234	52920-98A	372	53111-05BRD	382	53116-04BJK	384	53149-10BZN	390	53274-06BHY	385
52627-09	370	52923-04A	70	53111-05BRJ	382	53116-04BJL	384	53149-10DBJ	390	53274-06BPT	385
52629-00	221	52924-98A	372	53111-06BXT	382	53116-05BPO	384	53149-10DBP	390	53274-06BXZ	385
52631-07	78, 146, 236	52927-05	28	53111-06BXY	382	53116-05BPS	384	53149-10DBV	390	53274-07CHC	385
52633-08	364	52930-05	227	53111-07BNR	382	53116-05BPV	384	53149-10DCE	390	53274-08CPX	385
52652-04	76, 146, 234	52931-99	702	53111-07CGP	382	53116-05BPY	384	53149-10DCN	390	53276-04	377
52655-84	75, 145	52933-97B	370	53111-07CGR	382	53116-05BPZ	384	53149-10DDZ	390	53276-09A	376
52656-04	76, 146, 234	52935-04	370	53111-07CGS	382	53116-05BRK	384	53149-10DEC	390	53281-06	232
52657-04A	373	52940-04A	70	53111-07CGY	383	53116-97DH	384	53149-10DEF	390	53282-06	232
52689-09	141	52941-04A	70	53111-07CHG	382	53147-98C	378	53149-10DEH	390	53285-06	400
52706-07	75, 145, 232	52952-97	365	53111-07CHH	382	53149-03LZ	390	53149-10DEK	390	53287-06BKA	387
52708-97B	373	52959-08	227, 239	53111-08COR	383	53149-03TQ	390	53149-10DEM	390	53287-06BPZ	387
52709-97B	373	52965-98	76, 147, 235	53111-08COZ	382	53149-04BHT	390	53149-99	390	53287-06BZD	387
52710-07	74	52975-05	357	53111-08CPC	382	53149-04BHX	390	53149-99DH	390	53287-06BZE	387
52714-04	436	52976-05	357	53111-08CPD	382	53149-04BNR	390	53155-00EF	386	53287-06BZF	387
52715-04A	306	52997-98	698	53111-08CPF	382	53149-05BPS	390	53155-01XV	386	53287-06BZG	387
52723-06	371	52998-98	698	53111-08CPG	382	53149-05BPV	390	53155-02BBY	386	53287-06BZH	387
52726-09	146	53007-98	75, 145, 232	53111-08CPR	383	53149-05BPY	390	53155-03BDP	386	53287-06BZJ	387
52728-95	75, 145	53009-03	233, 251	53111-08CPY	383	53149-05BPZ	390	53155-04BKA	386	53287-06BZK	387
52729-08	236	53010-98	75, 145, 232	53111-09BKR	383	53149-06BXT	390	53155-04BKB	386	53287-07BNR	387
52731-00	232	53011-98	374	53111-09BYM	382	53149-06BXY	390	53155-04BKC	386	53287-07BPS	386
52735-85	75, 145, 232	53015-05B	246	53111-09CFZ	383	53149-06BYF	390	53155-04BKD	386	53287-07BPY	386
52736-85A	75, 145, 232	53020-06A	144	53111-09CST	727			53155-04BKE	386	53287-07BXT	386

53287-07BXY	387	53332-07CHA	385	53742-04	78, 148	53929-08CPJ	82, 250	54089-10	138	55736-07	609
53287-07CGP	387	53332-07CHD	385	53743-97	374	53929-08CPK	82, 250	54091-10	147	55737-07	609
53287-07CGR	387	53332-08CPR	385	53762-06	27, 31	53929-08CPL	82, 250	54097-10	543	55749-07	609
53287-07DH	387	53332-08CPS	385	53763-06	29	53929-09CWA	82, 250	54099-10	366	55750-07	609
53287-08COR	386	53332-08CPX	385	53767-98	379	53929-09CWL	82, 250	54114-10	255, 378	55751-07	609
53287-08COR	387	53332-08CPY	385	53797-09	144	53929-09CWN	82, 250	54144-10	458	55752-07	609
53287-08COR	386	53341-97A	375	53803-06	369, 543	53929-09CWR	82, 250	54205-09	369	55835-05A	576
53287-08COZ	386	53359-02	219	53804-06	369, 543	53929-09CWT	82, 250	54210-09	240	55854-07	584
53287-08CPC	386	53370-95B	233	53806-00	238	53929-09CYS	82, 250	54213-09	374	55861-09	576, 595
53287-08CPD	386	53371-95A	233	53810-00B	231, 233	53929-10BHT	82, 250	54215-09	374	55862-09	576, 595
53287-08CPF	386	53373-02A	354	53815-00	231, 233	53929-10DBJ	82, 250	54246-09	369	55864-09	576, 591
53287-09BNR	387	53374-03	231	53820-00	233	53929-10DBP	82, 250	54247-09	370	55865-09	576, 595
53287-09BPY	387	53378-03A	231	53821-00	233	53930-03	233	54248-09	370	55866-09	576, 595
53287-09CPC	387	53387-03A	231	53822-00	233	53931-03	233	54249-09	369	55869-10	553
53287-09CYE	387	53388-03	231	53824-00	233	53932-03	233, 245	54250-10	78	55876-10	584
53287-09CYS	387	53407-06	232	53826-00B	399	53935-08	239	54252-10	148	55908-04	576
53287-09DH	387	53432-02	27	53828-00	149	53938-04	375	54256-10	232	55908-08	576
53301-06	400	53472-09	375	53834-00A	144	53939-03	79, 149, 241	54258-10	231	55914-98	576, 593
53302-07	400	53494-04	79	53839-00	144	53948-04	79	54263-10	240	55919-82	576, 595
53303-07	377	53495-95	79	53842-00C	440	53953-06	240	54265-10	543	55919-82T	576, 595
53315-09	32	53510-07	78, 148, 240	53850-00A	79, 241	53957-08	239	54268-10	233	55920-83B	576, 595
53325-06BKA	387	53511-06	150	53857-00B	231, 233	53959-06	233	54331-04	657	55924-97	576
53325-06BZD	387	53512-07	79	53858-01	144	53961-06	144	54332-04	657	55934-89	576, 595
53325-06BZE	387	53527-95A	144	53859-02A	233	53963-09BHY	385	54333-04	657	55934-92	576, 595
53325-06BZF	387	53528-95B	74	53862-00	79, 149, 241	53963-09CPS	385	54352-09	650	55943-05	576
53325-06BZG	387	53529-04	74	53866-00	79, 149	53963-09CPY	385	54360-05	254, 379	55954-00	576, 594
53325-06BZH	387	53531-95A	233	53870-01A	144	53963-09CST	727	54530-10	65	55955-00A	576
53325-06BZJ	387	53532-02	74	53878-03	398	53963-09CWB	385	54564-09	407	55958-01	576, 588
53325-06BZK	387	53533-02A	144	53882-02A	144	53963-09CWC	385	54588-94	259	55967-08	576, 578
53325-07BNR	387	53543-95A	144	53887-05	398	53963-09CWK	385	54594-03	158	55972-00	576
53325-07BPS	386	53544-04	74, 80	53896-06	241	53963-09CXN	727	54596-94	259	55975-08A	576, 584
53325-07BPY	386	53545-95	74	53899-02	78, 149	53963-09CYT	385	54598-02	407	55977-09	576, 588
53325-07BPZ	387	53548-02A	401	53900-02	78, 149	53963-09CYV	385	54599-02	407	55985-10	576, 584
53325-07BXT	386	53549-95	231, 233	53911-01	399	53963-10CYS	384	54614-05	407	55996-09	596
53325-07BXY	387	53552-81A	75, 145, 232	53913-04	74	53963-10DBM	385	54616-96	101	56004-00	576
53325-07CGP	387	53559-04A	254	53919-04A	440	53963-10DCK	385	54619-08	158	56006-88C	552
53325-07CGR	387	53566-09	375	53920-08	64	53963-10DH	384	54621-05	158, 259	56021-04B	102, 576, 588
53325-07DH	387	53579-01	400	53925-04	74	53964-06A	144, 543	54625-06	158	56029-00	576, 589
53325-08COR	386	53598-88A	403	53928-05	236	53965-06	241	54628-06	407	56032-08	576, 580
53325-08COR	387	53603-08	402	53929-06AV	82, 250	53968-06C	144	54630-03A	407	56036-08	576, 590
53325-08COR	386	53605-97	403	53929-06BHS	82, 250	53974-06	159	54631-02B	407	56039-03A	576, 586
53325-08COZ	386	53612-08	242	53929-06BHX	82, 250	53975-06	159	54635-09	407	56047-03C	550, 560
53325-08CPC	386	53618-05	233, 236	53929-06BNR	82, 250	53976-08	64	54651-05	259	56047-08A	550, 560
53325-08CPD	386	53621-98	83, 255, 403	53929-06BPO	82, 250	53979-07A	242	54652-05	259	56049-08	551, 559
53325-08CPF	386	53640-96	395	53929-06BPS	82, 250	53982-08	148	54676-09	158	56052-00	598
53332-06BHY	385	53649-05	242	53929-06BPY	82, 250	53988-07	369, 543	54704-07	101	56055-01	576, 589
53332-06BJG	385	53652-05	242	53929-06BPZ	82, 250	53989-08	240	54733-04	101	56060-01	598
53332-06BPR	385	53655-04	83	53929-06BXT	82, 250	54001-04A	259	54754-09	101	56063-82A	597
53332-06BPW	385	53665-87	395	53929-06DH	82, 250	54008-04	401	54758-07	259	56066-82A	597
53332-06BPX	385	53667-89A	395	53929-07CGS	82, 250	54011-04	255, 401	55700-07	609	56075-07	102, 576, 587
53332-06BRB	385	53669-89	461	53929-08CGT	82, 250	54014-05	401	55703-07	609	56079-93	576, 595
53332-06BRD	385	53670-93	395	53929-08COS	82, 250	54030-09	369	55706-07	609	56079-93T	576, 589
53332-06BXZ	385	53690-06A	83, 255, 378	53929-08COV	82, 250	54049-10	148	55709-07	609	56081-82A	576, 595
53332-06BYA	385	53692-96	233, 246	53929-08COZ	82, 250	54051-08	254	55712-07	609	56081-82T	103, 576, 589
53332-06BYC	385	53702-04A	661	53929-08CPC	82, 250	54055-10	148	55723-10	609	56082-83	576, 595
53332-07CGX	385	53711-96A	78, 149	53929-08CPE	82, 250	54072-10	71, 138	55733-07	609	56082-83T	103, 576, 589
53332-07CGY	385	53713-96A	79, 241	53929-08CPF	82, 250	54074-10	71	55734-07	609	56085-83A	103, 576, 595
53332-07CGZ	385	53718-04	78, 148, 240	53929-08CPH	82, 250	54075-10	138	55735-07	609	56085-83T	103, 576, 589

# 804 PART#/PAGE# REFERENCE

56086-81	576	56350-03A	609	56729-04	557	57140-05	214	57800-00	345	58277-95	215
56086-81T	576	56360-09	609	56729-08	557	57141-05	214	57804-07	352	58278-95	213
56093-88A	576	56391-04	576	56735-04	552	57160-05	211	57805-03A	402	58283-04A	342
56101-98	598	56399-03	608	56740-04	561	57177-05	24	57807-04	341	58284-04A	342
56102-99	576, 595	56405-08	554	56740-08	561	57185-05	345	57837-00A	209	58297-94	703
56103-08	576	56411-03	608	56741-04	561	57199-05	131, 211	57838-08	67, 132	58298-87	703
56110-98	103, 576, 595	56414-03	608	56746-08	554	57202-07	559	57844-05	402	58301-96	344
56113-98	576, 103	56422-02C	576	56750-04B	551, 557	57202-08	559	57846-01	343	58302-96	344
56150-04	576	56425-02	558	56751-04	561	57203-07	701	57850-01	34	58303-96	344
56152-04B	576, 590	56425-08	558	56757-05	552	57205-05	52	57861-06	25	58308-95	703
56154-04	576, 588	56434-98	576	56760-04	576, 577	57207-05A	703	57870-07	25	58313-96	400
56165-03	103, 176, 290, 597	56443-00A	555	56775-04	609	57211-05	24	57957-98	343	58314-97	344
56166-08	576, 590	56457-00A	609	56789-05	268, 639	57213-06	25	57965-97A	133, 209	58325-06	339
56170-83TA	598	56459-01A	556	56793-05	576	57216-07A	703	57969-97A	209, 217	58346-06	131
56174-03C	551, 564	56459-08	556	56799-04	556	57220-07A	703	57975-99	215	58347-06	131
56176-08	576, 593	56469-93C	150	56802-06	150	57226-06	25	57981-97	339	58348-06	131
56177-92TA	598	56473-98	103, 576	56805-05A	609	57229-06	25	57988-09	343	58350-96	133, 209
56178-92TA	598	56481-03	242	56807-05A	609	57239-05A	703	57995-96	339	58360-09	131, 212
56180-08	576, 591	56486-01	103, 177, 290, 597	56808-05A	609	57251-08	210	58002-09	352	58361-03	133, 212, 630
56184-08	576, 592	56495-02	150	56809-05	609	57253-08	210	58016-89A	345	58376-09	131, 212
56196-03C	551, 564	56512-02C	550, 556	56810-05	609	57260-08	64	58022-07A	352	58387-06	131
56196-08A	551, 564	56512-08A	550, 556	56828-03B	551, 558	57262-08	64	58024-96A	68	58397-00	209
56196-0A	564	56518-02	560	56828-08A	551, 558	57300-06	132	58042-04BDK	738	58402-04	701
56210-94T	552	56518-08	560	56832-04	576, 582	57301-06	132	58042-04DH	738	58413-06	131
56217-94T	552	56528-02	576	56855-05	576	57331-07	132, 209	58042-08BDK	738	58433-96	341
56223-98	597	56533-02A	576	56856-05	576	57335-08	346, 654	58042-08DH	738	58444-06	131
56241-96	564	56552-95	576, 595	56857-05	576, 580	57338-08	131	58063-04	67, 131	58468-09BDK	445
56246-08	564	56556-95	103, 576, 589	56870-06	656	57340-08	131	58073-09	216	58468-09BPY	445
56246-96A	564	56557-95	576, 595	56902-08	576, 591	57357-07	340	58120-96A	352	58468-09BYM	445
56254-09	553	56558-95	103, 576, 589	56904-06	552	57400-06	351	58121-85B	341	58468-09CGR	445
56257-09	553	56562-95	576	56916-07	596	57411-08	351, 753	58125-90B	270	58468-09CGS	445
56263-08	564	56563-95	103, 576, 589	56926-05A	551, 561	57609-08	132	58135-94	341	58468-09CHH	445
56263-96A	564	56564-02	609	56926-08A	551, 561	57610-09	25	58146-07	348	58468-09COZ	445
56266-09	597	56567-86B	598	56940-09	576, 587	57621-06BDJ	34	58156-08	352	58468-09CPC	445
56267-09	596	56569-86	576, 595	56941-09	576, 591	57621-06BDP	34	58157-07	584	58468-09CPD	445
56269-09	596	56570-98	576	56947-08	576, 589	57621-06BJK	34	58158-08	68, 132	58468-09CPF	445
56273-08	576	56571-98A	576	56964-07	576, 592	57621-06BJL	34	58161-09	216	58468-09CPG	445
56275-08	562	56579-02A	609	56981-07	46, 576	57621-06BPS	34	58163-02	340	58468-09CPH	445
56275-96B	562	56590-02	608	56997-07	551, 559	57621-06BPV	34	58164-96A	68, 133	58468-09CPJ	445
56285-98	552	56595-03A	609	57006-03	287	57621-06BPZ	34	58165-09	216	58468-09CPK	445
56290-05	596	56616-03	609	57014-04	702	57621-06BYF	34	58166-08	352	58468-09CPL	445
56296-05	596	56619-03B	551, 562	57015-06	132	57621-06BYM	34	58181-78	344	58468-09CWA	445
56298-03	427, 597	56621-99	576	57016-06	132	57621-06DH	34	58187-86	344	58468-09CWL	445
56308-88T	794	56623-99	576, 594	57039-03BDK	738	57621-06NZ	34	58187-96	344	58468-09CWN	445
56309-88	794	56624-99	576, 595	57039-03BDK	738	57621-07BPY	34	58189-98	703	58468-09CWR	445
56313-76T	794	56625-99	576, 595	57039-03DH	738	57621-07CGP	34	58192-87A	68, 133	58468-09CWT	445
56314-78	794	56626-99	702	57039-08BDK	738	57688-10	213	58194-94	341	58468-09CWE	445
56323-81TA	794	56658-00	552	57039-08DH	738	57701-08	217	58195-94	341	58468-09CYS	445
56324-81TA	794	56675-05	576	57040-01	738	57702-08	217	58204-98	345	58468-09DWH	445
56327-81TB	794	56676-02	552	57040-01DH	738	57716-01	68, 133	58207-04	345	58468-10DBJ	445
56328-81TB	794	56700-03A	576	57040-08	738	57734-00	215	58221-04	341	58468-10DBV	445
56330-00	576, 588	56711-03	563	57040-08DH	738	57740-05	352	58236-08CST	727	58468-10DCE	445
56331-81T	794	56715-06	609	57061-00	215	57748-04	215	58236-08CXN	727	58481-02	699
56336-83T	794	56719-03	609	57061-09	215	57749-04	215	58240-95	215	58502-80C	351
56340-04	609	56720-03	609	57070-97DH	68, 739	57754-04	215	58243-95	213	58508-09BDK	445
56344-03A	609	56723-04	609	57070-98	68, 739	57767-00	339	58248-96	347, 700	58508-09BHS	445
56345-03A	609	56726-07	609	57101-01	287	57768-00	341	58262-05	442	58508-09BHV	445
				57109-01	25	57799-00	142, 228	58275-95	215	58508-09BHX	445

58508-09BJK	445	58606-08CPC	390	58722-09BPO	445	58854-05ZB	349	58900-98B	347, 700	59765-98	422
58508-09BJL	445	58606-08CPD	390	58722-09BPS	445	58854-05ZQ	349	58904-03	701	59776-10	648
58508-09BPS	445	58606-08CPF	390	58722-09BPY	445	58854-06BXT	349	58907-96B	209, 216, 217	59802-05	131, 211
58508-09BPV	445	58606-08CPG	390	58722-09BPZ	445	58854-06BXY	349	58928-08	347, 700	59863-94T	662
58508-09BPY	445	58606-08CPH	390	58722-09BXT	445	58854-06BYF	349	58932-98	400	59899-88T	661
58508-09BXT	445	58606-08CPJ	390	58722-09BXY	445	58854-07CGP	349	59002-98	420	59925-06	743
58508-09BXY	445	58606-08CPK	390	58722-09CGP	445	58854-07CGR	349	59005-98	421	59925-06DH	743
58508-09CGP	445	58606-08CPL	390	58722-09CGR	445	58854-07CGS	349	59013-02A	422	59931-08	242
58508-09CGR	445	58606-08CRR	390	58722-09COZ	445	58854-07CGT	349	59027-99	285	59983-75T	661
58508-09CGS	445	58606-08CTF	390	58722-09CPC	445	58854-07CGV	349	59045-00B	741	59985-04	84, 743
58508-09CGT	445	58606-09BYM	390	58722-09CPD	445	58854-07CHG	349	59052-98	420	59985-07	84, 743
58508-09CGV	445	58606-09CFZ	390	58722-09CPE	445	58854-07CHH	349	59054-96	741	60025-01	84, 743
58508-09CHG	445	58606-09CWA	390	58722-09CPF	445	58854-08COZ	349	59068-96	286, 420	60025-01DH	84, 743
58508-09CHH	445	58606-09CWN	390	58722-09CPH	445	58854-08CPC	349	59069-96	286, 420	60041-04	661
58508-09CHY	445	58606-09CWR	390	58722-09CPE	445	58854-08CPD	349	59071-98	285	60050-01	662
58508-09DH	445	58606-09CWT	390	58722-09CYP	445	58854-08CPG	349	59081-96	286, 420	60051-01	662
58508-09XE	445	58606-09CYE	390	58722-09DH	445	58854-08CPH	349	59133-99	346	60052-04DH	84, 743
58519-07A	343	58606-09CYS	390	58722-10BYM	445	58854-09BYM	349	59141-98	662	60052-07DH	84, 743
58520-79TC	414	58606-09CZB	390	58722-10DBJ	445	58854-09CWA	349	59146-96	285, 421	60060-04	119, 662
58525-95A	351	58606-09DAA	390	58742-05	133, 211, 643	58854-09CWL	349	59147-96	285, 421	60065-03	662
58562-96A	301	58606-10BZN	390	58751-05	131, 211	58854-09CWN	349	59209-91T	284, 420	60081-00	743
58568-98A	352	58606-10DBJ	390	58753-01A	342	58854-09CWR	349	59213-96	346	60179-06	285, 421
58593-97	738	58606-10DBP	390	58770-96	217	58854-09CWT	349	59217-03	171, 284	60193-07	119, 660
58601-04	67, 131	58606-10DBV	390	58771-96	217	58854-09CYE	349	59228-91	285, 421	60197-08	271
58602-04	67, 131	58606-10DCE	390	58772-97	216	58854-09CYS	349	59230-88	285, 422	60210-07	660
58606-03LZ	390	58606-10DCN	390	58779-05	211	58854-10DBJ	349	59239-93	399	60215-06	119, 660
58606-03TQ	390	58606-10DDZ	390	58799-02	340	58854-10DBV	349	59285-90	286	60236-09BEO	84, 742
58606-04BHT	390	58606-10DEC	390	58830-88	350	58854-10DCE	349	59286-90	286	60236-09DH	84, 742
58606-04BHX	390	58606-10DEF	390	58830-88DH	350	58854-10DEH	349	59315-98	286, 420	60236-10BEO	84, 742
58606-04BNR	390	58606-10DEH	390	58841-98	350	58854-10DEK	349	59320-07	242	60236-10DH	84, 742
58606-05BPS	390	58606-10DEK	390	58841-98DH	350	58854-10DEM	349	59336-09	646	60277-07	660
58606-05BPV	390	58606-10DEM	390	58854-05	349	58861-04BBP	350	59337-09	646	60280-07	119, 660
58606-05BPY	390	58606-99	390	58854-05AV	349	58861-04BDK	350	59338-09	646	60293-00	166
58606-05BPZ	390	58606-99DH	390	58854-05BBN	349	58861-04BHS	350	59348-98	286, 420	60293-90A	166
58606-05BRK	390	58617-09	131	58854-05BDP	349	58861-04BHV	350	59349-97	399	60303-06	166
58606-06BXT	390	58628-99	215	58854-05BDT	349	58861-04BJL	350	59366-97	286	60303-07A	166
58606-06BXY	390	58630-09	131	58854-05BHS	349	58861-04DH	350	59367-97	286	60316-00A	272
58606-06BYF	390	58649-97A	214	58854-05BHT	349	58861-05BPO	350	59368-97	286	60317-06	272
58606-06BYS	390	58651-97A	214	58854-05BHV	349	58861-05BPS	350	59369-97	286	60345-08	272
58606-06BYW	390	58652-97A	214	58854-05BHX	349	58861-05BPY	350	59380-05	646	60379-09	98
58606-06BYY	390	58653-97A	214	58854-05BJK	349	58861-05BPZ	350	59381-05	646	60389-97A	272
58606-06CAX	390	58657-97A	215	58854-05BJL	349	58861-06BXT	350	59385-98	422	60402-04	98
58606-06GY	390	58658-97A	215	58854-05BPO	349	58861-06BXY	350	59386-98	422	60408-09	415
58606-07BSC	390	58683-89B	351	58854-05BPS	349	58861-07BNR	350	59397-03DH	741	60413-04	98
58606-07CGP	390	58684-89B	351	58854-05BPV	349	58861-07CGP	350	59397-98	741	60469-01A	40
58606-07CGR	390	58687-89	351	58854-05BPY	349	58861-07CGR	350	59429-04	118, 650	60475-92A	166
58606-07CGS	390	58688-89A	351	58854-05BPZ	349	58861-08COZ	350	59448-09	646	60476-00A	271
58606-07CGT	390	58691-04	215, 341	58854-05BRK	349	58861-08CPC	350	59470-06	118, 650	60480-94T	98
58606-07CGV	390	58703-09	67, 131	58854-05DH	349	58861-08CPD	350	59473-09	171	60484-01B	40
58606-07CHG	390	58706-09	67, 131	58854-05KB	349	58861-08CPF	350	59496-97	84, 741	60489-06A	166
58606-07CHH	390	58714-06	400	58854-05LZ	349	58861-08CPH	350	59496-97DH	84, 741	60490-08	272
58606-07CHY	390	58722-09BBP	445	58854-05NR	349	58861-09BYZ	350	59545-04	650	60491-02A	415
58606-07CHZ	390	58722-09BDK	445	58854-05NV	349	58861-09CYE	350	59582-02A	285, 421	60493-04A	40
58606-07CJA	390	58722-09BHS	445	58854-05QC	349	58861-09CYS	350	59651-01	286, 420	60495-04	40
58606-07CJX	390	58722-09BHT	445	58854-05QH	349	58861-09DAK	350	59664-03	171, 284	60514-07A	166
58606-07CKF	390	58722-09BHV	445	58854-05TQ	349	58865-03	133, 212	59685-10	648	60529-90A	523, 527
58606-08CAS	390	58722-09BJL	445	58854-05XE	349	58882-04BDK	738	59720-01A	119, 661	60543-86A	527
58606-08COZ	390	58722-09BNR	445	58854-05ZA	349	58882-04DH	738	59726-04	53	60543-89	527



# 806 PART#/PAGE# REFERENCE

60543-94	527	61308-09	440	62732-06BXY	744	62995-04	533	65247-09	479	66263-08CPL	739
60543-95	527	61319-09	440	62732-06BXZ	744	62996-07	90	65271-03	37	66263-09CWA	739
60543-99B	526	61335-09	440	62732-06BYA	744	62999-04	744	65694-05A	490	66263-09CWL	739
60553-07	526	61356-08CST	727	62732-06BYC	744	62999-07	744	65829-00	490	66263-09CWR	739
60568-91TA	520	61356-08CXN	727	62732-07BNR	744	63002-09	315, 537	65948-00A	783	66263-09CWT	739
60569-91TA	520	61359-98	440	62732-07BPS	744	63004-09	449, 537	65958-04A	783	66263-09CYS	739
60572-86	523, 527	61374-04	440	62732-07BPY	744	63020-04	535	65989-90B	783	66263-10BYM	739
60584-98	521	61556-04	188	62732-07BXT	744	63023-05	90	65989-97C	783	66263-10DBJ	739
60585-98	521	61653-04	113	62732-07BXY	744	63026-05	175, 290, 597	65991-82B	783	66263-10DBP	739
60607-08	545	61655-91	184	62732-07CGP	744	63027-05	175, 290, 597	66006-29F	783	66264-04	93
60610-02A	272	61740-90T	746	62732-07CGR	744	63030-09	449, 537	66006-70	783	66310-02	37
60610-07	272	61741-93T	746	62732-07CGS	744	63055-09	315, 537	66007-84	783	66328-82T	93
60618-01	518	61742-93T	746	62732-07DH	744	63065-09	189, 537	66010-82B	783	66331-05	37
60639-00	524	61769-40T	746	62732-08CGZ	744	63087-07	90	66010-97C	783	66333-90	173
60649-07	272	61769-47T	746	62732-08COR	744	63131-09	449, 537	66021-00	270	66340-78	93, 172
60653-92T	520	61771-66TB	746	62732-08COZ	744	63690-00A	535	66031-91	783	66358-83	93, 172
60654-07	272	61773-57T	746	62732-08CPE	744	63692-00A	535	66032-91	783	66367-73	93
60655-07	272	61773-58T	746	62732-08CPF	744	63698-02	535	66050-03	414	66367-73T	794
60665-85B	527	61774-51T	746	62732-08CPR	744	63705-97	535	66053-01	270	66367-97	93
60665-89	527	61775-59T	746	62732-08CPW	744	63709-04	535	66058-01	414	66368-97	172
60665-94	527	61776-61T	746	62732-09CWA	744	63729-04	535	66071-83T	794	66370-65T	794
60665-99B	526	61777-63T	746	62732-09CYS	744	63731-99A	784	66088-96	531	66373-06	36, 315, 537, 750
60667-85A	527	61780-91T	746	62732-10BHT	744	63782-80	784	66096-02	530	66375-06	172
60668-84B	523	61781-91T	746	62732-10BJM	744	63782-80T	784	66139-04	529	66375-97	172
60668-99	523	61782-91T	746	62732-10BYM	744	63793-01K	784	66192-99	172	66378-06	749
60670-85A	523, 527	61783-92T	746	62732-10COV	744	63796-77A	784	66217-01	533	66426-04	173
60705-09	526	61784-92T	746	62732-10COW	744	63796-77T	784	66218-01	533	66439-07	172
60711-07	166	61785-92T	746	62732-10DBJ	744	63798-99A	784	66261-04	93	66440-05	269
60713-07	526	61814-55T	746	62732-10DBR	744	63805-80A	784	66262-04	93	66441-05	269
60717-07	526	61840-94T	746	62734-96A	90	63810-80A	784	66263-04BBP	739	66442-06	172
60739-01	524	61929-98	77	62778-10	112, 187, 320, 454	63812-90	784	66263-04BHS	739	66443-06	172
60739-07	524	62027-04	77	62803-97A	188, 320, 454	63813-90	784	66263-04BHT	739	66476-73T	794
60747-01	524	62028-04	142	62809-06	534	63813-90T	784	66263-04BHX	739	66503-02	530
60751-01	524	62030-04	77	62811-08A	318	63835-87T	784	66263-04BJK	739	66508-00	529
60758-06	526	62063-01	364	62816-03	112, 188, 320, 454	63837-92T	784	66263-04BJL	739	66510-00	529
60764-06	526	62378-10	440	62818-06D	318	63840-48A	784	66263-04NZ	739	66516-07	528
60766-06	523	62470-02	531	62818-08A	318	63860-00	535	66263-04XE	739	66530-03	530
60782-06	526	62511-06	531	62819-03	112, 188, 320, 454	64100-03	704	66263-05BPO	739	66532-07	529
60792-06B	524	62512-97	93	62823-06	452	64101-03	704	66263-05BPS	739	66543-08	528
60794-06B	524	62667-87TA	90	62823-08A	452	64108-03	176, 291, 601	66263-05BPV	739	66545-07	530
60801-06	545	62668-87TA	315	62857-99	536	64115-04	291, 427, 601	66263-05BPY	739	66718-01	93, 172
60815-08	524	62692-07	536	62858-99	536	64120-06	704	66263-05BPZ	739	67057-04B	111
60837-07	40	62695-09	536	62861-99	536	64201-85C	257	66263-06BNR	739	67061-04B	111
60839-07	40	62732-04BBP	744	62863-98	87, 534	64207-89B	257	66263-06BXT	739	67074-02	629
60849-10	525	62732-04BHS	744	62896-00B	315	64216-09	257	66263-06BXY	739	67182-04	111
60867-08	272	62732-04BHT	744	62910-06	186	64219-96	256	66263-07CGP	739	67182-07	111
60868-10	525	62732-04BJD	744	62910-09A	186	64227-08	257	66263-07CGR	739	67182-95D	111
60869-10	423, 525	62732-04BJE	744	62920-00A	455	64230-08	257	66263-07CGS	739	67187-04	184
60870-10	525	62732-04BJL	744	62938-00E	189, 537	64267-00	698	66263-07CGT	739	67188-04	184
61195-04BJC	744	62732-04DH	744	62946-09	449, 537	64806-07A	484, 486	66263-07CHY	739	67189-95	184
61195-04BJD	744	62732-04NZ	744	62955-09	315, 537	64924-09	477	66263-08COS	739	67206-04	191, 317
61195-04BJE	744	62732-05BPO	744	62962-01A	36	64937-00A	257	66263-08COZ	739	67207-04	317
61195-05BPW	744	62732-05BPS	744	62965-01	287	64938-00	257	66263-08CPC	739	67218-04	317
61195-05BPX	744	62732-05BPX	744	62968-02	87, 534	64981-09	489	66263-08CPE	739	67221-97	184
61195-06BYA	744	62732-05BPY	744	62974-09	189, 537	64982-07	257	66263-08CPF	739	67224-04	190
61268-08CST	727	62732-06BHX	744	62982-03A	36	64983-07	257	66263-08CPH	739	67224-95C	190
61268-08CXN	727	62732-06BNR	744			64985-07A	490	66263-08CPJ	739	67231-04A	317, 448
61286-92T	440	62732-06BXT	744			65000-04	37	66263-08CPK	739		

67268-06B	191, 317	68086-08	118, 648	68478-05	53, 651	69285-05	630	69739-01	116, 647	70623-08	495
67293-95	111, 190	68087-08	118, 648	68485-04	80	69286-05A	631	69740-01	636, 647	70900-08	444
67294-95A	111, 190	68094-06C	628	68510-74C	645	69287-07	631	69749-05	637, 647	70905-07	444
67313-05A	184, 313, 447	68103-96	639	68517-94A	67, 114, 643	69289-05	632	69752-04	116, 647	70928-07	182, 318
67315-05A	184, 313, 447	68116-08	648	68544-10	153	69290-09	346, 654	69753-04	116, 647	71031-04	754
67516-04B	450	68117-08	648	68546-09	649	69294-05A	633	69754-04	116, 647	71038-04	754
67516-08	450	68118-08	648	68564-06	643	69303-02	116, 646	69755-04	116, 647	71039-04	754
67519-04B	450	68129-97	68, 739	68593-06	114, 634	69304-02	116, 646	69756-05	116, 647	71040-04	754
67519-08	450	68129-98DH	68, 739	68595-06	634	69306-02	646	69757-05	116, 647	71041-04	754
67522-04B	111, 450	68143-98A	644	68603-01	114, 133, 630	69307-02	646	69758-05	116, 647	71097-07	318
67523-04	110, 190, 316, 448	68150-05	191, 317	68605-08	630	69308-02	646	69759-05	116, 647	71114-05	444
67524-04	110, 190, 316, 448	68160-99	390	68611-98	645	69315-02	646	69760-05	116, 647	71118-05	444
67566-05A	184, 313, 447	68168-89A	651	68615-04	644	69366-07	53, 649	69761-05	116, 647	71123-05	444
67575-04	309	68169-90A	651	68617-04	644	69367-07	53, 649	69772-04	51	71124-05	444
67593-05	633	68172-06	650	68643-09	67, 114, 643	69374-05A	53	69787-07	651	71125-05	444
67610-09	652	68185-00	117, 642	68669-05	631	69400-05A	658	69790-07	651	71129-05	182, 318
67620-09	652	68189-07	113, 658	68670-05	631	69404-05	658	69791-07	638	71131-07	444
67671-09	652	68192-99	390	68682-09	655	69408-05	658	69792-07	638	71138-07	444
67678-09	652	68200-00D	751	68718-02	150, 153	69412-07	50, 658	69793-07	638	71148-05	318
67679-09	652	68200-07	751	68732-02A	153	69415-05A	113, 658	69794-07	638	71149-05	444
67680-09	652	68207-07	751	68733-02A	153	69421-05	658	69795-07	638	71153-05	444
67695-09	652	68207-07	751	68775-93TA	638	69422-05	113, 658	69797-08	635	71161-05	444
67701-09	652	68208-98A	633	68778-04	51	69423-05	50, 113, 658	69802-08	635	71165-05	444
67704-03	51, 634	68211-05	51	68863-08	52, 117, 640	69426-04	110	69817-07A	649	71167-05	444
67734-88T	638	68227-09	144, 153	68913-98B	633	69433-08	643	69818-06	632	71168-05	444
67735-91T	639	68230-97B	644	68926-00	750	69461-06A	645	69820-06	644	71172-05	182, 318
67737-88T	638	68250-08	394	68926-07	750	69462-06A	118, 645	69828-06	110, 191, 316, 448	71202-03	309
67738-91T	639	68266-03	117, 642	68927-00	750	69463-06	118, 645	69829-06	110, 191, 316, 448	71208-07	309
67750-88T	638	68271-08	394	68952-98	643	69464-06	53, 645	69844-08	52, 117, 641	71228-05	318
67751-91T	639	68273-03A	633	68953-04	191, 316, 448	69465-06	645	69845-08	52, 117, 641	71229-05	444
67752-77T	638	68286-10	394	68960-98A	191, 317	69474-07	52, 117, 640	69851-06	114, 634	71230-05	444
67761-96	638	68297-05	629	68961-98A	317, 448	69475-07	52, 117, 640	69857-07	245	71231-05	444
67774-10	649	68311-01	119, 651	68962-98A	317	69476-07	52, 117, 640	69895-08	52	71232-05	444
67775-01C	629	68317-01A	751	68971-98B	739	69492-05	642	69920-07	651	71235-05	444
67783-78T	638	68317-06A	751	69005-85T	659	69494-06	650	69926-08	117, 640	71237-05	444
67791-91T	639	68318-01A	751	69015-08	514	69577-06	642	69929-07	245	71256-07	444
67796-91T	639	68318-06	751	69018-00	751	69580-07	53, 645	69945-08	52, 117, 641	71282-04	183
67822-88	264	68319-01	751	69039-09	659	69590-07	117, 640	69960-08	52, 117, 641	71283-01	310
67863-04A	628	68319-06A	751	69042-98	740	69591-07	640	69972-08	636	71284-01	183
67864-04A	628	68328-02	751	69063-03	642	69592-07	640	69973-08	637	71288-03A	441
67871-85TA	115, 635	68328-06A	751	69079-04	642	69593-08A	52, 640	70032-09	376	71296-07	310
67884-90TA	115	68332-08	651	69112-95D	113, 659	69604-03	635	70113-08	377	71337-05	182, 318
67890-91B	269	68335-05	629	69147-03	642	69611-06	114, 634	70164-06	621	71369-08	318
67891-99	269	68341-05	629	69153-03	642	69620-04A	115, 635	70169-06	621	71370-05	444
67907-96C	268, 639	68342-05	629	69166-01A	113, 659	69622-99B	115, 636	70172-06	621	71371-05	444
67913-95T	639	68344-05	629	69167-02A	113, 658	69623-99A	115, 636	70213-02C	426, 605	71372-05	444
68005-99	641	68345-05	629	69176-02	751	69624-99A	115, 636	70222-96B	46, 104, 174, 288, 425, 600	71373-05	444
68006-83T	638	68348-05	633	69200-01	51	69627-99	636	70223-96B	425, 600	71376-05	444
68007-99	641	68352-04B	751	69208-09	116, 646	69704-00	743	70228-96C	425, 600	71377-05	444
68011-88T	651	68352-06	751	69226-09	116, 646	69709-00	115, 635	70239-07	605	71514-98	93
68011-91T	651	68358-07A	649	69227-04A	632	69710-06	743	70248-02B	426, 605	71527-04	93
68012-88E	650	68360-00	248	69228-04	632	69714-04B	743	70255-02B	426, 605	71656-07	426, 605
68012-88T	651	68375-03	248	69229-04	632	69732-05	115, 637	70270-04	115, 314, 451	71718-02	426, 605
68043-06B	628	68388-10	394	69230-04	632	69733-05	637	70264-94A	451	71790-05	439
68055-10BHP	268	68412-99	631	69234-04	632	69734-05	637	70492-07	640	71802-03	425, 600
68085-08	118, 648	68413-99	631	69235-04	632	69735-05	115, 637	70623-06	495	71803-03	425, 600
		68468-09	65	69236-04	51	69736-02	116, 647			71804-03	46, 104, 174, 288, 425, 600
		68474-04B	80	69284-05	114, 630	69738-05	115, 637				

# 808 PART#/PAGE# REFERENCE

71808-03	425, 600	74582-00	287	75027-08A	452	77108-09	623	79175-10CGT	381	80622-07	491
71813-09	425, 600	74584-99	443	75031-09	111	77117-10	624	79175-10CGV	381	80623-07	491
71816-09	425, 600	74596-00	442	75041-03	314, 449	77122-99	625	79175-10CHG	381	80674-08	479
71900-08	444	74597-01	287	75042-03	314, 449	77126-98	625	79175-10CHH	381	80677-08	488
71901-08	444	74604-99	443	75051-08	186, 319, 453	77140-05	441	79175-10COZ	381	80678-08	480
71902-08	444	74609-04	92	75054-03	314, 449	77142-06	443	79175-10CPC	381	80679-08	482
71903-08	444	74610-01	287	75055-03	314, 449	77143-07	443	79175-10CPD	381	80680-08	484
71924-08	444	74610-07	287	75084-04B	186, 319, 453	77147-91C	625	79175-10CPF	381	80681-08	486
71925-08	444	74610-08	287	75095-05A	187, 319, 453	77148-91	625	79175-10CPG	381	80716-08	438, 491
71926-08	444	74612-06	443	75097-05	112, 187, 320, 454	77155-06	622	79175-10CWA	381	80721-09	488
71927-08	444	74616-04	173, 287	75098-08	187, 319, 453	77173-08	623	79175-10CYE	381	80726-09A	477
71939-08	444	74622-04	423	75102-04	314, 449	77181-01	625	79175-10CYS	381	80732-09	490
71971-08	444	74622-06	423	75104-04	314, 449	77181-10	621	79175-10DBJ	381	80742-09	488
71972-08	444	74622-09	423	75108-06	314, 449	77182-02	426	79175-10DBV	381	80781-10	487
71973-08	444	74661-04	190, 313, 439	75110-98B	775	77183-02	426	79175-10DCE	381	80794-10	481
71982-08	318	74662-04	111, 190, 439	75113-04A	450	77196-04	426	79175-10DEH	381	80813-10	483
71984-08	318	74665-04	173	75113-08	450	77196-07	426	79175-10DEK	381	80817-10	485
71985-08	318	74667-06	173	75115-06	314, 449	77196-08	426	79175-10DEM	381	80818-10	483
71986-08	318	74676-07	185, 312, 446	75133-99	189, 315, 449	77197-04	426	79175-10DHD	381	80821-10	481
73294-10	268	74676-08	185	75137-98B	775	77197-07	426	79179-08	394	80824-10	483
73342-09	116, 647	74676-09	185	75176-08	187, 320, 454	77197-08	426	79189-06	379	80829-10	487
73343-09	647	74677-07	185, 312, 446	75231-08	187, 319, 453	77198-04	426	79192-10	388	80847-10	489
73344-09	116, 647	74677-08	185	75237-03B	186, 319, 453	77198-07	426	79211-08A	393	80871-10	173
73369-10	245	74677-09	185	75242-08	186, 319, 453	79071-09BPY	384	79224-09BNR	387	80881-10	489
74439-00	451	74682-10	450	75265-04A	451	79071-09CGR	384	79224-09BPY	387	83527-10CPC	445
74457-00	450	74683-10	450	75311-08	187, 319, 453	79071-09CHH	384	79224-09CPC	387	83527-10CWA	445
74461-03A	313, 447	74688-10	450	75320-05A	451	79071-09CPC	384	79224-09CYE	387	83527-10CYS	445
74468-03	313, 447	74689-10	450	75324-05A	451	79071-09CWS	385	79224-09CYS	387	83527-10DHD	445
74471-03A	313, 447	74690-10	450	75327-09	186	79071-09CWV	385	79224-09DHD	387	83812-09	458
74473-03A	313	74691-10	450	75338-09	111	79071-09CWW	385	79300-04C	155	83819-09	410, 457
74475-03A	313	74692-10	450	75357-10	187, 319, 453	79071-09CYE	384	79300-06C	155	83825-09	457
74497-03	37	74718-07	185, 312, 446	75358-10	187, 319, 453	79071-09CYS	384	80102-97	478	83833-09	422, 459
74537-93A	287	74718-08	185	76182-95A	626	79071-09DHD	384	80104-99	481	83841-09	458
74538-09	423	74718-09	185	76208-07	626	79071-10BHT	384	80366-99	481	83843-09	458
74541-00	190, 442	74719-07	185, 312, 446	76251-98A	626	79071-10BYM	384	80412-04	478	83845-09	459, 755
74543-00	423	74719-08	185	76312-98	625	79071-10DBJ	384	80415-04	478	83847-09	459
74544-04A	188	74719-09	185	76326-00A	626	79071-10DBN	387	80416-06	478	83921-10	457
74549-04	313, 447	74726-08	110	76340-98	626	79071-10DBO	387	80417-06	478	83928-09	459
74549-07	313, 447	74734-08	312	76386-08	625	79071-10DBW	385	80418-06	481	83954-10	457
74550-92T	442	74735-07	185	76386-09	625	79071-10DBX	387	80460-05	487	88200-09	154
74552-04A	450	74735-09	185	76388-08	625	79071-10DCF	385	80490-07	488	88227-08	64
74553-04A	450	74744-08	312	76388-08	625	79071-10DEH	385	80491-07	488	88232-06	401
74554-04	450	74745-08	446	76390-05A	620	79071-10DEK	385	80492-07	480	88237-07	245
74555-04	313, 447	74746-08	312	76400-09	626	79071-10DEM	385	80493-07	480	88238-07	245
74555-07	313, 447	74747-08	446	76404-06	622	79103-03BFG	385	80494-07	482	88256-07	245
74556-04	185, 312, 446	74748-08	312	76410-09	626	79148-06A	394	80495-07	482	88263-07	247
74556-07	185, 312, 446	74749-08	446	76412-06	621	79175-10BDK	381	80496-07	484	88265-06	694
74556-08	185	74750-08	312	76414-06	626	79175-10BHT	381	80497-07	484	88272-06	705, 771
74556-09	185	74751-08	446	76415-06	626	79175-10BNR	381	80500-07	486	88286-07	247
74557-04	185, 312, 446	74752-08	312	76416-06C	622	79175-10BPS	381	80501-07	486	88297-07	245
74557-07	185, 312, 446	74753-08	446	76418-06A	622	79175-10BPY	381	80502-07	476	88298-07	245
74557-08	185	74754-08	312	76440-06	623	79175-10BPZ	381	80503-07	476	88299-09	394
74557-09	185	74755-08	446	76530-07	620	79175-10BXT	381	80601-09	479	88306-07	245
74560-96	442	75008-02A	775	76556-09	626	79175-10BXY	381	80611-09	491	88312-07	81
74562-98	442	75012-82D	315	76561-09	626	79175-10BYM	381	80616-07A	491	88348-10	154
74577-97	173	75014-06A	318	76569-09	624	79175-10CGP	381	80618-07	491	88490-88A	461
74578-97	287	75014-08A	318	76572-09	624	79175-10CGR	381	80619-07	491	88860-97	461
74579-97	92	75020-08A	318	77107-09	623	79175-10CGS	381	80621-10	485	88861-97	461

90067-06	379	90225-06DH	253	90715-03BDT	253	90725-08BJK	253	91172-09	33	91412-08CPH	82
90126-00A	152	90225-07BYM	253	90715-03DH	253	90725-08BPS	253	91177-97	311	91412-08CPJ	82
90126-00DH	152	90225-07CGS	253	90715-03XE	253	90725-08BPY	253	91179-09	396	91412-08CPK	82
90126-00ZL	152	90225-07CHG	253	90715-03XF	253	90725-08BXT	253	91179-10	396	91412-08CPL	82
90126-01XE	152	90225-07CHH	253	90715-03XG	253	90725-08CGS	253	91194-04	171, 284	91412-09CWA	82
90126-02BBN	152	90225-08BPY	253	90715-03ZB	253	90725-08CGT	253	91195-04	284, 420	91412-09CWL	82
90126-02ZB	152	90225-08BYM	253	90715-03ZL	253	90725-08CGV	253	91196-08	515	91412-09CWR	82
90126-03BDP	152	90225-08CHH	253	90715-03ZQ	253	90725-08COZ	253	91216-97	396	91412-09CWT	82
90126-03BDT	152	90225-08CPC	253	90715-04BHS	253	90725-08CPC	253	91219-98	405	91412-09CYS	82
90126-04BHS	152	90225-08CPD	253	90715-04BHT	253	90725-08CPF	253	91220-98	405	91412-10DBJ	82
90126-04BHT	152	90225-08CPH	253	90715-04BHX	253	90725-08CPH	253	91249-04	105, 427, 606	91422-09	391
90126-04BHX	152	90225-08CPJ	253	90715-04BJK	253	90725-08CPJ	253	91252-03	291, 427, 606	91441-06A	33
90126-05BPS	152	90225-08DH	253	90715-04BJL	253	90725-08CPK	253	91265-98A	396	91469-06	183, 311
90126-05BPV	152	90225-09BDK	253	90715-05BPO	253	90725-08CPL	253	91274-04	105, 176, 291, 427, 606	91486-01	83, 152
90126-05BPY	152	90225-09CWA	253	90715-05BPS	253	90725-08DH	253	91286-09A	396	91519-99	573
90126-06BXY	152	90225-09CWL	253	90715-05BPV	253	90725-09CWA	253	91286-10	396	91537-00C	248
90126-07BYM	152	90225-09CWN	253	90715-05BPY	253	90725-09CWL	253	91315-04	574	91550-00C	515
90126-07CGP	152	90225-09CWR	253	90715-06BXT	253	90725-09CWN	253	91333-06	535	91558-01A	754
90126-07CGR	152	90225-09CWT	253	90715-07BDK	253	90725-09CWR	253	91336-03	176, 291, 606	91561-01A	754
90126-07CGS	152	90225-09CYS	253	90715-07BPS	253	90725-09CWT	253	91346-00	168	91562-01	754
90126-07CHG	152	90225-10BHT	253	90715-07BPY	253	90725-09CYS	253	91347-00	278, 685	91569-01	754
90126-07CHH	152	90225-10DBJ	253	90715-07BPZ	253	90739-99	705, 771	91357-99A	419	91573-06	433
90126-08COS	152	90233-08	244	90715-07BXT	253	90799-86C	83	91358-99A	419	91573-09	433
90126-08CPC	152	90238-00	302	90715-07BXY	253	90799-94D	83	91360-03	291, 606	91578-00	439
90126-08CPD	152	90240-08	244	90715-07CGP	253	90839-94A	396	91364-03	176, 291, 606	91583-99	367
90126-08CPE	152	90245-08	244	90715-07CGR	253	90853-06DH	393	91369-03	105, 176, 606	91614-09BPY	391
90126-08CPF	152	90251-09	398	90715-07CGS	253	90857-06DH	393	91385-00	74	91614-09BYM	391
90126-08CPG	152	90255-09	398	90715-07CGT	253	90876-05	249	91402-00	284	91614-09CGR	391
90126-08CPH	152	90270-99	657	90715-07CGV	253	90881-09A	397	91405-04	74	91614-09CPC	391
90126-08CPJ	152	90299-00	251	90715-07DH	253	90892-09	396	91407-00	183, 311	91614-09CWA	391
90126-08CPK	152	90300-98A	156	90715-08BDK	253	90939-97	405	91408-00	183, 311	91614-09CYS	391
90126-08CPL	152	90313-08	244	90715-08BPY	253	90955-97	405	91409-00	183, 311	91614-09DH	391
90126-09CWA	152	90320-00D	248	90715-08CGP	253	90999-09	392	91412-04AV	82	91614-10DBJ	391
90126-09CWL	152	90328-08	64	90715-08CGR	253	91001-01	183, 310	91412-04BDK	82	91614-10DBV	391
90126-09CWR	152	90330-08	80	90715-08CPF	253	91003-10	404, 620	91412-04BHS	82	91614-10DCE	391
90126-09CWT	152	90342-04A	80	90715-08CPH	253	91008-82B	81, 153, 249	91412-04BHT	82	91615-09	155
90126-09CYS	152	90345-90A	302	90715-08CPJ	253	91010-91A	81, 156	91412-04BHX	82	91621-07	311
90126-10COV	152	90363-08	65	90715-08CPK	253	91015-91	156	91412-04BJK	82	91643-09	310
90126-10DBJ	152	90369-06C	154	90715-08CPL	253	91017-10	156	91412-04DH	82	91657-02	574
90133-06B	246	90394-00	253	90715-08DH	253	91026-94A	311	91412-04XE	82	91660-03	749
90181-08A	153	90394-00DH	253	90715-09BYM	253	91051-94	698	91412-04ZB	82	91660-06	749
90206-02	398	90395-00	644	90715-09CWA	253	91066-07	649	91412-05BPO	82	91665-03	749
90214-05	398	90404-00A	248	90715-09CWL	253	91067-07	649	91412-05BPS	82	91668-05	141, 229, 367
90222-08	244	90409-08	65	90715-09CWR	253	91080-93	284	91412-05BPY	82	91670-09	391
90224-03BDK	253	90419-08	247	90715-09CWT	253	91085-83D	419	91412-05BPZ	82	91672-07	749
90224-03DH	253	90465-98A	74	90715-09CYS	253	91099-94A	419	91412-06BNR	82	91684-08	751
90225-03BBP	253	90485-08	402	90715-10DBJ	253	91100-09	419	91412-06BXT	82	91685-98	755
90225-03BDK	253	90531-93	655	90725-05BDK	253	91100-94	419	91412-06BXY	82	91686-98	755
90225-03BDT	253	90564-06C	155	90725-05BHX	253	91117-97	284, 419	91412-07CGP	82	91687-98	755
90225-03DH	253	90570-86TA	81, 156, 249	90725-05BJK	253	91124-03A	546	91412-07CGR	82	91696-05A	573
90225-03XE	253	90580-09	369, 373	90725-05BPS	253	91125-04A	81	91412-07CGS	82	91697-06A	573
90225-03ZQ	253	90589-91D	156	90725-05BPY	253	91129-01	310	91412-08CGT	82	91708-97	405
90225-04BHS	253	90645-03A	393	90725-05DH	253	91134-01	310	91412-08CGV	82	91709-97	405
90225-05BPS	253	90690-04A	393	90725-06BXT	253	91135-09	183, 311	91412-08COZ	82	91716-02	747
90225-05BPY	253	90715-03BBN	253	90725-07CGS	253	91136-07A	32	91412-08CPC	82	91718-02	747
90225-06BDK	253	90715-03BBP	253	90725-07CGV	253	91143-06BEO	393	91412-08CPE	82	91720-02	747
90225-06BHT	253	90715-03BDK	253	90725-08BDK	253	91147-02	105, 176, 291, 606	91412-08CPF	82	91722-04	705
90225-06BXY	253	90715-03BDP	253	90725-08BHX	253						



# 810 PART#/PAGE# REFERENCE

91723-02	747	91885-97A	33, 403	92058-05	405	94076-09	502	94452-05	175, 290, 598	94670-08	505
91732-02	747	91887-98	403	92059-07	572, 656	94077-09	502	94453-05	105, 175, 598	94671-99A	765
91733-85A	168, 278	91907-87	575	92068-08	572, 656	94078-09	503	94454-05	105, 175, 290, 598	94672-99	758
91741-09BPY	391	91909-03B	575	92096-05	573	94085-09	503			94674-99	777
91741-09BYM	391	91909-90A	575	92115-09	617	94086-09	505	94481-89T	776	94675-99	758
91741-09CGR	391	91910-03B	575	92136-05	405	94088-09	504	94527-95	544	94680-99	767
91741-09CGS	391	91910-90A	575	92137-05	405	94089-09	504	94529-95	544	94681-03	766
91741-09CPC	391	91920-91T	575	92189-06	400	94102-09	502	94531-95	544	94683-99	765
91741-09CWA	391	91921-91T	575	92190-06	572	94107-09	503	94534-10CZU	723	94684-00A	774
91741-09CYS	391	91924-09	347	92209-05	500	94109-95	663	94534-10DDD	718	94686-00	776
91741-09DH	391	91930-92T	574	92238-09	619	94111-95	546	94534-10DDE	721	94688-00	757
91741-10BHT	391	91931-92T	574	92352-08	256, 699	94112-04	31	94534-10DDF	714, 716	94689-00	768
91741-10DBJ	391	91939-98	575	92357-08A	618	94114-02	663	94534-10DDG	720	94691-08	283
91741-10DBV	391	91940-98	575	92364-08	619	94115-93T	546	94534-10DDH	722	94692-08	283
91741-10DCE	391	91945-98B	441	92365-08	619	94116-93T	546	94534-10DDI	717	94693-08	283
91743-87T	699	91956-97	249	92366-08	619	94117-93T	546	94534-10DDJ	724	94694-08	283
91744-87T	699	91957-97	83, 249	92378-09	619	94118-93T	546	94534-10DDL	719	94695-08	776
91745-02	747	91958-97	156, 249	92382-08A	619	94119-93T	546	94546-05	663	94696-08	776
91746-03	98	91959-97	83, 156, 249	92398-09	572	94120-93T	546	94560-07	283	94697-08	776
91753-92	404, 696	91965-98	574	92410-09	572	94121-93T	546	94561-07	283	94701-09	762
91758-07	311	91968-98	574	92416-08	573	94122-93T	546	94562-07	283	94702-09	762
91770-85	76, 147, 235	91971-98	574	92423-08	573	94123-93T	546	94563-07	283	94703-09	763
91771-04	620	91982-03B	575	92600-10	347	94124-93T	546	94564-98	782	94708-98	99, 170, 279, 690
91772-85A	698	91983-03B	575	93023-88	705	94125-93T	546	94616-98	705	94719-09	695
91773-85	699	91991-98	405	93024-88	705	94126-93T	546	94624-97B	772	94720-09	695
91777-02	397	91992-98	405	93025-88	705	94127-93T	546	94625-98	705	94721-09	695
91778-00	251	92003-10BDK	392	93036-95	705	94129-09	503	94626-98	705	94722-09	695
91782-95	698	92003-10BHT	392	93037-09	705	94130-93T	544	94627-98	764	94723-09	695
91783-96	403	92003-10BNR	392	94001-03	35	94131-93T	544	94628-05	764	94725-09	695
91790-84C	249	92003-10BPS	392	94002-03	35	94132-93T	544	94630-98	544	94727-09	695
91807-85	747	92003-10BPY	392	94013-03	39	94133-01	567	94631-98	544	94728-09	695
91810-85	747	92003-10BPZ	392	94014-03	35	94134-09	775	94638-08	501	94729-09	695
91811-85	747	92003-10BXT	392	94026A	735	94135-93T	663	94640-08	757	94731-09	695
91815-85	747	92003-10BXY	392	94026B	735	94136-09	501	94641-08	757	94733-09	695
91816-85	747	92003-10BYM	392	94026C	735	94137-09	502	94642-08	757	94734-09	693
91819-85	76, 147, 234	92003-10CGP	392	94026D	735	94139-01	567	94643-08	757	94735-98A	694
91820-85A	133, 210	92003-10CGR	392	94026E	735	94140-02	571	94644-08	757	94743-09	693
91821-85	566	92003-10CGS	392	94027A	735	94141-10	502	94645-08	757	94751-08	34, 697
91838-92	257	92003-10CGT	392	94027B	735	94144-09	503	94646-98	757	94753-99	439
91840-03B	575	92003-10CGV	392	94027C	735	94184-01	403, 699	94647-98	756	94755-99	439
91843-97	451	92003-10CHG	392	94027D	735	94185-01	403, 699	94648-08	501	94758-09	693
91845-03B	575	92003-10CHH	392	94027E	735	94204-03A	34	94649-98	758	94759-99	777
91846-03B	575	92003-10COZ	392	94038-09	504	94206-03	31	94650-98	758	94760-99	766
91847-88A	403	92003-10CPC	392	94046-03	35, 544	94207-04	544	94651-09	770	94770-05	766
91848-03B	575	92003-10CPD	392	94048-09	501	94208-04	544	94653-98	758	94773-00A	170, 279, 690
91857-91	705	92003-10CPF	392	94052-03A	545	94263-04	31	94654-98B	773	94773-07	170, 279, 690
91861-93T	575	92003-10CPG	392	94052-07	545	94280-04	92, 545	94655-98	764	94776-09	404, 694
91862-93T	575	92003-10CWA	392	94053-03A	545	94281-04	92, 545	94656-98	767	94787-09	693
91863-90T	575	92003-10CYE	392	94054-03	545	94289-94T	546	94657-98	764	94788-01A	404, 694
91864-90T	575	92003-10CYS	392	94055-03	545	94291-04A	92, 545	94658-98	764	94790-01	767
91865-90T	575	92003-10DBJ	392	94056-03	545	94413-04	175, 290, 598	94659-98	764	94791-01	767
91866-90T	575	92003-10DBV	392	94057-09	504	94415-05	163, 265	94660-98	774	94792-08	256, 696
91871-93T	575	92003-10DCE	392	94058-03	545	94416-05	283	94661-98	774	94793-01	775
91874-93T	575	92003-10DH	392	94059-03	545	94419-06	501	94662-98	757	94806-09	404, 694
91875-70B	575	92006-05	291, 606	94063-09	504	94435-02B	774	94663-02	767	94807-09	404, 696
91877-97	705	92022-03A	575	94068-03	545	94435-99	774	94666-08	505	94811-00	763
91878-77A	575	92023-03A	575	94074-09	504	94448-82B	776	94668-00	774	94819-02	774
91879-67B	575	92057-05	405	94075-09	502	94451-05	290, 598	94669-00	774	94820-02	774

94821-01	775	95710-07CMC	729	95726-10DDE	721	98185-90T	704, 759	98955-07	302	99814-09	773
94830-02	544	95710-07CNW	729	95726-10DDG	720	98186-84T	759	98959-08	302	99816-09	773
94832-02	544	95710-07CNX	729	95726-10DDL	719	98187-90T	759	98960-97	776	99816-1040/00QT	779
94834-02	544	95710-08CMC	729	95731-08CMC	729	98189-85T	759	98965-99	758	99816-2050/00QT	779
94843-01	775	95710-08CNW	729	95731-08CNW	729	98190-85T	759	98968-99	777	99816-50/00QT	779
94900-03	705	95710-08CNX	729	95731-08CNX	729	98191-85T	759	99000-77	747	99816-60/00QT	779
94901-03	705	95710-08CSZ	729	95731-08CSZ	729	98192-85T	759	99002-97A	433	99817-99A	764
94902-03	705	95710-10DDB	726	95734-07CMC	729	98193-85T	759	99013-82	75, 145	99818-97	776
94903-07	542	95710-10DDD	718	95734-07CNW	729	98194-85T	759	99020-86T	112, 189, 454	99819-09	773
94904-07	542	95710-10DDE	721	95734-07CNX	729	98196-85T	704, 759	99020-90T	112, 189, 321, 454	99820-09	773
94905-07	542	95710-10DDF	716	95734-10DDB	726	98197-85T	704, 759	99025-89	747	99820-2050/00GL	779
94906-07	542	95710-10DDG	720	95734-10DDC	725	98198-85T	704, 759	99027-87T	747	99821-09	772
94907-07	542	95710-10DDL	719	95734-10DDF	716	98199-85T	704, 759	99027-90T	747	99822-02	781
94908-07	542	95713-07CMC	729	95734-10DDI	717	98200-88T	704	99028-87T	747	99824-03/00QT	779
94909-07	542	95713-07CNW	729	95734-10DDK	714	98261-91V	765	99028-90T	747	99828-09	772
94910-07	542	95713-07CNX	729	95737-08CMC	729	98300A	735	99028-90T	747	99829-09	772
94911-07	542	95713-08CST	727	95737-08CNW	729	98300B	735	99352-82Z	747	99835-94T	770
94912-07	542	95713-08CSZ	729	95737-08CNX	729	98300C	735	99353-82Z	747	99836-94T	770
94913-07	542	95713-08CXN	727	95737-08CSZ	729	98300D	735	99537-96	321, 455	99837-94T	770
94914-07	542	95714-10CZU	723	95741-01	321, 455	98300E	735	99539-97	112, 189, 321	99841-01	765
94915-07	542	95714-10DDH	722	95756-10CZU	723	98400A	735	99642-97	777	99844-07	769
94916-07	542	95714-10DDJ	724	95756-10DDH	722	98400B	735	99650-02	781	99845-07	765
94917-07	542	95714-10DDK	715	95756-10DDJ	724	98400C	735	99653-85	776	99847-09	772
94918-07	542	95715-10CZU	723	95756-10DDK	715	98400D	735	99660-92T	281	99849-97	768
94919-07	542	95715-10DDH	722	95758-08CST	727	98400E	735	99661-92T	281	99850-92T	785
94920-07	542	95715-10DDJ	724	95758-08CXN	727	98600BF	745	99662-92T	281	99851-05	780
94921-09	283, 542	95715-10DDK	715	95758-09CST	727	98600BXR	745	99663-92T	281	99855-89	782
94922-09	283, 542	95716-07CMC	729	95758-09CXN	727	98600BXS	745	99664-01	769	99856-92	782
94923-09	283, 542	95716-07CNW	729	95760-10DDB	726	98600BY	745	99666-04	112, 189	99857-97	782
94924-09	418, 542	95716-07CNX	729	95760-10DDC	725	98600EK	745	99667-04	112	99860-81	782
94941-07	542	95716-08CMC	729	95760-10DDF	716	98603CJ	745	99668-04	112	99861-02	781
94942-07	542	95716-08CNW	729	95760-10DDI	717	98605AX	745	99669-04	112, 188, 321	99862-72	782
94943-07	171, 283, 418, 542	95716-08CNX	729	95760-10DDK	714	98605BF	745	99670-04	112, 188, 321, 455	99863-01B	772
94944-07	92, 542	95716-08CSZ	729	95764-10DDB	726	98606BF	745	99671-97	777	99865-81A	781
94946-07	92, 542	95716-09CMC	729	95764-10DDC	725	98606BXR	745	99673-10	112, 188, 321, 455	99869-04	773
94947-07	171, 542	95716-09CNW	729	95764-10DDD	718	98606BXS	745	99679-98	281	99874-04	773
94948-07	283, 542	95716-09CNX	729	95764-10DDF	716	98606BY	745	99684-98	281	99875-86T	782
94949-07	418, 542	95716-09CSZ	729	95764-10DDI	717	98606EK	745	99686-98	112, 189, 321	99878-87T	782
94968-09	782	95716-10CZU	723	95764-10DDK	714	98609EK	745	99688-10	112, 188, 321, 455	99880-73	780
94971-09	505, 782	95716-10DDK	715	95767-10DDB	726	98618-03	777	99701-84	764	99881-87	780
95703-07CMC	729	95717-09CMC	729	95767-10DDC	725	98705-85VB	755	99725-89	765	99882-88T	785
95703-07CNW	729	95717-09CNW	729	95767-10DDF	716	98715-85VC	755	99729-94T	768	99883-88T	785
95703-07CNX	729	95717-09CNX	729	95767-10DDI	717	98716-87B	755	99757-89T	768	99884-80	780
95703-08CMC	729	95717-09CSZ	729	95767-10DDK	714	98717-06	756	99760-85T	769	99889-91A	782
95703-08CNW	729	95717-10CZU	723	95982-98B	25, 217, 341, 756	98721-90B	755	99766-86T	769	99893-91A	782
95703-08CNX	729	95717-10DDH	722	95983-07	348, 756	98722-90C	755	99766-87T	769	99894-09	771
95703-08CSZ	729	95717-10DDJ	724	96396-09	442	98724-92C	755	99769-88T	769	99901-77	781
95703-10DDB	726	95717-10DDK	715	97005-02	474, 541	98725-91	461, 756	99775-89T	768	99902-77	781
95703-10DDC	725	95722-10CZU	723	97008-07	704, 759	98743-09	755	99776-91T	768	99909-93R	780
95703-10DDD	718	95722-10DDH	722	97018-08	141	98744-09	755	99779-88T	769	99943-04	773
95703-10DDF	716	95722-10DDJ	724	97026-09	367	98835-92	696	99779-89T	768	99953-99A	781
95703-10DDI	717	95722-10DDK	715	97031-09	229	98839-09	765	99776-91T	768	99974-04	773
95703-10DDK	714	95723-10DDB	726	97036-09	229	98864-97	256, 699	99778-94T	768	99982-96	768
95709-10DDD	718	95723-10DDC	725	98169-88T	704, 759	98868-98	696	99779-04	769	99983-96	768
95709-10DDE	721	95723-10DDF	716	98170-88T	704, 759	98870-00B	256, 694	99780-04	769		
95709-10DDG	720	95723-10DDI	717	98183-90T	759	98923-09	34, 694	99809-97	777		
95709-10DDL	719	95726-10DDD	718	98184-90T	704, 759	98945-04A	697	99811-97	777		
						98949-06	697	99813-09	779		

Product	VRSC™	SPORTSTER®	DYNA®	SOFTAIL®	TOURING
Adjustable Highway Peg Mount	570	108, 570	177, 180, 570-571	301, 570-571	432-433, 570-571
Adjustable Pushrod/Cover Kit	–	–	494	494	494
Aileron Grip/Peg Collection	558	558	558	558	558
Air Cleaner – Heavy Breather	–	472	472	472	472
Air Cleaner – Stage I	470	467	470-471	470-471	470-471
Air Cleaner Covers/Trim	–	88-89, 740	516-522, 540-541, 740	516-522, 540-541, 740	516-522, 540-541, 740
Air Dams/Scoops	34	738	738	738	–
Air Deflectors	–	739	739	270	341, 352, 414
Air Filters	470, 785	467, 785	471-473, 785	471-473, 785	471-473, 785
Air Horns	50	113	658-659	658-659	658-659
Alarm Systems/Pagers	749-751	749-751	749-751	749-751	749-751
American Flags	705	705	705	705	705
Ancra® Tie-Down Anchor Kit	759	759	759	759	759
Antenna Relocation Kits	–	–	–	–	625-626
Antennas	–	–	–	–	619, 625-626
Anti-Freeze and Coolant	781	–	–	–	–
Anti-Seize Products	776	776	776	776	776
Assembly Lube	505, 782	505, 782	505, 782	505, 782	505, 782
Audio Amplifiers	–	–	–	–	622
Audio/CB Systems	–	–	–	–	620-626
Audio/Headsets/Accessories	620, 624	620, 624	620, 624	620, 624	620-625
Auxiliary/Fog Lamp Kits	633	630, 633	630, 633	630-631, 633	632, 633
Axle Covers	38-39, 41	96, 97	164-165, 167	266-267, 276-277	412-413
Axle Nut Wrench	–	–	776	776	776
Axle Spacers	39, 43, 665	95, 97, 665	165, 167, 665	267, 273, 665	413, 665
Backrest Pads – Sissy Bar	29, 31-32	76, 78	146-147	234-236, 238-239	372-373
Backrest Pads – Tour-Pak	–	83	–	250	388-389
Backrests/Pads	30-32	74-76, 78	144-147	231-239	366-367, 370-373
Bags	32-34, 693-697	80-83, 693-703	152-156, 693-703	244-256, 693-703	402-405, 693-703
Bags, Windshield	–	702-703	702-703	702-703	347, 701-703
Banjo Bolts/Covers	44	99, 100, 604	170, 604	281, 282, 604	416, 604
Batteries	783	783	783	783	783

Product	VRSC™	SPORTSTER®	DYNA®	SOFTAIL®	TOURING
Battery Charger Lead/Extensions	772	772	772	772	772
Battery Chargers	772-773	772-773	772-773	772-773	772-773
Battery Covers/Boxes	-	93	172	-	-
Bearing Install/Remove Tools	-	-	503	503	503
Bearings/Seals, Wheel	665	665	665	665	665
Belt Drive Pulleys	43, 667	686-687	686-687	686-687	686-687
Belt Guards	40	98	166	272	415
Belt Tension Guide	776	776	776	776	776
Belts, Emergency	-	-	793	793	793
Bezels, Instrument/Speaker	-	111	190	313	439, 442-443
Bibs/Chaps, Fender	-	73	142	221, 228	-
Bibs/Chaps, Tank	34	77	142	228	364
Big Bore Kit	-	467	468-470	468-470	468-470
Black Fin Derby/Timer Cover Collection	-	-	517	517	517
Bleeder Screw Covers	-	100	170	282	282
Blue Buster®	770	770	770	770	770
Bobtail Fenders	-	84, 743	743	-	-
Bobtail Luggage Racks	-	79	150	242	-
Bolt Caps/Covers, Riser	-	598	175, 598	598	-
Bolt Covers	544	92, 542, 544, 598	171, 175, 542, 544, 598	283, 542, 544, 598	418, 542, 544
Bolt Sets/Kits/Assortments	35, 546-547	92, 544-547	544-547	544-547	544-547
Bolts, Handlebar and Riser	-	105	597, 598	597, 598	-
Bolts, Seat	-	73	141	229	365
Bolts/Mounts, Footpeg	567	107, 567	181, 567	303-304, 567	437, 567
Braces, Fork	39	95	158	265	-
Brackets, Clutch/Brake Lever	46, 599	104, 599	174, 599	288, 599	424, 599
Brackets, Taillight/License Plate	53	119, 660-661	660-661	660-661	660-661
Brackets/Mounts, Passenger Footpeg	50	107, 567	181, 567	303-304, 567	437, 567
Brackets/Mounts, Turn Signal	52	114, 117, 642, 643	642, 643	642-645	642-642
Brackets/Supports, Saddlebag	-	83	156	249	396-397
Braided Brake Lines	-	612-615	612-615	612-615	612-615
Braided Control Cables	608-610	607-611	607-611	607-611	607-611



Product	VRSC™	SPORTSTER®	DYNA®	SOFTAIL®	TOURING
Braided Oil/Fuel Lines	–	–	535	535	535
Brake Banjo Bolts/Covers	44	99, 100, 604	170, 604	281, 282, 604	416, 604
Brake Bleeder Caps/Covers	–	100	170	282	282
Brake Caliper Bolt Covers	–	100	170	281	–
Brake Caliper Covers	–	100	170	282	417
Brake Caliper Inserts	44, 169	100, 169	169	281	418
Brake Calipers	44	100	169	280	416
Brake Disc Lock	752	752	752	752	752
Brake Fluid	781	781	781	781	781
Brake Hardware	690	99, 690	170, 690	279	418
Brake Levers	47, 48-49	104, 106, 602-603	175, 178, 602-603	289, 295-296, 602-603	425, 429, 602-603
Brake Lights	53	118, 648	645, 648-650	644, 645, 648-650	644, 645, 648-650
Brake Lines/Fittings	–	612-615	612-615	612-615	612-615
Brake Master Cylinders, Handlebar	46, 599-601	104, 599-601	174, 599-601	288, 599-601	424, 599-601
Brake Master Cylinders, Rear	50	99	–	292	428
Brake Pads	793	793	793	793	793
Brake Pedal Covers/Pads	–	–	553-565	553-565	553-565
Brake Rotors	–	688-689	671, 688-689	671, 688-689	670, 688-689
Brake/Carb/Choke Cleaners	782	782	782	782	782
Brake/Clutch Levers	47	104, 602-603	175, 178, 602-603	289, 295-296, 602-603	425, 429, 602-603
Bulbs	651	629, 651	629, 651	628-629, 651	628-629, 651
Bullet Lights	51, 52	634, 640-642	634, 640-642	634, 640-642	642, 644
Bungee Cords/Nets/Nuts	759	759	759	759	759
Cable Fitting Covers	–	92, 601, 604	176, 601, 604	291, 601, 604	427, 601, 604
Cable Guides/Clamps	606	105, 606	176, 606	291, 606	427, 606
Cable/Chain Locks	752-753	752-753	752-753	752-753	752-753
Cables – Throttle/Idle	609-610	607-611	607-611	607-611	607-611
Cables, Clutch	–	607-611	607-611	607-611	607-611
Caliper Covers	–	100	170	282	417
Caliper Inserts	44, 169	100, 169	169	281	418
Calipers, Brake	44	100	169	280	416
Cam Bearing Installation Tools	–	–	503	503	503

Product	VRSC™	SPORTSTER®	DYNA®	SOFTAIL®	TOURING
Cam Chain Tensioner Tool	-	-	502	502	502
Cam Support Plate	-	-	493	493	493
Cam/Crank Sprocket Lock Tool	-	-	502	502	502
Cam/Gearcase Cover	35	85-86	526, 527	526, 527	526, 527
Camshaft Removal/ Installation Tool	-	-	503	503	503
Caps, Axle	38-39, 41	96-97	164-165, 167	266-267, 276-277	412-413
Caps, Fork Tube	39	105	165	270	-
Caps, Gas Tank	-	112	186-189	318-321	452-455
Caps, Handlebar Switch Button	49, 600	104, 600	174, 600	288, 600	425, 600
Caps, Valve Stem	690	690	690	690	690
Carburetor/EFI Covers	-	534	534-535	534-535	534-535
Cargo Hold-Downs	759	759	759	759	759
Case Boring Jigs and Adapters	-	-	501	501	501
CB Microphone Kit	-	-	-	-	624, 625
CB/Audio System	-	-	-	-	622-625
CB/Radio Antennas	-	-	-	-	625-626
Center Stand	-	-	-	302	433
Chain Locks	752-753	752-753	752-753	752-753	752-753
Chain Lubes/Cleaners	781, 782	781, 782	781, 782	781, 782	781, 782
Chaincase Oil	779, 780	779, 780	779, 780	779, 780	779, 780
Chamois, Cloths, Wipes and Towels	767	767	767	767	767
Chaps/Bibs, Fender	-	73	142	221, 228	-
Chaps/Bibs, Tank	34	77	142	228	364
Choke Knobs/Knob Covers	-	87	534	534	534
Chrome & Rubber Grip/Peg Collection	564-565	564-565	564-565	564-565	564-565
Chrome Engine Kit	35	85-86	524	524	524
Chrome Hardware	35, 39, 546-547	92, 544-547	544-547	544-547	544-547
Chrome/Metal Polishes	765, 768	765, 768	765, 768	765, 768	765, 768
Circulator Seat Pads	29	72	142	228	365
Clamps, Cable	606	105, 606	176, 606	291, 606	427, 606
Clamps, Footpeg	-	570-571	570-571	570-571	570-571
Clamps, Handlebar	-	598	598	598	598

Product	VRSC™	SPORTSTER®	DYNA®	SOFTAIL®	TOURING
Classic Chrome Derby/Timer Covers	–	523	523	523	523
Classic Cover Kit	–	92, 542	171, 542	283, 542	418, 542
Cleaning Supplies	762-770	762-770	762-770	762-770	762-770
Clocks/Thermometers	314	314	314	314	314
Clutch Cable Fitting Covers	–	92, 601, 604	533, 601, 604	533, 601, 604	533, 601, 604
Clutch Cables	–	607-611	607-611	607-611	607-611
Clutch Hubs/Lining	496	495	495-496	495-496	495-496
Clutch, Reduced Effort Kit	–	–	176	289	426
Clutch/Brake Levers	47, 48-49	104, 106, 602-603	175, 178, 602-603	289, 295-296, 602-603	425, 429, 602-603
Clutch/Clutch Spring	496	495	495-496	495-496	495-496
Coil Covers	–	93	173	287	–
Color-Matched Accessories	34	82, 84, 738-744	152, 738-744	250-253, 738-744	381-384, 390-392
Communication Systems	–	–	–	–	622-625
Compensator Sprocket	–	–	496	496	496
Compression Release Installation Kit	–	–	501	501	501
Compression Release Kits	–	–	495	495	495
Conchos	705	705	705	705	705
Console Bags/Pouches	–	–	183	310-311	–
Console Inserts	–	–	182	318	444
Consoles/Dash Panels	–	113	182-184	309-311, 318	439-445
Contact Cleaner/Lube	781	781	781	781	781
Control Cables	609-610	607-611	607-611	607-611	607-611
Controls, Handlebar	46-47	102-104, 599-606	174-175, 599-606	288-289, 599-606	424-427, 599-606
Coolant Hose Covers	36	–	–	–	–
Coolant/Additives	781	–	–	–	–
Coolers, Oil	–	90	514	514	514
Covers, Battery	–	93	172	–	–
Covers, Bleeder Screw	–	100	170	282	282
Covers, Brake Caliper	–	100	170	282	417
Covers, Brake Pedal	–	–	553-565	553-565	553-565
Covers, Cable Fitting	–	92, 601, 604	176, 601, 604	291, 601, 604	427, 601, 604
Covers, Choke Knob	–	87	534	534	534

Product	VRSC™	SPORTSTER®	DYNA®	SOFTAIL®	TOURING
Covers, Clutch Cable Adjuster	-	92, 601, 604	533, 601, 604	533, 601, 604	533, 601, 604
Covers, Floorboard	-	-	307	307	438
Covers, Fork Stem	39	105	174	270	-
Covers, Gas Cap	-	112	188, 189	321	440, 454-455
Covers, Horn	-	113	659	659	659
Covers, Ignition Switch	-	93	-	-	439
Covers, Master Cylinder	47, 50	99, 104, 599-601	174, 599-601	288, 599-601	424, 599-601
Covers, Oil Line/Transmission	-	-	528, 531	528, 529	529, 530, 531
Covers, Oil Pressure Switch	-	-	533	-	533
Covers, Petcock	-	87	534	534	534
Covers, Saddlebag Latches	-	-	-	-	393
Covers, Side	37	93, 739	172-173	-	-
Covers, Solenoid	-	87	533	533	533
Covers, Storage	755-757	755-757	755-757	755-757	755-757
Covers, Swingarm Pivot	41	97	-	274-275	-
Covers, Taillight	53	119, 651	651	651	651
Covers, Triple Tree	-	-	-	268-269	414
Covers, Valve Stem	690	690	690	690	690
Covers, Voltage Regulator	37	92	173	287	423
Crankcase Bushings/Bearings	-	-	493	493	493
Crash Bars	45	109	182	300, 302	432
Crash Bars, Rain Guards	-	-	-	301	351
Crested Bar & Shield Grip/Peg Collection	556	556	556	556	556
Crossover Fuel Lines	-	-	535	535	535
Cruise Control Kits	-	-	-	-	426
Custom Seat Program	-	-	136, 706-709	219, 706-709	354, 706-709
CV Carb Top Covers	-	534	534	534	534
Cylinder Base Cover	-	87	532	532	532
Dark Custom Derby/Timer Cover	-	89	517	517	517
Dash Panels & Gauges	-	110-111, 113	183-191	309-319	439-453
Dash Trim	-	113	182-184	309-311, 318	439-445
Debris Guards	40	98	166	271, 272	415



Product	VRSC™	SPORTSTER®	DYNA®	SOFTAIL®	TOURING
Decals	745	745	745	745	745
Derby/Timer Covers	–	88-89, 523	516-523	516-523	516-523
Detachable Saddlebags	–	–	153	244, 245	–
Detachable Seat Hardware	–	73	141	229	365
Detachable Windshields	24-25	66-68	131-133	209-217	339-341
Detailer Sprays/Wipes	762-769	762-769	762-769	762-769	762-769
Detailing Swabs	769	769	769	769	769
Diamond Black Grip/Peg Collection	554	554	554	554	554
Dipsticks, Engine/Transmission	36	90	536-537	536-537	536-537
Directional Mirrors	572, 656	572, 656	572, 656	572, 656	347, 572, 656
Disc Locks	752	752	752	752	752
Discs, Brakes	–	688-689	671, 688-689	671, 688-689	670, 688-689
Display Stand	–	–	–	302	433
Docking Hardware – Saddlebag	–	74, 80	144, 153	233, 244, 245	–
Docking Hardware – Sissy Bar & Rack	–	74	144	233	369, 376-377
Drive Pulley Inserts/Covers, Rear	41	98-99, 685	168, 685	278, 685	415, 685
Drive Pulleys/Sprockets	43	101, 686-687	686-687	686-687	686-687
Driving Lights	633	630, 633	630, 633	631, 633	632, 633
Dunlop® Tires	790-792	790-792	790-792	790-792	790-792
Dust Covers, Fork	–	–	163	265	411
EFI Covers	–	–	534, 535	534, 535	534, 535
Electra-Glo Lighting	652-653, 656	652-653, 656	652-653, 656	652-653, 656	652-653, 654-656
Electrical Panel Covers	–	93	173	–	–
Emergency Belts	–	–	793	793	793
End Caps, Grip	552, 656	552, 656	552, 656	552, 656	552, 656
Engine Cleaner	768	768	768	768	768
Engine Guards	45	109	182	300	432
Engine Oil	778-779	778-779	778-779	778-779	778-779
Engine Rotator	–	504	504	504	504
Engine/Transmission Interface Cover	–	86	528	528, 529	529-530
Engines, Complete	508	–	510	508-509	510
Enrichener Knob	–	87	534	534	534

Product	VRSC™	SPORTSTER®	DYNA®	SOFTAIL®	TOURING
Evolution® 1340 Motors	-	-	-	508	-
Exhaust	-	476-478	479-481	482-487	488-491
Exhaust Clamps/Brackets	37	-	173	-	491
Exhaust Gaskets	-	490	490	490	490
Exhaust Shields	-	477	479, 481	483-487	489, 490
Exhaust, Anti-Bluing Products	770	770	770	770	770
Extended Reach Foot Controls	-	106	177	293	434
Extended Saddlebags	-	-	-	-	392
Extensions, Kickstand	-	108	179	303	428
Fairing Bra	-	-	-	-	343, 345
Fairing Lowers	-	-	-	-	348-351
Fairing Mounted Gauges	-	-	-	-	450-451
Fairing Mounted Mirrors	-	-	-	-	347, 441
Fairing Pockets/Pouches	-	-	-	-	347, 351
Fairing Run/Turn Signals	-	-	-	-	346, 347, 654
Fairing Trim	-	-	-	-	343, 346, 654
Fairing Wind Deflectors	-	-	-	-	343, 345, 352
Fasteners/Hardware	35, 544, 546-547	92, 544-547	544-547	544-547	544-547
Fender Adapters/Spacers	-	-	-	-	422
Fender Bibs/Chaps	-	73	142	221, 228	-
Fender Cover	-	757	757	757	757
Fender Luggage Racks	30	78-79	148, 150	238-242	374-375
Fender Struts/Covers/Hardware	-	-	171	283	415
Fender Tip Lights	-	-	-	286, 646	420, 646, 648-649
Fender Trim	-	171	171	283-286	419-422
Fenders	-	84, 741-743	741-743	741	741
Fill-N-Go Fuel Tank Funnel	771	771	771	771	771
Filters – Air	785	785	785	785	785
Filters – Oil	784	784	784	784	784
Flags	705	705	705	705	705
Flames Console/Tank Trim	-	-	182	318	444
Flames Derby/Timer Cover Collection	-	89	521	521	521

# 820 INDEX

Product	VRSC™	SPORTSTER®	DYNA®	SOFTAIL®	TOURING
Flames Fender/Saddlebag Trim	-	-	-	285, 286	393, 420, 421
Flames Fuel Cap/Filler Door	-	112	187, 189	319, 320, 321	440
Flames Grip/Peg Collection	560	560	560	560	560
Flashlight	775	775	775	775	775
Floorboard Covers/Guards	-	-	307	307	438
Floorboard Extension Kit	-	-	-	-	434
Floorboard Mounting Brackets	-	-	181	297, 304-306	434-436
Floorboards	50	108	180, 569	304-307, 568-569	434-438, 568-569
Flush Mount Gas Caps	-	-	186	318	452
Fog Lights	633	630, 633	630, 633	631, 633	632, 633
Foot Controls	48-49	106-108	177-181	292-299	428-431
Footboard Inserts	-	-	554-564, 567	554-564, 567	554-564, 567
Footboard Trim	-	-	307	307	438
Footpeg Mounts/Bolts	49-50, 567	106, 107, 567	180, 181, 567	303-304, 567	437, 567
Footpegs/Footboards	553-567	553-567	553-567	303-307, 553-567	434-438, 553-567
Fork Bag	-	-	698-699	698-699	-
Fork Braces	39	95	158	265	-
Fork Covers/Dust Covers	-	-	163	265	410-411
Fork Drain Plugs/Screws	-	95	163	265	411
Fork Oil	780	780	780	780	780
Fork Sliders	38	95	162	262-263	410-411
Fork Springs	-	101	158	259	407
Fork Tins	-	-	-	262-263, 268-270	411, 414
Fork Tube Nut Covers	-	105	165	270	-
Fork Wind Deflectors	-	-	-	270	341, 414
Forks – Inverted	-	-	-	264	-
Forward Control Extensions	-	-	-	293	-
Forward Control Kits	-	106	177	292-293	-
Forward Control Mounts	49	106	177	294	-
Frames, License Plate	53, 660-663	119, 660-663	660-663	660-663	660-663
Front End Kits	38	95	162	262, 264	410
Front Turn Signal Relocation Kit	52	114, 643	642, 643	642, 643	632, 642

Product	VRSC™	SPORTSTER®	DYNA®	SOFTAIL®	TOURING
Fuel Additives/Octane Boosters	782	782	782	782	782
Fuel Caps & Gauges	–	111-112	186-188, 189	318-321	440, 450, 452-455
Fuel Doors/Covers	–	–	–	–	440
Fuel Stabilizers/Storage	782	782	782	782	782
Fuel Tank Crossover Lines	–	–	535	535	535
Fuel Tanks	–	744	–	–	–
Fuel/Oil Lines	–	–	535	535	535
Garage Door Opener	754	754	754	754	754
Gas Caps/Covers	–	112	186-188, 189	318-321	440, 452-455
Gas Tank/Air Box Bra	34	77	142	228	364
Gauge Housings/Mounts	–	110-111	190-191	316-317	448
Gauges, Oil Pressure	–	–	189	315	449, 450, 451
Gauges, Oil Temperature	–	90	189, 537	315, 537	449, 451, 537
Gear Sets – 6 Speed	–	–	497	497	497
Glove Boxes	–	–	–	–	351, 400
GPS Systems	617-619	617-619	617-619	617-619	617-619
Grease	782	782	782	782	782
Grip End Caps	552, 656	552, 656	552, 656	552, 656	552, 656
Grips	550-564	550-564	550-564	550-564	550-564
Grips, Heated	550-551	550-551	550-551	550-551	550-551
Halogen Bulbs	629	629, 633	629, 633	628-629, 633	628-629, 633
Handgrips	550-564	550-564	550-564	550-564	550-564
Handgrips, Heated	550-551	550-551	550-551	550-551	550-551
Handlebar Bushings/Bolts	–	103, 597	176, 597	290, 597	426, 597
Handlebar Clamps	–	598	598	598	–
Handlebar Controls/Cover Kits	46-47, 599-600	104, 599-601	174, 599-601	288-289, 599-601	424-426, 599-601
Handlebar Levers/Controls	46-47	104, 599-603	174-175, 599-603	288-289, 599-603	424-426, 599-603
Handlebar Master Cylinders	46-47	104, 599-601	174, 599-601	288-289, 599-603	424, 599-603
Handlebar Mount Clock	314	314	314	314	314
Handlebar Risers	–	596-597	596-597	596-597	–
Handlebar Switch Button Caps	46, 600, 605	104, 600, 605	174, 600, 605	288, 600, 605	425, 426, 600, 605
Handlebar Switch Housings	46, 600, 605	104, 600, 605	174, 600, 605	288, 600, 605	425, 426, 600, 605



# 822 INDEX

Product	VRSC™	SPORTSTER®	DYNA®	SOFTAIL®	TOURING
Handlebar-Mount Tachometers	–	110-111	190-191	316-317	448
Handlebars/Risers	46	102-103, 587-597	576-597	576-597	576-597
Hardware Covers	35	92, 542, 544	171, 542, 544	283, 542, 544	418, 542, 544
Hardware Kits	31, 35, 39	92, 544-547	544-547	544-547	544-547
H-D Motor Co. Axle Covers	38	96	164	266, 276	413
H-D Motor Co. Caliper Inserts/Medallions	–	100	281	281	281
H-D Motor Co. Derby/Timer Covers	–	88	522	522	522
H-D Motor Co. Fuel Cap	–	112	189	321	455
H-D Motor Co. Pivot Bolt Covers	–	–	–	275	–
Headbolt/Rocker Box Covers	–	91	538-539	538-539	538-539
Headlamp Housing/Nacelle	51	114-115	–	268, 639	414
Headlamp Trim Rings/Visors	51	115, 636-639	636-639	636-639	636-639
Headlamps/Bulbs	51, 629	114, 629, 634-635	629, 634-635	628-629, 634-635	628-629, 634-635
Headlight, HID	–	–	–	628	628
Headsets/Accessories	620, 624	620, 624	620, 624	620, 624	620, 625-625
Heat Shields	–	477	479, 481	483-487	489, 490
Heated Hand Grips	550-551	550-551	550-551	550-551	550-551
Heel Rests	–	75	180	294	437
Heel-Toe Shift Levers	–	–	–	296	429, 430
Helmet Communications/Headsets	–	–	–	–	622-625
Helmet Locks	–	753	753	753	753
HID Headlamp	–	–	–	628	628
High Flow Air Filter	470	467, 472	471-473	471-473	470, 471-473
Highway Bar, Rain Guards	–	–	–	301	351
Highway Bars	–	109	182	300-301	432
Highway Pegs – Engine Guard Mount	570	570-571	570-571	301, 570-571	432-433, 570-571
Highway Pegs – Frame Mount	–	108	180	301	–
Hog Blaster	770	770	770	770	770
Horns/Horn Covers	50	114	658-659	658-659	658-659
Idle Cables	609-610	609-611	609-611	609-611	609-611
Ignition	–	498-499	498-499	498-499	498-499
Inner Cam Bearing Tools	–	–	503	503	503

Product	VRSC™	SPORTSTER®	DYNA®	SOFTAIL®	TOURING
Inner Fairing – Color-Matched	–	–	–	–	444-445
Inner Primary Covers/Trim	–	–	524, 525	524, 525	524, 525
Inner Tubes	788, 791	788, 791	788, 791	788, 791	788, 791
Inspection Covers	–	85	518, 520, 521, 523, 527	518, 520, 521, 523, 527	518, 520, 521, 523, 527
Instrument/Speaker Bezels/Trim	–	111	190	313	439, 442-444
Instruments	–	110-111	184-187, 189-191	312-319	446-451
Intake Manifold Wrenches	–	–	504	504	504
Intercom Systems	–	–	–	–	622-625
iPod® Protectors	620	620	620	620	620
Ironside Grip/Peg Collection	559	559	559	559	559
Isolated Drive System	–	–	–	–	415
Jiffy Stands	45	108	179	303	428
Keys	754	754	754	754	754
Kickstands/Extensions	45	108	179	303	428
Latch Inserts – Saddlebags	–	–	–	–	393
Laydown License Plate Mount	–	119, 660	660	660	660
Leather Care/Conditioners	765	765	765	765	765
Leather Saddlebags	35	80-81	153-156	244-249	–
Leather Tank Panels	–	–	183	310-311	–
LED Accent Lighting	652-653, 656	652-653, 656	652-653, 656	652-653, 655-656	652-656
LED Auxiliary Light Kits	–	118, 656	650, 656	644, 650, 655-656	648-649
LED Light Strips	652-653	652-653	652-653	652-653	652-653
LED Taillight	53, 649	118, 648	648-649	648-649	648-649, 650
LED Mini Lighting	52, 640	117, 640	640	640	–
Lenses, Taillight	53, 649	118, 648	648-649	648-649	648-649
Lenses, Turn Signals	646, 647	116, 646, 647	646, 647	646, 647	646, 647
Levers, Brake and Clutch	47, 48-49	104, 602-603	175, 602-603	289, 295-296, 602-603	425, 429, 602-603
License Plate Bolts/Nuts	663	663	663	663	663
License Plate Mounts/Frames	53, 661-662	119, 660-662	660-662	660-662	660-662
License Plate Relocation Kits	–	119	660	–	661
Lifter Block Covers	–	87	532	532	532
Lifter/Pushrod Kits	–	494	494	494	494

# 824 INDEX

Product	VRSC™	SPORTSTER®	DYNA®	SOFTAIL®	TOURING
Light Bars	-	-	-	644-645	644-645
Light Pods	652-653	652-653	652-653	652-653	652-653
Lights, Fender Tip	-	-	-	646	646, 648-649
Live To Ride Caliper Inserts/Medallions	-	100	281	281	281
Live To Ride Derby/Timer Cover Collection	-	89	520	520	520
Live To Ride Fender Trim	-	-	-	286	420
Live To Ride Fuel Cap/Filler Door	-	112	189	321	440
Live To Ride Handlebar Clamp	-	598	598	598	-
Locking Gas Caps	-	188	188	320	440, 454
Locks	752-753	752-753	752-753	752-753	752-753
Loctite® Supplies	777	777	777	777	777
Lower Fairing Pouches	-	-	-	-	351, 400
Lower Fork Legs	38	95	162	262-263	410
Lowering Kits	-	101	158	259	407
Lubricants, Spray/Multipurpose	781-782	781-782	781-782	781-782	781-782
Luggage	32-34, 693-697	80-83, 693-697	152-156, 693-697	244-256, 693-697	381-387, 404, 693-697
Luggage Rack/Tail Bags	34, 693-697	693-697	693-697	256, 693-697	404, 693-697
Luggage Racks	30, 32	78-79	148-150	238-242	374-375, 394-395
Luggage Rain Liners/Pouches	694	694	694	694	694
Luggage, Roller Style	697	697	697	697	697
Luggage, Sissy Bar	34	693-695, 697-699	693-695, 697-699	256, 693-699	693-697
Magnetic Trays	775	775	775	775	775
Mainshaft Bearing Race Tool	-	-	503	503	503
Master Cylinders/Covers	46-47, 50	99, 104, 599-601	174, 599-601	288, 292, 599-601	424, 428, 599-603
Medallions	746-747	746-747	746-747	746-747	746-747
Metal/Chrome Polishes	765, 768	765, 768	765, 768	765, 768	765, 768
Michelin® Tires	-	788-789	788-789	788-789	788-789
Mini Floorboards	50	108	180	294	437
Mini Tach/Components	-	110	190-191	316-317	448
Mirrors	572-575	572-575	572-575	572-575	572-575
Mirrors, Fairing Mount	-	-	-	-	347, 441
Motor Oil	778-780	778-780	778-780	778-780	778-780

Product	VRSC™	SPORTSTER®	DYNA®	SOFTAIL®	TOURING
Motorcycle Alarms	749-751	749-751	749-751	749-751	749-751
Motorcycle Covers	755-757	755-757	755-757	755-757	755-757
Motorcycle Dryers	770	770	770	770	770
Motorcycle Lifts	758	758	758	758	758
Motors, Complete	508	-	510	508-509	510
Mounting Yokes, Saddlebags	-	81	156	-	-
Mud Flaps	-	-	171	284	422
Muffler Clamps/Brackets	37	-	173	-	438
Mufflers	-	476-478	479-481	482-487	488-491
Mufflers, Covers & Shields	37	477	479, 481	483-487	489, 490
Mustache Engine Guard	-	-	-	300	432
Nacelle Kit	-	-	-	268, 639	414
Nostalgic Grip/Peg Collection	562	562	562	562	562
Novus® Plastic Polish	770	770	770	770	770
Oil Coolers/Covers	-	90	514	514	514, 533
Oil Dipsticks	36	90	536-537	536-537	536-537
Oil Filler Spout Cover	-	-	531	-	531
Oil Filter Wrenches	776	776	776	776	776
Oil Filters	784	784	784	784	784
Oil Line Separators	-	-	-	535	-
Oil Pressure Gauges	-	-	189	315	449, 450, 451
Oil Pressure Switch Cover	-	-	-	-	533
Oil Pump Kits	-	-	493	493	493
Oil Pumps/Kits	-	-	493	493	493
Oil Tank Covers	-	93, 739	-	-	-
Oil Temperature Gauges	36	90	189, 537	315, 537	449, 451, 537
Oils & Lubes	778-782	778-782	778-782	778-782	778-782
Organizers – Saddlebag/Tour-Pak	-	-	-	255	400-403
Oxygen Sensor Socket Tool	501	501	501	501	501
Packs, Sissy Bar	34, 693-697	693-695, 697-699	693-695, 697-699	693-695, 697-699	693-695, 697-699
Padlocks	752-753	752-753	752-753	752-753	752-753
Pads, Brake Pedal	-	-	553-565	553-565	553-565



Product	VRSC™	SPORTSTER®	DYNA®	SOFTAIL®	TOURING
Paint – Touch-Up	745	745	745	745	745
Passenger Backrests	29-32	74-77	144-147	231-239	370-373, 388-389
Passenger Floorboard Covers	–	–	307	307	438
Passenger Floorboard Mounts	–	–	181	306	436
Passenger Footboard Kits	50	108	180	306-307	434-437
Passenger Footpeg Mounts	50	107	181	303-304	437
Passenger Grab Rails	–	–	141	229	367
Passenger Pillion	27-29	73	139, 141	221, 222, 227	361
Passing Lamp Kits	–	114	630, 633	631, 633	632, 633
Pegs, Foot/Shifter	553-568	553-568	553-568	553-568	553-568
Personal Accents Console Inserts	–	–	182	318	444
Petcock Covers	–	87	534	534	534
Pillion Pads	27-29	73	139, 141	221, 222, 227	361
Pivot Bolt Covers	41	97	–	274-275	–
Plug Wires	–	499	499	499	499
Polishing Products	762-770	762-770	762-770	762-770	762-770
Pop-Up Gas Caps	–	–	186	318	452
Pouch, License Plate Bracket	–	698	698	698	–
Pouches, Guard	–	–	–	–	405
Pouches, Lower Fairing	–	–	–	–	351, 400
Pouches, Windshield	–	701-703	701-703	701-703	347, 700-703
Primary Cover Inserts/Emblems	–	85, 88-89, 523	516-523	516-523	516-523
Primary Covers	35	85, 86	524-527	524-527	524-527
Primary Locking Tools	–	–	–	–	502
Primary Oil	778-779	778-779	778-780	778-780	778-780
Primary, Inners	–	–	524, 525	524, 525	524, 525
Pulleys, Rear Drive	43	101, 686-687	686-687	686-687	686-687
Pushrod Tube Tool	–	505	505	505	505
Pushrod Tubes/Covers	–	–	494, 532	494, 532	494, 532
Pushrods/Kits	–	–	494	494	494
Quarter Fairing	–	739	739	–	–
Rack/Pillion Bags	34, 693-697	693-695, 697-699	693-695, 697-699	693-695, 697-699	404, 693-697

Product	VRSC™	SPORTSTER®	DYNA®	SOFTAIL®	TOURING
Racks – Luggage	30, 32	78-79	148-150	238-242	374-375, 394-395
Racks – Tour-Pak	–	83	–	254	394-395
Radio Accent Trim	–	–	–	–	442-443
Radio/Sound System	–	–	620	620	620-625
Rails, Fender/Saddlebag	–	–	–	284	394-398, 419
Rain Covers, Seat	–	77	142	229	365
Rain Guards, Highway Bar	–	–	–	301	351
Rain Liners/Pouches, Luggage	694	694	694	694	694
Ratcheting Crankshaft Wrenches	–	504	504	504	504
Razor-Pak Luggage	–	–	–	–	381
Rear Belt Guards	40	98	166	242	415
Rear Brake Master Cylinders	–	99	–	292	428
Rear Fenders	–	84, 742-743	742-743	–	–
Repair Kits – Snap, Strap & Button	771	771	771	771	771
Rider Footboard Kits	–	–	–	304-306	434
Rider/Passenger Communication	–	–	–	–	622-625
Rim Strips	788, 791	788, 791	788, 791	788, 791	788, 791
Riser Bushings	–	103, 597	176, 597	290, 597	426, 597
Riser/Handlebar Bolts	–	105, 598	175, 597-598	290, 597-598	–
Risers, Handlebar	–	596-597	596-597	596-597	–
Road Tech™ GPS	617-619	617-619	617-619	617-619	617-619
Rocker Arms/Support	–	494	494	494	494
Rocker Box Wrenches	–	–	504	504	504
Rocker Boxes/Cover Kits	–	–	524, 526, 527	524, 526, 527	524, 526, 527
Rocker Cover Bolt Kit	–	91	539	539	539
Roller Luggage	697	697	697	697	697
Rotors, Brake	–	688-689	671, 688-689	671, 688-689	670, 688-689
Run, Brake and Turn Signal Modules	53, 645	118, 645	645	645	645
S100® Cleaners	768-769	768-769	768-769	768-769	768-769
Saddle Shield Heat Deflectors	–	–	–	–	352
Saddlebag Bra/Chaps	–	–	–	–	402
Saddlebag Brackets/Supports	–	83	156	249	396-397

Product	VRSC™	SPORTSTER®	DYNA®	SOFTAIL®	TOURING
Saddlebag Extensions	-	-	-	-	392
Saddlebag Filler Strips	-	-	-	-	391
Saddlebag Guard Bags	-	-	-	-	405
Saddlebag Guards/Support Brackets	-	83	-	249, 302	396-398
Saddlebag Inserts/Liners	33	83	156	249, 250	400-403
Saddlebag Latch Covers	-	-	-	-	393
Saddlebag Lights	-	-	-	-	655, 657
Saddlebag Rails	-	-	-	-	394-398
Saddlebags	32-33	80-83	153-156	244-253	392
Saddlebags, Extended	-	-	-	-	392
Screwdrivers	774	774	774	774	774
Seat and Saddlebag Conditioner	765	765	765	765	765
Seat Button Repair Kit	771	771	771	771	771
Seat Hardware	-	73	141	229	365
Seat Pads	29	72	142	228	365
Seat Post	-	-	-	282	-
Seat Rain Covers	-	77	142	229	365
Seat Springs	-	71	138	222	-
Seats	27-29	70-73	135-142	219-229	354-365
Security Cables	752	752	752	752	752
Security Systems/Alarms	749-751	749-751	749-751	749-751	749-751
Shift Levers	48-49	106	177-178	295-297	429-430
Shift Linkages/Covers	48	107	179	298-299	430-431
Shifter Pegs	553-567	553-567	553-567	553-567	553-567
Shifter Shaft Cover/Spacer	-	-	-	297	430
Shock Absorber Pumps	-	-	-	-	407
Shock Spanner Wrench	776	776	776	776	776
Shocks	-	101	158	259	407
Side Covers	-	93, 739	172-173	-	-
Sidecar Accessories	-	-	-	-	460-461
Silencer Grip/Peg Collection	553	553	553	553	553
Sissy Bar Bags/Pouches	-	693-695, 697-699	693-695, 697-699	693-695, 697-699	693-697

Product	VRSC™	SPORTSTER®	DYNA®	SOFTAIL®	TOURING
Sissy Bar Brake Lamp	–	118, 650	650	650	–
Sissy Bar Flag Mounts	–	705	705	705	705
Sissy Bar Luggage Rack	30, 32	78-79	148-149	238-241	374-375
Sissy Bar Pads	29-32	76	146-147	234-236, 238-239	372-373
Sissy Bars	30, 32	74-78	144-147	231-239	370-373
Skull Axle/Pivot Covers	38	96, 97	164, 167	266, 276	412
Skull Caliper Inserts/Medallions	–	67, 747	747	747	747
Skull Console/Tank Trim	–	–	182	318	444
Skull Derby/Timer Cover Collection	–	88	519	519	519
Skull Footboard & Fender Trim	–	–	307	285, 286, 307	398, 421, 438
Skull Fuel Cap/Filler Door	–	112	187, 188	319, 320, 321	440, 453-455
Skull Grip/Peg Collection	561	561	561	561	561
Skull Hand Levers	–	602	602	602	602
Snap Repair Kit	771	771	771	771	771
Solenoid Covers/Caps	–	87	533	533	533
Spacers, Axle/Wheel	39, 43, 665	95, 97, 665	165, 167, 665	267, 273, 665	413, 665
Spark Plug Wires	–	499	499	499	499
Spark Plug/Headbolt Covers	–	91	538-539	538-539	538-539
Spark Plugs	786	498, 786-787	498, 786-787	498, 786-787	498, 786-787
Speaker Grills/Trim Rings	–	–	–	–	433
Speakers and Accessories	–	–	–	–	621, 622, 625
Special Tools	–	501-505	501-505	501-505	501-505
Speedometer/Tachometer	–	110-111	184-185, 190-191	312-313, 316-317	446-448, 450
Spoilers	34	738	738	287, 738	–
Sportster® Derby/Timer Cover Collection	–	88	–	–	–
Spotlight Visors	–	636-639	636-639	636-639	636-639
Spotlights	–	114, 630, 633	630, 633	631, 633	632, 633
Spring Seat Kits	–	71	138	222	–
Sprocket Covers	–	98-99, 685	168, 685	278, 685	415, 685
Sprocket/Rotor Hardware	–	99, 690	170, 690	279, 690	–
Sprockets	43	686-687	671, 686-687	671, 686-687	686-687
Stabilizers, Fuel	782	782	782	782	782



# 830 INDEX

Product	VRSC™	SPORTSTER®	DYNA®	SOFTAIL®	TOURING
Stainless Braided Lines & Cables	607-615	607-615	607-615	607-615	607-615
Starters/Solenoid Covers	–	87	533	533	533
Stash Tubes	–	704	704	704	–
Stealth Grip/Peg Collection	557	557	557	557	557
Steering Stem Bolt Covers	39	105	174	–	–
Storage Bag, Windshields	756	756	756	217, 756	756
Storage Covers	755-757	755-757	755-757	755-757	755-757
Storage Tubes	–	704	704	704	–
Streamliner Grip/Peg Collection	563	563	563	563	563
Struts, Fender	–	–	171	283	415
Supersport Windscreens	25	67, 68	132, 133	209-210	–
Surface Care Products	762-770	762-770	762-770	762-770	762-770
Swingarm	–	98	166	271	–
Swingarm End Caps/Covers	41	97	167	272-277	–
Swingarm Pivot Covers	41	97	–	274-275	–
Swingarm Rock/Debris Guards	40	98	166	271, 272	415
Switch Caps	46, 600, 605	104, 600, 605	174, 600, 605	288, 600, 605	425, 426, 600, 605
Switch Housings, Handlebar	46, 600, 605	104, 600, 605	174, 600, 605	288, 600, 605	425, 426, 600, 605
SYN3® Lubricant	778-779	778-779	778-779	778-779	778-779
Tachometers	–	110-111	185, 190-191	312-313, 316-317	446-448, 450
Tail Lamp Trim	53	651	651	651	651
Tail Lamps	53, 649	118, 648	648-649	648-650	648-650
Taillight/Turn Signals	53, 645	118, 645	645	645	645
Tank Bras/Chaps/Bibs	34	77	142	228	364
Tank Panels/Pouches	31, 34	–	183	310-311	–
Tappet/Lifter Block Cover	–	87	532	532	532
Tappets/Pushrods	–	494	494	494	494
Thermometers	314	314	314	314	449
Threadlocker®	777	777	777	777	777
Throttle and Idle Cables	609-611	609-611	609-611	609-611	609-611
Throttle Cable Clips	606	606	606	606	606
Throttle/Idle Cable Adjuster Covers	–	–	–	601	601

Product	VRSC™	SPORTSTER®	DYNA®	SOFTAIL®	TOURING
Throw-Over Saddlebags	-	81	153, 156	249	-
Tie-Down Straps	758-759	758-759	758-759	758-759	758-759
Timer Covers	-	88-89, 523	516-523	516-523	516-523
Timken® Bearing Race Installer	-	-	493, 501	493, 501	493, 501
Tire Bead Breaker	776	776	776	776	776
Tire Pressure Gauge	775	775	775	775	775
Tire Tubes	791	788, 791	788, 791	788, 791	788, 791
Tires	788-792	788-792	788-792	788-792	788-792
Tool Bags/Pouches/Rolls	-	-	698-699	698-699	-
Tool Kits	774	774	774	774	774
Toolboxes	-	-	-	257	-
Tools	774-776	774-776	774-776	774-776	774-776
Touch-Up Paint	745	745	745	745	745
Touring Bags	32-34, 692-705	80-83, 693-697	153-156, 693-697	244-253, 693-697	404, 693-697
Tour-Pak® Luggage	-	83	-	250, 254-255	378-389
Tour-Pak Luggage – Lid Racks	-	-	-	-	394-395
Tour-Pak Luggage – Lighting	-	-	-	-	390, 394, 650, 657
Tour-Pak Luggage – Liner Bags	-	84	-	255	400-403
Tour-Pak Luggage – Mounting Racks	-	84	-	255	376-377
Tour-Pak Luggage – Trim	-	-	-	-	393-399
Transmission Dipsticks	-	-	536	536	536
Transmission Gear Sets/Kits	-	-	497	497	467
Transmission Oil/Fluid	778-779	778-779	778-780	778-780	778-780
Transmission Tools	-	-	502, 503	502, 503	502, 503
Transmission Top/Side/End Covers	-	-	526-527, 528	526-527, 529-529	526-527, 529-530
Transmissions	-	-	497	497, 501	497, 501
Tribal Grip/Peg Collection	553	553	553	553	553
Trike Accessories	-	-	-	-	456-459
Triple Trees/Covers	-	-	165	262, 268-270	414
Turn Signal Kits	54	114, 116-118	640-641	640-641	632, 634
Turn Signal Lenses/Trim/Visors	646, 647	116, 646-647	646-647	646-647	646-647
Turn Signal/Brake Lamp Modules	53	118, 645	645	645	645

Product	VRSC™	SPORTSTER®	DYNA®	SOFTAIL®	TOURING
Valve Springs/Kits	–	494	494	494	494
Valve Stem Caps	690	690	690	690	690
Voltage Regulators/Covers	37	92	173	287	423
Wash & Shine Products	762-770	762-770	762-770	762-770	762-770
Washer/Nut Assortments	546-547	546-547	546-547	546-547	546-547
Water Pump Hose Cover	36	–	–	–	–
Waxes & Polishes	762-770	762-770	762-770	762-770	762-770
Wheel Bearing Tools	775	775	775	775	775
Wheel/Axle Spacers	39, 43, 665	95, 97, 665	165, 167, 665	267, 273, 665	413, 665
Wheels	42	675, 677-680	665-684	665-684	665-684
Wide Band Grip/Peg Collection	555	555	555	555	555
Wide Tire Kits	–	–	159	–	–
Wind Deflector, Front Fork	–	–	–	270	341
Wind Deflectors, Fairing	–	–	–	–	343, 345, 352
Windshield Bags/Pouches	–	701-702	701-702	701-702	700-702
Windshield Cleaner/Polish	765, 770	765, 770	765, 770	765, 770	765, 770
Windshield Storage Bag	756	756	756	756	756
Windshield Trim	–	–	–	215	341, 343, 346, 654
Windshield/Fairing Trim/Turn Signals	–	–	–	–	346, 347, 654
Windshields	24-25	64, 66-68	131-133	209-217	339-346
X2 Grip/Peg Collection	563	563	563	563	563



Harley-Davidson Parts and Accessories Division, a facility of Harley-Davidson Motor Company, is registered to International Quality Standard ISO 9001:2008.

The sale or use of these parts or accessories does not grant the purchaser a license or other right under any Harley-Davidson patent.

**IMPORTANT – PLEASE READ:** We have tried to make this catalog comprehensive and factual. All product descriptions (including depictions, specifications, dimensions, measurements, ratings and competitive comparisons) are based on available information at the time of publication. Although such descriptions are believed correct, errors and changes can occur and complete accuracy cannot be guaranteed. Harley-Davidson may make changes at any time to prices and specifications, and may change or discontinue any of the items depicted in this catalog, without notice and without incurring any obligation.

**ATTENTION:** Vehicles in the configurations shown and the accessories described in this catalog may not be available for sale or use in some locations. Please check with your dealer for complete product details and the latest information.

**TRADEMARKS:** Acceleration Nation, Aluminator, Badlander, Brawler, Bar & Shield logo, Boom! Audio, Boom! Bagger, Cross Bones, Dark Custom, Dashinator, Destroyer, Detonator, Deuce, Diamond Back, Dyna, Electra Glide, Evolution, Fantail, Fat Bob, Fat Boy, Harley, Harley-Davidson, Harley Owners Group, HD, H-D, Heritage Softail, Heritage Springer, H.O.G., HOG, Hog Ties, Howitzer, Hugger, Iron883, LightningStar, Low Rider, Muscle, Nightster, Night Rod, Night Train, Profile, Rallyrunner, Reach, Revolution, Road Glide, Road King, Road Tech, Road Zeppelin, Rocker, Rockertail, Screamin' Eagle, Sidekick, Signature Series, Softail, Sportster, Springer, Street Bob, Street Glide, Street Stalker, Stripper, Sun Ray, Sunwash, Super Glide, SYN3, Tallboy, ThunderStar, Tour-Pak, Trick, Tri-Glide, T-Sport, Twin Cam 88, Twin Cam 88B, Twin Cam 96, Twin Cam 96B, Twin Cam 103, Twin Cam 103B, Twin Cam 110, Twin Cam 110B, Ultra Classic, V-Rod, VRSC, Wide Glide, Willie G, Wrecking Crew, and the Harley-Davidson Genuine Motor Parts and Genuine Motor Accessories Logo are among the trademarks of H-D Michigan, Inc.

Alcoa, Anacra, Bantam, Bike Bright, Blue Buster, Blue Coral, Bluetooth, Brembo, City Navigator, ClimaShield, Color Lok, Dunlop, Duraflex, Dynojet, Escort, ExpertMeter, Garmin, Google, Hastings, Hylomar, iPod, Kevlar, Lexan, Loctite, Lubit-8, Marzocchi, McIntosh Labs, Naugahyde, Nav Traffic, Nomex, Novus, PJ1, Permatex, Poly Chain, Power Guard, S100, SD, Stylus, Teflon, Threadlocker, Velcro, Windows, WMA, Xenoy, XM, zūmo and all other marks are trademarks of their respective owners.



## BUILD YOUR BIKE ONLINE.

*The Customizer interactive Web tool lets you select your bike, install and remove accessories, and view, save and print the list for the ride you've created. The Customizer gives you the freedom to try different options, reduces the trial and error, and lets you see the visual impact of an accessory before you buy. [www.harley-davidson.com/customizer](http://www.harley-davidson.com/customizer)*

