



Format = Part No., Year, Description, Original Chevrolet Parts Book Group No., Price and Unit of Measure.



Now you can get all of our catalogs on a fully interactive CD. Find parts easily with our illustrated click-thru images. Includes bonus material and catalogs in full color!

Need the latest and greatest parts for your street rod? Ask for our latest Street Rod Headquarters parts catalog. Call us at 800-952-1752 or visit us on the web at www.streetrodhq.com



Providing part numbers speeds up your order, improves accuracy and helps us maintain low prices.

See Illustration Index for core charge information and a list of abbreviations. For Body Model information, see Section 5T.



Format = Part No., Year, Description, Original Chevrolet Parts Book Group No., Price and Unit of Measure.



1941 Cabriolet—Ron Wade, Owner, Chevs of the 40's



Ron Wade's National Vintage Chevrolet Club of America's Best of Show 1941 Cabriolet has over 50 accessories: Air filter-oil bath, antenna-reel, armrest-center, back-up light, beauty rings, clock-electric, compass, cowl vent knob-ivory, crank support-front bumper, crank-hand, defroster, driving lights, emergency brake whistle, exhaust tip-sharks tail, fender skirts, flashlight, fold-down rear guard, foot scraper, gas cap-GM locking, GM caroma, grill-winterguard, grill guard-bumper, heater-super deluxe, hood

ornament-flying lady, horn-town & country, initial holder, license frames, mirror-day/night, mirror-lighted vanity, mirror-right, oil filter, passing lights, radiator screen-outside, radiator-overflow tank, radio-AM and 4-band short wave, radio-pocket portable, rear axle 3.70, rear fender guards, spare tire inflator, spotlight-left and right, steering wheel-spinner, thermometer, tire pump, tires-whitewall, tool kit, turn signals, umbrella-silk, valve cover breather, visor-clip-on, washboards-front fender, wheel disks, and windshield washers.

Returns require a return authorization number, Please call.

Picture Table of Contents — Body Index

Street Rod Parts

Chevs of the 40's is a proud distributor of many of the premier street rod parts providers. We are very excited about the continuing expansion of our inventory to provide for the street rod market as well as continuing the availability of parts for the restorer. As always, if you need any assistance our top-notch sales staff is available on the phone to answer any of the tougher questions.

Core charge information

All core charges are refundable when we receive your rebuildable unit in exchange. Please remove all external parts and brackets.

Part number information

Group and part numbers are original GM when applicable so you may refer to Chev parts book for questions.

Exceptions

Suffix "A" — part not originally available by itself.

Suffix "B" — not originally available as an assembly.

Other suffixes, not originally available by itself or is a modified part.

If you have an addition or correction for this catalog, please give us a call. We want to provide the best possible service for you!

Illustration Index

Air Conditioning & Heating	35T
Axle—Front & Rear	200T
Brake Parts	180T
Bumper	230T
Camshaft	20T
Chassis	pg. 6
Clutch, Drive Shaft and Rear End	140T
Complete Bed	pg. 7
Complete Truck Bed Order Form	490T
Crankshaft	20T
Custom Wheels	220T
Dash Knobs	340T
Door Assembly	380T
Door Panels	330T
Driving, Fog and Spot Lights	85T
Electrical System	pg. 5
Engine Assembly	20T
Engine ID Chart	20T
Engine Kits	20T
Exhaust System	130T
Exterior	pg. 6
Front & Rear Suspension Kits	205T
Gauges—Classic Instruments	350T
Glass	pg. 5
Headlamp	85T
Heating & Air Conditioning	35T
Horn Contact Parts	190T
IFS/IRS Suspension Kits	205T
Interior Kits	330T
Interior	pg. 4
Knobs	340
Paint Combination Chart	pg. 11
Rubber	pg. 5
Series ID Table	pp. 8–10
Sheet Metal	pg. 7
Starter/Generator & Related	40T
Steering Gear	190T
Suspension (aftermarket)	205T
Suspension (stock)	200T
Taillamp	85T
Transmissions	150T
Truck Body Parts (Sheetmetal)	295T
Window Channel	450T
Windshield Wipers	370T
Wiring Harness	60T

Number ID, Production #'s, Paint & Trim Charts (Sect. 5T, 8T)

Gifts, Tools, Insulation, Paints, Solvents, Adhesives, Car Covers (Sect. 10T, 12T, 15T)

Engine Parts, Gaskets Mounts (Sect. 20T, 22T, 24T, 26T)

Cooling, Heating (Sect. 30T, 35T)

Engine Electrical, Starters, Alternators, Ignition (Sect. 40T, 45T, 50T, 55T)

Electrical (Sect. 60T)

Lighting (Sect. 80T, 85T, 90T, 100T, 110T)

Fuel, Exhaust (Sect. 120T, 130T)

Clutch, Transmission, Driveline, Rear Axle (Sect. 140T, 150T, 160T, 170T)

Brakes, Steering (Sect. 180T, 190T)

Suspension, Wheels, Hubcaps, Bearings (Sect. 200T, 205T, 210T, 220T)

Bumpers, Grilles, Hood (Sect. 230T, 240T, 250T)

Fenders, Running Boards, Step Plates (Sect. 270T, 290T)

Body, Sheet Metal, Mounts (Sect. 295T, 300T)

Firewall, Floorboard, Interior (Sect. 310T, 320T, 330T)

Dash, Mirrors, Radio, Wipers (Sect. 340T, 345T, 350T, 360T, 370T)

Doors (Sect. 380T, 390T, 400T)

Window: Glass & Rubber (Sect. 420T, 430T, 440T, 450T, 460T, 470T, 480T)

Complete Beds & Parts (Sect. 490T)

Manuals, Tags, Decals, Photos (Sect. 520T, 530T, 550T, 560T)



Picture Table of Contents—Interior

Format = Part No., Year, Description, Original Chevrolet Parts Book Group No., Price and Unit of Measure.

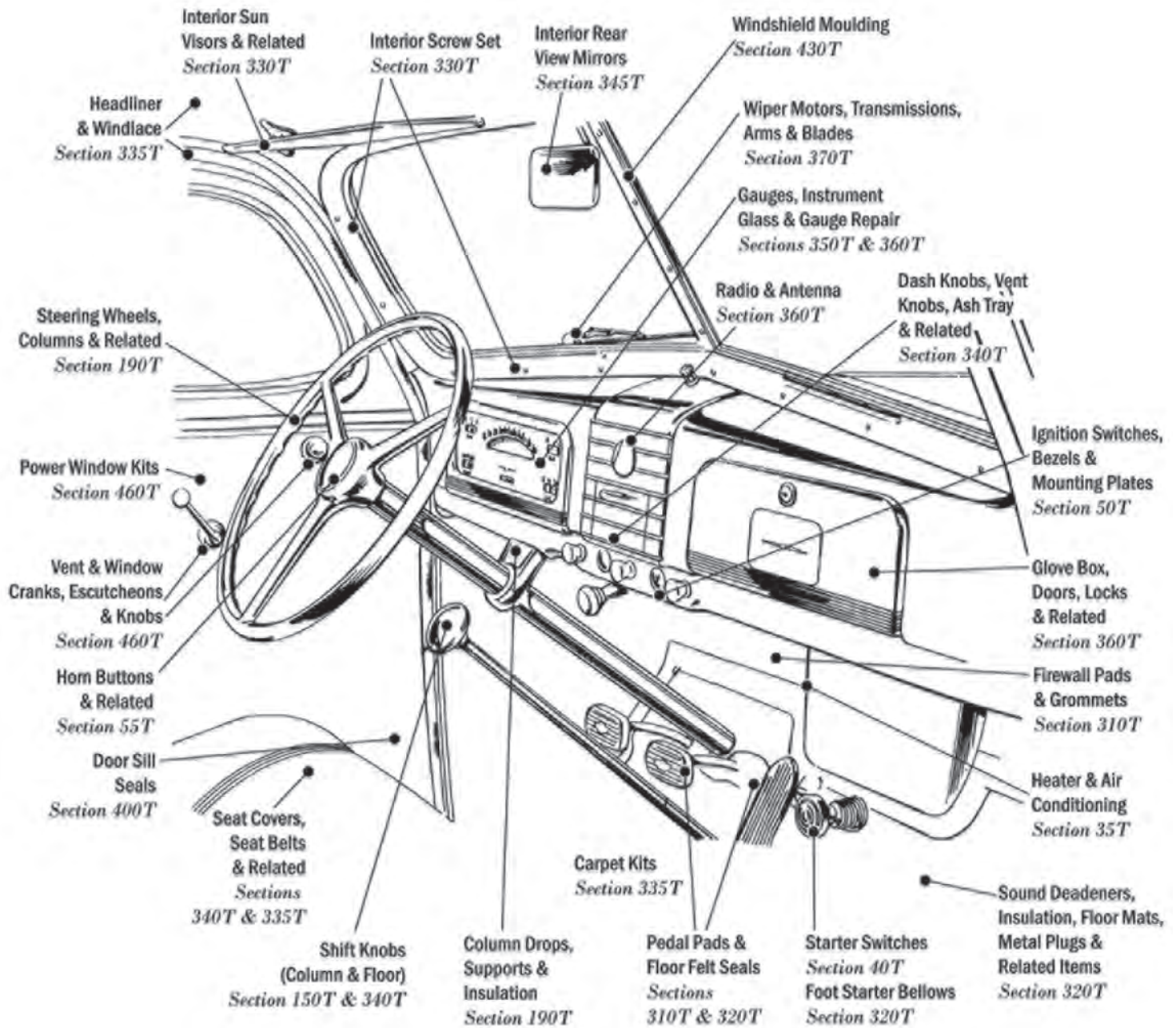

Returns require a return authorization number, Please call.

Picture Table of Contents—Electrical System, Glass & Rubber

Format = Part No., Year, Description, Original Chevrolet Parts Book Group No., Price and Unit of Measure.

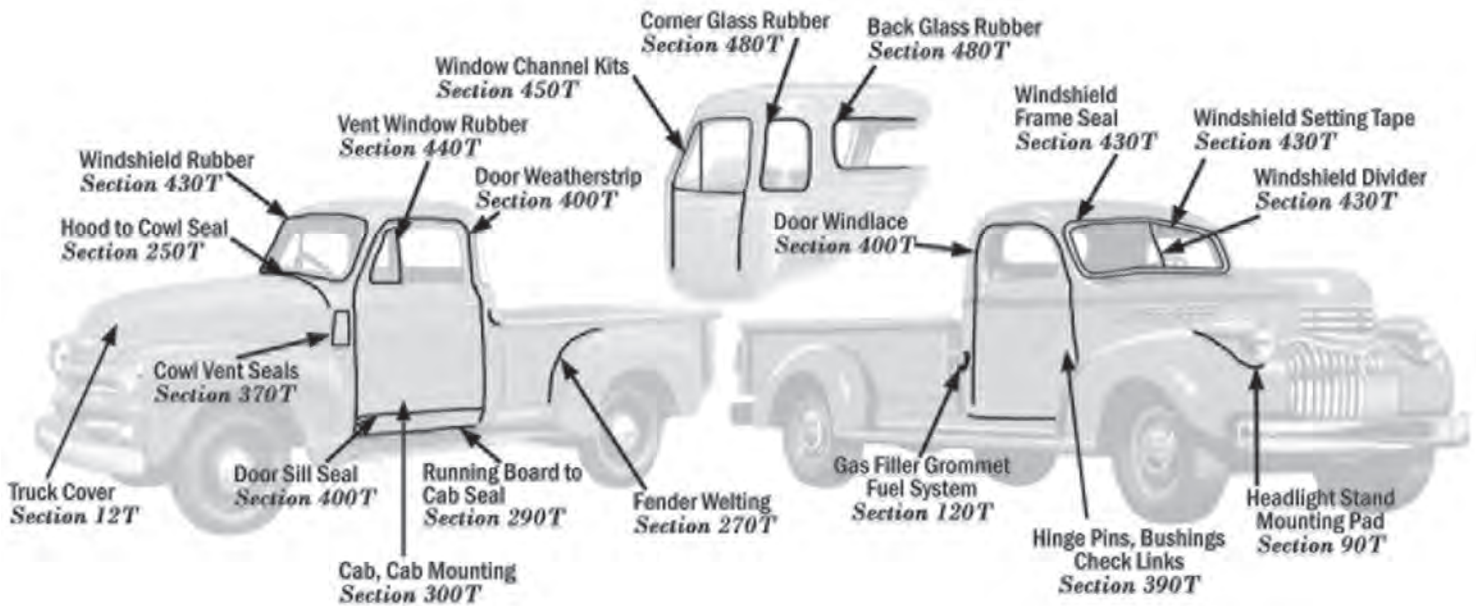
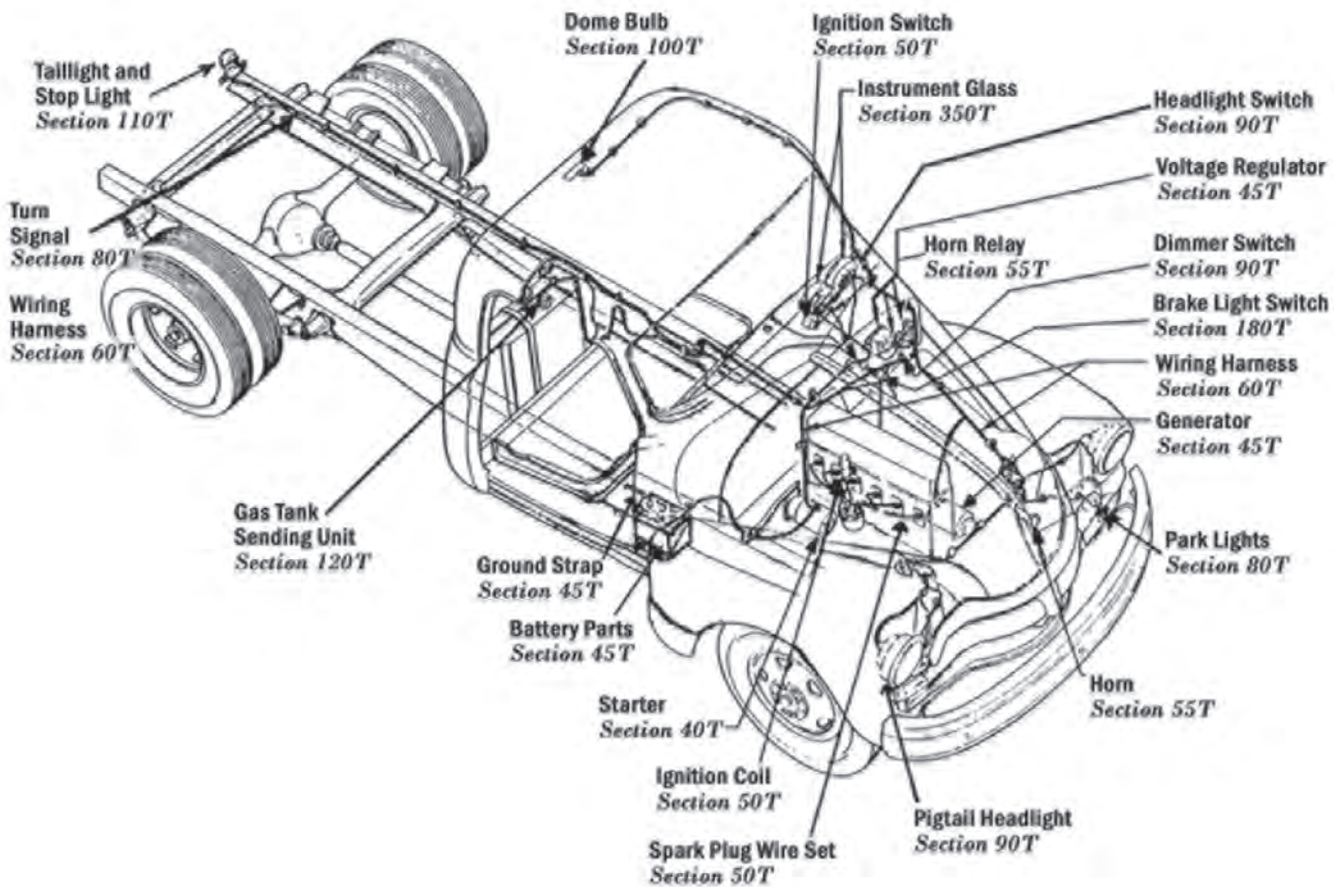

Providing part numbers speeds up your order, improves accuracy and helps us maintain low prices.

See Illustration Index for core charge information and a list of abbreviations. For Body Model information, see Section 5T.



Picture Table of Contents—Chassis and Exterior

Format = Part No., Year, Description, Original Chevrolet Parts Book Group No., Price and Unit of Measure.

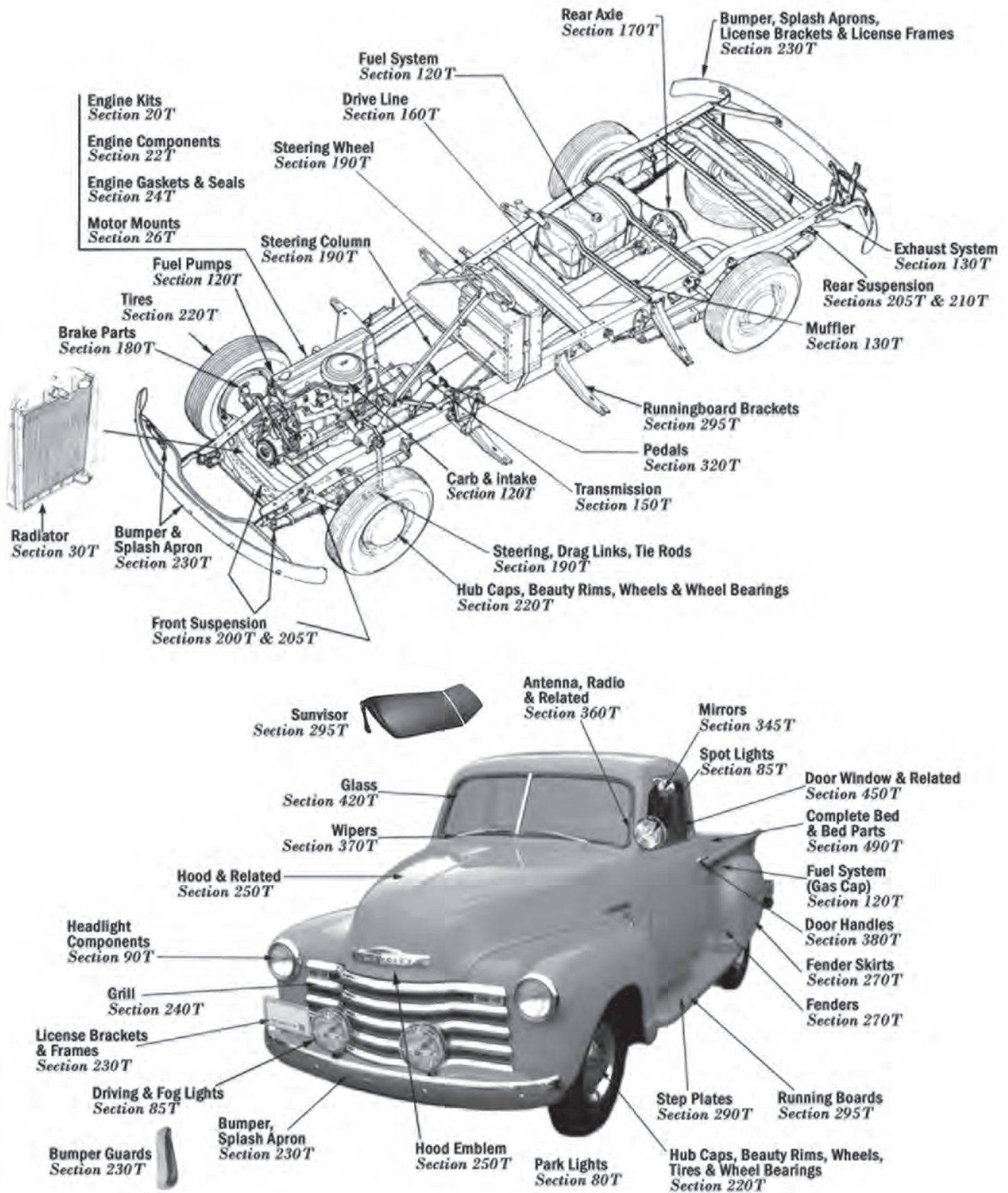

Returns require a return authorization number, Please call.

Picture Table of Contents—Sheet Metal and Complete Bed

Format = Part No., Year, Description, Original Chevrolet Parts Book Group No., Price and Unit of Measure.



Truck Sheet Metal
*All Sheet Metal
 can be found in
 Section 295T.*

Including:
NEW Complete Steel Cabs
Upper and Lower Back Panels
Firewalls
and More

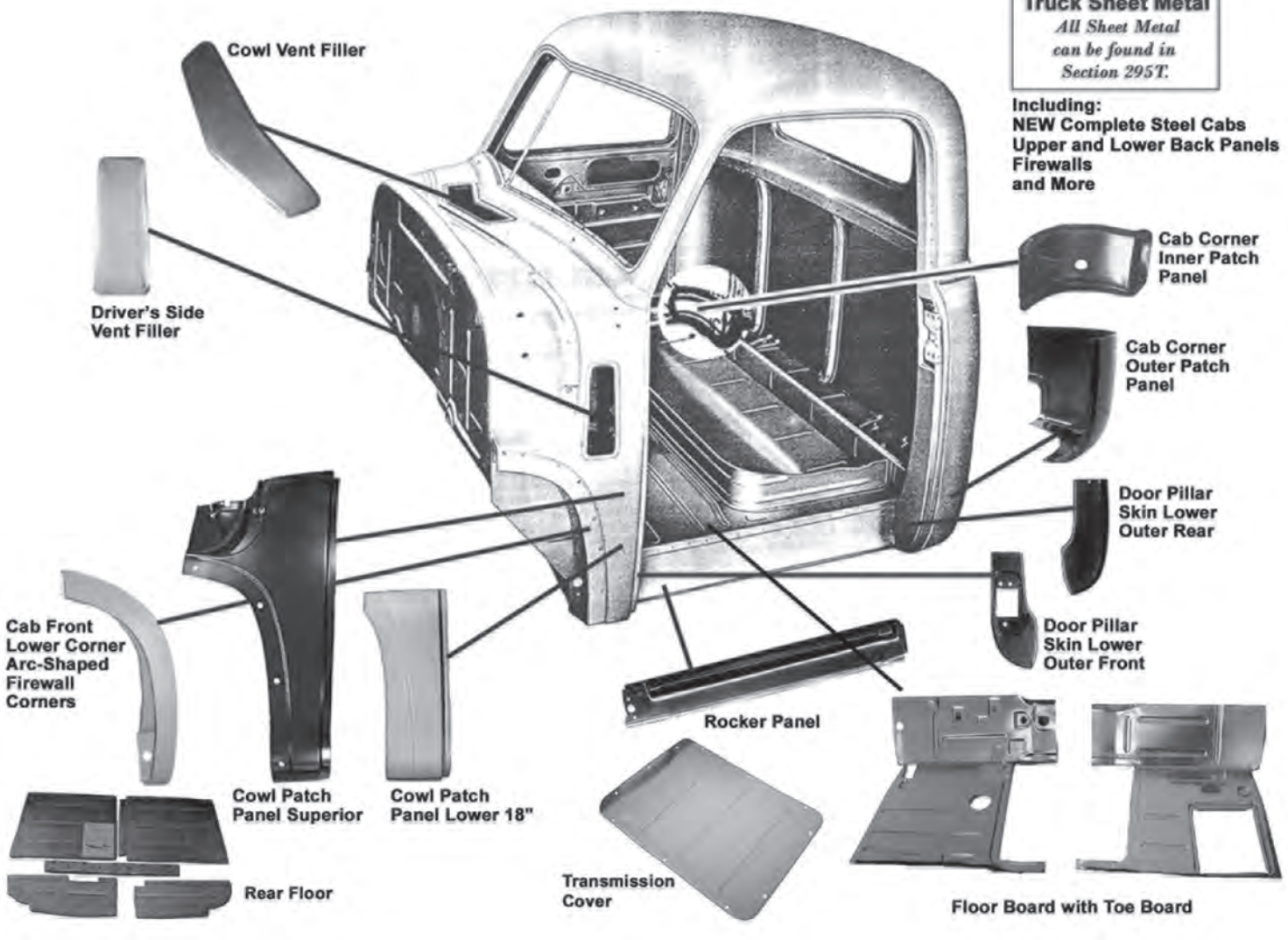

Truck Bed Parts
*All Truck Bed Parts
 can be found in
 Section 490T.*

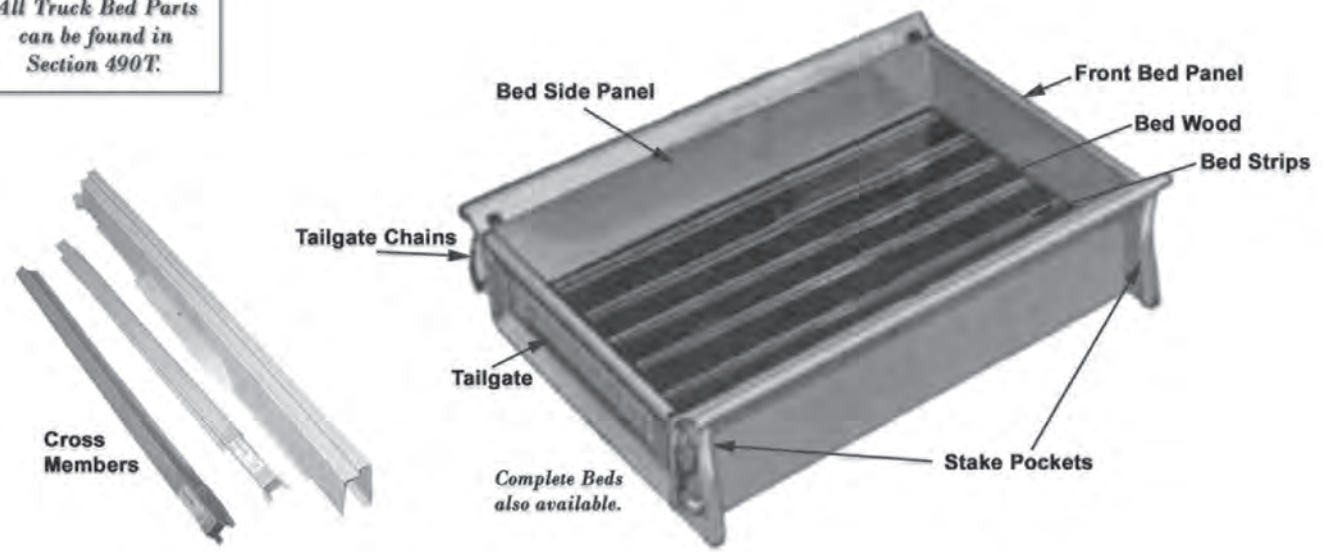



Section 5T: Series Identification Table

Format = Part No., Year, Description, Original Chevrolet Parts Book Group No., Price and Unit of Measure.

Series	Wheelbase	Type of Vehicle
1937		
GA	112-1/4	Passenger (Master De Luxe) with Knee Action (Enclosed Type)
GB	112-1/4	Passenger and Sedan Delivery (Master)
GC	112	Commercial—1/2 Ton Truck
GD	122-1/4	Commercial—3/4 Ton Truck, 11 in. Brakes
GE	22-1/4	Commercial—1 Ton Truck
SA	131-1/2	Utility—1-1/2 Ton Truck, Single Wheels
SB	131-1/2	Utility—1-1/2 Ton Truck, Dual Wheels
SC	157	Utility—1-1/2 Ton Truck, Single Wheels
SD	157	Utility—1-1/2 Ton Truck, Dual Wheels

1938		
HA	112-1/4	Passenger (Master De Luxe) with Knee Action (Enclosed Type)
HB	112-1/4	Passenger and Sedan Delivery (Master)
HC	112	Commercial—1/2 Ton Truck
HD	112-1/4	Commercial—3/4 Ton Truck, 11 in. Brakes
HE	112-1/4	Commercial—1 Ton Truck, 14 in. Brakes
TA	131-1/2	Utility—1-1/2 Ton Truck, Single Wheels
TB	131-1/2	Utility—1-1/2 Ton Truck, Dual Wheels
TC	57	Utility—1-1/2 Ton Truck, Single Wheels
TD	157	Utility—1-1/2 Ton Truck, Dual Wheels

1939		
JA	112-1/4	Passenger (Master De Luxe) with Knee Action (Open Spring Type)
JB	112-1/4	Passenger and Sedan Delivery (Master 85)
JC	113-1/2	Commercial—1/2 Ton Truck
JD	123-3/4	Commercial—3/4 Ton Truck, 11 in. Brakes
JE	123-3/4	Commercial—1 Ton Truck, 14 in. Brakes (Heavy Duty)
VA	133	Utility—1-1/2 Ton Truck, Single Wheels
VB	133	Utility—1-1/2 Ton Truck, Dual Wheels
VC	158-1/2	Utility—1-1/2 Ton Truck, Single Wheels
VD	158-1/2	Utility—1-1/2 Ton Truck, Dual Wheels
VE	107-5/8	Utility—Cab Over Engine, Single Wheels
VF	107-5/8	Utility—Cab Over Engine, Dual Wheels
VG	131-1/8	Utility—Cab Over Engine, Single Wheels
VH	131-1/8	Utility—Cab Over Engine, Dual Wheels
VM	156-5/8	Utility—Cab Over Engine, Single Wheels
VN	156-5/8	Utility—Cab Over Engine, Dual Wheels

Series	Wheelbase	Type of Vehicle
1940		
KA	113	Passenger (Special De Luxe) with Knee Action (Open Spring Type)
KH	113	Passenger (Master De Luxe) with Knee Action (Open Spring Type)
KB	113	Passenger and Sedan Delivery (Master 85), Conventional Front Axle
KC	113-1/2	Commercial—1/2 Ton Truck
KD	123-3/4	Commercial—3/4 Ton Truck, 11 in. Brakes
KE	123-3/4	Commercial—3/4 Ton Truck, 14 in. Brakes, Heavy Duty
KF	133	Commercial—1 Ton Truck
WA	133	Utility—1-1/2 Ton Truck, Single or Dual Wheels
WB	158-1/2	Utility—1-1/2 Ton Truck, Single or Dual Wheels
WV	193-5/8	Utility—School Bus Chassis, Dual Wheels
WD	107-5/8	Utility—Cab Over Engine
WE	131-1/8	Utility—Cab Over Engine
WF	156-5/8	Utility—Cab Over Engine

1941		
AH	116	Passenger (Special De Luxe) with Knee Action (Open Spring Type)
AG	116	Passenger and Sedan Delivery (Master De Luxe) with Knee Action (Open Spring Type)
AK	115	Commercial—1/2 Ton Truck
AL	125-1/4	Commercial—3/4 Ton Truck, 11 in. Brakes
AM	125-1/4	Commercial—3/4 Ton Truck, 14 in. Brakes, Heavy Duty
AN	134-1/2	Commercial—1 Ton Truck
YR	134-1/2	Utility—1-1/2 Ton Truck, Single or Dual Wheels
YS	160	Utility—1-1/2 Ton Truck, Single or Dual Wheels
YT	95	Utility—School Bus Chassis, Dual Wheels
YU	109	Utility—Cab Over Engine
YV	132-1/2	Utility—Cab Over Engine
YW	158	Utility—Cab Over Engine
1942		
BH	116	Passenger (Special De Luxe)
BG	116	Passenger and Sedan Delivery (Master De Luxe)
BK	115	Commercial—1/2 Ton Truck
BL	125-1/4	Commercial—3/4 Ton Truck, 11 in. Brakes
BM	125-1/4	Commercial—3/4 Ton Truck, 14 in. Brakes

Returns require a return authorization number, Please call.

Section 5T: Series Identification Table

Format = Part No., Year, Description, Original Chevrolet Parts Book Group No., Price and Unit of Measure.



Series	Wheelbase	Type of Vehicle
1941, continued		
BN	134-1/2	Commercial—1 Ton Truck
MR	134-1/2	Utility—1-1/2 Ton Truck, Single or Dual Wheels
MS	160	Utility—1-1/2 Ton Truck, Single or Dual Wheels
MY	160	Utility—School Bus Chassis, Dual Wheels
MT	195	Utility—School Bus Chassis, Dual Wheels
MU	109	Utility—Cab Over Engine
MV	132-1/2	Utility—Cab Over Engine
MW	158	Utility—Cab Over Engine

First Design	Second Design	Wheelbase	Type of Vehicle
--------------	---------------	-----------	-----------------

1946			
DK		116	Passenger (Fleetmaster and Fleetline)
DJ		116	Passenger (Stylemaster)
CK	DP	115	Commercial—1/2 Ton Truck
	DR	125-1/4	Commercial—3/4 Ton Truck
	DS	134-1/2	Commercial—1 Ton Truck
OR	PJ	134-1/2	Utility—1-1/2 Ton Truck
OS	PK	160	Utility—1-1/2 Ton Truck
OW	PL	160	Utility—School Bus Chassis
OY		195	Utility—School Bus Chassis
OE	PV	134-1/2	Utility—2 Ton Truck
OF	PW	160	Utility—2 Ton Truck
OG	PX	195	Utility—School Bus Chassis
OH	PP	109	Utility—2 Ton Truck, Cab Over Engine
OI	PR	132-1/2	Utility—2 Ton Truck, Cab Over Engine
OJ	PS	158	Utility—2 Ton Truck, Cab Over Engine

Series	Wheelbase	Type of Vehicle
1947		
EK	116	Passenger (Fleetmaster and Fleetline)
EJ	116	Passenger (Stylemaster)
EP	116	Commercial Type of Vehicles
ER	125-1/4	Commercial—3/4 Ton Truck
ES	137	Commercial—1 Ton Truck
QJ	137	Utility—1-1/2 Ton Truck
QK	161	Utility—1-1/2 Ton Truck
QL	161	Utility—School Bus Chassis
QV	137	Utility—2 Ton Truck
QW	161	Utility—2 Ton Truck
QX	199	Utility—School Bus Chassis
QP	110	Utility—2 Ton Truck, Cab Over Engine
QR	134	Utility—2 Ton Truck, Cab Over Engine

Series	Wheelbase	Type of Vehicle
1948		
QS	158	Utility—2 Ton Truck, Cab Over Engine
FK	116	Passenger (Fleetmaster and Fleetline)
FJ	116	Passenger (Stylemaster)
FP	116	commercial—1/2 Ton Truck
FR	125-1/4	Commercial—3/4 Ton Truck
FT	125-1/4	Commercial—3/4 Ton Truck (Dubl-Duti), Forward Control Delivery Chassis
FS	137	Commercial—1 Ton Truck
FU	137	Commercial—1 Ton Truck (Dubl-Duti), Forward Control Delivery Chassis
RJ	137	Utility-1-Utility—1-1/2 Ton Truck
RK	161	Utility-1-Utility—1-1/2 Ton Truck
RL	161	Utility—School Bus Chassis
RV	137	Utility—2 Ton Truck
RW	161	Utility—2 Ton Truck
RX	199	Utility—School Bus Chassis
RP	110	Utility—2 Ton Truck, Cab Over Engine
RR	134	Utility—2 Ton Truck, Cab Over Engine
RS	158	Utility—2 Ton Truck, Cab Over Engine

1949			
GK	2100	115	Passenger (Deluxe), Styleline and Fleetline
GJ	1500	115	Passenger (Special), Styleline and Fleetline
GP	3100	116	Commercial—1/2 Ton Truck
GR	3600	125-1/4	Commercial—3/4 Ton Truck
GT	3700	125-1/4	Commercial—3/4 Ton Truck (Dubl-Duti), Forward Control Delivery Chassis
GS	3800	137	Commercial—1 Ton Truck
GU	3900	137	Commercial—1 Ton Truck (Dubl-Duti), Forward Control Delivery Chassis
SJ	4100	137	Utility—1-1/2 Ton Truck
SK	4400	161	Utility—1-1/2 Ton Truck
SL	4500	161	Utility—School Bus Chassis
SV	6100	137	Utility—2 Ton Truck
SW	6400	161	Utility—2 Ton Truck
SX	6700	199	Utility—School Bus Chassis
SP	5100	110	Utility—2 Ton Truck, Cab Over Engine
SR	5400	134	Utility—2 Ton Truck, Cab Over Engine
SS	5700	158	Utility—2 Ton Truck, Cab Over Engine

1950			
HK	2100	115	Passenger (Deluxe), Styleline and Fleetline
HJ	1500	115	Passenger (Special), Styleline and Fleetline
HP	3100	116	Commercial—1/2 Ton Truck
HR	3600	125-1/4	Commercial—3/4 Ton Truck

Providing part numbers speeds up your order, improves accuracy and helps us maintain low prices.

See Illustration Index for core charge information and a list of abbreviations. For Body Model information, see Section 5T.



Section 5T: Series Identification Table

Format = Part No., Year, Description, Original Chevrolet Parts Book Group No., Price and Unit of Measure.

Series	Wheelbase	Type of Vehicle
1950, continued		
HT	3700	125-1/4 Commercial—3/4 Ton Truck (Dubl-Duti), Forward Control Delivery Chassis
HS	3800	137 Commercial—1 Ton Truck
HU	3900	137 Commercial—1 Ton Truck (Dubl-Duti), Forward Control Delivery Chassis
TJ	4100	137 Utility—1-1/2 Ton Truck
TK	4400	161 Utility—1-1/2 Ton Truck
TL	4500	161 Utility—School Bus Chassis
TV	6100	137 Utility—2 Ton Truck
TW	6400	161 Utility—2 Ton Truck
TY	6500	179 Utility—2 Ton Truck
TX	6700	199 Utility—School Bus Chassis
TP	5100	110 Utility—2 Ton Truck, Cab Over Engine
TR	5400	134 Utility—2 Ton Truck, Cab Over Engine
TS	5700	158 Utility—2 Ton Truck, Cab Over Engine

Series	Wheelbase	Type of Vehicle
1951		
JK	2100	115 Passenger (Deluxe), Styleline and Fleetline
JJ	1500	115 Passenger (Special), Styleline and Fleetline
JP	3100	116 Commercial—1/2 Ton Truck
JR	3600	125-1/4 Commercial—3/4 Ton Truck
JT	3700	125-1/4 Commercial—3/4 Ton Truck (Dubl-Duti), Forward Control Delivery Chassis
JS	3800	137 Commercial—1 Ton Truck
JU	3900	137 Commercial—1 Ton Truck (Dubl-Duti), Forward Control Delivery Chassis
UJ	4100	137 Utility—1-1/2 Ton Truck
UK	4400	161 Utility—1-1/2 Ton Truck
UL	4500	161 Utility—School Bus Chassis
UV	6100	137 Utility—2 Ton Truck
UW	6400	161 Utility—2 Ton Truck
UY	6500	179 Utility—2 Ton Truck
UX	6700	199 Utility—School Bus Chassis
UP	5100	110 Utility—2 Ton Truck, Cab Over Engine
UR	5400	134 Utility—2 Ton Truck, Cab Over Engine
US	5700	158 Utility—2 Ton Truck, Cab Over Engine

Series	Wheelbase	Type of Vehicle
1952		
KK	2100	115 Passenger (Deluxe), Styleline and Fleetline
KJ	1500	115 Passenger (Special), Styleline and Fleetline
KP	3100	116 Commercial—1/2 Ton Truck
KR	3600	125-1/4 Commercial—3/4 Ton Truck
KT	3700	125-1/4 Commercial—3/4 Ton Truck (Dubl-Duti), Forward Control Delivery Chassis
KS	3800	137 Commercial—1 Ton Truck

Series	Wheelbase	Type of Vehicle
1952, continued		
KU	3900	137 Commercial—1 Ton Truck (Dubl-Duti), Forward Control Delivery Chassis
VJ	4100	137 Utility—1-1/2 Ton Truck
VK	4400	161 Utility—1-1/2 Ton Truck
VL	4500	161 Utility—1-1/2 Ton, School Bus Chassis
VV	6100	137 Utility—2 Ton Truck
VW	6400	161 Utility—2 Ton Truck
VY	6500	179 Utility—2 Ton Truck
VX	6700	199 Utility—2 Ton Truck, School Bus Chassis
VZ	6800	212 Utility—2 Ton Truck, School Bus Chassis
VP	5100	110 Utility—2 Ton Truck, Cab Over Engine
VR	5400	134 Utility—2 Ton Truck, Cab Over Engine
VS	5700	158 Utility—2 Ton Truck, Cab Over Engine

Series	Wheelbase	Type of Vehicle
1953-54		
A	1500	115 Passenger (One Fifty), excluding 1508
B	2100	115 Passenger (Two Ten)
C	2400	115 Passenger (Bel Air)
D	1508	115 Sedan Delivery
H	3100	116 Commercial—1/2 Ton Truck
J	3600	124-1/4 Commercial—3/4 Ton Truck
K	3700	124-1/4 Commercial—3/4 Ton Truck (Dubl-Duti), Forward Control Delivery Chassis
L	3800	137 Commercial—1 Ton Truck
M	3900	137 Commercial—1 Ton Truck (Dubl-Duti), Forward Control Delivery Chassis
N	4100	137 Utility—1-1/2 Ton Truck
P	4400	161 Utility—1-1/2 Ton Truck
R	4500	161 Utility—School Bus Chassis
S	5100	110 Utility—2 Ton Truck, Cab Over Engine
T	5400	134 Utility—2 Ton Truck, Cab Over Engine
U	5700	158 Utility—2 Ton Truck, Cab Over Engine
V	6100	137 Utility—2 Ton Truck
W	6400	161 Utility—2 Ton Truck
X	6500	179 Utility—2 Ton Truck
Y	6700	199 Utility—School Bus Chassis
Z	6800	212 Utility—School Bus Chassis

Returns require a return authorization number, Please call.

Section 5T: Series Identification Table

Format = Part No., Year, Description, Original Chevrolet Parts Book Group No., Price and Unit of Measure.



15



1937 1937 was the first year Chevrolet began to offer 3/4- and one-ton trucks as standard models. Chevrolet also introduced the 216 engines and increased the number of main bearings to four. With the gas tank under the seat, the passenger seat must be removed to fill the tank. The half-ton bed length increased from 72 inches to 77 inches. Other Chevrolet truck changes that year included the truck headlights attached to the radiator shell sides and the treads on the running boards ran the length of board.



1938 The 1938 Chevrolet truck model was much like the 1937 truck. Still, some changes included the gas tank filler extended through the cab wall instead of under the seat and a heavier bumper with a painted streak was added. The pickup used the flat head six-cylinder engine borrowed from Pontiac. This was the last year Chevrolet used the generator cutout.



1939 The 1939 and 1940 Chevrolet trucks had a restyled and reengineered cab and front sheet metal. The new models were the best-looking trucks in Chevrolet Division's history. The Chevy cab was designed for driver comfort and convenience. In 1939 Chevrolet launched its first cab-over-engine truck. This was also the first year Chevrolet used script lettering on the tailgate, and the last year for oval taillights.



1940 Chevrolet continued the new design into the 1940 model year. One of the more obvious differences from the 1939 models was the uppermost grille bar with the large Chevrolet name written in red script letters. Minor changes in the cab included the instrument panel, curved with a rectangular gauge cluster design from the passenger cars. Chevrolet introduced the rectangular taillight that year and the Chevy bed became three inches wider.



1941 The 1941 Chevrolet trucks entire front end was all new. The larger, more impressive truck had an increased wheelbase and more power. Chevy discontinued the stamped name in the tailgate that year. The longer wheelbase enabled the cab area with additional legroom and the seat back was reclined to a more comfortable angle. The headlight assemblies were secured to the fenders.



1942 The 1942 Chevrolet trucks were essentially unchanged from 1941. The government halted all automobile production in early 1942 because of World War II. Chevrolet resumed production of civilian trucks for general sales in August, 1945. The government allowed Chevrolet to build civilian heavy-duty chassis cabs for qualified essential users in both 1944 and 1945 and the half-ton 115-inch wheelbase pickup in 1945 for qualified essential civilian users.



1946 In 1946 Chevrolet brought a full line of light, medium, and heavy-duty trucks to the market. All the trucks that year came complete with chrome trim. The Coupe Pickup was the only prewar model that didn't return. The light-duty engine was the same as the prewar engine. Only minor changes were made to the Chevy models in 1946.

Providing part numbers speeds up your order, improves accuracy and helps us maintain low prices.

See Illustration Index for core charge information and a list of abbreviations. For Body Model information, see Section 5T.



Section 5T: Series Identification Table

Format = Part No., Year, Description, Original Chevrolet Parts Book Group No., Price and Unit of Measure.



1947 1947 was the year of major overall for Chevrolet. The Advanced Design trucks entered production with a multitude of model changes. The new Chevy's had a larger cab, more comfortable seats and driving better vision. The gas tank was moved to under the truck bed that year. The 3" wider bed had nine planks, versus the seven from the year before. The Chevrolet name was stamped into tailgate. The larger windshield and bigger side and rear window glass and optional rear-quarter windows greatly improved safety and driver vision.

1948 Chevrolet only made minor changes to their models this year. The transmission gear shift lever was moved to the steering column from the floor, while the parking brake was changed from a floor mounted lever to a foot actuated pedal.

1949 Still only minor changes were made this year. The gas tank was moved into the cab behind the seat back. The Chevy hood emblem became a chrome-plated steel. This was the last year Chevrolet used the lever action shocks.



1950 In 1950 the 216.5 cubic inch six was tweaked to put out more horsepower. The new modern tubular shocks were introduced this year. The Chevrolet hood side emblem show their name plus 3100 for a 1/2 ton, 3600 on a 3/4 ton and 3800 on a 1 ton.

1951 In 1951 the left-side cowl vent was eliminated and replaced with the door vent windows. The seat adjustment with the metal cable is changed to a rod under the cushion which is run through a rubber grommet and secured to the seat riser frame. In mid-year, the Chevy truck bed changed from nine boards to eight. The maximum speedometer speed was 80 mph.



1952 Push-button door handles were introduced in the 1952 model year. The Chevrolet hub-caps changed from being chrome plated to gray painted steel with black block letters, though the stamping and shape remained the same as prior years. Some say a very few deluxe 1/2 ton pickups still carried the chrome cap. The truck speedometer now shows a maximum speed of 90 mph.



1953 The Chevrolet truck hood emblem is now stainless steel. This was the first year Chevy offered the optional left side mount spare tire on the pickups. 1953 was the last year for wood blocks under the truck bed.



1954 Chevrolet introduced the one-piece windshield, an all-new grille, new parking lights, a new steering wheel and a redesigned dashboard. The new high-pressure 235 cubic inch insert bearing engine on the pickups and 261 cubic inch six-cylinder on large trucks began that year. The Chevy hubcaps had the same shape as before; however, they had only the bowtie emblem. The redesigned bed changed to increase the bed depth with all new bed sides. The optional rear bumper is dropped in the center to make room for the new license plate location.

Returns require a return authorization number, Please call.

Section 8T: Paint Combination Chart

Format = Part No., Year, Description, Original Chevrolet Parts Book Group No., Price and Unit of Measure.



Body		Moulding		Stripe	
1937-39					
242	Swifts Commercial Red	225	—	Argent Silver	2894202
243	Export Blue	314	—	Argent Silver	2894202
244	Brewster Green Med.	267	—	Gigolo Green	2899862
1940-46					
242	Swifts Commercial Red		Black Duco	2072122	Argent Silver 2894202
269	Boatswain Blue		Argent Silver	2894202	Totem Scarlet 28950165
257	Apple green		Cream Medium	2896596	Emerald Green 2893133
312	Amour Yellow		Omaha Orange	2896276	Moulding Black 2072122
234	Cream Medium		Export Blue	2897128	Argent Silver 2894202
314	Export Blue		Argent Silver	2894202	Totem Scarlet 28950165
262	Omaha Orange		Chess Blue	28950666	White Striping 289008
313	Aluminum (Silver)		Totem Scarlet	28950165	Moulding Black 2072122
Most Common Colors					
	Brewster Green		1940 uses Cream Medium		1940 uses Emerald Green
	Black		Kildaire Green	28950701	Emerald Green 2893133
			Emerald Green	2893133	Cream Medium 2896596
			1940 uses Omaha Orange		1940 uses Chess Blue
264	White		Kildaire Green	28950701	White Striping 289008
301	Hollywood Tan (Oakland Plant)		Moulding Black	2072122	White Striping 289008
	Bordeaux Maroon (Terrytown and Baltimore Plants)		Moulding Black	2072122	Gold Bronze Powder
Upper Body		Lower Body		Moulding	
1941-46 Suburban					
	Airdale Brown		Circassion Brown		
			Kildaire Green	28950701	White Striping 289008
Body		Moulding		Stripe	
1947-49					
	Fathom Green		—		—
1947-53					
	Windsor Blue		—		—
	Cape Maroon		—		—
	Swift Red (Commercial Red)		—		—
	Amour Yellow		—		—
	Sun Beige		—		—
	Forester Green		—		—
	Seacrest Green		—		—
1947-55					
	Omaha Orange (GMC)		—		Jet Black
	Cream Medium		—		Jet Black
	Mariner Blue		—		Cream Medium
	White		—		Juniper Green
1948-49					
	Channel Green		—		—
1951-55					
	Yukon Yellow		—		Jet Black
	Burgundy Maroon		—		Gold Bronze
	Copper Tone		—		Shell White
	Ocean Green		—		Jet Black
	Autumn Brown		—		Shell White
	Transport Blue		—		Cream Medium
	Juniper Green		—		Cream Medium

Providing part numbers speeds up your order, improves accuracy and helps us maintain low prices.

See Illustration Index for core charge information and a list of abbreviations. For Body Model information, see Section 5T.



Section 10T: Gift Items, Collectibles, Truck Covers & Vehicle Maintenance

Format = Part No., Year, Description, Original Chevrolet Parts Book Group No., Price and Unit of Measure.

Hats



HAT-CHEVS1
Choose Black or Navy preformed ball cap with Chevs embroidered logo and red, white & blue detailing on brim.

One size fits all with velcro closure.
(-0) \$12.00 EA



HAT-CHEVS2
Beanie/ Stocking cap. Navy with Chevs embroidered logo. One size fits all.

(-15)..... \$12.00 EA

T-Shirt



SHIRT
New & Improved!
CHEVS OF THE 40's t-shirt. 100% cotton, white t-shirt with small logo on front, large on back. Specify size: Med, Lrg, X-Lrg or XXX-Lrg. (0-0)\$8.00 EA

Hoodies



HOODIE-CH1
Large or XL cotton hoodies with Chevs chest logo. Choose Black, Grey, Navy or Red. (0-15) \$20.00 EA

HOODIE-CH2
XXL (Black, Navy or Grey) or XXXL (Black or Navy). Single Chevs logo on left chest. (0-15) \$25.00 EA

Vintage Chevrolet Cooler



COOLER
Includes mini tray and side mount bottle opener. Choose Red or Blue.
(0-0)\$115.00 EA

Neon Sign



NEONSIGN01
Large "Genuine Chevrolet Parts". Uses standard household current. 46" x 48". Mounting hardware included.

(0-0)\$816.00 EA

Turntable



TURNTABLE
Electric rotating vehicle display. Vehicle hovers over ground. Rotates at 0.6 rpm max. Safety stop for the slightest bump or obstruction. Easy to setup and transport. Made in the USA!. (0-15) ...\$4,950.00 EA

Artwork

Complement your office, den, garage or living room with these prints of classic Chevrolet vehicles. All are limited print runs.



ART1
Hauler Heaven. 15" X 30" color print of trucks. Limited print run of 750. See if you can find your favorite truck.
(0-15) \$85.00 EA



ART3
Chevy Farm. 15" X 30" color print of classic cars. Limited print run of 650.
(0-15) \$75.00 EA



ART4
Fifties Junkpile. 32" X 23" color print of cars. Limited print run of 1500. See if you can find your favorite GM vehicle from the 50s.
(0-15) \$95.00 EA



RW183
'MOTORAMA 54' limited edition, 36" x 20" print. Signed & numbered (950 total print run) color print showing GM concept cars minutes before the doors open. (-0) \$98.00 EA

Bar Table -Custom Wheel



HBBAS-02
HIGH BOY with 30" Black Table Top. 4 stack wheel design.
(-15).....\$499.00 EA



LBBAS-02
LOW BOY with 30" Black Table Top. 3 stack wheel design.
(-15).....\$449.00 EA

Stools -Custom Wheel



STOOLWMM-01
Mechanics stool. 17" height. (-15)\$159.00 EA

Returns require a return authorization number, Please call.

Section 10T: Gift Items, Collectibles, Truck Covers & Vehicle Maintenance



Format = Part No., Year, Description, Original Chevrolet Parts Book Group No., Price and Unit of Measure.

10T



STOOLW-01
CLASSIC. 16" diameter,
29" seat height. 3 hoop
design. (-15) \$399.00 EA



STOOLW-02
CRUISER. 18" diameter,
29" seat height. 3 hoop stacked
design. (-15) \$499.00 EA



STOOLW-03
DEUCE. 18" diameter,
19" seat height. 2
hoop stacked design.
(-15) \$349.00 EA



STOOLW-04
SPORSTER. 16" diameter,
29" seat height. 3 hoop design
without backrest.
(-15) \$349.00 EA

Shown with High Boy Table (sold separately)

Stools



STOOLPB
Chevrolet Parts.
Yellow, red and blue
swivel with backrest.
(0-15).....\$120.00 EA



STOOLSB
Chevrolet Service.
Blue and white swivel
seat with backrest.
(0-15).....\$120.00 EA



STOOLP
Chevrolet Parts.
Yellow, red and
blue swivel seat.
(0-15).....\$90.00 EA



STOOLS
Chevrolet Service
stool. Blue and
white swivel seat.
(0-15).....\$90.00 EA



STOOLB1
Buick Service.
(0-15).....\$90.00 EA



STOOLB2
Chevy Bowtie.
(0-0).....\$90.00 EA



STOOLB2B
Chevy Bowtie
w/ backrest.
(0-15) \$125.00 EA



STOOLB3
Belair w/ backrest.
(0-15) \$140.00 EA



STOOLG1
GMC Trucks.
(0-15).....\$90.00 EA



STOOLO1
Oldsmobile Service.
(0-15).....\$90.00 EA



STOOLP1
Pontiac Service.
(0-15).....\$90.00 EA

Model 1:6 Scale Chevy Small Block



MODEL12SR
Produced by Liberty Classic. Cool
scaled rendition of a tried-and-
true classic (limited quantity).
(0-15) \$35.00 EA

Providing part numbers speeds up your order, improves accuracy and helps us maintain low prices.

See Illustration Index for core charge information and a list of abbreviations. For Body Model information, see Section 5T.



Section 10T: Gift Items, Collectibles, Truck Covers & Vehicle Maintenance

Format = Part No., Year, Description, Original Chevrolet Parts Book Group No., Price and Unit of Measure.

Watches

Each watch comes packaged in a collectible tin gift box with Chevrolet logo and 3 year limited warranty.



WAT20027
Chevrolet Men's
Two-Tone Metal Band
Calendar Watch
(0-15) \$52.00 EA



WAT20033
Chevrolet men's metal
band calendar watch
(0-15) \$42.00 EA



WAT22355
Chevy Trucks Men's
Calendar Watch
(0-15) \$48.00 EA



WATL29
Ladies Route 66,
black face, radial
dial calendar watch.
Stainless steel band.
(0-15) \$42.00 EA

Neon Marquee Sign -Large 10 Foot Length



NEON120UC
10 Feet Long! OK Used Cars in Red & Yellow. (-15) \$5,000.00 EA



NEON120CO
10 Feet Long! "Chevrolet Corvette
Garage" in Red, Black & Yellow.
(-15) \$5,000.00 EA

Neon Marquee Sign & Clock -72" Length



NEON72UC-YEL
6' x 26" tall. (-15) \$1,250.00 EA



NEON72SS-BW
6' x 26" tall. (-15) \$1,250.00 EA



NEON72SV-BLK
6' x 26" tall. (-15) \$1,250.00 EA



NEON72SV-YEL
6' x 26" tall. (-15) \$1,250.00 EA



NEON72GO-RED
6' x 26" tall. (-15) \$1,250.00 EA



NEON72SV-BLU
6' x 26" tall. (-15) \$1,250.00 EA



NEON72MM-RED
"MOPAR Muscle Motors", 6' x 26" tall
with 20" neon clock. (-15) . \$1,250.00 EA

Neon Marquee Sign -48" Length



NEON48G-BLK
"ROUTE 66 GARAGE", 48" x 24" tall, 8"
deep. (-15) \$600.00 EA



NEON48G-BLU
"GENUINE FORD PARTS GARAGE",
48" x 24" tall, 8" deep. (-15) . \$600.00 EA



NEON48G-GRN
"LAST CHANCE GARAGE", 48" x 24"
tall, 8" deep. (-15) \$600.00 EA

Returns require a return authorization number, Please call.

Section 10T: Gift Items, Collectibles, Truck Covers & Vehicle Maintenance

Format = Part No., Year, Description, Original Chevrolet Parts Book Group No., Price and Unit of Measure.



10T



NEON48GL-RED
"TEXACO HIGH OCTANE GASOLINE",
48" x 24" tall, 8" deep. (-15) . \$600.00 EA



NEON48S-YEL
"CHEVROLET SERVICE", 48" x 24" tall,
8" deep. (-15)\$600.00 EA



NEON34GST-RED
"TEXACO GAS", 34" x 24" tall, 8" deep.
(-15)\$600.00 EA



NEON48G-YEL
"CHEVROLET PARTS GARAGE", 48" x
24" tall, 8" deep. (-15)\$600.00 EA



NEON48UC-YEL
"OK USED CARS", 48" x 24" tall, 8"
deep. (-15)\$600.00 EA



NEON34PG-BLK
"POLLY GAS", 34" x 24" tall, 8" deep.
(-15)\$600.00 EA

Neon Marquee Sign -34"
Length



NEON48S-BLK
"PHILLIPS 66 SERVICE", 48" x 24" tall,
8" deep. (-15)\$600.00 EA



NEON34GS-BLK
"PHILLIPS 66 GAS", 34" x 24" tall, 8"
deep. (-15)\$600.00 EA

Clocks-Large

*Neon to light up your garage, den,
workshop or anywhere you can find a
place for these large clocks. Limited 1
year warranty.*



NEON48S-BLU
"GENUINE FORD PARTS SERVICE",
48" x 24" tall, 8" deep. (-15) . \$600.00 EA



NEON34GS-RED
"MOBIL GAS", 34" x 24" tall, 8" deep.
(-15)\$600.00 EA



CLOCKN02
Super Chevrolet Service, blue trim,
large neon wall clock. (0-15) \$249.00 EA



NEON48S-GRN
"LAST CHANCE GARAGE SERVICE",
48" x 24" tall, 8" deep. (-15) . \$600.00 EA

Providing part numbers speeds up your order, improves accuracy and helps us maintain low prices.

See Illustration Index for core charge information and a list of abbreviations. For Body Model information, see Section 5T.



Section 10T: Gift Items, Collectibles, Truck Covers & Vehicle Maintenance

Format = Part No., Year, Description, Original Chevrolet Parts Book Group No., Price and Unit of Measure.



CLOCKN01
Genuine Chevrolet, yellow trim, large neon wall clock. (0-15)\$249.00 EA



CLOCKN04
Polly Gas, yellow trim, large neon wall clock. (0-15)\$249.00 EA



CLOCKN12
Gilmore Gas. White neon, cream face and red trim. (0-15)\$249.00 EA



CLOCKN05
Genuine Chevrolet, blue trim, large neon wall clock. (0-15)\$249.00 EA



CLOCKN10
Sinclair DINO Gasoline Gas. Green neon, white face and green trim. (0-15)\$249.00 EA



CLOCKN13
Mobil gas. White face, white neon and dark blue trim. (0-15)\$249.00 EA



CLOCKN03
OK, red trim, large neon wall clock. (0-15)\$249.00 EA



CLOCKN11
Signal Gas. White neon, black face and red trim. (0-15)\$249.00 EA



CLOCKN15
56-57 Corvette. Black face w/ red neon. (0-15)\$249.00 EA

Returns require a return authorization number, Please call.

Section 10T: Gift Items, Collectibles, Truck Covers & Vehicle Maintenance

Format = Part No., Year, Description, Original Chevrolet Parts Book Group No., Price and Unit of Measure.



Clock



WB623
100th Anniversary,
13" diameter clock
with sounds. Dial
features twelve of the
legendary vehicles that made GM the
automotive icon it is today. Hear one
of twelve authentic recordings of these
vehicles at the top of each hour. Great
collector's item for auto enthusiasts.
Light deactivates the engine sounds
when the room is dark. (-15) .. \$35.00 EA



RS131
Genuine Chevrolet
Parts. 14" diameter,
plastic face with
aluminum bezel. 1
AA battery required
(not included).

(-15) \$39.00 EA



RS130
Chevrolet Super
Service. 14" diameter,
plastic face with
aluminum bezel. 1
AA battery required
(not included).

(-0) \$39.00 EA



GC693
Chevrolet Super
Service. Full size
12" face is easy to
read from across
the shop. Weather
resistant polystyrene.

Requires 1 AA battery (not included).
(-15) \$28.00 EA



GC192
Genuine Chevrolet
Parts. Full size
12" face is easy to
read from across
the shop. Weather
resistant polystyrene.

Requires 1 AA battery (not included).
(-15) \$28.00 EA

*Comes These clocks come with limited
3 year warranties. Chevrolet gift box
included. Officially licensed GM
products.*



CLOCK07
Tire neon wall clock. 14" Diameter with
quartz movement. Rubber tire outer
housing, wrench hour hand, screwdriver
minute hand. Blue neon tube (6 month
warranty on tube) with rotor & caliper
behind wheel. Electric neon, battery
operated clock. (0-15) \$52.00 EA

Thermometer -Wall Mount



GC692
Chevrolet Super
Service. This 12"
thermometer features
full face with large
numbers for easy
readability. Weather
resistant polystyrene. Requires 1 AA
battery (not included). (-15).... \$28.00 EA



GC191
Genuine Chevrolet
Parts. 12" thermometer
features full face with
large numbers for easy
readability. Weather
resistant polystyrene.

Requires 1 AA battery (not included).
(-0) \$28.00 EA

Tin Sign



RS667
Super Chevrolet
Service. 16-1/2" x 12-
1/2". (-15)..... \$14.00 EA



SS407
51 Chevrolet Truck.
16" x 10-3/4".
(-15)..... \$14.00 EA



SS642
Super Chevrolet
Service. 12" diameter .
(-15)..... \$14.00 EA



SS655
Genuine Chevrolet
Parts. 11-
3/4" diameter .
(-15)..... \$14.00 EA

Wall Sign



CHEVYGAR
Polished stainless steel, laser cut
"Chevy Garage" wall sign. 32" x 13" tall.
Great for any garage, office or game
room. (-15) \$50.00 EA



HAGWSCRG
Clear coated, laser cut "Chevy
Garage" wall sign. 32" x 13" tall. Great
for any garage, office or game room.
(-15) \$50.00 EA

Duster



DUSTER
Cotton duster w/ handle and
carrying case. Red, standard size.
(8.8-15) \$10.25 EA



DUSTER MINI
Cotton duster w/ handle. Red head,
black handle in a compact size (12"
overall length). (8.88-15) \$6.25 EA

Providing part numbers speeds up your order, improves accuracy and helps us maintain low prices.

See Illustration Index for core charge information and a list of abbreviations. For Body Model information, see Section 5T.



Section 10T: Gift Items, Collectibles, Truck Covers & Vehicle Maintenance

Format = Part No., Year, Description, Original Chevrolet Parts Book Group No., Price and Unit of Measure.

Car Wash

Adam's specially-formulated Car Wash Soap is pH-balanced and won't strip the protective coating off your finish. This soap suds like crazy and is biodegradable.



ADPG001
1 gallon.
(8.8-15)..... \$30.00 EA



ADPD001
12 oz. Bottle.
(8.8-15)..... \$11.00 EA

Detail Spray

We use this stuff and it works. Use as a waterless car wash, a clay bar lubricant or to enhance the depth and clarity of paint, chrome, plastic, aluminum, and glass. Specially formulated lubricants gently remove dirt, smudges and grime, leaving surfaces with a smooth, ultra-high gloss finish. Use in the sun or shade, and in hot or cool temperatures.



ADPG002
1 gallon.
(8.8-15) . . . \$40.00 EA



ADPD002
16 oz. Bottle.
(8.8-15) \$13.00 EA

Machine Super Wax

Machine Super Wax sets a new standard for machine applied car wax treatments with more shine, more protection and quick & easy application.



ADPD018
16oz. (0-15) . \$25.00 EA

Spray Glaze

This liquid glaze adds depth and clarity to chrome, glass and paintwork. Extreme ease of use and creates ultra-high gloss results. Product can be used in direct sun and has no dust. Shake well before and during use. Product separates by design. Not for use on oxidized finishes.



ADPD007
16 oz. Bottle.
(8.8-15) . . . \$20.00 EA

Clay Bar



ADPA001
Removes surface contamination safely and easily without skid or swirl marks. The large 4-oz bar is suitable for 8-10 vehicles. (8.8-15) \$27.00 EA

Revive Polish



ADPD004
Removes moderate oxidation, swirl marks, and fading. Easy to remove. Will not stain rubber or plastic. 12 ounces.
(8.8-15) \$20.00 EA

Buttery Wax

Formulated with a special blend of polymers, resins and natural Carnauba. Contains no cleaners or abrasives and will not stain plastic or rubber. Always treat an imperfect finish with Adam's Clay Bar and Revive Polish before applying Buttery Wax. Our 12-oz bottle will cover many vehicles, especially when used sparingly as recommended. Use in sun or shade, hot or cool temps.



ADPD006
12 oz. Bottle.
(8.8-15)..... \$20.00 EA

Fine Machine Polish

Polish your car's clearcoat to a jewel-like finish. Designed for application by dual-action car polishers. After just one or two uses, your clearcoat will have perfect clarity so you can enjoy all of the rich color below. Use it several times a year to maintain perfect gloss, without thinning your clearcoat.

To protect your finely polished finish, follow up with Machine SuperWax or Buttery Wax. Both products will add additional gloss, depth and rich color.



ADPD017
16 oz. (0-15). \$25.00 EA

Swirl & Haze Remover

Not a rubbing compound and is less abrasive than toothpaste. Gently removes scratches from clearcoats and painted surfaces. For use by hand or machine. For best results, combine with Revive Polish.



ADPD005
16 oz. (0-15). \$25.00 EA

Returns require a return authorization number, Please call.



Format = Part No., Year, Description, Original Chevrolet Parts Book Group No., Price and Unit of Measure.

10T

Undercarriage Spray

Don't let ugly, soiled wheel wells ruin your beautiful detail job! Make them disappear!

Here's the secret. While you're washing your wheels, spray Adams All Purpose Cleaner in your fender wells and give them a good scrubbing with a fender brush. Let the cleaner dwell while you clean the tire and wheel, then give everything a thorough rinsing. If your wheel wells are really nasty looking, scrub them twice. After washing, allow to air dry, blow dry or towel dry.

Once dry, spray a light coating of Adam's Invisible Undercarriage Spray to all areas of the fender well, then work the product in with an old towel. When you're finished, your black fender well liners will have a perfect satin black finish. They literally become invisible and no longer stand out where they can rob your car of its detailed beauty. Works great for engine bays too!!



ADPD014
16oz. (0-15) . \$13.00 EA

Glass Cleaner



ADPD012
16oz. spray bottle.
(8.8-15) \$10.00 EA

Rubber Dressing

Enhance and protect the appearance of plastic, rubber, tires, moldings, dashboards and door panels. Adam's V.R.T. contains no harmful silicone or alcohol. The thick moisturizing cream applies easily with a sponge and will not leave a greasy film, attract dirt, or harm paint or glass. Added U.V. protection keeps vehicle interiors and exteriors looking and feeling like new.



ADPG003
1 gallon.
(8.8-0) \$60.00 EA



ADPD003
12 oz. Bottle.
(8.8-15) \$25.00 EA

Detail Sponge



ADPA003
Large washable sponge. Use to apply a thin, even coat of Adam's Vinyl, Rubber, & Tire (V.R.T.) without the mess.
(8.8-15) \$6.75 SET

All Purpose Cleaner



ADPD025
16oz. spray. Heavy duty w/ lemon scent. Use to remove brake dust, clean engines, cleaning buffing and applicator pads. Dilute by 50% for use on delicate surfaces like polished wheels.
(8.8-15) \$10.00 EA

Applicator



ADPM001
Large washable sponge. Use to apply a thin, even coat of VRT without the mess.
(8.8-15)..... \$8.00 SET

Leather Conditioner



ADPD008
Nourish and condition leather upholstery with this thick, non-greasy cream. Contains U.V. blocking agents and will never dry your leather. Suitable for auto and home upholstery. 16 oz. bottle.
(8.8-15) \$20.00 EA

Carpet & Upholstery Cleaner



ADPD011
Non-toxic, non-allergenic cleaner. Contains no soap and will not create suds, yet it magically removes spots and dirt from your floor mats and other carpeted areas and fabric upholstery.
(8.8-15) \$9.00 EA

Drying Towel

Adam's new ultra-soft Waffle STARFIBER Jumbo Microfiber Drying Towel is the bath sheet of detailing towels. It measures a whopping 25" x 36" and is twice as thick and more durable than their last towel, yet every bit as absorbent. And the waffle never streaks or scratches. Save over 30% when you buy two.



ADPM008
1 towel.
(8.8-15) \$20.00 EA

Providing part numbers speeds up your order, improves accuracy and helps us maintain low prices.

See Illustration Index for core charge information and a list of abbreviations. For Body Model information, see Section 5T.



Section 10T: Gift Items, Collectibles, Truck Covers & Vehicle Maintenance

Format = Part No., Year, Description, Original Chevrolet Parts Book Group No., Price and Unit of Measure.

Metal Polish



ADPD009
Bring back luster and shine on heavily oxidized parts without scratching. This pure liquid magic works wonders on stainless,

brass, billet, chrome, and nickel. Follow with Polish #2 for additional shine and maintenance (for use on non-clear coated parts). (8.8-15) \$25.00 EA

Polishing Ball



POWERBALL
Use with your favorite polishing compound/ liquid on a drill/ screw gun to revitalize metal, plastic and more. 6" dia. (8.8-15) ... \$32.75 EA



POWERBALLM
Mini ball with 10" extension for hard to reach areas. 3-1/4" dia. (8.8-15) ... \$31.75 EA

Detail Sponge



ADPTSPONGE
Large washable sponge. Use to apply a thin, even coat of Adam's Vinyl, Rubber, & Tire (V.R.T.) without the mess.

(8.8-0) \$1.25 SET

Polishing Towel

Adam's Microfiber Polishing Towel is the softest, safest and most effective polishing towel on the market. Measuring 16" x 24", the thick yellow towel is ideal for removing polish and Adam's Detail Spray. We use two polishing towels for a standard detail.

ADPM002
Single Towel. (8.8-15) \$13.00 EA

Truck Cover

Recommended for inside use only.



- 306800A**
Polycotton, 1/2T short bed.
(16.55-15) \$190.00 EA
- 306803F**
Flannel, 1/2T short bed.
(16.55-15) \$225.00 EA
- 306800T**
Polycotton, long bed. (16.55-15) \$205.00 EA
- 306804F**
Flannel, long bed. (16.55-15) \$240.00 EA

Truck Cover - Accessories



306800B
Storage bag.
(16.55-15) \$10.00 EA



306800L
Lock set. (16.55-20) \$15.00 EA

Returns require a return authorization number, Please call.

Section 12T: Tools, Adhesives, Brake Fluid, Gas Tank Prep & Sealer, Carburetor & Brake Cleaners and Polishers
 Format = Part No., Year, Description, Original Chevrolet Parts Book Group No., Price and Unit of Measure.



12T

Auto Dolly



3 sizes
 8"x16"
 12"x16"
 16"x16"

M9980
 One person to move your vehicle. Choose heavy duty (10,000lbs. total) or standard (6,000lbs. total). 3 different sizes. 8" x 16", 12" x 16" or 16" x 16". (-0) \$149.00 SET

Lubricator & Bolt Loosener



PBBLASTER
 Powerful rust inhibitor, bolt loosener/ penetrant. (-15).....\$6.00 EA

Tire Care



WHITEWIPE
 White wall tire wipes. 7" x 9" wipe. 35 per container. (-15) \$6.00 EA

Oil Additive



Don't let good parts go bad!

ZDDPLUS
 There is nothing trick about this additive. It simply replaces the ZDDP (Zinc Dialkyl-Dithio-Phosphate) that is necessary on non-roller lifter engines and was taken out of the oil because of the extended 120,000 mile warranty on catalytic converters. (8.8-15) ..\$10.00 EA

Clutch Head Driver W/ Bits



DRIVER All
 Magnetic driver w/ 5 bits (1/8in., 5/32in., 3/16in., 1/4in., 5/16in.) with Chev's imprint. (8.821-15)\$22.25 SET

Clutch Head Bits

3685598 All
 1/8in. (1/4in. drive) (8.821-30)... \$4.50 EA
 3685592 All
 5/32in. (1/4in. drive) (8.821-40). \$4.75 EA
 3685594 All
 3/16in. (1/4in. drive) (8.821-40). \$4.75 EA
 3685593 All
 1/4in. (1/4in. drive) (8.821-40)... \$4.75 EA
 3685595 All
 5/16in. (1/4in. drive) (8.821-20). \$7.25 EA

Clutch Bit Holder

3685596 All
 For your 1/4in. drive ratchet. Holds clutch head bits. (8.821-20)..... \$7.00 EA

Tool Bag



986362 All
 Tool bag. Superb reproduction w/ pictures of tools which may be found at swap meets. 13-5/8" x 6". (8.821-15) \$18.00 EA

Tools-Engine, Drivetrain



38352226 37-53
 Used to align oil dipper troughs in pan (\$400 refundable deposit upon return of tool) (1.427-40)\$450.00 Rent



838956A All
 To align clutch disc. (0.866-40) ..\$6.50 EA



595005A 37-54
 Drive shaft bushing puller to rent (return in original condition for \$20 refund). (5.451-15) \$68.25 EA

Tools-Body



010351 All
 Removes mouldings (Amazing!) (8.821-15) \$35.75 EA



01832 All
 To install windshield & back window rubber (exc 41-48 w/ mouldings) (8.821-30)\$6.25 EA



3847415T 42-54
 Inserts back glass rubber lock strip. (16.469-15) \$24.75 EA

Tools-Interior

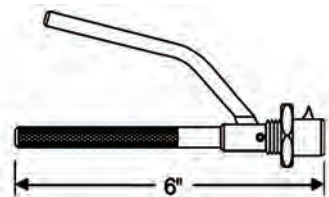

4088134A All
 Installs door handle ferrules. Return tool in same condition as sent for a \$20 refund (Does not work with Ferrule part #4125630). (10.537-15) \$40.25 EA

Providing part numbers speeds up your order, improves accuracy and helps us maintain low prices.

See Illustration Index for core charge information and a list of abbreviations. For Body Model information, see Section 5T.



Section 12T: Tools, Adhesives, Brake Fluid, Gas Tank Prep & Sealer, Carburetor & Brake Cleaners and Polishers
 Format = Part No., Year, Description, Original Chevrolet Parts Book Group No., Price and Unit of Measure.

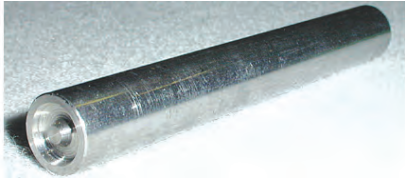

4173376A..... 49-65
 Sets vent window pivot pin.
 (10.669-15)\$5.00 EA

Stainless Steel Tubing



SSTUBING
 304 seamless tubing in
 1/2", 5/8" & 3/4" O.D.
 Can be cut to length.
 Total lengths up to
 20 ft sticks (oversize
 shipping on long

lengths). (-0)\$2.75 FT

Battery Tender Plus

1.25 amp, Charges a battery and maintains it. Automatically switches from full charge to floating charge mode. Reverse Polarity Protection.

Battery Tender Plus -Battery Charger



BT06V
 6 Volt Charger. (2.332-15) \$62.50 EA

BT12V
 12 Volt Charger. (2.332-15) \$62.50 EA

Battery Minder

1.0 max amp. Charger/ maintainer/ conditioner charges without overcharging. No sulphate build-up.

Battery Minder Plus -Battery Charger



BM12V
 12 Volt Charger. (2.332-15) \$50.00 EA

BM06V
 6 Volt Charger. (2.332-15) \$50.00 EA

Smartcharge -Battery Charger



SMARTCHG
 Maintain and charge your battery with the SmartCharge™ digital battery charger! This handy unit keeps your battery in the ideal state and lengthens its life span using AccuCharge™ technology.
 -Ideal for Hot Rods
 -Maintains & Extends Your Battery Life
 -AccuCharge™ Technology
 -Steady Trickle Charge (-15) .. \$18.00 EA

Fender Cover



989936B
 Chevrolet text w/ Bowtie.
 (19.98-15) \$29.75 EA



989936H
 with Heartbeat of America script.
 (19.98-15) \$32.00 EA

Oil Pad



OILPAD1
 Place under vehicle to absorb oil, water, etc. Holds over 1 gallon. (3 ft x 5 ft).
 (8.821-15) \$22.50 EA

OILPAD
 Place under vehicle to absorb oil, water, etc. Holds approx 1 gallon (3 ft x 3 ft).
 (8.821-15) \$16.50 EA

Gas Tank Restoration Kit



PORTANK
 Restore and maintain gummed up tanks. Cleaner, metal prep, sealer, fuel preservative/ stabilizer and complete instructions. (3.001-0) \$68.25 EA

Returns require a return authorization number, Please call.



Gas Tank Cleaner

Works fast & makes petroleum-based cleaners nearly obsolete. Can be diluted with water up to 10 times its volume while remaining potent. Removes grease, oil, mildew, algae, musty odors, soap films & wax. Use it to clean canvas, vinyl, nylon, holding tanks, grease traps, auto parts and more.



PORCLEAN
 1 quart. (3.001-15) \$11.00 EA

Metal Prep

Provides adhesion for POR-15 paint (Sect. 15) on aluminum and shiny polished metal surfaces. Etches metal and leaves a zinc phosphate coating. Non-caustic, non-corrosive, non-toxic & non-flammable.



PORMETAL
 Water based, OSHA approved biodegradable solution. 1 quart. (3.001-15)..... \$16.50 EA

Gas Tank Sealer Slush



3657942B
 Seals gas tank. Recommended for new tanks. Impervious to all fuels. (3.001-0) \$34.50 QT



3657942C
 Seals gas tank. Alcohol resistant. Recommended for new tanks. (3.001-15) \$30.00 QT

Fuel Stabilizer

Keep fuel fresh. Removes water, cleans carburetors & fuel injectors. Protects engine from gum, varnish, rust, and corrosion. Eliminates need to drain fuel before storage. Special dispenser bottles measure exactly without waste. Contains NO alcohol.



111801B
 POR-15 stabilizer. Treats up to 48 gals (3 ozs. per gal). 1 pint. Treats for a minimum 2 years. (3.001-15) \$12.25 EA



111801
 STA-BIL stabilizer. 8 oz bottle treats 20 gallons. Treats up to 1 year. (3.001-15) \$7.50 EA

303 Aerospace Protectant

Keeps UV-sensitive materials "like new" year after year. Gives 100% prevention of UV caused slow-fade with regular use. No other protectant beautifies as intensely, protects as powerfully or lasts as long.



O30370
 1 gallon refill. (8.8-0) \$73.00 EA
 O30340
 16 oz. spray bottle. (8.8-0) \$16.00 EA

Rust Remover



1001PL
 Works great, is biodegradable and non-caustic. Sold as a concentrate that makes 3 gallons. (8.8-15) \$30.00 EA

Anti-Corrosion Compound



CBL12
 Kills corrosion on contact. Safe on electronics, battery terminals, wiring harnesses. 12 oz. spray.

(8.776-15)..... \$20.00 EA

Cleaner-Carburetor



6505259
 16 oz spray can. (3.725-0) \$5.00 EA

Cleaner-Brake



6129423
 Superior cleaner. Many uses (spray can). (4.683-15)..... \$3.25 EA

Brake Fluid



5450285B
 DOT 4 (12 oz). (4.683-15) \$3.25 EA



603486B
 DOT 5, silicone. Less corrosion. 12 ounce bottle. (4.683-15) \$18.00 EA



Section 12T: Tools, Adhesives, Brake Fluid, Gas Tank Prep & Sealer, Carburetor & Brake Cleaners and Polishers
 Format = Part No., Year, Description, Original Chevrolet Parts Book Group No., Price and Unit of Measure.

Gasket Sealer



1015BP
 High temp silicone.
 Black (3.35 oz tube).
 (8.8-15)..... \$6.25 EA



GL16
 Rubber repair kit.
 Repairs chipped
 running board rubber &
 other rubber materials.
 2-part epoxy, 16 oz.
 (10-15)..... \$36.00 EA

*NOTE: Hazardous materials such as
 paints & cleaners cannot be shipped by
 air carrier. Ground shipping only (no
 international, Alaska or Hawaii).*

Adhesives & Sealers



986199A
 3M Contact cement
 for rubber to metal.
 Bonds instantly.
 Industrial quality for
 gravel guards, running
 board rubber, etc.
 (8.8-15)..... \$40.00 QT



306105
 Krazy Glue. Rubber
 to metal & rubber to
 rubber bonding. Splice window gaskets
 & sponge weather strip & more.
 (8.8-15)..... \$3.00 EA



01608
 3M plastic & emblem
 adhesive (5 oz. tube).
 (8.8-15)..... \$11.50 EA

Weatherstrip Cement



511114
 Black weatherstrip
 cement, 5-oz tube.
 Superior product!. (8.8-0)..... \$12.75 EA

Adhesives & Sealers



511113
 Spray adhesive for
 bowdrill cloth. Best
 product available
 for all interior trim.
 (18 oz. spray can).
 (8.8-20) \$15.00 EA



GL14
 Windshield sealer.
 Seals leaks
 in new & old
 installation. Will not dry out.
 (Adhesives & Sealers-15)..... \$7.00 EA



1940 1-1/2 Ton—Darren Saari, Duluth, Minnesota

Returns require a return authorization number, Please call.

Section 15T: Sound Deadener, Thermal Protection & Paints

Format = Part No., Year, Description, Original Chevrolet Parts Book Group No., Price and Unit of Measure.



15T

Sound Deadener-Thermal Protection



VB-15PRO
Advanced compound well suited for exterior automotive panels such as inside fender wells, wheel arches and underside of the floor pan. Converts structural resonance and vibration into low level heat through friction. When cured, it remains soft which allows it to absorb the impact of road debris. (NOTE: Should

only be applied to exterior surfaces due to prolonged outgassing). 18 Oz. Aerosol can. Covers 4 sq. ft. (8.8-15)\$14.50 EA



DEADENER
The ultimate in noise reduction. Engineered specifically for the interior & exterior side of body panels. 200% decrease in noise & vibration than any .070in. asphalt material. Bonds to metal, fiberglass & wood. Easy to apply (spray gun, roller or brush), non-toxic & water based for easy clean up. Covers 30 sq. ft. (8.8-15)\$82.50 GALLON

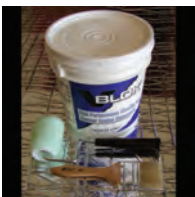

HEATSHIELD
Awesome heat reduction in a can! Lightweight, pliable and bonds to virtually any material! Made up of air filled glass beads held in suspension by a high temp latex acrylic binder. Two 15 mil applications yield a thermal value of R-24. Insulate & prevent corrosion with one product. Easy to apply, non-toxic. (8.8-15).....\$95.00 GALLON



SPRAYGUN
Spray gun. Siphon-feed spray gun for DEADENER & HEATSHIELD. (8.8-15).....\$84.75 EA

Paint-Zero Rust



511112C
Satin black w/ rust inhibitors. Use on core supports, inner fender panels, etc (12 oz spray). Match to GM satin black. (8.8-15)\$18.00 EA

POR-15 Rust Preventive Paint



POR-15QT
1 quart. Rust-preventative coating applied directly over rusted or seasoned metal surfaces. Dries as rock hard, non-porous finish that won't chip, crack or peel. Prevents rust from reoccurring. Choose Black, Semi-Gloss Black, Grey, Silver or Clear. (8.8-0)\$45.00 QT



POR-15QTSLV
Thinner. 1 quart. Use for easy cleanup or thinning of POR-15 paint. (8.8-15)\$11.00 QT

Paint-Engine



986959S 29-52
Grey hi-temp (16 oz spray can). Color has been tested and is correct. (8.8-15)\$20.00 EA



986970S 53-62
Blue (12-3/4 oz spray can). (8.8-15)\$22.50 EA

986959A 29-52
Grey. Reduce using Xylene (max of 15%). (8.8-40)\$40.00 QT
986970A 53-62
Blue (8.8-15).....\$50.00 QT
986970G 37-46
Engine (olive) GMC (8.8-15)....\$50.00 QT
986970M 47-59
Engine (red orange) GMC (8.8-15).....\$55.50 QT

VHT Hi-Temp Engine Enamel



986959R
Universal red (12 oz. spray can). (8.8-15)\$9.00 EA

986959O
Chevy orange (12 oz. spray can). (8.8-15)\$9.00 EA
986959FB
Flat black (12 oz. spray can). (8.8-15)\$9.00 EA
986959B
Gloss black (12 oz. spray can). (8.8-15)\$9.00 EA
986959SB
GM satin black (12 oz. spray can). (8.8-15)\$9.00 EA
986959UA
Universal aluminum (12 oz. spray can). (8.8-15)\$9.00 EA

Providing part numbers speeds up your order, improves accuracy and helps us maintain low prices.

See Illustration Index for core charge information and a list of abbreviations. For Body Model information, see Section 5T.



Section 15T: Sound Deadener, Thermal Protection & Paints

Format = Part No., Year, Description, Original Chevrolet Parts Book Group No., Price and Unit of Measure.

Paint-Carburetor



12910 All Carburetor renew, bronze (5 oz. spray can) (8.8-15) ... \$16.50 EA



12911 All Carburetor renew, silver (5 oz. spray can) (8.8-15) ... \$16.50 EA

Paint-cab Interior

985734P 37-39 Brown crinkle-for cab interior (lacquer) (16.08-15)..... \$40.00 QT

604481P 40-46 Beige hammertone-for cab interior (thin w/ enamel thinner) (16.08-15).. \$49.75 QT

3693291P 47-53 Semi flat brown, slight metallic for cab interior. Acrylic enamel (thin w/ enamel thinner). (16.08-15) \$40.00 QT

3700359P 47-54 Pulsar grey, for cab interior, 47-54 Panel & Suburban 54 deluxe cab, interior lacquer (16.08-15)..... \$69.00 QT

985734S 54 Pearl beige for interior of cab. (16.08-15)..... \$50.00 QT

Paint-Battery Tray



12998 All Corrosion resistant, black (12 oz spay) (8.8-15) \$20.00 EA

Paint-Heater

604481P 42-46 Beige hammertone (thin w/ enamel thinner). (16.08-15) \$57.50 QT

604481H 47-54 Silver hammertone (thin w/ enamel thinner) (16.08-15)..... \$34.50 QT

Paint-Radio & Heater

985734P All Brown crinkle (lacquer) (16.08-15)..... \$45.00 QT

Paint-Exhaust



3657963C Stainless steel pigments. For exhaust manifolds & pipes. Gives a soft grey, metallic finish. (3.609-15) ... \$30.00 PT



3657963FA Very high temp, flat aluminum for manifolds & pipes. 12 oz spray can. (3.609-15)..... \$12.50 EA



3657963E Clear, high temp (1200 degree) for exhaust etc, 12 oz spray can. (3.609-15) \$12.50 EA

Paint-Cast Blast



3657963D Cast blast high temp 1200 degree. Grey, fresh cast look for exhaust manifolds, etc. Rust preventative, 12 oz spray can. (3.609-15)..... \$9.50 EA



3657963F Grey cast blast, For non high heat applications. Gives fresh cast look. Rust preventative, 12 oz spray can. (3.609-20)..... \$8.75 EA

Paint-Inner Fender Panel



511112D Flat black spray paint for use on core supports and inner fender panels. (8.8-15)..... \$6.25 EA

511112 All Satin black-also great for ore support, tires & rubber mats (quart) (8.8-15)..... \$29.00 QT

Paint-hub Caps & Trim



306567 All Red, for hub caps & trim (special lettering enamel) 1/2 pint (8.8-20) \$25.50 EA

306553 All Blue, for hub caps & trim (special lettering enamel). 1/2 pint. (8.8-15) \$13.00 EA

306505 All Black, for hub caps & trim (special lettering enamel) 1/2 pint (8.8-15) \$13.00 EA

NOTE: Hazardous materials such as paints & cleaners cannot be shipped by air carrier. Ground shipping only (no international, Alaska or Hawaii).

Returns require a return authorization number, Please call.



Engine Cylinder Head and Manifolds

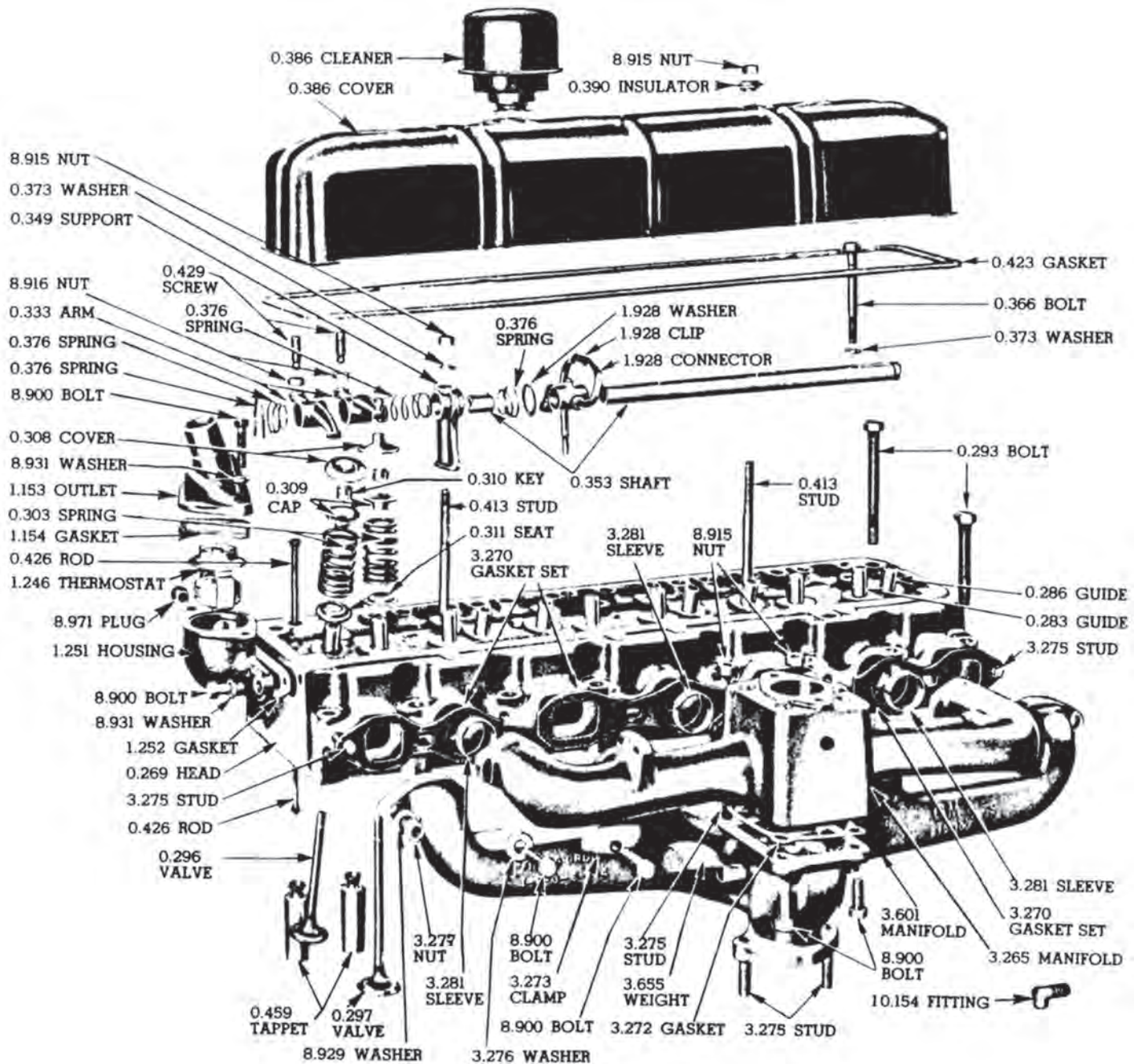

Providing part numbers speeds up your order, improves accuracy and helps us maintain low prices.

See Illustration Index for core charge information and a list of abbreviations. For Body Model information, see Section 5T.



Section 20T: Crate Engines & Engine Kits

Format = Part No., Year, Description, Original Chevrolet Parts Book Group No., Price and Unit of Measure.

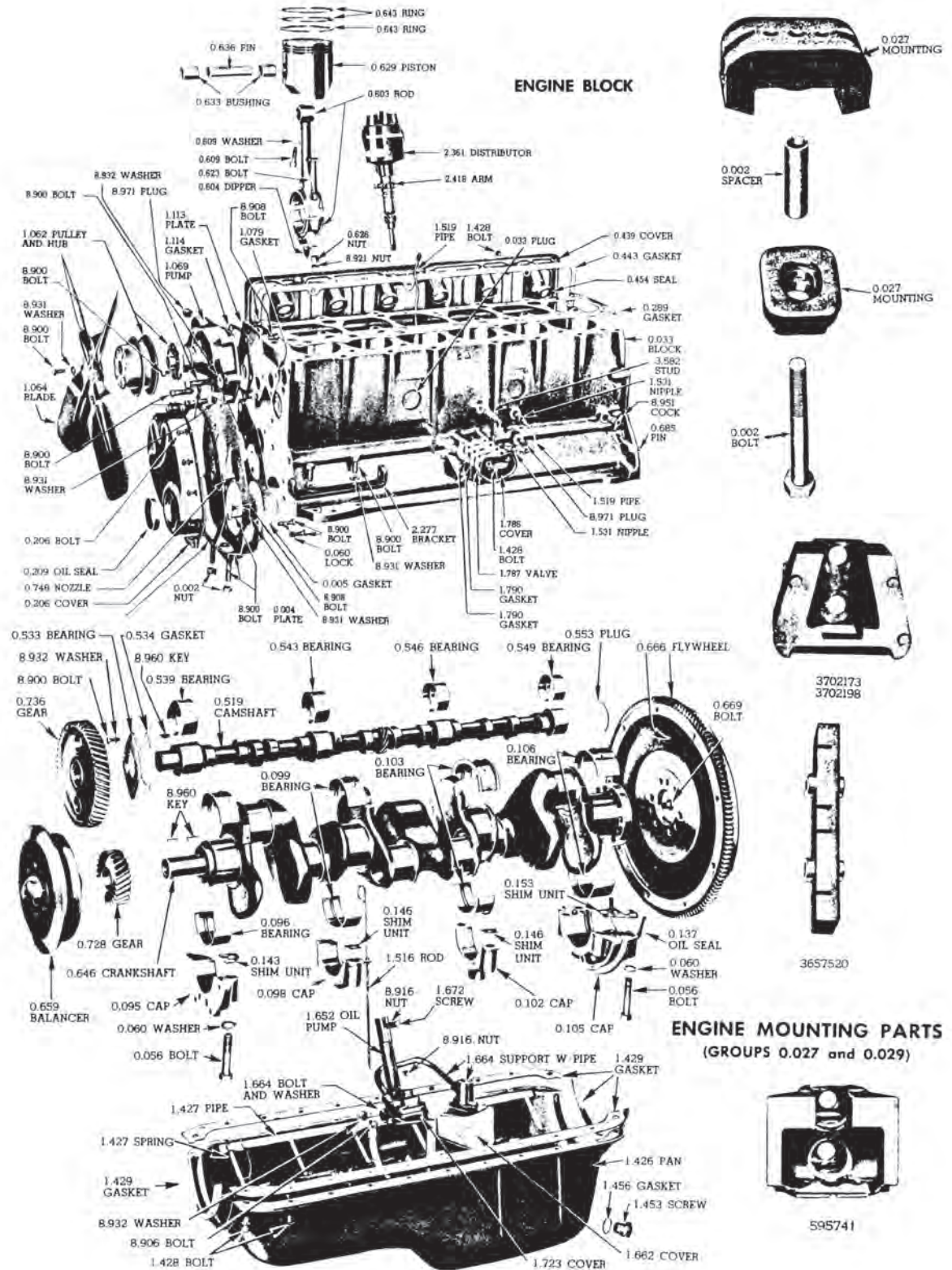

Returns require a return authorization number, Please call.

Section 20T: Crate Engines & Engine Kits

Format = Part No., Year, Description, Original Chevrolet Parts Book Group No., Price and Unit of Measure.



20T

Engine ID Chart		
Model Year	216 CU Inch Numbers	Block Casting Numbers
1937	1 to 1187821	838101838710
1938	1187822 to 1915446 B1 to B10502	838710
1939	1915447 to 2697267 B10503 to B105461	838941
1940	2697268 to 3665902 B105462 to B221935	839400
1941	AA 1001 to AA	1163720
	AC 1001 to AC 19549	839400
1942	2AA, 2AC, BA	839770
1946	DA	839770
1947	EA	839770
1948	FA	3835253
1949	GA	3835253
1950	AHCA, AHCM, BHCA, BHCM, HAA, HAM, HAC, HAP, HBA, HBM, HCA, HCM, HCD, HCQ	3835497
1951	AJCA, AJCM, BJCA, BJCM, JAA, JAM, JAC, JAP, JBA, JBM, JCA, JCM, JCD, JCQ	3835497
1952	AKCA, AKCM, BKCA, CKCM, KAA, KAM, KAC, KAP, KBA, KBM, KCA, KCM, KCD, KCQ	3835849
1953	ALCC, ALCP, BLCC, BLOP, LAG, LAT, LAJ, LAV, LBA, LBM, LAM, LCA, LCM, LCC, LCP, LCD, LCH, LCU3835849	

Model Year	235 CU Inch Prefixes	Block Casting Numbers
1941	AG, AL	3660439
1942	BG, BL	839751
1946	BG, BL—1 st design	839751
1946	DDA, DDM, DEA, DEM—2 nd design	839751
1947	EDA, EDM, EEA, EEM	3835335
1948	FDA, FDM, FEA, FEM	3835309
1949	GDA, GDM, GEA, GEM	3835309
1950	HDA, HDM, HEA, HEM	3692703
1951	JDA, JDM, JEA, JEM	3692703
1952	KDA, KDM, KEA, KEM	3835692
1953	LDA, LDM, LEA, LEM, LAA	37019463701483
1954	T54 or F54 followed by: L, LA, M, MA, MB, N, P, Q, R, S, T, TA, U, UA, UB, X, XZ, XB, Y, YE, YG, Z, ZC, ZE, ZH	3701481
1954	Except 53 ST	3701481
1954	First series	3733949
1955	Through 4/1/56	3836233

Model Year	261 CU Inch Engine Block	Block Casting Numbers
1954-55	First series	37024363703414
1956	All	3836340
1957	All	3836340
1955-57	All	3836340
1958	All	3836340
1959	All	3759365
1960-62	All	3769923

Note: The 235 cu. in. engine can be distinguished from the 216 engine by the engine serial number prefix as follows:

- 1941 AG or AL
- 1942 BG or BL
- 1946 BG or BL (First Design)
- 1946 DDA, DDM, DEA, or DEM (Second Design)
- 1947 EDA, EDM, EEA, or EEM
- 1948 FDA, FDM, FEA, or FEM
- 1949 GDA, GDM, GEA, or GEM
- 1950 HDA, HDM, HEA, or HEM
- 1951 JDA, JDM, JEA, or JEM
- 1952 KDA, KDM, KEA, or KEM
- 1953 LDA, LDM, LEA, or LEM



Section 20T: Crate Engines & Engine Kits

Format = Part No., Year, Description, Original Chevrolet Parts Book Group No., Price and Unit of Measure.

Engine Kit

When ordering: SPECIFY exact year and size of engine (216ci, 235ci or 261ci), HYDRAULIC or solid lifters, standard or exact oversize of rod, main bearings, pistons and rings. Also SPECIFY stick shift or powerglide.

Call for availability of pistons & bearings before boring block or having crank turned.

MEK1 Engine Kit

*MEK1 contains all parts necessary to overhaul a complete short block assembly. Including: Rods machined for insert bearings (new rods on 1937-47 kits), rod bearings, main bearings, pistons with pins, piston rings, new camshaft, lifters, cam bearings, timing gears, full gasket set, soft plugs, plastigauge, oil pump, bolt boots & block sealant lube (1937-39 includes pushrods). *Assembly lube no longer included.*

MEK139	37-39	Includes pushrods (0.001-20)	\$1,200.00 KIT
MEK140	40	(0.001-15)	\$1,150.00 KIT
MEK147	41-47	(0.001-15)	\$1,010.00 KIT
MEK153	48-53	Except Powerglide (0.001-20)	\$1,010.00 KIT
MEK152	50-52	For Powerglide (0.001-15)	\$1,050.00 KIT
MEK162	53-62	Except 53 stick (0.001-15)	\$844.75 KIT

MEK2 Engine Kit

MEK239	37-39	Includes pushrods (0.001-20)	\$1,170.00 KIT
MEK240	40	(0.001-15)	\$1,120.00 KIT
MEK247	41-47	(0.001-15)	\$1,050.00 KIT
MEK253	48-53	Except Powerglide (0.001-15)	\$980.00 KIT
MEK252	50-52	For Powerglide (0.001-15)	\$963.50 KIT
MEK262	53-62	Except 53 stick (0.001-15)	\$849.00 KIT

EK Engine Kit

EK39	37-39	Includes pushrods (0.001-15)	\$681.50 KIT
EK47	40-47	(0.001-15)	\$650.00 KIT
EK53	48-53	Except Powerglide (0.001-15)	\$671.00 KIT
EK52	50-52	For Powerglide (0.001-0)	\$596.00 KIT
EK62	53-62	Except 53 stick (0.001-15)	\$859.00 KIT
EK58	54-58	For solid lifter (0.001-15)	\$596.00 KIT

RRK Re-ring Kit

RRK39	37-39	(0.001-30)	\$250.00 KIT
RRK53	40-53	Except 53 Powerglide (0.001-30)	\$250.00 KIT
RRK62	53-62	Except 53 stick (0.001-20)	\$180.00 KIT

RRK3 (Re-ring Kit w/ Main Bearings)

RRK339	37-39	(0.001-40)	\$364.75 KIT
RRK347	40-47	(0.001-40)	\$352.75 KIT
RRK353	48-53	Except 53 Powerglide (0.001-40)	\$335.50 KIT
RRK362	53-62	Except 53 stick (0.001-20)	\$275.00 KIT

CLK (Cam & Lifter Kit)

CLK39	37-39	Solid lifter w/ pushrods (0.001-15)	\$240.50 KIT
CLK53	40-53	Solid lifter exc 53 Powerglide (0.001-15)	\$147.50 KIT
CLK52	50-52	Hydraulic lifter for Powerglide (0.001-15)	\$270.25 KIT
CLK62	53-62	Hydraulic lifter exc 53 stick (0.001-15)	\$257.50 KIT
CLK58	54-58	Solid lifter. (0.001-15)	\$225.00 KIT

CLK3 (Cam, Lifter Kit & Timing Gears)

CLK339	37-39	Solid lifter w/ pushrods (0.001-15)	\$268.50 KIT
CLK353	40-53	Solid lifter exc 53 Powerglide (0.001-15)	\$198.50 KIT
CLK352	50-52	Hydraulic lifter Powerglide (0.001-15)	\$318.25 KIT
CLK362	53-62	Hydraulic lifter exc 53 stick (0.001-20)	\$308.50 KIT
CLK358	54-58	Solid lifter. (0.001-15)	\$198.50 KIT

PRK (Piston & Ring Kit)

PRK40	37-40	Domed piston (0.001-40)	\$215.00 KIT
PRK53	41-53	216ci (0.001-15)	\$348.25 KIT
PRK62	41-62	235ci (exc 53 Powerglide) (0.001-15)	\$215.00 KIT
PRK61	54-62	261ci (0.001-15)	\$215.00 KIT

Kits containing the following parts will have core charges of: Reground cams: \$35 ea, Rods: \$35 ea. Until we receive your cores!

Oversize shipping charges apply. Please call for rate.

Returns require a return authorization number, Please call.

Section 22T: Engine Components, Valve Covers, Rods, Bearings, Oil Pumps & Related

Format = Part No., Year, Description, Original Chevrolet Parts Book Group No., Price and Unit of Measure.



22T

Valve & Rocker Cover Set



3836614S 37-62
235ci chromed valve & rocker covers w/ breather cap and gaskets. Excellent finish. (0.386-15)\$88.50 SET

Valve Cover



3686784C 37-53
Chrome 1937-53 Chevy 216 6-cyl Valve Cover - Unbaffled. (-15)\$42.75 EA

Offenhauser Valve Cover



3686784O 37-53
Ribbed for 216ci. Polished aluminum valve cover, includes bolts. (0.386-15)\$194.50 EA



3836614O 37-62
Ribbed for 235ci. Polished aluminum valve cover, includes bolts. (0.386-15)\$211.25 EA

Wayne Valve Cover



3686784W 37-62
"Wayne" Finned aluminum cover. Superb reproduction w/ breather cap and stud kit. (0.386-0)\$150.00 EA

Side Covers-Chevy Six Cylinder



3701541W 50-62
"Wayne" Finned aluminum side cover. Superb reproduction, fits 235ci-261ci. (0.439-0) \$75.00 EA

Plastigauge

609118P All
To check bearing clearance. (0.143-0) \$2.00 EA

Note: Pilot bearing bushing see Section 140T.

Note: Engine electrical see Section 40T, 45T & 50T.

Note: Fuel pump & carburetor see Section 120T.

Main Bearings



384706 37-39
.002 to .030 under. (0.099-40) \$135.00 SET

384206 40-47
Standard size to .075 under. (0.099-0) \$135.00 SET

368847 48-53
.002, .010, .020, .030 exc 53 Powerglide. (0.099-15) \$130.00 SET

368855 48-53
.040, .050, .060 (exc 53 Powerglide). (0.099-15) \$130.00 SET

370394 53-62
Standard to .040 exc 53 stick. (0.099-20) \$133.00 SET

Rod Bearings



370485 37-53
Standard size to .060. (exc '53 Powerglide). (0.616-40) \$131.75 SET

370486 53-62
Except 53 stick (0.616-40) \$49.00 SET

Rod Bearing Shims



3692517 29-53
.009 thick shims for rod bearings (0.619-15) \$32.00 SET

Rod Service

Note: Price subject to bearing availability. Before grinding crank shaft, please contact us to be sure undersize bearings needed are available.



602235A 37-53
Machine your rod for insert bearing (\$35 core) (0.603-15) \$52.00 EA

Rod

Note: SPECIFY exact model engine with rod casting number when possible. \$35 core charge refundable on rebuildable rod.

602235AA 37-53
Rebuilt with new babbitt (\$35 core) (0.603-15) \$75.00 EA

602235N 37-47
Babbitt rods. Standard size only (NOS). (0.603-0) \$45.00 EA

602235M 37-47
Machined for insert bearing (NOS) (0.603-20) \$90.00 EA

Providing part numbers speeds up your order, improves accuracy and helps us maintain low prices.



See Illustration Index for core charge information and a list of abbreviations. For Body Model information, see Section 5T.



Section 22T: Engine Components, Valve Covers, Rods, Bearings, Oil Pumps & Related

Format = Part No., Year, Description, Original Chevrolet Parts Book Group No., Price and Unit of Measure.

Rod Bolt & Nut

-  3835449 33-53
Except 53 Powerglide
(0.623-20) . \$5.50 EA
-  107823 All
Pal lock nuts for rod
bolts (0.626-40)
\$4.75 SET

Rod Dipper



- 3834884 33-53
For connecting rod (0.604-15) . . . \$4.00 EA

Rod Bolt Boots

-  986047B All
Protects crankshaft
during assembly
(8.8-20) \$3.00 PR

Pistons



- 602806 37-40
Specify oversize (6 pcs)
(0.629-40) \$250.00 SET
- 605260 41-53
Fit 216ci (specify oversize) (6 pcs).
(0.629-40) \$186.00 SET
- 369398 41-62
W/ 235ci (specify oversize) (6 pcs).
(0.629-15) \$190.75 SET
- 3707460 54-62
261ci. Specify oversize (6 pcs).
(0.629-0) \$204.00 SET

Rings

- 
- 608021 37-53
Fit 216ci (specify oversize)
(0.643-0) \$60.00 SET
- 370405 41-53
235ci exc 53 Powerglide (specify oversize)
(0.643-15) \$60.00 SET
- 370527 53-54
235ci exc 53 stick (specify oversize)
(0.643-0) \$60.00 SET
- 3720210 54-62
261ci (specify oversize)
(0.643-0) \$61.25 SET

Wrist Pins

-  838570 37-62
Standard (0.636-15) .
\$4.75 EA

Valve Seats

- 
- 3688065A 38-52
Intake exc 50-52 235ci
(0.296-30) \$6.25 EA
- 3835318A 38-52
Exhaust exc 50-52 235ci
(0.297-20) \$6.25 EA
- 3835519A 50-62
Intake 235ci
(0.296-40) \$6.75 EA
- 3683569A 50-52
Exhaust 235ci
(0.297-20) \$6.25 EA
- 3683569B 53-62
Exhaust 235ci
(0.297-20) \$6.25 EA

Valve Guide

- 
- 3688758 38-40
Intake (0.283-15) \$6.25 EA
- 3688759 38-40
Exhaust
(0.283-30) \$6.25 EA
- 3708168 41-62
Intake
(0.283-30) \$6.25 EA
- 3688761 41-62
Exhaust
(0.283-40) \$6.25 EA

Valve

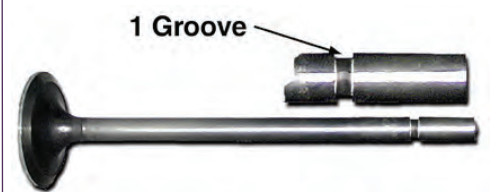
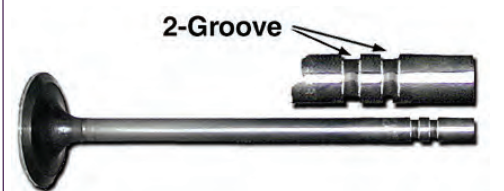
-  **1 Groove**
- 838437 35-40
Intake (0.296-40) \$15.50 EA
- 838717 35-40
Exhaust (1 groove)
(0.297-40) \$15.50 EA
- 839504 41-49
Intake (1 groove)
(0.296-40) \$15.50 EA
- 3835318 41-49
Exhaust (1 groove)
(0.297-15) \$25.00 EA
-  **2-Groove**
- 3688065 41-53
Intake (2 groove) exc 50 & later 235ci.
(0.296-15) \$15.50 EA
- 3835608 41-53
Exhaust exc 50 & later 235ci (2 groove)
(0.297-30) \$15.50 EA
- 3835519 50-52
Intake, 235ci only (1 groove).
(0.296-30) \$15.50 EA
- 3835910 53-62
Intake, 235ci only (2 grooves).
(0.296-15) \$15.50 EA

Returns require a return authorization number, Please call.

Section 22T: Engine Components, Valve Covers, Rods, Bearings, Oil Pumps & Related

Format = Part No., Year, Description, Original Chevrolet Parts Book Group No., Price and Unit of Measure.



3683569. 50-62
Exhaust, 235ci only (2 grooves).
(0.297-40) \$15.50 EA

Valve Springs



3835626. 28-52
(0.303-15) . \$3.00 EA



3704142. 53-58
(0.303-15) . \$6.50 EA

Valve Spring Cap



837624. 35-47
Inlet (set of 6) (0.309-15) \$2.00 SET

Valve Seals



3835333. 38-57
12 pcs (0.308-40) \$8.25 SET

Valve Stem Locks



838029. 34-57
Key (12 pcs) (0.31-40) \$6.00 SET

Rocker Arm Shaft



839592. 40-58
(0.353-15) \$36.00 EA

Rocker Arm



837385B. 34-54
Adjusting screw & nut.
(0.429-15) . \$8.00 EA



839459. 41-53
Left Exhaust, exc 50-53 235ci.
(0.333-40) \$16.00 EA
939463. 41-53
Left Intake, exc 50-53 235ci
(0.333-40) \$16.50 EA

Rocker Assembly

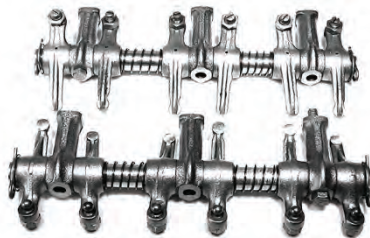

838244B. 37-39
Fits 216ci (\$100 core)
(0.352-15) \$258.00 PR
609925. 40
Fits 216ci (\$100 core)
(0.352-15) \$258.00 PR
609924. 41-53
Fits 216ci (\$50 core)
(0.352-15) \$206.00 PR
3729191. 50-58
235ci (\$50 core)
(0.352-15) \$206.00 PR

Lifters



838774. 29-39
(0.459-15) \$17.00 EA



839263. 37-55
Solid, original 40-55 (37-39 must be used w/ pushrods #3835776) (0.459-30) \$11.00 EA



5230850 50-58
Hydraulic, w/
Powerglide (0.459-15)
\$14.75 EA

Pushrods



3835776. 37-53
10-1/4". Fits 216ci, 37-39, use w/ lifter #839263 (0.426-20) \$8.00 EA
3836261. 41-55
10-5/8". All 235ci exc Powerglide (0.426-15) \$7.00 EA
3835777. 50-62
11-1/4". All 235ci w/ Powerglide (0.426-15) \$7.25 EA

Camshaft



3836491. 37-53
For solid lifters, new
(0.519-15) \$110.00 EA
3836491R 37-53
For solid lifters, reground (\$80 core)
(0.519-20) \$84.00 EA
3836491RC 37-53
Reground to 53 Corvette specs, for solid lifters (\$80 core).
(0.519-40) \$99.75 EA
3836485. 50-53
For hydraulic lifters, new
(0.519-15) \$137.00 EA
3836485R 50-53
For hydraulic lifters, reground (\$100 core)
(0.519-40) \$79.75 EA
3713919. 54-55
For solid lifters, new, exc Powerglide & 261ci (for 261ci use part #3836484) (0.519-15) \$117.75 EA
3713919R 54-55
For solid lifters reground (\$40 core) exc Powerglide & 261ci (for 261ci use part #383684R) (0.519-30) \$71.50 EA
3836483. 54-62
For hydraulic lifters, new
(0.519-15) \$178.25 EA
3836483R 54-62
For hydraulic lifters, reground (\$40 core)
(0.519-15) \$71.50 EA

22T

Providing part numbers speeds up your order, improves accuracy and helps us maintain low prices.

See Illustration Index for core charge information and a list of abbreviations. For Body Model information, see Section 5T.



Section 22T: Engine Components, Valve Covers, Rods, Bearings, Oil Pumps & Related

Format = Part No., Year, Description, Original Chevrolet Parts Book Group No., Price and Unit of Measure.

3836484. 54-58
For solid lifters, new, 235ci, 261ci
(0.51-0) \$144.50 EA
- 3836484R 54-62
For solid lifters, reground, 235ci, 261ci
(\$40 core)
(0.519-15) \$71.50 EA

Camshaft Bearings



- 838846B. 37-53
(0.539-15) \$50.00 SET
3836191. 54-58
(0.539-0) \$37.50 SET

Camshaft Thrust Plate & Spacer



3702305. 37-57
(0.533-20) \$9.25 SET

Camshaft Thrust Plate Screws



- 3702305A. 37-57
(0.533-30) \$1.50 SET

Timing Gear



- 3835371B. 37-62
Crank & aluminum camshaft gear.
Matched set (0.728-15) \$65.00 SET

Stove Bolt



839301. 40-60
W/ lock washer correct
for timing cover,
pushrod cover & oil
pan (8 pcs) (1.428-30)
\$3.25 SET

Cylinder Head Bolts



3837543. 34-62
Long (Used). (0.293-15) \$4.00 EA
3837544. 37-62
Short
(0.293-15) \$3.75 EA

Valve Cover-Grommets



838083. 34-53
2 pcs (0.413-15) \$4.00 PR

Valve Cover-Acorn Nut



131502. 29-53
Stainless (8.915-30).
\$6.50 SET
- 131502P. 29-53
Polished stainless
(8.915-15) \$13.50 SET

Oil Fill Cap



3835665. 46-57
Breather on rocker
cover, replacement.
(0.386-20) \$13.25 EA

Sleeves-(Metal)



837273. 39-53
Intake to head 216ci. Exc 50-53 235ci
(3 piece set) (3.281-20) \$7.00 SET
3835506. 50-62
Intake to head 235ci, 261ci (3 piece set)
(3.281-15) \$6.75 SET

Dampner-Balancer

605635. All
Recondition yours. 216ci, 235ci
engines. (0.659-15) \$199.50 EA

Woodruff Keys



106751. All
For harmonic balancer,
crank and cam gears
(3 pcs) (8.96-40) \$3.25 SET

Engine Assembly Lube

Synthetic oils enable Royal Purple to make superior lubricants, but it is Royal Purple's advanced Synslide additive technology that gives Royal Purple's EP lubricants their amazing performance. Engine Performance magazine raves about this product.



- 986047D. All
Royal Purple.
Synthetic, 8 oz bottle.
(8.8-15) . . \$17.00 EA



986047. All
8 oz bottle. (8.8-15) .
\$8.25 EA

Returns require a return authorization number, Please call.

Section 22T: Engine Components, Valve Covers, Rods, Bearings, Oil Pumps & Related

Format = Part No., Year, Description, Original Chevrolet Parts Book Group No., Price and Unit of Measure.



22T

Timing Hole Plug



836802A All Rubber, rare (0.714-15) \$6.75 EA

Soft Plug Set



3835121 37-54 For complete plug kit you'll also need expansion plug #838127 (0.034-40) .

\$7.50 SET

Expansion Plug



838127 38-54 Block, rear of camshaft 1-31/32in. (0.553-40) \$1.50 EA



838128 38-54 Block, rear of camshaft 1-5/8in. (0.553-40) . . \$1.75 EA

Oil Pan Plug



344690 28-57 1/2 in. w/ washer. Choose standard, single oversize, double oversize or triple oversize. (1.456-40) \$2.25 EA
 344690B 28-57 W/ washer, 1/2in., single oversize (1.456-20) \$2.25 EA
 344690C 28-57 W/ washer, 1/2in., double oversize (1.456-20) \$2.25 EA
 344690D 28-57 W/ washer, 1/2in., triple oversize (1.456-20) \$2.25 EA

Alignment Tool



38352226 37-53 Used to align oil dipper troughs in pan (\$400 refundable deposit upon return of tool) (1.427-40) \$450.00 Rent

Gasket-Oil Fill Cap



836446 31-48 Gasket. Exc 48 3/4T & larger (1.517-40) . . . \$4.25 EA

Oil Dip Stick Tube

3685702 47-57 Cut to length 8-7/64in. (1.516-15) \$38.00 EA

Oil Pressure Line



609912 36-53 Rocker arm, exc Powerglide w/ 235ci (1.519-15) \$20.00 EA



1399637B 37-54 Engine to gauge (1.519-15). \$17.50 EA

Oil Distributor Valve



839170 40-53 Exc 53 Powerglide (1.787-15) \$28.75 EA



839173 40-53 Gasket (1.79-20) . . . \$1.25 EA

Oil Pickup-Grommet



3701563 53-54 Grommet, oil pickup tube to screen assembly (1.664-40). \$1.75 EA

Oil Pump



838440 37-39 For 216ci engine (NOS) (1.652-15) \$155.00 EA

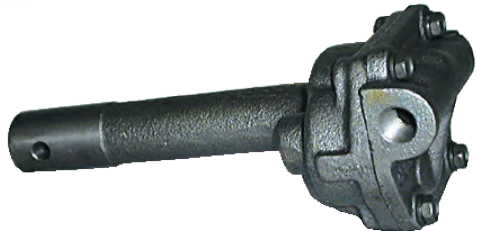

839157 40-53 Fits 216 & 235ci (exc 53 Powerglide). (1.652-0) \$105.00 EA



3702363 53-54 Fits 235ci, exc 53 stick (1.652-15) \$75.75 EA

Oil Pump Rebuild Kit

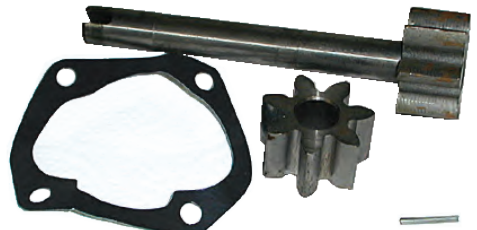

839157A 40-53 Rebuild kit, exc Powerglide (1.652-20) \$30.25 EA

Providing part numbers speeds up your order, improves accuracy and helps us maintain low prices.

See Illustration Index for core charge information and a list of abbreviations. For Body Model information, see Section 5T.



Section 22T: Engine Components, Valve Covers, Rods, Bearings, Oil Pumps & Related

Format = Part No., Year, Description, Original Chevrolet Parts Book Group No., Price and Unit of Measure.

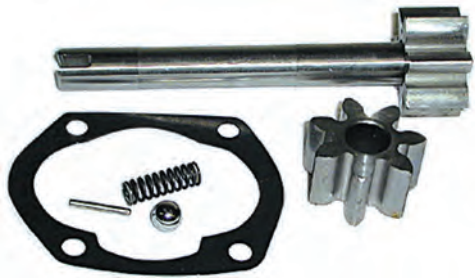

3702363A 53-54
Rebuild kit, exc 53 stick
(1.652-15) \$50.00 EA

Oil Pump Drive Gear



839164 40-53
Drive gear. Exc 53
Powerglide (NOS)
(1.659-40) . \$5.00 EA

Bee Hive Oil Filter



5573017A All
Super reproduction, painted. Hard to
find item (1.836-0) \$199.00 EA

Bee Hive Oil Filter Bracket



5573017C All
Mount bracket, painted
(1.836-0) . \$23.00 EA

Oil Filter Element



5572288C All
4-1/4in. o.d. x 5in. high, #P115 I.D.
9/16". (1.836-15) \$14.50 EA



5572288A All
3-1/4in. o.d. x 4-1/8in. high, #P203.
1-1/8" I.D. (1.836-15) \$14.50 EA



5572288D All
4-1/4in. o.d. x 8in. high, #P117. I.D.
9/16". (1.836-15) \$14.50 EA



5572288B All
4in. o.d. x 5in. high. Wix #51006.
(1.836-15) \$14.50 EA

Oil Filter Hose



3702341 37-54
13in. (3.163-20) \$19.50 EA



3654629 29-54
19in. (3.163-20)
\$19.00 EA

Note: Pilot bearing bushing see Section 140T.

Returns require a return authorization number, Please call.

Section 22T: Engine Components, Valve Covers, Rods, Bearings, Oil Pumps & Related

Format = Part No., Year, Description, Original Chevrolet Parts Book Group No., Price and Unit of Measure.



Odds & Ends

Please call for availability on all Odds & Ends parts; once part is sold, it may no longer be in stock.

838963N 37-39
Body oil distributor valve (NOS)
(1.785-40) \$20.00 EA
362897 29-36
Bushing- Piston Pin (NOS) (1-0)
\$2.00 PR
00205 37-53
Cambearings .030 (NOS) (0.539-40) .
\$15.50 SET
3701490 53-61
Connecting Rod (fits 53 Pg & All 54-61)
(0.603-40) \$75.00 EA
3701889 53
Connecting rod (fits all 53 & 53-55
Corvette) (0.603-0) \$75.00 EA
605487N 29-32
Connecting rod bolts NOS (0.623-0) .
\$23.00 EA
363713 32
Connecting rod. Fits 1932 engine. NOS
(0.603-0) \$75.00 EA
837677 35-36
Crankshaft Timing Gear (NOS) (0.728-
0) \$20.00 EA
3695373 41-55
Exhaust Valve Rotor Assembly (0.309-
20) \$3.00 EA
3730859 57-58
Exhaust Valve, All exc Powerglide (1-
30) \$4.00 EA
3836026 55
Exhaust Valves (Pass Exc P/g) (NOS)
(0.297-40) \$10.00 EA
838483 37-53
Flywheel Shield Extensions. (0.679-40)
\$15.00 EA
839226 39-54
Gasket - oil pump screen cover (7.356-
15) \$2.00 EA
838774N 29-39
Lifters (Solid) (NOS) (0.459-20)
\$22.00 EA
3847065N 37-47
Main bearing-front intermediate (0.099-
40) \$10.00 EA
3701556 47-49
Oil Dipstick NOS (Comm & Utility).
(01*000-40) \$15.00 EA
3690722 32-57
Oil nozzle at timing gear (0.748-0) ...
\$5.75 EA

603956A 37-39
Oil Pan Pipe Assembly (NOS) (1-0) ..
\$85.00 EA
837656 35-36
Oil pan seal at front crankcase. NOS-
shelf worn. (0.213-20) \$3.00 EA
838458N 29-39
Oil Pickup cover (NOS) (Shelf Worn).
(1.656-40) \$17.50 EA
604509 35
Oil pump NORS (7-11/16" overall
length) (2.108-0) \$60.00 EA
838803 29-39
Oil Pump Screen (NOS) (1.656-40) ..
\$15.00 EA
3835365 48-50
Oil pump screen cover support
assembly. Note: when using this part it
will be necessary to peen back edges
of tray to provide clearance for oil
pump suction pipe. (1.664-40)
\$25.00 EA
955-INEX. All
Oil Regulator Valve Silencing Cap
(0.303-40) \$20.00 SET
3712747 40-52
Pipe & Cover Oil Pump (NOS) (1.664-
40) \$20.00 EA
60280660A 37-40
Piston .060in. (0.629-40) .. \$45.00 EA
3731676 54-60
Piston ring set. NOS, fits 261ci engine,
standard bore. (0.643-40) \$60.00 SET
60280680A 37-40
Pistons .080in. (NOS) (0.629-40) ...
\$35.00 EA
60526010N 41-53
Pistons (NOS). Fits 216ci, .010 over.
(0.629-0) \$100.00 EA
60280680N 37-40
Pistons. 216ci Engine .080 over (NOS)
(0.629-40) \$200.00 SET
6028060N 37-40
Pistons. Fits 216ci standard bore
(NOS). (0.629-40) \$41.75 EA
6052600N 41-53
Pistons. Fits 216ci, standard bore
(NOS). (0.629-0) \$30.00 EA
38355144 All
Push rod cover used 235ci (10 bolt
holes 5-21/32 x 27) (0.439-0)
\$25.00 EA
3835344 37-53
Push rod cover. Fits 216ci (Used) (1-
40) \$25.00 EA

3835246 37-53
Pushrod cover seal. Cork. Fits all 216ci
(0.454-0) \$1.00 EA
3728993N 55-57
Rear main bearings (NOS) (0.96-40) .
\$15.00 PR
608202 37-53
Rings for 216ci .020 (NOS) (0.643-40)
\$60.00 SET
837385U 34-54
Rocker arm & nut used (0.429-40) ...
\$5.00 EA
3835528 40-53
Rocker Arm Oil Line Connector (NOS).
(1.928-0) \$25.00 EA
836867 33-36
Rocker Arm Shaft Oil Connector (NOS)
(1.928-40) \$12.00 EA
3835508 37-54
Rocker arm shaft spring (2-5/16"
length) (0.376-40) \$8.00 EA
838999 34-40
Rocker Arm- Exhaust (0.333-40)
\$7.00 EA
838993 37-40
Rocker Arm- Left Intake (0.333-40) ..
\$7.00 EA
838994 37-40
Rocker Arm- Right Intake (0.333-40) .
\$7.00 EA
3835548 50
Rocker Arm. Exhaust, 235ci Engine
(0.333-40) \$16.00 EA
3701304 53
Rocker Shaft Oil Line Connector (1-0)
\$12.00 EA
838220 37-39
Rocker Shaft Sleeve 1/8in. Id On One
End, 1/2in. Id On Other End (1.928-15)
\$2.00 EA
838246 37-53
Rocker shaft support with 216 (0.349-
40) \$40.00 EA
3836090 54-56
Rotator-Exhaust Valve, 1.5 Ton (0.309-
20) \$3.00 EA
602325 37-57
Shims for crankshaft front bearing
(0.146-40) \$5.00 SET
609121 40-50
Shims for crankshaft rear bearing
(0.153-40) \$5.00 EA
00195 37-39
Small spring around pushrod, inside
(-30) \$4.00 EA

22T

Providing part numbers speeds up your order, improves accuracy and helps us maintain low prices.

See Illustration Index for core charge information and a list of abbreviations. For Body Model information, see Section 5T.



Section 22T: Engine Components, Valve Covers, Rods, Bearings, Oil Pumps & Related

Format = Part No., Year, Description, Original Chevrolet Parts Book Group No., Price and Unit of Measure.

839304 38-50
Spring Valve All Exc PG (NOS) (0.603-20) \$3.00 EA

839156 40-50
Spring-pump Screen Retaining (1.657-0) \$3.00 EA

837253 30-50
Spring-Valve on rocker shaft (NOS) (0.376-0) \$10.00 EA

3835520 50-53
Support, Rocker Arm Shaft, 235ci (0.349-40) \$10.00 EA

609533N 33-36
Timing Gear Cover (NOS) (0.206-40). \$65.00 EA

3686784U 37-53
Valve cover (Used) (1-0) .. \$40.00 EA

838336U 30-53
Valve Cover Studs (0.413-0) \$4.00 PR

839104U 37-42
Valve cover. Needs to be repainted (Used). (0.386-0) \$50.00 EA

838246 37-54
Valve rocker shaft retainer hair pin (0.376-40) \$5.00 EA

837365 34-37
Valve Spring All exc dc (0.303-30) . . . \$3.75 EA

837264N 35-42
Valve spring cap (0.309-15). \$2.00 EA

3835392N 47-48
Valve Spring Cap (NORS) (0.309-20). \$2.50 EA

3836755 57
Valve spring cap cover V-8 (0.308-40) \$10.00 SET

839897 41-48
Valve Spring Cap-Exhaust (0.309-15) \$2.00 EA

362477 29-36
Wrist Pins, .003 O.S. (NOS) (1-40) .. \$6.00 SET

Returns require a return authorization number, Please call.

Section 24T: Engine Gaskets & Seals

Format = Part No., Year, Description, Original Chevrolet Parts Book Group No., Price and Unit of Measure.



24T

Gasket-Overhaul

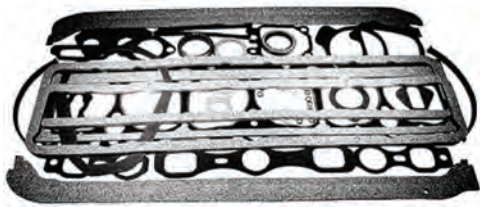

- 3702872 37-53
Complete set. All (exc 53 P.G.)
(0.01-15) \$85.25 SET
- 3702872A 50-52
Complete set. Fits 235ci
(0.01-15) \$92.50 SET
- 3719628 53-62
Complete set. Fits 235ci
(0.01-15) \$75.50 SET
- 3836107B 54-62
Complete set. Fits 261ci
(0.01-15) \$81.75 SET

Gasket-Oil Pan



- 602373 37-39
(1.429-15) \$10.75 SET
- 604338 40-55
(1.429-15) \$10.00 SET

Gasket-Head



- 839541 37-53
216ci motor. (0.289-15) \$37.75 EA



- 3835562 50-52
235ci motor (0.289-15) \$35.00 EA



- 3701296 53-62
235ci motor (0.289-15) \$27.25 EA



- 3836107 54-62
Fits 261ci (0.289-15) \$33.25 EA

Gasket-Valve Cover



- 3694248 37-53
1/4in. thick (0.423-15) \$10.00 EA
- 3696781 54-62
Cork.
(0.423-15) \$10.50 EA

Gasket-Valve Grind

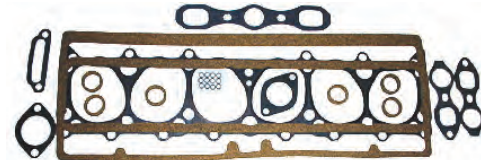

- 3691929 37-53
Exc 50-53 235ci (0.289-15) \$53.50 SET
- 3707038 50-53
Fits 235ci, exc 53 Powerglide
(0.289-15) \$51.00 SET
- 3709428 53-62
Fits 235ci, exc 53 manual trans
(0.289-15) \$58.25 SET
- 3709429 54-57
Fits 261ci
(0.289-20) \$37.75 SET

Seal-Front Timing Cover



- 3835946 37-58
(0.209-30) \$10.00 EA

Dampner-Balancer



- 605203 37-54
Sleeve, repair seal
surface on crank
dampner (0.659-20) \$8.00 EA

Seal-Rear Main



- 3835774 40-58
Original rope (2 pcs)
(0.137-15) \$18.00 EA



- 3835774G 40-58
Like original rope. Replaces original
asbestos type. Graphite (2 pcs).
(0.137-15) \$19.75 EA

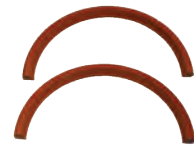

- 3835774R 40-58
Rubber (2 pcs) (0.137-
15) \$25.00 SET

Gasket-Timing Cover



- 839048B 37-62
Complete set w/ seal
(0.005-15) \$19.00 SET

Gasket-Push Rod Cover



- 602336 37-53
Gasket w/ plug seals. Exc 50-53 235ci
(0.443-15) \$14.50 SET
- 3835515 50-62
Paper. Fits 235ci & 261ci
(0.443-15) \$8.25 SET

Gasket (Intake-Exhaust Manifold)



- 602483A 37-53
Intake & exhaust manifold. Fits 216ci
(3pcs) (3.27-15) \$11.25 SET

Providing part numbers speeds up your order, improves accuracy and helps us maintain low prices.

See Illustration Index for core charge information and a list of abbreviations. For Body Model information, see Section 5T.



Section 24T: Engine Gaskets & Seals

Format = Part No., Year, Description, Original Chevrolet Parts Book Group No., Price and Unit of Measure.

3707045.....50-58
Intake & exhaust manifold. Fits 235ci &
261ci (3pcs)
(3.27-15).....\$13.50 SET

Gasket-Manifold



838290.....37-53
Rectangle between
manifolds. Fits 216ci
(3.272-15) . \$4.25 EA



3835572.....50-62
Rectangle between
manifolds. Fits 235ci &
261ci (3.272-15)....
\$4.25 EA

Gasket-Oil Fill Cap



836446.....31-48
Gasket. Exc 48 3/4T &
larger (1.517-40) ...
\$4.25 EA

Gasket-Oil Distributor Valve



839173.....40-53
Gasket (1.79-20) ...
\$1.25 EA

Gasket Sealer



1015BP.....
High temp silicone.
Black (3.35 oz tube).
(8.8-15) ... \$6.25 EA

Engine Assembly Lube



986047D..... All
Royal Purple.
Synthetic, 8 oz bottle.
(8.8-15) .. \$17.00 EA



986047..... All
8 oz bottle. (8.8-15) .
\$8.25 EA

Odds & Ends

Please call for availability on all Odds & Ends parts; once part is sold, it may no longer be in stock.

839541.....37-53
Head gasket for 216ci motor (NOS).
(0.289-40).....\$20.00 EA



1946 1/2 Ton—Pete White, Dorset, United Kingdom

Returns require a return authorization number, Please call.

Section 26T: Motor Mounts



Format = Part No., Year, Description, Original Chevrolet Parts Book Group No., Price and Unit of Measure.

Note: Transmission Mounts see Section 150T

Motor Mount-front



3739939 33-59
Also fits 39-54 GMC. (0.027-15) \$8.50 EA

Metal Cover



3656502 37-54
Front motor mount (0.029-15) .. \$12.00 EA

Motor Mount-rear



3702198 37-53
Chevy & 39-53 GMC
exc 48-53 Chevy
1/2T (47 2nd design).
(0.027-30) \$27.75 EA



756700 47-53
1/2T (47-2nd design).
(0.027-30) \$20.00 EA



3705444 54
Upper (0.027-40) . . .
\$17.00 EA



3789949 54
Lower (0.027-40) . . .
\$10.00 EA

Odds & Ends

Please call for availability on all Odds & Ends parts; once part is sold, it may no longer be in stock.

602790 37-46
Cushion-motor Mount Bracket Assy
(Accy) Heater (0.027-40) . . \$45.00 PR
3689112 47-50
Cushion-motor Mount Bracket with 2
Rear Brackets, 2 Hold Down Bolts, 2
Bolt Springs & Attaching Parts (Used
To Replace Rubber Mountings for
Heavy Duty Service) (0.027-0)
\$45.00 EA

602787 37-50
Rear bracket for cushioned motor
mount (0.027-40) \$15.00 EA

26T



Section 30T: Radiators, Caps, Overflow Tanks, Water Pumps, Hoses, Electric Fans & Fan Belts

Format = Part No., Year, Description, Original Chevrolet Parts Book Group No., Price and Unit of Measure.

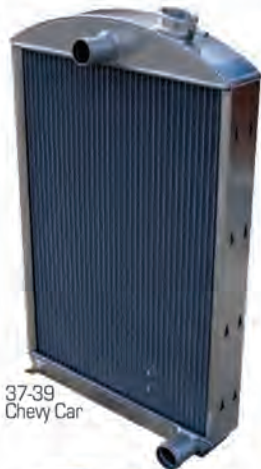

37-39
Chevy Car



41-48
Chevy Car



37-38
Ford Car

- Available Upgrades:
- Polished Radiator
 - Billet Cap
 - Polished Shroud
 - Electric Fan



Aluminum radiators from PRC offer great value at an unbeatable price. Includes billet necks for durability, weld-on universal mounting tabs and furnace brazed cores (welded in an oven), no glue or epoxy.

Available Upgrades for these radiators include: Electric Fan, Shroud and Full Polishing (shroud & radiator).

Need a custom radiator? Call or download our CUSTOM RADIATOR FORM from our web site.

* Crossflow custom radiators also available

** Oversize shipping charges apply on all radiators. No returns on custom radiators.

Part Number	Years	Fill Neck	Size	Price	Unit
CHEVY CARS - PRC					
ALUMRAD 37	37	Rear mount.	17"W x 27"H	\$430.00	EA
ALUMRADT 37	37	Rear mount w/ internal trans cooler.	17"W x 27"H	\$495.00	EA
ALUMRAD 38-39	38-39	Top mount fill neck, offset.	17"W x 27"H	\$430.00	EA
ALUMRADT 38-39	38-39	Top mount fill neck, offset w/ internal trans cooler.	17"W x 27"H	\$495.00	EA
ALUMRAD 40-41	40-41	Top mount fill neck, offset.	17"W x 27"H	\$430.00	EA
ALUMRADT 40-41	40-41	Top mount fill neck, offset w/ internal trans cooler.	17"W x 27"H	\$495.00	EA
ALUMRAD 42-48	42-48	Top mount fill neck, offset.	19-3/4"W x 24"H	\$430.00	EA
ALUMRADT 42-48	42-48	Top mount fill neck, offset w/ internal trans cooler.	19-3/4"W x 24"H	\$495.00	EA
ALUMRAD 49-54	49-54	Top mount fill neck, offset.	22"W x 24"H	\$430.00	EA
ALUMRADT 49-54	49-54	With external trans cooler. 12" without overdrive trans, 20" with overdrive trans.	22"W x 24"H	\$495.00	EA
CHEVY TRUCKS - PRC					
ALUMRAD 37-53	37-53	TYPE 1	18"W x 27"H	\$430.00	EA
ALUMRADT 37-53	37-53	With internal trans cooler.	18"W x 27"H	\$495.00	EA
ALUMRAD 46-54	46-54	TYPE 2	20-1/4"W x 24-1/2"H	\$430.00	EA
ALUMRADT 46-54	46-54	With internal trans cooler.	20-1/4"W x 24-1/2"H	\$495.00	EA
GMC TRUCKS - PRC					
ALUMRADG 37-54	37-54	Rear mount.	18"W x 27"H	\$430.00	EA
ALUMRADGT 37-54	37-54	Rear mount w/ internal trans cooler.	18"W x 27"H	\$495.00	EA
FORD CARS - PRC					
ALUMRADFC 37-38	37-38	Top mount fill neck.	16-1/2"W x 27"H	\$430.00	EA
ALUMRADFT 37-38	37-38	Top mount fill neck w/ internal trans cooler.	16-1/2"W x 27"H	\$495.00	EA
ALUMRADFC 39	39	Standard.	15-1/2"W x 27"H	\$430.00	EA
ALUMRADFT 39	39	Standard. With internal trans cooler.	15-1/2"W x 27"H	\$495.00	EA
ALUMRADFCD 39	39	Deluxe.	20-1/2"W x 25"H	\$430.00	EA
ALUMRADFT 39-40	39-40	Deluxe. With internal trans cooler.	20-1/2"W x 25"H	\$495.00	EA
ALUMRADF 41	41	Top mount fill neck.	19"W x 24-1/2"H	\$430.00	EA
ALUMRADFT 41	41	Top mount fill neck. With internal trans cooler.	19"W x 24-1/2"H	\$495.00	EA
ALUMRADF 46-48	46-48	Top mount fill neck.	20-1/2"W x 25"H	\$430.00	EA
ALUMRADFT 46-48	46-48	Top mount fill neck. With internal trans cooler.	20-1/2"W x 25"H	\$495.00	EA
ALUMRADF 49-51	49-51	Top mount fill neck.	20"W x 25-1/2"H	\$430.00	EA
ALUMRADFC-T 49-51	49-51	Top mount fill neck. With internal trans cooler.	20"W x 25-1/2"H	\$495.00	EA
ALUMRADF 52-56	52-56		18-1/2"W x 24"H	\$430.00	EA
ALUMRADFT 52-56	52-56	With internal trans cooler.	18-1/2"W x 24"H	\$495.00	EA
FORD TRUCKS - PRC					
ALUMRADF-T 37-38	37-38	Rear mount fill neck.	18-1/2"W x 27"H	\$430.00	EA
ALUMRADF-TT 37-38	37-38	Rear mount fill neck. With internal trans cooler.	18-1/2"W x 27"H	\$495.00	EA
ALUMRADF-T 40-41	40-41	Top mount fill neck.	21"W x 25-1/2"H	\$430.00	EA
ALUMRADF-TT 40-41	40-41	Top mount fill neck. With internal trans cooler.	21"W x 25-1/2"H	\$495.00	EA
ALUMRADF-T 48-52	48-52	Top mount fill neck.	21"W x 27-1/2"H	\$430.00	EA
ALUMRADF-TT 48-52	48-52	Top mount fill neck. With internal trans cooler.	21"W x 27-1/2"H	\$495.00	EA
ALUMRADF-T 53-56	53-56		21-1/2"W x 26"H	\$430.00	EA
ALUMRADFT-T 53-56	53-56	With internal trans cooler.	21-1/2"W x 26"H	\$495.00	EA
UPGRADES TO PRC RADIATORS					
POLISHRAD		Get your radiator fully polished. Add to radiator price.		\$125.00	EA
ALUMRADFAN		Electric fan for radiators listed above. 16", 2360CFM.		\$150.00	EA
ALUMRADSHROUD		Aluminum fan shroud for PRC "ALUMRAD" part numbers.		\$100.00	EA
POLISHSHROUD		Polish shroud. Add to shroud price.		\$40.00	EA

Returns require a return authorization number, Please call.

Section 30T: Radiators, Caps, Overflow Tanks, Water Pumps, Hoses, Electric Fans & Fan Belts

Format = Part No., Year, Description, Original Chevrolet Parts Book Group No., Price and Unit of Measure.



Radiator V-8 (Copper-Brass)

Oversize shipping charges apply on radiators. Please call for rate.



3118968A . . . 47-54
V8 small block, 4
core w/ trans cooler.
(1.219-15).....\$460.00 EA

Radiator (Copper-Brass)

Oversize shipping charges apply. Please call for rate.



3118968 47-54
6 cylinder, 3 core.
(1.219-15) \$411.75 EA

Radiator Cap



370683 34-36
Seahorse gorgeous (accessory).
(1.203-15) \$178.50 EA



594498AC . . . 37-52
AC Delco RC-10. No
pressure. (1.203-15) . .
\$30.50 EA



594498 37-52
No pressure. (1.203-15)
\$7.75 EA



850501 53-54
4 lb genuine AC.
(1.203-15) . \$10.25 EA



850795 55-57
7 lb genuine AC.
(1.203-15) . \$15.00 EA



850795R. 53-57
7 lbs. (1.203-30)
\$6.75 EA

Overflow Tank



985528 37-54
Accessory with hose,
mounting bracket and screws
(1.29-15).....\$157.50 EA

Note: For the correct decal see Section 550T.

Overflow Tank Decal



DEC03. 39-48
Gold with red wings
(gorgeous!) (19.2-40) .
\$5.00 EA



DEC28 49-54
(19.2-20) . . . \$6.00 EA

Hose Set



601607B 37-48
For accessory overflow tank w/
original GM instruction sheet
(1.24-30) \$9.50 SET

601607C 49-54
For accessory overflow tank w/ original
GM instruction sheet
(1.24-30) \$9.50 SET

Radiator Core Support



3707011 47-55
For center fill radiator.
(1.27-15) \$229.50 EA

Core Support Pads & Shims



367314 39-46
Radiator core support mount. 4-1/4"
x 1-1/2" (2-1/2" between bolt holes).
(1.27-40) \$12.00 SET



3684763A. . . . 47-49
Radiator core support
mount. 2-1/4" x 1-1/4"
x 1/4" thick. (1.27-15).
\$6.00 SET

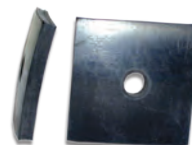

3684763. 50-54
Radiator core support
mount. (1.27-20)
\$5.25 PR

Core Support Bolt Kit



3676480. 41-54
Radiator core support
to frame. (1.27-40) . . .
\$3.25 SET

Radiator Petcock



134519. 37-39
Not as original.
(1.229-30) . . \$4.25 EA



3113456. 40-47
(1.229-20). \$14.75 EA



3719518. 48-57
(1.229-30) . . \$4.25 EA

30T

Providing part numbers speeds up your order, improves accuracy and helps us maintain low prices.

See Illustration Index for core charge information and a list of abbreviations. For Body Model information, see Section 5T.



Section 30T: Radiators, Caps, Overflow Tanks, Water Pumps, Hoses, Electric

Fans & Fan Belts

Format = Part No., Year, Description, Original Chevrolet Parts Book Group No., Price and Unit of Measure.

Radiator Hose Set



2782488 37-40
W/ metal elbow.

(1.159-20) \$44.75 SET

2782488A 41-46
W/ metal elbow.

(1.159-20) \$44.75 SET



3694277B 47-54
Molded hose with GM script with
clamps. (1.173-20) \$28.75 SET

Upper Hose



364382P 37-46
GM script 6-3/4in. (1.13-30) . \$6.50 EA



3702348 47-54
Molded hose with GM script.
(1.159-20) \$8.00 EA

Metal Elbow



378248 35-40
In lower hose. (1.173-15) ..\$16.50 EA

3656796 41-46
In lower hose.
(1.173-15) \$16.50 EA

Lower Hoses



3701363A 37-40
GM script (2 pcs) (hoses are trim-to-
fit). (1.159-30) \$9.50 SET

3701363B 41-46
GM script (2 pcs).

(1.159-30) \$11.50 SET

Moulded Lower Hose



3692230 41-46
GM script, replaces metal elbow & 2
hoses. (1.173-30) \$15.75 EA

3694277 47-54
GM script, repro.

(1.173-20) \$13.00 EA

Radiator Hose Clamps



111616 All
Upper hose (original) (2 pcs).

(1.166-20) \$4.50 SET

111619 All
Lower hose (original) (2 pcs).

(1.166-40) \$7.50 SET

Water Pump -Polished Pulley



3741033P 29-54
W/ short (narrow)
polished pulley &
shaft. For use on 55
& later 235ci & 261ci engines (\$100
core). 3-15/16" from mounting flange to
end of shaft. (1.069-20) . . \$100.00 EA

Water Pump



3741033 29-54
W/ short (narrow)
pulley & shaft (not
polished). For use
on 55 & later 235ci &
261ci engines (\$100 core). (1.069-15) .
\$89.25 EA



3741033LP . . . 29-54
For conversion to
235ci. Includes gasket
for '55 & later 235ci &
261ci 6-cylinders. (1.069-15)
\$140.00 EA



598308 37-38
W/ gasket (\$100 core).
Has aluminum pulley.
(1.069-20) \$113.50 EA



838903 39-40
W/ gasket (\$100 core).
(1.069-15) . \$87.75 EA

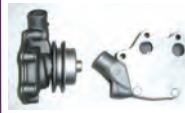

939467 41-52
W/ gasket (\$30 core).
(1.069-15) . \$85.00 EA



3836804 53-54
W/ gasket (narrow
pulley). \$30.00 core
charge. (1.069-15) . . .
\$85.00 EA



3774212 54-55
Fits 261ci. (1.069-20) .
\$85.00 EA

Fan



838277 37-54
Black finish. Fits 37-40
GA, HA, KH & 41-54
Passenger. (1.064-15)
\$33.50 EA

Pulley -Water Pump



3836804PA . . . 53-54
Polished aluminum,
single groove v-belt.
(1.069-40) . \$35.00 EA



598310 37-38
Aluminum (brushed
finish). (1.069-15)
\$55.25 EA

Returns require a return authorization number, Please call.

Section 30T: Radiators, Caps, Overflow Tanks, Water Pumps, Hoses, Electric

Fans & Fan Belts

Format = Part No., Year, Description, Original Chevrolet Parts Book Group No., Price and Unit of Measure.



3836804A. . . . 53-54
Aluminum (brushed
finish) (1.069-15)
\$31.00 EA



3123995. . . . 29-54
180 degree. (1.246-40)
\$6.75 EA

Backing Plate-water Pump



838151. . . . 37-40
(1.113-20). \$12.75 EA

Gasket-Thermostat Housing



838341. . . . 37-57
Thermostat housing
gasket. Fits
gooseneck. (1.154-15)

\$1.00 EA

Gasket-Backing Plate (Water



383150. . . . 37-40
(1.114-20) . . \$3.25 EA

Gasket-Head To Water Outlet



3838297. . . . 37-62
(1.252-20) . . \$1.50 EA



839469. . . . 41-54
(1.114-20) . . \$3.25 EA

Bushing



3837160. . . . 38-55
For temp gauge. 3/8"
I.D. (1.15-15) \$8.00 EA

Gasket-Water Pump to Block



838137. . . . 37-40
(1.079-20) . . \$3.25 EA

Belt



3836048. . . . 41-54
(1.079-20) . . \$3.25 EA



3836162. . . . 55-61
For water pump w/
short pulley & shaft
(part # 3741033 55
& later 235ci & 261ci
engines) (1.069-20) . .
\$3.25 EA

3680776. . . . 37-52
For fan & generator
(1.066-15) \$13.00 EA
3713313. . . . 53-54
For fan & generator
(1.066-0) \$10.00 EA
2190650. . . . 39-53
For fan & generator. Fits GMC.
(1.066-15) \$17.75 EA

Gasket Sealer



1015BP.
High temp silicone.
Black (3.35 oz tube).
(8.8-15) \$6.25 EA

2304817. . . . 54
For fan & generator. Fits GMC.
(1.066-20) \$9.00 EA

Thermostat



3133598. . . . 29-54
160 degree. (1.246-40)
\$7.00 EA

Odds & Ends

Please call for availability on all Odds & Ends parts; once part is sold, it may no longer be in stock.

07320 35-41
Axle flange studs, oversize 1-1/2T
(13*000-0) \$1.00 EA
954417 33-39
Bearing Pinion Shaft Rear All Utility
(13*000-0) \$20.00 EA
901305 33-39
Bearing Pinions Shaft NOS Rear Utility
(13*000-40) \$25.00 EA
3653927 40-47
Bolt Axle Shaft 1/2-13x1-11/32
(13*000-0) \$2.00 EA
3131355UR. 54-55
Defroster inlet accessory (Used)
(9.779-0) \$5.00 EA
838277U 37-54
Fan Blade (Ga, Ha, Ka, Kh & 41-54
Pass and All Truck) Used (1.064-40) . .
\$20.00 EA
07161 35-42
Lock Ring Spacer, Ball Bearing Type
(13-0) \$7.50 EA
473636 36-57
Nut-Rear Wheel Bearing (36-53 Utility)
(13*000-40) \$10.00 EA
473636N 36-57
Nut-Rear Wheel Bearing NOS (36-53
Utility) (13*000-40) \$15.00 EA
595647 37-39
Shaft Bolt Lock Axle 3-1/8 I.D. (13*000-
40) \$15.00 EA
598308N 37-38
Water Pump- (NOS) (\$35 Core Charge)
(1.069-15) \$120.00 EA

30T

Providing part numbers speeds up your order, improves accuracy and helps us maintain low prices.

See Illustration Index for core charge information and a list of abbreviations. For Body Model information, see Section 5T.



Defroster Air -Hidden Controls A/C System

Go into stealth mode for your 47-53 Chevy Truck. This kit hides center vents and controls behind stock speaker grill. Order as a complete system or choose interior only kit. Choose 2 additional vents (vent choices on following pages).

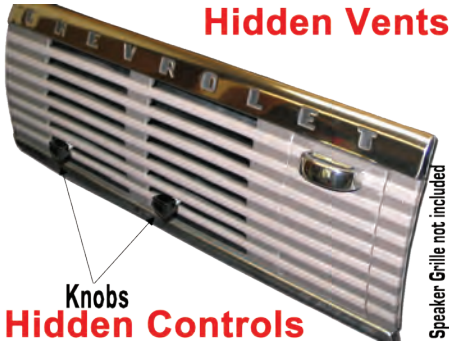

- Complete system. Cable operated controls. Choose 2 additional vents.
 47-53 Chevy Truck
AC4000GC \$1115.00 SET
- Interior only system. Cable operated controls. Choose 2 additional vents.
 47-53 Chevy Truck
AC4000GI \$540.00 SET

Speaker Grille



- Chevy Speaker grille w/ script and ash tray
 Chevy Truck
3684033 \$110.00 EA
- GMC
 47-53 GMC Truck
3684033G \$110.00 EA

Old Air -Under Dash A/C System

- Complete system. Mounts under dash. Electronic Controls.
 47-54 Chevy Truck
AC4100DC \$1,215.00 SET



- Cable operated controls.
 47-54 Chevy Truck
AC4000DC \$1,115.00 SET

Old Air -Air Conditioning & Heating System

Complete Universal systems with everything you need to install Heat & Air Conditioning in your vehicle (minus refrigerant). These Hurricane units are designed for efficiency and minimal use of space to allow for stereos, glove boxes, wiper motors, etc. Choose Hurricane unit with Upper, Lower or Side exit fittings (see dimensions below). System includes Sanden 508 Compressor (or equivalent -just let us know compressor location), Mounting Brackets, Condenser (specify location & you'll need to measure your radiator), Receiver/ Drier, Binary Pressure Safety Switch, A/C & Heater Hose, Wire Harness, Clamps, 4 inch Vent Hose Kit, Control Panel w/ Knobs and more. Pick 4 vents (next page) to best suit your dash (some double vents count as 2). Optional items include Electronic Slide Controls (Vertical or Horizontal) in black or aluminum finish, Chrome Drier or Polished Compressor.

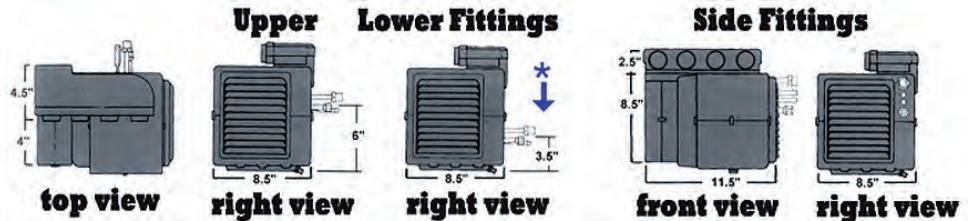

Condensers use flat tubes not round creating greater frontal area which equates to improved cooling.

The Heat & Defrost units for these systems mounts directly to your firewall. A/C & Heater lines pass through a custom rubber grommet that fits into the factory blower motor hole (shown below). Take a look at our In-Dash Vent and Switch kit below. These systems are designed for easy installation with custom condenser mounting, aluminum lines and step-by-step instructions. Retains cowl vent and majority of glove box. Has floor Heat and De-Humidified Defrost.



Universal for most applications

- Complete System with Upper HVAC fittings and Electronic Controls.
AC1100C \$1,130.00 SET
 Cable Controls. **AC1000C** \$1,030.00 SET
- Complete System with 90-degree HVAC fittings and Electronic Controls.
AC2100C \$1,201.25 SET
 Cable Controls. **AC2000C** \$1,030.00 SET
- Complete System with Lower HVAC fittings and Electronic Controls.
AC3100C \$1,130.00 SET
 Cable Controls. **AC3000C** \$1,030.00 SET

A little tight on defroster space for your HVAC unit? Just let your sales rep know that you want the 90 degree defroster outlet option. And hey, we won't even charge you for it.



90° Defrost Option
 Requires only 1-7/8" space above for duct hose routing, include "V" adapter



Standard Defrost Outlets
 Allow 2-1/2" to 3" above for duct hose routing

Returns require a return authorization number, Please call.



Old Air -Air Conditioning & Heating System Vents

Choose the 4 vents that best fit your application: (VENT-3 and VENT-20 count as 2 vents). Vents included with A/C kits. Vents also sold separately.



HVAC vents under dash, rectangular double vent (2in. x 11-1/2in.). Counts as 2.
VENT-3 \$24.00 EA

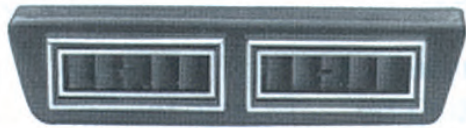

HVAC vents under dash, rectangular double vent (2in. x 10in.), Counts as 2.

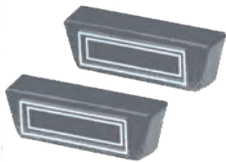

HVAC vent under dash, rectangular (2in. x 6-1/4in.)
VENT-1 \$12.50 EA



HVAC vents in dash, rectangular (1-3/8in. x 4-3/4in.)
VENT-5 \$10.00 EA

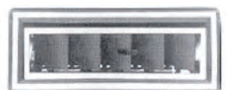

HVAC vents in dash, rectangular (1-3/8in. x 3-3/4in.)
VENT-6 \$10.00 EA



HVAC vents in dash, rectangular (2in. x 5-1/4in.)
VENT-8 \$10.00 EA



HVAC vents in dash, rectangular (2-3/4in. x 2-1/2in.)
VENT-7 \$10.00 EA

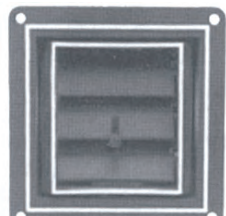

HVAC vents in dash, rectangular (3-1/2in. x 3-1/2in.)
VENT-21 \$16.50 EA



HVAC vents kick panel louvers (pair)
VENT-14 \$34.50 EA



HVAC vents under dash, round (3in. x 4-1/2in.)
VENT-2 \$12.50 EA



HVAC vents under dash, round corner
VENT-10 \$32.50 EA



HVAC vents in dash, round (2-1/4in. diameter)
VENT-9 \$10.00 EA

Old Air -Air Conditioning & Heating System-Upgrades

Options: We offer Horizontal or Vertical Slide Controls. Your choice of Brushed Aluminum or Black finish. Shine up your engine bay with a Polished Compressor and Chrome Drier (with polished clamp). All for a very reasonable cost.



Electronic controls. Smooth servo action. Available in Horizontal or Vertical cover plate and Brushed Aluminum or Black finish.



Chrome drier for air conditioning. With polished mounting bracket. 8in. L x 2-1/2in. dia. With sight glass.
ACDRIERUP \$60.00 EA



In-line Trinary Pressure Switch.
ACTRINARY \$15.00 EA



Defroster vent. Replaces missing or worn vents. Plastic.
ACDVENT \$16.00 EA

Stealth Air - Hide-A-Vent

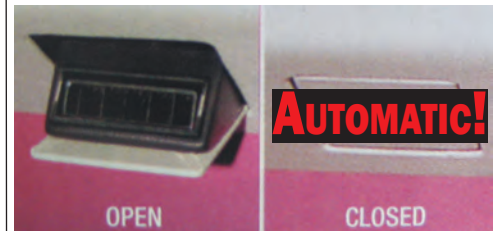

Have your A/C vents pop out automatically when fan is on & hide when fan is off. Lowers from under dash or cut out opening for vents in under dash cover (not included). 3" vent uses 2" hose.

For Under Dash Cover refer to Section 330



Vacuum Solenoid and Relay kit for Hide-A-Vent

Solenoid only (one required)
RD-2130 \$24.00 EA

Heater Control Valve



Cool Control Electronic bypass valve controls water flow to heater from minimal to full flow. Easy installation. Uses high-torque servo motor. Non corrosive, safe water flow control for a variety of applications.

OAP50-1555 \$72.50 EA



Section 35T: Air Conditioning, Heaters, Heater Hoses, Switches, Heater Decals & Heater Paint
Format = Part No., Year, Description, Original Chevrolet Parts Book Group No., Price and Unit of Measure.

Universal Heater-Defroster



Includes three knob control panel (knobs can be mounted directly into dash)

Includes Our Electronic Gen-II Servo Controlled Heater Water Valve!

506101 All
 GEN II COMPAC heater/ defroster with electronic servo controls & 3 speed fan. (9.779-0) \$229.00 KIT

Universal Heater



50515-VUH
 GEN II COMPAC heater only with electronic servo controls & 3 speed fan. (9.779-0) \$165.00 EA

Cowl Vent Knob



985603 40-46
 Ivory accessory (9.691-40) \$16.00 EA

Heater Switch



3112682B. All
 6v, rotary rheostat, clamps to dash bottom. Variable speed. (8.852-15) \$20.00 EA



3112682C. All
 12v, rotary rheostat, clamps to dash bottom. 3 speed. (8.852-15) . \$22.00 EA

Heater & Defroster Knob



3129274C. 47-53
 Warmer, maroon. (8.861-15) \$11.00 EA



3129274D. 54
 Warmer, black. (8.861-15) \$11.00 EA

Heater & Defroster Nipple



3106066. 29-54
 Connects heater hose to engine. (8.866-15) \$10.00 EA

Heater & Defroster Shutoff Valve



985533. 35-54
 Replacement, screws into water pump. (8.87-15) . \$32.00 EA

Heater Control Valve

3128267D 47-55
 Rebuild service using your core. (8.861-15) \$110.00 EA

\$10 shipping & handling fee for rebuild service.

Heater Control Valve Rebuild Kit



3128267C. 47-54
 Rebuild kit, w/ instructions. (8.861-15) \$12.75 EA

Defroster Duct Hose



3119156R. All
 1-1/2in. i.d. 36in. length. Plastic replacement (original was cloth covered, wound wire) (9.779-20) \$24.50 EA
 3119719. All
 1-3/4in. i.d. 36in. length. Cloth covered. (9.779-15) \$24.00 EA

3125764. All
 2in. i.d. 36in. length. Cloth covered. (9.779-15) \$24.00 EA

Heater & Defroster Hose



3691292 All
 Black, 5/8in. hose (8.846-40) \$2.00 FT

Heater & Defroster Hose Clamps



432645. All
 Fits 5/8in. hose. Original (4 pcs) (1.166-40) . \$4.50 SET

Heater Grommet



3691292A. 47-54
 Grommet for 5/8in. heater hose (thru firewall). (8.846-20) . \$8.50 PR

Heater Wiring Harness



3106048B. 37-49
 Heater & defroster (8.853-15) \$51.75 EA

Voltage Reducer



1119005.
 12v to 6v voltage reducer to operate heater, radio & gauges. Hi-tech, delivers constant volts. Superior quality. (2.5-15) \$72.00 EA



1119005C.
 12v to 6v voltage reducer to operate heater. (2.5-15) \$18.25 EA

Returns require a return authorization number, Please call.



35T

Heater Gasket

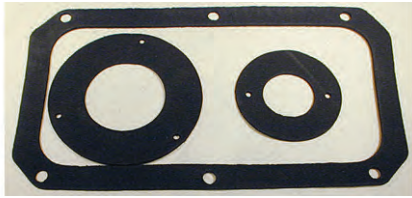

986248A 47-54
 Gasket, deluxe heater set.
 (8.845-15) \$13.25 EA

Heater Core Rebuild

3115605R 37-54
 Rebuild your heater core (8.854-15) .
 \$375.00 EA

\$10 shipping & handling fee for rebuild service.

Paint-Heater



604481P 42-46
 Beige hammer tone
 (thin w/ enamel
 thinner). (16.08-15) . .
 \$57.50 QT



604481H 47-54
 Silver hammer tone
 (thin w/ enamel
 thinner) (16.08-15) . .
 \$34.50 QT

NOTE: Hazardous materials such as paints & cleaners cannot be shipped by air carrier. Ground shipping only (no international, Alaska or Hawaii).

Heater Motor



5047730 47-54
 Heater Motor. 6v exc airflow (5-1/2in. x
 3in. diameter), NOS.
 (8.855-20) \$89.75 EA

Heater & Defoster Motor

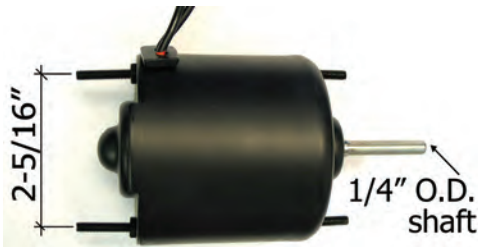

5047531 37-54
 6v replacement (5in. x 3in.
 diameter) 1-3/8in. Shaft reversible.
 (8.855-15) \$65.50 EA



5047849 37-54
 12v replacement, (5in. x 3 in.
 diameter) 1-1/2in. shaft, reversible
 (8.855-15) \$60.75 EA

Heater Box



986248 47-54
 Deluxe with recirculating fan.
 (8.854-15) \$148.50 EA

Resistor



3829052 38-72
 Heater blower motor
 (w/o A/C). (8.855-15)
 \$16.00 EA

Decal Defroster



DEC06 47-55
 On/off defroster decal.
 (19.2-20) . . \$3.00 EA

Decal Heater



DEC07 47-52
 Chevrolet round
 emblem. (19.2-15) . .
 \$9.00 EA



DEC08 47-52
 GMC round emblem.
 (19.2-15) . . \$9.00 EA



DEC09 53
 Fresh air round decal.
 (19.2-15) . . \$2.50 EA



DEC10 53-54
 GMC round decal.
 (19.2-15) . . \$2.75 EA



DEC16 54-55
 Fresh air round decal.
 (19.2-15) . . \$2.50 EA



DEC17 53
 Recirculating round
 decal. (19.2-15)
 \$3.50 EA



DEC18 54-55
 Recirculating round
 decal. (19.2-15)
 \$3.00 EA



DEC29 49-51
 Decal-Harrison
 (19.2-20) . . \$3.50 EA



Odds & Ends

Please call for availability on all Odds & Ends parts; once part is sold, it may no longer be in stock.

1997811 38-48
 Defroster switch high low exc 42-46
 COE (9.779-40).....\$40.00 EA

1997816 47-49
 Heater switch used (8.852-40).....
 \$25.00 EA

04070 41-48
 Switch, air , under dash (NOS) (9.779-
 0).....\$40.00 EA



1946 1/2 Ton—Scott Mills for Larry O'Malley,
 Independence, Kansas

Returns require a return authorization number, Please call.

Section 40T: Starters & Related

Format = Part No., Year, Description, Original Chevrolet Parts Book Group No., Price and Unit of Measure.



40T

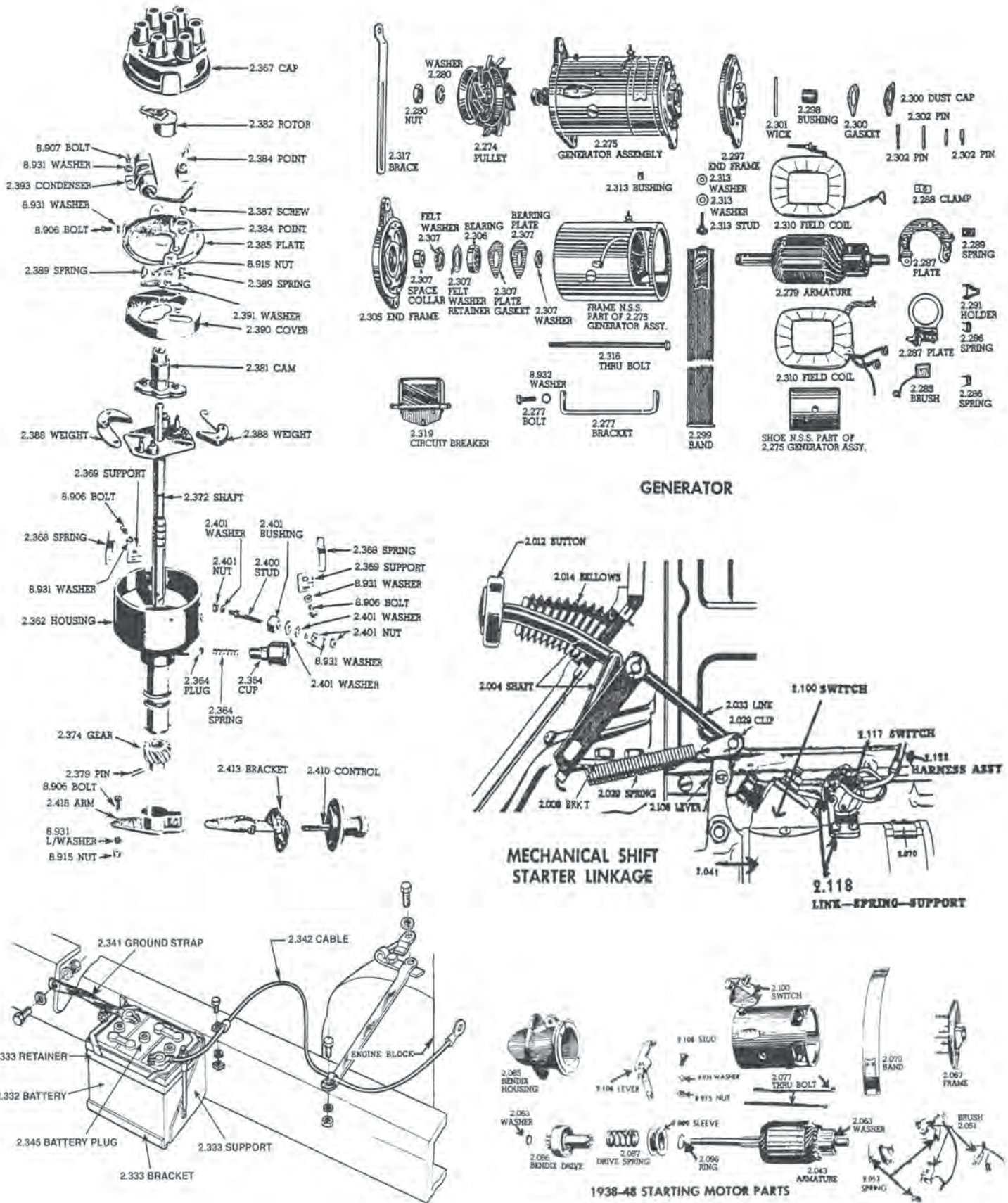

Providing part numbers speeds up your order, improves accuracy and helps us maintain low prices.

See Illustration Index for core charge information and a list of abbreviations. For Body Model information, see Section 5T.



Section 40T: Starters & Related

Format = Part No., Year, Description, Original Chevrolet Parts Book Group No., Price and Unit of Measure.

Starter Switch



362941 29-37
Foot starter (NOS)
(2.1-40) . . \$19.00 EA



820052A 38-54
Foot starter. No side
terminal (NORS) (2.1-
15) \$18.25 EA

Starter Pedal Return Spring



3654152 37-54
Return spring. (2.029-
20) \$5.50 EA

Starter Solenoid



1118135 54
Double Duty & 54-55
Hydromatic (2.1-0) . .
\$50.50 EA

Starter Solenoid Repair Kit



1118135A 49-54
Also fits 53-55 Corvette
(2.1-15) \$15.00 EA



1118135A 54-55
Double Duty & 54-55
Hydromatic (2.1-15) . .
\$15.00 EA

Starter Solenoid Boot



1912448 49-59
Double duty model and
hydromatic (2.113-30)
\$10.00 EA

Insulator



1118135C 49-64
Molded, keeps
solenoid cool. (2.1-15)
\$16.75 EA

Polarity Reverse Switch



1889827 41-42
On starter, w/ 1in. x
1-1/2in. base (NOS)
(2.117-40). \$38.00 EA



1907122 46-48
On starter (NOS)
(2.117-40) \$44.00 EA



1881929 41-48
Wiring harness for
reverse polarity switch.
(2.122-15) \$22.75 EA

Engine Crank



3661378 37-53
Manual start, hardened steel.
Repro. If you have the muscles!!
(0.239-0) \$60.00 EA



3681380 47-53
Starting crank support
bracket (7.025-15) . .
\$19.00 EA

Starter

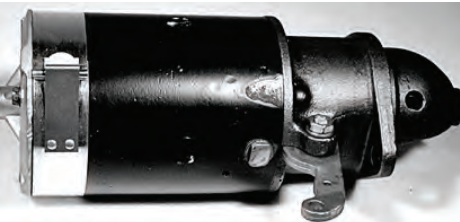

1107108 38-54
Foot operated (\$35 core)
(2.041-15) \$115.50 EA

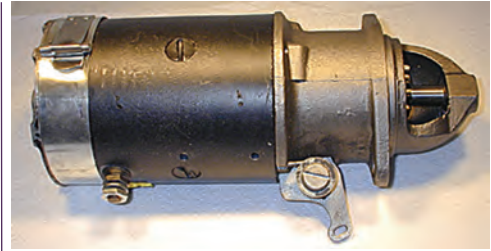

1913369 49-54
Uses solenoid (\$50 core). Fits
Passenger & DUBL-DUTI Trucks.
(2.041-15) \$121.00 EA

Starter Rebuild Service

1864489 37
Rebuild yours (2.041-15). \$136.50 EA

Starter Rebuild Kit

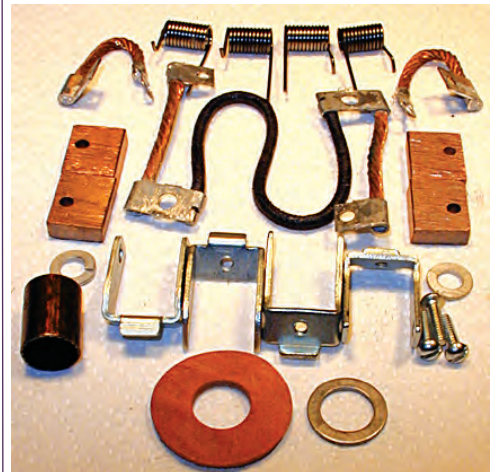

1900558 37-54
W/ brushes, bushings (18 pcs).
(2.053-15) \$50.00 KIT

Starter Drive



1859020 34-37
(2.086-15) \$82.00 EA



2873789 38-54
(2.086-20) \$45.00 EA

Starter Brush Set



811553 25-54
(2.051-40) \$5.00 SET

Returns require a return authorization number, Please call.

Section 40T: Starters & Related



Format = Part No., Year, Description, Original Chevrolet Parts Book Group No., Price and Unit of Measure.

Starter Bushing

-  810620 29-37
Drive end (2.083-30)
\$4.25 EA
-  1839345 38-54
Drive end (2.083-20) .
\$2.75 EA
-  810620A 38-54
Nondrive end (2.083-30) \$4.25 EA

Starter Band

-  817114 29-54
Covers openings on starter
(2.07-15) \$6.25 EA

Starter Oil Cover

-  114998 29-54
Hinged lid. 3/8" o.d.
insert. (2.305-15) . . .
\$5.00 EA

Delco Remy Metal Tag

-  PLATE07 37
Generator, starter & distributor
(19.4-15) \$10.25 EA
-  PLATE05 38-54
Generator, Starter or Distributor.
Includes rivets. (19.4-15) \$6.25 EA

Odds & Ends

- Please call for availability on all Odds & Ends parts; once part is sold, it may no longer be in stock.*
- 813550 25-37
Commutator end frame 25-37 Chevy.
26-29, 33-34 Pontiac (2.067-40)
\$15.00 EA
 - 1907038 29-54
Frame, Starting Motor Com. End
(2.067-0) \$15.00 EA
 - 1927200 55-57
Starter Drive Assy. (Bendix) All (3-0) .
\$20.00 EA
 - 1885814U 49-50
Starter motor lever used (2.108-0) . . .
\$15.00 EA
 - 1119789 55-56
Starter solenoid. 12V new item, never
used. (2.1-0) \$30.00 EA

40T

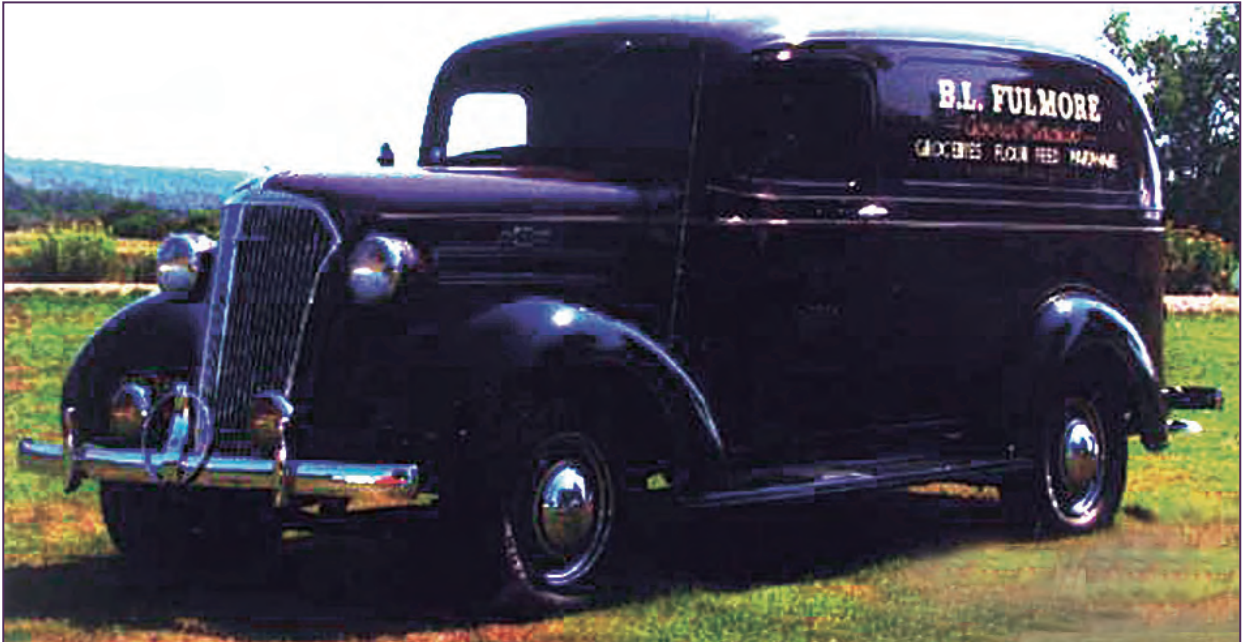

1937 1/2 Ton—Burt Fulmor, Nova Scotia, Canada



Section 45T: Alternators, Generators, Voltage Regulators, Batteries, Battery Trays & Battery Cables

Format = Part No., Year, Description, Original Chevrolet Parts Book Group No., Price and Unit of Measure.

Alternator

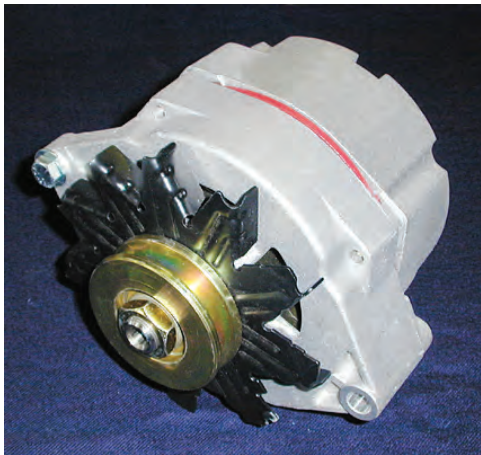

89502S
6v-60 amp, 7.5v internally regulated, single groove pulley, comes w/ DA plug, uses original wiring, new. (2.275-0)\$207.00 EA

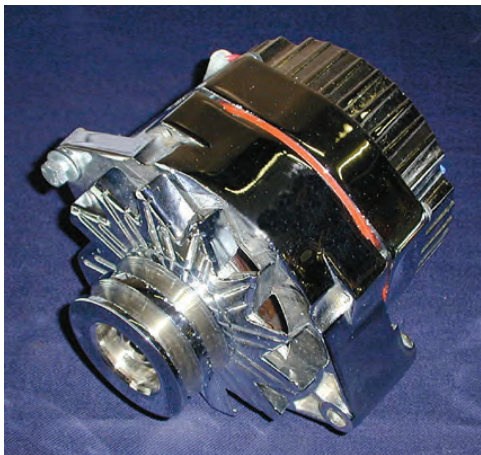

89502C
6v-60 amp, 7.5v show chrome housing, 3/8" 2 groove pulley, internally regulated, comes w/ D.A. plug, uses original wiring, new. (2.275-0)\$278.25 EA

D.A. Plug



89502
Connects 6v or 12v alternator to original wiring. (2.275-15) \$18.25 EA

Alternator Pulley



89502P
3/8" 2 groove. (2.274-15) \$30.25 EA



90502WP 37-52
For 37-52 w/ 1/2" belt. (2.274-15) \$30.25 EA

Mount Bracket



839446B
Universal alternator bracket. (2.277-15) \$75.75 EA



839446C 37-55
Alternator bracket (12v or 6v alt. 37-52 requires 53-54 water pump & 53-up crank pulley). (2.277-15) \$75.00 EA

Battery Tender Plus

1.25 amp, Charges a battery and maintains it. Automatically switches from full charge to floating charge mode. Reverse Polarity Protection.

Battery Tender Plus -Battery Charger



BT06V
6 Volt Charger. (2.332-15) \$62.50 EA
BT12V
12 Volt Charger. (2.332-15) \$62.50 EA

Battery Minder

1.0 max amp. Charger/ maintainer/ conditioner charges without overcharging. No sulphate build-up.

Battery Minder Plus -Battery Charger



BM12V
12 Volt Charger. (2.332-15) \$50.00 EA

BM06V
6 Volt Charger. (2.332-15) \$50.00 EA

Returns require a return authorization number, Please call.

Section 45T: Alternators, Generators, Voltage Regulators, Batteries, Battery Trays & Battery Cables
 Format = Part No., Year, Description, Original Chevrolet Parts Book Group No., Price and Unit of Measure.



Smartcharge -Battery Charger



SMARTCHG
 Maintain and charge your battery with the SmartCharge™ digital battery charger! This handy unit keeps your battery in the ideal state and lengthens its life span using AccuCharge™ technology.
 -Ideal for Hot Rods
 -Maintains & Extends Your Battery Life
 -AccuCharge™ Technology
 -Steady Trickle Charge (-15) .. \$18.00 EA

Generator



1102744 40-52
 10-1/2in. long, 6v (\$75 core)
 (2.275-15)\$115.50 EA



1100024 52-54
 9-1/2in. long, 6v (\$75 core).
 (2.275-15)\$115.50 EA

Generator Rebuild Service

1100502 29-39
 Rebuild service for your generator
 (2.275-15).....\$131.25 EA

Generator Rebuild Kit



1901243 40-54
 W/ brushes, gaskets, etc. (41 pcs).
 Pulley end bearing #954378 not included. (2.286-15) \$40.00 KIT

Generator Brush Set



1857963 37-39
 (2.285-15) \$7.75 SET



1878209 40-54
 (2.285-15) \$4.50 SET

Generator Bearing



954378 29-57
 Pulley end (2.306-30)
 \$7.50 EA

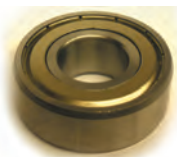

954685 53-57
 Commutator end
 (2.298-15) \$23.00 EA

Generator Bushing



812823 29-48
 Commutator end
 (2.298-40) . \$3.75 EA

812824 49-52
 Commutator end
 (2.298-40) \$2.75 EA

Generator Oil Cover



816341 29-54
 (2.305-15) . \$3.25 EA

Generator Band



816340 29-52
 Covers opening in generator
 (2.299-15) \$11.00 EA

Generator Bolt & Nut



3682642B 37-54
 Set (generator to motor) (2.277-15) . . .
 \$5.25 SET

Delco Remy Metal Tag



PLATE07 37
 Generator, starter & distributor
 (19.4-15) \$10.25 EA



PLATE05 38-54
 Generator, Starter or Distributor.
 Includes rivets. (19.4-15)\$6.25 EA

Providing part numbers speeds up your order, improves accuracy and helps us maintain low prices.

See Illustration Index for core charge information and a list of abbreviations. For Body Model information, see Section 5T.



Section 45T: Alternators, Generators, Voltage Regulators, Batteries, Battery Trays & Battery Cables

Format = Part No., Year, Description, Original Chevrolet Parts Book Group No., Price and Unit of Measure.

Belt



- 3680776 37-52
For fan & generator (1.066-15) \$13.00 EA
- 2190650 39-53
For fan & generator. Fits GMC.
(1.066-15) \$17.75 EA
- 3713313 53-54
For fan & generator
(1.066-0) \$10.00 EA
- 2304817 54
For fan & generator. Fits GMC.
(1.066-20) \$9.00 EA



- 1118331 53-54
(2.5-15) \$72.00 EA

Battery Tray

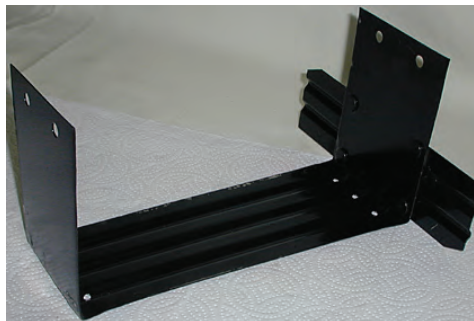

- 594062 37-46
Metal tray only. (2.333-15) \$26.25 EA

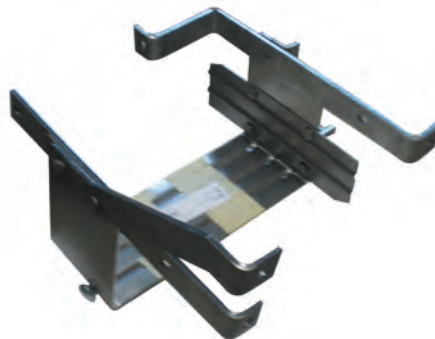

- 594062A 37-46
Metal tray w/ attaching brackets.
(2.333-15) \$65.00 EA



- 3683559 47-55
Complete with sides and studs.
(2.333-15) \$51.00 EA



- 3683563 47-54
Base only. (2.333-15) \$14.00 EA

Voltage Cut Out



- 1867781 29-39
Exc COE (2.319-40) \$78.75 EA

Voltage Regulator



- 1118301A 40-52
(2.5-15) \$65.00 EA

Battery Tray Paint



- 12998 All
Corrosion resistant, black (12
oz spay) (8.8-15) \$20.00 EA

Battery Cover



- 354120 29-38
Inspection cover in floor. 4-1/2" x 8"
(16.547-15) \$16.00 EA

Returns require a return authorization number, Please call.

Section 45T: Alternators, Generators, Voltage Regulators, Batteries, Battery Trays & Battery Cables

Format = Part No., Year, Description, Original Chevrolet Parts Book Group No., Price and Unit of Measure.



3652966 39-46
Inspection cover in floor. 4-1/2" x 10".
(16.547-15) \$28.00 EA

Battery Cover Gasket



3683383A 47-54
Battery inspection cover.
(16.547-30) \$7.75 EA

Battery Hold Down



3653224 47-54
(2.335-15) \$16.25 EA

Battery Mat



3686708B
Anti-corrosion pad to protect your
battery tray. 7 3/4" X 12" x 1/8" thick.
(2.333-30) \$6.50 EA

Ground Strap



529404A 29-54
13in. replacement. (2.341-15) .. \$19.00 EA



602387 47-54
Engine to frame. (9.65-15) \$12.00 EA

Positive Cable



1854073 29-46
Fabric covered 25-1/4in.
(2.342-0) \$36.75 EA
5288946 47-54
Fabric covered 39-1/2in.
(2.342-15) \$57.00 EA

Odds & Ends

Please call for availability on all Odds & Ends parts; once part is sold, it may no longer be in stock.

00940 52-54
Battery Filler Cap Accessory. Save A
Battery (2.332-40) \$35.00 SET
1910404 37-52
Frame generator drive end (2.305-0) .
\$15.00 EA
00991 57
Generator 12 volt rebuilt (3-15)
\$75.00 EA
3704711U 41-52
Generator bracket (2.277-40)
\$15.00 EA
839447 41-54
Generator bracket ((Used)) (2.317-0).
\$15.00 EA
3703618U 53-54
Generator Bracket 53-54 Pass, 53-55
Comm Use with 1100018 6 Volt
(2.277-40) \$15.00 EA
3835672 52
Generator Bracket. 6-1/8in. overall
length. Fits all 11000B small
generators (2.277-0) \$15.00 EA
602253 36-51
Pulley on engine for low speed driving.
Keeps motor cool at low speed.
(2.274-0) \$25.00 EA
118301R 40-52
Rebuilt voltage regulator (2.5-0)
\$75.00 EA
1118835 52-55
Voltage Regulator-rebuilt-6v-50amp
(13.5-40) \$45.00 EA

45T

Providing part numbers speeds up your order, improves accuracy and helps us maintain low prices.

See Illustration Index for core charge information and a list of abbreviations. For Body Model information, see Section 5T.



Section 50T: Ignition Systems, Ignition Switches, Vacuum Advances & Distributors

Format = Part No., Year, Description, Original Chevrolet Parts Book Group No., Price and Unit of Measure.

Ignition Switch

1116469D . . . 51-55
As original for 1951-52 car (no accessory position). Fits 1954-55 (1st Series) Chevy truck also. (2.188-15) \$48.00 EA



1112362E6 41-53
6v. (2.384-15) \$145.00 SET
1112362E12 41-53
12v. (2.384-15) \$135.00 SET



1112388E6 54-62
6v. (2.384-15) \$128.50 EA



1112388E12 54-62
12v. (2.384-15) \$124.00 EA

Distributor



1112362A 40-54
Mallory dual point. Chevy & GMC 6-cylinder. (2.361-0) \$375.00 EA



PED62720
50,000 volt coil & Dyna-Module allows wider plug gaps & instant throttle response. Add a set of Livewires to go with your electronic distributor. (0-15) \$395.00 EA

Spark Plug Wires



PEDC9066-E
Chevy in-line 6 cyl., 250-292ci. Choose color: Red, Black, Blue, Yellow or Purple. (0-15) \$88.75 SET

Ignition Coil - Pertronix 6 Volt



PER40001
Chrome. 1.5 Ohm primary resistance. (2.384-0) \$40.75 EA
PER40011
Black. 1.5 Ohm primary resistance. (2.384-0) \$35.75 EA

Wire Looms



5298107L All
Chrome. Fits 216ci, 235ci. (0-15) \$29.00 SET

Spark Plug Wire Set



5298107R . . . 34-54
Superb reproduction. Copper core. (2.239-15) . . . \$25.00 EA

O-Rings



3652191 29-59
Rubber, holds plug wires. (2.251-40) . . . \$2.50 SET

Plugs



1559494 33-54
Genuine AC14 mm plug (exc 41-48) (6 pcs) (2.27-15) \$17.75 SET



1559459 41-48
Genuine AC 10 mm plug (6 pcs) (2.27-15) . . . \$18.75 SET

Returns require a return authorization number, Please call.

Section 50T: Ignition Systems, Ignition Switches, Vacuum Advances & Distributors

Format = Part No., Year, Description, Original Chevrolet Parts Book Group No., Price and Unit of Measure.



Polarity Reverse Switch



1889827 41-42
On starter, w/ 1in. x
1-1/2in. base (NOS)
(2.117-40). \$38.00 EA

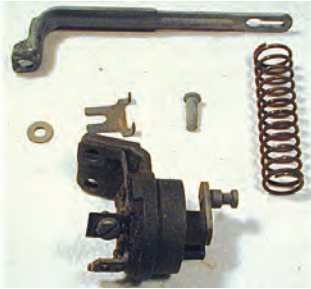

1907122 46-48
On starter (NOS) (2.117-40) \$44.00 EA



1881929 41-48
Wiring harness for reverse polarity
switch. (2.122-15) \$22.75 EA

Distributor



1112362 40-53
Exc 53 powerglide (\$35 core)
(2.361-15) \$90.00 EA
1112358 53-57
Exc 53 stick shift (\$35 core)
(2.361-15) \$90.00 EA

Points



1855720 33-40
2-1/8in. overall length
(2.384-15) \$6.50 SET



\$6.50 SET



1882391 41-48
With polarity reversing
switch (1-3/4in. overall
length) (2.384-15) \$13.25 SET

1855720 48-53
All (exc 48 w/ polarity
reversing switch & 53
235ci) 2-1/8in. overall
length. (2.384-15) . . .

1924571 53-57
All (exc 216ci,
2-3/16in. overall
length) (2.384-15) . . .
\$7.75 SET

Condenser



1928111 37-54
(2.393-40) . \$4.75 EA

Hold Down Screw



816784 All
Condenser & points
(2.387-40) . \$0.75 EA

Rotor



820445 33-52
All exc CC, DC & 53
235ci (2.382-20)
\$4.50 EA



1924245 53-57
All, exc 53 216ci
(2.382-15) . \$4.00 EA

Distributor Cap



824735 33-53
Except 53 235ci (2.364-15) \$16.00 EA



1924248 53-54
With 235ci, 261ci (2.364-15) \$15.00 EA

Ignition Coil



1115380 47-54
6v, Delco (NOS) (2.17-15) \$85.00 EA



1115380A 47-54
6v, replacement (2.17-30) \$42.00 EA

Delco Remy Metal Tag



PLATE07 37
Generator, starter & distributor
(19.4-15) \$10.25 EA



PLATE05 38-54
Generator, Starter or Distributor.
Includes rivets. (19.4-15) \$6.25 EA

Providing part numbers speeds up your order, improves accuracy and helps us maintain low prices.

See Illustration Index for core charge information and a list of abbreviations. For Body Model information, see Section 5T.



Section 50T: Ignition Systems, Ignition Switches, Vacuum Advances & Distributors

Format = Part No., Year, Description, Original Chevrolet Parts Book Group No., Price and Unit of Measure.

Timing Hole Plug



836802A. All Rubber, rare (0.714-15) \$6.75 EA

Vacuum Advance



1116076R. 37-54 Rebuild service (your core) (2.41-15) \$86.50 EA

\$10 shipping & handling fee for rebuild service.



1909343A. 39-55 W/ bracket & timing mark 90 degrees to vacuum chamber. exc 261 (2.41-15) \$50.00 EA



1909343. 39-62 Less bracket, NOS. (2.41-30) . \$75.00 EA

Ignition Switch



1116452. 40-54 Bolt-in replacement, w/ "Start" & "Accessory" positions (6v or 12v) Needs original key & lock cylinder '35-'57 trucks (#1458180) or '47-'48 trucks (#3716725) --not included. (2.188-15) \$33.50 EA

1116452. 47-53 Reproduction. Bolts in like original. Screw terminal. Foot starter only. (2.188-15) \$30.00 EA



1116452A
Are you using a fork lift ignition switch? Use our flush mount switch w/ mounting bracket. Finish it off with a lock cylinder #1458180 or #3716725 (including keys). (2.188-15) \$32.75 SET

Ignition Switch Mounting Plate



3688155
Universal mounting plate conforms to your dash to mount your switch (cylinder not included). (2.192-20) \$6.50 EA

Ignition Lock



1458180. 35-57 Cylinder & non-GM keys. (2.188-15) \$13.00 EA



3716725. 47-48 Cylinder & keys (non GM). (2.188-15) \$24.50 EA

Ignition Switch Mounting Bracket



Faces rear of truck

3684097. All Mounting bracket (behind dash). (2.192-15) \$20.00 EA

Key Blank



601272. 35-54 Original GM round head. Fits trunk, glove box & locking gas cap (2.187-30). \$2.25 EA



3694624. 35-57 Original GM octagon head. Fits ignition, door & spare tire locks. (2.187-30) \$1.75 EA

Returns require a return authorization number, Please call.



Odds & Ends

Please call for availability on all Odds & Ends parts; once part is sold, it may no longer be in stock.

- 1847432 34-37
 Armature (Starter) All exc Dc (2.279-40) \$25.00 EA
- 1865155 37-38
 Bracket, Distributor Vac Control (2.41-0) \$30.00 EA
- 1869573 57
 Bracket, Holds Condensor 8cyl Use w/ # 1112330 (NOS) (2.393-0) . \$0.75 EA
- 11123624 40-53
 Distributor with points and cond (Used). (2.361-40). \$75.00 EA
- 1112363 51-52
 Distributor, w/o contact plate (NOS) (2.361-40). \$75.00 EA
- 1847643 33-56
 Dual point breaker plate (2.385-0) . . . \$45.00 EA
- 1853749U 33-34
 Electric lock cable (no key cylinder) (2.188-40). \$50.00 EA
- 00875 38-51
 Ignition Coil NOS GMC w/ Fins (2.17-40) \$50.00 EA
- 1916805 51-53
 Insulator, Inner, for Distributor (3-0) . . \$2.00 EA
- 5298107R 29-55
 Plug wire set by Packard (fits 29-46 all & 47-55 Comm) (2.239-0) . \$20.00 EA
- 1855520 39-48
 Points (6.168-40) \$15.00 EA
- 1851208 All
 Spark plug wire. 7MM, compression type. Sold by the foot (2.241-0) \$2.00 FT
- 1848515 33-37
 Vacuum Control Fits CA, DA, EA, ED, FA, FD & GA (2.41-40) . . . \$50.00 EA

50T



1939 1/2 Ton—Geral Laurin, Trevor, Wisconsin

Providing part numbers speeds up your order, improves accuracy and helps us maintain low prices.

See Illustration Index for core charge information and a list of abbreviations. For Body Model information, see Section 5T.



Section 55T: Horns & Related

Format = Part No., Year, Description, Original Chevrolet Parts Book Group No., Price and Unit of Measure.

Horn



HORN3
Ooogah horn. Heavy
duty 12 volt motor.
Easy installation.

Limited lifetime warranty. (2.81-15) . .
\$46.00 EA

Horns

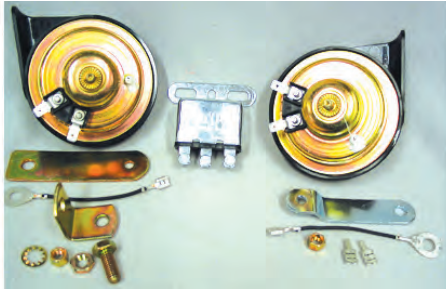

9000518 40-54
W/ relay, 12v (pair). (2.81-15) \$60.00 SET

Horn Contact



265316 41-46
W/ spring. Fits COE
only. (2.819-30)
\$10.00 EA

Horn Button Contact



759037 47-57
Contact w/ spring. Fits
49-57 cars (& vette),
37-57 Comm & Util.
(2.819-20) . \$9.50 EA

Horn Contact Plate

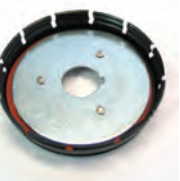

758239 47-53
Horn button snaps
over this plate. 2-5/8"
O.D., 9/16" I.D (2.819-
15) \$20.00 EA



758566 54-59
Horn button snaps
over. 2-1/2" O.D.,
9/16" I.D. (2.819-15).
\$20.00 EA

Cup W/ Chrome Rim



473258 29-40
For horn button.
(2.819-30) \$22.00 EA

Horn Button Assembly



753838 29-40
S-wire, rubber button & metal cap.
(2.817-15) \$28.50 SET

Horn Button S-wire



753838B 29-40
(2.817-40) . \$5.50 EA

Horn Button



753838C 29-40
Metal cap on rubber
horn button. (2.817-
40) \$9.00 EA

609620609620 41-46
41-46 all commercial & utility (exc
COE). (2.817-15) \$28.00 EA



755850 47-53
Chrome & painted.
(2.82-15) . \$35.00 EA



3720100 54
Chrome & painted.
(2.82-0) . \$25.00 EA

Horn Button Pad



753838A 29-40
Rubber. (2.817-0) . .
\$9.00 EA

Horn Button Spring

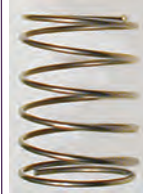

755284 41-46
(2.816-40) . . \$9.00 EA

Horn Relay



1116775A 34-54
6v, replacement.
(2.815-15) \$20.00 EA



1116775B All
12v (2.815-15)
\$13.25 EA

Horn Wire Grommet



9000516 40-54
Horn wire thru horn
cover (2 pcs). (2.81-
30) \$5.75 SET



3711896 41-46
Horn wire thru steering
column. (9.775-15) . .
\$3.25 EA

Returns require a return authorization number, Please call.



Highway Series Wiring Kits

Some of the features of the Highway Series Kits include:

Complete wiring for instrument gauges; steering column wiring including directionals and hazard; all engine compartment wiring; gauge cluster disconnect harness; alternator leads for GM SI internally regulated & 1-wire alternators; accessory feed wires for A/C, heater, radio and wipers; all fuses, flashers and horn relays; GM column mounted ignition switch connectors & dash mounted ignition switch and connectors; color coded instructions; highest quality GM terminals & GXL/XLPW wire; alternator in-line diode, anti-push-back locks; color coded connection block; dimmer switch; headlight switch; mega-fuse protection and as always...complimentary tech support.



#13237. . . \$349 Kit

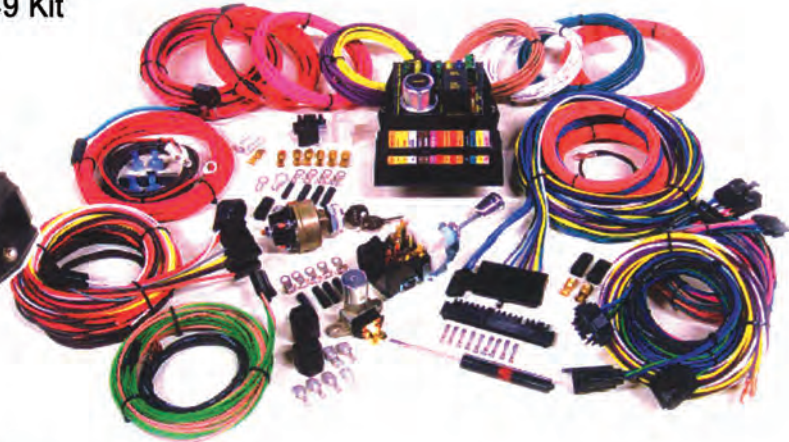

#500695. . . \$449 Kit



Superior Quality!
Superior Engineering!
Superior Color Schematics!

American Autowire wiring kits are the only kits available utilizing the vibration-proof connection system and engineering techniques of "Hooke's Law". Ask us about it!



Section 60T: Wiring Harness, Wiring Clips, Terminal Boards

Format = Part No., Year, Description, Original Chevrolet Parts Book Group No., Price and Unit of Measure.

Main Wire Harness-Street Rod



500944 Highway 15-Nostalgia (details on previous page). (-15) ... \$795.00 KIT



13237 Highway 15-Street Rod (details on previous page). (8.055-15) \$349.00 KIT

Main Wire Harness-Street Rod Truck

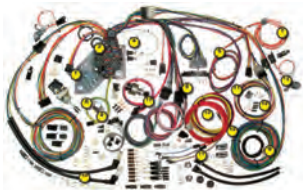

2960053SR 47-55
Built on the new 18 fuse, 21 circuit fuse box system, kit comes completely ready to install under the dash. Includes modern fuse box, instruction sheet, dash harness, instrument cluster kit, parking lamp kit, rear body kit, power plus front lighting kit, engine & starter kit, courtesy light connection kit, fuse relay flasher kit, ignition switch, headlight switch, dimmer switch and wire ties. (2.555-0) \$499.00 SET

Custom Harness



XP-735 Pre War street rod trucks. (-15) \$430.00 SET

Custom Wiring Harness



CK-540 Converts your stock 6 volt engine to 12 volt or upgrade your existing 12 volt. (-0) \$360.00 SET

Main Wire Harness-Chevrolet

Note: Turn signals are located in Section 80T.

Note: Our cloth-covered wiring harnesses below are superb reproductions with braided harness cover and numbered ends for easy installation.



1865315	37-38
Original cloth (2.555-15)	\$445.00 EA
1872970	39
Original cloth (2.555-15)	\$475.50 EA
1872970A	39
Original cloth (fits fire truck, commercial, etc.) (2.555-15)	\$433.25 EA
1879561	40
Original cloth (2.555-15)	\$563.50 EA
4284502	41-46
Original cloth (2.55-15)	\$563.50 EA
4188864	47-49
Original cloth (2.555-15)	\$674.00 EA
5299874	50-53
Original cloth (2.555-15)	\$740.00 EA

Some 1953 & all 1954 trucks used plastic wiring harnesses.

Returns require a return authorization number, Please call.

Section 60T: Wiring Harness, Wiring Clips, Terminal Boards



Format = Part No., Year, Description, Original Chevrolet Parts Book Group No., Price and Unit of Measure.

Main Wire Harness-GMC



1865315G	37
GMC, original cloth, special order (2.555-15)	\$633.50 EA
1879561G	40
GMC, original cloth, special order (2.555-15)	\$732.75 EA
4284502G	41
GMC, original cloth, special order (2.555-15)	\$721.75 EA
5284496G	46
GMC, original cloth, special order (2.555-15)	\$485.75 EA
4188864G	47-49
GMC, original cloth, special order (2.555-15)	\$721.75 EA
5299874G	50-52
GMC, original cloth, special order (2.555-15)	\$675.50 EA
5299874A	53
GMC, original cloth, special order (2.555-15)	\$746.75 EA

Some 1953 & all 1954 trucks used plastic wiring harnesses.

Main Wire Harness- Replacement Chevrolet

Note: Plastic wiring harnesses include turn signal harness.



1865315P	37-39
Plastic, generator (2.555-15)	\$224.50 EA
1865315PV	37-39
Plastic, alternator (2.555-15)	\$216.50 EA

4284502P	40-46
Plastic, generator (2.555-15)	\$225.50 EA
4284502PV	40-46
Plastic, alternator (2.555-15)	\$209.50 EA
4188864P	47-49
Plastic, generator (2.555-15)	\$180.50 EA
4188864PV	47-49
Plastic, alternator (2.555-15)	\$155.25 EA
5299874P	50-52
Plastic, generator (2.555-0)	\$150.00 EA
5299874PV	50-52
Plastic, alternator (2.555-0)	\$150.00 EA
2960053P	53-54
Plastic, generator (2.555-0)	\$150.00 EA
2960053PV	53-54
Plastic, alternator (2.555-0)	\$150.00 EA

Main Wire Harness- Replacement GMC

Note: Order GMC wire harnesses when you want to add electric temperature and oil pressure gauges to your Chevrolet truck.



1865315T	37-39
Plastic, GMC, generator (2.555-15)	\$224.50 EA
1865315TV	37-39
Plastic, GMC, alternator (2.555-15)	\$216.50 EA
4284502T	40-46
Plastic, GMC, generator (2.555-15)	\$225.50 EA
4284502TV	40-46
Plastic, GMC, alternator (2.555-15)	\$209.50 EA
4188864T	47-49
Plastic, GMC, generator (2.555-15)	\$209.50 EA
4188864TV	47-49
Plastic, GMC, alternator (2.555-15)	\$216.50 EA

5299874T	50-52
Plastic, GMC, generator (2.555-15)	\$209.50 EA
5299874TV	50-52
Plastic, GMC, alternator (2.555-15)	\$214.50 EA
2960053T	53-54
GMC, plastic, w/ generator (2.555-15)	\$180.50 EA
2960053TV	53-54
GMC, plastic, w/ alternator (2.555-15)	\$214.50 EA

Transmission Wire Harness-GMC

5299874B	53
GMC, for hydramatic original cloth, special order (2.555-15)	\$152.75 EA

Headlight Pigtails



918977	37-39
Exc COE (2.75-15)	\$60.00 PR
5931796	41-46
And park light (2.75-0)	\$54.00 EA



5942312	47-55
W/ grommets (2.75-15)	\$65.00 PR

Note: Turn signals are located in Section 80T.

Providing part numbers speeds up your order, improves accuracy and helps us maintain low prices.

See Illustration Index for core charge information and a list of abbreviations. For Body Model information, see Section 5T.

60T



Section 60T: Wiring Harness, Wiring Clips, Terminal Boards

Format = Part No., Year, Description, Original Chevrolet Parts Book Group No., Price and Unit of Measure.

Heater Harness



3106048B 37-49
Heater & defroster (8.853-15) \$51.75 EA

Horn Harness



1997713A 37-42
Town & Country horn
(2.832-15) \$65.75 EA

Wire Loom



1846572 All
Black, original hard cover to protect
wiring, 1/4in. i.d. (2.53-20) \$0.75 FT
1846574 All
Black, original hard cover to protect wiring,
5/16in. i.d.
(2.53-30) \$1.00 FT
1846573 All
Black, original hard cover to protect wiring,
3/8in. i.d.
(2.53-15) \$0.75 FT

1846575 All
Black, original hard cover to protect wiring,
7/16in. i.d.
(2.53-20) \$1.00 FT
1846576 All
Black, original hard cover to protect wiring,
1/2in. i.d.
(2.53-15) \$1.00 FT

Wire



985776A All
Armored steel covered.
(9.773-30) \$0.25 IN
985777W All
Lacquer coated braided, white.
(9.773-40) \$0.25 IN

Clip



3735074A All
1/8in. slot, wiring or
tubing (4 pcs) (8.95-15)
\$5.75 SET



3735074C All
3/8in. slot, gas, brake
line, wire harness (4
pcs). (8.95-15)
\$4.75 SET



148129 All
(9/16in. Slot) wiring or
tubing (4 Pcs) (8.95-15)
\$6.25 SET

Terminal Boards

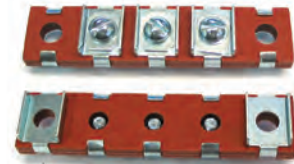

2-3/8" center to center

1865535 40-53
(3 terminal) main wiring to headlight &
park light pigtails w/ rivets. Mounting
holes: 2-3/8" center-to-center.
(2.56-15) \$20.00 PR

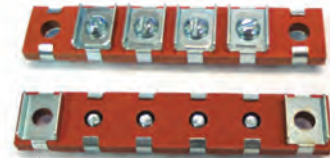

3" center to center

1998756 40-54
(4 terminal) main wiring to headlight
& park light pigtails w/ rivets.
Mounting holes: 3" center-to-center.
(2.56-15) \$24.00 PR

Odds & Ends

Please call for availability on all Odds & Ends parts; once part is sold, it may no longer be in stock.

1913990 38-52
Generator comutator end frame (NOS)
Fits 38-39 PASS, COE, 40-52 ALL
(2.297-0) \$20.00 EA
1848532 34-37
Spring Starter Motor (3-40). \$10.00 EA
001385 48
Start switch on dash-pushbutton, black
(03*000-0) \$20.00 EA
1913369B 55-57
Starter 12v Foot Start (0-15) \$66.50 EA

Returns require a return authorization number, Please call.

Section 80T: Turn Signals, Flush Mount Kits, LED Bulbs & Park Lights

Format = Part No., Year, Description, Original Chevrolet Parts Book Group No., Price and Unit of Measure.



Halogen Turn Signal Kit w/ Harness



9857206TK 37-53
W/ (2) 6v halogen bulbs, wire harness, flasher sockets & switch (specify year when ordering). (2.761-0)
37-39 \$263.25 SET
40 \$277.50 SET
41-42 \$245.00 SET
42-46 \$247.00 SET
47-53 \$247.00 SET



9857212TK 37-53
W/ (2) 12v halogen bulbs, wire harness, flasher sockets & switch (specify year when ordering). (2.761-0)
37-39 \$247.75 SET
40 \$269.50 SET
41-42 \$231.75 SET
42-46 \$213.25 SET
47-53 \$231.00 SET

Halogen Turn Signal Kit -No Harness



9857207TK 37-53
W/ (2) 6v halogen bulbs, flasher sockets & switch, w/out wire harness (specify year when ordering).
37-39 \$99.75 SET
40 \$94.00 SET
41-42 \$103.00 SET
42-46 \$103.25 SET
47-53 \$103.25 SET



9857208TK 37-53
W/ (2) 12v halogen bulbs, flasher sockets & switch, w/out wire harness (specify year when ordering). (2.761-0)
37-39 \$106.00 SET
40 \$98.25 SET
41-42 \$107.25 SET
42-46 \$110.50 SET
47-53 \$110.50 SET

Billet Park Light Rim

Polished billet aluminum park light rim available in 2 designs, crossbar or open. Mounts to original bucket & lens.



312810-1 47-53
Polished billet aluminum (crossbar design). Mounts to original bucket & lens. (2.593-0) \$60.00 PR

312810 47-53
Polished billet aluminum (open design). Mounts to original bucket & lens. (2.593-15) \$60.00 PR

Bulbs -LED

Note: LEDs are very directional and need to be angled correctly to be bright. Minimal current draw.



\$15.00 EA

145416LED6A
6v, straight pins.
Replaces bulb #1156.
Use LED flasher
#3713382L. (8.991-15)



#3713382L. (8.991-15) \$15.00 EA

145416ALED6A
6v, offset pins.
Replaces bulb #1157.
Use LED flasher



#3713382L. (8.991-15) \$15.25 EA

145416J
12v, offset pins.
Replaces bulb #1157.
Use LED flasher



#3713382L. (8.991-15) \$12.25 EA

145416K
12v, straight pins.
Replaces bulb #1156.
Use LED flasher

Turn Signal Flasher -LED



\$16.75 EA

3713382L
12v. For use w/ LED lights (3 prong). LOW LOAD. (2.892-30)



\$16.75 EA

3713382L2
12v. For use w/ LED lights (2 prong). LOW LOAD. (2.892-30)



\$10.00 EA

FF552NLF
12v. For use w/ LED lights (2 prong). Fixed blinker speed. (2.892-15)



\$40.00 EA

FF552NL
12v. For use w/ LED lights (2 prong). Adjustable blinker speed. (2.892-15)



\$50.00 EA

FF552NLP
12v. For use w/ LED lights (2 prong). Adjustable pulsing blinker speed. (2.892-15)

Providing part numbers speeds up your order, improves accuracy and helps us maintain low prices.

See Illustration Index for core charge information and a list of abbreviations. For Body Model information, see Section 5T.



Section 80T: Turn Signals, Flush Mount Kits, LED Bulbs & Park Lights

Format = Part No., Year, Description, Original Chevrolet Parts Book Group No., Price and Unit of Measure.

Turn Signal Flasher -Audible

1335230TA
Audible flasher. 6v, 3 prong. (2.892-0).
\$33.75 EA

3713382TA
Audible flasher. 12v, 3 prong. (2.892-0)
\$31.25 EA



FF552TA
Audible flasher. 12v, 2
prong. (-0) \$28.75 EA

Turn Signal Flasher

1335230 All
6v (2.892-30) \$6.50 EA

3713382 All
12v (2.892-15)
\$7.00 EA

Turn Signal Switch

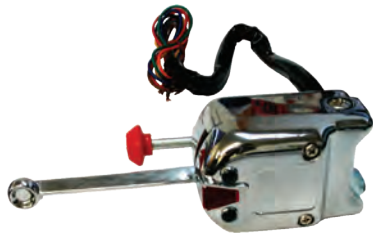

985720 All
Superior (2.895-15) \$25.50 EA



985720E All
Economy (2.895-15) \$16.50 EA

5944127 54-62
(2.895-15). \$25.00 EA

Turn Signal Knob

5939511A 54-59
(2.906-15). \$11.00 EA

Flasher Socket

5297633 All
W/ mounting bracket
(2.892-15) . . \$6.50 EA

Turn Signal Harness



985720A39 37-39
Cloth, w/ flasher socket, extra pigtail
for park lights and instructions
(2.761-0) \$138.50 EA

985720A40 40
Cloth, w/ flasher socket, extra pigtail for
park lights and instructions
(2.761-0) \$138.50 EA

985720D42 41-42
Wire harness, plastic, w/ flasher socket,
extra pigtail for park lights and instructions.
(2.761-0) \$121.50 EA

985720D46 42-46
Wire harness, plastic, w/ flasher socket,
extra pigtail for park lights and instructions.
(2.761-0) \$121.50 EA

985720D53 47-53
Wire harness, plastic, w/ flasher socket,
extra pigtail for park lights and instructions.
(2.761-0) \$121.50 EA

Park Light Assembly



916957T 37-39
Accessory. Complete with turn signal.
(2.585-15) \$102.00 EA



916957 37-39
Accessory. Complete assembly
(2.585-15) \$76.00 EA



595825 37-39
Retainer plate & wire
guide for park light
(2.585-30) \$29.00 L&R



928665 47-53
Clear, 6v. (2.585-15) \$40.00 EA

928665B 47-53
Clear, 12v, double element bulb for turn
signals.
(2.585-15) \$48.00 EA

928664 47-53
Amber, 12v, double element bulb for turn
signals.
(2.585-15) \$44.00 EA



897429 54-55
55 1st series. (2.585-15) . . \$40.00 EA

Park Light Body



5942094 54
With chrome rim.
(2.586-15). \$26.00 EA

Returns require a return authorization number, Please call.

Section 80T: Turn Signals, Flush Mount Kits, LED Bulbs & Park Lights



Format = Part No., Year, Description, Original Chevrolet Parts Book Group No., Price and Unit of Measure.

Sockets & Bulbs For Park Lights w/ Turn Signals

Park light socket and bulb kits also available with halogen or LED bulbs.



1873702S 37-39 6v (2.75-20)	\$20.00 SET
1873702U 37-39 12v (2.75-30)	\$20.25 SET
5930046S 40 6v (2.75-15)	\$27.00 SET
5930046U 40 12v (2.75-15)	\$27.00 SET
5936804S 47-53 6v (2.75-30)	\$19.00 SET
5936804U 47-53 12v (2.75-40)	\$19.00 SET
5942094S 54 6v (2.596-30)	\$16.75 SET
5942094U 54 12v (2.75-40)	\$16.75 SET

Halogen Bulbs can be added to following kits for an additional \$20.

5930153S 41-42 6v (2.75-30)	\$20.50 SET
5930153U 41-42 12v (2.75-40)	\$20.50 SET
5032299S 42-46 6v (2.75-20)	\$16.75 SET
5032299U 42-46 12v (2.75-40)	\$19.00 SET

Park Light Lens



920249 37-39
Accessory (2.589-15) .
\$15.00 EA



924854 40
Plastic (2.589-15) . . .
\$25.25 EA



5930136P 41-42
Plastic, 4in. long for
die cast housing.
(2.589-15) . \$26.25 EA



5932977 42-46
2in. long for tin cover
housing. (2.589-15) . .
\$10.25 EA



5936802G . . . 47-50
GMC (2.589-15)
\$22.00 EA



5936801 47-53
Amber, glass. (2.589-
20) \$12.50 EA



5936802 47-53
Clear, glass lens.
(2.589-20) . . \$7.25 EA



5935955 51-53
GMC (glass). Includes
gasket #5936805G.
(2.589-15) . \$15.75 EA

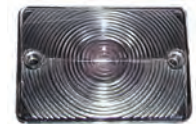

5942151 54
Clear (2.589-15)
\$8.00 EA



5942151A 54
Amber (2.589-15)
\$8.00 EA

Park Light Rim



5930230 40
(2.593-15) . \$25.50 EA



5936795 47-53
Chrome. (2.593-15) . .
\$8.00 EA

Park Light Rim Screws



923315 40
Stainless steel (2 pcs)
(2.688-30) . \$0.75 SET



5942152 47-53
4 pcs. (2.594-40)
\$1.50 SET

Park Light Lens Gasket



922758 40
(2.59-15) . . \$3.25 PR



5930153 41-42
4in. Long. (2.59-20) . .
\$4.75 PR



5932999 42-46
2-3/16in. long (2 pcs).
(2.59-20) . . \$6.00 PR



5936804G . . . 47-50
GMC (2 pcs). (2.59-15)
\$3.25 PR



5936805G . . . 51-53
GMC (2 pcs). (2.59-15)
\$2.00 PR



5936804 47-53
2 pcs. (2.59-15)
\$3.50 SET



5942513 54
(2.59-15) . . \$4.75 PR

80T

Providing part numbers speeds up your order, improves accuracy and helps us maintain low prices.

See Illustration Index for core charge information and a list of abbreviations. For Body Model information, see Section 5T.



Section 80T: Turn Signals, Flush Mount Kits, LED Bulbs & Park Lights

Format = Part No., Year, Description, Original Chevrolet Parts Book Group No., Price and Unit of Measure.

Grommet



928665A 47-54
Park light wire-thru
housing. (2.596-15) . .
\$4.00 PR

Mounting Pads



603313 37-39
Park light to fender (2 pcs)
(2.599-15) \$12.25 PR



3650817 40
Park light to fender
(2.599-30) . . \$6.00 PR



917012 41-42
Park light w/ die cast base (2 pcs).
(2.599-30) \$10.00 PR



5932996A 42-46
Park light w/ 1 pc tin cover (2 pcs).
(2.599-30) \$10.00 PR



5936003G . . . 47-50
GMC park light (2
pcs). (2.599-20)
\$5.25 SET



5936003F 52-53
GMC park light (2 pcs).
(2.599-15) . . \$10.50 SET



897429A 54
Park light to fender.
(2.599-15) . \$10.50 PR

Odds & Ends

*Please call for availability on all Odds
& Ends parts; once part is sold, it may
no longer be in stock.*

917012U 41-46
Parking lamp housing, left side (Used)
(2.585-0) \$25.00 EA



1938 1/2 Ton—Richard Palomo, Odessa, Texas

Returns require a return authorization number, Please call.

Section 85T: Driving Lights, Fog Lights & Spot Lights

Format = Part No., Year, Description, Original Chevrolet Parts Book Group No., Price and Unit of Measure.



85T

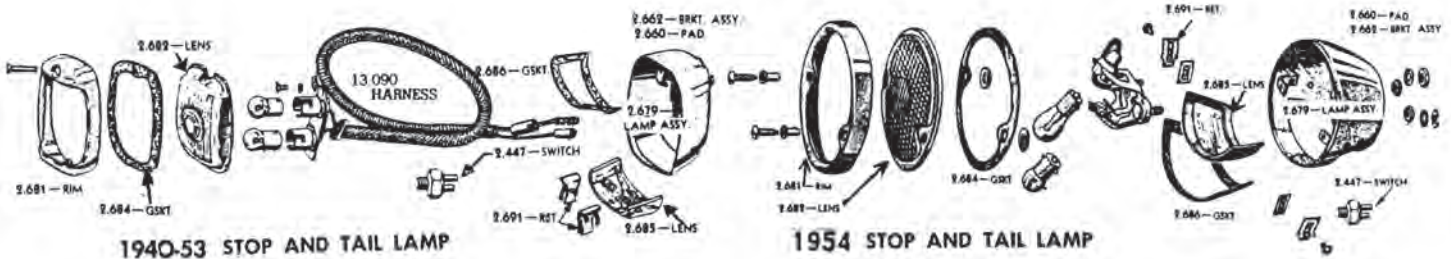
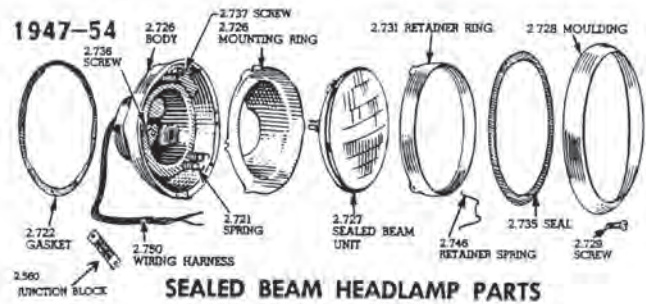
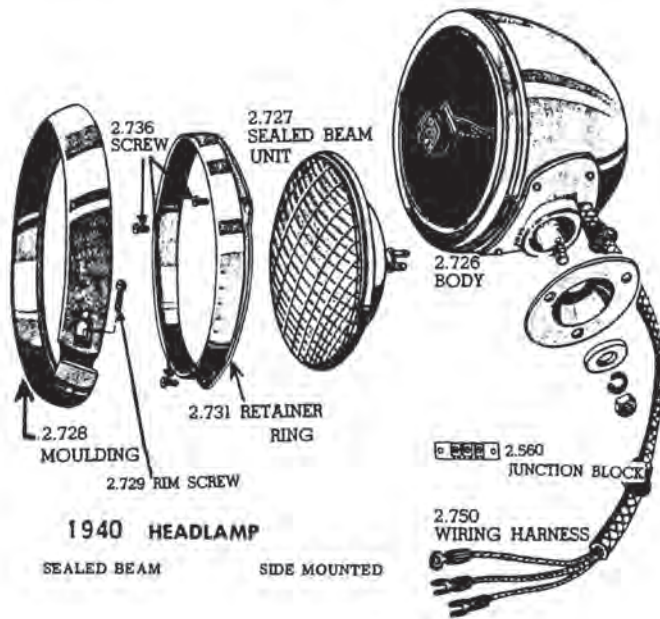
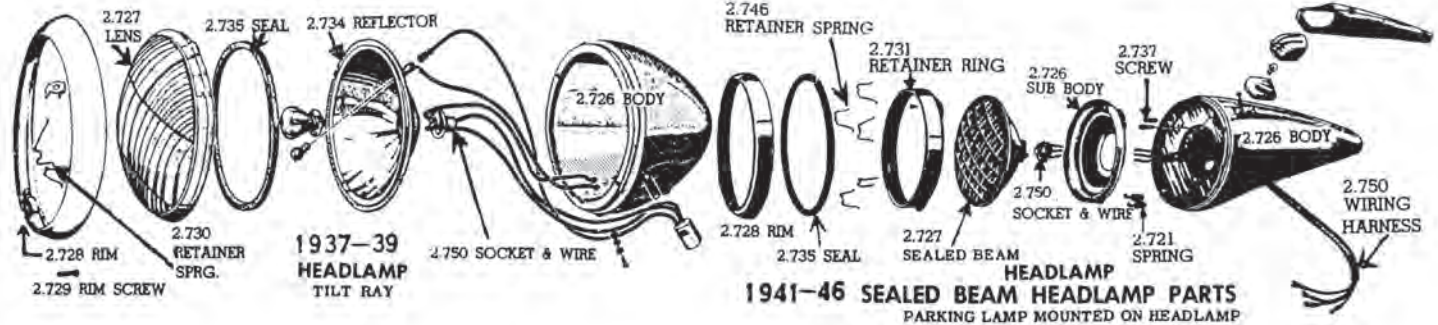

Providing part numbers speeds up your order, improves accuracy and helps us maintain low prices.

See Illustration Index for core charge information and a list of abbreviations. For Body Model information, see Section 5T.



Section 85T: Driving Lights, Fog Lights & Spot Lights

Format = Part No., Year, Description, Original Chevrolet Parts Book Group No., Price and Unit of Measure.

Note: Fog and driving lights are GM script w/ brackets, switch & wiring. Fog lights are amber, driving lights are clear.

Driving Lights



- 409185 All
Clear, 6v, 5in. (specify year when ordering). (9.774-0)\$181.75 PR
- 409185A 37-54
Clear, 12v, 5in. (specify year when ordering). (9.774-30) \$151.00 PR
- 409186 All
Clear, 6v, 6in. (specify year when ordering). (9.774-0) \$181.75 PR
- 409186A 37-54
Clear 12v, 6in. (specify year when ordering). (9.774-0) \$151.00 PR

Fog Light



- 985174 37-38
Nice repro w/ brackets. (9.774-15) \$280.50 SET

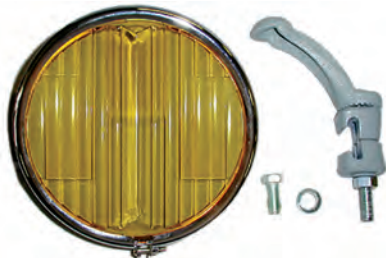

- 985444 39
Nice repro w/ brackets. (9.774-15)\$306.00 PR



- 409182 All
Amber with GM script. 6v, 5in. dia. (specify year when ordering). (9.774-0)\$181.75 PR
- 409182A 37-54
Amber with GM script. 12v, 5in. dia. (specify year when ordering). (9.774-0) \$151.00 PR
- 409183 37-54
Amber with GM script. 6v, 6in. dia. (specify year when ordering). (9.774-0) \$181.75 PR
- 409183A 37-54
Amber with GM script. 12v, 6in. dia. (specify year when ordering). (9.774-0) \$151.00 PR

Fog Light Lens



- 921415 37-38
Amber. 6-5/16" o.d. (9.774-15) \$19.75 EA

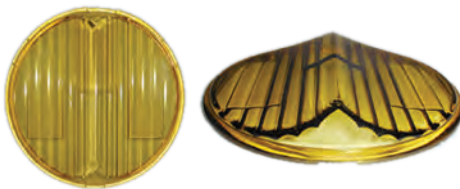

- 923706 39
Amber (original repro). 6-3/4" dia. (9.774-15) \$23.50 EA

Fog Light Rim



- 5930366 40
Chrome (NOS). 7" o.d. (9.774-0) . \$42.00 EA

Fog Light Emblem



- 984716E 41
(9.774-15)\$31.50 EA

Fog Light Bracket

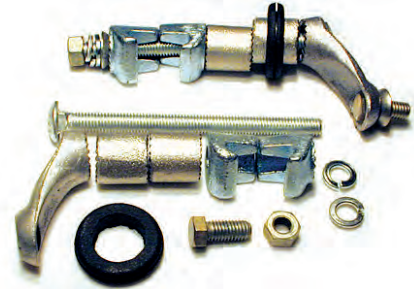

- 5933244 All
W/ apron on bumper brackets. (9.774-15)\$38.75 SET

Switch



- 924160 All
Fog light, backup light, etc, rotary. Clamps to dash bottom. (9.774-20) \$20.00 EA

Note: Headlight and spotlight bulbs see Section 100T.

Spotlight

Note: Spotlights have GM script and include right or left bracket and template.

- 985993H 37-54
6v, 5in. (specify year & left or right when ordering). (9.773-0) \$133.75 EA



- 985993A 37-54
6v, 6in., (specify year & left or right when ordering). (9.773-0)\$142.25 EA
- 985993G 37-54
12v, 5in. (specify year & left or right when ordering). (9.773-0) \$133.75 EA

Returns require a return authorization number, Please call.

Section 85T: Driving Lights, Fog Lights & Spot Lights



Format = Part No., Year, Description, Original Chevrolet Parts Book Group No., Price and Unit of Measure.

985993F. 37-54
12v, 6in., (specify year & left or right when
ordering).
(9.773-0) \$133.75 EA

Spotlight Brackets



985993TR. 37-54
Right (specify year when ordering).
(9.773-0) \$33.00 EA
985993TL 37-54
Left (specify year when ordering).
(9.773-0) \$33.00 EA

Spotlight Handle



985998B. All
Ivory w/ chrome housing & switch for
spotlight. (9.773-15) \$52.00 EA

GM Script Tag



985993M. 37-54
Top of driving lights,
fog light and spotlight.
(9.773-20) \$8.25 EA

Wire Assembly



985774A. All
W/ armored steel
covered, cloth wire &
metal fuse holder for
spotlight, as original.
(9.773-20)
\$21.25 SET

Fuse Holder



985775A. All
Metal fuse holder.
(9.773-15) . \$8.25 EA

Wire



985776A. All
Armored steel covered.
(9.773-30) \$0.25 IN
985777W All
Lacquer coated braided, white.
(9.773-40) \$0.25 IN

Odds & Ends

Please call for availability on all Odds & Ends parts; once part is sold, it may no longer be in stock.

5931921U All
Bracket fog lamp (9.774-0) \$10.00 EA

85T

Providing part numbers speeds up your order, improves accuracy and helps us maintain low prices.

See Illustration Index for core charge information and a list of abbreviations. For Body Model information, see Section 5T.



Section 90T: Headlight Components, Frenched Kits, Halogen Conversions, Rims, Seals & Switches

Format = Part No., Year, Description, Original Chevrolet Parts Book Group No., Price and Unit of Measure.

Headlight - Halogen with LED Turn Signal. AutoNik Slick Signals



AUT6001C
The ultimate in cool. 7 inch, H-4 Halogens with amber LED turn signal-marker lights. Replacement for H6024 sealed beam. Complete instructions and easy to install. Extensive testing went into bulb selection for long life and best lighting characteristics.
(2.727-20) \$85.00 EA

Headlight Bucket/ Housing



919475FL. . . . 37-40
Left. (2.726-15) . . .
\$117.75 EA



919475FR. . . . 37-40
Right. (2.726-15) . . .
\$117.75 EA



925203F. . . . 41-46
Fiberglass (specify left or right hand when ordering). (2.726-15)
\$117.75 EA

Stand -Headlight Bucket



350778F. . . . 39-40
Fiberglass, right.
(2.544-15) \$81.00 EA



350777F. . . . 39-40
Fiberglass, left.
(2.544-15) \$81.00 EA

Halogen Headlight Conversion



110185D. 31-39
Halogen bulb. 6v headlight conversion. Double the light of a sealed beam, retains original appearance. Uses original lens & reflector. Clear.
(8.991-15) \$51.00 PR

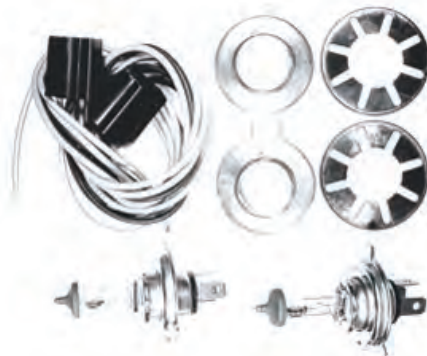

110185A. 31-39
Halogen bulb. 12v headlight conversion. Double the light of a sealed beam, retains original appearance. Uses original lens & reflector. Clear.
(8.991-15) \$40.75 PR

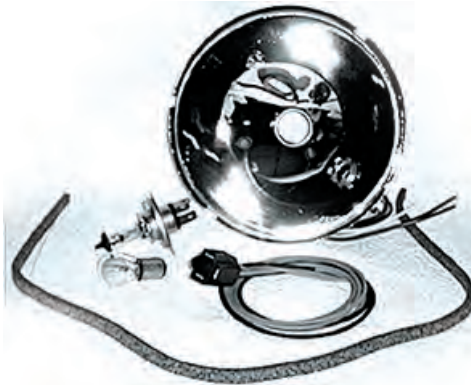

920773L. 37-39
Reflector w/ clear halogen headlight bulb & clear park light bulbs (6v). Trim to fit. (2.734-15) \$127.50 PR



920773K. 37-39
Reflector w/ clear halogen headlight bulb & amber park light bulbs (12v). Trim to fit. (2.734-15) \$122.75 PR

Headlight Lens



110185J
7in. crystal replacement glass. Curved lens with halogen H4/ HB2, 60/55 watt bulb. 12V, replaces H6017 or H6024.
(2.727-15) \$36.75 EA

Tri-Bar Headlight Cover-Blue Dot



193142TB
Blue Dot. Fits 7 inch headlights.
(2.731-15) \$9.00 EA

Returns require a return authorization number, Please call.

Section 90T: Headlight Components, Frenched Kits, Halogen Conversions, Rims, Seals & Switches
 Format = Part No., Year, Description, Original Chevrolet Parts Book Group No., Price and Unit of Measure.



Tri-Bar Headlight Cover-Chrome Bullet



193142TC
 Chrome Bullet. Fits 7 inch headlights.
 (2.731-15)\$8.25 EA

Headlight Visors



193142D. 47-54
 Chrome plated.
 (2.731-15) \$16.00 PR



193142B. 47-54
 Chrome plated w/ blue dot jewel.
 (2.731-15) \$16.25 PR



193142A. 47-54
 Chrome half moon.
 Covers top 1/3 of headlight.
 (2.731-30) \$9.25 PR



193142AM. 47-54
 Amber acrylic with chrome trim plate.
 Fits 7 inch round headlights.
 (2.731-15) \$12.00 PR



193142BL. 47-54
 Blue acrylic with chrome trim plate.
 Fits 7 inch round headlights.
 (2.731-15) \$12.00 PR



193142GR. 47-54
 Green acrylic with chrome trim plate.
 Fits 7 inch round headlights.
 (2.731-15) \$12.00 PR



193142RE. 47-54
 Red acrylic with chrome trim plate.
 Fits 7 inch round headlights.
 (2.731-15) \$12.00 PR

Note: Headlight Knobs see Sections 340T.

Headlight Bucket Assembly



5932796D. 47-54
 Complete w/ original style pigtail (plastic wires in cloth loom), retainer & 12v bulb (no rim).
 (2.726-0) \$69.00 EA



5932796C. 47-54
 Complete w/ pigtail, retainer & 12v bulb, no rim.
 (2.726-15) \$51.00 EA

Headlight Lens

923344. 37-39
 Glass replacement lens.
 (2.727-0) ... \$29.00 EA

Headlight Bucket



924535. 41-54
 Inner bucket only. Steel (also 55 6volt).
 (2.726-15) \$36.00 EA

Headlight Wire Grommet



5931584. 47-54
 Bucket for pigtail (2 pcs).
 (9.775-20) \$4.00 PR

Headlight Grommet



3673139. 47-53
 Fender inner panel.
 (9.775-40) \$4.00 SET

Pad-Headlight Bucket



5933134. 41-46
 Headlight bucket to fender.
 (2.544-20) .. \$16.00 PR

Gasket-Headlight Bucket



3722121. 47-54
 Headlight bucket to fender.
 (2.722-20) .. \$5.00 PR

Headlight Stand Mounting Pad



476489. 37
 (2.544-40) \$8.00 L&R



597992. 38
 (2.544-40) \$8.00 L&R



350910. 39-40
 (2.544-40) \$8.00 L&R

90T

Providing part numbers speeds up your order, improves accuracy and helps us maintain low prices.

See Illustration Index for core charge information and a list of abbreviations. For Body Model information, see Section 5T.



Section 90T: Headlight Components, Frenched Kits, Halogen Conversions, Rims, Seals & Switches

Format = Part No., Year, Description, Original Chevrolet Parts Book Group No., Price and Unit of Measure.

Clutch Head Screws



5932796A 47-54
With tin u-nuts, attach headlight bucket to fender (32 pcs). (2.726-20) \$13.25 SET

Clutch Head Driver



DRIVER All
Magnetic driver w/ 5 bits (1/8in., 5/32in., 3/16in., 1/4in., 5/16in.) with Chev's imprint. (8.821-15) \$22.25 SET

Headlight Bucket Spring



924551 41-46
Tension adjusting.
(2.721-20) . \$5.50 EA
5937452 47-54
Tension adjusting.
(2.721-30) . \$6.00 EA

Headlight Rim



921514 36-39
Chrome (36 car, 37-39 trucks exc COE). Does not come with tab or screw (2.728-15) . . . \$29.75 EA
5930416 40
Chrome reproduction.
(2.728-15) \$28.00 EA
5930416N 40
Chrome (2.728-0) . . . \$35.00 EA



924722 41-46
Chrome (2.728-15) . . \$25.00 EA



5941285 47-54
Door w/ clips.
Stainless steel.
(2.728-15) \$17.00 EA

Headlight Lens Seal



605918 32-39
2 pieces. (2.735-20) . \$6.25 PR



5930594A 40-54
Headlight rim to sealed beam retainer (2.735-15) \$10.75 SET



5930594C 40-54
W/ wire insert headlight rim to retainer (2.735-30) . . \$16.00 PR

Headlight Rim Seal Clip



5934791 37-39
Does 2. (2.746-30) . . . \$6.25 SET

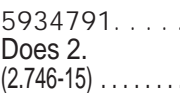

5934791 40-54
Does 2.
(2.746-15) \$8.25 SET

Sealed Beam Retainer Ring



5930433 40
Stainless repro.
(2.731-15) \$14.00 EA



924534 41-54
(2.731-15) \$14.75 EA

Screws-Sealed Beam Retainer Ring



924622 40-54
Retainer screws (3 pcs) (2.729-40) \$2.25 SET

Terminal Boards

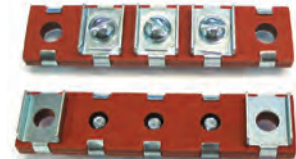

2-3/8" center to center

1865535 40-53
(3 terminal) main wiring to headlight & park light pigtails w/ rivets. Mounting holes: 2-3/8" center-to-center.
(2.56-15) \$20.00 PR

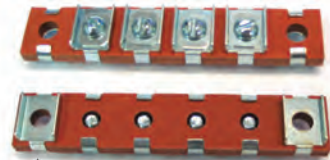

3" center to center

1998756 40-54
(4 terminal) main wiring to headlight & park light pigtails w/ rivets. Mounting holes: 3" center-to-center.
(2.56-15) \$24.00 PR

Note: Headlight bulbs see Section 100T.

Headlight Switch



1995040 30-46
Replacement (2.485-30) \$20.00 EA



1995040A 30-46
Delco original replacement, w/ removable shaft. Black knob, white "LIGHTS" text. (2.485-15) \$70.00 EA

Returns require a return authorization number, Please call.



1994007 39
 Genuine Delco, NOS.
 (2.485-15) \$85.00 EA



1995041S 47-54
 6 Volt. Superior. Uses original nut, knob & removable shaft. Includes spade terminals (for units w/ locking groove at end of shaft). (2.485-0) \$40.00 EA



1995041T 47-54
 12 Volt. Superior. Uses original nut, knob & removable shaft. Includes spade terminals (for units w/ locking groove at end of shaft). (2.485-15) \$47.00 EA

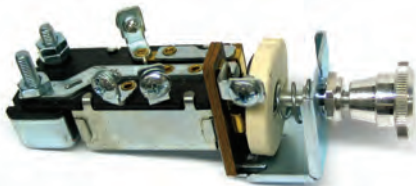

1995041A 47-54
 Replacement, nonremovable shaft.
 12volt. (2.485-20) \$19.50 EA



1995041R 47-54
 Superior. Uses original nut, knob & removable shaft. Includes spade terminals (for use w/ units with locking groove at end of shaft). (2.485-30) \$60.00 EA

Headlight Switch Shaft



3653818S 47-54
 Removable type. (2.485-30) \$5.00 EA

Headlight Switch Retaining Nut



1995041C 47-54
 Stainless (2.485-15) .
 \$8.00 EA

Dimmer Switch

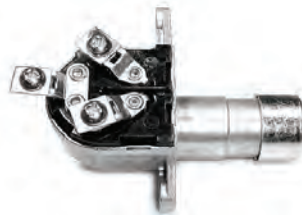

1997008 29-54
 (2.459-15) \$10.00 EA

Headlight Relay



1116789A 37-54
 6v (2.485-15) \$30.00 EA



1116789B All
 12v (2.485-0) \$40.00 EA

Odds & Ends

Please call for availability on all Odds & Ends parts; once part is sold, it may no longer be in stock.

1997853 All
 Auxiliary lamp switch on-off (9.774-0)
 \$40.00 EA
 925203U 41-46
 Headlight assembly left. No park light
 (Used) (2.725-0) \$100.00 EA
 925204U 41-46
 Headlight assembly right no park light
 (Used) (2.725-0) \$100.00 EA
 5933136U 41-46
 Headlight bucket, right side (Used) (0-0) \$60.00 EA
 193142N All
 Headlight cover, NOS black with red
 plastic jewel (2.731-40) . . . \$30.00 EA
 1116789U 37-54
 Headlight Relay 6v used (2.485-0) . . . \$20.00 EA
 350966U 39-40
 Headlight stand, right side (Used)
 (2.546-40) \$60.00 EA
 1995041U 47-54
 Headlight Switch (2.487-40) \$95.00 EA
 1995041 47-54
 Headlight Switch (2.487-0) \$135.00 EA

90T



Section 100T: Light Bulbs (Incandescent & LED) and Sealed Beams

Format = Part No., Year, Description, Original Chevrolet Parts Book Group No., Price and Unit of Measure.

Halogen Headlight Conversion-Bulb



110185C 31-39
Headlight bulb.
Clear Halogen, 12v,
H4 replacement.
(8.991-40) . \$9.00 EA



110185B 31-39
Headlight bulb.
Clear Halogen, 6v.
(8.991-15) \$18.50 EA

Bulbs-Halogen



145416F 37-54
Halogen tail light
& park light w/ turn
signal, 6v, dual filament, straight pin,
replacement for #1158. (8.991-15) . . .
\$17.00 EA



145416B 37-54
Halogen tail light
& park light w/
turn signal, 12v,
dual filament, 55/5 watt, offset pin,
replacement for #1157. (8.991-15) . . .
\$14.00 EA



145416G
Halogen tail light
& park light w/ turn
signal, 12v, dual
filament, 55/5 watt, straight pins,
replacement for #1156. (8.991-15) . . .
\$15.25 EA



145416C 37-54
Halogen tail light
& park light, 6v 50
watt, single filament,
straight pin. (8.991-40) . . . \$15.25 EA



145416D 37-54
Halogen tail light
& park light, 6v 20
watt, single filament,
straight pin. (8.991-15) . . . \$17.00 EA



145416E
Halogen tail light
& park light w/ turn
signal, 6v, dual
filament, offset pin,
replacement for #1154. (8.991-15) . . .
\$17.00 EA



145416H
Halogen tail light &
park light, 12v 50
watt, single filament,
straight pin. (8.991-40) . . . \$12.25 EA



145416I
Halogen tail light &
park light, 12v 20
watt, single filament,
straight pin. (8.991-15) . . . \$12.25 EA

Bulbs -LED

Note: LEDs are very directional and need to be angled correctly to be bright. Minimal current draw.



145416ALED6A . . .
6v, offset pins.
Replaces bulb #1157.
Use LED flasher
#3713382L. (8.991-15) . . . \$15.00 EA



145416LED6A
6v, straight pins.
Replaces bulb #1156.
Use LED flasher
#3713382L. (8.991-15)
\$15.00 EA



145416J
12v, offset pins.
Replaces bulb #1157.
Use LED flasher
#3713382L. (8.991-15) . . . \$15.25 EA



145416K
12v, straight pins.
Replaces bulb #1156.
Use LED flasher
#3713382L. (8.991-15) . . . \$12.25 EA

Turn Signal Flasher -LED



3713382L
12v. For use w/ LED
lights (3 prong). LOW
LOAD. (2.892-30) . . .
\$16.75 EA



3713382L2
12v. For use w/ LED
lights (2 prong). LOW
LOAD. (2.892-30) . . .
\$16.75 EA

Headlight Bulbs



110185 31-39
Headlight bulb. 6 volt.
(8.991-40) \$12.25 EA

Headlight



193142 40-54
Sealed beam 6v. (2.727-0) \$12.25 EA



5947212 All
Sealed beam 12v. (2.727-0) \$4.25 EA

Bulbs



142303 All
Tail light or license
light. Fits some Sedan
Delivery tail lights.
#63-6v. (8.991-15) . . .
\$1.50 EA



142303A All
Tail light or license
light. Fits some Sedan
Delivery tail lights.
#98-12v. (8.991-15) . . .
\$2.00 EA



145416 All
Tail light & stop light
#1154-6v. (8.991-15)
\$1.75 EA



145416A All
Tail light & stop light
(bright) #1157-12v w/
offset pins. (8.991-30)
\$1.00 EA



145417 All
Brake and turn
signal. Dual element
6v w/ equal height
retaining pins. #1158.
(8.991-15) \$4.00 EA

Returns require a return authorization number, Please call.

Section 100T: Light Bulbs (Incandescent & LED) and Sealed Beams



Format = Part No., Year, Description, Original Chevrolet Parts Book Group No., Price and Unit of Measure.

-  145419 All
Brake and turn signal. Dual element 12v w/ equal height retaining pins. #1176.
(8.991-15) \$3.00 EA
-  115273 All
High beam indicator & ignition lock lamp #51-6v. (8.991-15) \$1.25 EA
-  115273A All
High beam indicator & ignition lock lamp #53-12v. (8.991-15) \$1.25 EA
-  125588 All
Parking (in head lamp) instrument panel, clock, glove box, dome light, Cabriolet tail light indicator #55-6v.
(8.991-15) \$1.50 EA
-  125588A All
Parking (in head lamp) instrument panel, clock, glove box, dome light, Cabriolet tail light indicator #57-12v.
(8.991-20) \$1.50 EA
-  453138 All
Dome lamp #210-6v (2 contacts). (8.991-20) \$6.50 EA
-  453138A All
Dome lamp #1004-12v (2 contacts). (8.991-15) . \$1.50 EA
-  119434 All
Dome lamp #82-6v (2 contacts). (8.991-15) \$2.00 EA
-  119434A All
Dome lamp #90-12v (2 contacts). (8.991-20) \$2.00 EA
-  120406 All
Dome lamp #88-6v (2 contacts). (8.991-15) \$6.50 EA

-  120406A All
Dome lamp #94-12v (2 contacts). (8.991-20) \$3.00 EA
-  119294 All
Dome & stop lamp #87-6v (1 contact) w/ straight pins.
(8.991-15) . \$2.50 EA
-  119294A All
Dome & stop lamp #93-12v (1 contact) w/ straight pins.
(8.991-20) . \$2.50 EA
-  142306 All
Dome lamp (panel) #81-6v (1 contact).
(8.991-15) . \$1.50 EA
-  142306A All
Dome lamp (panel) #89-12v (1 contact).
(8.991-15) . \$1.50 EA
-  142309 All
Fog, back up & safety light #1133-6v.
(8.991-15) . \$3.50 EA
-  145431 All
Safety light-spotlight #1323-6v. (8.991-15) \$11.00 EA

Spotlight

- 
- 456720 All
6in. sealed beam, 12v, #4435.
(9.773-15) \$20.50 EA
- 444279 All
6in. sealed beam, 6v, #4535.
(9.773-20) \$34.25 EA
- 451927 All
5in. sealed beam, 12v, #4405 (fits unity spotlight only).
(9.773-15) \$19.25 EA
- 987264 All
5in. sealed beam, 6v, #4515.
(9.773-20) \$34.25 EA

Driving Light

- 
- 987263 All
6in. sealed beam. Clear, 12v, #4412.
(9.774-20) \$16.50 EA
- 
- 986942 All
6in. sealed beam. Clear, 6v, #4012.
(9.774-20) \$24.50 EA
- 593837 All
5in. sealed beam. Clear, 12v, #4415.
(9.774-20) \$16.50 EA
- 3936674 All
5in. sealed beam. Clear, 6v, #4015.
(9.774-20) \$32.75 EA

Fog Light

- 
- 987263A All
6in. sealed beam, amber, 12v, #4412A.
(9.774-15) \$23.25 EA
- 986942A All
6in. sealed beam, amber, 6v, #4012A.
(9.774-15) \$46.25 EA
- 593837A All
5in. sealed beam, amber, 12v, #4415A.
(9.774-15) \$23.25 EA
- 3936674A All
5in. sealed beam, amber, 6v, #4015A.
(9.774-20) \$38.00 EA

100T



Section 110T: Tail lights, LED Lights, Flush Mount Kits, Blue Dots, License Lights, Backup Lights

Format = Part No., Year, Description, Original Chevrolet Parts Book Group No., Price and Unit of Measure.

LED Bed Roll Light



MAK102864
Red LEDs. Billet aluminum w/ polished bezel. Dual intensity for tail light and brake/ turn signal. Includes 10" pigtail. Fits 40-66 Chevy, 40-87 GMC. (0-15)\$110.00 PR



LEDBEDLITE
Aluminum housing in 15/16" (red only), 1-1/8", 1-1/4" or 1-5/8" diameters. Choose Amber or Red. (0-0) \$110.00 PR



MAK102865
Amber LEDs. (0-15)\$110.00 PR

Bed Roll Light



MAK102853 41-66
Red. Incandescent bulb (amber also available). (0-0) \$60.00 PR

Bed Roll Reflector



MAK102850. 41-66
red insert reflector.
(0-15) \$35.25 PR

LED Bed Roll Light -Reverse Light



MAK102866
White LEDs for back up lights.
(0-15)\$120.00 PR

Bulbs -LED 6 Volt

Note: LEDs are very directional and need to be angled correctly to be bright. Minimal current draw.



145416LED6R
6 volt. Red, straight pin. Replaces bulb #1156. Use LED flasher #3713382L.
(8.991-15) \$15.00 EA



145416LED6W
6 volt. White, straight pin. Replaces bulb #11556. Use LED flasher #3713382L.
(8.991-15) \$18.00 EA



145416ALED6R . . .
6 volt. Red, offset pin. Replaces bulb #1157. Use LED flasher #3713382L. (8.991-15)

\$15.00 EA



145416ALED6W . . .
6 volt. White, offset pin. Replaces bulb #1157. Use LED flasher #3713382L.
(8.991-15) \$18.00 EA

(8.991-15) \$18.00 EA

Bulbs -LED 12 Volt



145416L
12 volt. Red, offset pin. Replaces bulb #1157. Use LED flasher #3713382L. (8.991-15)

\$15.25 EA



145416M
12 volt. Red, straight pin (single contact). Replaces bulb #1156.

Use LED flasher #3713382L. (8.991-15)
\$12.25 EA

LEDs typically require electronic flashers. See section 80T for available LED flashers.

Blue Dots



920626A
W/ chrome ring (you install).
(2.682-20)\$6.25 PR

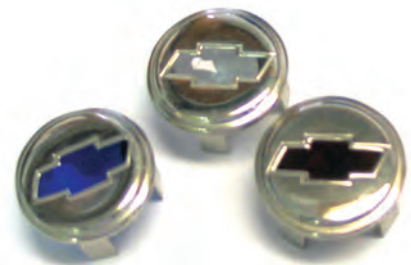

920627
Chrome with colored Bowtie. Specify color: Blue, Amber, Clear or Red. Fits blue dot hole. (2.682-40) \$22.25 PR

Returns require a return authorization number, Please call.

Section 110T: Tail lights, LED Lights, Flush Mount Kits, Blue Dots, License Lights, Backup Lights
 Format = Part No., Year, Description, Original Chevrolet Parts Book Group No., Price and Unit of Measure.



Tail Lights

The following tail lights & components are grouped together by year. Restoration items first followed by street rod parts as direct fit upgrades. Complete assemblies precede individual components.

1934-39 Tail Light



913823B 34-39
 Glass w/ Bowtie
 (2.682-15) . \$23.75 EA



913823 34-39
 Lens (2.682-20)
 \$11.50 EA



913825 34-39
 Rim. Chrome With
 Bowtie center. (2.681-0)
 \$17.50 EA



913824 34-39
 Gasket, lens. (2.684-15)
 \$2.00 EA

1937-39 Tail Light



916642 31-39
 Complete unit. Glass lens, black
 housing (exc Panel & Suburban).
 (2.679-15) \$67.25 EA

1940-53 Tail Light Assembly



927074GL 40-53
 W/ script glass lens. Left side.
 (0.554861111-20) \$28.00 EA
 985608GR 40-53
 GLASS script lens, BLACK housing &
 chrome rim. Right side.
 (0.554861111-20) \$28.00 EA



927074L 40-53
 W/ plastic lens. Left side.
 (2.679-15) \$27.25 EA
 985608R 40-53
 W/ plastic lens, right.
 (2.679-20) \$27.00 EA
 927074BL 40-53
 W/ glass lens and blue dot. Left side.
 (2.679-20) \$39.00 EA
 985608BR 40-53
 W/ glass lens & blue dot. Right side.
 (0.554861111-20) \$39.00 EA
 927074CL 40-53
 Chrome w/ script glass lens. Left side.
 (0.554861111-15) \$31.75 EA
 985608CR 40-53
 Chrome w/ script glass lens. Right side.
 (2.679-15) \$31.75 EA
 927074DL 40-53
 Glass lens w/ blue dot and chrome
 housing. Left side.
 (0.554861111-15) \$40.75 EA
 985608DR 40-53
 Chrome, glass w/ blue dot. Right side.
 (2.679-15) \$40.75 EA



927074FL 40-53
 Red LED tail/ brake light with
 STAINLESS steel housing. Left
 side w/ white LED license light.
 (2.679-15) \$39.75 EA



5933830 40-53
 Tail light rim, 4in. x
 2-3/4in. (2.681-15)
 \$7.00 EA



5937162 40-53
 Tail light lens.
 Plastic, 4in. x 2-3/4in.
 (2.682-20) . . \$6.75 EA



920626 40-53
 Tail light lens. Original
 script, glass, 4in. x
 2-3/4in. (2.682-30)
 \$11.75 EA



920626B 40-53
 Tail light lens. Glass w/
 blue dot, 4in. x 2-3/4in.
 (2.682-15) . \$14.50 EA



920625 40-53
 Gasket, tail light
 lens, 4in. x 2-3/4in.
 (2.684-30) . . \$1.75 EA

110T

Providing part numbers speeds up your order, improves accuracy and helps us maintain low prices.

See Illustration Index for core charge information and a list of abbreviations. For Body Model information, see Section 5T.



Section 110T: Tail lights, LED Lights, Flush Mount Kits, Blue Dots, License Lights, Backup Lights

Format = Part No., Year, Description, Original Chevrolet Parts Book Group No., Price and Unit of Measure.

1947-53 Tail Light Assembly -Panel & Suburban (optional)

Note: Tail light parts below fit Panels & Suburbans w/ 3in. O.D. round, bullet-shaped dual tail lights.



916877C 47-53
Chrome housing, red lens.
(2.679-15) \$83.50 EA



916877 47-53
Primered housing, red lens.
(2.679-15) \$78.00 EA



916877CLRC 47-53
LED. Chrome housing w/ Clear lens &
Red LED. (2.679-15) \$104.00 EA



916877CLR 47-53
LED. Chrome housing w/ Red lens.
(2.679-15) \$104.00 EA



916877LRC 47-53
LED. Primered housing w/ Red LED &
clear lens. (2.679-15) \$99.00 EA



916877LR 47-53
LED. Primered housing w/ Red lens.
(2.679-15) \$99.00 EA

1947-53 Tail Light -Panel & Suburban (optional)



920696LRR . . . 39-53
Red LEDs & reflector
for 3" tail light (fits
LED units above only).
(2.682-15) . \$26.50 EA



920696LLR . . . 39-53
RED lens for 3" LED
tail light. Fits 39-52 car
or 47-53 trucks (fits
LED units above only).
(2.682-15) . \$2.00 EA



916877F 39-52
Housing. Fiberglass w/o inner
bucket. 3in. round. Needs rim
cutouts (fits '40-'52 Sedan Delivery).
(2.679-15) \$58.75 EA



923322 47-53
Rim (3in. round).
(2.681-15) . \$28.00 EA



920696 47-53
Lens, glass (3in.
round). (2.682-20) . . .
\$9.50 EA



920696B 47-53
Lens, glass (3in.
round) w/ blue dot.
(2.682-15) . \$15.50 EA



921872 47-53
Gasket, lens (3in.
o.d., round) (2 pcs).
(2.684-30) . \$3.50 SET

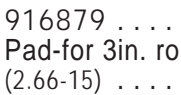

916879 47-53
Pad-for 3in. round tail lights (2 pcs)
(2.66-15) \$12.00 PR

1954 Tail Light Assembly



897711 54
Assembly. Black w/ boot & pigtail.
(2.679-15) \$34.00 EA



897711C 54
Assembly. Stainless w/ boot & pigtail.
(2.679-15) \$50.00 EA

Returns require a return authorization number, Please call.

Section 110T: Tail lights, LED Lights, Flush Mount Kits, Blue Dots, License Lights, Backup Lights

Format = Part No., Year, Description, Original Chevrolet Parts Book Group No., Price and Unit of Measure.



1954 Tail Light



5938745 54
Lens, plastic w/ guide
script. (2.682-20)
\$6.25 EA



918355 54
Rim stainless steel.
(2.681-15) . . \$6.50 EA



914301 54
Gasket, lens. (2.684-15)
\$3.25 EA

Rubber Boot



5933167C . . . 54-57
For tail light pigtail.
(2.596-15) . . \$5.00 EA

Tail Light Pigtails



5291632 54-57
With bulb contacts.
(2.694-15) . . \$7.00 EA

Tail Light Panel & Suburban



5936906 47-56
Lens (Panel, Suburban
w/ doors). (2.682-20) .
\$13.50 EA



5936906B . . . 47-56
Lens w/ blue dot
(Panel, Suburban w/
doors). (2.682-15) . . .
\$16.50 EA



5936907 47-56
Gasket, lens (Panel,
Suburban w/ doors).
(2.684-20) . . \$2.25 EA



5936905 47-56
Gasket, license lens
(Panel, Suburban w/
doors). (2.686-15) \$1.75 EA



3676259 47-56
Pad (Panel, Suburban
w/ doors). (2.66-0) . . .
\$32.75 EA



3686479 47-57
Pad, 4-1/2in. round,
(Panel, Suburban w/
tailgate). (2.66-15) . . .
\$23.50 EA

Tail Light Brackets



602534 34-39
Left. Tail light & license plate.
(2.662-0) \$27.50 EA



602535 34-39
Right (2.662-0) \$26.50 EA



604293 40-46
Left. Tail light & license plate.
(2.662-15) \$26.50 EA



604235 40-46
Right (2.662-15) \$24.50 EA



3847441S 47-53
Left side, tail light & license plate.
Stainless steel. (2.662-15) \$20.50 EA



3696238S 47-53
Right side. Stainless steel.
(2.662-15) \$20.50 EA



3847441E 47-53
Left. Tail light & license plate.
(2.662-15) \$9.25 EA



3847441D 47-53
Left, tail light & license plate. Chrome.
(2.662-15) \$14.25 EA



3696238E 47-53
Right (2.662-15) \$9.25 EA



3696238D 47-53
Right, chrome. (2.662-15) \$13.75 EA



2301905S 54
Left side. Stainless steel.
(2.662-15) \$10.00 EA

110T

Providing part numbers speeds up your order, improves accuracy and helps us maintain low prices.

See Illustration Index for core charge information and a list of abbreviations. For Body Model information, see Section 5T.



Section 110T: Tail lights, LED Lights, Flush Mount Kits, Blue Dots, License Lights, Backup Lights

Format = Part No., Year, Description, Original Chevrolet Parts Book Group No., Price and Unit of Measure.



2034056S 54
Right side. Stainless steel.
(2.662-15) \$10.00 EA



2309105 54
Left, unpainted. (2.662-15) \$5.25 EA



2304056 54
Right, unpainted. (2.662-15) \$5.75 EA



2309105C 54
Left, chrome. (2.662-15) \$7.75 EA

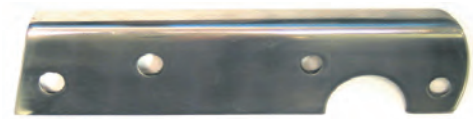

2304056C 54
Right, chrome. (2.662-15) \$7.25 EA

1940-53 License Light Lens



920634 40-53
License light lens (glass).
(2.685-15) \$14.50 EA



920634P 40-53
License light lens (plastic).
(2.685-20) \$6.50 EA



920808 40-53
Gasket (2.686-40) \$2.50 EA



827925 40-53
Retainer clips & screws, license light lens. (2.691-15) \$5.00 SET



923315 40-53
Screws for tail light rim. Stainless steel (2 pcs). (2.688-30) \$0.75 SET

Switch



924160 All
Fog light, backup light, etc, rotary. Clamps to dash bottom. (9.774-20) \$20.00 EA

License Plate Bracket



3707021 54-59
Includes license light rear.
(2.705-15) \$51.75 EA

License Light Pad



3688071 54
Pickup w/ rear bumper.
(2.702-20) \$9.75 PR

Back Up Light



5938297 50-52
Lens, glass includes gasket #5935956
(2.697-15) \$20.00 SET



5935956 50-52
Back up lens gasket
(2.697-15) . \$4.25 SET

Wire Conduit



985608SCL 40-53
19in. length, Stainless Steel line.
(2.679-15) \$8.25 EA



985608SCS 40-53
12in. length, Stainless Steel line. (2.679-15) \$6.25 PR

Odds & Ends

Please call for availability on all Odds & Ends parts; once part is sold, it may no longer be in stock.

920626U 37-52
Lens-Tail Light (Glass) . (-0) \$10.00 EA

5539547U 54-57
License light lens used (2.685-0) \$10.00 EA

3847313U 47-53
Tail light Assy. Center. Fits Panel (10*000-0) \$60.00 EA

04960 55-57
Tail light Assy. Round lens w/ bracket (10*000-0) \$35.00 EA

913823B 31-35
Taillight Lens (glass) W/bowtie (2.682-0) \$19.00 EA

Returns require a return authorization number, Please call.

Section 120T: Fuel System, Gas Tanks, Gas Tank Sending Units, Fuel Pumps, Carburetors, Air Cleaners & Intake Manifolds

Format = Part No., Year, Description, Original Chevrolet Parts Book Group No., Price and Unit of Measure.



Gas Tank

Oversize shipping charges apply to all Gas Tanks. Please call for rate.

605240 41-46
Stainless steel w/ anti slosh baffle,
1/2Ton. Holds 24.5 gallons. (3.001-0) .
\$740.00 EA

3692400 47-53
Stainless steel w/ anti slosh baffle. Fits
47-48 1/2T truck & 47-54 1/2T Panel.
Holds 13.5 gallons. 23-3/4" L x 12-1/2"
W x 13" H. (3.001-0) \$740.00 EA



605239 All
Fits under bed. Universal mount.
27.75in. x 17.75in. x 8.5in. Holds
17.5 gallons (straps not included).
(-0) \$215.00 EA



3847690 47-53
Under bed, frame rail mount. Bed
fill tank with baffles. 19 gallons.
(3.001-15) \$325.00 EA

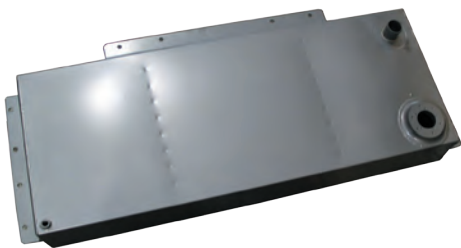

3708964 54-55
Under bed, frame rail mount. Bed
fill tank with baffles. 19 gallons.
(-15) \$325.00 EA

Gas Tank Fill Hose Kit



3684410C 49-57
CHROME. Kit comes complete with
hoses, clamps, neck, cap & grommet.
(3.003-15) \$80.25 SET

Fenton Intake 2 Carb



3836071E 50-62
2 carb intake kit. Includes linkage and
fuel kit to install from existing fuel
line. For 235ci & 261ci (261ci uses
235ci carbs, w/ 2-15/16" bolt spacing).
No grinding required to fit headers.
(3.265-15) \$200.00 EA

3687540B 50-62
Install kit. Includes
bellcrank, throttle rod
& spring. (3.579-15) \$40.00 EA

838573B 50-62
Heat kit. Header to
Fenton dual intake.
235ci only. (3.64-15) .
\$40.00 EA

Offenhauser Intake 2 Carb



3836071B 37-53
Dual carb. Fits 216ci. Uses 216ci
carbs with 2-5/8in. bolt spacing.
Linkage included (carb only!).
(3.265-15) \$250.00 SET

3836071A 50-62
Dual carb. Fits 235ci. 261ci uses 235ci
carbs with 2-15/16in. bolt spacing. Linkage
included (carb only!).
(3.265-15) \$250.00 SET

Offenhauser Intake 3 Carb



3836071D 37-53
Triple carb. Fits 216ci. Uses 216ci carbs
with 2-5/8in. bolt spacing. Linkage
included (carb only -verify firewall
clearance!). (3.265-15) \$270.50 SET

3836071C 50-62
Triple carb. Fits 235ci. 261ci uses 235ci
carbs with 2-15/16in. bolt spacing.
Linkage included (carb only -verify firewall
clearance!).
(3.265-15) \$270.50 SET

Air Cleaner Assembly



PAT-AIR95
9-1/2" dia. Stainless steel.
Complete w/ filter and base clamp.
(3.41-0) \$60.00 EA

1528725S
Smooth. Complete w/
4in. filter and base
clamp. (3.41-15)
\$10.25 EA

1528725L
Louvered. Complete
w/ 4in. filter and base
clamp. (3.41-15)
\$10.25 EA

120T

Providing part numbers speeds up your order, improves accuracy and helps us maintain low prices.

See Illustration Index for core charge information and a list of abbreviations. For Body Model information, see Section 5T.



Section 120T: Fuel System, Gas Tanks, Gas Tank Sending Units, Fuel Pumps, Carburetors, Air Cleaners & Intake Manifolds

Format = Part No., Year, Description, Original Chevrolet Parts Book Group No., Price and Unit of Measure.



1528725MS
Complete with 4in. filter, base clamp & 3 prong spinner. Smooth housing. 2-5/8in. neck. (3.41-15) . . \$13.25 EA



1528725ML
Complete with 4in. filter, chrome louvered housing, base clamp & 3 prong spinner. Smooth housing. 2-5/8in. neck. (3.41-15)

\$13.25 EA

Adapter-Air Cleaner



1528725A
2-5/8in. to 2-5/16in. to fit air cleaners. (3.41-15) . . . \$1.00 EA

Air Filter Element



1528725E
4in. replacement for air cleaner assemblies (#1528725S & 1528725L). (3.41-15) **\$3.75 EA**

Clamp-Air Cleaner



1528725C
Replacement for base of 4in. air cleaner (#1528725S & #1528725L). (3.41-30) \$1.25 EA

Line Clamp - Stainless

Lokar Line Clamps are stainless steel and come with machine and sheetmetal screws. For securing electric, brake, fuel or transmission lines.



13274
3/16" single (12 clamps). (8.95-15) **\$17.00 SET**

13277
1/4" single (12 clamps). (8.95-15) \$17.00 SET

13278
5/16" single (12 clamps). (8.95-15) \$17.00 SET

13279
3/8" single (12 clamps). (8.95-15) \$17.00 SET

13280
1/2" single (12 clamps). (8.95-15) \$17.00 SET

13281
5/8" single (8 clamps). (8.95-15) \$17.00 SET

13282
3/4" single (8 clamps). (8.95-15) \$17.00 SET

13283
7/8" single (8 clamps). (8.95-15) \$17.00 SET



13276
3/16" x 3/16" double (6 clamps). (8.95-15) **\$17.00 SET**

13285
1/4" x 1/4" double (6 clamps). (8.95-15) \$17.00 SET

13286
5/16" x 5/16" double (6 clamps). (8.95-15) \$17.00 SET

13287
3/8" x 3/8" double (6 clamps). (8.95-15) \$17.00 SET

13288
1/2" x 1/2" double (6 clamps). (8.95-15) \$17.00 SET

13289
5/8" x 5/8" double (4 clamps). (8.95-15) \$17.00 SET

13290
3/4" x 3/4" double (4 clamps). (8.95-15) \$17.00 SET

13291
7/8" x 7/8" double (4 clamps). (8.95-15) \$17.00 SET



13275
3/16" x 3/8" combination (6 clamps). (8.95-15) **\$17.00 SET**

13284
5/16" x 3/8" combination (6 clamps). (8.95-15) \$17.00 SET

Clamp



120521
1/4in. bolt-on strap. For wire or tube (4 pcs). (8.95-40)

\$2.75 SET



120521B
3/8in. bolt-on strap. For wire or tube (4 pcs). (8.95-40) \$2.75 SET



120521A
5/16in, insulated bolt-on strap. For wire or tube (4 pcs). (8.95-40)

\$2.75 SET

Voltage Reducer



1119004
12v conversion. Best for fuel gauge. Hi-Tech w/ constant volts.

(2.5-15) \$18.50 EA

Returns require a return authorization number, Please call.

Section 120T: Fuel System, Gas Tanks, Gas Tank Sending Units, Fuel Pumps, Carburetors, Air Cleaners & Intake Manifolds
 Format = Part No., Year, Description, Original Chevrolet Parts Book Group No., Price and Unit of Measure.



Fuel Stabilizer

Keep fuel fresh. Removes water, cleans carburetors & fuel injectors. Protects engine from gum, varnish, rust, and corrosion. Eliminates need to drain fuel before storage. Special dispenser bottles measure exactly without waste. Contains NO alcohol.



111801B.
 POR-15 stabilizer.
 Treats up to 48 gals (3
 ozs. per gal). 1 pint.
 Treats for a minimum
 2 years. (3.001-15) . . .
 \$12.25 EA



111801.
 STA-BIL stabilizer.
 8 oz bottle treats 20
 gallons. Treats up to 1
 year. (3.001-15)
 \$7.50 EA

Gas Tank Restoration Kit



PORTANK
 Restore and maintain gummed
 up tanks. Cleaner, metal prep,
 sealer, fuel preservative/ stabilizer
 and complete instructions.
 (3.001-0) **\$68.25 EA**

Metal Prep



PORMETAL.
 Water based,
 OSHA approved
 biodegradable
 solution. 1 quart.
 (3.001-15) . \$16.50 EA

Gas Tank Cleaner



PORCLEAN
 1 quart. (3.001-15) **\$11.00 EA**

Gas Tank Sealer



3657942B.
 Seals gas tank.
 Recommended for new
 tanks. Impervious to
 all fuels. (3.001-0) . . .
 \$34.50 QT

Sealer Slosh



3657942C.
 Seals gas tank.
 Alcohol resistant.
 Recommended for new
 tanks. (3.001-15)
 \$30.00 QT

Gas Tank-Die Stamped

Oversize shipping charges apply to all Gas Tanks. Please call for rate.



3657515. 37-46
 Steel, like original. Under seat mount.
 18 gallons (3 larger than original).
 (3.001-15) \$350.00 EA



476972. 37-46
 Tank straps. (3.001-0) \$40.00 PR

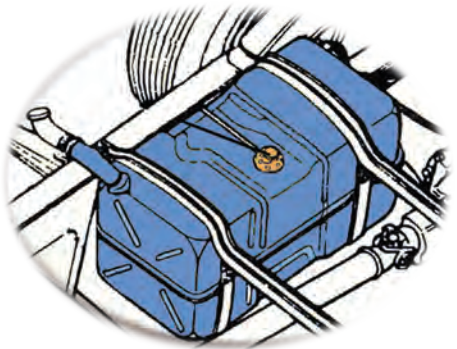

3708924. 47-55
 Steel, like original. Fits 47-48
 1/2Ton, 49-55 Panel, Suburban &
 Canopy Express. 13" wide x 24"
 long (plus 5/8" flange) x 13-1/2" tall.
 (3.001-15) \$350.00 EA

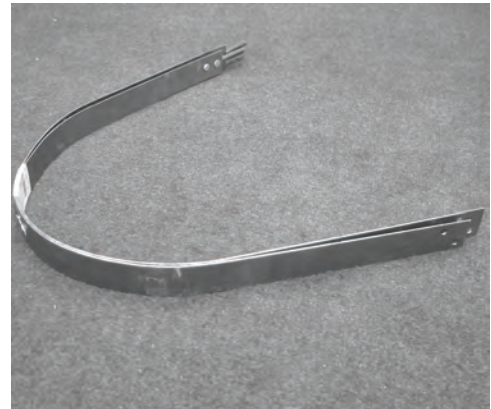

3693463B. 47-55
 Tanks straps. (3.022-15) \$34.50 PR



3708971. 49-54
 Behind seat, galvanized (like original).
 17 gallons. (3.001-15) \$189.25 EA

120T

Providing part numbers speeds up your order, improves accuracy and helps us maintain low prices.

See Illustration Index for core charge information and a list of abbreviations. For Body Model information, see Section 5T.



Section 120T: Fuel System, Gas Tanks, Gas Tank Sending Units, Fuel Pumps, Carburetors, Air Cleaners & Intake Manifolds

Format = Part No., Year, Description, Original Chevrolet Parts Book Group No., Price and Unit of Measure.

Gas Tank Mounting Bracket



3690133B 49-55
With straps. (3.022-15) \$70.00 PR

Tank Straps



3658213A. All
Universal, no
hardware included. 42"
L x 1-3/8" W. (3.022-15)
\$16.00 PR

Gas Tank Mounting Pad



3690131. 39-46
4 pieces. (3.015-15) . .
\$10.50 SET



3690131B. 47-54
Gas tank bumper &
grommet kit (8 pcs).
(3.015-15) \$15.00 SET

Gas Tank Sending Unit



1518225K. 41-54
With gasket and screws. Correct
ohms for Chevy gauges. 6v or 12v
passenger cars (exc. SDL & WGN).
(3.107-15) \$50.00 EA

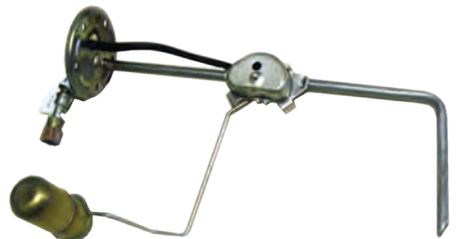

1517500. 49-55
Correct ohms for Chevy gauges (6v
or 12v). Brass float. Will fit 47-55 w/
modifications. (3.107-15) \$40.00 EA

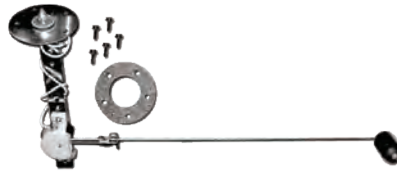

1516250
W/ screws, gasket & instructions,
correct ohms (0-30) for Chev gauges
(6v or 12v). Adjustable float (plastic)
height. (3.107-15) \$25.00 EA

Float

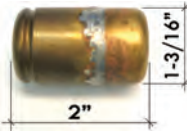

3708954. 47-59
Brass, for gas tank
sending unit. (3.107-20)
\$9.00 EA



1516250A. All
Cork. For gas tank
sending unit (2 floats).
(3.107-30) . \$6.25 SET

Terminal Boot



1516252. All
Sending unit wire boot.
(3.107-15) . \$15.00 EA

Gasket -Gas Tank Sending Unit



1516061. 31-54
Gasket, gas tank
sending unit (3.112-30)
\$2.25 EA

Screws



1516061A. All
Screws for sending
unit (zinc). (3.112-40).
\$4.00 SET

Intermediate Fuel Line

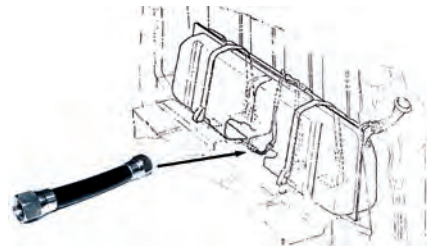

3711160. 49-54
Intermediate line between main line
and sending unit at tank. 7" length.
(0-15) \$13.00 EA

Gas Tank Fill Hose Kit



3684410. 49-57
Kit comes complete with hoses,
clamps, neck, cap & grommet.
(3.003-15) \$60.00 SET

Fuel Filler Neck



3684410F. 47-48
47-48 1/2 ton. (3.003-15) \$16.50 EA



3684410P. 47-55
47-55 Suburban & Panel.
(3.003-15) \$18.50 EA

Grommet -Gas Filler



3800461. 39-46
Panel & Suburban.
(3.008-15) . \$12.00 EA



598847. 38-46
Rubber. 42-46 also
use pad #3674211
(below). (3.008-15). . .
\$12.00 EA

Returns require a return authorization number, Please call.

Section 120T: Fuel System, Gas Tanks, Gas Tank Sending Units, Fuel Pumps, Carburetors, Air Cleaners & Intake Manifolds

Format = Part No., Year, Description, Original Chevrolet Parts Book Group No., Price and Unit of Measure.



3674211 42-46
Flange, held by
4 screws & metal
retainer. Use with
grommet #598847
(above). (3.008-15) . .

\$10.50 EA



3606433 47-48
(3.008-15) . . \$8.00 EA



3807278 47-54
Panel & Suburban.
(3.008-20) . . \$9.00 EA



3807281 49-54
(3.008-20) . . \$8.50 EA

Hose -Gas Tank Filler



3654570 37-48
GM script with clamps exc COE.

(3.003-30) \$10.25 SET

3654570 49-57
GM script with clamps (panel, suburban &
school bus chassis).

(3.003-30) \$10.25 SET

3692531 49-57
& vent hose GM script w/ clamps
(conventional cab).

(3.003-20) \$9.00 SET

Hose -Fuel Line



609742 All
1/2in. ID sold by the inch

(3.003-40) \$0.25 IN

Clamp-Gas Filler Hose



111619 49-57
For 1-3/8in. i.d. gas filler hose.

Original, conventional cab (2 pcs).
(1.166-30) \$5.50 SET

3834073B 37-57

For 2-1/4in. i.d. gas filler hose, original.
Fits Panel, Suburban, Bus & 37-46 exc
COE (2 pcs).

(3.003-40) \$4.00 SET

Gas Caps



985076A 37-57
Locking with Bowtie. Inside flange.

(3.028-15) \$40.00 EA



595857 28-57
Non-locking, polished stainless
steel (like original), w/ inside flange

(3.028-15) \$6.00 EA



595857L 28-52
Locking, chrome w/ inside flange. Not
original item. (3.028-15) \$12.00 EA

Grommet-Gas Gauge Wire



3653742 51-54

Gas gauge wire,
1/8in. I.D. X 1in. O.D.
(9.775-15) . . \$5.00 EA

Fuel Filter



986640AC 33-56
Genuine AC. Complete
assembly w/ glass
bowl & filter. (3.89-15)
\$36.50 EA

986640 33-56
Complete assembly w/ glass bowl and
filter. (3.89-15) \$24.00 EA



5451937 33-56
Replacement element
(not for fuel pump
filter). (3.89-15)
\$7.25 EA

Gasket-In Line Filter Bowl



5452822 37-57
Gasket, inline filter
bowl. 2-7/16" (3.89-30)
\$2.00 EA

Gasket-Fuel Pump



5590039 37-56
Fuel pump filter bowl
gasket, 2-1/4in. o.d.
(3.904-30) . . \$2.25 EA

120T

Providing part numbers speeds up your order, improves accuracy and helps us maintain low prices.

See Illustration Index for core charge information and a list of abbreviations. For Body Model information, see Section 5T.



Section 120T: Fuel System, Gas Tanks, Gas Tank Sending Units, Fuel Pumps, Carburetors, Air Cleaners & Intake Manifolds

Format = Part No., Year, Description, Original Chevrolet Parts Book Group No., Price and Unit of Measure.

Mounting Gasket-Fuel Pump



838263 37-57
Fuel pump mounting
gasket (3.932-30)
\$1.75 EA

Glass Bowl



1523094 37-55
Fuel pump (1-15/16in.
i.d.) w/ gasket
(3.903-20) . \$9.25 SET

Fuel Pump



5592627 37-51
W/ metal bowl (3.9-15)
\$36.00 EA



1523429 37-51
W/ glass bowl (3.9-15)
\$58.00 EA



1523429R 37-51
REBUILT, w/ glass
bowl (3.9-20)
\$90.00 EA



5591457 37-51
W/ vacuum pump
(glass bowl) stops
slow wipers, original
accessory. Also fits
GMC. (3.9-15)
\$125.00 EA



5591457M 37-51
W/ vacuum pump
(metal bowl) (3.9-15) .
\$89.00 EA



5592627M 52-57
W/ metal bowl (3.9-15)
\$50.00 EA



5592627GR . . . 52-57
REBUILT, w/ glass
bowl (3.9-20)
\$90.00 EA



5592675M . . . 52-57
W/ vacuum pump
(metal bowl) stops
slow wipers, original
accessory. (3.9-15) . .
\$90.00 EA



5592675 52-57
W/ vacuum pump
(glass bowl) stops
slow wipers, original
accessory. (3.9-15) . .
\$125.00 EA

Fuel Pump Rebuild Kit

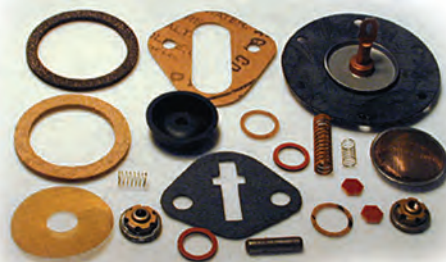

5592945 37-51
Without vacuum pump
(3.901-15) \$40.00 EA



5591844 37-51
W/ vacuum pump (3.901-15) .. \$65.00 EA



5592988 52-57
Without vacuum pump
(3.901-15) \$40.00 EA

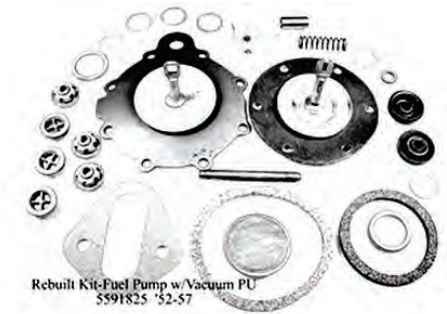

5591825 52-57
W/ vacuum pump (3.9-15) \$64.00 EA

Air Filter Element



1529264 37-54
Complete (3.41-15) \$28.50 EA



1529264A 37-54
Copper mesh only. (3.41-15) .. \$12.75 EA

Note: Air Filter Decals see Section 550T.

Wing Nut



120240 37-54
Air filter wing nut
(8.92-40) . . . \$1.50 EA

Returns require a return authorization number, Please call.



Carburetor

Note: All Carburetors are rebuilt units for Chevrolet applications (not GMC). Raw finish (not painted). Ran and tuned prior to shipment.

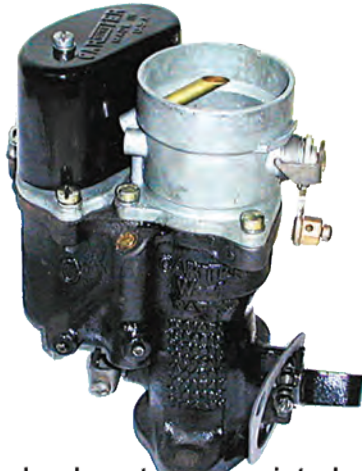

3692429C 49
 Carter W-1 (\$150 core).
 (3.725-15) \$170.00 EA



Carbs do not come painted

7004600 49-53
 Rochester. Fits 216ci (\$150 core)
 (3.725-15) \$170.00 EA

Carbs do not come painted



839987 41-48
 Carter W-1 (\$150 core)
 (3.725-15) \$170.00 EA

Carbs do not come painted



7004468 50-59
 Rochester. Fits 235ci (\$150 core).
 (3.725-15) \$170.00 EA

Carbs do not come painted

Carburetor Cleaner



6505259
 16 oz spray can.
 (3.725-0) \$5.00 EA

Carburetor Rebuild Kit

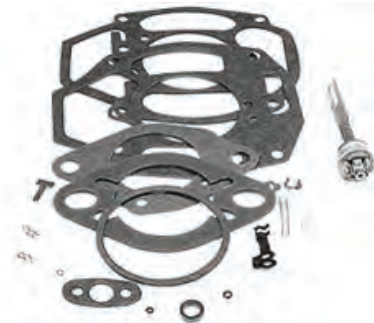

7004363 32-62
 Rochester (3.725-15) \$19.25 EA

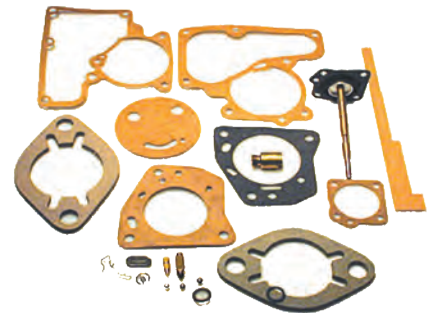

3902169C 37-56
 Fits Carter Y-F, 216ci
 (3.725-15) \$26.50 EA



603978 36-40
 Fits Carter W-1, 216ci engine
 (3.725-15) \$63.00 EA

120T

Providing part numbers speeds up your order, improves accuracy and helps us maintain low prices.

See Illustration Index for core charge information and a list of abbreviations. For Body Model information, see Section 5T.



Section 120T: Fuel System, Gas Tanks, Gas Tank Sending Units, Fuel Pumps, Carburetors, Air Cleaners & Intake Manifolds

Format = Part No., Year, Description, Original Chevrolet Parts Book Group No., Price and Unit of Measure.



609993 41-48
Carter W-1 (216ci) (3.725-15) \$60.00 EA



3692429 49
Carter W-1 (3.725-15) \$65.00 EA

Carburetor Insulator

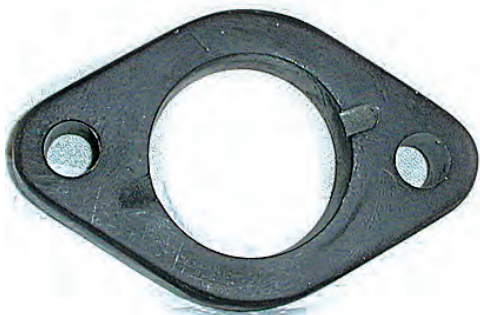

3692797 34-53
Bakelite exc 50-53 235ci
(3.726-20) \$13.25 EA
3692799 50-59
Bakelite (235ci)
(3.726-20) \$13.50 EA
3692797 39-55
Bakelite insulator (GMC).
(3.726-20) \$13.25 EA

Carburetor Base Gasket



601348 34-49
(3.726-15) . . \$1.75 EA

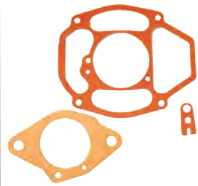

7002377 49-50
Rochester 3pc set,
NORS (3.725-0)
\$3.00 SET



839632 50-53
216ci engine.
2-3/4inch bolt centers.
(3.726-15) . . \$3.00 EA



3712549 50-62
Carburetor base
(235ci, 261ci engine).
3inch bolt centers.
(3.726-15) . . \$2.25 EA

Carburetor Parts



837066 32-49
Spring for idle mixture
screw. Flts Carter W-1
(3.725-30) . . \$0.75 EA

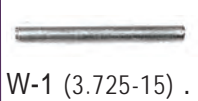

836639 32-49
Float level pin, Carter
W-1 (3.725-15) \$0.25 EA



7002672 37-57
Carburetor float all w/
Rochester (3.745-15) .
\$20.00 EA

Throttle Return Spring



Throttle Return Spring
3650230 '37&'40
3650230 37-40
(3.459-15) \$4.50 EA



3659431 41-49
(3.459-15) \$4.00 EA



3695705 50-59
All 6 cylinder. (3.459-15) \$4.50 EA

Main Fuel Line



348753 37-54
Steel (specify year
when ordering).
(8.964-0) . \$40.00 SET



348753S 37-54
Stainless (specify
year when ordering).
(8.964-0) . \$55.00 SET

product varies by vehicle

*Oversize shipping charges apply.
Please call for rate.*

Fuel Pump to Carb Fuel Line

348754 All
Steel (specify year when ordering).
(8.964-15) \$20.00 SET
348754S All
Stainless (specify year when ordering).
(8.964-15) \$25.00 SET

*Oversize shipping charges apply.
Please call for rate.*

Vacuum Advance Line

217278 All
Carb to distributor. Steel (specify year
when ordering). (8.964-15) \$20.00 SET
217278S All
Carb to distributor. Stainless (specify
year when ordering). (8.964-15)
\$25.00 SET

*Oversize shipping charges apply.
Please call for rate.*

Clip



599119 All
Holds gas & vacuum
lines together, fuel
pump to carburetor
(uses 4) (8.95-30) \$8.75 PR



3735074C All
3/8in. slot, gas, brake
line, wire harness (4
pcs). (8.95-15)
\$4.75 SET



148129A All
Double ended, holds
1/4in. brake & 5/16in.
gas line to frame
(snaps into hole).
(8.95-40) . . \$3.50 EA

Returns require a return authorization number, Please call.

Section 120T: Fuel System, Gas Tanks, Gas Tank Sending Units, Fuel Pumps, Carburetors, Air Cleaners & Intake Manifolds
Format = Part No., Year, Description, Original Chevrolet Parts Book Group No., Price and Unit of Measure.



Gasket-Manifold



602483A 37-53
 Intake & exhaust manifold. Fits 216ci
 (3pcs) (3.27-15) \$11.25 SET
 3707045 50-58
 Intake & exhaust manifold. Fits 235ci &
 261ci (3pcs)
 (3.27-15) \$13.50 SET



838290 37-53
 Rectangle between
 manifolds. Fits 216ci
 (3.272-15) . . \$4.25 EA



3835572 50-62
 Rectangle between
 manifolds. Fits 235ci &
 261ci (3.272-15)
 \$4.25 EA

Sleeves-(Metal)



837273 39-53
 Intake to head 216ci. Exc 50-53 235ci
 (3 piece set) (3.281-20) \$7.00 SET
 3835506 50-62
 Intake to head 235ci, 261ci (3 piece set)
 (3.281-15) \$6.75 SET

Odds & Ends

Please call for availability on all Odds & Ends parts; once part is sold, it may no longer be in stock.

08560 41-46
 Accy. vari-Speed Governor (11-0)
 \$20.00 EA
 7002890 50-51
 Carb Float Bowl, 235ci Rochester
 (NOS) (3.724-40) \$25.00 EA
 700408S 54-57
 Carburetor Kit - 6 Cyl w/ H.T. (3.724-40)
 \$15.00 EA
 05160 49
 Carburetor, Carter We w/ Auto Choke
 (3.724-40) \$195.00 EA
 05280 50-53
 Carburetor, Carter Y-F. For 216ci
 engine (3.725-40) \$175.00 EA
 00907 41-62
 Contact Lever Floating Arm (Points)
 (3-0) \$4.00 EA
 5591843 42-51
 Diaphragm kit. Fuel side, dual pump
 (11-0) \$25.00 EA
 5592876 52
 Diaphragm rebuild kit (NORS). Use w/
 part #559226 (11-40) \$15.00 EA
 5592877 52-55
 Diaphragm rebuild kit (NORS). Use w/
 part #5592627 (11-40) \$15.00 EA
 5592922 52-55
 Diaphragm rebuild kit (NORS). Use w/
 part #5592765 (3.725-40) . . \$15.00 EA
 5591547 42-51
 Fuel & Vacuum Pump (NOS) (3.9-0) . .
 \$90.00 EA
 1573094U 37-55
 Fuel pump glass bowl used (3.903-0) .
 \$10.00 EA
 106 35-55
 Fuel Pump Line To Carb (6 Cyl) NORS
 (11-0) \$5.00 EA
 986640U 33-56
 Gas filter assembly (Used). (3.89-0) . .
 \$10.00 EA
 593306 34-58
 Gas Lines NORS 7in. long (8.964-40) .
 \$15.00 EA
 3835881 37-53
 Intake & exhaust manifold. Fits 216ci.
 (3.601-0) \$175.00 EA

3835527 37-53
 Intake manifold with oil filter. Fits
 216ci. (3.265-0) \$150.00 EA
 839577 41-49
 Metering Rod- Carter W-1 (3.725-15) . .
 \$2.50 EA
 837368 32-49
 Screw- Idle Mixture Carter W-1
 (3.725-15) \$2.00 EA

120T

Providing part numbers speeds up your order, improves accuracy and helps us maintain low prices.

See Illustration Index for core charge information and a list of abbreviations. For Body Model information, see Section 5T.



SANDERSON HEADERS

Small Block Engine

Part #	Year	Type	Steering/Suspension	Head	Price	
						Jet Hot Coated
365790CC2 *	ALL	Tube	Stock (exc. 30-46) R&P or CS (Exc. 49-54)	SP or AP SP or AP	\$225.00	\$375.00
365797CC3	ALL	Tube	R&P or CS (Exc. 30-46) 70-92 Camaro Clip	SP or AP SP or AP	225.00	375.00
365794CC1	ALL	Tube	67-79 Camaro Clip	SP	175.00	325.00
365795AP	ALL	Tube	67-79 Camaro Clip	AP	225.00	375.00
365795HO	ALL	Tube	67-79 Camaro Clip	HO	225.00	375.00
365796QP	ALL	Cast	R&P or CS 67-79 Camaro Clip	SP, AP, HO (Chevy heads only) SP, AP, HO (Chevy heads only)	320.00	480.00
365793QP	ALL	Cast	70-92 Camaro Clip	SP, AP, HO (Chevy heads only)	350.00	510.00

Big Block Engine

Part #	Year	Type	Steering/Suspension	Head	Price	
						Jet Hot Coated
365783BB1	ALL	Tube	R&P or CS	Stock	\$265.00	\$415.00
365785BB2	ALL	Tube	67-92 Camaro Clip	Stock	315.00	465.00
365787QP	ALL	Cast	R&P or CS 67-92 Camaro Clip	Stock Stock	450.00 450.00	610.00 610.00

R&P-Rack & Pinion Steering CS-Cross Steering (Drag link is parallel to tie rod [Vega Style Steering Box])
 SP-Straight Plug AP-Angle Plug HO-High Output



365795HO ALL



365790CC2 ALL



365797CC3 ALL



365795AP ALL



365796 QP ALL
365796 QP ALL
365796 QP ALL



365783BB1 ALL
365785BB2 ALL



365794CC1 ALL

Returns require a return authorization number, Please call.

Section 130T: Exhaust Systems, Headers, Extensions

Format = Part No., Year, Description, Original Chevrolet Parts Book Group No., Price and Unit of Measure.



FULLY POLISHED, BOLT-ON complete stainless steel, dual side-by-side exhaust system to fit 47-55 (1st Series) Chevy & GMC trucks with Fenton headers. No drilling, cutting or modification needed. Comes with everything needed for a quick install: headpipes, "shotgun" tail pipes, dual in & dual out stainless muffler, stainless hangers, stainless clamps and instructions. System runs down driver's side for a neat, clean installation. Installs in less than an hour!!

#3683656FE Complete stainless system ..\$675.

If you don't already have Fenton headers, see details below. Fits 216ci, 235ci & 261ci Chevy engines (#3657963A) and 228ci, 247ci & 270ci GMC engines (#3657963G).

Note: Shipping is typically \$75-\$120. Carefully packaged in 1 large box.

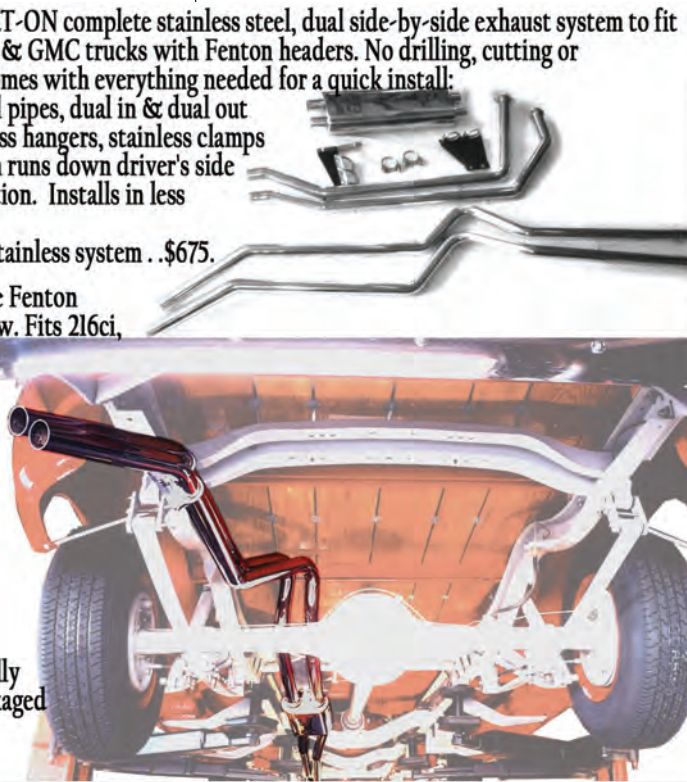

130T

Fenton Headers



3657963A 37-62
Cast iron & being reproduced under license from Fenton for all 1937-62 216ci, 235ci & 261ci engines. Wow! Comes with header flange and gaskets. (3.609-15)\$260.00 PR

3657963G 37-62
GMC, Cast iron & being reproduced under license from Fenton for all GMC 228ci, 247ci, 270ci, & 302ci engines. Wow! Comes with header flange (stamped GMC) and gaskets. (3.609-15)\$260.00 PR

3657963S 37-62
Bolt set for Fenton headers. (3.609-40) .. \$4.75 SET

838573B 50-62
Heat kit. Header to Fenton dual intake. 235ci only. (3.64-15) . \$40.00 EA



3692831
Header pipe to Fenton headers (requires 2). (3.611-20)\$4.25 EA

Tube Headers

tubing is mandrel bent to provide the highest flow possible, and fixture welded to ensure precise fit. Mounting flanges are O-ringed to reduce leakage.



3657963T 37-62
Black painted finish. Includes weld-on header pipe flanges. Fits 1937-62 216ci, 235ci & 261ci. (3.609-15) ... \$150.00 SET



3657963SS 37-62
Polished stainless finish. Includes weld-on header pipe flanges. Fits 216ci or 235ci. (3.609-30)\$237.00 SET

Providing part numbers speeds up your order, improves accuracy and helps us maintain low prices.

See Illustration Index for core charge information and a list of abbreviations. For Body Model information, see Section 5T.



Section 130T: Exhaust Systems, Headers, Extensions

Format = Part No., Year, Description, Original Chevrolet Parts Book Group No., Price and Unit of Measure.

Exhaust System

Note: Complete system includes header pipe gasket, studs and nuts, header pipe spring (1938-42), header pipe, muffler, muffler clamps, muffler hanger, tailpipe and tailpipe hanger as needed. Will not fit GMC.

Note: All pipes are aluminized at no extra charge. Oversize shipping charges apply to all Exhaust Systems. Please call for rate.



599415B	37-40	1/2T (3.705-15)	\$226.00 EA	3696806A	50-53	1/2T (3.705-15)	\$271.50 EA
599397B	37-40	3/4T (3.705-15)	\$226.00 EA	3696806A	50-53	1/2T w/ 235ci. (3.705-15)	\$271.50 EA
3656764B	41-46	1/2T (3.705-15)	\$226.00 EA	3696161A	50-53	3/4T exc double duty. (3.705-15)	\$281.25 EA
3657135B	41-48	3/4T (3.705-15)	\$211.50 EA	3715243A	50-53	1T (3.705-15)	\$267.75 EA
3656962B	41-48	1-1/2T w/ 134-1/2in. wheelbase. (3.705-15)	\$214.00 EA	3692828A	50-53	1-1/2T & 2T 216ci. (3.705-15)	\$224.50 EA
3683656B	47-48	1/2T (3.705-15)	\$226.00 EA	3692828B	50-54	1-1/2T & 2T 235ci. (3.705-15)	\$225.50 EA
3683656C	49	1/2T (3.705-15)	\$226.00 EA	3696806B	54	1/2T (3.705-15)	\$263.75 EA
3657135C	49	3/4T (3.705-15)	\$208.75 EA	3696161B	54	3/4T exc double duty. (3.705-15)	\$263.75 EA
3656962C	49	1-1/2T w/ 134-1/2in. wheelbase. (3.705-15)	\$197.25 EA	3715243B	54	1T (3.705-15)	\$259.75 EA

Gasket-Manifold



602483A 37-53
Intake & exhaust manifold. Fits 216ci (3pcs) (3.27-15) \$11.25 SET



3707045 50-58
Intake & exhaust manifold. Fits 235ci & 261ci (3pcs) (3.27-15) \$13.50 SET



838290 37-53
Rectangle between manifolds. Fits 216ci (3.272-15) . . \$4.25 EA



3835572 50-62
Rectangle between manifolds. Fits 235ci & 261ci (3.272-15) \$4.25 EA

Studs In Manifold



837552B 29-54
For header pipe, 3/8in. x 2in. w/ brass hex nuts (3.275-30)

\$4.75 SET

Heat Riser Spring



602799 37-54
Anti-rattle (3.653-40) . \$7.00 EA



838573 37-54
Thermostat (3.653-40) \$17.25 EA

Heat Riser Shaft



596264A 37-54
Oversize requires reaming worn manifold holes (3.65-15)

\$23.00 EA

Flange Plate



593607 37-53
Holds header pipe to manifold, 216ci (3.61-15) . . . \$7.00 EA



3696988 51-57
235ci, also fits Fenton headers (3.61-15) . . \$9.75 EA

Gasket



593606 37-49
Header pipe to manifold. (3.611-20) . . \$3.50 EA

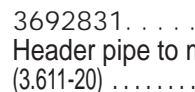

3692831 50-54
Header pipe to manifold. (3.611-20) \$4.25 EA

Spring



368244 32-48
Supports rear of header pipe (exc 40-46 1T & 39-46 utility). (4.827-15) \$6.50 EA

Header Pipe

3652725 37-40	All (3.609-15) \$61.75 EA
3684108 41-48	All (3.609-15) \$61.75 EA
3691277 49	All (3.609-15) \$61.75 EA

Returns require a return authorization number, Please call.

Section 130T: Exhaust Systems, Headers, Extensions



Format = Part No., Year, Description, Original Chevrolet Parts Book Group No., Price and Unit of Measure.

3693712 50-53
All with 216ci motor. (3.609-15)
\$79.75 EA
3693715 50-54
All with 235ci motor. (3.609-15)
\$73.25 EA

Oversize shipping charges apply to all Header Pipes. Please call for rate.

Muffler

603746 35-40
(3.701-15) \$62.25 EA
3656598 41-49
(3.701-15) \$62.25 EA
3693710 50-54
(3.701-15) \$100.25 EA

Muffler Clamp



3693812 37-49
Rear, 1-5/8in. (3.708-20) \$4.50 EA
3693811 50-54
Rear, 1-7/8in.
(3.708-40) \$3.00 EA
3693811 37-49
Front, 1-7/8in.
(3.708-40) \$2.50 EA
3694837 50-54
Front, 2in.
(3.708-30) \$2.25 EA

Muffler Hanger

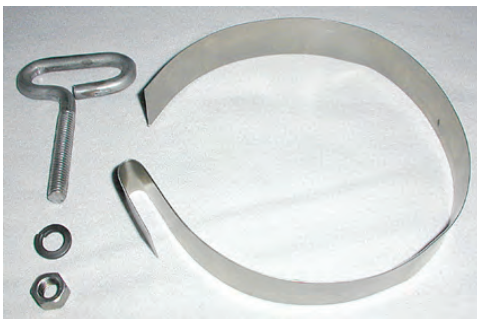

3676257 37-55
(3.704-15) \$7.00 EA

Tailpipe



599415 37-40
1/2T (3.705-15) \$59.50 EA
599397 37-40
3/4T (3.705-15) \$61.75 EA
3656764 41-46
1/2T (3.705-15) \$61.75 EA
3657135 41-49
3/4T (3.705-15) \$61.75 EA
3656962 41-49
1-1/2T w/ 134-1/2in. wheelbase & 1t.
(3.705-15) \$61.75 EA
3683656 47-49
1/2T (3.705-15) \$61.75 EA
3696806 50-54
1/2T (3.705-15) \$61.75 EA
3689574 50-54
Panel, Suburban, Canopy Express.
(3.705-15) \$61.75 EA
3696161 50-54
3/4T exc Double Duty. (3.705-15)
\$61.75 EA
3715243 50-59
1T (3.705-15) \$61.75 EA
3692828 50-54
1-1/2T & 2T, 8-3/8in
long. (3.705-30)
\$23.00 EA

Oversize shipping charges apply on all tailpipes. Please call for rates.

Tailpipe Hanger



3656791 37-54
Correct reproduction. (3.706-0) \$7.50 EA



3656791A 37-54
Replacement. (3.706-15) \$5.00 EA



3658199 41-48
Includes grommet.
(3.706-40) . \$14.50 EA

Tailpipe Heat Shield

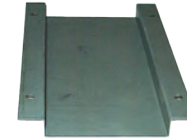

3689481R 37-46
Under bed. (3.706-15)
\$9.25 EA



3689481S 47-54
Under bed. (3.706-15)
\$7.00 EA

Tailpipe Clamp



594135 All
Clamp, original for
tailpipe extension w/
nut & bolt. (3.708-15) .
\$5.50 EA

Exhaust Extension



51A18529P
Plain, Polished Stainless.
(-15) \$15.00 EA



985992A All
Era accessory
stainless steel w/
stamped bowtie.
(3.705-20) . \$21.00 EA



985992C All
CHROME Bowtie
shaped outlet. 2-1/4"
I.D. (not pre-drilled).
(3.705-20) . \$33.25 EA



986885S All
STAINLESS STEEL
Bowtie shape w/
mounting screws.
2-1/4" I.D. (not pre-
drilled). (3.705-15) . . .
\$46.25 EA

130T

Providing part numbers speeds up your order, improves accuracy and helps us maintain low prices.

See Illustration Index for core charge information and a list of abbreviations. For Body Model information, see Section 5T.



Section 130T: Exhaust Systems, Headers, Extensions

Format = Part No., Year, Description, Original Chevrolet Parts Book Group No., Price and Unit of Measure.



98584842-48
Bear Claw shape.
Superb chrome
reproduction of
original. (3.705-15). . .
\$87.75 EA

Paint-Exhaust



3657963FA
Very high temp, flat
aluminum for manifolds
& pipes. 12 oz spray can.
(3.609-15) \$12.50 EA



3657963E
Clear, high temp (1200
degree) for exhaust
etc, 12 oz spray can.
(3.609-15) \$12.50 EA



3657963C
Stainless steel
pigments. For
exhaust manifolds &
pipes. Gives a soft
grey, metallic finish.
(3.609-15) . \$30.00 PT



3657963D
Cast blast high temp 1200
degree. Grey, fresh cast
look for exhaust manifolds,
etc. Rust preventative,
12 oz spray can.
(3.609-15) \$9.50 EA

**NOTE: Hazardous materials such as
paints & cleaners cannot be shipped by
air carrier. Ground shipping only (no
international, Alaska or Hawaii).**

Odds & Ends

*Please call for availability on all Odds
& Ends parts; once part is sold, it may
no longer be in stock.*

602366U37-39
Exhaust Manifold- Good Used (1-0) . .
\$75.00 EA

383588137-53
Intake & exhaust manifold. Fits 216ci.
(3.601-0) \$175.00 EA

83900545-54
Intake manifold for 235ci. (3.265-0) . . .
\$75.00 EA

369416350-57
Intake manifold. Fits all exc 216ci & DD
(Used) (3.609-40) \$65.00 EA

383542449-57
Manifold clamp (3.273-0) . . . \$5.50 EA



1940 Dump Truck—Darren Saari, Duluth, Minnesota

Returns require a return authorization number, Please call.

Section 140T: Clutches & Flywheels

Format = Part No., Year, Description, Original Chevrolet Parts Book Group No., Price and Unit of Measure.

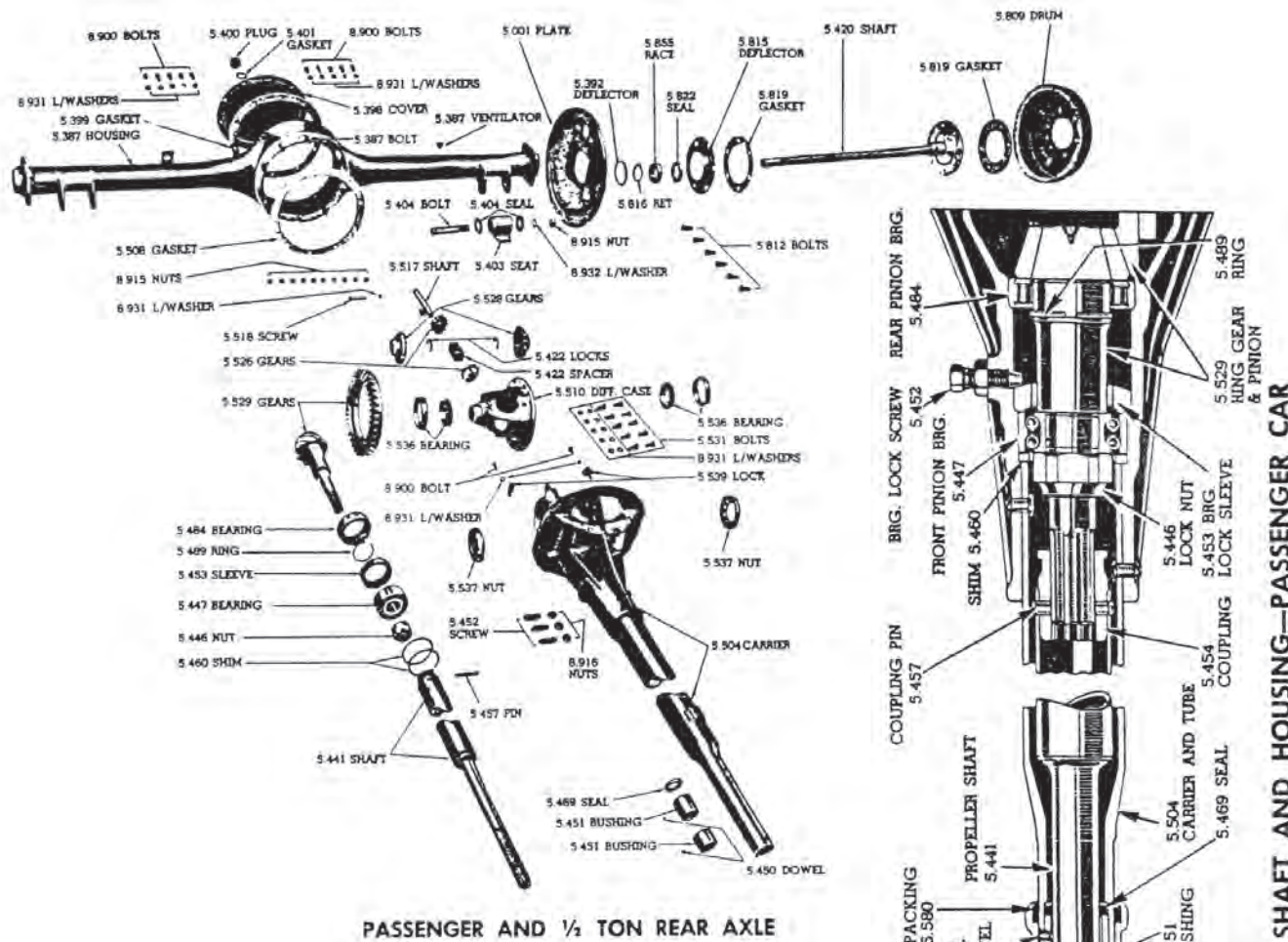

PASSENGER AND 1/2 TON REAR AXLE

PROPELLER SHAFT AND HOUSING—PASSENGER CAR

ILLUSTRATIONS ARE COMPLETE ASSEMBLIES.
SEE TEXT FOR AVAILABILITY.

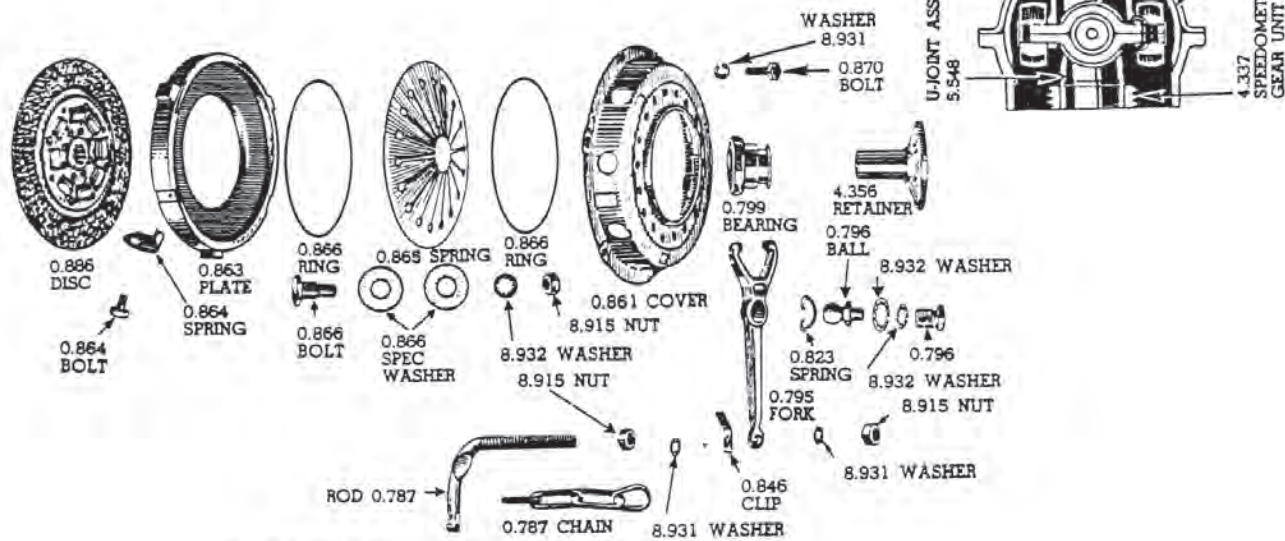

DIAPHRAGM SPRING BOLTED TYPE CLUTCH PARTS

Providing part numbers speeds up your order, improves accuracy and helps us maintain low prices.

See Illustration Index for core charge information and a list of abbreviations. For Body Model information, see Section 5T.

140T



Section 140T: Clutches & Flywheels

Format = Part No., Year, Description, Original Chevrolet Parts Book Group No., Price and Unit of Measure.

Pilot Bearing



90710931-39
(0.649-15) . \$36.25 EA

Pilot Bushing



41256239-66
(0.649-40) . \$5.50 EA

Throwout Arm Ball



2054961C32-37
2 pieces w/o clips or
lockwasher. (0.796-40)
\$15.00 EA



205496138-54
Stud, 1-1/2in. long.
(0.796-40) . \$6.00 EA

Clip



83898731-54
Throwout arm to ball
stud. (0.823-40)
\$6.75 EA

Throwout Bearing



90942238-54
(0.799-20) . \$30.00 EA

Throwout Arm Spring



366488141-46
7-5/16in. (0.844-15) . .
\$10.00 EA



365311447-54
6in. (0.844-15) \$6.25 EA

Clutch Pedal Return Spring



36824432-46
(4.827-15) . \$6.50 EA



369866547-57
Overall length 5-3/4in.
(4.827-20) . \$5.75 EA

Clutch Linkage Rod



367645447-59
Rod 7-1/16in. (1 hook
& 1 eye). (0.787-15) \$10.50 EA



367639847-59
Offset rod (L shape)
2-1/4in. (0.787-15) . . .
\$14.00 EA

Pressure Plate-Rebuilt



83895638-53
9in. (\$50 core). (0.863-15) \$91.25 EA
83894938-53
Heavy duty, 10-3/4in. (\$50 core).
(0.863-15) \$89.00 EA
383671554-57
Use w/ 9in. & 10in. disc (\$50 core).
(0.863-15) \$88.75 EA

Pressure Plate Bolts



838653 All
Shouldered 3/8-16,
1" length, grade 8.
Includes lock washers.
Set of 6. (0.863-15) . .
\$10.00 EA

Pressure Plate Bolt



83975642-60
Mounts flywheel
to crank. 7/16-20,
31/32", grade 8.
Includes lock washers.
Set of 6. (0.669-15) . .

Clutch Disc -Rebuilt



384745038-54
9in. o.d. (\$40 core).
(0.886-20) \$82.50 EA
383548338-53
10-3/4in. o.d. (\$40 core).
(0.886-15) \$79.50 EA
383611954-57
10in. (\$40 core).
(0.886-15) \$49.50 EA

Tool



838956A All
To align clutch disc.
(0.866-40) . \$6.50 EA

Flywheel Ring Gear

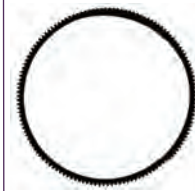

83817737-54
139 teeth (exc
powerglide). (0.667-40)
\$75.00 EA

Please call for availability on all Odds & Ends parts; once part is sold, it may no longer be in stock.

Odds & Ends

3835453N All
Clutch Disc, 10-3/4in. (NOS) Fits
216ci. Truck. (0.886-0) . . . \$75.00 EA
2054960N38-42
Clutch fork screw (NOS) (0.796-0) . . .
\$10.00 EA
383600438-53
Pressure plate shelf worn, rusty. Fits
Pass, 1/2T, 3/4T & Heavy Duty (4.667-0)
\$30.00 EA

Returns require a return authorization number, Please call.

Section 150T: Transmissions, Shifters, Transmission Mounts, Knobs, Shift Boots & Cables

Format = Part No., Year, Description, Original Chevrolet Parts Book Group No., Price and Unit of Measure.

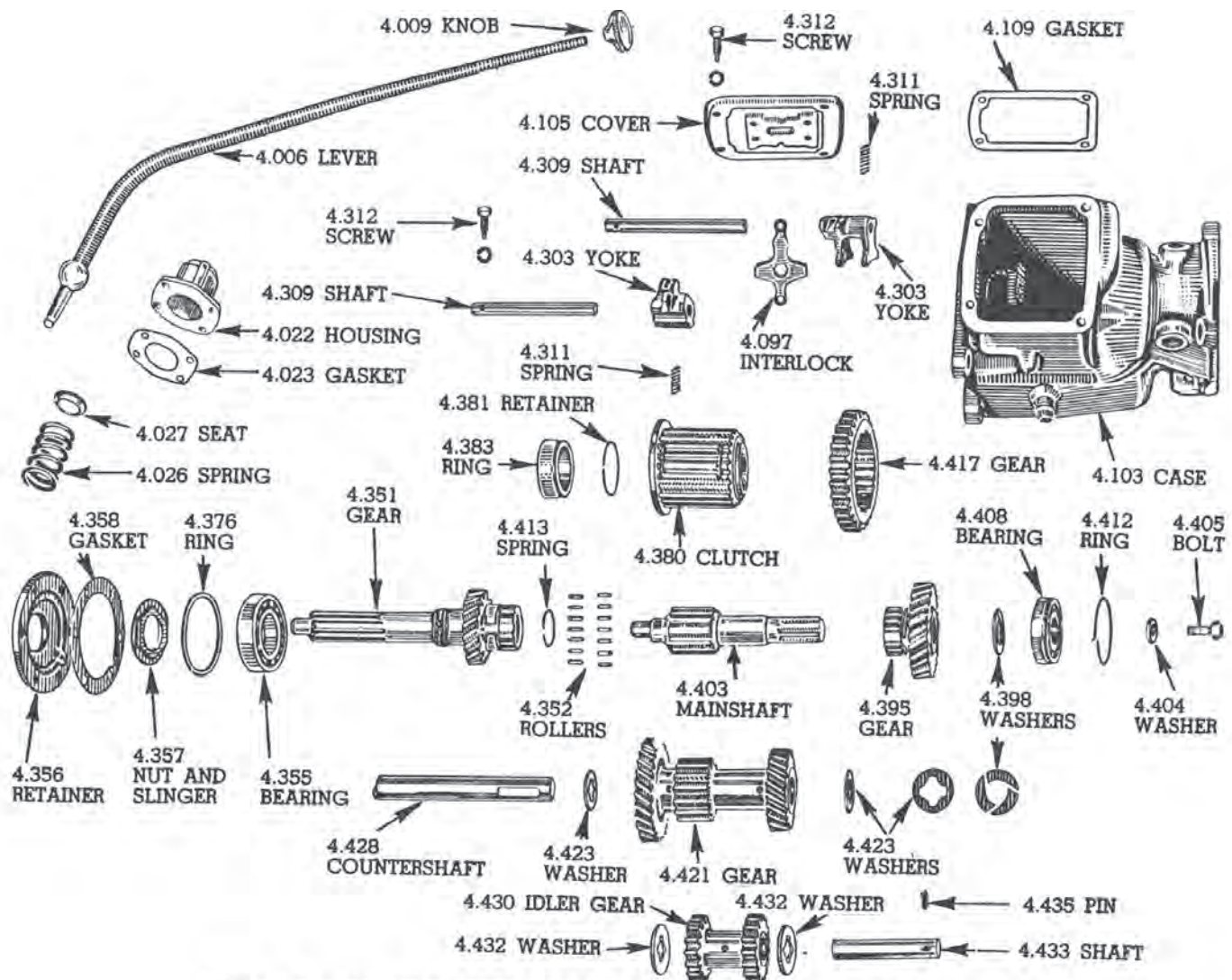

1937-47 SYNCHRO-MESH TRANSMISSION (CENTER GEARSHIFT)

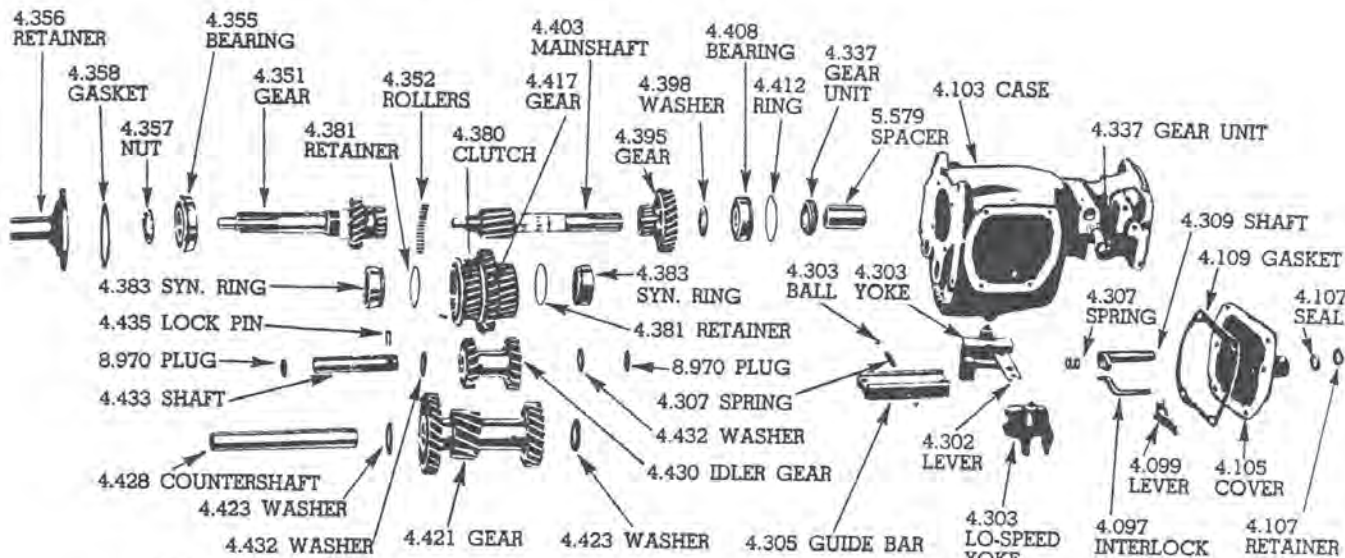

1939-48 PASS. SYNCHRO-MESH TRANSMISSION (STEERING COLUMN GEARSHIFT)

Providing part numbers speeds up your order, improves accuracy and helps us maintain low prices.

See Illustration Index for core charge information and a list of abbreviations. For Body Model information, see Section 5T.

150T



Section 150T: Transmissions, Shifters, Transmission Mounts, Knobs, Shift Boots & Cables

Format = Part No., Year, Description, Original Chevrolet Parts Book Group No., Price and Unit of Measure.

Speedometer Conversion



ERASPEEDO

Unit corrects speedometer on transmissions with electronic speed sensor. Great for any tire/wheel combination on street rod applications. Instructions included. (4.329-15) \$145.00 EA

Line Clamp - Stainless



- 13274
3/16" single (12 clamps).
(8.95-15)\$17.00 SET
- 13277
1/4" single (12 clamps).
(8.95-15)\$17.00 SET
- 13278
5/16" single (12 clamps).
(8.95-15)\$17.00 SET
- 13279
3/8" single (12 clamps).
(8.95-15)\$17.00 SET
- 13280
1/2" single (12 clamps).
(8.95-15)\$17.00 SET
- 13281
5/8" single (8 clamps). (8.95-15) \$17.00 SET
- 13282
3/4" single (8 clamps). (8.95-15) \$17.00 SET
- 13283
7/8" single (8 clamps). (8.95-15) \$17.00 SET



- 13276
3/16" x 3/16" double (6 clamps).
(8.95-15) \$17.00 SET
- 13285
1/4" x 1/4" double (6 clamps).
(8.95-15)\$17.00 SET
- 13286
5/16" x 5/16" double (6 clamps).
(8.95-15)\$17.00 SET
- 13287
3/8" x 3/8" double (6 clamps).
(8.95-15)\$17.00 SET
- 13288
1/2" x 1/2" double (6 clamps).
(8.95-15)\$17.00 SET
- 13289
5/8" x 5/8" double (4 clamps).
(8.95-15)\$17.00 SET

- 13290
3/4" x 3/4" double (4 clamps).
(8.95-15)\$17.00 SET
- 13291
7/8" x 7/8" double (4 clamps).
(8.95-15)\$17.00 SET

Note: Die cut pad & gaskets for floor insert over transmission see Section 320T.

Shift Knob



374993 29-47
3-speed floor shift
push-on. Black.
(4.009-15) .. \$7.75 EA



374993B. 29-54
4-speed screw-on.
Black. (4.009-15)
\$7.50 EA



985099. 37
Brown, accessory.
(4.009-15) . \$31.75 EA



3686898. 47-53
Maroon. (4.009-15) ..
\$6.00 EA



3698233. 54-59
Black (4.009-15).
\$8.00 EA

Floorshift Seal



3653420. 37-47
Floor to transmission
3-speed. (4.015-15) . . .
\$18.75 EA



3687200. 37-54
Floor to transmission
4-speed. (4.015-20) ..
\$5.00 EA

Floor Shift Boot



3651348A. All
Replacement-3 speed
(uses #3654365t trim
ring). (4.015-40).
\$9.25 EA

Trim Ring



3654365T. All
Stainless retains boot
#3651348A. (4.044-15)
\$12.25 EA

Returns require a return authorization number, Please call.

Section 150T: Transmissions, Shifters, Transmission Mounts, Knobs, Shift Boots & Cables
Format = Part No., Year, Description, Original Chevrolet Parts Book Group No., Price and Unit of Measure.



Bushing

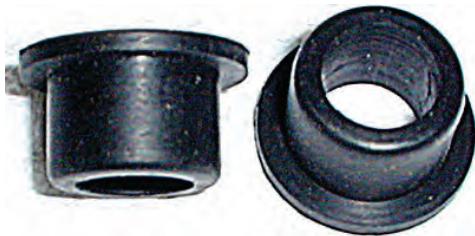

365244 48-53
 Rubber shift rod ends (4 pcs).
 (4.016-20) \$8.50 SET
 365244 54
 Rubber shift rod ends (6 pcs).
 (4.016-20) \$12.50 SET

Bracket-Shift Tube Support



3698234 48-54
 Supports top of shift
 tube under steering
 wheel. (4.018-15) . . .
 \$18.25 EA

Spring & Pivot Pins



3654731 40-57
 Column shift handle
 (fits 40-54 car & 48-57
 truck). (4.025-40) . . .
 \$8.25 SET

Pivot Pins



3653719 40-57
 Column shift handle (2 pcs).
 (4.025-20) \$2.50 PR

Metal Plug



142024 48-54
 In shift box (also 49-54 car).
 (9.008-30) \$1.00 EA

Rubber Bellows



3686796 48-59
 On shift box, base
 of steering column.
 (4.015-40) .. \$6.25 EA

Bearing



435844 37-57
 Front bearing on main
 drive gear. (4.355-15).
 \$24.75 EA



954168 37-54
 Rear of trans case (tail
 shaft). (4.408-15) . . .
 \$30.00 EA

Tailshaft Bushing



3717682 48-54
 Rear of tailshaft, 1/2T,
 4-speed. (4.445-15) ..
 \$16.75 EA

Shift Fork



3845048 49-55
 2nd & 3rd gear (\$15
 core). (4.303-15) . . .
 \$58.25 EA



591660 48-55
 Seal for inside cover,
 3-speed (2 pcs).
 (4.107-15) \$10.50 SET

Transmission Gasket Set



3764394 37-54
 3-speed. (4.005-15) \$16.75 SET



606664 31-47
 4-speed. (4.005-15) \$20.50 SET

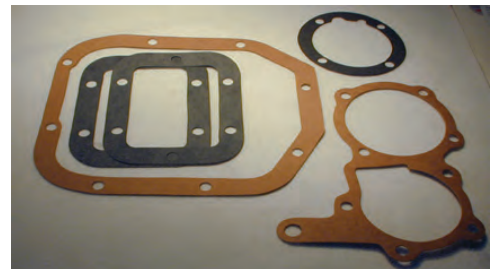

3689458 48-63
 Muncie 4-speed. (4.005-20) .. \$13.50 SET

Reverse Idler Gear



591264 41-47
 4 speed. (4.43-0) \$30.00 EA

Cluster Shaft



591213 40-57
 3 speed roller bearing type. Fits bushing
 w/ modifications. (4.428-0) \$20.00 EA

Bushing



591210 37-53
 Fits bushing-styled
 cluster (2 pcs).
 (4.422-20) \$14.25 SET

Soft Plug



103892 39-48
 End of cluster shaft
 & reverse idler shaft.
 (8.97-40) . . . \$1.00 EA

150T

Providing part numbers speeds up your order, improves accuracy and helps us maintain low prices.

See Illustration Index for core charge information and a list of abbreviations. For Body Model information, see Section 5T.



Section 150T: Transmissions, Shifters, Transmission Mounts, Knobs, Shift Boots & Cables

Format = Part No., Year, Description, Original Chevrolet Parts Book Group No., Price and Unit of Measure.

Small Parts Kit

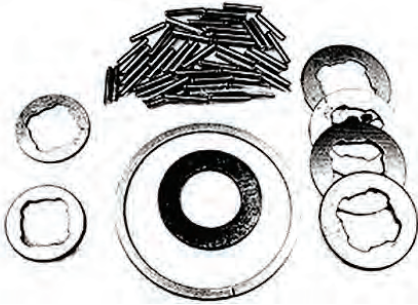

609926 37-54
Thrust washers, needle bearings
(3-speed). (4.004-20) \$45.00 KIT

Transmission Rebuild



591187T 37-54
3 speed rebuild service. Includes
gaskets, bearings and small parts
kit. Other parts extra (please remove
side covers & speedo gears prior to
shipping). Oversized shipping charges
apply. Please call for rates. \$350 core
charge. (4.003-40) \$550.00 EA

Transmission Mount

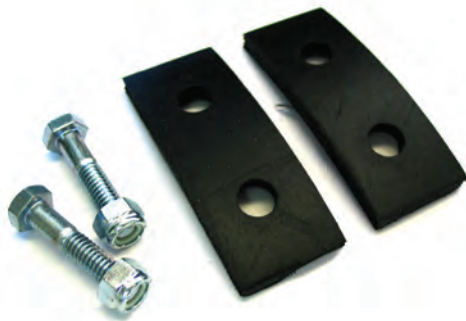

3652730A 37-54
Rebuild kit: Pad & bolts.
(4.081-15) \$8.50 SET



594117 37-39
(4.081-20). \$65.00 EA



3688234 48-53
Steel (4.081-15)
\$75.00 EA

3711049C 42-57
Rubber, for turbo 350, turbo 400, &
400R, 1-hole mount. (4.081-30)
\$10.50 EA

Speedometer Cable



1567793 37-57
W/ original housing assembly exc 1939-
54. (4.342-20) \$34.50 EA
158829 39-54
W/ original metal housing assembly. 70"
length.
(4.342-30) \$35.25 EA



158829P 39-54
W/ plastic housing assembly.
(4.342-15) \$20.50 EA
1588291A 37-57
Cable w/o housing. 85" length (0.130 dia.).
(4.342-15) \$15.50 EA



1565706 37-57
Tip, steel
(speedometer end of,
speedo cable). (4.342-30) . . . \$4.50 EA

Odds & Ends

Please call for availability on all Odds & Ends parts; once part is sold, it may no longer be in stock.

591780 49-54
2 & 3rd Shifter Shaft W Plate (12-40) .
\$12.00 EA
590929N 37-39
2nd Gear-all 3 Speed (12-0) \$35.00 EA
590927 37-39
3-speed (4.421-30) \$160.00 EA
590545 32-36
Bearing - trans main drive gear
(4.355-0) \$45.00 EA
904913 54-55
Bearing 3 Speed, rear trans (COMM)
(4.405-40) \$30.00 EA
142260 37-57
Bearing Center S Front (All 4 speed)
(12*000-40) \$30.00 EA
121856 31-47
Bearing counter shaft rear (4-speed)
(12*000-0) \$20.00 EA
954451 37-39
Bearing diff. side 37-39 all util.
(5.536-40) \$40.00 EA
902100 30-39
Bearing Differential (1/2, 3/4 & 1 Ton)
(05;536-0) \$30.00 EA
954358 48-57
Bearing Front On Main Drive Gear
(4.355-40) \$24.75 EA
954864 48-57
Bearing Main Shaft Rear (4 speed)
(4.408-40) \$30.00 EA
141854 31-47
Bearing Main Shaft Roller. All 4 speed
(4.352-0) \$20.00 EA
905207 41-47
Bearing Propeller Shaft (5.436-40) . . .
\$30.00 EA
3661395U 41-42
Bearing yoke trunnion. Fits 235 (Used)
(12*000-0) \$10.00 EA
954373 31-47
Bearing, Trans, Main Drive Gear ALL
(12*000-0) \$20.00 EA
05560 29-54
Brass insert. Repairs worn trans (13-0)
\$25.00 EA
3663239 39-69
Cap steel front prop shaft (NOS)
(4.341-0) \$20.00 EA

Returns require a return authorization number, Please call.

Section 150T: Transmissions, Shifters, Transmission Mounts, Knobs, Shift Boots & Cables

Format = Part No., Year, Description, Original Chevrolet Parts Book Group No., Price and Unit of Measure.



3687429 48-54 Clamp, Gearshift Selector housing (12*000-40) \$10.00 EA	591113 40-54 Gear. 1st & Reverse sliding (NOS). Exc heavy duty. (4.417-0) \$30.00 EA	3691568N 50-52 Ring-washer torque conv retain NOS (13*000-40) \$6.00 PR
591191 40-57 Cluster gear. 3-speed for roller bearing type. (4.421-30) \$160.00 EA	3705067 37-39 Gear. Transmission main drive for 3-speed. (4.403-0) \$100.00 EA	590517 31-47 Shaft 1st & 2nd speed, all w/ 4 speed (12*000-0) \$10.00 EA
364495 34-37 Clutch Fork NOS (COMM, Utility) (12*000-0) \$25.00 EA	18860 54 Gearshift 1st & Rev Linkage (NOS) (12-0) \$15.00 EA	590853 37-39 Shift Yoke Shaft 1st & Reverse All 3 speed (12*000-40) \$35.00 EA
591603 48-57 Clutch Gear Synchronizing Cone 4 Speed (4.384-40) \$35.00 EA	3686836 48-54 Gearshift Operating Lever & Clamp (12-40) \$12.00 EA	591288 37-54 Synchronizer Energizing Spring. 3-spd, 1-5/16" id x 1-3/8" oc x 7/64" thick (Used). (4.413-0) \$12.00 EA
3692835 50-54 Collar, U-joint Ball 50-54 Pass Powerglide (13-40) \$25.00 EA	591501 48-54 Input shaft COMM & Utility w/ 4 speed (04:351-40) \$25.00 EA	3653607 40 Torque tube U-Joint housing rear (13*000-0) \$35.00 EA
590826 32-40 Counter gear thrust washer (4.423-0) . \$10.00 EA	3686812 48-55 Lever, Gearshift Selector, 2nd & 3rd (4-1/4in) fits 48-52 COMM, 53-55 COMM 1st series exc DD, 55 COMM 3sp 6 cyl 2nd series (4.016-40) \$15.00 EA	591103 40 Trans Case, COMM w/ 3 speed NOS (12*000-0) \$150.00 EA
591667 48-50 Counter Gear, 1st Speed all w/ 4 speed (12*000-40) \$75.00 EA	3688159 49-55 Lever, Gearshift Selector, 2nd & 3rd (5-1/4in overall length), fits 49-54 pass 3sp, 53-55 DD 3sp 1st series, (4.016-40) \$15.00 EA	3692608 48-57 Trans Main Shaft 4 speed (All) (12*000-40) \$65.00 EA
591394 31-57 Counter Shaft Gear Key NOS 4 speed (4.421-0) \$6.50 EA	954869 48-57 Main shaft gear (4.112-40) . \$40.00 EA	590654 32-36 Trans. Synchronizing Drum exc CC & DD (12-40) \$25.00 EA
590620 33-36 Counter Shaft, 3 Speed Exc CC DC EC (12-0) \$15.00 EA	5668232 55-56 Mast jacket bearing assembly, fits COMM & Utility (6.521-40) . \$40.00 EA	591631 48-54 Transmission case. For 3-speed commercial (Used). (4.103-0) \$125.00 EA
357665 54-57 Differential Bearing Adjuster nut (13-000-0) \$25.00 EA	590621 32-36 Oil Slinger, Main Drive Gear (12-0) . . . \$8.00 EA	3686832U 48-50 Transmission inspection cover 3spd (Used) (4.105-0) \$75.00 EA
3652336 40-53 Differential Case, 40-42 COMM, 46-53 1/2T, 53-57 1/2T (5.51-0) . \$150.00 EA	3682372 46-47 Propeller shaft bearing retainer (NOS) (5.439-40) \$20.00 EA	1307238 54-61 Transmission Oil Plug w/ Seal (NOS) (12-40) \$6.00 EA
609951 34-37 Fork Unit Clutch Release COMM & Utility (12*000-40) \$20.00 EA	591620 48-54 Retainer trans Main Drive Bearing (12*000-0) \$30.00 EA	591906 48-57 Yoke, 1st & 2nd Speed All (4sp) (12*000-40) \$30.00 EA
590481 31-37 Front Main Bearing Retainer (12-40) . . \$25.00 EA	591119 40 Retainer trans rear bearing (All 4 speed) (4.317-40) \$45.00 EA	
591298 38-46 Front Main Bearing Retainer 4 speed (12-000-0) \$20.00 EA	3656434N 40-47 Retainer-gearshift Lever Ball 3 Speed (12-40) \$35.00 EA	
954394 46-50 Front pinion bearing. All 1/2T (NOS) (4.355-40) \$50.00 EA	3694491 51-54 Reverse Band Brake Strut, P/g (NOS) (12-40) \$70.00 EA	
591578 48-50 Gear 2nd speed for 4-spd constant mesh (NOS) (4.395-40) \$20.00 EA	590925 37-39 Reverse idler gear for 3 Speed (NOS) (12-40) \$30.00 EA	
590387 29-42 Gear shift lever cap 4 speed (4.015-0) \$25.00 EA	472931 32-36 Reverse idler gear. Fits standard w/ 3-speed. (4.43-0) \$30.00 EA	
590493 31-47 Gear trans High Speed Sliding (12*000-0) \$25.00 EA		

150T

Providing part numbers speeds up your order, improves accuracy and helps us maintain low prices.

See Illustration Index for core charge information and a list of abbreviations. For Body Model information, see Section 5T.



Section 160T: Drive Lines, Oakie Bushings

Format = Part No., Year, Description, Original Chevrolet Parts Book Group No., Price and Unit of Measure.

U-joint Rebuild Kit



609948. 33-53
33-39 4 speed front, rear exc VE, VF;
40 front exc KC, WD; 41-53 front 3/4
exc Double-Duty. (5.548-20) ... \$29.00 EA



609944. 40-54
Fits car & 1/2T. (5.548-15) \$48.75 EA

U-joint Lock Plates



3723489. 40-54
2 plates & 4 bolts.
(5.586-15) \$11.25 SET

U-joint Assembly

602795. 37-39
W/ yokes, 3/4T, 3-speed.
(5.548-15) \$178.50 EA
604373. 40-47
W/ yokes 3/4 & 40 1t 3-speed front.
(5.548-40) \$150.00 EA
3653380. 40
W/ yokes 1-1/2T (exc WD).
(5.548-0) \$153.00 EA



606799. 40-47
W/ yokes 1/2T 3-speed.
(5.548-30) \$175.00 EA
591646. 41-53
W/ yokes 3/4T 3-speed.
(5.548-15) \$178.50 EA
591642. 48-54
W/ yokes 1/2T 3-speed.
(5.548-15) \$190.00 EA

Torque Tube



3723490P. 50-54
Ball seal kit, for drive
shaft. Fits 50-54
cars w/ Powerglide.
(5.572-15) . \$13.75 EA

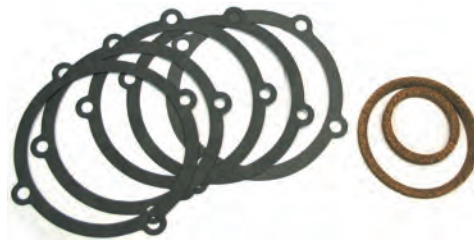

3723490. 29-54
Ball seal kit, for drive shaft 29-40 &
41-54 cars, 1/2T & 3/4T truck w/ manual
trans. (5.572-15) \$13.75 EA

Dowel Pin



347813. 29-50
5/16in. , retains drive shaft bushing.
(5.45-30) \$4.50 EA

Coupling Pin



3657332. 40-54
Drive shaft to pinion.
(5.457-30) \$8.50 EA

Drive Shaft Bushing



596907. 37-53
Front, 3/4T & 38-40 1T.
(5.451-40) . . \$20.00 EA



3652328. 40-50
Rear, 50 1st design.
(5.451-15) . . \$40.00 EA

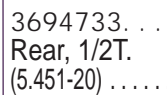

3694733. 51-54
Rear, 1/2T.
(5.451-20) \$30.75 EA

Drive Shaft Seal



595010. 37-39
1/2, 3/4 & 1T. (5.469-15) \$9.50 EA
3691457. 40-50
40 all & 41-50 1/2T. 1" i.d.
(5.469-15) \$12.50 EA

Oakie Bushing

Replaces front & rear drive shaft bushing & seal without disassembling rear end and driveline.



595005B. 37-39
Car, 1/2T, 3/4T & 1T
(5.451-15) \$60.00 EA



3652328B. 40-50
Car, 1/2, 3/4 & 1T. (5.451-15) . \$83.50 EA
3694733B 51-54
Car, 1/2, 3/4 & 1T.
(5.451-15) \$83.50 EA

Returns require a return authorization number, Please call.

Section 160T: Drive Lines, Oakie Bushings



Format = Part No., Year, Description, Original Chevrolet Parts Book Group No., Price and Unit of Measure.



609930A. 40-50
Seal. (5.451-15)
\$5.00 EA

Tool



595005A. 37-54
Drive shaft bushing puller to rent (return
in original condition for \$20 refund).
(5.451-15) \$68.25 EA

Odds & Ends

Please call for availability on all Odds & Ends parts; once part is sold, it may no longer be in stock.

954452 30-39
Bearing Pinion Shaft Front 30-36 PA
(13*000-40) \$30.00 EA
954455 33-39
Bearing Pinion Shaft Front All Utility
(13*000-0) \$75.00 EA
905113 33-35
Bearing-pinion Shaft Front (13-0)
\$20.00 EA
366989 31-38
Lock Ring, Front Prop. Shaft Bearing
(13-40) \$5.00 EA
901105 33-35
Pinion shaft bearing. Rear exc CC
(13-40) \$25.00 EA
370416 33-39
Prop Shaft Bushing, Front (Utility)
(13*000-40) \$20.00 EA

600962 34-40
Prop Shaft Bushing, Front Utility
(13*000-0) \$20.00 EA
365393 40
Prop Shaft Bushing, Rear (Utility)
(13*000-0) \$20.00 EA
3653931 40
Propeller shaft housing bushing front
(13*000-40) \$25.00 EA
3705198 54-57
Rear bearing dust shield (5.438-40)
\$25.00 EA
373526 34-36
Torque tube U-joint housing. Fits
DA,DB (5.664-40) \$20.00 EA
376203 35-39
U-Joint Rear 3 & 4 Speed (13*000-0)
\$165.00 EA
609944N 40-54
U-joint rebuild kit. Fits car & 1/2 ton
truck (NOS) (-0) \$40.00 EA

160T



1946 & 1937 Trucks—Greg McCaffrey, Portola, California

Providing part numbers speeds up your order, improves accuracy and helps us maintain low prices.

See Illustration Index for core charge information and a list of abbreviations. For Body Model information, see Section 5T.



Section 170T: Rear Axles, Bearings & Seals

Format = Part No., Year, Description, Original Chevrolet Parts Book Group No., Price and Unit of Measure.

Ring & Pinion Conversion Kit





3705439A 40-54
 3.55:1 1/2 ton trucks only! Bolt in for 1940-50 (1937-39 requires drive line modifications). 1954 1/2 ton truck needs the correct carrier to install this conversion (spool casting #3652366-40-43, 1/2 ton trucks). Will not fit Canadian spec trucks.
 (5.529-15) \$450.00 SET

Ring & Pinion Installation Kit

3705430KT 40-50
 Gaskets, Seals, Bearings. (5.529-15) . \$475.00 SET
 3705439KT 51-54
 Gaskets, Seals, Bearings. (5.529-15) . \$450.00 EA

Rear Axle Seal

 592441 33-54
 1/2T & 37-42 3/4 & 1T. (5.822-15) . \$25.00 EA
 3663166 41-42
 Except 1/2T. (5.469-15) \$15.00 EA
 3686563 46-57
 3/4 & 1T. (5.822-20) . . \$8.25 EA

Rear Axle Bearing & Seal

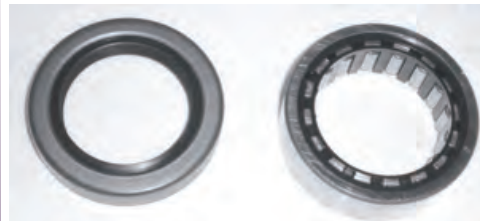

111121B 37-54
 (5.855-15) \$104.25 SET
 188930B 46-57
 3/4 & 1T. (5.855-15) \$76.50 SET

Rear Axle Bearing

 111121 37-54
 1/2T & 37-42 3/4 & 1T. (5.855-15) . \$85.50 EA



188930 46-57
 3/4 & 1T. (5.855-15) \$66.25 EA

Gasket-Axle

 370245 37-59
 Center cover on rear axle, rear gasket, 1/2T & 37-42 3/4 & 1T. (5.399-15) . . \$6.50 EA
 370246 37-59
 Differential to axle housing, front gasket, 1/2T & 37-42 3/4 & 1T. (5.508-15) . . \$4.50 EA

Differential Fill

 344829 29-54
 Plug w/ gasket. (5.4-15) \$6.75 EA

Carrier Bearing



7450385 46-56
 1/2T & 40-42 3/4T & 1T (uses 2). (5.536-15) \$61.25 EA

Pinion Seal

 3653618 40-57
 40 COE, 41-42 1-1/2T & larger (exc 1/2T & 40-55 2-speed). (5.469-15) . \$19.50 EA

Pinion Bearing

 954780 35-54
 Front, Passenger & 1/2T. (5.447-15) \$58.75 EA
 125630 35-54
 Rear. Cars; 35-54 pass & 53-55 Corvette. Trucks; 35-42 COMM, 46-54 1/2 Ton (5.484-15) . \$66.50 EA

Bushing & Bolt W/ Nut

 3652182A 48-54
 Bolt w/ nut, rear end to spring, 1/2T. (5.403-15) \$27.25 PR

Returns require a return authorization number, Please call.



Odds & Ends

Please call for availability on all Odds & Ends parts; once part is sold, it may no longer be in stock.

- 901604 48-50
Bearing counter shaft rear (4-speed)
(4.408-40) \$30.00 EA
- 144535 36
Bearing, inner axle shaft fits 1-1/2 ton
(5.855-0) \$25.00 EA
- 7450385N 46-56
Carrier Bearing- 1/2in. (NOS) w/ race.
(5.536-40) \$60.00 SET
- 364538 33-39
Differential Case 1/2, 3/4 & 1 Ton
(5.51-0) \$150.00 EA
- 3714787 46-57
Differential case 1/2T, 3/4T (5.517-0) .
\$150.00 EA
- 3705430 40-52
NOS ring & pinion (5.529-15)
\$300.00 EA
- 189638 32-36
Rear pinion bearing 2 speed rear axle,
vacuum shift (5.484-0) . . . \$25.00 EA
- 3847057 46-50
Rod assy w/ 2spd rear axle (NOS)
(5.635-0) \$20.00 EA
- 3653928 40-47
Spacer gasket, metal rear wheel hub
w/ 1/2in. axle bolt holes fits utility
(5.811-40) \$10.00 EA
- 3651377 39-41
Stud, shaft to hub cap 2 spd axle 1.5
ton (13*000-40) \$6.00 SET

Is one of these trucks yours?



170T



Section 180T: Brake Parts

Format = Part No., Year, Description, Original Chevrolet Parts Book Group No., Price and Unit of Measure.

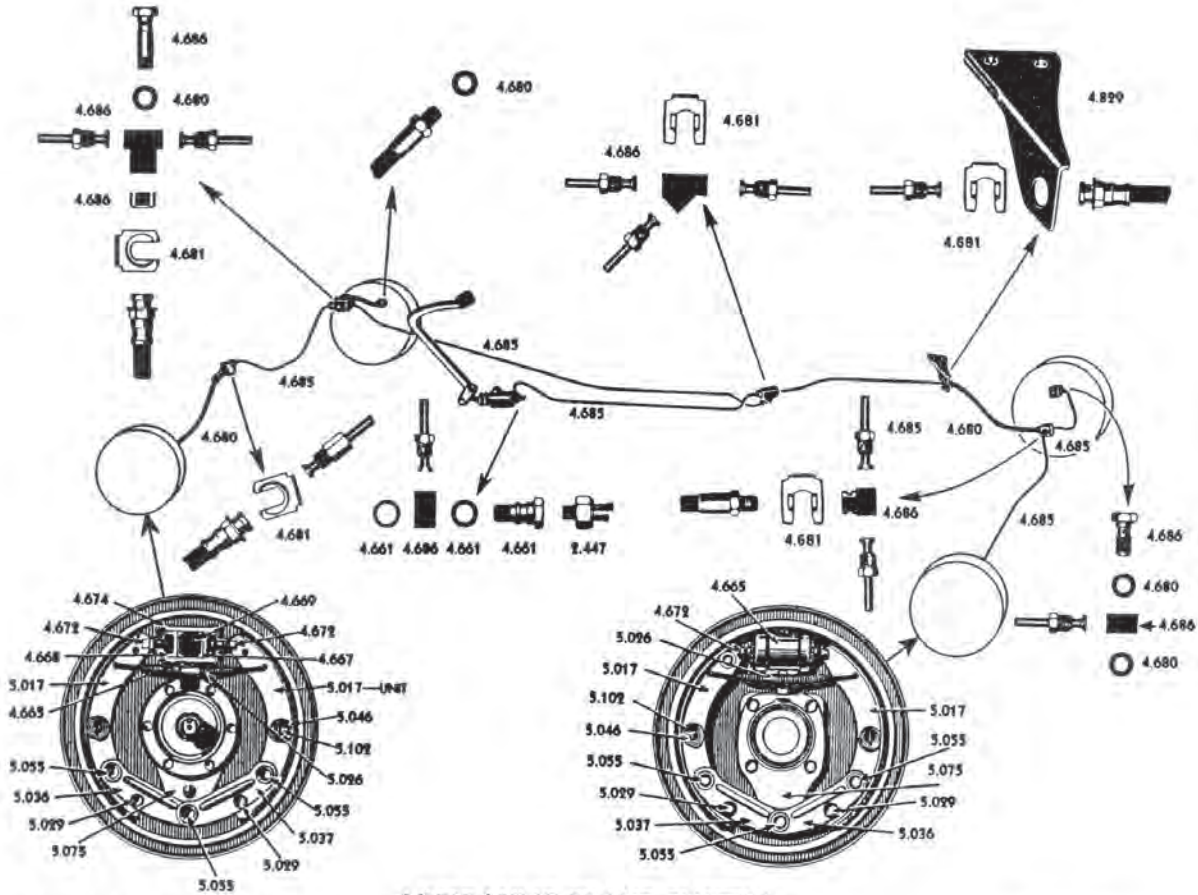

ILLUSTRATIONS ARE COMPLETE ASSEMBLIES. SEE TEXT FOR AVAILABILITY.

HYDRAULIC BRAKE SYSTEM

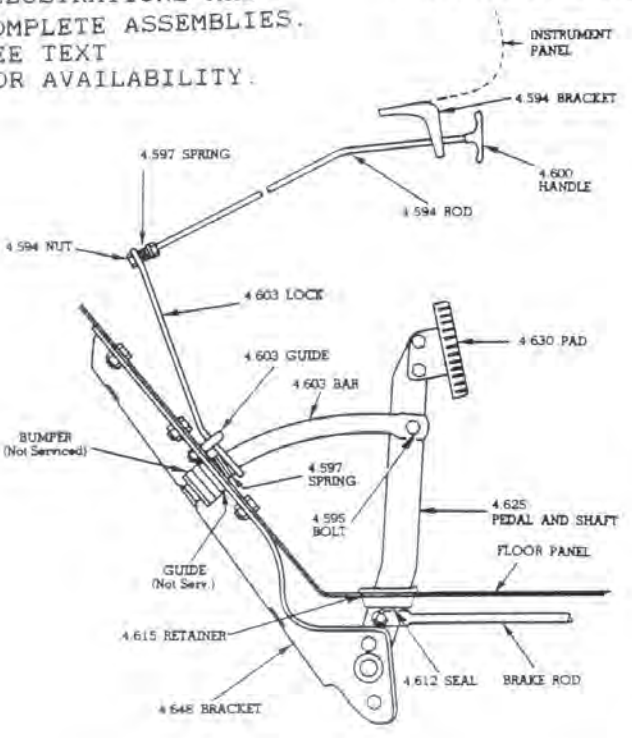

TRUCK PARKING BRAKE CONTROLS (FOOT OPER.)

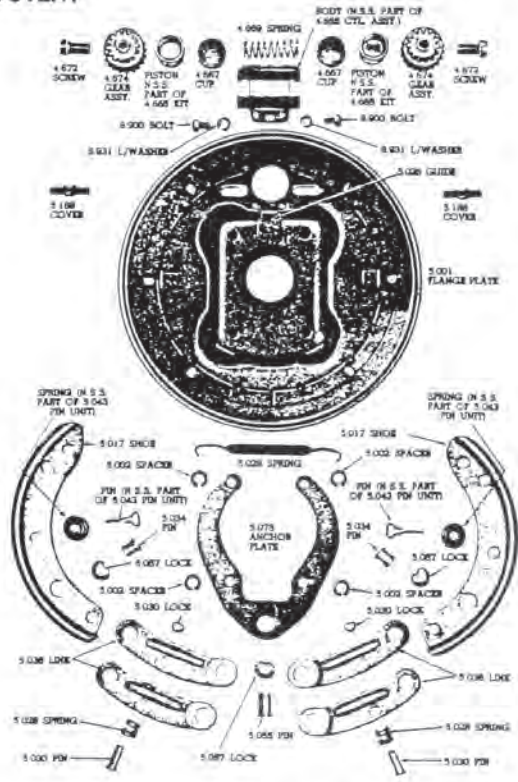

HYDRAULIC BRAKE PARTS—FRONT

Section 180T: Brake Parts

Format = Part No., Year, Description, Original Chevrolet Parts Book Group No., Price and Unit of Measure.



Master Cylinder & Brake Booster Assy



MASCYL1 47-55
Bolt in replacement using stock brake pedal. 7in. dual diaphragm brake booster. All new components. Specify your application-disc/disc or disc/drum. All bracketry included. Bolt-in application onto stock frames of 47-54 and 55 1st series trucks. (4.65-0)\$399.00 EA



EC-505 47-54
New 7" booster & master cylinder assembly. Mounts in stock location using original brake pedal. (-0)\$395.00 KIT

Disc Brake Conversion Kit



EC-702CK SHOWN

EC-711SCK 28-40
Complete kit including rotors, calipers, pads, brackets & fasteners (brake hoses sold separately). (-0)\$450.00 KIT



EC-711S 28-40
Bracket kit only (no rotors, calipers, pads, etc). (-0)\$180.00 KIT

EC-711CK 41-54
B. (-0).....\$450.00 KIT
EC-711 41-54
Bracket kit only (no rotors, calipers, pads, etc). (-0).....\$180.00 KIT



ABS375 47-54
6 lug front w/ master cylinder and booster. Keep your 6 lug a 6 lug. Features 12" rotors, Chevy truck calipers, brake hoses & dust caps. Master cylinder/ power brake unit features a 7-1/2" dual diaphragm booster, proportioning valve & adjustable rod to set your brake pedal height. (5.809-0)\$845.00 SET



ABS376 47-54
6 lug front, NO master cylinder and booster. Keep your 6 lug a 6 lug. Features rotors, Chevy truck calipers, brake hoses & dust caps. (5.809-0)\$495.00 SET



EC-750
Rubber brake hose kit for ECI conversion kits. Front only. (-0)\$50.00 PR



EC-751
Rubber brake hose kit for ECI conversion kits. Front only. (-0)\$50.00 PR

Line Clamp - Stainless



13274
3/16" single (12 clamps). (8.95-15)\$17.00 SET
13277
1/4" single (12 clamps). (8.95-15)\$17.00 SET
13278
5/16" single (12 clamps). (8.95-15)\$17.00 SET
13279
3/8" single (12 clamps). (8.95-15)\$17.00 SET
13280
1/2" single (12 clamps). (8.95-15)\$17.00 SET
13281
5/8" single (8 clamps). (8.95-15) \$17.00 SET
13282
3/4" single (8 clamps). (8.95-15) \$17.00 SET
13283
7/8" single (8 clamps). (8.95-15) \$17.00 SET



13276
3/16" x 3/16" double (6 clamps). (8.95-15)\$17.00 SET
13285
1/4" x 1/4" double (6 clamps). (8.95-15)\$17.00 SET

180T

Providing part numbers speeds up your order, improves accuracy and helps us maintain low prices.

See Illustration Index for core charge information and a list of abbreviations. For Body Model information, see Section 5T.



Section 180T: Brake Parts

Format = Part No., Year, Description, Original Chevrolet Parts Book Group No., Price and Unit of Measure.

- 13286
5/16" x 5/16" double (6 clamps).
(8.95-15)\$17.00 SET
- 13287
3/8" x 3/8" double (6 clamps).
(8.95-15)\$17.00 SET
- 13288
1/2" x 1/2" double (6 clamps).
(8.95-15)\$17.00 SET
- 13289
5/8" x 5/8" double (4 clamps).
(8.95-15)\$17.00 SET
- 13290
3/4" x 3/4" double (4 clamps).
(8.95-15)\$17.00 SET
- 13291
7/8" x 7/8" double (4 clamps).
(8.95-15)\$17.00 SET



- 13275
3/16" x 3/8" combination (6 clamps).
(8.95-15)\$17.00 SET
- 13284
5/16" x 3/8" combination (6 clamps).
(8.95-15)\$17.00 SET

Clamp

-  120521.....
1/4in. bolt-on strap.
For wire or tube (4
pcs). (8.95-40)
\$2.75 SET
-  120521A.....
5/16in, insulated bolt-
on strap. For wire or
tube (4 pcs). (8.95-40)
\$2.75 SET
-  120521B.....
3/8in. bolt-on strap.
For wire or tube (4
pcs). (8.95-40)
\$2.75 SET

- 
BRKCOHAUL 36-50
(5.017-15)\$182.00 KIT



- BRKCOHAUL 51-54
(5.017-15)\$140.00 KIT

Emergency Brake Release



- 3690404..... 48-51
Handle (chrome). (4.592-15) ..\$13.50 EA
- 1990717.....52-53
Knob (maroon).
(4.6-15) ...\$11.00 EA



- 1990717A..... 54
Knob (black). (4.6-15)
\$10.00 EA

- 3687252..... 48-55
U-bolt for foot brake
release lock guide.
(4.603-15) . \$10.50 EA

Emergency Brake Bracket

-  3687303 48-55
For foot operated pedal.
(4.648-15)\$45.00 EA

Emergency Brake Cable

-  597327..... 37-46
1/2T (takes 2). Does not include clevis.
55" length. (4.826-15) \$90.00 EA

- 3694170..... 47-54
1/2T (takes 2) (1947-50 use your end).
(4.826-15) \$48.00 EA

Gasket



- 476136..... 36-54
Emergency cable to backing plate.
(4.834-15)\$3.00 PR

Boot



- 3691420..... 37-54
Emergency cable to cable housing.
(4.834-20) \$6.50 SET

Clevis End Pin



- 3682642..... 37-53
Emergency brake.
(4.833-40) ... \$5.25 PR



- 3687752..... 47-54
Emergency brake
cable (4.826-15).....
\$5.75 EA

Control Rod Assembly



- 3689297..... 48-54
Emergency brake (goes back to
cables). Fits 1/2T. (4.826-15) \$90.00 SET

Grommet



- 3696521..... 51-54
(9.775-15) .. \$1.75 EA

Returns require a return authorization number, Please call.

Section 180T: Brake Parts

Format = Part No., Year, Description, Original Chevrolet Parts Book Group No., Price and Unit of Measure.



Anti-Rattle Rubber Spacer



369387 37-54
Hand brake handle
release rod. (4.605-40)
\$7.00 EA

Spring



373980 32-57
Emergency hand
brake release lever.
(4.597-15) .. \$5.75 EA

Brake Pedal Return Spring



368244 36-46
(4.827-15) \$6.50 EA



5 3/4"

3698665 47-57
Overall length 5-3/4in.
(4.827-20) \$5.75 EA

Bushings



3682074 37-46
Clutch & brake pedal
shaft (13/16in. o.d. x
3/4in. i.d. x 1-25/64in.
l) (4.626-15) \$25.00 PR



3683016 47-54
Clutch & Brake Pedal
Shaft (1-1/16in. O.d. X
1in. l.d. X 1-1/4in. L)
(0.831-15) . \$21.00 PR

Brake Drum



602432A 36-50
Front, straight axle. 1/2T & commercial
(6 lug). (5.809-15) \$95.00 EA



601985 36-50
Rear 1/2T & 37-42 3/4T.
(5.809-15) \$111.50 EA
3696266 51-56
Front or rear 1/2T.
(5.809-20) \$75.75 EA

Gasket -Brake Drum



365673 29-57
Brake drum (6 lug) front or rear.
(5.819-15) \$3.50 PR

Brake Shoes



3681129 36-52
36-50 1/2T front & rear, 37-42 3/4T rear
w/ 11in. brakes, 37-52 3/4T front, 37-
42 1T front (does 2 wheels) \$30 core.
(5.017-15) \$34.00 PR
3696177 51-56
Front 2 wheels (\$15 core).
(5.017-15) \$30.00 SET
3695709 51-56
Rear 2 wheels (\$15 core) w55b.
(5.017-15) \$33.50 SET
3703512 53-59
3/4 & 1T front, 3/4 rear (exc. 14in. brakes,
duals & 7.50in. x 17in. tire).
(5.017-15) \$48.25 PR

Note: Inquire about Brake Shoes for Larger Trucks.

Tinnerman Nuts



365897 All
Retains rear brake
drum (6 pcs). (5.81-40)
\$3.75 SET

Brake Shoe Hold Down Kit



3696704 51-57
2 wheels (8 pcs). (5.043-20) ... \$8.00 SET

180T

Providing part numbers speeds up your order, improves accuracy and helps us maintain low prices.

See Illustration Index for core charge information and a list of abbreviations. For Body Model information, see Section 5T.



Section 180T: Brake Parts

Format = Part No., Year, Description, Original Chevrolet Parts Book Group No., Price and Unit of Measure.

Brake Shoe Hold Down



475509 36-50
Spring (2 pcs).
(5.046-40) . \$4.50 SET



475506 36-50
J-hook (2 pcs).
(5.102-30) . \$3.00 SET

Brake Shoe Return Springs

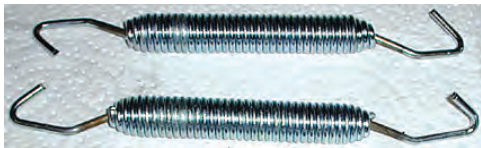

475511 37-50
For 2 wheels (2 pcs) 36-42 all,
46-50 1/2T, 3/4T front only.
(5.026-20) \$6.75 SET



3680890 46-52
3/4T rear and 1T front.
(5.026-15) \$12.50 EA

Brake Shoe Springs



3694822 51-54
Return & adjusting, Passenger
& 1/2T (does 2 wheels) (6 pcs).
(5.026-30) \$20.00 SET

Pin-Lock



475508 36-52
Brake shoe 9/16in.
o.d. (exc 51-52 1/2T)
(2 pcs) Fits 1 side.
(5.03-40) . . \$3.00 SET



475508E 36-52
E-clip. Replaces
original on brake shoe.
9/16in. o.d. (exc 51-52
1/2t) (2 pcs). (5.03-40)
\$1.75 SET



358829 30-52
Shoe anchor 29/32in.
o.d. (1/2T & most 3/4T)
(2 pcs). (5.057-15) . . .
\$5.00 SET



358829E 30-52
Replacement (e-clip)
brake shoe, 29/32in.
o.d. (2 pcs). (5.057-40)
\$1.75 SET



359380 30-57
Shoe anchor 1-3/16in.
o.d. some 3/4 & most
1T (2 pcs). (5.057-15) \$6.25 EA



359380E 30-57
E-clip for brake shoe,
1-3/16in. o.d. some
3/4 & most 1T (2 pcs).
(5.057-40) \$1.75 SET

Adjuster Assembly



496351B 51-57
Brake shoe w/ star wheel, fits
Passenger & 1/2T. (5.11-15) . . . \$13.50 EA

Brake Adjust Hole Plugs



475516B 36-54
Plugs (rubber) (8 pcs).
(5.188-40) . \$5.25 SET



475516 36-54
Plugs (original metal)
(8 pcs). (5.188-30) . . .
\$8.50 EA

Brake Hose



476719 36-54
36-50 all, 51-54 3/4t only, takes 3.
(4.68-20) \$23.25 EA
3696551 51-57
Takes 3.
(4.68-20) \$23.25 EA

U-clip



334961 36-57
For brake hose to
frame (uses 3) (3
piece set). (4.681-40).

\$3.25 SET

Copper Washer



231343 36-57
For brake hose (3
pcs). (4.671-40)
\$5.25 SET

Brake Line Sets

Oversize shipping charges apply to all Brake Line Sets. Please call for rate.

3696833 37-54
Steel 1/2T (specify year when
ordering). (4.865-0) . . . \$145.00 SET

369683S 37-54
Stainless 1/2T (specify year when
ordering). (4.865-0) . . . \$170.00 SET

3696844 37-52
Steel 3/4T (specify
year when ordering).
(4.865-0) \$145.00 SET

369684S 37-52
Stainless 3/4T (specify year when
ordering). (4.865-0) . . . \$155.00 SET

Returns require a return authorization number, Please call.

Section 180T: Brake Parts

Format = Part No., Year, Description, Original Chevrolet Parts Book Group No., Price and Unit of Measure.



Master Cylinder



5450257 36-37
1/2T (\$100 core). (4.65-15) ..\$175.00 EA



5454576E 38-46
New for 1/2T. Must reuse old push rod
& retainer (not drilled for brake light
switch). (4.65-0)\$124.50 EA



5454576 38-46
Rebuilt 1/2T (\$100 core).
(4.65-15)\$165.00 EA



5454381 38-46
Except 1/2T (\$35 core).
(4.65-15)\$142.75 EA

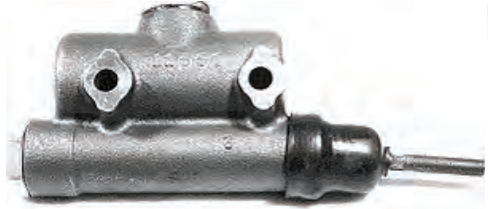

5454575 47-50
1/2T (\$35 core). (4.65-15)\$131.25 EA



5454382 47-51
Except 1/2T (\$35 core).
(4.65-15)\$149.75 EA



5454384 51
1/2T (\$35 core). (4.65-30) \$55.00 EA



5454459 52-54
1/2T & 53-54 3/4 & 1T (exc
Hydramatic & Double Duty) (\$35 core).
(4.65-15)\$126.00 EA



5454382 52-54
1-1/2T, 2T & 52 Double Duty (\$35 core).
(4.65-15)\$160.00 EA



5454384 53-54
Double Duty & Hydramatic (\$35 core).
(4.659-30) \$55.00 EA

Master Cylinder Rebuild Kit



5453950 36-50
1/2T (1in. bore). (4.65-15) \$24.00 EA



5454428 36-57
1-1/2T, 2T & 36-52 3/4, 1T (1-1/4in.
bore). (4.649-15) \$28.25 EA



5450962 51-54
1/2T & 53-54 3/4, 1T (1-1/8in. bore).
(4.649-15) \$21.00 EA

180T

Providing part numbers speeds up your order, improves accuracy and helps us maintain low prices.

See Illustration Index for core charge information and a list of abbreviations. For Body Model information, see Section 5T.



Section 180T: Brake Parts

Format = Part No., Year, Description, Original Chevrolet Parts Book Group No., Price and Unit of Measure.

Plug



592865 36-54
Master cylinder inspection (in floor). 3-3/8" diameter for 3" hole. (12.541-15) \$7.50 EA

Rubber Boot

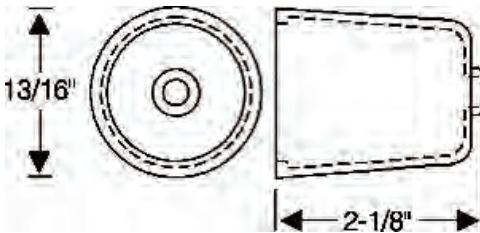

5450551 36-57
On master cylinder. (4.659-0) \$14.50 EA

Gasket



080445 37-57
Master cylinder cap. (4.651-30) . . \$1.50 EA

Wheel Cylinder-Front



5300869 36-52
36-50 1/2, 3/4, 1, 1-1/2T, 2T & 51-52 3/4T (exc 50 Double Duty). (4.665-15) \$71.00 EA
5455479L 51-59
Left 1/2T. (4.665-20) \$45.50 EA
5455478R 51-59
Right 1/2T. (4.665-20) \$45.50 EA

5453780 51-52
1-1/2T & 2T. (4.665-15) \$66.75 EA
5453819 53-54
1-1/2T & 2T (1in. piston). (4.665-20) \$50.50 EA

Wheel Cylinder-Rear

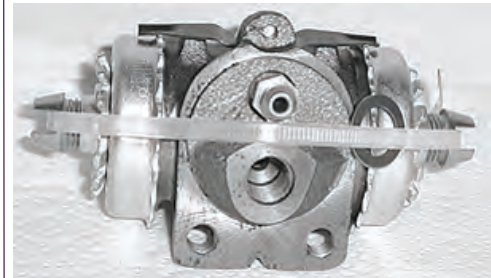

5300866 36-50
1/2t, 37-42 3/4T w/ 11in. drum. (4.665-15) \$57.75 EA
5300885 36-50
1-1/2T. (4.665-0) \$100.00 EA
5450071 37-52
1T & 3/4T w/ 14in. drum. (4.665-0) \$49.50 EA
5453819 51-54
Rear. Also fits 53-55 Corvette. (4.665-20) \$50.50 EA
5455480L 53-57
Left, 1T. (4.665-40) \$38.25 EA
5455480R 53-57
Right, 1T. (4.665-40) \$38.25 EA
5453866 51-53
Front on rear axle (1-1/2T, 2T). (4.665-15) \$88.25 EA
5453865 51-53
Rear on rear axle (1-1/2T, 2T). (4.665-20) \$91.00 EA
5454313 53-59
Front on rear axle (1-1/2T, 2T). (4.665-15) \$75.75 EA
5454314 53-59
Rear on rear axle (1-1/2T, 2T). (4.665-15) \$71.00 EA

Wheel Cylinder Rebuild Kit-Front



5450431 36-52
36-50 1/2, 3/4, 1, 1-1/2T, 2T & 51-52 3/4T (exc 50 Double Duty) (1-1/4in. bore). (4.665-20) \$27.50 EA



5455661 51-59
1/2T & 53-57 3/4 & 1T. (4.665-20) \$9.50 EA



5455660 53
1-1/2T & 2T. (4.665-30) \$11.50 EA



5454399 54-59
1-1/2T & 2T. (4.665-30) \$9.00 EA

Wheel Cylinder Rebuild Kit-Rear



5450429 36-50
1/2T & 37-42 3/4T with 11in. drum (1-3/16in. bore). (4.665-15) \$23.50 EA

Returns require a return authorization number, Please call.

Section 180T: Brake Parts

Format = Part No., Year, Description, Original Chevrolet Parts Book Group No., Price and Unit of Measure.



5450435 36-50
W/ pistons 1-1/2T & 2T (1-1/2in. bore).
(4.665-20) \$18.50 EA



5450434 36-52
W/ pistons 3/4T with 14in. drum 40-52
1T (exc Double Duty) (1-3/8in. bore).
(4.665-20) \$19.75 EA



5455661 51-57
3/4T (exc 56 Double Duty).
(4.665-20) \$9.50 EA



5455660 51-59
1/2T (4.665-30) \$11.50 EA



5454488 51-57
1-1/2T & 2T. (4.665-30) \$14.25 EA



5454252 53-59
1T (4.665-15) \$10.50 EA

Bleeder Valve

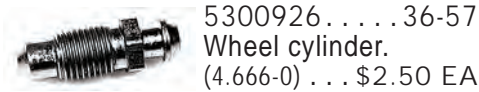

5300926 36-57
Wheel cylinder.
(4.666-0) . . . \$2.50 EA

Brake Line Junction Bolt



476099 37-54
Brake line junction
block bolt. Fits all car
and 51-55 3/4 ton
up to 2 ton trucks.
(4.686-30) . \$10.00 EA

Brake Line Junction Block

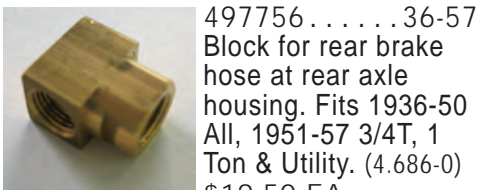

497756 36-57
Block for rear brake
hose at rear axle
housing. Fits 1936-50
All, 1951-57 3/4T, 1
Ton & Utility. (4.686-0)
\$19.50 EA

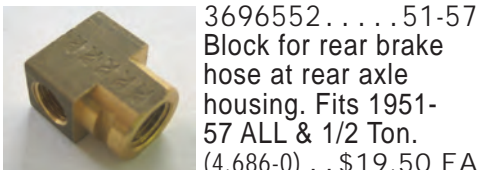

3696552 51-57
Block for rear brake
hose at rear axle
housing. Fits 1951-
57 ALL & 1/2 Ton.
(4.686-0) . \$19.50 EA

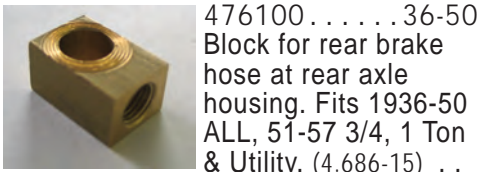

476100 36-50
Block for rear brake
hose at rear axle
housing. Fits 1936-50
ALL, 51-57 3/4, 1 Ton
& Utility. (4.686-15) . .
\$18.00 EA



3696540 51-54
Block, left front brake
line at master cylinder.
Fits 1951-54 PASS
(EXC. CONV) & 1/2
ton. (4.686-15)
\$18.00 EA

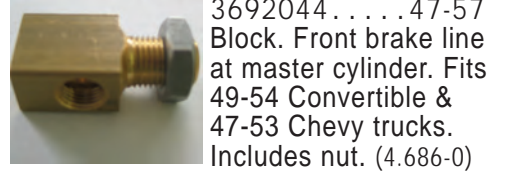

3692044 47-57
Block. Front brake line
at master cylinder. Fits
49-54 Convertible &
47-53 Chevy trucks.
Includes nut. (4.686-0)

\$23.00 EA

Clip



3735074C All
3/8in. slot, gas, brake
line, wire harness (4
pcs). (8.95-15)
\$4.75 SET

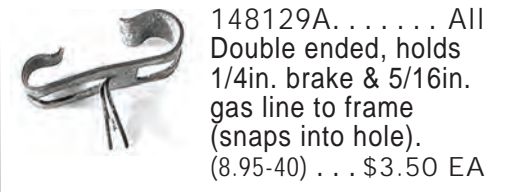

148129A All
Double ended, holds
1/4in. brake & 5/16in.
gas line to frame
(snaps into hole).
(8.95-40) . . \$3.50 EA

Brake Light Switch

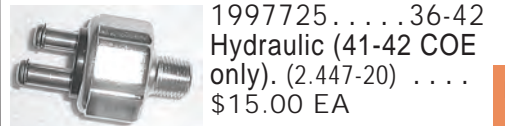

1997725 36-42
Hydraulic (41-42 COE
only). (2.447-20)
\$15.00 EA

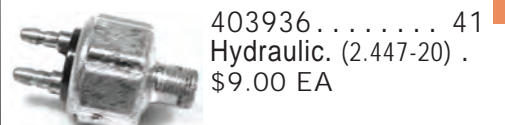

403936 41
Hydraulic. (2.447-20) .
\$9.00 EA

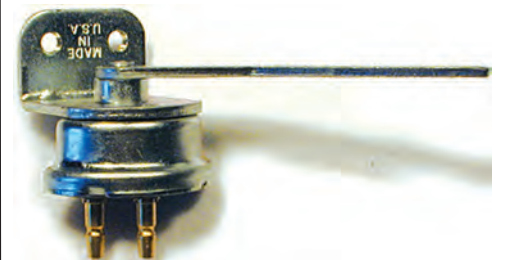

1997901 42-54
Mechanical (exc 42 COE).
(2.447-20) \$14.50 EA

Brake Fluid

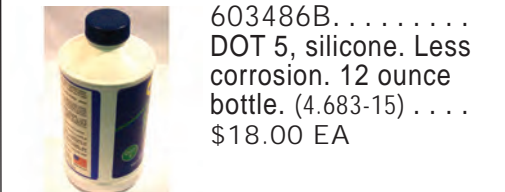

603486B
DOT 5, silicone. Less
corrosion. 12 ounce
bottle. (4.683-15)
\$18.00 EA

180T

Providing part numbers speeds up your order, improves accuracy and helps us maintain low prices.

See Illustration Index for core charge information and a list of abbreviations. For Body Model information, see Section 5T.



Section 180T: Brake Parts

Format = Part No., Year, Description, Original Chevrolet Parts Book Group No., Price and Unit of Measure.



5450285B
DOT 4 (12 oz). (4.683-15)
\$3.25 EA

Brake Cleaner



6129423
Superior cleaner. Many uses
(spray can). (4.683-15) \$3.25 EA

NOTE: Hazardous materials such as paints & cleaners cannot be shipped by air carrier. Ground shipping only (no international, Alaska or Hawaii).

Odds & Ends

Please call for availability on all Odds & Ends parts; once part is sold, it may no longer be in stock.

3693451 51-55
Backing Plate, Rear Left fits 51-54
Passenger, 53-55 Corvette, 51-55 1/2
ton (1st series) (5.001-40) . . \$35.00 EA
596565 37-50
Bolt, flange plate spacer fits 1937-52
Utility Exc COE, HD or 1946-50 1-1/2T
except school bus chassis (5.002-40) .
\$15.00 PR
3693452 51-55
Brake backing plate right side
(5.001-40) \$34.00 EA
3680959U 46
Brake cable 46 3/4 (Used) (4.826-40) .
\$25.00 EA
477443U 36-50
Brake link small pin & spring used fits
1936-50 passenger car & 1946-50 1/2
ton & 3/4 ton exc DD (5.029-0)
\$5.00 PR
592412U 36-52
Brake links used (fits 1936-50
passenger, 1936-42 truck, 1946-50 1/2
ton, 3/4 ton exc DD, 1951-52 3/4 ton
exc DD) (5.036-0) \$20.00 PR

3653268U 40-52
Clevis. Fits 40-52 Pass, 55-59 3/4, 1 &
1.5 Ton w/ HT, 3spd, HD & 2nd series
(Used) (4.826-0) \$10.00 EA
378548 34-57
Deflector, Rear Wheel Hub NOS
(14*000-0) \$8.00 EA
91949 55-59
Emergency Brake Cable (55-59 1/2T)
(14*000-0) \$40.00 EA
3686685 48-50
Emergency Brake cable (Utility)
(14*000-40) \$45.00 EA
3684247 47-52
Emergency brake cable 1 ton NOS
(14*000-40) \$60.00 EA
3651404 39-46
Emergency brake cable. Fits all Utility.
(14*000-40) \$60.00 EA
3658405 37-42
Emergency brake cables, 37-38 3/4T
(14*000-0) \$45.00 EA
3687294 52-55
Foot brake pedal latch bar, COMM
NOS (14*000-40) \$17.50 EA
597235 39
Front anchor plate & links. (5.075-40) .
\$40.00 EA
7450131 49-53
Front inner bearing, 49-50 2 ton
(13*000-30) \$45.00 EA
144526 36-40
Inner Race & Roller outer axle bearing
(13*000-40) \$25.00 EA
3656987U 40-57
Pedal assembly brake and clutch
(2.008-0) \$25.00 EA
592420U 36-50
Pin for brake link used (5.036-0)
\$15.00 EA
3695834 51-57
Propeller shaft dual shoe brake link
outer connecting angle on one end fits
51-55 1 ton utility first series except
COE, 55-57 2nd series all (5.61-40) . .
\$15.00 EA
3650735 39-48
Seal - wheel bearing front fits 39
COE, 40-48 2 Ton & 46-48 school bus
chassis (6.326-40) \$10.00 EA
5300890 36-50
Wheel brake cylinder cup 1-1/2in. rear
(4.665-0) \$0.50 EA
1409123 36
Wheel brake cylinder cup rear 1-1/16in.
(4.665-0) \$0.50 EA

5450073 46-50
Wheel brake cylinder cups front
1-3/8in. (4.665-0) \$0.50 EA
5450031 51-59
Wheel brake cylinder cups. Fits 51-52
and 53-59 CBL (4.665-0) . . . \$0.50 EA
5451615-1. 46-48
Wheel brake cylinder rear (4.665-40) . .
\$19.00 EA
5300885N 36-50
Wheel brake cylinder rear NOS 1.5 ton
(4.665-40) \$85.00 EA
5450431N 36-48
Wheel brake cylinder spring & cups.
Front for 1-1/4in. bore, Delco NOS.
(4.665-40) \$15.00 SET
5465299 53
Wheel brake cylinder. Front 1in.
(4.665-0) \$0.50 EA
1074825 36-50
Wheel brake cylinders front 1-3/16in.
(4.665-0) \$0.50 EA
5300922 36-50
Wheel Cylinder Adjust Screw Rear
(Utility) (4.672-20) \$3.00 EA
5300800 All
Wheel cylinder cup 1-3/16 in (4.667-15)
\$2.00 EA
5300866U 54-60
Wheel cylinder NOS shelf worn
(4.665-40) \$50.00 EA
5455484N 53-57
Wheel cylinder rear 1 ton DD
(14-000-40) \$55.00 EA
5455480 53-57
Wheel cylinder rear 3/4 ton (4.665-40).
\$40.75 EA

Returns require a return authorization number, Please call.

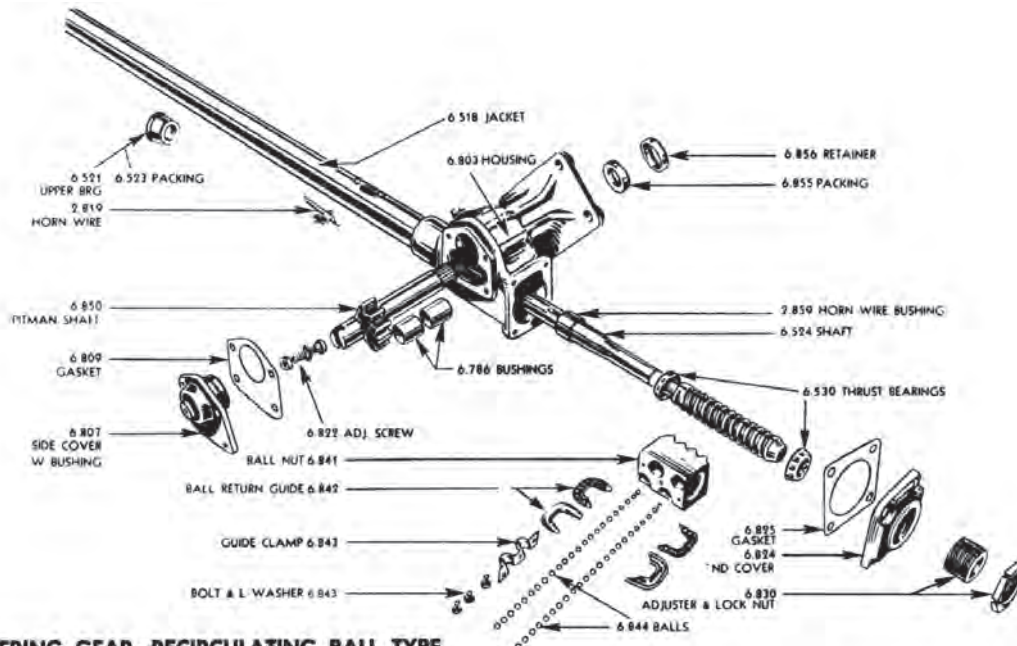

1941-46 STEERING GEAR—RECIRCULATING BALL TYPE

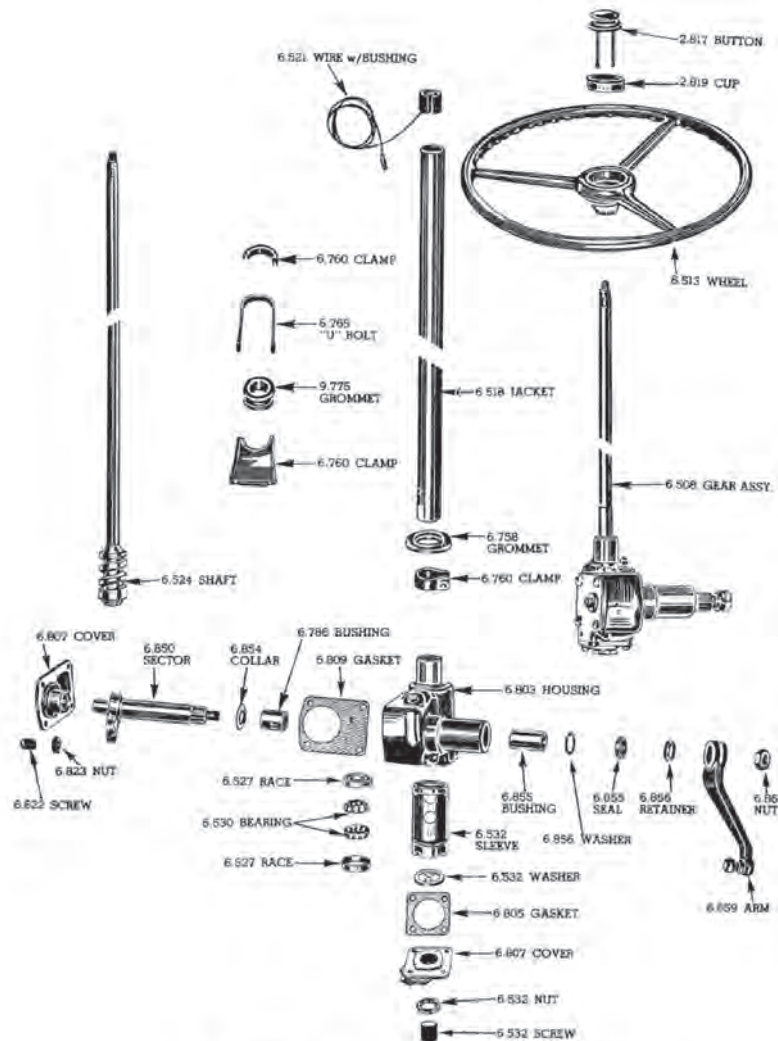

1937-40 TRUCK AND 1937 GB SERIES PASSENGER CAR

190T

Providing part numbers speeds up your order, improves accuracy and helps us maintain low prices.

See Illustration Index for core charge information and a list of abbreviations. For Body Model information, see Section 5T.

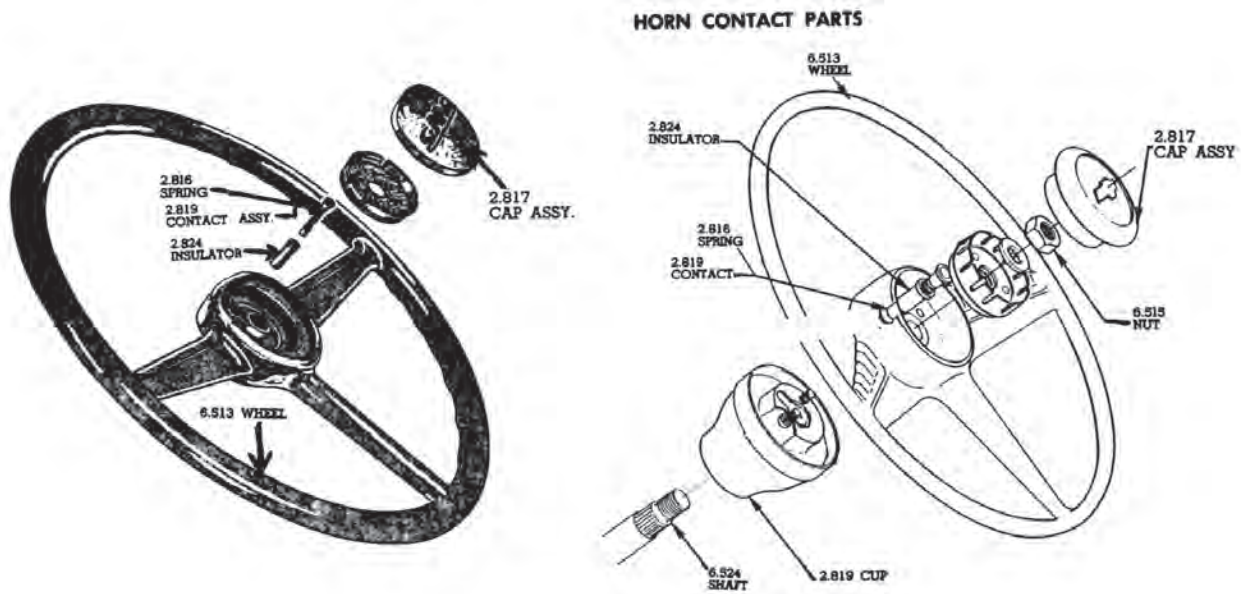

ILLUSTRATIONS ARE COMPLETE ASSEMBLIES
 SEE TEXT FOR AVAILABILITY

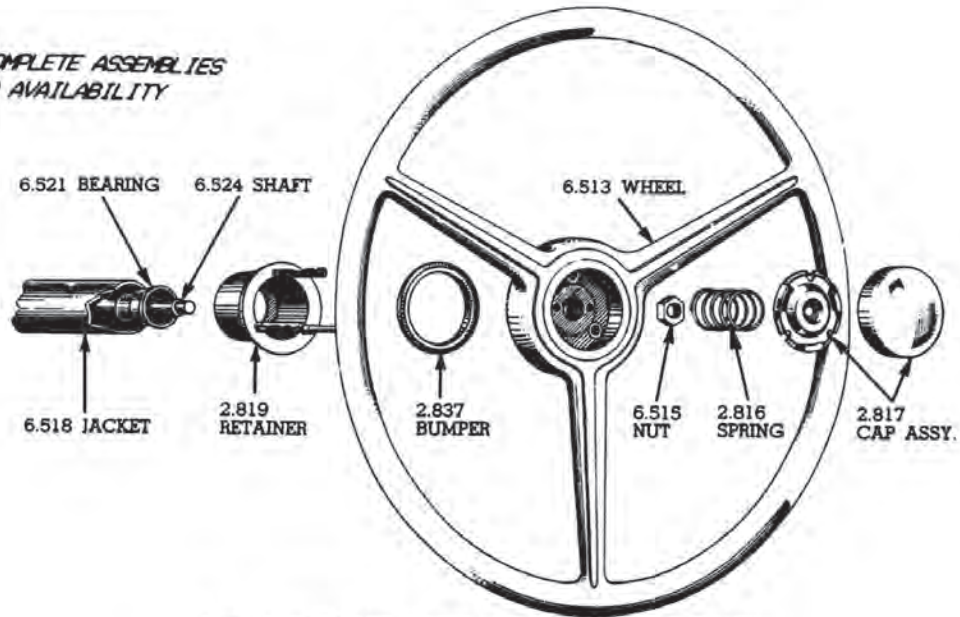

HORN CONTACT PARTS—CONVENTIONAL TRUCK

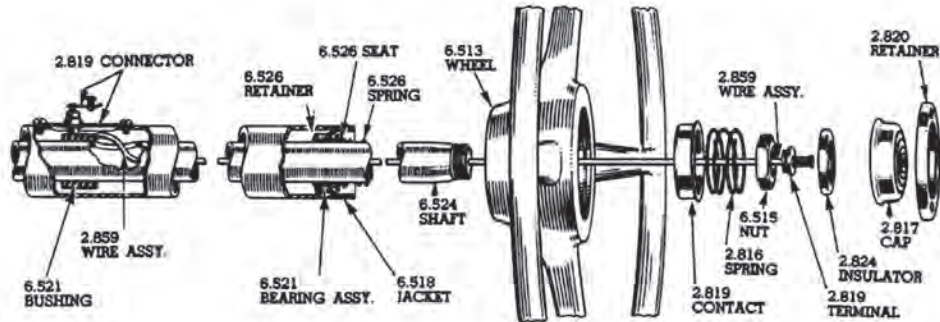

HORN CONTACT PARTS—CAB-OVER-ENGINE

Returns require a return authorization number, Please call.



Telescopic (Power) & Tilt Steering Column (Flaming River)

Power Telescopic and Tilt column in one package. Full 2 inch range of travel. Unique design telescopes from the tube with a remote, compact stainless steel cable drive which can be mounted under the dash, seat or anywhere you can think to hide it (72" cable length). You can even add 2-position memory at a minimal cost. Easy to install, complete functionality. Available for floor shift applications only. Order in mill finish (paintable) or polished stainless.



- FR20011PM
30-32 inch, Polished Stainless Finish with memory. (4.007-0) \$1,550.00 EA
- FR20012PM
32-34 inch, Polished Stainless Finish with memory. (4.007-0)\$1,550.00 EA
- FR20011P
30-32 inch, Polished Stainless Finish. (4.007-0)\$1,547.75 EA
- FR20012P
32-34 inch, Polished Stainless Finish. (4.007-0)\$1,547.75 EA
- FR20011M
30-32 inch, Mill Finish. (4.007-0)\$1,261.00 EA
- FR20012M
32-34 inch, Mill Finish. (4.007-0)\$1,261.00 EA

Tilt Steering Column-Column Shift (Flaming River)

Flaming River now manufactures an all new column shift, tilt steering column. All new components have been engineered by Flaming River to incorporate state-of-the-art technology in this nostalgic design. Each column comes complete with gear shift arm, stainless steel dress up kit, illuminated gearshift indicator and GM wiring (4-1/4in. connector) and a removable 12 position linkage arm with each column for easy alignment. Shaft size is 1in. DD 2in. tube diameter.



- FR20020
2" o.d. x 28" length. Steel finish (paintable). (4.007-0) . . . \$559.00 EA
- FR20020PL
2" o.d. x 28" length. Chrome & stainless steel finish. (4.007-15)\$699.00 EA
- FR20021
2" o.d. x 30" length. Steel finish (paintable). (4.007-0)\$559.00 EA
- FR20021PL
2" o.d. x 30" length. Chrome & stainless steel finish. (4.007-15)\$699.00 EA
- FR20111NS
Concealed neutral safety switch, can be installed on you gear shift column. Includes switch & billet aluminum cover. (4.007-15)\$59.00 EA

Tilt Steering Column-Floor Shift (Flaming River)



- FR20000
1-3/4" o.d. x 28" length. Steel finish (paintable). (4.007-15) . . . \$345.00 EA
- FR20000SS
1-3/4" o.d. x 28" length. Polished, stainless steel finish. (4.007-15)\$499.00 EA

- FR20001
1-3/4" o.d. x 30" length. Steel finish (paintable). (4.007-15)\$345.00 EA
- FR20001SS
1-3/4" o.d. x 30" length. Polished, stainless steel finish. (4.007-15)\$499.00 EA
- FR20005-28
2" o.d. x 28" length. Steel finish (paintable). (4.007-15)\$345.00 EA
- FR20005-28SS
2" o.d. x 28" length. Polished, stainless steel finish. (4.007-15)\$499.00 EA
- FR20005
2" o.d. x 30" length. Steel finish (paintable). (4.007-15)\$345.00 EA
- FR20005SS
2" o.d. x 30" length. Polished, stainless steel finish. (4.007-15)\$499.00 EA
- FR2000MCSS
Polished Stainless. Since it is only 17" long, it reduces u-joint angles and removes visible tube from the engine compartment increasing component clearance. (4.007-15)\$489.00 EA

Steering Column - Swing Away Kit

This kit enables you to mount a steering column and swing it to the side when getting in or out of your vehicle. Includes bracket and swivel floor mount. A column and/or column drop must be purchased separately. Can also be used with an existing column.



- FR1621
1-3/4" dia column. (-15) . \$315.00 EA
- FR1622
2" dia column. (-15)\$305.00 EA

Shift Indicator (Flaming River)



- FR20010-KIT
Black ABS housing w/ pointer. (4.007-15)\$79.00 EA

Providing part numbers speeds up your order, improves accuracy and helps us maintain low prices.

See Illustration Index for core charge information and a list of abbreviations. For Body Model information, see Section 5T.



Section 190T: Steering Columns, Steering Wheels, Shafts, Rebuild Kits, Steering Components & Related
Format = Part No., Year, Description, Original Chevrolet Parts Book Group No., Price and Unit of Measure.

FR20010-OVKIT
 Black ABS overdrive housing w/ pointer.
 (4.007-15)\$76.75 EA

FR20010-KITC
 Chrome ABS housing w/ pointer.
 (4.007-15)\$109.00 EA

FR20010-OVKITC
 Chrome ABS overdrive housing w/ pointer.
 (4.007-15)\$105.75 EA

Gearshift Arm (Flaming River)



FR200101AR.
 Forged. Polished
 chrome. (4.007-15) ...
 \$99.50 EA



FRGSARM
 Straight gearshift arm.
 (4.038-15)\$32.00 EA



FRGSARM-OF
 Offset gearshift arm.
 (4.038-15)\$32.00 EA

Steering Column Drop (Billet Specialties)



BIS27025
 2-1/2" drop for 2". column, POLISHED
 finish. (6.761-15)\$65.00 EA

Steering Column Drop (Flaming River)

Flaming River's Column Drops are machined from billet aluminum with a smooth radius edge. This sleek design is available in satin or mirror finish.



FR20102
 2-1/2" drop for 1-3/4" column, satin
 finish. (6.761-15)\$91.00 EA

FR20102PL
 2-1/2" drop for 1-3/4" column, polished
 finish. (6.761-15)\$99.50 EA

FR20107
 2-1/2" drop for 2" column, satin finish.
 (6.761-15)\$79.00 EA

FR20107PL
 2-1/2" drop for 2" column, polished finish.
 (6.761-15)\$79.00 EA



FR20103
 3-1/2" drop for 1-3/4" column, satin
 finish. (6.761-15)\$79.00 EA

FR20103PL
 3-1/2" drop for 1-3/4" column, polished
 finish. (6.761-15)\$79.00 EA

FR20108
 3-1/2" drop for 2" column, satin finish.
 (6.761-15)\$79.00 EA

FR20108PL
 3-1/2" drop for 2" column, polished finish.
 (6.761-15)\$79.00 EA

Column Floor Mounts (Billet Specialties)



BIS27920
 1-7/8" column MOUNT FLOOR.
 (6.758-15)\$70.00 EA

Column Floor Mounts (Flaming River)



FR20100
 1-3/4" floor shift. (6.758-15) \$94.50 EA

FR20101
 2" column shift. (6.758-15)\$94.50 EA

Billet aluminum ball and collar swivel design floor mount simplifies column installation by allowing up to a 60 degree angle.

Column Shift Floor Mounts (Flaming River)



FR20100CVR
 Floor mount firewall cover. Polished
 aluminum cover to finish the engine
 side column of the floor mount.
 (6.758-15)\$56.50 EA

Tilt Column Wiring Accessories (Flaming River)

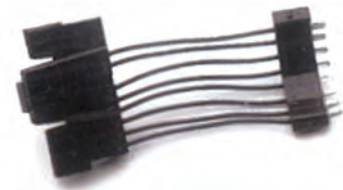

FR20118-2
 Plug adapter-horseshoe shaped
 connector used in 67-68 Camaro.
 (Plug adapter FR20118 could be
 used in place of this adapter).
 (2.555-15)\$49.00 EA

Returns require a return authorization number, Please call.

Section 190T: Steering Columns, Steering Wheels, Shafts, Rebuild Kits, Steering Components & Related
 Format = Part No., Year, Description, Original Chevrolet Parts Book Group No., Price and Unit of Measure.



FR20118-1
 Flasher kit used for classic vehicles that did not come equipped with 4-ways. Includes flasher, female adapter & terminals. (2.555-15)\$79.00 EA

FR20118
 Plug adapter kit, female plug. Supplied with terminals. Can be used to adapt any existing wiring harness to mate with 4-1/4" connector. (2.555-15) \$17.50 EA

Steering Shaft-Billet (Flaming River)

There are two types of intermediate shaft systems: Splined (3/4-36) or "DD". Either shafting is ideal for your steering system. Splined shafts allow a more precise adjustment. DD can only be phased 180 degrees. The advantage to DD is that it can be cut to any length eliminating the need to premeasure. You will need to choose which shafting you will be using prior to ordering the universal joints, since one side accommodates the shaft. Splined shafts have two inches of spline on each side that can be easily trimmed one inch per side. DD shafts are available in two lengths which can be cut to size.

Billet shafts use a pre-ground alloy steel for strength and cosmetics. Available with electroless nickel plating for corrosion resistance.



FR1870-X
 Splined shaft in 2" increments (4" to 16") unplated. (5.548-15) ..\$43.00 EA
 FR1870-XPL
 Splined shaft in 2" increments (4" to 16") plated. (5.548-15) \$73.00 EA
 FR1871-XX
 Splined shaft in 2" increments (18" to 22") unplated. (5.548-15) \$43.00 EA

FR1871-XXPL
 Splined shaft in 2" increments (18" to 22") plated. (5.548-15) \$73.00 EA
 FR1850
 DD 18" shaft, unplated. (5.548-15) \$41.50 EA
 FR1851
 DD 36" shaft, unplated. (5.548-15) \$62.50 EA

Steering Shaft-Stainless (Flaming River)

Stainless Steel shafts are manufactured from high quality 303 stainless.

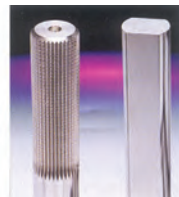

FR1850SSPL
 Polished stainless steel shafts, 18" DD. (5.548-15)\$83.50 EA
 FR1851SSPL
 Polished stainless steel shafts, 36" DD. (5.548-15)\$100.25 EA
 FR1870-XSS
 Polished stainless steel shafts splined in 2" increments (4" to 16"). (5.548-15)\$120.75 EA
 FR1871-XXSS
 Polished stainless steel shafts splined in 2" increments (18" to 22"). (5.548-15)\$120.75 EA

U-joints--Billet-Joint Steering Box (Flaming River)

The Billet-Joint U-Joints are CNC machined from aircraft steel to precision tolerances. The sealed needle bearing design will last ten times longer than a standard pin & block universal joint. The unique nickel plating prevents rust without the hassle of painting.



FR1709DD
 9/16" -26 spline box, 3/4" DD shaft. (5.548-15)\$69.00 EA

FR1709DDPL
 9/16" -26 spline box, 3/4" DD shaft (polished). (5.548-15) \$89.00 EA
 FR1708
 9/16" -26 spline box, 3/4" -36 shaft. (5.548-15) \$69.00 EA
 FR1708PL
 9/16" -26 spline box, 3/4" -36 shaft (polished). (5.548-15) \$89.00 EA
 FR1722DD
 5/8" -36 spline box, 3/4" DD shaft. (5.548-15) \$69.00 EA
 FR1722DDPL
 5/8" -36 spline box, 3/4" DD shaft (polished). (5.548-15) \$89.00 EA
 FR1726DD
 5/8" -36 spline box, 3/4" -36 shaft. (5.548-15) \$69.00 EA
 FR1726DDPL
 5/8" -36 spline box 3/4" -36 shaft (polished). (5.548-15) \$89.00 EA
 FR1724
 3/4" -30 spline box, 3/4" -36 shaft. (5.548-15) \$69.00 EA
 FR1724PL
 3/4" -30 spline box, 3/4" -36 shaft (polished). (5.548-15) \$89.00 EA
 FR1733DD
 3/4" -30 spline box, 3/4" DD shaft. (5.548-15) \$69.00 EA
 FR1733DDPL
 3/4" -30 spline box, 3/4" DD shaft (polished). (5.548-15) \$89.00 EA
 FR1715DD
 3/4" -36 spline box, 3/4" DD shaft. (5.548-15) \$69.00 EA
 FR1715DDPL
 3/4" -36 spline box, 3/4" DD shaft (polished). (5.548-15) \$89.00 EA
 FR1711
 3/4" -36 spline box, 3/4" -36 shaft. (5.548-15) \$69.00 EA
 FR1711PL
 3/4" -36 spline box, 3/4" -36 shaft (polished). (5.548-15) \$89.00 EA
U-joints--Billet-Joint Steering Column (Flaming River)
 FR1707DD
 1" DD column, 3/4" Shaft. (5.548-15) \$69.00 EA
 FR1707DDPL
 1" DD column, 3/4" shaft (polished). (5.548-15) \$89.00 EA

190T

Providing part numbers speeds up your order, improves accuracy and helps us maintain low prices.

See Illustration Index for core charge information and a list of abbreviations. For Body Model information, see Section 5T.



Section 190T: Steering Columns, Steering Wheels, Shafts, Rebuild Kits, Steering Components & Related
Format = Part No., Year, Description, Original Chevrolet Parts Book Group No., Price and Unit of Measure.

FR1746DD
 1" DD column, 3/4" -30 shaft.
 (5.548-15) \$69.00 EA

FR1746DDPL
 1" DD column, 3/4" -30 shaft (polished).
 (5.548-15) \$89.00 EA

FR1714DD
 1" DD column, 3/4" -36 shaft.
 (5.548-15) \$69.00 EA

FR1714DDPL
 1" DD column, 3/4" -36 shaft (polished).
 (5.548-15) \$89.00 EA

FR1717DD
 1" DD column, 3/4" DD shaft.
 (5.548-15) \$69.00 EA

FR1717DDPL
 1" DD column, 3/4" DD shaft (polished).
 (5.548-15) \$89.00 EA

FR1754DD
 1" DD column, 1" DD shaft.
 (5.548-15) \$69.00 EA

FR1754DDPL
 1" DD column, 1" DD shaft (polished).
 (5.548-15) \$89.00 EA

U-joints--Stainless Steering Box (Flaming River)

Flaming Rivers Stainless Steel U-joints are made with 303 Stainless Steel for its strength, superior corrosion resistance & shine. The stainless steel joints have such a precision machined finish that they look pretty right out of the box. Add some polishing & they are gorgeous!



FR2509DD
 9/16" -26 spline box, 3/4" DD shaft.
 (5.548-15) \$79.00 EA

FR2509DDPL
 9/16" -26 spline box, 3/4" DD shaft (polished). (5.548-0) \$99.00 EA

FR2508
 9/16" -26 spline box, 3/4" -36 splined shaft.
 (5.548-15) \$79.00 EA

FR2508PL
 9/16" -26 spline box, 3/4" -36 splined shaft (polished). (5.548-0) \$99.00 EA

FR2522DD
 5/8" -36 spline box, 3/4" DD shaft.
 (5.548-15) \$79.00 EA

FR2522DDPL
 5/8" -36 spline box, 3/4" DD shaft (polished). (5.548-0) \$99.00 EA

FR2526
 5/8" -36 splined shaft box, 3/4" -36 splined shaft. (5.548-15) \$79.00 EA

FR2526PL
 5/8" -36 splined shaft box, 3/4" -36 splined shaft (polished). (5.548-0) \$99.00 EA

FR2533DD
 3/4" -30 spline box, 3/4" DD shaft.
 (5.548-15) \$79.00 EA

FR2533DDPL
 3/4" -30 spline box, 3/4" DD shaft (polished). (5.548-0) \$99.00 EA

FR2524
 3/4" -30 spline box, 3/4" -36 splined shaft.
 (5.548-15) \$79.00 EA

FR2525PL
 3/4" -30 spline box, 3/4" -36 splined shaft (polished). (5.548-0) \$99.00 EA

FR2515DD
 3/4" -36 spline box, 3/4" DD shaft.
 (5.548-15) \$79.00 EA

FR2515DDPL
 3/4" -36 spline box, 3/4" DD shaft (polished). (5.548-0) \$99.00 EA

FR2511
 3/4" -36 spline box, 3/4" -36 splined shaft.
 (5.548-15) \$79.00 EA

FR2511PL
 3/4" -36 spline box, 3/4" -36 splined shaft (polished). (5.548-0) \$99.00 EA

U-joints--Stainless Steering Column (Flaming River)

FR1716DD
 3/4" DD column, 3/4" DD shaft.
 (5.548-15) \$69.00 EA



FR2514DD
 1" DD column, 3/4" -36 splined shaft.
 (5.548-15) \$79.00 EA

FR2514DDPL
 1" DD column, 3/4" -36 splined shaft (polished). (5.548-0) \$99.00 EA

FR2517DD
 1" DD column, 3/4" DD shaft.
 (5.548-15) \$79.00 EA

FR2517DDPL
 1" DD column, 3/4" DD shaft (polished).
 (5.548-0) \$99.00 EA

Steering Shaft Support Bearing



FR1810
 3/4", zinc plated for steering systems with multiple joints. Fits splined or DD shafts. (5.548-15) \$32.50 EA

Steering Wheel



756084A. 47-53
 Black. Superior quality. Shaft size: 11/16", 36 splines.
 (6.513-15) \$200.00 EA



758625A. 54
 Black. Superior quality, beautiful finish.
 (6.513-15) \$200.00 EA

Returns require a return authorization number, Please call.

Section 190T: Steering Columns, Steering Wheels, Shafts, Rebuild Kits, Steering Components & Related
Format = Part No., Year, Description, Original Chevrolet Parts Book Group No., Price and Unit of Measure.



Steering Column Clamp



3657031 41-46
 U-bolt with fasteners.
 (6.765-15) . \$15.00 EA

Steering Column Insulator



3681057A 34-46
 Steering column to dash, brown exc
 COE. (6.758-15) \$13.50 EA



598145 34-46
 Steering column to dash, black exc
 COE. (6.758-15) \$1.75 EA



3685524 47-53
 Steering column to dash, black exc
 COE. (6.758-15) \$3.00 EA



3700190 54
 Steering column to dash.
 (6.758-20) \$3.00 EA

Grommet



357507 29-46
 Steering column at floor
 (exc COE). (6.758-15) .
 \$30.75 EA



3685928 47-54
 Steering column with
 metal core & sponge
 seal #3682871 at
 firewall (floor shift).
 (6.758-15) . \$13.00 EA



3685928A . . . 47-54
 Steering column
 without metal core at
 firewall (floor shift).
 (6.758-15) . \$25.00 EA



3687204 47-54
 Steering column at
 firewall (column shift).
 (6.758-30) . . \$5.75 EA



3682871 47-54
 Steering column at
 firewall (floor shift).
 (6.758-40) . \$14.00 EA



3687205 48-54
 Steering column with metal core &
 sponge seal #3687204 at firewall
 (column shift). (6.758-15) \$16.00 EA

Rubber Ring



755899 41-46
 Anti-rattle under
 steering wheel.
 (2.819-30) . . \$7.50 EA

Bearing



264887 41-46
 Under steering wheel.
 (6.521-15) . \$18.25 EA



270255 47-54
 Under steering wheel.
 (6.521-15) \$60.00 EA

Steering Gear Overhaul Kit

Note: Steering gear overhaul kits do not include worm gear, pitman shaft or sector shaft. Those items sold separately.



264277A 38-40
 Includes roller bearings.
 (6.524-15) \$89.00 KIT



267880A 41
 (6.524-15) \$111.25 KIT



267880B 42-46
 Exc 1T & larger COE.
 (6.524-15) \$113.00 KIT



5060231A 47-54
 (6.524-15) \$127.50 SET

Bearings & Balls For Steering Worm Gear



266741 41
 Balls in ball nut
 steering worm gear
 (30 piece). 0.0025 dia.
 (6.844-40) \$10.25 SET

190T

Providing part numbers speeds up your order, improves accuracy and helps us maintain low prices.

See Illustration Index for core charge information and a list of abbreviations. For Body Model information, see Section 5T.



Section 190T: Steering Columns, Steering Wheels, Shafts, Rebuild Kits, Steering Components & Related

Format = Part No., Year, Description, Original Chevrolet Parts Book Group No., Price and Unit of Measure.



206800 42-57
Balls in ball nut
steering worm gear
(30 piece). (6.844-40).
\$8.25 SET



261866B 37-40
Thrust bearing (2) & race (2).
(6.53-15) \$44.00 SET



179291B 41-54
Thrust bearing (2) & race (2).
(6.53-15) \$71.50 SET

Gasket



269298 41-46
Steering gear side
cover. (6.809-30)
\$2.50 EA

Pitman Shaft



609936 38-40
Steering gear. (6.85-40) \$153.50 EA

Screw (Pitman Shaft)



266678 41-57
Adjuster for pitman
shaft. (6.822-15)
\$7.50 EA

Bushing-Pitman Shaft



266316 34-54
Pitman shaft.
Length=1.370",
I.D.=0.140",
O.D.=0.250". (6.786-15)
\$17.75 EA

Pitman Shaft Seal



262155 37-57
(6.855-15) \$7.50 EA

Drag Link Kit



608840 32-59
& tie rod end rebuild kit, plugs,
springs, seats, exc 53-59 drag link.
(6.874-15) \$28.00 PR

Drag Link Rebuild Kit



608840N 32-40
NOS. Includes plugs, springs &
seats (exc 39-48 knee action).
(6.874-30) \$28.00 PR

Drag Link



609749 37-46
Includes part #608840 (Tie rod end
rebuild kit). Fits 37-46 1/2, 3/4, 1 and
1-1/2 ton vehicles. (6.87-15) .. \$89.50 EA



3699489 47-52
Includes Drag Link Kit #608840.
(6.87-15) \$100.00 EA



3696469 53-54
With tie rod ends. (6.87-15) \$91.25 EA

Balls



595586B 30-59
Drag link end on
steering & pitman
arms. (6.874-15)
\$47.00 SET



595586A 30-52
Tie rod end on 1/2T
steering arms (2 pcs).
(6.874-15) \$42.00 SET

Drag Link Seals



3705009A 32-52
2-7/8in. long, metal as original.
(6.886-15) \$18.25 SET

Returns require a return authorization number, Please call.

Section 190T: Steering Columns, Steering Wheels, Shafts, Rebuild Kits, Steering Components & Related
 Format = Part No., Year, Description, Original Chevrolet Parts Book Group No., Price and Unit of Measure.



3705009 32-52
 2-1/4in. long, rubber replacement.
 (6.886-15) \$19.50 SET

Long Tie Rod



367528 32-54
 Rod only (40-54 1/2T & 3/4T). 43-1/4"
 long. (6.23-15) \$40.00 EA

Tie Rod End



374226R 34-54
 1/2T & 3/4T (replacement type complete
 w/ ball) right. (6.233-20) \$45.00 EA
 374227L 34-54
 1/2T & 3/4T (replacement type complete
 with ball), left.
 (6.233-20) \$45.00 EA

Odds & Ends

Please call for availability on all Odds & Ends parts; once part is sold, it may no longer be in stock.

596575U 46
 3rd arm (steering) fits DR, DS, OR,
 OS, PK (6.103-0) \$40.00 EA
 266667 41
 Ball nut for steering gear, fits all
 commercial & utility exc COE
 (15*000-40) \$45.00 EA
 270263 47-53
 Ball Nut, Steering Worm Gear (2 Ton)
 (15*000-0) \$45.00 EA
 08420 34
 Bushing, Pitman Shaft (NOS) (15-0) . .
 \$4.00 PR
 3686831 48-54
 Column shift clamp. All 3-speed.
 (12*000-0) \$12.00 EA
 3835580U 50-55
 Exhaust manifold. Casting # 3835580
 (Used) (3.601-40) \$75.00 EA
 266048N 41
 Guide steering gear ball return fits
 all commercial & utility exc COE
 (15<000-0) \$15.00 PR
 756190 47-53
 Horn button. Fits comm (2.817-0)
 \$35.00 EA
 755850U 47-53
 Horn Cap Used (04-000-0) . \$15.00 EA
 1116775 34-54
 Horn Relay (NOS) (2.815-40)
 \$30.00 EA
 595271U 39-46. 39-46
 Pitman arm (Used) (6.859-0) \$75.00 EA
 609937 41-46
 Pitman Shaft (Steering Gear) (6.85-40)
 \$85.00 EA
 609936N 38-40
 Pittman Shaft (NOS). Some surface
 rust. (6.85-0) \$85.00 EA
 3847342 47-54
 Sector (Pitman Shaft) (6.85-40).
 \$85.00 EA
 3667227 37-50
 Steering arm fits 1-1/2 ton left or right
 (6.103-0) \$25.00 EA
 373781 34-36
 Steering connecting rod (drag link)
 (6.87-40) \$75.00 EA
 3703563 53-57
 Steering knuckle (spindle) fits 3/4T &
 1T (15*000-40) \$65.00 EA

607317 35-37
 Steering Knuckle Spindle (Utility)
 (15^000-0) \$75.00 EA
 3678194 46-50
 Steering knuckle stop NOS (fits 46 PP,
 PR, PS; 47-50 DD, SBC & 2T) use with
 3681101 forged I-beam (6.009-0)
 \$15.00 EA
 3656527 41-50
 Steering knuckle stop NOS 1/2T
 (15^000-0) \$20.00 EA
 753325 38-40
 Steering wheel fits all except JA, KA,
 KB, KH & COE (Used) (6.513-0)
 \$100.00 EA
 3701357U 54-57
 Steering wheel hub without single level
 hole used (6.512-0). \$20.00 EA
 756084U 47-53
 Steering Wheel Used (04-000-40)
 \$70.00 EA
 374226N 32-56
 Tie rod end left (4-59/64 in) (25/36-16
 right hand thread) Stamped R. Fits
 32-34 all exc CC & DC, 35-38 Pass,
 COMM exc EC, FC, GB & HB, 39-42
 COMM, 46-56 1/2T & 3/4T exc DD.
 (6.233-40). \$35.00 EA
 374227N 32-56
 Tie rod end. Left side. (4-59/64in.)
 (25/36-16 left hand thread) Stamped
 L. Fits 32-34 all exc CC & DC, 35-38
 Pass, COMM exc EC, FC, GB & HB,
 39-42 COMM, 46-56 1/2T & 3/4T exc
 DD. (6.233-40) \$35.00 EA
 5660219 49-50
 Worm Gear & Shaft (50 1st Design)
 (6.524-40). \$150.00 EA
 264279 38-40
 Worm Gear & Shaft (All Utility) (6.524-0)
 \$150.00 EA
 270260 47-53
 Worm Gear & Shaft 2T & School Bus
 Chassis (15^000-0). \$125.00 EA
 267888 41-46
 Worm Gear & Shaft Utility exc COE
 (15^000-0) \$150.00 EA

190T

Providing part numbers speeds up your order, improves accuracy and helps us maintain low prices.

See Illustration Index for core charge information and a list of abbreviations. For Body Model information, see Section 5T.

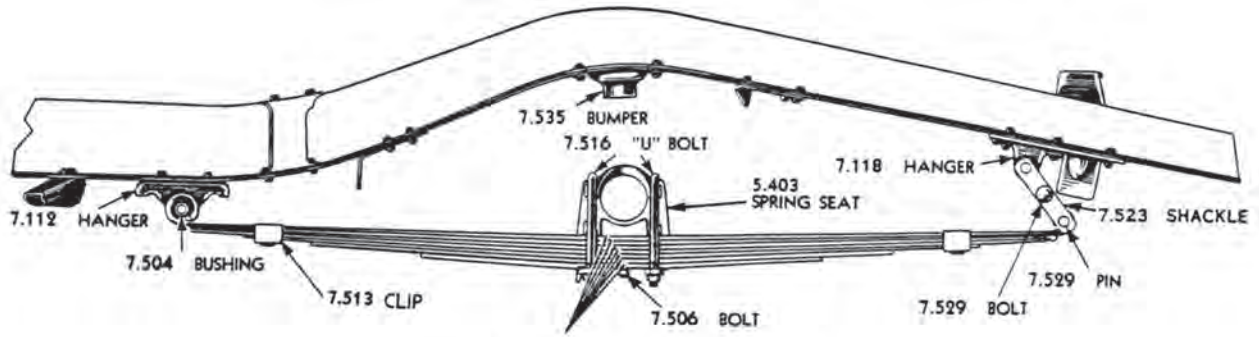

REAR SPRING AND PARTS

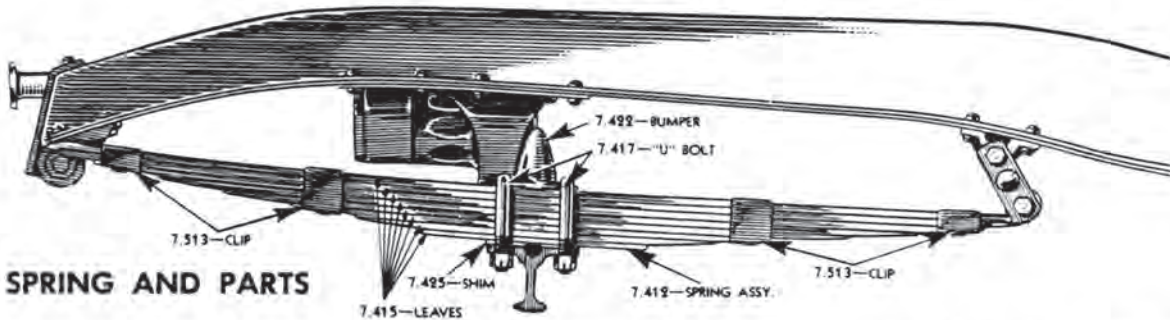

FRONT SPRING AND PARTS

ILLUSTRATIONS ARE COMPLETE ASSEMBLIES. SEE TEXT FOR AVAILABILITY.

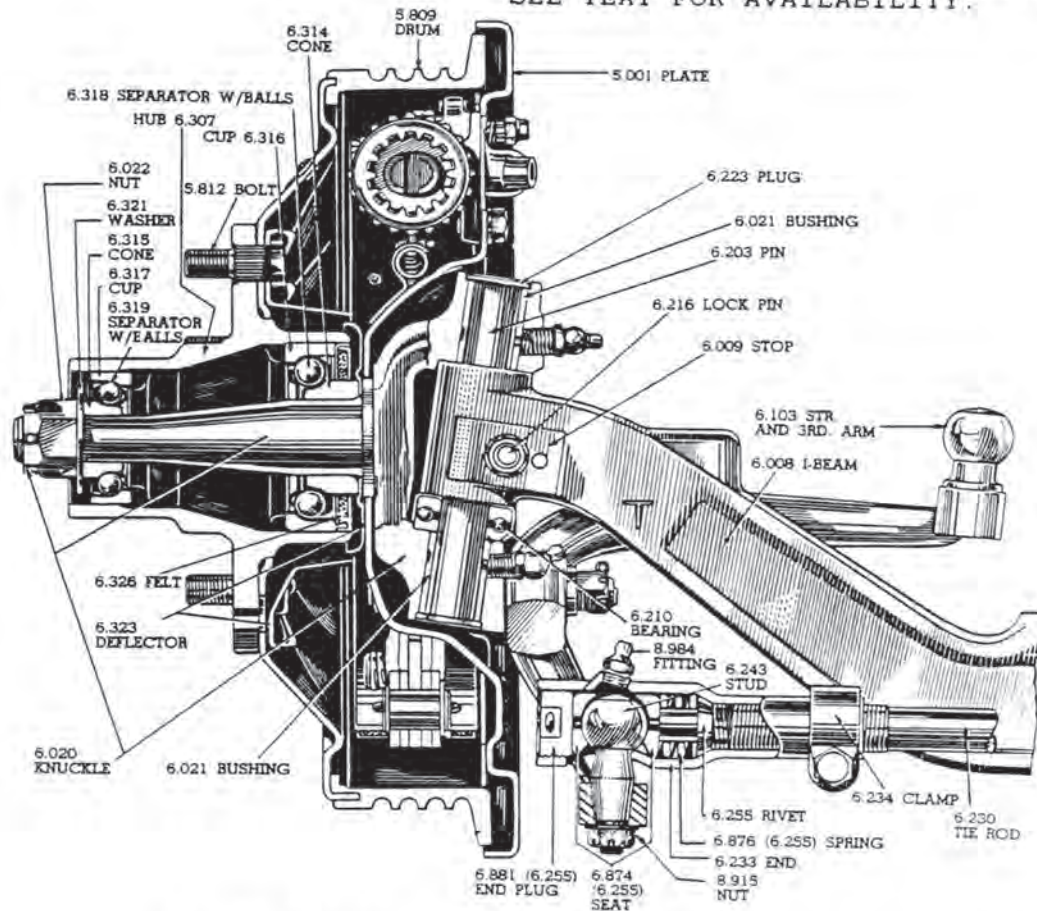

FRONT AXLE—CONVENTIONAL TRUCK (EXC. HVY. DUTY)

Returns require a return authorization number, Please call.

Section 200T: Front Suspension Components, Shocks, King Pins, Rebuild Kits & Shackles

Format = Part No., Year, Description, Original Chevrolet Parts Book Group No., Price and Unit of Measure.



Pitman Arm



5880723S 47-54
Power steering conversion kit, for stock suspension. Fits late model Saginaw steering box. (5.809-0) \$91.00 EA



5880723L 47-54
Power steering conversion kit, for lowered suspension. (5.809-15) \$129.00 EA

Power Steering Conversion Kit



5880723 47-54
For late model Chevy Saginaw steering box. (5.809-15) \$195.00 SET

Grease Fitting



191758 All
1/8in. national pipe, straight. (8.984-40) . . . \$1.50 EA



110347 All
1/4in. x 28 taper thread, 90 degree. (8.984-40) . . \$1.50 EA

Shocks



1072707 34-50
Right front, dual action (#1730-A) \$75 core. (7.345-15) \$250.00 EA
1072708 34-50
Left front, dual action (#1430-B) \$75 core (7.345-15) \$250.00 EA



1054144 37-46
Left front, single action (#1430CA) \$50 core (7.345-0) \$176.25 EA



1054146 34-46
Right front, single action (#1430DA) \$50 core (7.345-0) \$176.25 EA
1054146 47-50
Left front, single action (exc HP, HR, HS) (#1430DA) \$50 core (7.345-0) \$176.25 EA



1054144 47-50
Right front, single action (exc HP, HR, HS) (#1430CA) \$50 core (7.345-0) \$176.25 EA



5516237G 50-54
Front, 1/2T & 3/4T (7.345-15) \$60.00 SET

Shock Absorber Fluid



603489S All
(6.386-15) . . \$6.75 QT

Tube Shock Mounts



3700440 47-54
Upper front or rear. Fits 1/2T (replacement for 50-54). (7.395-15) . \$35.25 EA



3693687 47-54
Lower front, left (7.395-15) . \$27.50 EA



3693688 47-54
Lower front, right (7.395-15) . \$27.50 EA



3655328 47-54
Lower rear, left or right, 1/2T (replacement for 50-54). (7.395-15) \$24.50 EA

Shock Conversion Kit



3700440B 47-49
W/ gas shocks (4), 1/2T. (7.395-15) \$351.50 SET

Shock Link



043032A 30-49
9-5/16in. overall (7.355-30) . . . \$20.00 EA

200T

Providing part numbers speeds up your order, improves accuracy and helps us maintain low prices.

See Illustration Index for core charge information and a list of abbreviations. For Body Model information, see Section 5T.



Section 200T: Front Suspension Components, Shocks, King Pins, Rebuild Kits & Shackles

Format = Part No., Year, Description, Original Chevrolet Parts Book Group No., Price and Unit of Measure.

Bushings

 041133 30-49
Shock link. 1/2T &
3/4T. (7.388-15)
\$9.00 PR

 041133B. 30-49
Shock link single
action w/ brass
bushings, pins & cotter
keys for beam axle.
Superior. (7.388-15) . .
\$12.25 PR



043816 33-53
Shock link double action shock 33-46
all, 47-49 1/2, 3/4, 1T & 50-55 double
duty. (7.388-15) \$7.25 SET



3708378 50-57
Shock, rubber (8), w/ washers & nuts.
(7.388-15) \$14.25 SET

 3501467 39-46
Sway bar (rubber) use
with #350146 (2 piece)
(7.24-15) . \$15.50 SET

 350146 39-46
Sway bar shaft (steel
bushed rubber)
use with #3501467
(7.24-15) \$29.00 PR



3708378 50-54
Sway bar rubber links (8) w/ washers &
nuts (7.388-15) \$14.25 SET

King Pins



602691 29-39
1/2T, 34-39 3/4 & 1T
(6.203-15) \$137.50 PR

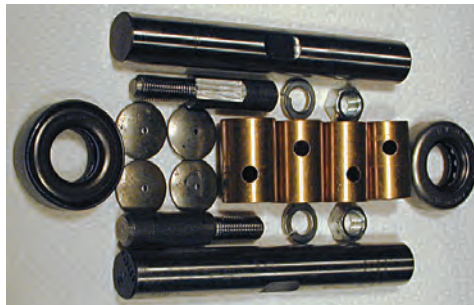

601019 31-52
46-52 3/4, 1T & 31-50 1-1/2T
(6.203-15) \$82.00 PR



602690 40
1/2T, 3/4T & 1T (6.203-15) \$84.75 PR

605121 41-54
1/2T
(6.203-15) \$63.75 PR

3691111 46-57
Double duty, 2T, 46-47 1-1/2T, 48-57
1-1/2T heavy duty
(6.203-15) \$69.75 PR



3704112 53-54
3/4, 1, 1-1/2T (exc Double-duty,
School Bus chassis, heavy duty)
(6.203-15) \$68.25 PR

Shackles



604478 34-46
Front 34-36 all, 37-40 (exc COE) 41-46
1/2T & 3/4T (7.523-15) \$105.00 SET



609071 39-54
Front COE & 41-46 1, 1-1/2T, 2T
(7.436-15) \$122.00 SET

3847459 47-54
Front (1/2T & 3/4T)
(7.436-0) \$75.00 SET

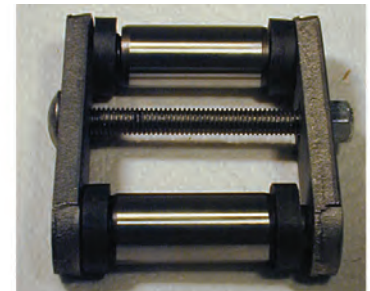

3847460 47-56
Front 1T & larger exc Double Duty &
COE (7.436-15) \$100.00 SET

Shackle Rebuild Kit



373199 30-54
Does 2. Pins, bushings & seals, 1/2T &
3/4T (16 pcs). (7.427-15) \$66.50 SET

Returns require a return authorization number, Please call.

Section 200T: Front Suspension Components, Shocks, King Pins, Rebuild Kits & Shackles

Format = Part No., Year, Description, Original Chevrolet Parts Book Group No., Price and Unit of Measure.



3653273 39-54
Does 2, pins, bushings, seals, 39-40
COE, 41-54 1, 1-1/2T, 2T, Double Duty
(16 piece) (7.427-15) \$50.75 SET

Seals



593705 34-54
Rubber for steel
bushed shackles (8
pcs). (7.443-40) \$11.25 SET

Bolt & Bushing



593990B 37-54
Fixed end front
springs, 1/2T & 3/4T (2
piece) (7.428-15)
\$60.00 SET



3657393 39-54
Fixed end front spring,
41-54 1, 1-1/2T & 2T
(39-40 COE) (7.428-15)
\$46.00 PR

Bumper-Axle



3653084 40-54
Axle (exc Double
Duty & 53-54 3/4,
1, 1-1/2T & 2-ton)
(7.422-15) \$20.00 SET



3700034 52-57
52-54 1T, 53-54 3/4T,
55-57 all. (7.535-15) . .
\$32.25 SET

U-Bolt



601231 34-54
W/ nuts, front axle
to spring, 34-49 1/2,
3/4, 1T & 50-54 1/2T
(7.417-15) . \$11.25 EA

Bolt



1288224 All
Leaf spring center (exc utility vehicle) (2
pcs). (7.506-40) \$2.75 SET

Front Leaf Spring

*Note: Spring Order requires purchase
of fixed end pins & bushings (pressed
in free).*

599316 39-46
1/2T (7 leaves) (7.412-15). \$460.00 PR
3656610 41-46
3/4T (8 leaves) (7.412-15). \$470.00 PR
3702793 47-54
1/2T & 3/4T, exc Double Duty (8
leaves) (7.412-15). \$450.00 PR

*Oversize shipping charges apply to all
Front Leaf Springs. Please call for
rate.*

Liner



3699910T 37-54
For leaf springs. 1-3/4" wide.
(7.495-15) \$50.00 SET

Sway Bar

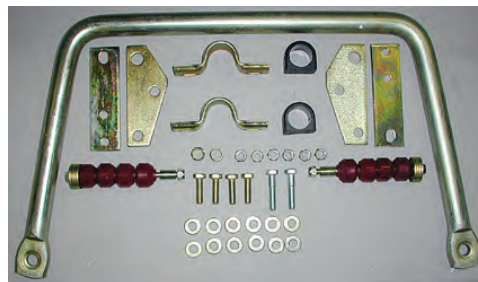

3683028 47-54
Sway bar, front, complete, 1-1/8in.
diameter w/ links and bushings
(7.241-15) \$152.00 SET

Odds & Ends

*Please call for availability on all Odds
& Ends parts; once part is sold, it may
no longer be in stock.*

593044 37-40
Bushing, King Pin, GB, HB, JB, KB, KC
(15-0) \$10.00 EA
3186987U
Delco shock. 14-1/2in. compressed,
22-1/2in. extended. Verify fitment for
your vehicle. (7.345-0) \$20.00 EA
4984842U
Delco shock. 15in. compressed, 23-
1/2in. extended. Verify fitment for your
vehicle. (7.345-0) \$20.00 EA
602691N 37-39
King pin repair kit NOS fits all COMM
(6.203-40). \$25.00 EA
603537N 29-39
King pins NOS .010 over, fits 29-39 1/2
ton & 34-39 3/4 ton (6.203-40).
\$75.00 EA
1054146U 50
Shock front left used fits Double Duty
(7.345-40). \$75.00 EA
301231N 50-55
U-bolts, fits front- 1st series. No nuts
or washers. (-0) \$20.00 PR

200T

Providing part numbers speeds up your order, improves accuracy and helps us maintain low prices.

See Illustration Index for core charge information and a list of abbreviations. For Body Model information, see Section 5T.



Corvette C4 IFS & IRS installation kits for 47-53 Chevy Trucks

Now you can have the ride, superior handling, cornering and braking provided only by the advanced technology built into the Corvette suspension.



Rear kit shown assembled and polished



Front kit shown assembled and polished

STREET ROD HEADQUARTERS now offers quality kits to adapt the late model ('84-'87 and '88-'95) Corvette front and rear independent suspensions to your '47-'55 Chevy truck.



IRS kit shown with optional coil overs

These kits are designed to fit your frame. All brackets are laser cut from cold rolled steel and heli-arc welded for strength and unsurpassed good looks.

These kits utilize Corvette C-4 front and rear suspension components mounted to your frame using the stock Corvette geometry. The real bonus is this system uses the stock Corvette Power Rack and Pinion Steering Unit as designed by GM, eliminating any "bump steer" problems inherent with units from vehicles designed in the '70s with light weight vehicles and economy in mind.



IFS kit shown with optional coil overs

You can have GM sports car handling on your GM manufactured truck. All the Corvette suspension components are manufactured from forged aluminum which allows you to decrease vehicle weight while also maintaining strength and a solid suspension.

Not only will you be amazed at how well your truck rides but how fun it will be to drive with a Corvette front and rear suspension installed. And let's not forget 4-wheel disc brakes designed to mount to your suspension.

Available Aldan Eagle coil over shocks for front or rear allow you to adjust the ride to your liking with 6-position adjustable compression damping and spring rate adjustment also. Rugged construction and combination of oil and gas charging incorporated in each shock are only part of the reason we recommend them with our IFS and IRS kits. Kits come complete with instructions and all hardware.

You'll enjoy the handling and new life brought to your truck with these very affordable suspension kits for years to come.

Front Suspension

- SUSCORF1 84-87 C-4 IFS-front without coil over shocks (see below) \$795.00
- SUSCORF2 88-96 C-4 IFS-front without coil over shocks (see below) \$850.00

Rear Suspension

- SUSCORR1 84-87 C-4 IRS-rear without coil over shocks (see below) \$710.00
- SUSCORR2 88-96 C-4 IRS-rear without coil over shocks (see below) \$725.00

Aldan Coil-Over Shocks

- SHOCKF1 Front shock\$399.00 pr
- SHOCKF2 Front shock w/ chrome springs\$479.00 pr
- SHOCKF3 Front shock w/ polished housing\$454.00 pr
- SHOCKF4 Front shock w/ chrome springs & polished housing\$534.00 pr
- SHOCKR1 Rear shock\$399.00 pr
- SHOCKR2 Rear shock w/ chrome springs\$479.00 pr
- SHOCKR3 Rear shock w/ polished housing\$454.00 pr
- SHOCKR4 Rear shock w/ chrome springs & polished housing\$534.00 pr



Returns require a return authorization number, Please call.



**Keep your GM all GM
with our custom front and rear subframes
designed to fit your chassis using GM-based components**



No longer do you have to go to the junk yard to buy a Camaro or whatever front chassis section to "clip" your car or truck frame. We have been making custom designed front IFS and rear IRS, standard, or stepped chassis subframes for a few years now, and it has become part of our standard product line. We can design a front or rear-steer subframe for any street rod, classic Chevy, large car or truck. Whether you want air bags, coilovers, we will design an IFS subframe that will be the same width as your chassis rails, have the same wheel base, any track width, any step over the front IFS, engine mounts, rack-and-pinion steering, core support mount or whatever is necessary. Computer generated, mandril-bent, custom steps over the IFS is also an option.

Our standard brake packages with these IFS "clips" are the '70-'81 Camaro 11-inch disc brake (5-on-4 3/4) or the '77-'88 Impala/Caprice 12-inch disc brake (5-on-5). We offer steering linkage kits, stock column adapters to splined U-joints, Flaming River or ididit columns to solve your steering hook-up problems.

The rear chassis subframes can be tubbed, stepped, air bagged or whatever you'd like. To complete your new rear clip, we jig-narrow and straighten Ford rearends and use Dutchman alloy axles any spline, any wheel bolt-pattern, big or small bearings, any flange (GM, Ford or Mopar). We also offer a universal rear 4-link kit with two styles of Panhard bars and a universal transmission crossmember/trans mount kit. Both come extra long so you can cut-to-fit for your chassis needs.

Send us the dimensions for a free estimate. Other options include custom bent 1-inch od front-and-rear sway bars, Wilwood or Baer high performance brakes. Complete rearends or housings are available from Hallbrand, Alston's FAB9, new '58 Ford style housings, Championship style, a used housing from our pile or bring your own! We are a dealer for Air Ride Technologies, Baer Racing Brakes, Wilwood and many other popular street rod and classic Chevy manufacturers.

Bring your ride into the 21st century and have a great handling hot rod with a custom subframe! You'll have rack-and-pinion steering, disc brakes, narrower front track for more turning room under the fender, coilovers or air bags, and it will mate perfectly to the width of your existing frame rails. Most of all you'll have all the adjustability we build into all of our other IFS kits and direct replacement chassis!

**Weld-in Front-Steer IFS
for Cars & Pickups
'33-54 Chevy Cars • '33-59 Chevy PU**



This front-steer, independent front suspension (I.F.S.) is designed for those early cars and trucks that have plenty of space in front of the crossmember for the rack-and-pinion steering. The weld-in kits are available for '33-'54 Chevy cars and '33-'59 Chevy trucks in Stage I or Stage II.

The most complete kit, Stage II, features a 2 X 4 X .188-inch wall box-tube crossmember that holds the D.O.M. 1-inch diameter X .156-inch wall lower tubular A-arms and 7/8-inch diameter X .156-inch wall upper tubular control A-arms. Steering is provided by a Flaming River manual rack-and-pinion, while two '70-'81 GM Camaro spindles, ball joints, 11-inch rotors, and calipers give you stock over-the-counter GM parts available most everywhere! With a two-position lower mount and a three-position upper mount, the Hal Corp. aluminum, adjustable coilover-shocks will give the stance you like best!

Our popular Stage I kit (designed to use the Stage II components) features everything in the Stage II kit except the spindles, balljoints, rotors, calipers, and rack.

Your options (can be substituted at an additional cost) include a '83-'89 T-Bird power rack, chrome A-arms, 12-inch diameter rotors, bolt-pattern changes, front sub-frames, anti-sway bars, and different tread-widths are available.

We offer stance adjustability like no one else!

All of our IFS kits with either air bags, ShockWave™ units or coilovers have an adjustable upper A-arm tower-mount that gives you about 3-inches of adjustment up-and-down. All of our lower A-arms have a two position lower mount for coilovers or ShockWave™ Air Ride systems. At the rear of our chassis, you'll find a three-position mount for either coilovers or shocks. Combine this with the adjustability of our Hal coilovers and you'll have 3-4-inches of stance adjustment up front and the same at the rear with any of our IFS kits, chassis clips, or direct replacement chassis!

The basis for all our IFS kits

You'll notice there is one thing in common about all our IFS kits, and that's the use of the stock GM '70-'81 Camaro front spindle. We've really chosen this spindle for the benefit of our customers. Let me point out why we like these front-steer spindles so much! They offer either an 11 or 12-inch GM brake package with 2-15/16-inch diameter caliper pistons, vented rotors on the same balljoints using either the 11- or 12-inch spindle. These very popular balljoints were used by GM on their mid-sized cars from '73-'88, and on '77-'88 Caprice/Impala (12-inch disc brakes, most with 5-on-5 bolt pattern) and the '70-'81 Camaro with 11-inch brakes (5-on-4 3/4 pattern).



So what does this mean to you? The brake options using these spindles are better than anything else over the counter! We use very common, easy-to-find parts at the junk yard or over-the-counter at any parts house! With our product line, you can have either 11- or 12-inch (Delco caliper) disc brakes without having to change a thing! This caliper applies much more pressure on the rotor than later down-sized versions!

This also means to our customers on a budget that buying our economical Stage I kits lets you save about \$800 (over the complete Stage II)! Every kit is available in a Stage I form! The Stage I allows you to provide spindles, rotors, calipers, balljoints, and rack from a donor car or directly over the counter from any parts house in the USA or Canada! All of our IFS kits are alignable at any frontend shop or GM dealer!

Providing part numbers speeds up your order, improves accuracy and helps us maintain low prices.

See Illustration Index for core charge information and a list of abbreviations. For Body Model information, see Section 5T.



Section 205T: Front & Rear Suspension

Format = Part No., Year, Description, Original Chevrolet Parts Book Group No., Price and Unit of Measure.



Independent Front Suspension

Weld-in Standard Front Steer IFS w/ 11" Rotors	.2795.00
Weld-in Standard Front Steer IFS—Stage 1	.2755.00
Bolt-in Standard IFS (additional)	+200.00
Weld-in Standard Front Steer Pickup IFS-11" Rotors	.2795.00
Weld-in Standard Front Steer IFS—Stage 1	Call
Weld-in Standard Front Steer IFS w/ 12" Rotors	Call
Weld-in Heavy Duty Front Steer IFS—Stage 1	Call
Weld-in Standard Rear Steer IFS w/ 11" Rotors	.2895.00
Weld-in Standard Rear Steer IFS—Stage 1	Call

Independent Front Suspension Options (Additional)

Air Suspensions

Air Ride Tech. Shocks – pr.	.630.00
Air Comp. Kit – 2 Wheel (ARC4000E)	.1495.00
Add Shock Wave to Rear Suspension Kit	.630.00
Anti-Sway Bar Kits – Standard Front	.195.00
Anti-Sway Bar Kit – Heavy-duty NASCAR Bar	.295.00
12" Rotors & Calipers – Upgrade	.250.00
Change rotor bolt pattern.	.150.00
Steering Hook-up Kit (2 pc.)	.205.00
Steering Hook-up Kit (3 pc.)	.379.00
Baer Brakes – Front, 12" or 13"	from 1780.00
Baer Brakes – Rear 12"	from 1200.00
Drill-slot-zinc wash-rotors (pair)	.85.00
Front Wilwood Brake Kit 12":	
Drilled Rotors	from 1050.00
Polished & Drilled	from 1200.00
Front 13" add \$630 to above	
Rear Wilwood Brake 12" with E. Brake	
Drilled Rotors	from 1050.00
Polished & Drilled	from 1200.00
Rack & Pinion Fittings (pair)	.37.00
Drilled-Slotted Rotors 11" (pair)	from 205.00
Corvette P.S.	.940.00
(Pumps, pulleys – bracket, hoses, side motor mounts)	

Rear Suspension

4-bar Kits	.1095.00
4-link Kits with 4130 Rod Ends	.1295.00
Panhard Rod Assembly	.150.00
G-4 Panhard Rod	.295.00

Lower Shock Mounts (Standard or G-4)	.135.00
Coilover Crossmember (Standard or G-4)	.100.00
G-4 Rear Suspension Kit	.1195.00
Rear Sub Frame	.1095.00
9" Housing (any width)	.1195.00
(Suspension kit installed with new Dutchman axles and bearings. Suspension kit additional.)	
Fabricated 9" Housing (additional)	.400.00
Engine & Transmission Mount Kits	.300.00
Trans/Motor Mount Kit/Energy Suspension M/M	.425.00
Motor Mounts (frame brackets)	.150.00
Manual Master Cylinder	.230.00
Brake Booster & Master Cylinder 7"	.189.00
Brake Pedal	
7" Booster and Master Cylinder	.369.00
8" Booster (upgrade)	.105.00
Clutch Pedal (additional)	.45.00
53-62 Corvette Master Cylinder Kit (manual)	.310.00
53-62 Corvette Master Cylinder Kit (power)	.625.00
Rod Ends (teflon lined):	

	1018	4130
3/8"	11.00	16.00
1/2"	15.00	22.00
5/8"	19.00	27.00
3/4"	21.00	34.00
Urethane Bushings	.6.00	
3/4" Adjuster with Bushings	.26.00	
Tri-5 Rear Ladder Bar Kit	.995.00	

I.F.S. Parts

Heavy-Duty "A" Arms

Lower (pair)	.450.00
Top (pair)	.250.00
Ball Joints (most)	.26.00
Ball Joints Boots (each)	.6.00
Front Subframe or Rear Subframe	.1095.00
Tie Rod Ends & Adapters	.100.00
Pivot Shaft Assemblies (pair)	.100.00
QA1 Coilover Shocks with Springs	.320.00
QA1 Adjustable Shocks with Springs	.420.00
QA1 Double Adjustable Shocks with Springs	.735.00
Coilover Springs (pair)	.100.00
Bolt-On Top Shock Mount (pair)	.85.00
Crossmember Assembly (most models)	.680.00
Core Support Crossmembers	.150.00
Spindles:	
Front Steer ('67-'72 GM 11")	.260.00
Rear Steer (new with arms, pair)	.260.00
Dropped Spindles	.225.00
Stainless Brake Hose Kit	.89.00

Returns require a return authorization number, Please call.

Section 205T: Front & Rear Suspension

Format = Part No., Year, Description, Original Chevrolet Parts Book Group No., Price and Unit of Measure.



All New '47-'53 5-Window Cab

Save time and money!
No rust repair or panel
replacement needed!

Comes with doors
mounted. Choose with
'47-'50 non-vent window
or '52-'53 vent windows.

\$8,995

+ shipping and crating fees

'47-'53 Chevy Truck Chassis

Start off on the right foot with this CAD-engineered chassis. 2" x 8" fully boxed rails and a rigid "K" member designed for strength and durability. Order as Base or Complete Chassis. Call for complete information.

Base Chassis includes:

- 6 Bolt-on running board brackets
- Cab mounts
- Front body mount
- Engine & transmission mounts
- Complete Mustang II front end
- Brake pedal & bracket
- Currie 9" rear axle housing with 31 spline axles (standard)
- Rear parallel leaf spring kit
- Rear shocks

Starting at **\$6,892**

Options & Upgrades

- Tubular IFS front end
- Chrome/stainless front suspension upgrade
- 4-Link rear suspension
- 3rd members
- Air bag suspension upgrade
- Sway bars
- Steel brake lines installed

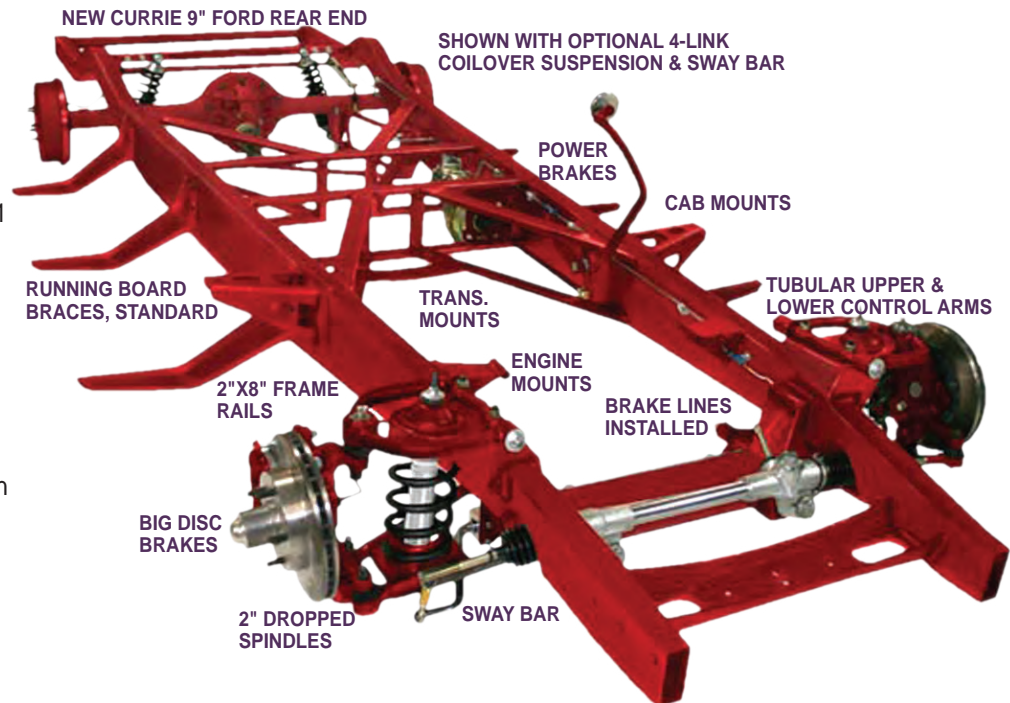

205T

Providing part numbers speeds up your order, improves accuracy and helps us maintain low prices.

See Illustration Index for core charge information and a list of abbreviations. For Body Model information, see Section 5T.



Section 210T: Rear Suspension, Lowering Kits, Rebuild Kits, Shocks & Hardware

Format = Part No., Year, Description, Original Chevrolet Parts Book Group No., Price and Unit of Measure.

Lowering Blocks



- 373201A
1", w/ u-bolts. (7.427-20) ...\$60.00 EA
- 373201B
2", w/ u-bolts. (7.427-20)\$60.00 SET
- 373201C
3", w/ u-bolts. (7.427-15)\$60.00 SET

Shock Conversion Kit



- 3700440B..... 47-49
W/ gas shocks (4), 1/2T.
(7.395-15) \$351.50 SET

Single Action Shock



- 1054421..... 34-49
Left rear, 1/2Tt, #1430MA (\$50 core).
(7.345-15)\$171.00 EA
- 535256..... 34-49
Right rear, 1/2T, #1430LP (core \$50).
(7.345-15) \$171.00 EA

Dual Action Shock



- 1054425..... 34-47
Left rear, #1731-U (\$50 core).
(7.345-15)\$162.00 EA
- 1054424..... 34-47
Right rear, #1731-T (\$50 core).
(7.345-15)\$162.00 EA
- 1054424..... 48-49
Left rear, #1731-T (\$50 core).
(7.345-15) \$162.00 EA

- 1054425..... 48-49
Right rear, #1731-U (\$50 core).
(7.345-15)\$162.00 EA

Shocks



- 5516239G..... 47-54
Rear, 1/2T (original 50-54 will fit 47-49
w/ conversion). (7.345-15) \$50.75 PR
- 5394579G..... 47-54
Rear, 3/4T (original 50-54 will fit 47-49 w/
conversion).
(7.345-20) \$65.00 SET

Tube Shock Mounts



- 3700440..... 47-54
Upper front or rear.
Fits 1/2T (replacement
for 50-54). (7.395-15).
\$35.25 EA



- 3655328..... 47-54
Lower rear, left or right, 1/2T
(replacement for 50-54).
(7.395-15) \$24.50 EA

Bushing



- 041133..... 30-49
Shock link. 1/2T &
3/4T. (7.388-15)
\$9.00 PR



- 041133B..... 30-49
Shock link single
action w/ brass
bushings, pins & cotter
keys for beam axle.
Superior. (7.388-15) ..
\$12.25 PR



- 041153..... 33-53
In shock arm, rubber,
double action. (7.377-15)
\$8.00 EA



- 043816..... 33-53
Shock link double action shock 33-46
all, 47-49 1/2, 3/4, 1T & 50-55 double
duty. (7.388-15) \$7.25 SET

Bushings -Shock



- 3708378..... 50-57
Shock, rubber (8), w/ washers & nuts.
(7.388-15)\$14.25 SET

Bolt & Bushing



- 593990B..... 34-54
Front of rear spring,
1/2T. (7.428-15)
\$60.00 PR

Shackles -Rear



- 350441..... 34-54
1/2T & 3/4T (2 pcs).
(7.523-15)\$90.00 SET

Shackle Rebuild Kit



- 373199..... 30-54
Does 2. Pins, bushings & seals, 1/2T &
3/4T (16 pcs). (7.427-15)\$66.50 SET

Returns require a return authorization number, Please call.

Section 210T: Rear Suspension, Lowering Kits, Rebuild Kits, Shocks & Hardware

Format = Part No., Year, Description, Original Chevrolet Parts Book Group No., Price and Unit of Measure.



3725531B 33-55
3/4T, 1T & Utility (exc Panel).
(7.573-15) \$131.50 SET

Grease Fitting



191758 All
1/8in. national pipe,
straight. (8.984-40) . . .
\$1.50 EA



110347 All
1/4in. x 28 taper
thread, 90 degree.
(8.984-40) . . \$1.50 EA

Seals -Shackle



593705 34-54
Rubber for steel
bushed shackles (8
pcs). (7.443-40) \$11.25 SET

Bushing



3652182A 48-54
Bolt w/ nut, rear end to spring, 1/2T.
(5.403-15) \$27.25 PR

Bumper -Rear Axle



365627 34-46
1/2T (7.535-15)
\$32.25 PR



3700034 52-57
52-54 1T, 53-54 3/4T,
55-57 all. (7.535-15) . .
\$32.25 SET

U-Bolt



602509 31-46
Rear axle to spring, 1/2T.
(7.417-15) \$11.25 EA
601231 47-54
W/ nuts, rear axle to spring pivot, 1/2T.
(7.417-15) \$11.25 EA

Bolt



1288224 All
Leaf spring center (exc utility vehicle) (2
pcs). (7.506-40) \$2.75 SET

Teflon Liner



3699910T 37-54
For leaf springs. 1-3/4" wide.
(7.495-15) \$50.00 SET

Rear Leaf Spring

Note: Spring order requires purchase of fixed end pins & bushings (pressed in free).



SPECIFY65T 37-54
Original springs will allow severe axle
wrap w/ the torque tube removed and
these are needed for an open drive
shaft. Also helps to center axle in wheel
wells.
Can be made with arch to lower vehicle.
(7.503-15) \$521.00 EA

3659368 36-46
1/2T (8 leaves).
(7.503-15) \$625.00 PR
3656559 41-54
3/4T (7 leaves).
(7.503-15) \$615.00 PR
3683317 47-54
1/2T (8 leaves).
(7.503-15) \$635.00 PR

Upsize shipping charges apply to all Rear Leaf Springs. Please call for rate.

Odds & Ends

Please call for availability on all Odds & Ends parts; once part is sold, it may no longer be in stock.

042852 39-54
Shock absorber link pin, fits 33-
50 COMM CT or 33-55 1.5 ton rear
(9.65-0) \$2.00 EA
3656558 46-47
U-bolt fits 1-1/2T, School bus chassis &
panel (7.516-40) \$20.00 EA

210T

Providing part numbers speeds up your order, improves accuracy and helps us maintain low prices.

See Illustration Index for core charge information and a list of abbreviations. For Body Model information, see Section 5T.



Section 220T: Wheels, Hub Caps, Beauty Rims, Tires & Wheel Bearings

Format = Part No., Year, Description, Original Chevrolet Parts Book Group No., Price and Unit of Measure.

Custom Wheels group#05.803



Wheels require modified hubcaps, which are sold separately—refer to the following pages for available hubcaps

	AB	AC	NB	NCC	NC	RB	RCC	RC
	Artillery Bare	Artillery All Chrome	Nostalgia Steel Bare (Smoothie)	Nostalgia Steel Bare Center w/ Chrome Rim (Smoothie)	Nostalgia Steel All Chrome (Smoothie)	Rally Bare	Rally Bare Center w/ Chrome Rim	Rally All Chrome
size								
14 x 5			\$60.50	\$78.00	\$74.00	\$60.50	\$78.00	\$74.00
14 x 6			\$60.50	\$78.00	\$74.00	\$60.50	\$78.00	\$74.00
14 x 7			\$64.50	\$88.50	\$82.00	\$64.50	\$88.50	\$82.00
15 x 5	\$130.50	\$197.00	\$64.50	\$88.50	\$82.00	\$64.50	\$88.50	\$85.00
15 x 6	\$134.00	\$197.00	\$66.00	\$88.50	\$82.00	\$66.00	\$88.50	\$85.00
15 x 7	\$138.00	\$203.00	\$71.00	\$93.50	\$85.00	\$71.00	\$93.50	\$85.00
15 x 8	\$141.00	\$208.00	\$77.00	\$101.50	\$92.00	\$77.00	\$101.50	\$92.00
15 x 10	\$173.00	\$238.00	\$89.00	\$126.50	\$112.00	\$89.00	\$126.50	\$112.00
15 x 12	\$246.00	\$310.00	\$155.00	\$187.50	\$186.00	\$155.00	\$187.50	\$195.00
15 x 14	\$256.50	\$333.00	\$166.50	\$199.00	\$195.00	\$166.50	\$199.00	\$195.00
16 x 6			\$104.00	\$122.00	\$115.00	\$104.00	\$122.00	\$115.00
16 x 7			\$106.25	\$134.50	\$117.00	\$106.25	\$134.50	\$117.00
16 x 8			\$119.00	\$146.50	\$122.00	\$119.00	\$146.50	\$122.00
16 x 10			\$143.00	\$164.00	\$164.00	\$143.00	\$164.00	\$164.00
16 x 12			\$175.00	\$197.00	\$182.00	\$175.00	\$197.00	\$182.00

**All 16" wheels use modified hubcaps for rally wheels only • Note: Artillery wheels use nostalgia caps.*

Backspacing	14x5	14x6	14x7	15x5	15x6	15x7	15x8	15x10	15x12	15x14	16x6	16x7	16x8	16x10
Standard Backspace	3	3-1/4	3-1/2	2-3/4	3-1/2	4	4-1/4	4-1/2	4-1/4	4-1/4	3-3/4	4	4-5/8	4-1/2
Minimum (on standard)	3	3-1/4	3-3/4	2-3/4	3-1/2	4	4-1/4	4-1/2	4-1/4	4-1/4	3-3/4	4	4-1/4	4-1/2
Maximum (on standard)	3-5/8	4-1/4	5-1/4	3-1/4	4-1/4	5	5	7-1/2	9-3/4	11-3/4	4-1/4	5-1/4	6-1/4	7
Reverse (minimum)	1-3/4	1-3/4	1-3/4	2	2	2	2	2-1/2	2-1/2	2-1/2				
Reverse (maximum)	2-5/8	3	3-1/2	2-5/8	2-3/4	3-1/8	4-1/4	5-3/4	7-1/2	9-1/2				

Backspacing Min/Max - Artillery Wheels

Minimum (on standard)				2-1/2	3-1/2	3-3/4	4	4-1/2	4-1/2	4-1/2
Maximum (on standard)				3	4	5	5-3/4	7	8-1/2	9-1/2

Bolt Patterns
 5 on 4-1/2" Ford
 5 on 4-3/4" Chevy
 6 on 5-1/2" Chevy
 (6 lug for 15" & 16" wheels only)

Measure your installation carefully!

Deep back spacing on front wheels can sometimes cause interference between rim and disc brake caliper.

Note: to order wheels choose style code [to row] & add size [left column]
 Example: "NCC14x7"

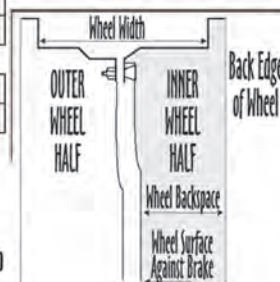

Returns require a return authorization number, Please call.



Hub Caps -Modified

5% discounts for sets of 4



594453MS 37-38
Stainless. Modified for nostalgia wheel.
(5.858-15) \$58.75 EA

594453MRS 37-38
Stainless. Modified for rally wheel.
(5.858-15) \$58.75 EA

594453MR 37-38
Chrome. Modified for rally wheel.
(5.858-40) \$75.50 EA



599748MS 39
Stainless. Modified to fit nostalgia
wheel. (5.858-15) \$58.75 EA

599748M 39
Chrome. Modified to fit nostalgia wheel.
(5.858-40) \$75.50 EA

599748MRS 39
Stainless. Modified to fit rally wheel.
(5.858-20) \$58.75 EA

599748MR 39
Chrome. Modified to fit rally wheel.
(5.858-40) \$75.50 EA



654307M 40
Chrome. Modified to fit nostalgia wheel.
(5.858-40) \$75.50 EA

654307MR 40
Chrome. Modified to fit rally wheel.
(5.858-40) \$75.50 EA



3658374M 41-48
1941-48 Passenger (41-46 Commercial
exc 46 1T). Modified to fit Nostalgia
wheel. (5.858-20) \$75.50 EA

3658374MR 41-46
1941-48 Passenger (41-46 Commercial
exc 46 1T) Modified to fit rally wheel.
(5.858-20) \$75.50 EA



3705092A 47-53
1/2T, modified to fit nostalgia wheel.
(5.858-15) \$63.00 EA

3705092AR 47-53
1/2T, modified to fit rally wheel.
(5.858-40) \$63.00 EA

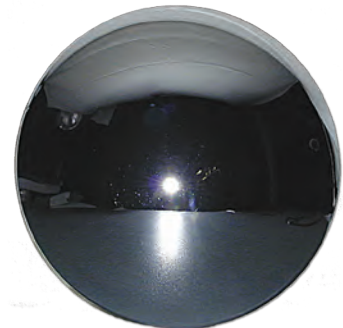

3705092M 37-48
(Set only) Baby moon, 37-46 1/2T & 37-
41 3/4T. (5.858-30) \$168.00 SET

3908671
Police, plain. Fits nostalgia wheel.
(5.858-40) \$20.50 EA



3908672
Police, plain. Fits rally wheel.
(5.858-40) \$37.50 EA



3908673 All
Police w/ bowtie. Fits rally wheel
(5.858-15) \$37.50 EA

Hub Caps -Custom



HCAPCROSS15
15 inch Crossbar style.
(5.858-0) \$178.50 SET

220T



Section 220T: Wheels, Hub Caps, Beauty Rims, Tires & Wheel Bearings

Format = Part No., Year, Description, Original Chevrolet Parts Book Group No., Price and Unit of Measure.

HCAPCROSS14
14 inch Crossbar style.
(5.858-0) \$178.50 SET



HCAPLANCERB15
15 inch 57 Lancer style.
(5.858-15) \$178.50 SET

HCAPLANCERB14
14 inch 57 Lancer style.
(5.858-15) \$178.50 SET

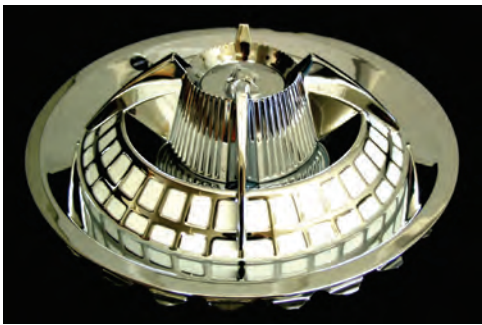

HCAPLANCER. 37-54
15 inch 59 Lancer style.
(5.858-15) \$359.00 SET



37050920. 37-54
15" Nude Figure. Chrome.
(5.858-15) \$357.00 SET

3705092N 37-54
14" Nude Figure. Chrome.
(5.858-15) \$306.00 SET

Valve Stem Cap



CROWNCAPR
Crown cap. Red plastic (5 pcs).
(5.804-15) \$5.25 SET

Nude Lady



3705092H
3 dimensional nude
figure handle or
hubcap ornament.
Chrome, 12-1/4in.
length. (5.858-15). . . .

\$38.75 EA

Hub Caps -Stock

5% discounts for sets of 4



2019471. 37-46
GMC 1/2T & 37-41 GMC 3/4T.
(5.858-15) \$32.75 EA



594453S. 37-38
Stainless (5.858-15) \$39.50 EA



599748S. 39
Stainless (5.858-15) \$39.50 EA

654307S 40
Stainless
(5.858-15) \$39.50 EA



594453. 37-38
(5.858-15) \$75.00 EA



654307. 40
Chrome (5.858-0) \$52.50 EA



3658374S. 41-48
Stainless 1941-48 Passenger
(41-46 Commercial exc 46 1T)
(5.858-15) \$30.75 EA



3705092. 47-53
1/2T. Chrome. (5.858-15) \$40.75 EA

Returns require a return authorization number, Please call.

Section 220T: Wheels, Hub Caps, Beauty Rims, Tires & Wheel Bearings



Format = Part No., Year, Description, Original Chevrolet Parts Book Group No., Price and Unit of Measure.

3705092S 47-53
1/2T. Stainless steel.
(5.858-15) \$50.00 EA



3680919 47-53
Chrome with red (3/4, 1T)
(5.858-15) \$48.50 EA



3705092P 47-53
GMC chrome with white lettering. 1/2T
only (5.858-15) \$28.50 EA
3705092G 47-53
GMC chrome with red lettering. 1/2T only
(5.858-15) \$28.50 EA



3708057 54
Superior 1/2T (5.858-15) \$52.50 EA
3708057C 54
1/2T
(5.858-15) \$28.50 EA



3708058 55-59
GMC 1/2T (superior)
(5.858-0) \$210.00 SET



3704844 39-53
Retaining clip. Fits 39-
53 Pass & 1/2T truck.
(5.864-15) . . \$1.50 EA

Decal Hub Cap



3705092R 47-53
Red (set of 4) (5.858-15) \$8.00 SET



3705092K 47-53
Black (set of 4) (5.858-15) . . . \$10.00 SET

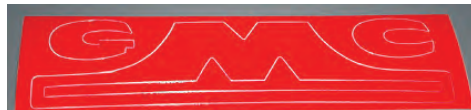

3705092GR 47-55
GMC decal. Red (set of 4)
(5.858-15) \$10.00 EA



3705092GK 47-55
GMC decal. Black (set of 4)
(5.858-15) \$7.50 EA



3705092GW 47-55
GMC decal. White (set of 4)
(5.858-15) \$10.00 SET

Beauty Ring



986259S
SMOOTH. 15in.
(outer wheel).
(5.858-15) \$26.00 EA



1279680S
SMOOTH. 16in.
(outer wheel).
(5.858-15) \$28.00 EA

Beauty Rings



986259 All
15in. (outer
wheel)-ribbed.
(5.858-15) \$26.00 EA



1279680 All
16in. (outer
wheel)-ribbed.
(5.858-15) \$28.00 EA

Tires

*Overize shipping charges apply.
Please call for rate.*

Tire - White Wall, Radial

*Note: All tires must be inflated to
manufacturers recommended PSI.*



368981R All
(670x15) Coker classic. 2-3/8in. white
wall (5.804-0) \$205.00 EA

368982R All
(670x16) 3in. white wall
(5.804-0) \$219.00 EA

3693215R All
(650x16) 3-1/2in. white wall
(5.804-0) \$199.00 EA

Providing part numbers speeds up your order, improves accuracy and helps us maintain low prices.

See Illustration Index for core charge information and a list of abbreviations. For Body Model information, see Section 5T.



Section 220T: Wheels, Hub Caps, Beauty Rims, Tires & Wheel Bearings

Format = Part No., Year, Description, Original Chevrolet Parts Book Group No., Price and Unit of Measure.

Tire - Black Wall, Radial



599887R. All
(600x16) BF Goodrich. Made from original molds. (5.804-0)\$211.00 EA

Tire - White Wall, Bias Ply



599886. All
(600x16) BF Goodrich 3-1/2in. white wall. Made from original molds. (5.804-0)\$159.00 EA
3693215. All
(650x16) BF Goodrich 3-3/4in. white wall (5.804-0)\$166.00 EA
3693215F. All
(650x16) Firestone 3-1/4in. white wall. (5.804-0)\$166.00 EA
368981. All
(670x15) BF Goodrich 3-5/8in. white wall tubeless (5.804-0)\$158.00 EA

Tire - Black Wall, Bias Ply



599887. All
(600x16) BF Goodrich. 4 ply. Made from original moulds. (5.804-0)\$133.00 EA
3693215B. All
(650x16) BF Goodrich. (5.804-0)\$143.00 EA
368981B. All
(670x15) BF Goodrich. Tubeless. (5.804-0)\$136.00 EA

Tire Care



WHITEWIPE
White wall tire wipes. 7" x 9" wipe. 35 per container.
(-15)\$6.00 EA

Tube



599885. All
600-650 x 16 (5.804-15)
\$18.50 EA

Valve Stem Cap



599884. All
Original metal style (5 pcs)
(5.804-40)\$6.50 SET

Tinnerman Nuts

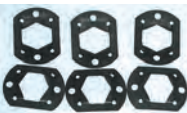

365897. All
Retains rear brake drum (6 pcs). (5.81-40)
\$3.75 SET

Lug Nut



358501. 29-57
Pass Car, 1/2T & 29-42 3/4 & 1T (5.813-40)
\$1.00 EA

Stud For Lug Nut



370465. 36-50
Front 1/2T & 36-42 3/4, 1T (5.812-20) . . .
\$3.50 EA



476515. 51-57
Front 1/2T (5.812-40) .
\$3.25 EA



375696. 36-57
Rear 1/2T & 36-42 3/4, 1T (5.812-20)\$3.00 EA

Spindle Nut & Washer



379656. 35-57
1-1/2T& 2T, 46-57 3/4T (6.022-15)
\$7.50 SET



378137. 40-54
1/2T & 40-42 3/4, 1T
(6.022-20) . \$6.75 SET

Dust Cover

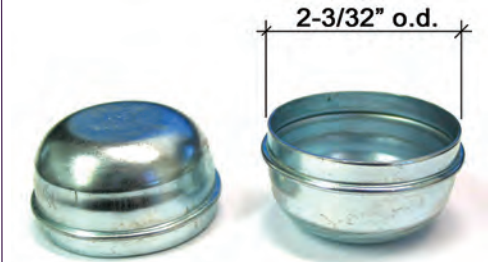

370262. 36-54
Front wheel bearing dust cover.
Fits 1/2T & 36-42 3/4T & 1T
(5.858-20)\$10.50 PR

Front Wheel Bearing Seal



352488. 29-40
Cars & 1/2t trucks.
(6.326-30) . \$20.75 EA

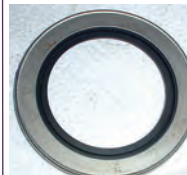

379654. 35-57
1-1/2T, 46-57 3/4 & 1T exc 42 bus, 51-52 1-1/2T & heavy duty
(6.326-15) . \$30.50 EA



3656536. 41-57
1/2T, 41-42 3/4 & 1T
(6.326-20) . \$14.00 EA

Front Wheel Bearing -Inner



909002. 29-40
Inner. Front wheel. Fits Pass, 1/2T & 3/4T (6.311-15) \$95.00 EA

909026. 35-52
35-42 utility, 46-50 3/4, 1, 1-1/2T; 51-52 3/4 & 1T
(6.311-15) \$64.50 EA

909052. 41-57
Inner. Fits 41-42, 1/2T, 3/4, 1T
(6.311-15) \$74.75 EA

Returns require a return authorization number, Please call.



Format = Part No., Year, Description, Original Chevrolet Parts Book Group No., Price and Unit of Measure.

909046. 53-57
3/4, 1, 1-1/2T
(6.311-30) \$68.25 EA



909002R. 29-40
ROLLER replacement. Inner,
front. PASS & 1/2T & 3/4T.
(6.311-15) \$96.00 EA

909026R 35-52
Roller replacement 35-42 utility, 46-50 3/4,
1, 1-1/2T; 51-52 3/4 & 1T
(6.311-15) \$134.75 EA

909052R 41-57
Inner. Roller replacement. Fits 1/2T, 41-42
3/4, 1T
(6.311-15) \$59.25 EA

909046R 53-57
Roller for 3/4T, 1T & 1-1/2T (not original).
(6.311-15) \$88.75 EA

Front Wheel Bearing -Outer



909001. 29-57
Outer. Fits Pass and 1/2T & 29-42 3/4T
(6.313-15) \$35.00 EA

909025. 35-52
35-42 1-1/2T, 2T; 46-50 3/4, 1, 1-1/2T; 51-
52 3/4 & 1T
(6.313-15) \$36.00 EA

173238. 46-49
2T & bus with 15/16in. diameter hole (49
early)
(6.313-15) \$99.50 EA

188932. 46-57
3/4T, 1T rear
(5.855-15) \$70.00 EA

909045. 53-57
3/4, 1, 1-1/2T
(6.313-15) \$43.00 EA

Roller Bearing Conversion



909001R. 29-57
ROLLER replacement. Outer.
Fits Pass & 1/2T & 29-42 3/4T
(6.313-15) \$47.00 EA



BEARINGKIT 41-57
Convert your ball bearings to
roller. For both sides of front end.
(6.311-15) \$183.75 SET

909025R 35-52
Roller replacement. Outer. (35-42 1-1/2T,
2T; 46-50 3/4, 1, 1-1/2T; 51-52 3/4 & 1T)
(6.313-15) \$83.25 EA

909045R 53-57
Roller replacement. Outer. For 3/4T, 1T &
1-1/2T (not original).
(6.313-15) \$95.75 EA

Odds & Ends

Please call for availability on all Odds & Ends parts; once part is sold, it may no longer be in stock.

986108N 47-48
Accy. Tire Tracks to get out of snow
and sand. (-40) \$100.00 SET

986358U 49-50
Accy. Wheel Cover (Used) (16-40) . . .
\$45.00 EA

12380 48
Accy. Wheel Covers, 16in. (Used)
(16-40) \$65.00 EA

909066 60-61
Front wheel bearing-inner, fits 1/2 ton
(6.311-40) \$25.00 EA

3658374U 41-48
Hub Cap (Used) (16-0) . . . \$25.00 EA

3705092AD. 47-53
Hub Cap-1/2T-modified Nost
(Imperfect) (5.858-40) \$30.00 EA

654307MD. 40
Hub Cap-modified for Nostalgia Wheel
(Imperfect) (5.858-40) \$42.50 EA

909602U 46-57
Inner bearing cup, NOS fits 1/2 ton
(6.316-40) \$30.00 EA

3653926 40-47
Lock, Axle Shaft Bolt (Utility) (13*000-0)
\$2.00 EA

370957 29-38
Oil Deflector, Front Hub, Straight
(14-40) \$6.00 EA

379655 42-50
Oil Deflector, Front Hum 1-1/2T
(15-000-0) \$5.00 EA

3689081N. 40-47
Rear Wheel Hub Conversion Kit
(Utility) (13-000-40) \$25.00 EA

909702 29-50
Wheel bearing separator assembly
w/ balls inner fits all pass & 1/2 ton
(6.318-40) \$30.00 EA

5453701 54-56
Wheel cylinder cups-front 7/8in. o.d.
(4.665-0) \$0.50 EA

985705 41-42
Wheel discs w/o ribs. Needs
rechromed (16-40) \$150.00 EA

220T

Providing part numbers speeds up your order, improves accuracy and helps us maintain low prices.

See Illustration Index for core charge information and a list of abbreviations. For Body Model information, see Section 5T.



Section 230T: Bumpers, Bumper Brackets, Splash Aprons, License Brackets, & License Frames

Format = Part No., Year, Description, Original Chevrolet Parts Book Group No., Price and Unit of Measure.

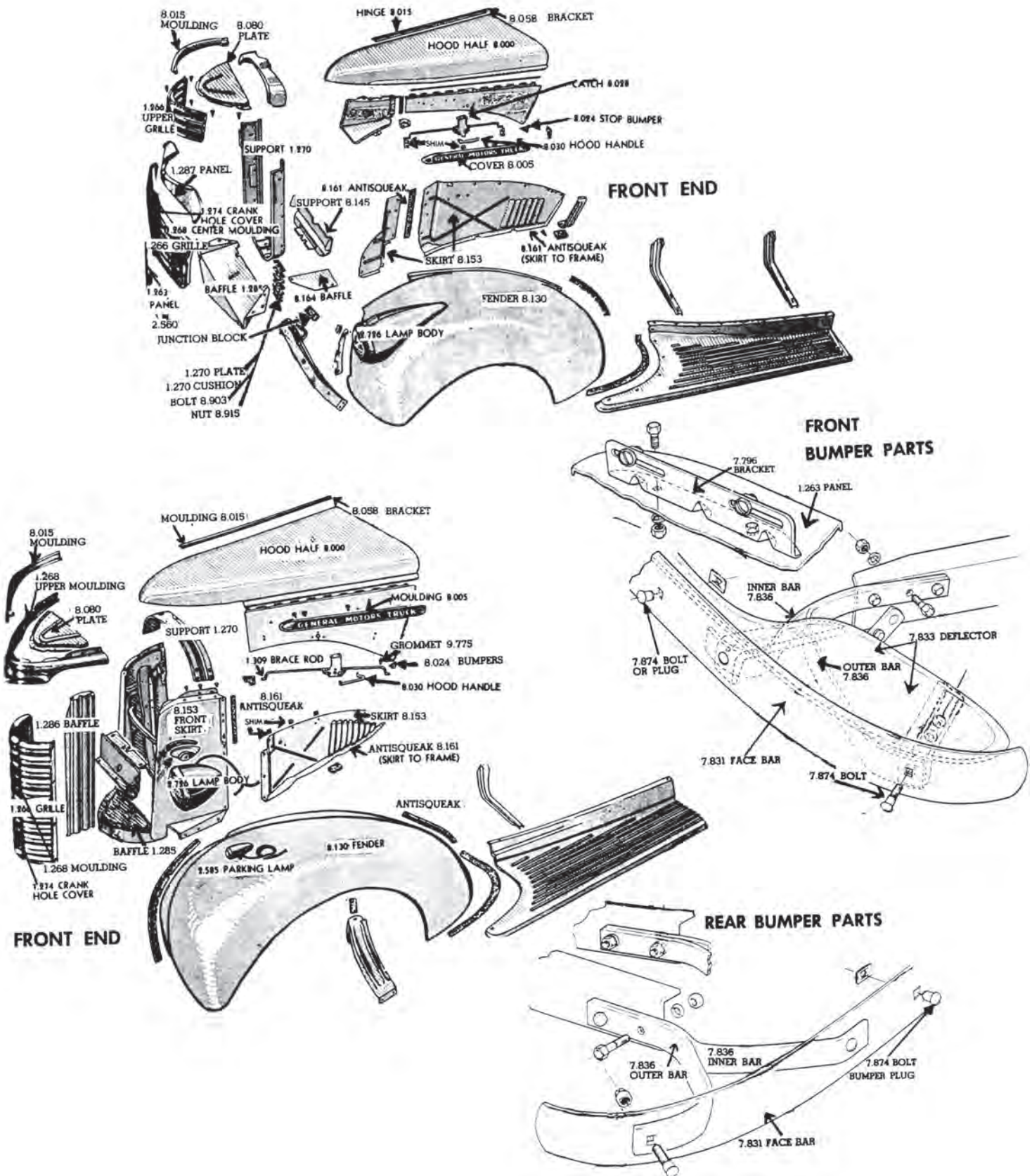

Returns require a return authorization number, Please call.

Section 230T: Bumpers, Bumper Brackets, Splash Aprons, License Brackets, & License Frames

Format = Part No., Year, Description, Original Chevrolet Parts Book Group No., Price and Unit of Measure.



Briz Bumpers



BRIZ5RIB-C 47-53
5 rib polished alloy bumper. Fits
47-54 Chevy trucks. 4-1/2" face
(does not include brackets or bolts).
(-0) \$353.50 EA



BRIZ3RIB
3 rib, fully polished
(on both sides) alloy
bumper. Fits 28-40
Chevy cars. 2-7/8"

face. (7.831-0) \$217.25 EA



BRIZ5RIB
Original 5 rib, fully
polished (on both
sides) alloy bumper.

Fits 35-48 Chevy cars, 41+54 Chevy
trucks. 4-1/2" face. Mount Front or
Rear. (7.831-15) \$231.00 EA



BRIZ5RIB-SH
Original 5 rib polished
alloy bumper.
Fits 49-53 Chevy
cars, 41-54 Chevy
trucks. 4-1/2" face.

(7.831-0) \$227.25 EA



BRIZBOLT
Polished, Stainless
bumper bolt. Radiused
head to fit over ribs.

(-15) \$7.75 EA

Bumper Brackets -Alloy



BRACKETYFP-C.
47-54
Polished, "Y" style for
5 rib contoured front
bumper, 47-54 Chevy
Trucks. (-15)

\$239.00 L&R



BRACKETYFP
Polished, "Y" style
front. Call for your
specific application.
Fits BRIZ & other

bumpers for 37-48 (some 35-36) Chevy
cars, some 37-54 Chevy trucks, 37-41
(some 33-36) Ford cars & some 33-41
Ford trucks. (-15) \$239.00 L&R



BRACKETYRP
Polished, "Y" style
rear. Call for your
specific application.
Fits BRIZ & other

bumpers for 37-48 Chevy cars, some
37-54 Chevy trucks, 37-41 Ford cars &
some 33-41 Ford trucks. (-15)
\$239.00 L&R



BRACKETJFP
Polished, "J" style
front. Call for your
specific application.
Fits BRIZ & other

bumpers for most 37-54 Chevy trucks,
28-32 (some 33-36 & 46-57) Ford cars
& most 28-56 Ford trucks. (-0)
\$179.00 L&R



BRACKETJRP
Polished, "J" style
rear. Call for your
specific application.
Fits BRIZ & other

bumpers for most 23-
54 Chevy trucks, 28-32 (some 46-57)
Ford cars & most 28-56 Ford trucks.
(-15) \$179.00 L&R



BRIZBRKT
License plate
mounting bracket for
BRIZ license guard.
(-15) \$23.00 EA

Briz Bumper License Guard



BRIZBGUARD
Polished. '49 Chevy
style. (-15) . \$156.50 EA

Bumpers

*Oversized shipping charges apply to.
Please call for rate.*



594648S 37
POLISHED STAINLESS.
Fits Front on Master, Front or Rear on
trucks. (7.831-0) \$385.00 EA



594648 37
TRIPLE PLATED CHROME. Fits
Master & Commercial 1/2 ton thru 1
ton. 34" center-to-center (inside bolt
holes). (7.831-0) \$325.00 EA



3847305S 38-39
POLISHED STAINLESS.
No holes. Studs for brackets welded
to back. (7.831-0) \$385.00 EA



3847305 38-39
TRIPLE PLATED CHROME. Front
or Rear. 35-1/2" center-to-center
(inside bolt holes). 5 mounting holes.
(7.831-0) \$325.00 EA



3653339S 40
POLISHED STAINLESS.
No holes. Studs for brackets welded
to back. Fits front or rear (exc.
rear of Wagon & Sedan Delivery).
(16.4-0) \$385.00 EA



3653339 40
TRIPLE PLATED CHROME. Fits front
or rear (exc. rear of Wagon & Sedan
Delivery). (7.831-0) \$325.00 EA

230T

Providing part numbers speeds up your order, improves accuracy and helps us maintain low prices.

See Illustration Index for core charge information and a list of abbreviations. For Body Model information, see Section 5T.



Section 230T: Bumpers, Bumper Brackets, Splash Aprons, License Brackets, & License Frames

Format = Part No., Year, Description, Original Chevrolet Parts Book Group No., Price and Unit of Measure.

3658265S 41-46
POLISHED STAINLESS.
With bolt holes (exc 41-42 COE & 46
1-1/2T w/ 160in. wheelbase). (7.831-0)
\$385.00 EA



3658265 41-46
TRIPLE PLATED CHROME. Front.
Exc 41-42 COE & 46 1-1/2T w/ 160in.
wheelbase. (7.831-0) . . . \$325.00 EA

3658265SA 41-46
POLISHED STAINLESS.
With bolt holes. Fits 1/2T & 3/4T
(original panels & Suburbans w/ doors
had 1-1/2in. less arc). (7.831-0)
\$385.00 EA



3658265A 41-46
TRIPLE PLATED CHROME. Rear.
1/2T & 3/4T (original panels &
Suburbans w/ doors had 1-1/2in. less
arc). (7.831-0) \$325.00 EA

3700438SS 47-54
POLISHED STAINLESS.
SMOOTH (no holes) Front, polished
stainless. Also fits rear of Panel &
Suburban. (7.831-0) \$385.00 EA



3700438S 47-54
POLISHED STAINLESS.
Front. Also fits rear of Panel &
Suburban. (7.831-20) . . . \$288.75 EA



3700438 47-54
TRIPLE PLATED CHROME. Front.
Also fits rear of panel and Suburban.
(7.831-15) \$150.00 EA



3683350S 47-53
POLISHED STAINLESS.
Rear, exc. Panel & Suburban. Nice!
(7.831-0) \$385.00 EA



3683350 47-53
TRIPLE PLATED CHROME.
Rear. Exc panel & Suburban.
(7.831-15) \$150.00 EA

3700438P 47-54
PAINTED.
Front. Also rear of panel and
Suburban. (7.831-15) . . . \$120.00 EA



3705437 54
CHROME
Rear, nice. (7.831-15) . . . \$191.50 EA

*Oversized shipping charges apply.
Please call for rate.*

Grommets -Bumper



3658003 41-46
Front bumper.
(7.792-15) . \$16.50 PR



599743 39-46
Rear bumper panel,
Suburban (2 pcs).
(7.792-15) . \$24.50 PR

Seal



3690257 47-54
Body to rear bumper panel or
Suburban. (7.833-15) \$21.00 EA

Bumper Guard



597827 38-39
Front or rear bumper.
(7.828-15) \$35.00 EA



986113 47-54
Front or rear (accessory).
(7.828-15) \$70.00 L&R



986113R 47-54
Front or rear (accessory). Rubber
face. Includes mounting hardware.
(7.828-15) \$25.00 EA

Bolt -Bumper Guard



597825A 37
1-1/8in. x 2-1/2in.
(7.829-15) . \$8.25 EA



597825 38-39
1-3/8in. x 2-1/2in.
(7.829-20) . \$8.25 EA

Bumper Bolt



594206SQ . . . 37-46
With oval head
bolt, nut, flat & lock
washers, as original.
Second quality.
(7.874-30) . \$4.00 SET



594205SQ . . . 37-46
With oval head bolt,
marsden nut, flat
& lock washers, as
original. Second
Quality (-30)

\$7.00 SET

Returns require a return authorization number, Please call.

Section 230T: Bumpers, Bumper Brackets, Splash Aprons, License Brackets, & License Frames

Format = Part No., Year, Description, Original Chevrolet Parts Book Group No., Price and Unit of Measure.



3695907C 47-54
Chrome w/ standard
nut & washers.
(7.874-15) . . \$2.25 EA



3695907 47-54
With standard bolt, nut
, flat & lock washers,
as original. (7.874-40)
\$4.50 EA



3695906 47-54
With standard bolt,
marsden nut , flat
& lock washers, as
original. (7.874-40) . . .

\$7.50 EA



125366 All
With Washers.
(8.917-20) . \$2.75 SET

Bumper Bracket



594711 37
Front (7.836-15) \$100.00 L&R



594154 37
Rear (7.836-15) \$125.00 L&R



350590 38-39
Front (7.836-15) \$90.00 L&R



597872 38-39
Rear (7.836-15) \$125.00 L&R



3653681 40
Front (7.836-15) \$115.00 L&R



3653862 40
Rear (7.836-15) \$130.00 L&R



3658053 41-46
Front (7.836-15) \$105.00 L&R



599382B 41-46
Rear. 6 piece set.
(7.836-15) \$125.00 L&R



3701949 47-54
Front (1/2T & 3/4T).
(7.836-15) \$87.00 L&R



3684827B 47-54
Rear (1/2T). (7.836-15) . \$100.00 L&R



3684833 47-54
Rear (3/4 & 1T).
(7.836-15) \$140.00 L&R

Front Splash Apron

*Oversized shipping charges apply.
Please call for rate.*



3684145 47-53
Bumper to grille. Steel (does
not fit GMC) superior quality.
(1.287-15) \$100.00 EA

3684145C 47-53
Bumper to grille. Chrome (does not fit
GMC). (1.287-15) \$200.00 EA

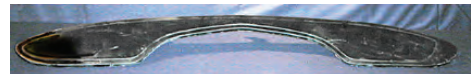

3684145F 47-53
Bumper to grille. Fiberglass (does not
fit GMC). (1.287-15) \$95.00 EA

3701226 54
Bumper to grille. Steel (does not fit
GMC). (1.287-15) \$100.00 EA

3701226C 54
Bumper to grille. Chrome (does not fit
GMC). (1.287-15) \$150.00 EA

3701226F 54
Bumper to grille. Fiberglass (does not
fit GMC). (1.287-15) \$85.75 EA



3684145G 47-53
Bumper to grille. Steel, GMC.
(1.287-15) \$100.00 EA

230T

Providing part numbers speeds up your order, improves accuracy and helps us maintain low prices.

See Illustration Index for core charge information and a list of abbreviations. For Body Model information, see Section 5T.



Section 230T: Bumpers, Bumper Brackets, Splash Aprons, License Brackets, & License Frames

Format = Part No., Year, Description, Original Chevrolet Parts Book Group No., Price and Unit of Measure.

Rear Splash Apron



3690258A 47-53
Fits over bumper brackets.
(7.833-15) \$150.00 EA

Rear Roll Pans

*Oversized shipping charges apply.
Please call for rate.*

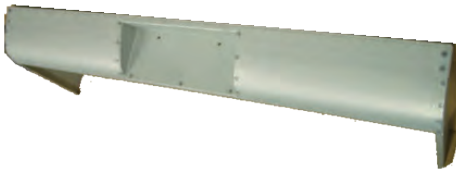

3658265P 41-46
Steel pan. Rear with license plate
recess. Replaces back bumper for
smooth look. (7.831-15) .. \$125.00 EA



3683305P 47-53
Steel pan. Rear with license plate
recess. Replaces back bumper for
smooth look. (7.831-15) .. \$125.00 EA

3683305PS 47-53
Steel pan. Replaces back bumper for
smooth look. (7.831-15) . . . \$75.00 EA



3683305FS 47-53
Fiberglass pan. Smooth rear panel
replaces back bumper (no license
plate recess). 50" end-to-end, 6"
height. (7.831-15) \$95.00 EA

3705437P 54
Steel pan. Rear with license plate recess.
Replaces back bumper for smooth look.
(7.831-15) \$125.00 EA

License Plate Bracket



595805 37-40
Front (7.796-0) \$25.00 EA



605358 41-46
Front (7.796-15) \$25.00 EA



3847439 47-53
Front (7.796-15) \$8.00 EA



3847439C 47-53
Front (chrome). (7.796-20) . \$20.00 EA



3847440A 54
Front (7.796-20) \$12.50 EA



3707021 54-59
Includes license light rear.
(2.705-15) \$51.75 EA

*Note: Rear License Plate Bracket see
Tail Light Bracket Section 110T.*

License Fastener



985094
Glass jewel reflector. Specify Red or
Green (2 pcs) . (9.777-15) . \$14.25 PR
985094P All
Plastic jewel reflector.
Red (2 pcs). (9.777-15)
\$3.00 PR



License Plate Frame



986708 All
Telescoping (8 pcs), 2 ribs on
end of each piece. Polished
stainless. Original accessory 48-55.
(9.777-15) \$53.50 EA



986710 37-54
Year on top and "Chevrolet" on bottom
of frame. Choose 1937-1954 (Exc 42
& 46). Specify year when ordering. (2
pcs). (9.777-0) \$13.50 SET

Returns require a return authorization number, Please call.

Section 230T: Bumpers, Bumper Brackets, Splash Aprons, License Brackets, & License Frames
 Format = Part No., Year, Description, Original Chevrolet Parts Book Group No., Price and Unit of Measure.



Odds & Ends

Please call for availability on all Odds & Ends parts; once part is sold, it may no longer be in stock.

350623	37-40	
Bumper Bracket Front (All 1-1/2T Exc COE) (17*000-0)	\$20.00	EA
3683663	47-55	
Bumper Bracket Front & Rear Inner Left (17*000-0)	\$20.00	EA
3683665	47-55	
Bumper Bracket Front & Rear Outer Left (17*000-40)	\$20.00	EA
3656466	41-46	
Bumper Bracket Front Outer NOS (17*000-40)	\$20.00	EA



1951 1/2 Ton—Randall Fehr, Seattle, Washington

230T

Providing part numbers speeds up your order, improves accuracy and helps us maintain low prices.

See Illustration Index for core charge information and a list of abbreviations. For Body Model information, see Section 5T.



Section 240T: Grilles, Panels, Hardware & Related

Format = Part No., Year, Description, Original Chevrolet Parts Book Group No., Price and Unit of Measure.

Grilles

Note: Grilles are sorted by Year Span with Street Rod grilles listed first followed by Restoration Grilles & Parts.

Oversize shipping charges apply on all Grilles. Please call for rates.

1937 Grille-Billet Aluminum Bars

595112BNC 37
Chromed bars. Narrow spacing (1/4in. space). (1.266-0)..... \$1,375.00 EA



595112BNP 37
Fully polished. Narrow bar spacing (1/4in. space). (1.266-0)..... \$900.00 EA

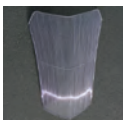

595112BNF 37
Polished (front bars only). Narrow bar spacing (1/4in. space). (1.266-0) .. \$750.00 EA

595112BWF 37
Polished (front of bars only). Standard bar spacing (3/8in. space). (1.266-0) \$595.00 EA

595112BWP 37
Fully polished. Standard bar spacing (3/8in. space). (1.266-0)..... \$715.00 EA

595112BWC 37
Chromed. Standard bar spacing (3/8in. space). (1.266-0)..... \$1,190.00 EA

1937 "Gangster Grille"



595112LS 37
Laser cut. Polished stainless for street rod. (1.266-15) \$675.00 EA



595112LP 37
Laser cut. Bare steel for street rod. (1.266-15) \$450.00 EA

1937 Grille-Side Moulding



594721 37
Side moulding. Cut to length. (1.268-15) \$116.00 L&R

1937 Grille



595311 37
Upper moulding. Polished stainless. (1.268-15) \$196.50 EA

595112S 37
Stainless, like original. (1.266-15)..... \$635.25 EA

1937 Grille Side Moulding



595539 37
Clips, 4 per side moulding (4 piece set). (1.269-0) \$5.00 SET

1937 Grille Center Strip



594996 37
Like original. (1.268-15)..... \$40.50 EA

1937 Crank Hole Cover



595039 37
(1.274-15) \$29.00 EA

1937 Grille Center Strip



594996S 37
Street rod (no holes for emblem or crank). (1.268-0) \$86.75 EA

1937 Grille Emblem



595376 37
Chrome. (1.303-15) \$63.00 EA

1937 Grille Shell



602395 37
Fiberglass. (1.263-15) .. \$369.75 EA

1938 "Gangster Grille"



597829LS 38
Laser cut. Polished stainless for street rod. (1.266-15) \$675.00 EA



597829LP 38
Laser cut. Bare steel for street rod. (1.266-15) \$395.00 EA

1938 Grille



597829 38
Bare steel like original. (1.266-0)..... \$440.00 EA

Returns require a return authorization number, Please call.

Section 240T: Grilles, Panels, Hardware & Related



Format = Part No., Year, Description, Original Chevrolet Parts Book Group No., Price and Unit of Measure.

1938 Grille Center Strip

597988..... 38
(1.268-15).....\$40.50 EA



1938 Grille Center Strip Clip

597463 38
Clips for center strip.
Uses 2. (1.269-15) . . .
\$6.25 PR



1938 Crank Hole Cover

597719 38
2 pieces (1.274-15) . . .
\$40.00 SET



1939 Grille

350422NC 39
W/ center strip (bare steel). 17
bars. (1.266-0) \$498.00 EA



1939 Grille Center Strip

580814 39
21-3/4in. (1.268-15). \$46.25 EA



1939 Grille Lettering



350422L 39
Top grille bar-vinyl.
(1.266-15)\$21.00 EA

1940 Grille



3653523NC 40
W/ center strip (bare steel). 16
bars. (1.266-0) \$495.00 EA

1940 Grille Center Strip



3653529 40
20-1/4in. (1.268-15) . \$55.00 EA

1940 Grille Upper Moulding



3653529P 40
Polished stainless steel.
(1.268-0)..... \$300.00 EA

1940 Grille Lettering



3653523A. 40
(1.266-15) \$21.00 EA

1941-46 Grille



3657169 41-46
Upper-chrome (not for show).
(1.266-15) \$350.00 EA
3657169NC..... 41-46
Upper-bare steel. (1.266-15)
\$175.00 EA



3657185NC..... 41-46
Upper & lower. Bare steel (exc COE).
(1.266-15) \$695.00 SET

3657185NCNL..... 41-46
Upper & Lower. Bare steel without logo.
(1.266-15) \$695.00 EA

1941-46 Grille Screw Set

3657169A 41-46
Upper grille to lower grille.
(1.266-15) \$4.00 SET



3651169..... 41-46
Upper grille to fender.
(1.269-15) . \$4.00 SET

1941-46 Grille Emblem



3657269 . . . 41-46
Lower.
(1.303-15) \$25.50 EA

1941-46 Grille Lettering



3657186 41-46
Red vinyl. (1.266-15) \$21.00 SET

1941-46 Grille Filler Panel



3664734 41-46
Upper grille baffle. Fits
between upper grille
& radiator. Fiberglass.
(1.286-15) . \$70.00 EA

1941-46 Grille Moulding Clips



597522A. 41-46
For moulding above
lower grille (8 pcs).
(8.005-30)..... \$4.75 SET

240T

Providing part numbers speeds up your order, improves accuracy and helps us maintain low prices.

See Illustration Index for core charge information and a list of abbreviations. For Body Model information, see Section 5T.



Section 240T: Grilles, Panels, Hardware & Related

Format = Part No., Year, Description, Original Chevrolet Parts Book Group No., Price and Unit of Measure.

1941-46 Panel Below Grille



3680810G 41-46
GMC fiberglass. (1.266-15) \$76.00 EA



3680810GS 41-46
GMC fiberglass w/out bumper
cutouts street rod application.
(1.266-15) \$76.00 EA

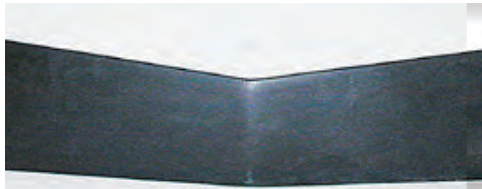

3680810 41-46
Fiberglass. (1.266-15) \$65.50 EA



3680810S 41-46
Fiberglass w/out bumper
cutouts street rod application.
(1.266-15) \$70.00 EA

1947-53 Grille



3847340 47-53
Chrome-detailed, preassembled very
nice. (1.266-15) \$400.00 EA

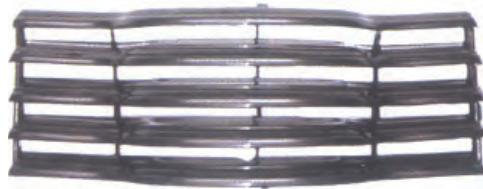

3847340P 47-53
Painted. Nice detail. Comes
preassembled. (1.266-15) \$325.00 EA



3847340G 47-53
Chrome-detailed, preassembled
very nice. GMC (exc COE).
(1.266-15) \$560.00 EA

1947-53 Grille Bolt Kit



3650205B. 47-53
Grille (1.269-30)
\$16.75 SET

1947-53 Grille Filler Panel

3693744F 47-53
Upper grille fiberglass. (1.286-15)
\$70.00 EA

Grille Filler Panel



3683583 47-53
Lower grille, EDP coated steel.
(1.286-0) \$120.00 EA



3683583F. 47-53
Lower grille fiberglass.
(1.286-15) \$120.00 EA

Grilles

Note: Oversize shipping charges apply on all grilles. Please call for rates.

1954 Grille



3700339B 54
Chrome plated. Comes assembled.
(1.268-0) \$750.00 EA



3700339BP 54
Cream color w/ black details. Comes
assembled. (1.268-15) . . . \$610.00 EA

1954 Grille-Vertical Bar



3701112. 54
Vertical center grille
bar. Chrome. (1.268-15)
\$100.00 EA



3701112A. 54
Unplated Center Grille
Bar. (1.268-15)
\$85.00 EA

1954 Grille Bolt Kit



3701113A 54
Grille (84 pieces).
(1.269-15) \$24.00 EA

Returns require a return authorization number, Please call.



Format = Part No., Year, Description, Original Chevrolet Parts Book Group No., Price and Unit of Measure.

1954 Grille Decals



3710929C 54
For chrome grille & hood emblem.
(8.055-15) \$9.25 SET



3710929P 54
For painted grille & hood emblem.
(8.055-15) \$9.25 SET

1955 (1st Series) Grille Decals



3701185C 55
(1st series) for chrome grille & hood emblem. (8.055-0) \$11.00 SET
3701185P 55
(1st series) for painted grille & hood emblem.
(8.055-15) \$12.00 SET

Core Support Pads & Shims



367314 39-46
Radiator core support mount. 4-1/4" x 1-1/2" (2-1/2" between bolt holes).
(1.27-40) \$12.00 SET



3684763A. . . 47-49
Radiator core support mount. 2-1/4" x 1-1/4" x 1/4" thick. (1.27-15).
\$6.00 SET

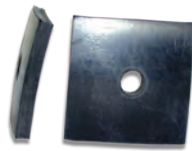

3684763. 50-54
Radiator core support mount. (1.27-20) \$5.25 PR

Core Support Bolt Kit



3676480. 41-54
Radiator core support to frame. (1.27-40) \$3.25 SET

Brace (V-Rod)



594773 37-38
Stainless Steel.
(1.309-15) \$104.00 EA

Odds & Ends

Please call for availability on all Odds & Ends parts; once part is sold, it may no longer be in stock.

- 10281 47-53
- Grille GMC (Good Used) (0-0) \$400.00 EA
- 3693745U 50-53
- Grille GMC (Some rust) (22:000-0) \$125.00 EA
- 602395U 37
- Grille shell and Radiator with hood ornament with top and side moulding (Used). Grille shell has rust at bottom. (1.263-15). \$300.00 EA
- 03790 47-53
- Headlight knob w/ shaft, good used (2.485-40). \$8.00 EA
- 03870 37-46
- Headlight Switch, 37-38 Pass & 40-46 Truck (9-40) \$55.00 EA
- 5936674 46-48
- Rim (trim ring) for spotlight (NOS) (7-40) \$15.00 EA
- 3700339 54
- Upper grille moulding, w/ chevrolet (Used) (1.266-0) \$125.00 EA

240T



Section 250T: Hoods, Hinges, Springs, Rubber, Emblems & Ornaments

Format = Part No., Year, Description, Original Chevrolet Parts Book Group No., Price and Unit of Measure.

Hood Hinge Bolt



3688414S . . . 47-54
STAINLESS STEEL.
Shouldered-1/2in. hex
head, 3/8in. shoulder
commercial utility
(exc COE) (uses 2).
(8.016-15) \$16.00 SET

Hood-Fiberglass

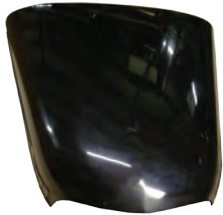

602345F 37
1-piece top section.
(8.001-15) \$477.75 EA



602985F 38
1-piece top section.
(8.001-15) \$477.75 EA

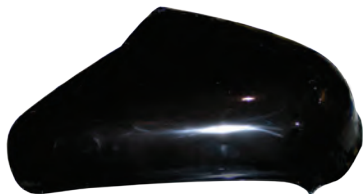

3701466F 47-55
1-piece top section.
(8-15) \$405.25 EA

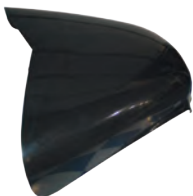

3692127 47-55
Smooth without inner liner, customer
will need to provide their own.
(8.001-15) \$300.00 EA

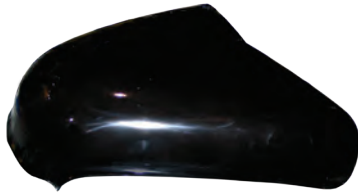

3692127G 47-55
GMC smooth without inner liner,
customer will need to provide their
own. (8.001-15) \$300.00 EA

Bullnose



3701990B 47-53
Replaces center strip & hood
ornament. 57in. length x 1/2"
wide, polished aluminum, w/ clips.
(8.015-15) \$30.75 EA

Hood Latch Lower Assembly



3682709P 47-53
Complete assembly, black.
(8.08-15) \$150.00 EA



3682709C 47-53
Complete chrome assembly.
(8.08-15) \$225.00 EA

Hood Latch Plate



2228975 47-53
Above Grille. Fits GMC.
(6.079-15) \$179.50 EA

Hood Latch Assembly

3682709A 47-53
Mechanism only. (8.08-15) . \$63.25 EA

Hood Center Strip



3681480S 47-55
Stainless steel w/ clips. Will not fit
GMC. (8.015-15) \$80.00 EA

Hood Deflector



C5018 All
Classic "Bi-Flector"
"accessory attaches
to hood center strip.
Choose Amber, Blue,
Clear, Green or Red.
(-0) \$12.00 EA

Radiator Cap



370683 34-36
Seahorse gorgeous (accessory).
(1.203-15) \$178.50 EA

Hood Ornament



595591 37
(1.265-15) \$205.00 EA



598015 38
(1.265-15) \$205.00 EA

Returns require a return authorization number, Please call.

Section 250T: Hoods, Hinges, Springs, Rubber, Emblems & Ornaments

Format = Part No., Year, Description, Original Chevrolet Parts Book Group No., Price and Unit of Measure.



350805 39-40
(1.265-15) \$205.00 EA



986162 47-53
Accessory (original 47-52).
(1.265-15) \$110.00 EA



986982 53
Accessory (1.265-15) . . . \$261.50 EA

Hood Ornament - GMC



986162G 47-55
GMC accessory. (1.265-0) \$349.00 EA

Center Strip



3681480 47-55
For hood bullnose-steel w/ clips will
not fit GMC. 55-1/4" length, tip-to-tip.
(8.015-15) \$80.00 EA



3681480SG . . 47-55
Stainless steel w/
clips. GMC. (8.015-15)
\$75.00 EA

Retainers w/ Screws



3654168B. . . . 29-46
For hood to cowl seal
(Set of 8). (9.127-40) .
\$6.25 SET

Hood Emblem



3684340 47-53
Front of Hood - Stainless.
(8.055-15) \$60.00 EA
3684340C 47-53
Front of Hood - Chrome.
(8.055-15) \$39.00 EA

Hood Hinge



372828P. . . . 34-40
Painted with fasteners
(exc COE). (8.015-15)
\$65.00 SET

Bracket -Hood Hinge



473987S. . . . 34-46
Stainless. Rear hood
hinge hold down. (-15)
\$23.25 EA

Gasket -Hood Emblem



3699021B 47-53
Hood emblem. (8.055-15) . . \$5.00 EA



3710929A 54
Hood emblem. (8.055-15) . . \$5.75 EA



3699021A 47-53
Hood emblem set-script. Red
"Chevrolet" & stripes, blue "Bowtie".
(8.055-15) \$6.25 EA

Decals -Grille



3710929C 54
For chrome grille & hood emblem.
(8.055-15) \$9.25 SET



3710929P 54
For painted grille & hood emblem.
(8.055-15) \$9.25 SET



3701185C 55
(1st series) for chrome grille & hood
emblem. (8.055-0) \$11.00 SET
3701185P 55
(1st series) for painted grille & hood
emblem.
(8.055-15) \$12.00 SET

Hood Side Emblem



474797A 36-38
Bowtie painted-superior quality.
(8.039-15) \$34.75 EA



474797 36-38
Bowtie all chrome.
(8.039-15) \$43.75 EA

250T

Providing part numbers speeds up your order, improves accuracy and helps us maintain low prices.

See Illustration Index for core charge information and a list of abbreviations. For Body Model information, see Section 5T.



Section 250T: Hoods, Hinges, Springs, Rubber, Emblems & Ornaments

Format = Part No., Year, Description, Original Chevrolet Parts Book Group No., Price and Unit of Measure.



3683134 47-48
Chevrolet Thriftmaster.
(8.039-15) \$15.00 EA



3699024 49-52
Chevrolet. (8.039-15) \$37.00 PR



3692106 49-51
3100 (8.039-15) \$12.00 EA



3700202 53-54
3100 (8.039-15) \$30.00 PR

Hood Side Moulding



3657265 41-46
Left (8.005-15) \$25.00 EA



3657266 41-46
Right (8.005-15) \$25.00 EA

Hood Side Clips & Bolts



59752346 41-46
Does 1 moulding.
(8.005-40) . \$5.75 SET

Hood Handle



597521A. 36-46
Stainless steel (36-39
cars) (8.03-30)
\$34.75 EA

597521P. 36-46
Plain steel, primered.
Paintable, as original.
(8.03-15) . . \$15.00 EA

Adhesive



01608
3M plastic & emblem adhesive (5 oz.
tube). (8.8-15) \$11.50 EA

Underhood Light



986250 47-48
Super reproduction.
(0.951388889-15) \$67.00 EA

Hood Corners



3678834 37-38
Rubber front. (8.024-0) . . . \$11.50 PR
3678834. 39-46
Rubber rear.
(8.024-0) \$11.50 PR

Bumpers (Rubber)



595304 37
Hood to grille shell (6
pcs). (8.024-30)
\$5.25 SET



3681093B. 38-46
Hood to grille shell (6
pcs). (8.024-40)
\$6.25 SET



3676360B. 47-54
Hood set (10 pcs).
(8.024-30) . \$9.25 SET

Hood To Cowl Seal



374969A. 29-46
Webbing-also radiator
shell to hood (9 ft).
(9.127-20) . \$12.00 EA



374969. 29-46
Webbing With Wire
Insert (9.127-15)
\$30.00 PR



3658468A. 41-46
2 44in. rubber strips.
(9.127-30) . \$12.25 PR



3688792. 47-55
2 32-1/2in. rubber
strips. (9.127-30)
\$12.00 PR

3664008BULK.
Rubber sold by the
inch (9.127-40)
\$0.25 IN

Hood To Grille Seal



374969C. 31-40
Webbing with wire
insert. (9.127-15)
\$27.50 EA

Hood Hinge Bolt



3689234S. 47-54
Stainless steel 5/8in.
hex head, 7/16in.
shoulder. Fits Comm &
Utility (exc COE) (uses
4). (8.016-15)
\$18.00 SET



3688414. 47-54
Shouldered-1/2in. hex
head, 3/8in. shoulder
commercial utility
(exc COE) (uses 2).
(8.016-0) . \$5.00 SET



3689234. 47-54
Shouldered-5/8in. hex
head, 7/16in. shoulder
commercial utility
(exc COE) (uses 4).
(8.016-15) . \$5.00 SET

Returns require a return authorization number, Please call.

Section 250T: Hoods, Hinges, Springs, Rubber, Emblems & Ornaments



Format = Part No., Year, Description, Original Chevrolet Parts Book Group No., Price and Unit of Measure.

Bracket -Hood Hinge



473987 34-46
Bracket for hood hinge
hold down (rear).
(8.058-15) . \$13.50 EA

Hood Hinge



372828 34-40
Chrome with fasteners (exc COE).
(8.015-15) \$100.00 SET

3657264 41-46
Chrome with fasteners (exc COE).
(8.015-15) \$100.00 SET

3657264P 41-46
Painted with fasteners (exc COE).
(8.015-15) \$65.00 SET



3686039 47-54
Upper & lower (left).
(8.015-15) \$44.00 SET



3686040 47-54
Upper & lower (right).
(8.015-15) \$44.00 SET

Odds & Ends

Please call for availability on all Odds & Ends parts; once part is sold, it may no longer be in stock.

3701424 54-55
(8.08-40) \$30.00 EA

3681600N 47-53
Center Strip, Hood NOS (Utility)
(19<000-0) \$75.00 EA

3681600N 47-54
Hood center strip NOS painted (8.015-0)
\$75.00 EA

3657264U 41-46
Hood hinge (Used). (8.015-40)
\$60.00 EA

3689239 47-53
Hood Hinge NOS left (19*000-0)
\$45.00 EA

3686039 47-55
Hood link w/ spring-left (19-40)
\$15.00 EA

3716191 55-59
Hood Lower latch plate NOS (8.08-40)
\$45.00 EA

595591U 37
Hood ornament. Nice condition (Used)
(1.265-0) \$175.00 EA

11540 54
Mldg, Hood Center, P/u (36^000-0)
\$70.00 EA

250T

Providing part numbers speeds up your order, improves accuracy and helps us maintain low prices.

See Illustration Index for core charge information and a list of abbreviations. For Body Model information, see Section 5T.



Section 270T: Fenders, Fender Skirts, Fender Welting, Fender Gaskets, Mud Flaps, Hardware & Mouldings

Format = Part No., Year, Description, Original Chevrolet Parts Book Group No., Price and Unit of Measure.

Fender Front (Steel)

Note: Steel fenders ship EDP coated to protect from rust. Oversize shipping charges apply. Please call for rates.



3682481 47-53
Left side. Metal. Exc COE.
(8.13-15) \$375.00 EA
3682482 47-53
Right side. Metal. Exc COE.
(8.13-15) \$375.00 EA



3700181 54-55
Left side. Metal. Fits 1st Series, Exc
COE. (8.13-15) \$375.00 EA
3700182 54-55
Right side. Metal. Fits 1st Series, Exc
COE.
(8.13-15) \$375.00 EA



3682481A . . . 47-55
Left side repair,
back of front fender.
(8.13-15) . . \$95.00 EA

3682482A 47-55
Right side repair, back of front fender.
(8.13-15) \$95.00 EA

Fender Front (Fiberglass)

Note: Fiberglass front fenders are made to order. \$7 additional packing fee on each fender. Oversize shipping charges apply. Please call for rates.



594955L 37-38
Left. (8.13-15) \$397.00 EA
594956R 37-38
Right.
(8.13-15) \$397.00 EA

599991L 39-40
Left.
(8.13-15) \$397.00 EA
599992R 39-40
Right.
(8.13-15) \$397.00 EA
3664961L 41-46
Left.
(8.13-15) \$405.25 EA
3664962R 41-46
Right.
(8.13-15) \$405.25 EA
3682657L 47-53
Left.
(8.13-15) \$329.75 EA
3682658R 47-53
Right.
(8.13-15) \$329.75 EA

Fender Rear (Steel)



3682835S 47-54
Left (8.203-15) \$400.00 EA
3682836S 47-54
Right
(8.203-15) \$400.00 EA

Fender Rear (Fiberglass)

Note: Fiberglass rear fenders are made to order. \$7 additional packing fee on each fender. Oversize shipping charges apply. Please call for rates.

594181L 37-38
Left.
(8.203-15) \$307.75 EA
594182R 37-38
Right.
(8.203-15) \$307.75 EA
594181W 37-38
Left 2" Wider.
(8.203-15) \$346.50 EA
594182W 37-38
Right 2" Wider.
(8.203-15) \$346.50 EA
599295L 39
Left (1/2, 3/4 & 1T).
(8.203-15) \$346.50 EA
599296R 39
Right (1/2, 3/4 & 1T).
(8.203-15) \$346.50 EA

599121L 39-46
Left (Panel, Suburban).
(8.164-15) \$323.50 EA
599122F 39-46
Right (Panel, Suburban).
(8.164-15) \$323.50 EA
3681977L 40-46
Left, exc 1T.
(8.203-15) \$323.50 EA
3681978R 40-46
Right, exc 1T.
(8.203-15) \$323.50 EA
3681977W 40-46
Left, 2" wider, exc 1T.
(8.203-15) \$346.50 EA
3681978W 40-46
Right, 2" wider, exc 1T.
(8.203-15) \$346.50 EA
3682835L 47-54
Left (all pickups).
(8.203-15) \$307.75 EA
3682836R 47-54
Right (all pickups).
(8.203-15) \$307.75 EA
3682835W 47-54
Left, 2-1/2" wider, all pickups.
(8.203-15) \$368.50 EA
3682836W 47-54
Right, 2-1/2" wider, all pickups.
(8.203-15) \$368.50 EA
3684691L 47-54
Left (Panel, Suburban).
(8.203-15) \$368.50 EA
3684692R 47-54
Right (Panel, Suburban).
(8.203-15) \$368.50 EA

Inner Fender Panel (Steel) -Front

Note: For inner fender panel black paint see Section 10T.



3687381 47-53
Left. (8.153-15) \$125.00 EA
3683076 47-53
Right.
(8.153-15) \$125.00 EA

Returns require a return authorization number, Please call.

Section 270T: Fenders, Fender Skirts, Fender Welting, Fender Gaskets, Mud Flaps, Hardware & Mouldings
Format = Part No., Year, Description, Original Chevrolet Parts Book Group No., Price and Unit of Measure.



Inner Fender Panel (Fiberglass) -Front

595889F. 37-38
 Left.
 (8.164-15) \$147.00 EA
 595890F. 37-38
 Right.
 (8.164-15) \$147.00 EA
 3664975F. 41-46
 Left.
 (8.164-15) \$205.75 EA
 3664976F. 41-46
 Right.
 (8.164-15) \$205.75 EA

Bolt & Washer Set

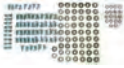
 3682481BZ . . 47-55
 Front fender. Zinc plated. (8.13-20)
 \$12.00 SET

Gasket Set



3701900A. 41-46
 Inner panel w/ lower rear mount pads.
 (8.154-15) \$27.50 SET



3701900C. 47-54
 Inner panel & front fender (8 pcs).
 (8.154-15) \$20.00 SET

Fender Gaskets

 609725. 47-54
 Fender to cowl (die cut). (8.205-15)
 \$20.00 SET

Fender Welt



601726
 1/4in. x 1-3/16in. 37-48 rear fenders
 use approx 15 ft. (8.205-30) . \$1.00 FT

601726C
 Chrome mylar (1-1/4" x 3/16").
 (8.205-20) \$1.50 FT

Fender Welting

601726A 27-46
 Set (4 fenders). (8.205-30) \$18.25 SET
 609275B 47-54
 Set (4 fenders) (optional). (8.205-30) . .
 \$20.50 SET
 601726E 37-54
 Rear fenders (optional 47-54).
 (8.205-30) \$16.50 PR
 601726F 37-54
 Chrome mylar rear (optional 47-54).
 (8.205-20) \$25.00 PR

Fender Marker (Guide)

 985134 37-54
 Illuminated. Clamps to front
 fender, chrome plated. Milky
 colored top w/ clear lens &
 stainless fin. (-15) \$70.50 L&R



Stand -Headlight Bucket

 350778F. 39-40
 Fiberglass, right.
 (2.544-15) . \$81.00 EA

Headlight Grommet

 3673139. 47-53
 Fender inner panel.
 (9.775-40) . \$4.00 SET

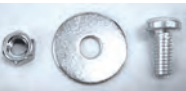
Clutch Head Bolt

 3681977B. . . . 39-46
 5/16in., nut, washer
 rear fender (3 pcs).
 (8.206-30) . \$2.00 SET
 3676478. 47-54
 5/16in., nut, washer
 rear fender (10 per
 fender) (3 piece set).
 (8.206-20) \$2.50 SET
 3681977. 47-54
 5/16in., nut, washer
 fender brace (3 pcs).
 (8.206-20) . \$2.50 SET

Clutch Head Driver



 DRIVER. All
 Magnetic driver w/ 5 bits (1/8in.,
 5/32in., 3/16in., 1/4in., 5/16in.) with
 Chevs imprint. (8.821-15) \$22.25 SET

Fender Braces

 3683947. 47-54
 Polished Stainless. Rear, 3/4 Ton.
 (8.212-0) \$50.00 PR
 3684841. 47-54
 Front
 (8.144-15) \$19.00 L&R
 3683947S. 47-54
 Stainless, Front & rear (4 piece set).
 1/2 Ton (8.203-15) \$94.00 SET

3683947. 47-54
 Rear - 1/2 Ton
 (8.212-30) \$10.50 EA
 3683947. 47-54
 Rear. 3/4 Ton
 (8.212-0) \$30.00 PR
 3683947A 47-54
 Rear, for 2" widened fenders.
 (8.212-30) \$11.75 EA

Mud Flaps

 986905. All
 W/ Chevrolet in bow-
 tie 12in.x17in. (2 pcs).
 (8.214-15) . \$41.00 PR

270T

Providing part numbers speeds up your order, improves accuracy and helps us maintain low prices.

See Illustration Index for core charge information and a list of abbreviations. For Body Model information, see Section 5T.



Section 270T: Fenders, Fender Skirts, Fender Welting, Fender Gaskets, Mud Flaps, Hardware & Mouldings

Format = Part No., Year, Description, Original Chevrolet Parts Book Group No., Price and Unit of Measure.

Fender Skirts



985641 36-46
Superb die-stamped production of
1940's original steel tear drop skirts.
(8.175-15) \$508.00 L&R



604503P 36-46
New (teardrop style).
(8.175-15) \$275.00 L&R



604503F 47-54
Fiberglass
reproduction of 40's
teardrop style. (8.175-15) \$297.25 L&R

Odds & Ends

Please call for availability on all Odds & Ends parts; once part is sold, it may no longer be in stock.

3682657U 47-53
Front fender left used with inner panel,
used in good condition (8.13-0)
\$100.00 EA

3682658U 47-53
Front fender right used with inner
panel, used in good condition (8.13-0)
\$100.00 EA

3682481U 47-53
Front left fender. Has holes cut for
parking light below headlight (Used)
(8.13-0) \$200.00 EA

599121S 39-46
Rear fender NOS left (8.203-40)
\$350.00 EA

3694962U 47-53
Right front fender (Used) (8.13-40) . . .
\$200.00 EA

3664975U 41-46
Skirt extension bracket spacer left
hand used (8.153-0) \$25.00 EA

3664976U 41-46
Skirt extension bracket spacer right
hand (Used) (8.153-0) \$25.00 EA

Returns require a return authorization number, Please call.

Section 290T: Sill Plates, Running Board Gaskets, Step Plates, Rocker Panel Mouldings & Fasteners

Format = Part No., Year, Description, Original Chevrolet Parts Book Group No., Price and Unit of Measure.



Note: Running Boards and Rocker Panels can be found in Section 295C.

Running Board Step Plate



350274B 47-54
 (super repro) very rare
 genuine chevrolet accessory
 (8.316-15) \$74.25 L&R



350274A All
 Stainless steel rim w/ rubber
 insert (7-5/8in. x 10-11/16in.)
 (8.316-15) \$94.25 L&R



350274C All
 Die cast with bowtie (5-5/16in. x 10-
 7/8in.) (8.316-15) \$60.00 L&R

Running Board Bolt Kit



3687271B . . . 37-54
 (8.299-40) \$12.50 SET

Gaskets-Running Board To Fender



3656703 39-40
 Running board to fenders (4)
 (8.299-15) \$16.00 SET



3656703A 41-46
 Running board to fenders (4)
 (8.299-15) \$16.00 SET



3687271A 47-54
 Running board to rear fender
 (8.299-15) \$3.50 PR

Running Board To Cab Seal



60395540 33-40
 (anti-squeak) to body (120in.)
 (8.237-20) \$9.50 SET

60395546 41-46
 Running board to body (Panel &
 Suburban) (120in.)
 (8.237-20) \$9.50 SET



3685433A . . . 47-54
 Running board to body
 (Panel & Suburban).
 (8.205-15) . \$28.00 PR



3685433 47-54
 Running board to
 cab (exc Panel &
 Suburban). (8.205-15)
 \$19.50 PR

Metal Retainer



3685433B . . . 47-55
 Running board to cab
 seal (8.205-15).
 \$9.00 EA

Screws



3685433C . . . 47-54
 For running board to
 cab seal retainer (18
 piece) (8.205-40)

\$2.50 SET

Running Board Mat



GL16
 Rubber repair kit.
 Repairs chipped
 running board rubber &
 other rubber materials.
 2-part epoxy, 16 oz.
 (10-15). . . . \$36.00 EA

290T

Providing part numbers speeds up your order, improves accuracy and helps us maintain low prices.

See Illustration Index for core charge information and a list of abbreviations. For Body Model information, see Section 5T.



Section 295T: 1937-39 Truck Body Parts

Format = Part No., Year, Description, Original Chevrolet Parts Book Group No., Price and Unit of Measure.

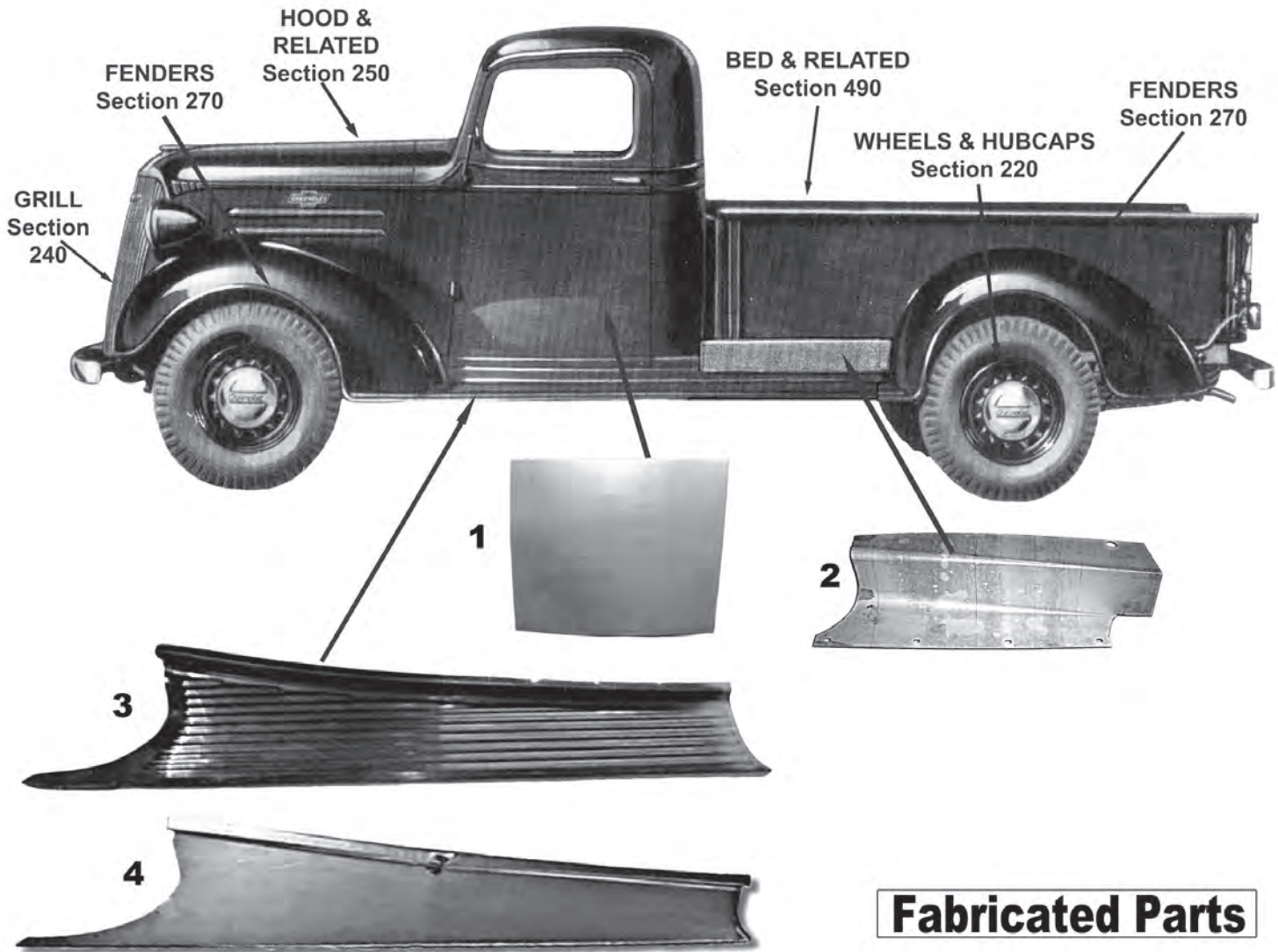

Fabricated Parts

1. Door Patch Panel

602455	36-38	Outer left. (16.15-15)	\$125.00	EA
602456	36-38	Outer right. (16.15-15)	\$125.00	EA
603339	39-46	Outer left. (16.15-15)	\$125.00	EA
3666518	39-46	Outer right. (16.15-15)	\$125.00	EA

2. Side Splash Apron

599731L	37-39	Left-1/2T. (8.228-15)	\$36.75	EA
599732R	37-39	Right-1/2T. (8.228-15)	\$36.75	EA

3. Running Boards w/ Built-in Mounting Points (Fiberglass)

594265S	37-38	Fiberglass-stock 1/2T. (8.299-15)	\$440.00	PR
594266F	37-38	Fiberglass-smooth 1/2T. (8.299-15)	\$308.75	PR
594265W	37-38	Fiberglass-smooth 1/2T (2in. wider). (8.299-15)	\$330.75	PR

3. Running Boards w/ Built-in Mounting Points (Fiberglass) — cont.

599578FS	39-40	Fiberglass-smooth 1/2T. (8.299-15)	\$308.75	PR
599578FW	39-40	Fiberglass-smooth 1/2T (2in. wider). (8.299-15)	\$330.75	PR

4. Running Boards w/ Built-in Mounting Points (Steel)

594266S	37-38	Smooth 16ga.cold rolled steel. 1/2T. (8.299-0)	\$375.50	PR
594266SW	37-38	Smooth 16ga.cold rolled steel. 1/2T (2in. wider). (8.299-0)	\$398.75	PR
599578S	39-40	Smooth 16ga.cold rolled steel. 1/2T. (8.299-0)	\$375.50	PR
599578SW	39-40	Smooth 16ga.cold rolled steel. 1/2T (2in. wider). (8.299-0)	\$398.75	PR

Returns require a return authorization number, Please call.

Section 295T: 1937-39 Truck Body Parts

Format = Part No., Year, Description, Original Chevrolet Parts Book Group No., Price and Unit of Measure.

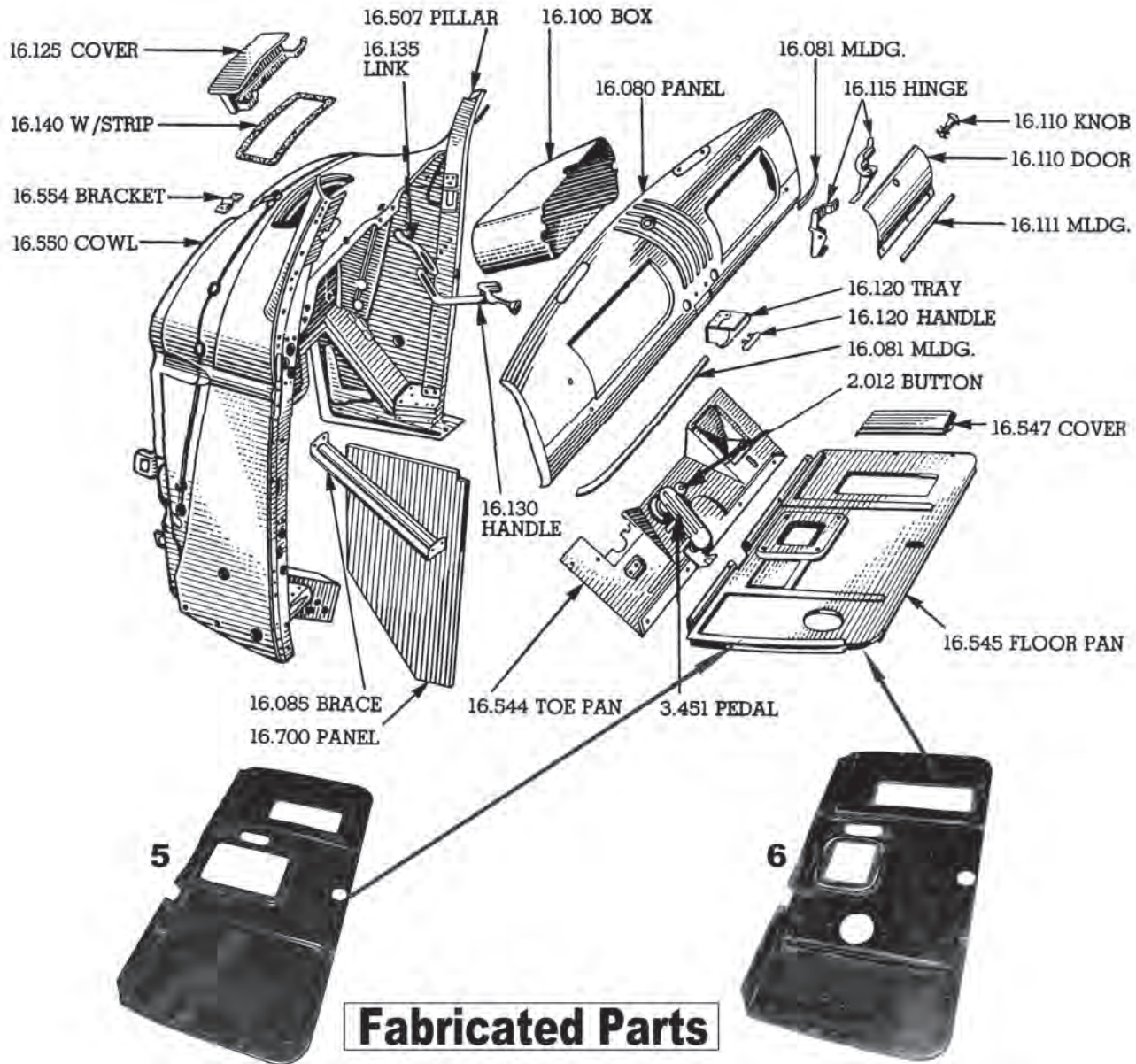

Fabricated Parts

5. Floorboard

594993 37-38 Door to door (fiberglass) 4-speed.
(16.545-15).....\$82.00 EA

6. Floorboard

3653211 39-40 Door to door (fiberglass) 4-speed.
(16.545-15).....\$82.00 EA

Screw Set

3693869B 39-46 Floor and Toeboard. 21 pieces.
(16.544-15).....\$9.00 SET

295T

Providing part numbers speeds up your order, improves accuracy and helps us maintain low prices.

See Illustration Index for core charge information and a list of abbreviations. For Body Model information, see Section 5T.



Section 295T: 1937-39 Truck Body Parts

Format = Part No., Year, Description, Original Chevrolet Parts Book Group No., Price and Unit of Measure.

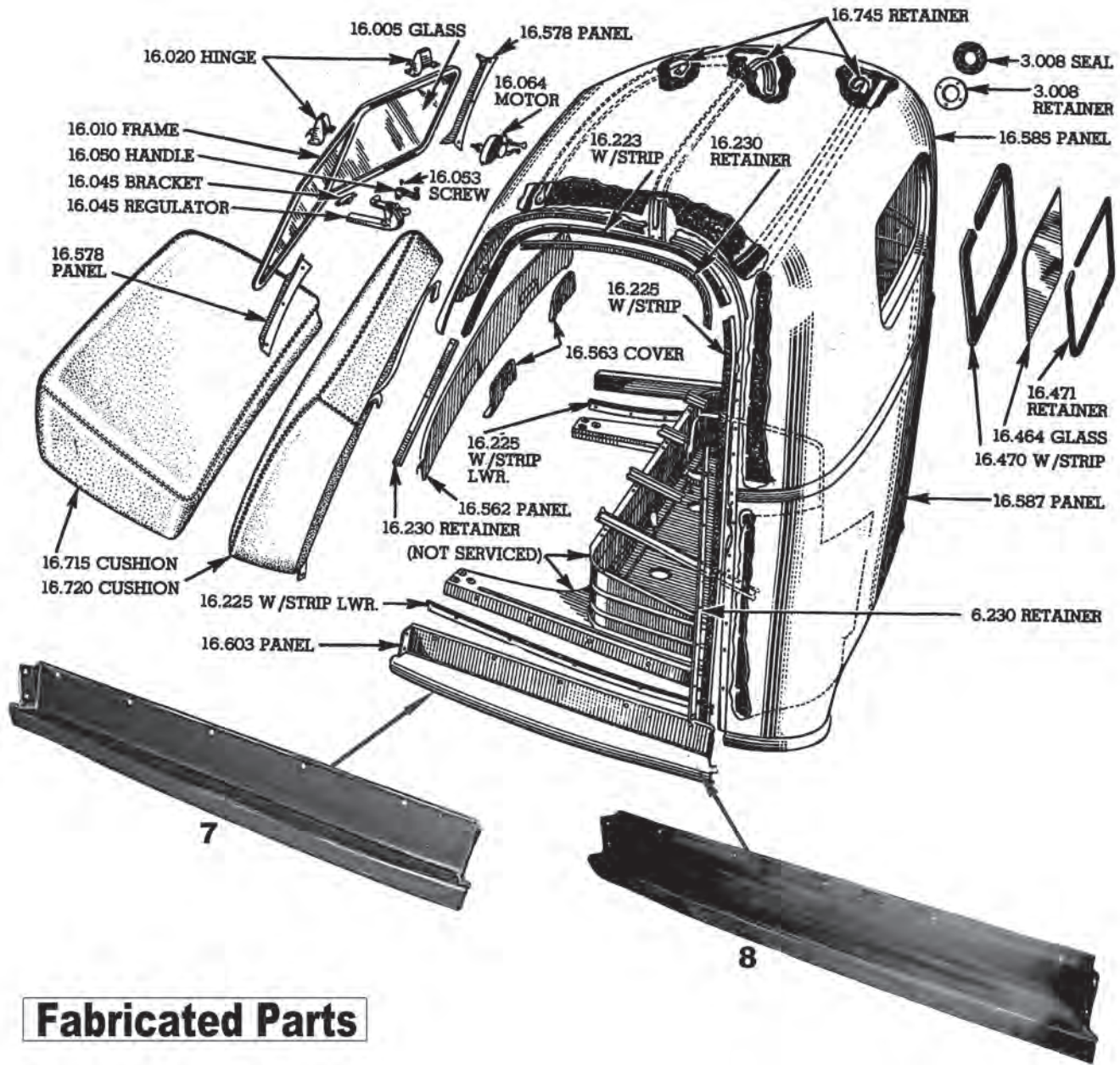

Fabricated Parts

7. Rocker Panel

477143	36-38	Left-fiberglass. (16.603-15)	\$70.00 EA
477144	36-38	Right-fiberglass. (16.603-15)	\$70.00 EA

8. Rocker Panel

598655	39-46	Left-fiberglass. (16.603-15)	\$70.00 EA
598656	39-46	Right-fiberglass. (16.603-15)	\$70.00 EA

Returns require a return authorization number, Please call.

Section 295T: 1940-46 Truck Body Parts

Format = Part No., Year, Description, Original Chevrolet Parts Book Group No., Price and Unit of Measure.

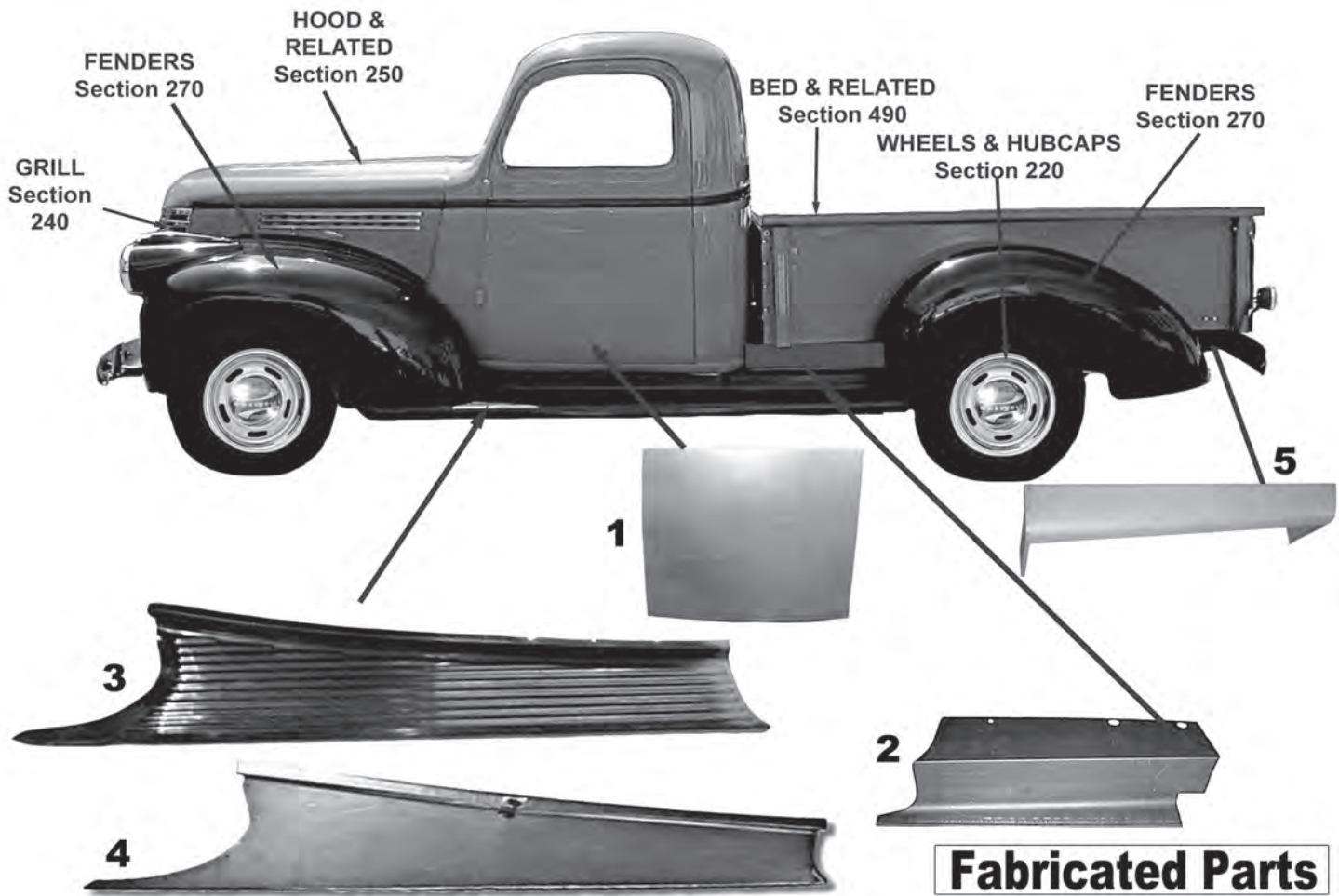

Fabricated Parts

1. Door Patch Panel

603339	39-46	Outer left. (16.15-15)	\$125.00 EA
3666518	39-46	Outer right. (16.15-15)	\$125.00 EA

2. Side Splash Apron

3654023L	40-46	Left-1/2T. (8.228-15)	\$36.75 EA
3654024R	40-46	Right-1/2T. (8.228-15)	\$36.75 EA
3654025L	40-46	Left-3/4T. (8.228-15)	\$58.50 EA
3654026R	40-46	Right-3/4T. (8.228-15)	\$58.50 EA

3. Running Boards w/ Built-in Mounting Points (Fiberglass)

599578FS	39-40	Fiberglass-smooth 1/2T. (8.299-15)	\$308.75 PR
599578FW	39-40	Fiberglass-smooth 1/2T (2in. wider). (8.299-15)	\$330.75 PR
3656702F	41-46	Fiberglass-smooth 1/2T. (8.299-15)	\$308.75 PR
3656702W	41-46	Fiberglass-smooth 1/2T. (8.299-15)	\$330.75 PR
3656915F	41-46	Fiberglass-stock 3/4T long bed. (8.299-0)	\$525.00 PR

4. Running Boards w/ Built-in Mounting Points (Steel)

599578S	39-40	Smooth 16ga.cold rolled steel. 1/2T. (8.299-0)	\$375.50 PR
599578SW	39-40	Smooth 16ga.cold rolled steel. 1/2T (2in. wider). (8.299-0)	\$398.75 PR
3656702S	41-46	Smooth 16ga.cold rolled steel. 1/2T. (8.299-0)	\$375.50 PR
3656702SW	41-46	Smooth 16ga.cold rolled steel. 1/2T (2in. wider). (8.299-0)	\$398.75 PR

5. Rear Pan

3658265PS	41-46	Steel pan. Rear without license plate recess. Replaces back bumper for smooth look. (7.831-15)	\$75.00 EA
-----------	-------	--	------------

295T

Providing part numbers speeds up your order, improves accuracy and helps us maintain low prices.

See Illustration Index for core charge information and a list of abbreviations. For Body Model information, see Section 5T.



Section 295T: Sheet Metal, Mouldings & Clips

Format = Part No., Year, Description, Original Chevrolet Parts Book Group No., Price and Unit of Measure.

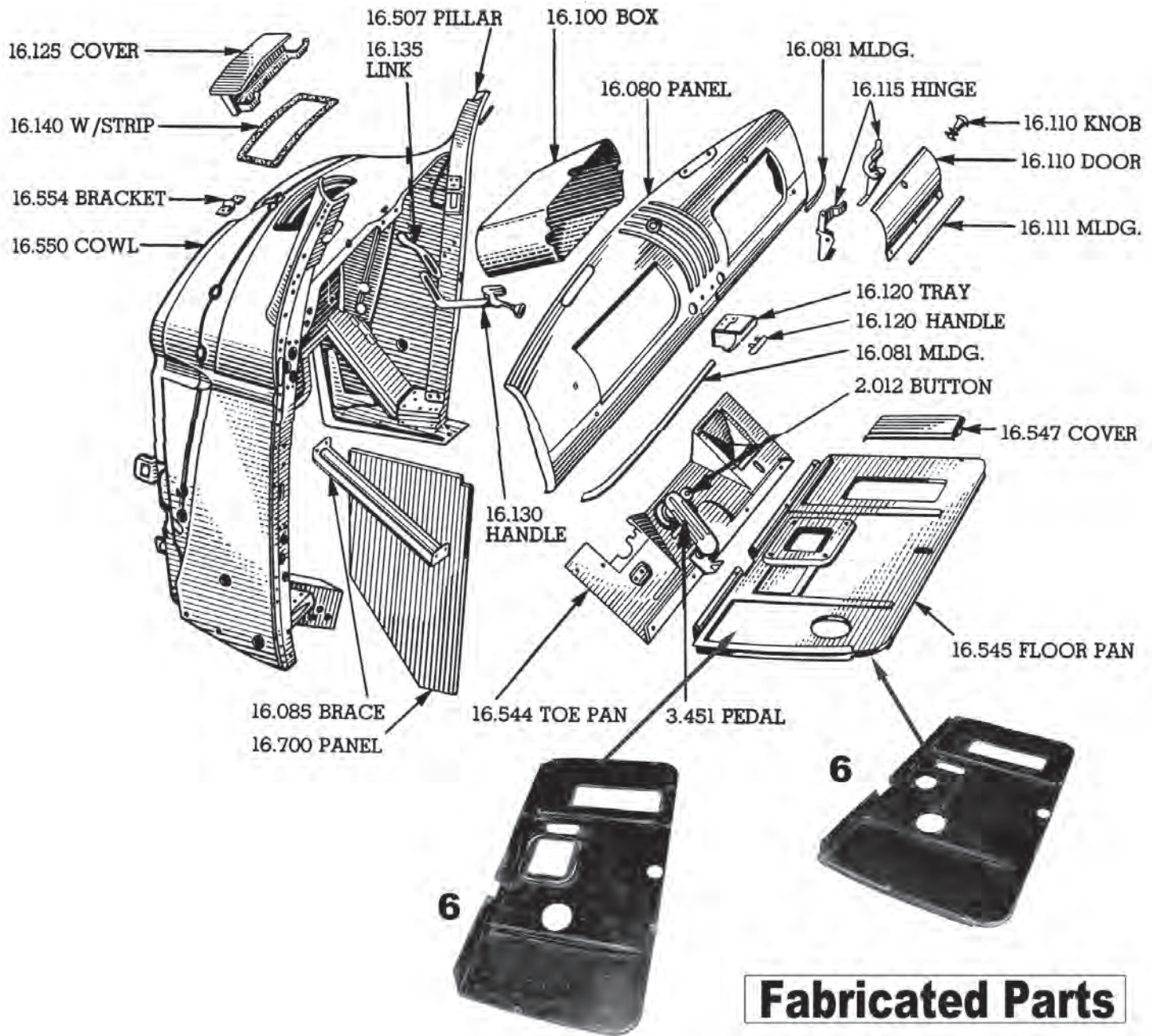

Fabricated Parts

6. Floorboard

3653211	39-40	Door to door (fiberglass) 4-speed. (16.545-15).....	\$82.00 EA
3681279	41-46	Door to door (fiberglass), 3-speed. (16.545-15).....	\$82.00 EA
3681279A	41-46	Door to door (fiberglass) 4-speed. (16.545-15).....	\$82.00 EA
187694B	41-46	For floor board (21 pcs). (16.542-15).....	\$5.00 SET

Returns require a return authorization number, Please call.

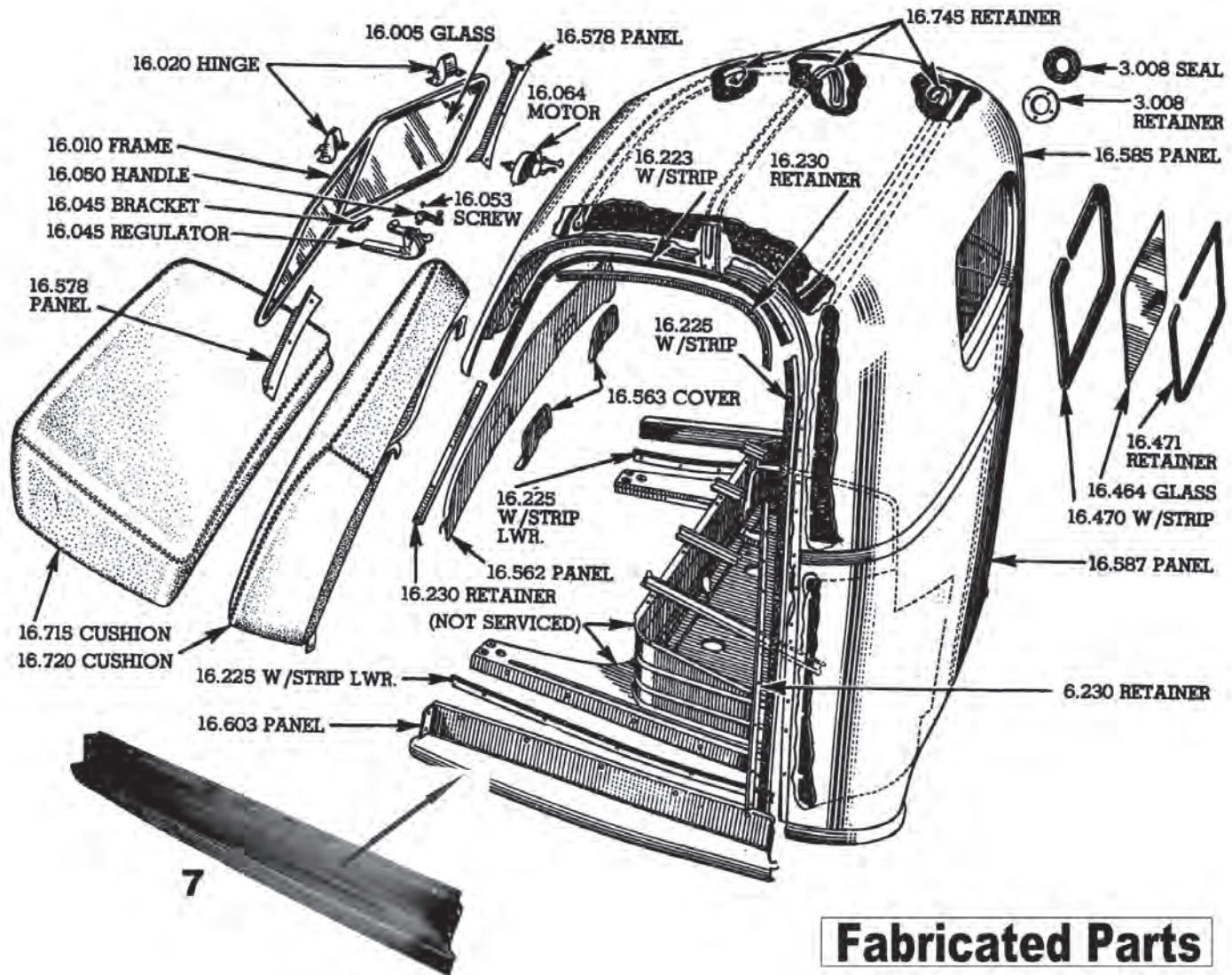

Fabricated Parts

7. Rocker Panel

598655	39-46 Left-fiberglass. (16.603-15).....	\$70.00 EA
598656	39-46 Right-fiberglass. (16.603-15)	\$70.00 EA

295T



Section 295T: 1947-54 Truck Body Parts

Format = Part No., Year, Description, Original Chevrolet Parts Book Group No., Price and Unit of Measure.

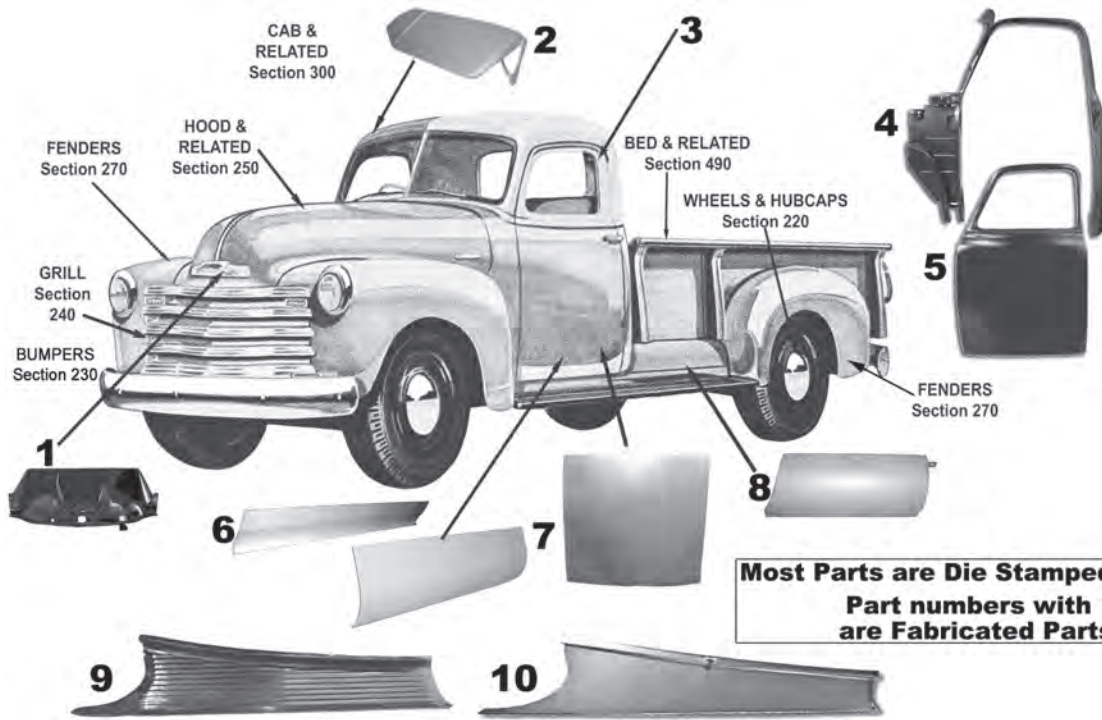

**Most Parts are Die Stamped
Part numbers with *
are Fabricated Parts**

1. Hood Latch Lower Assembly

3682709C	47-53	Complete chrome assembly. (8.08-15) . . .	\$225.00 EA
3682709P	47-53	Complete assembly, black. (8.08-15) . . .	\$150.00 EA
2228975	47-53	Above Grille. Fits GMC. (6.079-15)	\$179.50 EA

2. Sunvisor -Exterior

986877F	47-53	Aluminum, Fulton repro w/ mounting hardware & instructions. (37-52 car). Adjustable. (10.201-15)	\$500.00 EA
986877FSD	47-53	Metal, Fulton reproduction with mounting hardware & instructions. Adjustable. (10.201-15) . .	\$500.00 EA

Radiator Core Support (not shown)

3707011	47-55	For center fill radiator. (1.27-15)	\$229.50 EA
---------	-------	---	-------------

3. Window Reveal Mouldings

3684847B	47-54	Stainless. (16.185-15)	\$200.00 L&R
3684847	47-54	Left door. (16.185-15)	\$69.00 EA
3684848	47-54	Right door. (16.185-15)	\$69.00 EA

3. Reveal Mouldings

3684289	47-54	Left door. Window drip rail. (16.642-15) . . .	\$45.00 EA
3684290	47-54	Right door. Window drip rail. (16.642-15) . .	\$45.00 EA

4. Door Pillar

3807227B	47-53	Outer, left side w/ side cowl panel & windshield frame. (16.578-15)	\$400.00 EA
----------	-------	---	-------------

3807228B	47-53	Outer, right side w/ side cowl panel & windshield frame. (16.578-15)	\$400.00 EA
----------	-------	--	-------------

5. Door - Metal

3684147	47-50	Steel door. Left side minus trim & hardware. EDP black finish. Exc COE. (16.15-15)	\$450.00 EA
3684148	47-50	Steel door. Right side minus trim & hardware. EDP black finish. Exc COE. (16.15-15)	\$450.00 EA
3695437	51	Steel door. Left side minus trim & hardware. EDP black finish. Exc COE. (16.15-15)	\$450.00 EA
3695438	51	Steel door. Right side minus trim & hardware. EDP black finish. Exc COE. (16.15-15)	\$450.00 EA
3810915	52-55	Steel door. Left side minus trim & hardware. EDP black finish. Exc COE. (16.15-15)	\$450.00 EA
3810916	52-55	Steel. Right side minus trim & hardware. EDP black finish. Exc COE. (16.15-0)	\$450.00 EA

6. Door Patch Panel (inner)

3684147DL	47-54	Inner bottom, left (superior). (16.15-15) . . .	\$44.75 EA
3684147DR	47-54	Inner bottom, right (superior). (16.15-15) . .	\$44.75 EA
3684147C	47-54	Inner bottom (4in. high 32-1/2in. long). (16.15-20)	\$30.75 EA

7. Door Patch Panel (outer)

3684147BL	47-54	Outer bottom left (superior). (16.15-15) . . .	\$46.00 EA
3684147BR	47-54	Outer bottom right (superior). (16.15-15) . .	\$46.00 EA
3684147A	47-54	Outer bottom (10in. high 36in. long). (16.15-20)	\$36.75 EA

8. Side Splash Apron

3676427L	47-53	Left-1/2T. (8.228-15)	\$36.75 EA
3676428R	47-53	Right-1/2T. (8.228-15)	\$36.75 EA

Returns require a return authorization number, Please call.

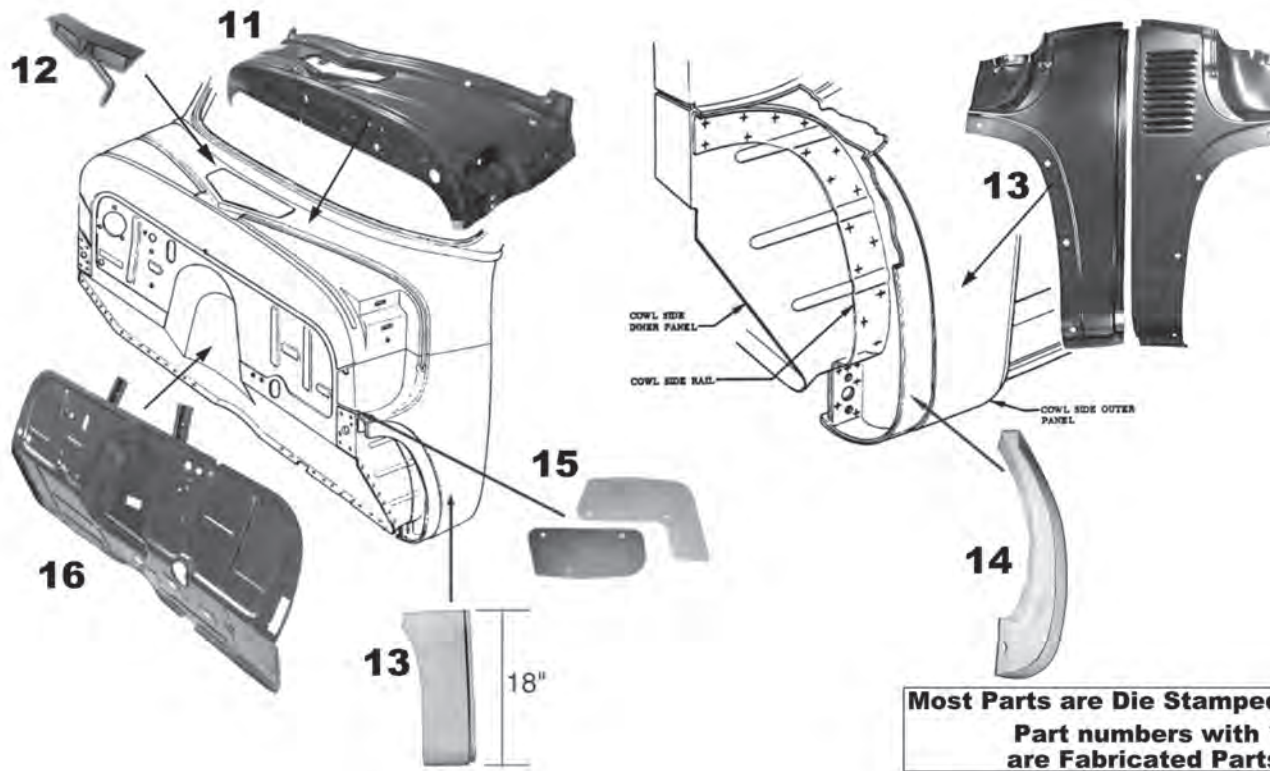

8. Side Splash Apron—cont.

3676429L	47-53	Left-3/4T. (8.228-15)	\$45.00 EA
3676430R	47-53	Right-3/4T. (8.228-15)	\$45.00 EA
3700361L	54	Left-1/2T. (8.228-15)	\$40.00 EA
3700362R	54	Right-1/2T. (8.228-15)	\$40.00 EA
3700365L	54	Left-3/4T. (8.228-15)	\$45.00 EA
3700366R	54	Right-3/4T. (8.228-15)	\$45.00 EA

9. Running Boards w/ Built-in Mounting Points (Fiberglass)

3682721S	47-54	Fiberglass-smooth 1/2T. (8.299-15)	\$308.75 PR
3682721W	47-54	Fiberglass-smooth 1/2T (2in. wider). (8.299-15)	\$330.75 PR
3682729FR	47-54	Fiberglass-stock (ribbed) 3/4T. (8.299-15)	\$419.00 PR
3682729F	47-54	Fiberglass-smooth 3/4T. (8.299-15)	\$399.00 PR

10. Running Boards w/ Built-in Mounting Points (Steel)

3687271SC	47-54	Chrome, ribbed steel. 1/2T. (8.299-0)	\$550.00 PR
3687271	47-54	Steel (super repro) 1/2T. (8.299-15)	\$550.00 PR
3687271S	47-54	Smooth 16ga.cold rolled steel. 1/2T. (8.299-0)	\$375.50 PR
3687271SW	47-54	Smooth 16ga.cold rolled steel. 1/2T (2 in. wider). (8.299-0)	\$398.75 PR

Running Board Brackets

3683573B	47-55	Left side. (7.016-15)	\$175.00 SET
----------	-------	-----------------------	--------------

Running Board Brackets—cont.

3683574B	47-55	Right side. (7.016-15)	\$175.00 SET
----------	-------	------------------------	--------------

11. Cowl Panel - Metal Upper

3696433A	47-53	Nice quality panel. Full top of cowl. (16.551-15)	\$250.00 EA
----------	-------	---	-------------

12. Cowl Vent

3682919	47-53	Assembly with handle. (16.125-15)	\$125.00 EA
---------	-------	-----------------------------------	-------------

13. Cowl Patch Panel Metal Outer

3683003SL	47-54	Left-superior (no louvers). 31" height. (16.551-20)	\$99.50 EA
3683002SR	47-54	Right-superior (w/ louvers). 31" height. (16.551-20)	\$99.50 EA
3683003B	47-54	Lower-left. (16.551-15)	\$35.00 EA
3683002B	47-54	Lower-right. (16.551-15)	\$35.00 EA

14. Cab Front Lower Corner

3687291	47-54	Arc-shaped firewall corners (behind tires) left. (16.551-15)	\$52.00 EA
3684032	47-54	Arc-shaped firewall corners (behind tires) right. (16.551-15)	\$52.00 EA

15. Metal Filler Panel

3685642	47-54	Firewall to inner panel. (8.155-15)	\$10.00 PR
---------	-------	-------------------------------------	------------

16. Firewall (steel)

3696815A	47-54	Complete repro steel firewall. Excellent quality. EDP coated. (16.551-15)	\$250.00 EA
----------	-------	---	-------------

Providing part numbers speeds up your order, improves accuracy and helps us maintain low prices.

See Illustration Index for core charge information and a list of abbreviations. For Body Model information, see Section 5T.



Section 295T: 1947-54 Truck Body Parts

Format = Part No., Year, Description, Original Chevrolet Parts Book Group No., Price and Unit of Measure.

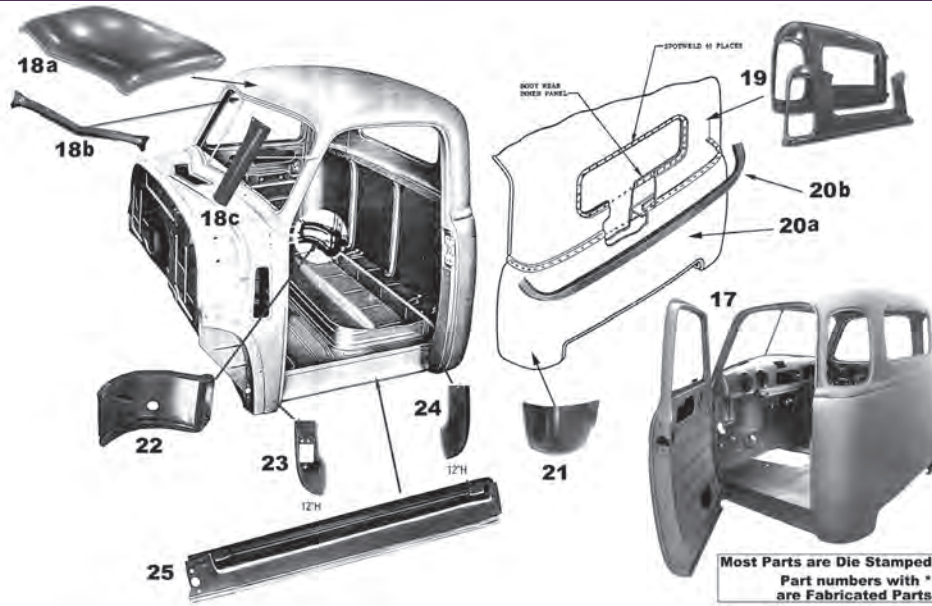

17. All Steel Cab

- | | | | |
|---------|-------|--|---------------|
| TR47PUT | 47-53 | Start your next build the right way with a rust free 5-window Chevy steel cab. Now in production!! Black primered. Includes windshield center bar and 47-50 doors (non-vent window) mounted w/ hinges (latch hardware not included). (16.585-0)..... | \$8,995.00 EA |
| TR52PUT | 47-53 | Same as above but with Start your next build the right way with a rust free 5-window Chevy steel cab. Now in production!! Black primered. Includes windshield center bar and 52-53 doors (for vent window) mounted w/ hinges (vent window & door latch hardware not included). (16.585-0)..... | \$8,995.00 EA |
| TR55PUT | 55-57 | Start your next build the right way with a rust-free 55-57 (2nd Series) Chevy steel cab. Now in production!! Black primered. Includes doors mounted w/ hinges (latch hardware not included). (16.585-0)..... | \$8,995.00 EA |

18a. Cab Roof

- | | | | |
|----------|-------|--|-------------|
| 3693099A | 47-54 | Metal replacement panel. (16.585-15) . . . | \$320.00 EA |
|----------|-------|--|-------------|

18b. Windshield Upper Roof Panel Brace

- | | | | |
|---------|-------|--|------------|
| 3809231 | 47-53 | Die stamped, EDP coated (16.553-15). . . . | \$65.00 EA |
|---------|-------|--|------------|

Sunvisor -Exterior

- | | | | |
|---------|-------|--|-------------|
| 986877 | 47-53 | Accessory. Exterior Sunvisor. (10.201-15) | \$275.00 EA |
| 986878S | 54-55 | Steel reproduction with mounting hardware & instructions. Fits Chevy & GMC. (10.201-15)..... | \$500.00 EA |

18c. Windshield Pillar Panel

- | | | | |
|----------|-------|-----------------------------------|------------|
| 3807227L | 47-53 | Left side. (16.578-15) | \$20.00 EA |
| 3807227R | 47-53 | Right side. (16.578-15) | \$20.00 EA |

19. Cab Back Panel - Upper

- | | | | |
|----------|-------|---|-------------|
| 3809365B | 47-54 | Upper interior panel for 5 window cabs. (16.585-15) | \$339.00 EA |
| 3809173B | 47-54 | Upper interior panel for 3 window cabs. (16.585-15) | \$325.00 EA |
| 3693001 | 47-54 | Upper exterior panel for 3 window cabs. (16.589-15) | \$355.00 EA |
| 3693099 | 47-54 | Upper exterior panel for 5 window cabs. (16.585-15) | \$355.00 EA |

20a. Cab Back Panel - Lower

- | | | | |
|---------|-------|---|-------------|
| 3693000 | 47-54 | Exterior panel below back window. (16.587-15) | \$450.00 EA |
|---------|-------|---|-------------|

NEW! Cab Lower Rear Back Panel Crossmember

- | | | | |
|----------|-------|---------------------------------------|------------|
| 3693000R | 47-54 | ADD DESCRIPTION (16.587-15) | \$55.00 EA |
|----------|-------|---------------------------------------|------------|

21. Cab Corner Patch Panel - Outer

- | | | | |
|----------|-------|---|------------|
| 3693003A | 47-54 | Outer left, rear. (16.587-15) | \$47.50 EA |
| 3693002A | 47-54 | Outer right. (16.587-15) | \$47.50 EA |

22. Cab Corner Patch Panel - Inner

- | | | | |
|----------|-------|------------------------------------|------------|
| 3693003B | 47-54 | Inner left. (16.587-15) | \$40.25 EA |
| 3693002B | 47-54 | Inner right. (16.587-15) | \$40.25 EA |

23. Door Hinge Post Lower

- | | | | |
|---------|-------|------------------------------|------------|
| 3700481 | 47-54 | Left. (16.603-15) | \$43.25 EA |
| 3700482 | 47-54 | Right. (16.603-15) | \$43.25 EA |

24. Door Latch Post Lower

- | | | | |
|---------|-------|------------------------------|------------|
| 3703551 | 47-54 | Left. (16.163-15) | \$46.25 EA |
| 3703552 | 47-54 | Right. (16.603-15) | \$46.25 EA |

Returns require a return authorization number, Please call.

Section 295T: 1947-54 Truck Body Parts

Format = Part No., Year, Description, Original Chevrolet Parts Book Group No., Price and Unit of Measure.

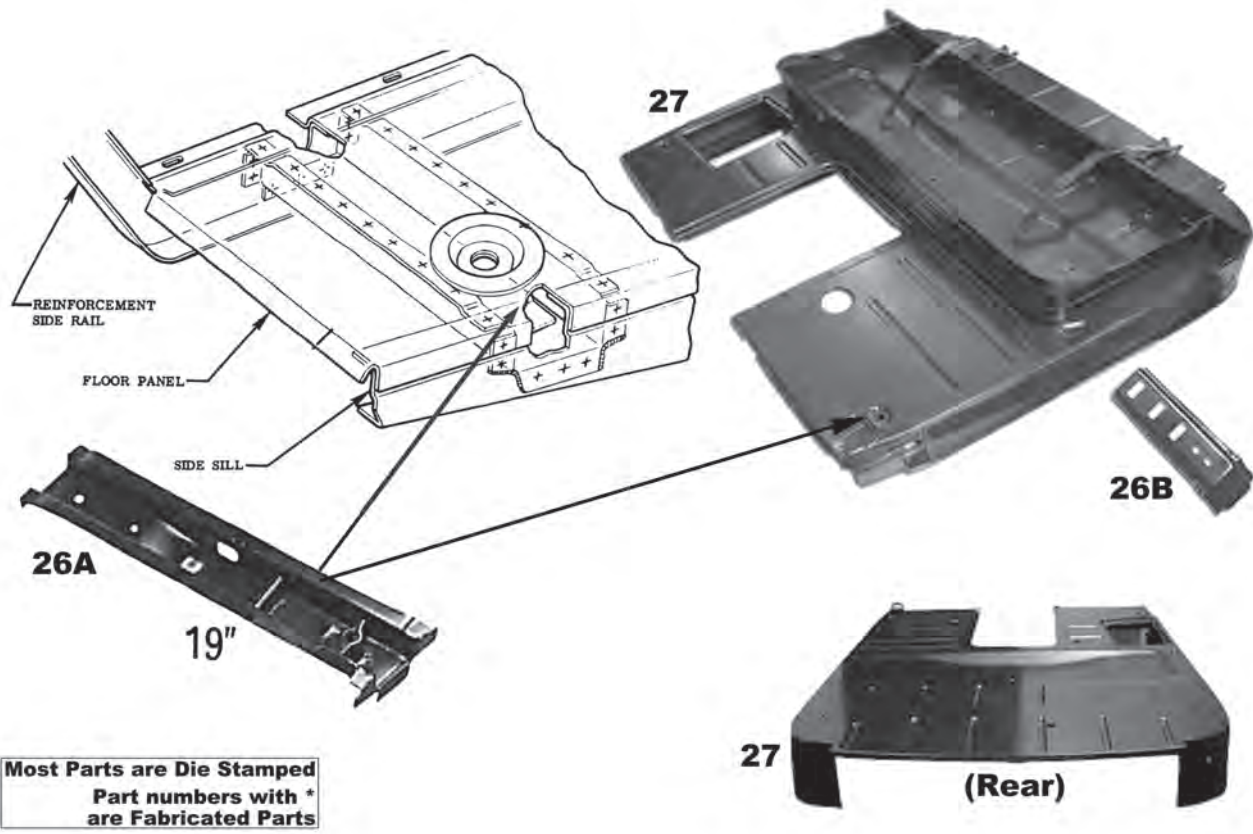

25. Rocker Panel-Outer

3692809	47-54	Left. (16.603-15)	\$38.75 EA
3692809S	47-54	Left (superior). (16.603-15)	\$54.25 EA
3692810	47-54	Right. (16.603-15)	\$38.75 EA
3692810S	47-54	Right (superior). (16.603-15)	\$54.25 EA

26a. Cab Mount Brace (Front)

3809493S	47-54	Front left-die stamped (superior). (16.545-15)	\$44.75 EA
3809494S	47-54	Front right-die stamped (superior). (16.545-15)	\$44.75 EA

26b. Cab Mount Brace (Rear)

3809495	47-54	Connects cross brace. (16.545-15)	\$36.75 EA
3809496B	47-57	Fabricated (16.454-15)	\$80.75 SET

Cab Back Panel Supports

3693000S	47-54	3 pieces. (16.587-15)	\$55.00 SET
----------	-------	-----------------------	-------------

27. Floor Pan

3713907AC	47-54	Complete Metal Floor Pan w/ tank straps, seat riser and floor braces. Excellent quality. (16-15)	\$575.00 EA
3713907A	47-54	with braces. (16-15)	\$525.00 EA

Note: For tank straps refer to section 120T

295T

Providing part numbers speeds up your order, improves accuracy and helps us maintain low prices.

See Illustration Index for core charge information and a list of abbreviations. For Body Model information, see Section 5T.



Section 295T: 1947-54 Truck Body Parts

Format = Part No., Year, Description, Original Chevrolet Parts Book Group No., Price and Unit of Measure.

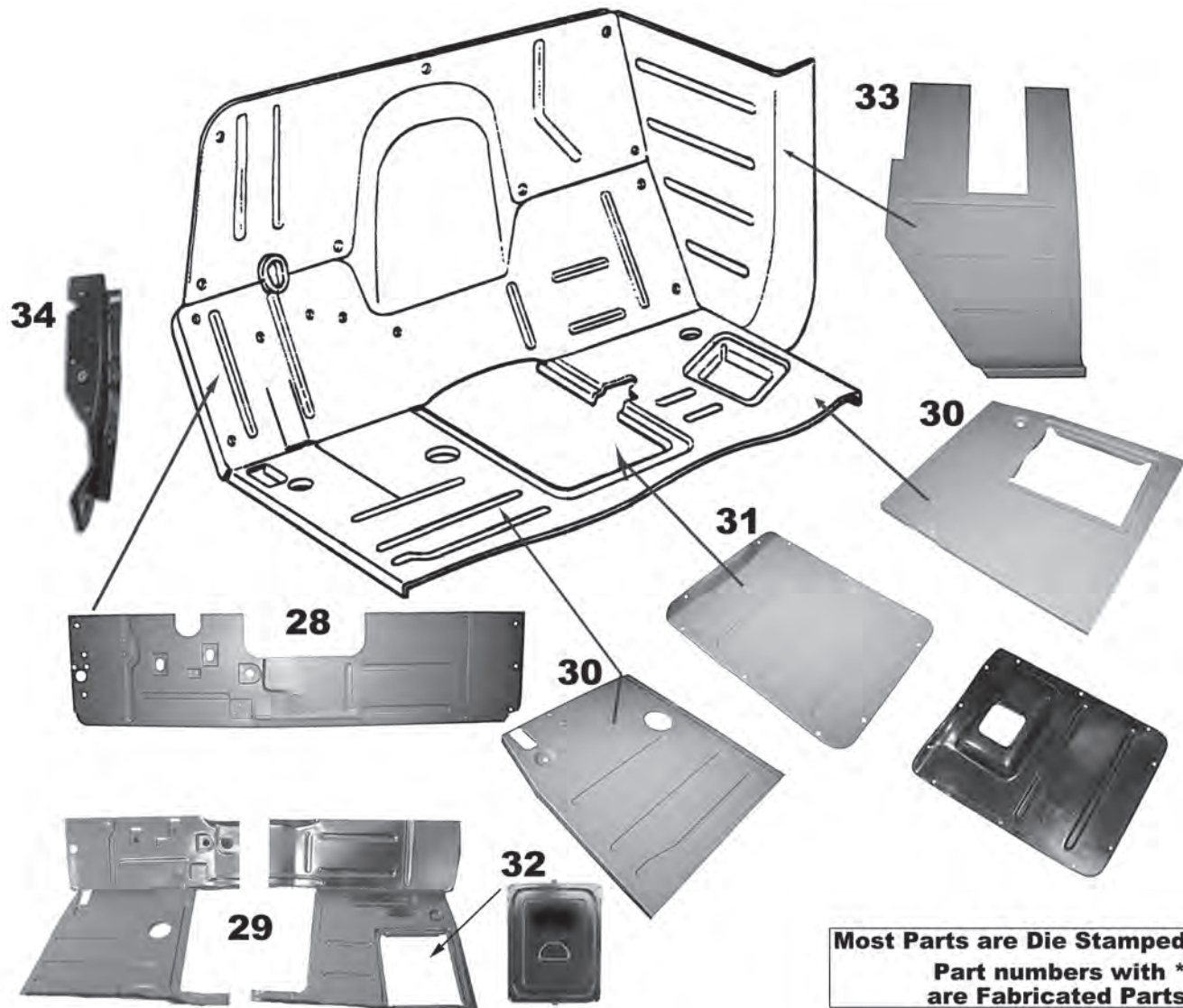

**Most Parts are Die Stamped
Part numbers with *
are Fabricated Parts**

28. Toe Board (Metal)

3700191A 47-55 Floor to firewall. (16.23-15)..... \$167.00 EA

29. Floor Panel (from seat forward)

3701601LC 47-54 Complete with toe board left. (16.545-20) \$116.50 EA

3701601RC 47-54 Complete with toe board right.
(16.545-20)..... \$116.50 EA

30. Floor Panel (from seat forward)

3701601L 47-54 Left (die stamped). (16.545-15)..... \$55.00 EA

3701601R 47-54 Right (die stamped). (16.545-15)..... \$55.00 EA

31. Floor Insert Over Transmission

3682939 47-55 Metal 3 speed. (16.547-15)..... \$42.00 EA

3697607 47-55 4 speed. (16.547-15)..... \$69.00 EA

3697607F 47-55 Fiberglass 4 speed. (16.547-15)..... \$48.00 EA

32. Battery Cover

3683383 47-54 Mounts in floor. (16.547-15)..... \$60.00 EA

33. Kick Panel-Metal Repair Panel

3693495 47-50 Inner left. (16.551-15)..... \$35.00 EA

3696023 51-54 Inner left. (16.551-15)..... \$32.75 EA

3809358 47-54 Inner right. (16.551-15)..... \$35.00 EA

34. Emergency Brake Bracket

3687303 48-55 For foot operated pedal. (4.648-15)..... \$45.00 EA

Returns require a return authorization number, Please call.

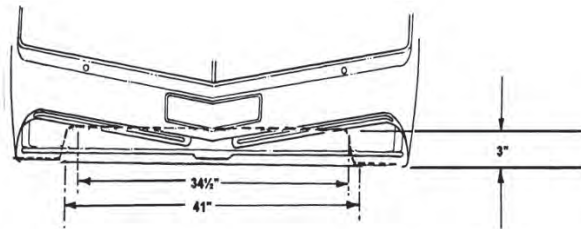
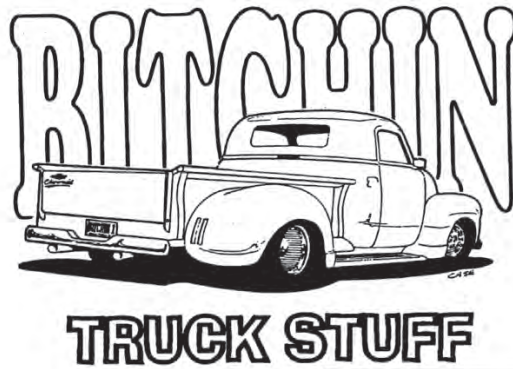

FIREWALL—PICKUP AND PANEL TRUCK

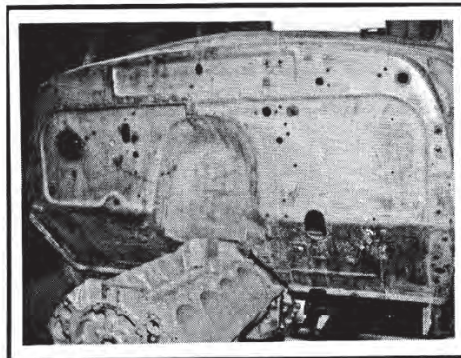
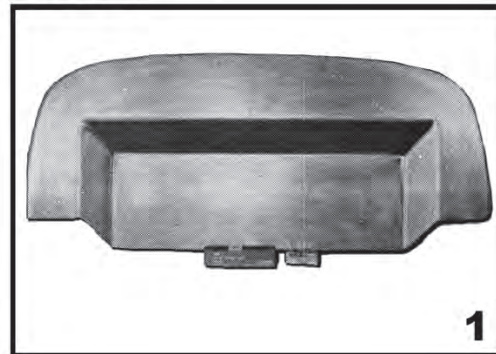

BEFORE YOU START...

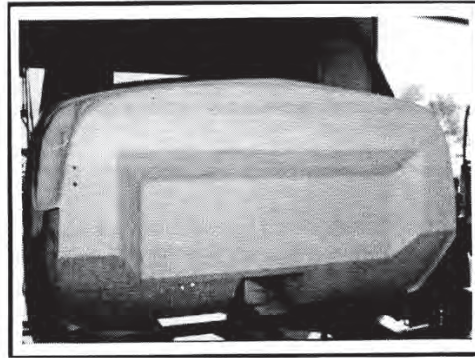

AFTER YOU FINISH.....

1. Firewall (steel)

3693009S54 47-54 Kit w/ set back. Smooth for V8. Use with front floor kit #3686335b54 or stock floor. (16.545-15)..... \$414.25 EA

Universal Battery Boxes

593780A Box for group 42. (2.333-15) \$75.50 EA
 593779A Box for group 71. (2.333-15) \$75.50 EA

295T



Section 295T: BITCHIN Sheetmetal Parts

Format = Part No., Year, Description, Original Chevrolet Parts Book Group No., Price and Unit of Measure.

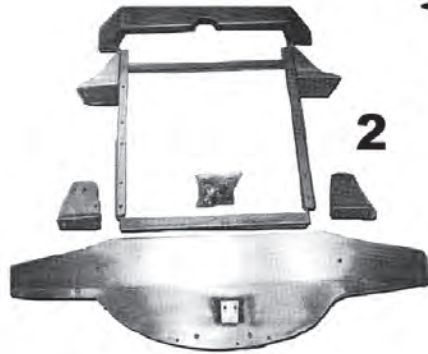

2



3



4



5



6



7



8

2. Radiator Core Support

- 3684764 47-53 For center fill radiator. (16.545-15) \$382.25 KIT
- 3684764B 54-55 For radiator with side fill. (16.545-15) . . . \$347.50 EA

3. Cowl Vent Filler Panel

- 3683004A53 47-53 (16.545-20) \$24.00 EA
- 3683004B54 54 (16.545-20) \$24.00 EA

4. Drivers Side Vent Filler

- 3683001 47-54 (16.545-20) \$24.00 EA

5. Inner Fender Apron Kit

- 3686239 47-54 Cleans look of engine bay. Bolt-in. Stock or Bitchin firewalls/ core supports. (16.545-15) . . . \$380.00 SET

6. Floor Kit

- 3686335A54 47-54 Front floor with stock firewall. (16.545-15) \$375.00 SET

7. Floor Kit

- 3686336R54 47-54 Rear floor. (0-15) \$197.50 SET

8. Floor Kit

- 3686335B54 47-54 Front floor panels with toe board. For use with "bitchin" firewall #3693009s54. (0-15) . \$375.00 SET

Returns require a return authorization number, Please call.

Section 300T: Cab Shims & Mountings

Format = Part No., Year, Description, Original Chevrolet Parts Book Group No., Price and Unit of Measure.



Cab Mount



3654239K 39-46
Includes pads, blocks, springs &
hardware. (9.015-15) \$69.75 SET

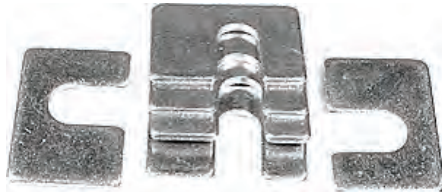

366983 All
1/8in. shims (1-3/4in. x 1-1/8in.
with 1/2in. slot) (6 pcs).
(9.023-30) \$3.00 SET



366982 All
1/16in. shims (1-3/4in. x
1-1/8in. with 1/2in. slot) (6 pcs).
(9.023-30) \$2.50 SET



366985 All
1/8in. shims (1-1/4in.
x 1-1/8in. with 1/2in.
slot) (6 pcs). (9.023-40)
\$3.00 SET



366984 All
1/16in. shims (1-1/4in.
x 1-1/8in. with 1/2in.
slot) (6 pcs). (9.023-40) \$3.50 SET

Body Mount Pads



3685018A. . . . 47-54
Panel or Suburban.
(9.009-30) \$25.25 SET

Cab Mount Wood Blocks



476534B. . . . 39-40
(9.015-15) . . \$8.00 PR

Cab Mount Pads

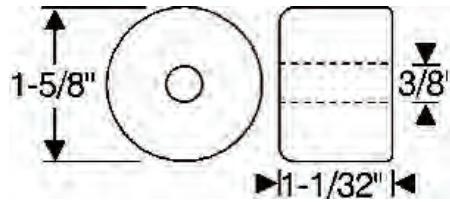

3654239B 37-46
At #4 bolt. (9.015-15) \$31.50 PR

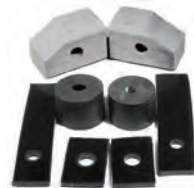

3654239 39-46
w/ blocks & #4 bolt
pads (1-7/8" dia. x
1-5/8" thickness x 1/2"
bolt hole). (9.015-15) .
\$33.75 SET



3701322 47-54
Front (9.023-30)
\$5.50 SET

Cab Mount Rear

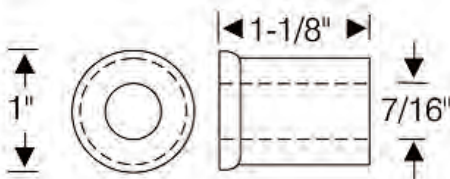

3660540 47-54
Rubber bushings (8 pcs).
(7.524-20) \$12.00 SET

Body Bolt Kits

BODYBOLT_47-51 47-51
Cab & Short Bed. Indented Hex Head
hardware kit. (9.008-15) . \$327.50 SET

BODYBOLT_47-51 47-51
Cab only. Indented Hex Head hardware
kit.
(9.008-15) \$170.00 SET

3701322S 47-54
Front only.
(9.008-15) \$29.00 SET

BODYBOLT_52-53 52-53
Cab & Short Bed. Indented Hex Head
hardware kit.
(9.008-15) \$319.00 SET

BODYBOLT_52-53 52-53
Cab only. Indented Hex Head hardware kit.
(9.008-15) \$167.00 SET

BODYBOLT_54-55 54-55
Cab & Short Bed. Indented Hex Head
hardware kit. 54-55 (1st Series).
(9.008-15) \$330.00 SET

BODYBOLT_54-55 54-55
Cab only. Indented Hex Head hardware
kit. 54-55 (1st Series).
(9.008-15) \$170.00 SET

Cab Mount Bolt Set



3654239A 37-40
(9.015-40) \$16.00 SET

3654239A 41-46
(9.015-30) \$20.50 SET



3701322C. . . . 47-54
Front (9.008-30)
\$4.50 SET

Cab Mount Body To Frame



3701322B 47-54
Pads & bolts. (9.015-15) . \$27.00 SET

*Please call for availability on all Odds
& Ends parts; once part is sold, it may
no longer be in stock.*

Odds & Ends

05605 34-37
Clutch Pressure plate 1-1/2T (12*000-0)
\$95.00 EA

3725249 54-56
Stud (w/ diaphragm spring clutch)
(12*000-0) \$7.50 EA

Providing part numbers speeds up your order, improves accuracy and helps us maintain low prices.

See Illustration Index for core charge information and a list of abbreviations. For Body Model information, see Section 5T.



Section 310T: Firewalls, Firewall Pads & Firewall Grommets

Format = Part No., Year, Description, Original Chevrolet Parts Book Group No., Price and Unit of Measure.

Firewall Pad-Fiberglass w/ Insulation



- 3693007F 39-46 (16.802-15) \$115.50 EA
- 3693009F 51-53 (16.802-0) \$95.00 EA
- 3702869F 54 (16.802-0) \$95.00 EA

Oversize shipping charges apply. Please call for rate.

Firewall Pad -Polyurethane w/ Insulation



- 3693009 47-54 (16.802-15) \$154.00 EA

Firewall Pad-Fiber Board w/ Insulation



- 3687451 47-50 (16.802-15) \$100.00 EA

Oversize shipping charges apply. Please call for rates.

Metal Clips



- 3692752 47-54 Firewall pad 1-3/16in. long (3 pcs). (15.282-15) \$10.50 SET



\$10.50 SET

Insulation



- 3693008A Jute w/ foil on 1 side (4 ft wide). (16.802-15) \$5.00 FT



- 3693008B Jute w/ foil on 2 sides (4 ft wide). (16.802-15) \$11.00 FT

Firewall Grommets



- 3691292A . . . 47-54 Grommet for 5/8in. heater hose (thru firewall). (8.846-20) . . \$8.50 PR



- 3681096 33-46 Ignition armored coil cable. (9.775-15) \$5.75 EA



- 3653762A . . . 39-53 Main wiring harness. (9.775-30) . . \$4.00 EA



- 3653762B . . . 54-59 Main wiring harness. (9.775-20) . . \$4.25 EA



- 875520 39-53 Speedometer cable. (9.775-40) . . \$2.75 EA



- 874420A 39-53 Speedometer cable with 3 holes- use with windshield washer. (9.775-15) . . \$5.25 EA



- 3681071 32-46 Throttle, choke, oil, temperature 3-7/8in. long, 4 holes. (9.775-20) . . \$10.00 EA



- 3673139 36-54 Vacuum hose. (9.775-40) . . \$1.75 EA



- 3711896 51-53 Wiring harness 11/16in. diameter. (9.775-15) . . \$3.25 EA



- 3684771 47-49 4 holes. (9.775-30) . . \$4.00 EA



- 3689044 50-52 4 holes. (9.775-15) . . \$6.00 EA



- 3695170 53-59 4 holes. (9.775-30) . . \$5.00 EA



- 357507 29-46 Steering column at floor (exc COE). (6.758-15) . \$30.75 EA



- 3685928 47-54 Steering column with metal core & sponge seal #3682871 at firewall (floor shift). (6.758-15) . \$13.00 EA



- 3685928A . . . 47-54 Steering column without metal core at firewall (floor shift). (6.758-15) . \$25.00 EA



- 3687205 48-54 Steering column with metal core & sponge seal #3687204 at firewall (column shift). (6.758-15) . . . \$16.00 EA

Returns require a return authorization number, Please call.

Section 310T: Firewalls, Firewall Pads & Firewall Grommets



Format = Part No., Year, Description, Original Chevrolet Parts Book Group No., Price and Unit of Measure.

Screws



3687205A 47-54
Stainless steel for
steering column
grommet. (6.758-40) . . .
\$2.50 EA

Felt Floor Seal



3657153 41-46
Floor felt for steering
column, brake &
clutch. (0.829-15)
\$8.50 EA

Sponge Seal



3687204 47-54
Steering column at
firewall (column shift).
(6.758-30) . . \$5.75 EA



3682871 47-54
Steering column at
firewall (floor shift).
(6.758-40) . \$14.00 EA

Rubber Plug



4805844 49-52
Rubber for 3/4in.
holes. (9.775-30)
\$2.25 EA

Please call for availability on all Odds & Ends parts; once part is sold, it may no longer be in stock.

310T

Providing part numbers speeds up your order, improves accuracy and helps us maintain low prices.

See Illustration Index for core charge information and a list of abbreviations. For Body Model information, see Section 5T.



Heatshield & Noise Barrier Kits

STOP NOISE, STOP HEAT. Selecting noise/ heat reduction products can be very confusing. We have made this an easier process by creating 3 different levels of kits: **Ultimate, Basic & Acousti-Shield**

Ultimate Noise Barrier Kit

Ultimate Noise Barrier Kit includes:

- One vibration damping sheet (VDAMP-2)
- Four acoustic sound floor barrier sheets (VBLOK-VB4.5)
- One gallon of sprayable sound deadener (DEADENER)
- Complete instructions for all items in kit.
- Option: One gallon of sprayable HEATSHIELD (details of individual components below)

Ultimate Noise Barrier Kit without HEATSHIELD	
13209	\$620.00 EA
Ultimate Noise Barrier Kit with HEATSHIELD	
13209-1	\$725.00 EA

Basic Noise Barrier Kit

Basic Noise Barrier Kit includes:

- Two thermal acoustic blankets (Insulator 12)
- One gallon sprayable sound deadener (DEADENER)
- Spray-on adhesive material & specialty seam tape
- Complete instructions.
- Option: One gallon of sprayable HEATSHIELD (details of individual components below)

Basic Noise Barrier Kit without HEATSHIELD	
13211	\$212.00 EA
Basic Noise Barrier Kit with HEATSHIELD	
13211-1	\$317.00 EA

Individual Heatshield & Noise Barrier Components

Vibration Damping Sheet. Moldable, odorless & lightweight mineral filled vinyl copolymer formulated to handle the extremes of aircraft and automotive vibration & noise control. 40% lighter than asphalt damping materials. Can handle continuous temps to 250 degrees. Paintable and can be applied to wood, fiberglass, sheet-metal and plastic panels. 2 sizes of thickness available. Each sheet= 37" x 54" (covers 14 sq. ft.)



Individual sheet. Thickness=.042".	
VBDAMP-2	\$70.00 EA
HEAVY DUTY individual sheets. Thickness=.075"	
VBDAMP-2HD	\$100.00 EA

BARRIER VBLOCK-VB3

Multi-layered composite material, which provides a shock absorbing, noise penetration barrier and thermal insulation. The isolation layer is constructed of a closed cell reinforced neoprene which decouples the floating lead septum from the vibrating source structure (floorboards etc.) creating a floating wall, which is one of the most effective noise penetration barrier materials.

SMALL 49" x 36" individual sheets. (12 sq. ft.) Thickness=.25"	
VBLOK-VB3.5	\$180.00 EA



THERMAL INSULATOR VBLOK-INS12

Thermo-Acoustic Blanket guards against the intrusion of heat, sound, vibration and airflow. Consisting of an all natural cotton fiber layer with surface layers of foil, it provides up to 50% greater R-value than other reflective insulation materials.

4' x 6'. Covers 24 sq. ft.	
VBLOK-INS12	60.00 EA

Sprayable sound **DEADENER** is a high performance air curing damping compound designed specifically for the interior & exterior side of body panels. Easy to apply (can also be brushed or rolled on), non-toxic & water based. 1 gallon.



DEADENER	\$84.00 EA
-----------------------	------------

HEATSHIELD is lightweight, pliable and bonds to virtually any material! Made up of air filled glass beads held in suspension by a high temp latex acrylic binder. Currently used in the US space shuttle program. Two 15 mil applications yield a thermal value of R-24. Insulate & prevent corrosion with one product. Easy to apply (spray, brush or roll on) and non-toxic. 1 gallon at 15-mil thick will cover approximately 50-60 square feet.

HEATSHIELD	\$100.00 EA
-------------------------	-------------

1 quart, external mix, siphon-feed spray gun. Use to apply HEATSHIELD/ DEADENER.

SPRAYGUN	\$100.00 EA
-----------------------	-------------



BARRIER VBLOCK-VB4

A composite material with a flexible, loaded vinyl mass barrier and a foam decoupling layer which reduces road noise by impeding the passage of soundwaves and acting as an airspace and spring. Its flexible nature prevents the composite from taking on vibrations from supporting structures, resulting in superior transmission loss over a broad frequency range.



SMALL 54" x 37" individual sheets (14 sq. ft.) Thickness=.25"	
VBLOK-VB4.5	\$138.00 EA

WEB SPRAY ADHESIVE

12 oz. can. Ideal for acoustic panel installation.	
WEBAD	\$17 EA

Returns require a return authorization number, Please call.



Format = Part No., Year, Description, Original Chevrolet Parts Book Group No., Price and Unit of Measure.

Accousti-Shield Kits

FULL KIT INCLUDES: FULLY ILLUSTRATED INSTRUCTIONS FOR A PAINLESS, TWO-HOUR INSTALLATION. STAGE 1: PRE-SIZED SOUND DAMPER PADS. The first stage consists of pre-trimmed, self adhesive, Sound Damper Pads. Bonded to strategically located trouble spots on the floor pan and roof of the vehicle to control body panel vibration and noise. These spots are mapped and labeled in detailed instructions which are included in each kit. STAGE 2: PRE-TRIMMED HEAT ABSORBER/BARRIER PANELS, SPRAY ADHESIVES AND SEALING TAPE. The second stage uses a high-tech absorbing, barrier material bonded to the body panels. Will deaden sound and insulate the vehicle from radiant heat penetration. Each absorber panel is cut to the correct shape and contour for your vehicle and is mapped and labeled with detailed instructions. Individual components available for most kits (components shown below in gray).

Turn Your Chevy Truck into "Quiet Riding Comfort"

Stage 1
Sound Damper Pads



The first stage consists of pre-trimmed, self-adhesive, Sound Damper Pads, bonded to strategically located trouble spots on the floor pan and roof of the vehicle to control body panel vibration and noise. These spots are mapped and labeled in detailed instructions which are included in the kit.

Stage 2
Heat Absorber/Barrier Panels



The second stage uses a high-tech absorber/barrier material, bonded to the body panels, to both sound deaden and insulate the vehicle from radiant heat penetration from the engine and road. Each absorber panel is cut to the correct shape and contour and is mapped and labeled in the detailed instructions.

Kits Include:

- Stage 1 Pre-Sized Sound Damper Pads
- Stage 2 Pre-Trimmed Heat Absorber / Barrier Panels, Spray Adhesive and Sealing Tape
- Complete Illustrated Installation Instruction



1937-1946 Chevy Truck Complete Kit #12927	\$414
1936-1938 Chevy Truck Late Low Cab Headliner (Molded).	\$193
1936-1938 Chevy Truck Cowl Panel Set (ABS Plastic)	\$50
1937-1938 Chevy Truck Molded Headliner	\$193
1937-1938 Chevy Truck Cowl Side Panels (ABS Plastic)	\$50
1937-1946 Chevy Truck Firewall Insulator	\$154
1937-1946 Chevy Truck Cowl Insulation Kit.	\$46
1937-1946 Chevy Truck Floor Insulation Kit.	\$164
1937-1946 Chevy Truck Rear Cab Insulation Kit	\$93
1937-1946 Chevy Truck Roof Insulation Kit.	\$93
1939-1946 Chevy Truck Molded Headliner.	\$180
1939-1946 Chevy Truck Cowl Panel Set (ABS Plastic)	\$50
1944 Chevrolet 1.5 Ton G 7 Military Firewall	\$219
1947-49 Chevy Truck Two-Piece Headliner (Original Style)	\$90
1947-53 Chevy Panel Delivery Complete Kit #15893	\$852
1947-53 Chevy Panel Delivery Body Panel Insulation Kit	\$180
1947-53 Chevy Panel Delivery Cowl Insulation Kit	\$93
1947-53 Chevy Panel Delivery Floor Insulation Kit	\$164
1947-53 Chevy Panel Delivery Headliner (ABS Plastic)	\$293
1947-53 Chevy Panel Delivery Rear Door Insulation Kit	\$81
1947-53 Chevy Panel Delivery Rear Floor Insulation Kit	\$140
1947-53 Chevy Panel Delivery Roof Insulation Kit	\$199
1947-53 Chevy Suburban Complete Kit #15894	\$629
1947-53 Chevy Suburban Cowl Insulation Kit	\$93
1947-54 Chevy Suburban Front Floor Insulation Kit	\$164
1947-53 Chevy Suburban Headliner	\$293
1947-53 Chevy Suburban Rear Door Insulation Kit	\$81
1947-53 Chevy Suburban Rear Floor Insulation Kit	\$117
1947-53 Chevy Suburban Roof Insulation Kit	\$164

1947-53 Chevy Truck Complete Kit #12928	\$459
1947-53 Chevy Truck Cowl Insulation Kit	\$93
1947-53 Chevy Truck Floor Insulation Kit	\$164
1947-53 Chevy Truck Molded Headliner	\$193
1947-53 Chevy Truck Rear Cab Insulation Kit	\$93
1947-53 Chevy Truck Roof Insulation Kit (split window)	\$93
1947-54 Chevy Panel Delivery Body Panel Cover (ABS Plastic)	\$135
1954-55 Chevy Panel Delivery Complete Kit	\$800
1954-55 Chevy Panel Delivery Body Panel Insulation Kit	\$180
1954-55 Chevy Panel Delivery Cowl Insulation Kit	\$93
1954-55 Chevy Panel Delivery Front Floor Insulation Kit	\$164
1954-55 Chevy Panel Delivery Headliner	\$293
1954-55 Chevy Panel Delivery Rear Door Insulation Kit	\$81
1954-55 Chevy Panel Delivery Rear Floor Insulation Kit	\$117
1954-55 Chevy Panel Delivery Round Window Roof Insulation Kit	\$164
1954-55 Chevy Suburban Complete Kit	\$629
1954-55 Chevy Suburban Cowl Insulation Kit	\$93
1954-55 Chevy Suburban Front Floor Insulation Kit	\$164
1954-55 Chevy Suburban Headliner	\$293
1954-55 Chevy Suburban Rear Door Insulation Kit	\$81
1954-55 Chevy Suburban Rear Floor Insulation Kit	\$117
1954-55 Chevy Suburban Round Window Roof Insulation Kit	\$164
1954-55 Chevy Truck Complete Kit #15889	\$459
1954-55 Chevy Truck Cowl Insulation Kit	\$93
1954-55 Chevy Truck Floor Insulation Kit	\$164
1954-55 Chevy Truck Molded Headliner	\$193
1954-55 Chevy Truck Rear Cab Insulation Kit	\$93
1954-55 Chevy Truck Roof Insulation Kit (round window)	\$93

Providing part numbers speeds up your order, improves accuracy and helps us maintain low prices.

See Illustration Index for core charge information and a list of abbreviations. For Body Model information, see Section 5T.



Section 320T: Floorboard Parts, Seals, Sound Deadeners, Mats & Pedals

Format = Part No., Year, Description, Original Chevrolet Parts Book Group No., Price and Unit of Measure.

Body Deadener



121126C
Hi-tech, 1/2 pound per
square foot (3/16in. x
3 ft x 8 ft). (15.492-15)
\$21.00 FT

Insulation



3693008C
Foil tape for jute
insulation (30 foot x
2in. roll). (16.802-15) .
\$6.25 EA

Web Adhesive Spray

SB-WEBAD
12 oz. can. Ideal for acoustic panel
installation. (-15) \$17.00 EA

Carpet With Pad

3716701C 37-46
Covers firewall to seat riser and side
of seat riser. Specify Loop or Cut
pile, Color and year of vehicle when
ordering. (16.8-15) \$139.75 EA

3698177C 47-53
Covers firewall to seat riser and side of
seat riser. Specify Loop or Cut pile and
Color when ordering. (16.8-15)
\$167.25 EA

3716701C 54-55
Covers firewall to cab back. Specify
Loop or Cut pile and color when
ordering. (16.8-15) \$172.00 EA

Throw Mats



986765A All
Accessory. Rubber w/ black Bowtie (2
pcs) (15.286-15) \$40.00 SET

Front Mat



3716701 37-46
Fits 37-40 w/ modification
(16.8-15) \$82.00 EA



3698177A 47-54
Reproduction (16.8-15) .. \$137.75 EA

Jute Insulation Pad



3698181 47-54
Floor mat (die cut).
(16.8-15) .. \$25.25 EA



3693008
Floor mat (3 ft x 6 ft).
(16.802-15) \$19.75 EA

Plug



592865 36-54
Master cylinder
inspection (in floor).
3-3/8" diameter for 3"
hole. (12.541-15)
\$7.50 EA

Metal Plug



594289B All
Fits 1-1/2in. hole in floor over
body mount bolts (2 pcs)
(9.008-30) \$7.00 SET
594289C All
Fits 3/4in. holes in floor (2 pcs)
(9.008-30) \$1.75 SET
594289D All
Fits 1/2in. holes in floor (2 pcs)
(9.008-30) \$1.50 SET

Battery Cover



354120 29-38
Inspection cover in floor. 4-1/2" x 8"
(16.547-15) \$16.00 EA

Battery



3652966 39-46
Inspection cover in floor. 4-1/2" x 10".
(16.547-15) \$28.00 EA

Gasket



3683383A 47-54
Battery inspection cover.
(16.547-30) \$7.75 EA

Screw Set



3693869B 39-46
Floor and Toeboard.
21 pieces. (16.544-15)
\$9.00 SET

Bolt Set



187694B 41-46
For floor board (21
pcs). (16.542-15)
\$5.00 SET

Screws



3652879 47-54
For transmission
cover in floorboard.
(12.559-40) \$4.00 SET

Returns require a return authorization number, Please call.

Section 320T: Floorboard Parts, Seals, Sound Deadeners, Mats & Pedals



Format = Part No., Year, Description, Original Chevrolet Parts Book Group No., Price and Unit of Measure.

Gasket



3697605 47-54
For transmission
cover in floorboard.
(16.547-20) \$5.00 SET

Floorshift Seal



3653420 37-47
Floor to transmission
3-speed. (4.015-15) . . .
\$18.75 EA



3687200 37-54
Floor to transmission
4-speed. (4.015-20) . .
\$5.00 EA

Floor Shift Boot



3651348A All
Replacement-3 speed
(uses #3654365t trim
ring). (4.015-40)
\$9.25 EA

Trim Ring



3654365T All
Stainless retains boot
#3651348A. (4.044-15)
\$12.25 EA

Hand Brake Seal



3653418 40-54
Sponge (under floor).
(4.612-20) . . \$6.00 EA

Seal & Bumper

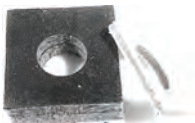

3694124A 48-54
Emergency pedal
brake shaft. (4.612-20)
\$5.00 SET

Emergency Pedal Boot



3694124 48-54
Under floor. (4.612-15)
\$7.00 EA



3694125 48-54
Metal retainer.
(4.615-15) . . \$6.75 EA



594988A All
Floor hand brake
(not original) uses
trim plate #595026
(4.612-40) . \$10.50 EA

Trim Plate



595026 All
Stainless-retains boot
#594988a (4.613-15) .
\$8.25 EA

Starter Pedal



3654134 38-54
Foot starter rubber
button. 2" dia., 1-1/4"
total height. (2.004-30)
\$9.50 EA



397577 29-54
Foot starter rubber
cap/ button (black).
1/2" height, 2-1/16"
dia. (2.004-15)
\$12.50 EA



3716711 38-54
Rubber bellows.
(2.014-15) . . \$7.00 EA



3654152 37-54
Return spring.
(2.029-20) \$5.50 EA

Pedal Pad

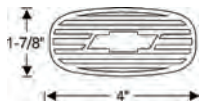

364022 29-46
Brake & clutch with
bowtie. (4.63-0)
\$28.00 PR



3683490 47-59
Brake, clutch &
emergency. (4.63-30) . . .
\$6.25 EA

Bumper

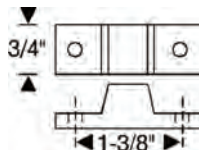

3681065 37-46
Clutch pedal (under
floor). (9.108-15)
\$12.00 EA



3653388 47-54
Brake & clutch arms to
floor (2 pcs). (9.108-40)
\$7.25 SET

Brake Pedal Return Spring



368244 32-46
(4.827-15) . . \$6.50 EA



368244 32-46
(4.827-15) . . \$6.50 EA



3698665 47-57
Overall length 5-3/4in.
(4.827-20) . . \$5.75 EA

Bushings



3682074 37-46
Clutch & brake pedal
shaft (13/16in. o.d. x
3/4in. i.d. x 1-25/64in.
l) (4.626-15) \$25.00 PR



3683016 47-54
Clutch & Brake Pedal
Shaft (1-1/16in. O.d. X
1in. I.d. X 1-1/4in. L)
(0.831-15) . \$21.00 PR

Seal



3657153 41-46
Floor felt for steering
column, brake &
clutch. (0.829-15)
\$8.50 EA



594337 47-51
Floor felt brake &
clutch pedal (2 pcs).
(0.829-15) . \$4.00 SET

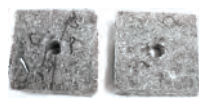

594337A 52-54
Floor felt brake &
clutch pedal (2 pcs).
(0.829-15) . \$4.00 SET

Gas Pedal



3653533 37-40
2-1/4in. x 7-3/4in.
(3.451-15) . \$21.00 EA

320T

Providing part numbers speeds up your order, improves accuracy and helps us maintain low prices.

See Illustration Index for core charge information and a list of abbreviations. For Body Model information, see Section 5T.



Section 320T: Floorboard Parts, Seals, Sound Deadeners, Mats & Pedals

Format = Part No., Year, Description, Original Chevrolet Parts Book Group No., Price and Unit of Measure.



3681341A. . . . 42-46
2-5/8in. x 7-3/4in. w/
pad. (3.451-15)
\$19.00 EA



3682873. . . . 46-52
2-7/8in. x 8-1/16in.
(3.451-15) . \$14.00 EA



3701621. . . . 53-57
2-7/8in. x 8-1/16in.
(3.451-15) . \$14.00 EA

Odds & Ends

Please call for availability on all Odds & Ends parts; once part is sold, it may no longer be in stock.

3659947U. 39-46
Brake & clutch pedal assembly used
(4.625-40). \$40.00 EA

3672713U. 42
Gas pedal. Fits all COMM & UTIL.
2-5/8in.X7-7/8in. (Used) (3.451-40) . . .
\$20.00 EA

597792 All
Starter pedal to starter link (2.033-0) . .
\$7.00 EA

Felt Body Deadener



121126A.
(original waffle
pattern)-used on
door skins, roofs, etc
(3/32in. x 3 ft x 8 ft).
(15.492-15) \$93.75 EA



121126B.
(original waffle
pattern)-used on door
skins, roofs, etc (1/8in.
x 3 ft x 8 ft). (15.492-15)
\$109.25 EA

Bushing



378431. 37
Gas pedal rod (in
floor). (3.469-40)
\$19.00 EA

Seal



3658395B. . . . 47-54
(felt) gas pedal rod in
floor. (3.469-20)
\$3.75 SET

Returns require a return authorization number, Please call.



Interior Kits for 37-54 Chevy Cars & Trucks from Chevs of the 40's

Antique Auto Upholstery

Tops & Top Assemblies

Carpets Fabrics Trims

Parts & Accessories

Panel Sets

**Attention to detail & correct materials.
Typical 60 day turn around.**

**Call or email us for a material sample
kit and quote**

330T



Section 330T: Interior, Sunvisors, Dome Lights, Headliners, Interior Screws, Door Panels, Kick Panels, Seats, Seat Covers & Belts
 Format = Part No., Year, Description, Original Chevrolet Parts Book Group No., Price and Unit of Measure.

**47-55
PRETRIMMED
PANELS**

THE PANELS AND PIECES BELOW ARE MODEL SPECIFIC, DESIGNED FOR YOUR TRUCK. FINISH THEM OFF BY COVERING THEM WITH STRETCHABLE TWEED, VINYL, ULTRALEATHER, ULTRASUEDE OR LEATHER AVAILABLE FROM RODDOORS. FIND MORE DETAILS ON MATERIALS ON THE FOLLOWING PAGES.

THE EUREKA



DESIGN: RON MANGUS
DOOR PANELS \$189/Pr
 RD-3080 W/ BUILT IN ARMREST

KICKPANELS \$69/Pr
 RD-3083

HEADLINERS \$169 Ea
 RD-3085 '47-'48 SPLIT WINDOW
 RD-3086 '49-'53 SPLIT WINDOW (SMOOTH)
 RD-3087 '54-'55 ROUND WINDOW (SMOOTH)

REAR CAB COVERS \$199 Ea
 RD-3090 '47-'48 NO TANK
 RD-3091 '49-'55 NO TANK

GAS TANK COVER \$199 Ea
 RD-3092



FITS OVER STOCK GAS TANK. BUILT IN PACKAGE TRAY AND ROOM TO MOUNT SPEAKERS

THE QUINN



DESIGN: RICH SANTANA WITH OPTIONAL ARM REST



WITH OPTIONAL DECO SHAPE
 RD-3242 W/O ARMREST \$189 Pr
 RD-3241 W/ ARMREST \$199 Pr
 RD-3240 W/ ARMREST & DECO SHAPES \$249 Pr
 RD-3099 DECO SHAPES \$59 Pr



YOU CAN SAY "I DID THAT!"

THEIR PANELS ARE DESIGNED FOR YOU TO COVER WITH YOUR OWN MATERIAL OR THEIRS OR YOU CAN TAKE THE PANELS TO YOUR LOCAL UPHOLSTERY SHOP AND SAVE A FEW BUCKS. BEST OF ALL, YOU DON'T HAVE TO TRANSPORT YOUR CAR.

PANELS ARE SHOWN WITH FABRIC FOR DISPLAY PURPOSES ONLY

TRIM TO FIT UNIVERSAL DOOR PANELS
 UNIVERSAL PANELS ARE \$189/ PR UNLESS NOTED

THE YOUNGSTER



DESIGN: DON'S HOT RODS
 RD-2532 30" DESIGN

THE HAYWARD



DESIGN: TAYLOR DESIGNS
 RD-2507 23" DESIGN
 RD-2508 30" DESIGN

THE COALINGA



DESIGN: TAYLOR DESIGNS
 RD-2504 23" DESIGN

THE PULVER



DESIGN: TODD EMMONS
 30" DESIGN
 RD-2524 W/ ARMREST \$199/Pr
 RD-2525 W/O ARMREST

THE ROGERS CREEK



DESIGN: TAYLOR DESIGNS
 RD-2528 30" DESIGN

THE LOMA PRIETA



DESIGN: TAYLOR DESIGNS
 RD-2516 23" DESIGN
 RD-2517 30" DESIGN

THE RIDGECREST



DESIGN: THOM TAYLOR
 RD-2527 23" DESIGN

THE CATALINA



DESIGN: RODDOORS
 RD-2503 30" DESIGN

ARMREST & MAP POCKET SOLD SEPARATELY

ALL UNIVERSAL PANELS ARE 44"W X 32"H

THE NEWPORT



DESIGN: THOM TAYLOR
 RD-2523 30" DESIGN \$199/Pr

THE FLAME II



DESIGN: RON MANGUS
 RD-2506

THE FLAME



DESIGN: RODDOORS
 RD-2505

THE CALAVARAS



DESIGN: TAYLOR DESIGNS
 RD-2502 30" DESIGN

**PRETRIMMED,
MODEL SPECIFIC**



THESE PANELS ARE MADE TO FIT A SPECIFIC MODEL TRUCK WITH NO TRIMMING.

THE OUTSIDE DIMENSIONS OF ALL UNIVERSAL PANELS ARE 44" WIDE X 32" HIGH. THE DESIGN MAY BLEED OFF ONE OR MORE SIDES AND CAN BE TRIMMED WITHOUT HARMING THE DESIGN. OR, AS SHOWN IN THE CHART ON THE RIGHT, DESIGNS MAY BE 23", 30" OR 36" WIDE. YOU CHOOSE THE DESIGN WIDTH THAT ALLOWS YOU TO TRIM THE OVERALL PANEL TO SIZE WITHOUT CUTTING INTO THE DESIGN. THE DIFFERENCE BETWEEN THE DESIGN WIDTH AND 44" IS THE SPACE THAT YOUR TRIM MUST FALL WITHIN TO PRESERVE THE DESIGN.

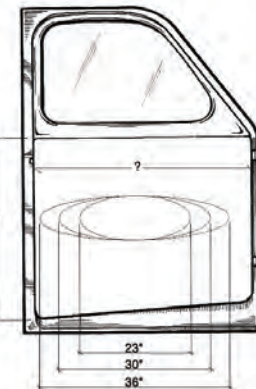

ADHESIVES

ABS GLUE

"DOPs Glue" Used to glue panels back together, attach carpet clips & upholstery tabs to panel backs and glue modular armrests into panels

RD-1005 \$6 Ea



SPRAY GLUE CHEESE

Use 2 cans for a truck, 4 cans for a sedan to glue fabric to panels, headliners and kicks. Adheres to wood, plastic or metal. NOT FOR SALE IN CALIFORNIA

RD-1007 \$18 Ea



Returns require a return authorization number, Please call.

Section 330T: Interior, Sunvisors, Dome Lights, Headliners, Interior Screws, Door Panels, Kick Panels, Seats, Seat Covers & Belts

Format = Part No., Year, Description, Original Chevrolet Parts Book Group No., Price and Unit of Measure.



DOOR PANELS COME IN TWO TYPES. PRETRIMMED-MODEL SPECIFIC AND UNIVERSAL. ALL PANELS ARE MADE OF .125 THICK ABS PLASTIC. THEY CAN BE GLUED, SCREWED, FOAMED, CARVED OR LAYERED. PLUS THEY ARE WATERPROOF. ABS GLUE IS USED TO PATCH OR FILL MISTAKES, MAKE CUSTOM TREATMENTS OR TO ADD MATERIAL WHERE IT'S NEEDED.

THESE PANELS COME BARE WITH THE DESIGNS MOLDED IN SO YOU CAN COVER WITH YOUR MATERIAL OR CHOOSE FROM OUR VAST SELECTION OF MATERIAL AVAILABLE. NO SEWING IS REQUIRED. FABRIC IS GLUED DOWN USING SPRAY ADHESIVE SPECIFIC TO THIS APPLICATION.

DOOR PANELS COME IN SETS OF 2, LEFT AND RIGHT. FOR 4-DOOR APPLICATIONS ORDER 2 SETS OF PANELS. SEVERAL PANEL STYLES CAN BE USED AS DOUBLE SETS FOR 4-DOORS. JUST REVERSE 2ND SET FOR A FLOW-THRU DESIGN.

THE MALIBU



DESIGN: THOM TAYLOR
RD-2520 23" DESIGN

THE HOLLYWOOD



DESIGN: RON MANGUS
RD-2512 W/O ARMREST

THE HOLLYWOOD AR



DESIGN: RON MANGUS
30" MIN DESIGN
RD-2511 W/ ARMREST

THE IMPERIAL



DESIGN: RODDOORS
RD-2513 23" DESIGN
RD-2514 30" DESIGN
RD-2515 36" DESIGN

ALL UNIVERSAL PANELS ARE 44"W X 32"H

SHAKE, RATTLE & ROLL 3/4



DESIGN: RON MANGUS
RD-2529 W/O ARMREST
REQUIRES TWO TONE FOR VINYL

SHAKE RATTLE & ROLL - FULL



DESIGN: RON MANGUS
RD-2531 30" DESIGN
REQUIRES TWO TONE FOR VINYL

SHAKE RATTLE & ROLL



DESIGN: RON MANGUS
30" MIN DESIGN
RD-2530 W/ ARMREST
REQUIRES TWO TONE FOR VINYL

THE RICHTER



DESIGN: RODDOORS
RD-2523 \$199/Pr

THE BOBECK



DESIGN: RICH SANTANA
RD2501 23" DESIGN

THE BOBECK AR



DESIGN: RICH SANTANA \$199/Pr
RD-2500 23" DESIGN

THE HEALEY FRONT & REAR

VERY COOL FLOW-THRU DESIGN.



RD-2510 REAR PANEL
RD-2509 FRONT PANEL
DESIGN: DENNIS PARKS

Dual Lock™ Tabs



3M™ DUAL LOCK™ RECLOSABLE TAPE IS USED TO FASTEN THE PANELS

NOT SURE ABOUT USING VELCRO AS A FASTENER FOR YOUR PANELS? WE WEREN'T EITHER UNTIL WE

HUNG A FULL SIZE PANEL ON OUR SHOWROOM WALL ONLY USING 3 OF THE PROVIDED DUAL LOCK MOUNTING TABS AND THEN ASKED OUR SALES STAFF TO PULL THE PANEL OFF. LET'S JUST SAY WE'RE CONVINCED THESE PANELS ARE STAYING ON YOUR DOOR. NO NEED TO DRILL ADDITIONAL HOLES IN YOUR DOOR, NO METAL CLIPS TO BREAK OR RUST, NO PLASTIC PINS THAT'LL BREAK OFF WHEN YOU DON'T PULL THE PANEL OFF JUST RIGHT AND NO MULTITUDE OF SCREWS THAT'LL WEAR DOWN THE BATTERY OF YOUR WIRELESS SCREW GUN BEFORE YOU GET TO THE LAST ONE.

DUAL LOCK FASTENERS \$22 Pkg
Package of 30 pcs for 2 doors RD-1004



PRODUCTS ARE SHOWN WITH FABRIC FOR DISPLAY PURPOSES ONLY

MODULAR ARMRESTS \$49 Pr

Can be used with any type of door paneling (cardboard or plywood). Each armrest has an integral mounting flange. Simply cut a hole in the panel the shape of the armrest, use glue or pop rivets to attach the flange. Armrest can be upholstered separately or after installation on door panel. Armrests are hollow to accommodate door pull kits.

NOTE: number next to armrest equals length in inches

THE ANAHEIM RD-1500	16"	THE BANANA RD-1501	18"	THE JALAPENO RD-1506	13-1/2"
THE CEYENNE RD-1502	19"	THE HUNGARIAN RD-1503	16-1/2"	THE HABENERO RD-1504	16-1/2"
THE FRESNO RD-1503	19-1/2"	THE SANTA FE RD-1509	16-1/2"	THE PIMENTO RD-1508	18"
THE YOLO RD-1512	19"	THE THAI RD-1511	15"	THE SERRANO RD-1510	16-1/2"
		THE PERON RD-1507	13"		

DOOR PULLS



FITS ANY DOOR PANEL WITH ARMRESTS. 2 STYLES TO CHOOSE FROM. INCLUDES PULLS, SCREWS AND BRACKETS FOR TWO DOORS.

SMALL (4" X 1.25" X .56" DEEP)
RD-1002 \$25 Kit
LARGE (5.25" X 1.94" X .81" DEEP)
RD-1010 \$25 Kit

SEDAN STYLE ARMRESTS

DESIGNED SPECIFICALLY FOR GM CARS, EACH MODEL OVERSIZED TO FIT THE VARIOUS TRIM SIZES
\$89 Set

1935-36 & 1939-41
RD-1550 W/ ASHTRAY STEP
RD-1551 W/O ASHTRAY STEP



ARMREST ONLY
QUARTER PANEL
FLAT STOCK KIT
NOT INCLUDED

1937
RD-1552



ARMREST ONLY
QUARTER PANEL
FLAT STOCK KIT
NOT INCLUDED

1938-48
RD-1554 W/ ASHTRAY STEP
RD-1553 W/O ASHTRAY STEP



ARMREST ONLY
QUARTER PANEL
FLAT STOCK KIT
NOT INCLUDED

RodDoors

DON'T HAVE YOUR OWN MATERIAL? MATERIAL AVAILABLE

ROD DOORS OFFERS A WIDE VARIETY OF MATERIALS TO COVER YOUR PANELS, SEATS AND HEADLINER. CARPET KITS ALSO AVAILABLE.

Providing part numbers speeds up your order, improves accuracy and helps us maintain low prices.

See Illustration Index for core charge information and a list of abbreviations. For Body Model information, see Section 5T.



Section 330T: Interior, Sunvisors, Dome Lights, Headliners, Interior Screws, Door Panels, Kick Panels, Seats, Seat Covers & Belts

Format = Part No., Year, Description, Original Chevrolet Parts Book Group No., Price and Unit of Measure.

Neoprene Gasketing Foam



VB-5
(8.8-15) . \$25.00 KIT

Sound -Vibration Damping

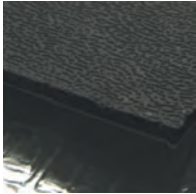

VB-2HDSP All
HEAVY DUTY
individual sheets.
Thickness=.075".
(8.8-15) . \$225.00 KIT



V-MAXAPP
(8.8-0) \$7.50 EA

Headliner -Molded ABS Plastic

These are ABS Plastic with a medium embossed leather grain texture. This material is easily formed with heat and duplicates the original look and texture exactly. ABS plastic is very tough, yet flexible, and does not show scratches or scuffs. It can be easily dyed with a flat vinyl plastic spray paint.

All of our patterns are based on out-of-vehicle originals. With few exceptions, truck headliners were black or brown when they came from the factory during the early years. ABS plastic can be easily dyed with a flat, vinyl plastic spray paint. The panels also can be covered with cloth or acoustic material.



593125P 37-38
Fits trucks (exc. Suburban).
(16.742-15) \$193.00 EA
3654634P 39-46
Fits trucks (exc. Suburban). (16.742-15)
\$180.00 EA
3676357P 47-53
Fits trucks (exc. Suburban). (16.742-15)
\$193.00 EA

3700527P 54
Fits trucks (exc. Suburban). (16.742-15)
\$193.00 EA

Headliner -Molded Fiberglass



3654634E 37-38
1 piece. (16.742-15) \$145.00 EA
3654634F 39-46
1 piece.
(16.742-15) \$145.00 EA
3676537F 47-53
1 piece.
(16.742-15) \$160.00 EA
3700527F 54
1 piece.
(16.742-15) \$173.75 EA

Note: Oversize shipping charges apply. Please call for rates.

Headliner Extension

467795 37-38
Molded fiberglass, back of headliner
around back glass to seat back.
(17.274-15) \$80.00 EA

Sound -Vibration Damping



VB-2 All
Individual sheet.
Thickness=.042".
(8.8-15) . . . \$63.50 EA



VB-2HD All
HEAVY DUTY
individual sheets.
Thickness=.075".
(8.8-15) . . . \$84.50 EA

Note: Oversize shipping charges apply. Please call for rates.

Headliner Conversion

3808406C 37-54
Napped Cotton Headliner conversion
kit for Panel trucks and Suburbans.
Any remnants of original headliner
must be discarded. Conversion
headliner is bow suspended much like
vintage passenger cars. Hardware is
included with kit. Bows are fitted to
roof by installer (drilling over doors
is required). 12 yards of tack strip
and hidem is included to finish the
perimeter. Professional Installation is
recommended.

Specify color: taupe, dark taupe,
maroon, beige, grey, ivory, light green,
dark green, aqua, red, medium blue or
black. (16.742-0) \$236.75 EA

Header Panel



593369 36-38
Mounts above windshield (fiberglass).
(16.562-15) \$86.50 EA
598772 39-46
Mounts above windshield (fiberglass).
(16.563-15) \$93.75 EA

Seat Belts



SBELTA
Aircraft style, chrome
buckle lap belt. Choose color: Black,
Dark Blue, Brown, Grey, Maroon, Red
Wine, Red or Tan (hardware kit sold
separately). (14.875-0) . . . \$22.00 EA



2002
2-point retractable lap
only belts available in
black, burgundy, Grey
or tan (specify color when ordering).
Comes with standard pushbutton
release. (14.875-30) \$57.75 EA



1001
Lap belts available in
black, burgundy, Grey
or tan (specify color when ordering).
Comes with standard pushbutton
release. (14.875-20) \$21.00 EA

Returns require a return authorization number, Please call.

Section 330T: Interior, Sunvisors, Dome Lights, Headliners, Interior Screws, Door Panels, Kick Panels, Seats, Seat Covers & Belts
Format = Part No., Year, Description, Original Chevrolet Parts Book Group No., Price and Unit of Measure.



Seat Belt Anchor Kit

 SBHP
 Deluxe reinforcing plates. Reduces chance of floor damage on high belt loads. Kit for 1 belt. (14.875-15) \$15.00 SET

 SBHPA
 Angled mounts for flat floor applications. Use with part #SBHP to complete your seat belt installation. Kit for 1 belt. (14.875-15) \$15.00 SET

 13245
 Hardware kit for one complete seat belt. Includes 2 of each: bolts, washers, lock washers and nuts. (14.875-20) \$4.00 SET

Sunvisor -Exterior

 986877F 47-53
 Aluminum, Fulton repro w/ mounting hardware & instructions. (37-52 car). Adjustable. (10.201-15) .. \$500.00 EA

 986877FSD 47-53
 Metal, Fulton reproduction with mounting hardware & instructions. Adjustable. (10.201-15) .. \$500.00 EA

 986877 47-53
 Accessory. Exterior Sunvisor. (10.201-15) \$275.00 EA



986878S 54-55
 Steel reproduction with mounting hardware & instructions. Fits Chevy & GMC. (10.201-15) \$500.00 EA

Sunvisor Assembly



3685637 47-53
 Left side interior visor with bracket, screws & template. Choose color: Black, Brown or Grey. (16.07-0) \$45.00 EA
 986155 47-53
 Right side interior visor with bracket, screws & template. Choose color: Black, Brown or Grey. (16.07-0) \$45.00 EA

Sunvisor

3703645 54
 Interior visor with bracket, screws & template. Left side, black, brown & Grey (specify color). (16.07-0) \$45.00 EA
 986773 54
 Interior visor with bracket, screws & template. Right side, black, brown & Grey (specify color). (16.07-0) \$45.00 EA



3685637B 47-59
 Interior visor. Brown. (16.07-15) \$30.00 EA

3685637C 47-59
 Interior visor. Black. (16.07-15) \$30.00 EA
 3685637D 47-59
 Interior visor. Grey. (16.07-15) \$30.00 EA



3685637L 47-53
 Interior visor support bracket. Left side with screws & template. (16.07-15) \$24.50 EA

986155R 47-53
 Interior visor support bracket. Right side with screws & template. (16.07-15) \$24.50 EA
 3685637EB 47-59
 Board only for interior visor. Fits Chevy & GMC. Fits left or right. (16.07-15) \$15.00 EA

3703645L 54
 Interior visor support. Left side with screws & template. (16.07-15) \$20.50 EA
 986773R 54
 Interior visor support. Right with screws & template. (16.07-15) \$20.50 EA

Dome Light Lens



4073975 37-46
 With round rim. Fits panel & Suburban. (16.494-15) \$29.00 EA

Dome Light Assembly



5937080 47-54
 Original finish with lens, bulb & fasteners (6 or 12 volt). (16.494-15) \$55.00 EA



5937080C 47-54
 Chrome with lens, bulb & fasteners (6 or 12 volt). (16.494-15) \$50.00 EA

330T

Providing part numbers speeds up your order, improves accuracy and helps us maintain low prices.

See Illustration Index for core charge information and a list of abbreviations. For Body Model information, see Section 5T.



Section 330T: Interior, Sunvisors, Dome Lights, Headliners, Interior Screws, Door Panels, Kick Panels, Seats, Seat Covers & Belts

Format = Part No., Year, Description, Original Chevrolet Parts Book Group No., Price and Unit of Measure.

Gasket -Dome Light Lens



5937080A . . . 47-54
Dome light lens.
(16.494-20) . \$1.50 EA

Headliner -Die Cut



593125 37-38
1-piece. Choose Black, Brown or
Grey. (16.742-15) \$44.00 EA
593125A 37-38
1pc Black. (16.742-15) \$44.00 EA



3801123 39-41
1-piece. Choose Black, Brown or
Grey. (16.742-40) \$44.00 EA



3654634 42-46
2-piece. Choose Black, Brown or
Grey. (16.742-15) \$30.00 SET



3694283 47-49
Black, Brown or Grey
(specify color when ordering).
(16.742-20) \$35.00 SET



3676357 50-53
2-piece. Choose Black, Brown or
Grey. (16.742-15) \$30.00 SET
3700527 54
2-piece. Choose Black, Brown or
Grey. (16.742-15) \$30.00 SET

Headliner Bow

3807558 50-54
Center (52in. long). (16.745-0)
\$25.00 EA

Headliner Washers



3654636 34-41
Rubber. Perfect repro.
(16.747-15) \$3.75 SET

J-Nut Retainer



. 37-46
er (5 pcs). (16.742-40).

Screw Set



477366 41-46
Headliner 8 x 32 x
5/16in. clutch head (22
pcs). (16.742-20)
\$9.50 SET



3654597B. . . . 47-54
Headliner. (16.29-30) .
\$5.00 SET



3694284B. . . . 47-54
Headliner, door panel,
window & windshield
garnish mouldings.
(16.29-30) \$14.25 KIT



3684481A. . . . 47-54
Windshield garnish
moulding (14 pcs).
(16.29-40) . \$3.75 SET



3684481B. . . . 47-54
Window garnish
mouldings, 2 doors.
(16.29-30). \$5.50 SET



3684161A 47-53
Door panel, cardboard,
does both doors (12
pcs). (16.29-40)
\$4.00 SET

Interior Screws



3654597C. . . . 37-50
8 x 32 x 1/2in. clutch
head (10 pcs).
(16.17-15) . \$3.25 SET



3654597A. . . . 37-50
8 x 32 x 1/2in. clutch
head (100 pcs).
(16.17-15) \$21.50 SET

Clutch Head Driver



DRIVER. All
Magnetic driver w/ 5 bits (1/8in.,
5/32in., 3/16in., 1/4in., 5/16in.) with
Chevs imprint. (8.821-15) \$22.25 SET

Windshield Divider Moulding



3684697S 47-53
Interior. Stainless windshield division
trim. (16.018-15) \$54.50 EA



3684697B 47-53
Painted with upper & lower caps &
fasteners. (16.018-15) . . . \$16.00 SET

Returns require a return authorization number, Please call.



Door Panels -Cardboard



3700543A 47-54
 Original leather grain Black, Brown or Maroon. Specify color when ordering. (16.165-40) \$16.50 L&R



3700543AB . . 47-54
 Original Leather Grain. Brown. (16.165-15) \$35.00 L&R

3700543 47-54
 Choose Black, Brown or Grey. Specify color when ordering. (16.165-0) \$15.00 L&R

Retainer Button



3707152 54
 Door panel cardboard, use 12. (16.165-40) \$1.00 EA

Kick Panels



474791 36-38
 Inner. Choose Black, Brown or Grey. Specify color when ordering. (16.7-20) \$16.00 L&R

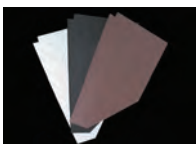

609526 39-46
 Inner. Choose Black, Brown or Grey. Specify color when ordering. (16.7-30) \$16.00 L&R



609527 47-54
 Inner. Choose Black, Brown or Grey (not original). Specify color when ordering. (16.7-20) \$16.00 L&R

Seat Bumpers



3681216 36-46
 (16.772-15) . \$3.75 PR

Seat Frame



367314B 47-54
 Rear bumper & screw set (4 pieces). (16.682-15) . \$7.50 PR

Grommet



\$2.50 EA

3695783 51-54
 (anti-rattle) seat adjust rod. (16.682-15)

Seat Cover



593345 37
 W/ split seat bottom (brown). (16.715-15) . . \$170.50 EA



593345A 37
 W/ split seat bottom (black). (16.715-15) . . \$170.50 EA

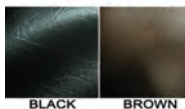

3808199 37-46
 Black (16.715-40) \$130.75 EA



3808200 47-49
 Matches repro door panels-black or brown(specify color when ordering). (16.715-0) \$150.00 EA

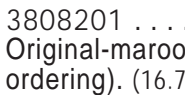

3808201 47-49
 Original-maroon (specify year when ordering). (16.715-15) . . . \$150.00 EA



3808205 50-54
 Original-black, brown or tan (specify color when ordering). (16.715-40) \$131.00 EA

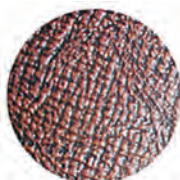

3808204 54
 Original (spanish grain brown). (16.715-15) . . \$174.25 EA

French Stitching Option

3808203 54
 For above GMC covers. Add this price to cost of seat cover above. Special order. (16.175-15) \$25.00 EA

Upholstery Batting

4092635B 37-54
 Cotton material placed in between upholstery and burlap. 24in. wide. (15.5-20) \$2.00 FT

Odds & Ends

Please call for availability on all Odds & Ends parts. Once part is sold, it may no longer be in stock.

4073975U 34-46
 Dome Light Lens (Used) (11.928-0) . . . \$15.00 EA

3684697U 47-53
 Moulding inside windshield division (Used) (16.018-0) \$150.00 EA

3806652U 39-46
 Seat bracket (Used) (16.68-0) \$10.00 SET

469853U 46
 Seat brackets (Used) (3.35-0) \$10.00 EA



Section 340T: Traffic Viewers, Dash Knobs, Cables & Cigarette Lighters

Format = Part No., Year, Description, Original Chevrolet Parts Book Group No., Price and Unit of Measure.

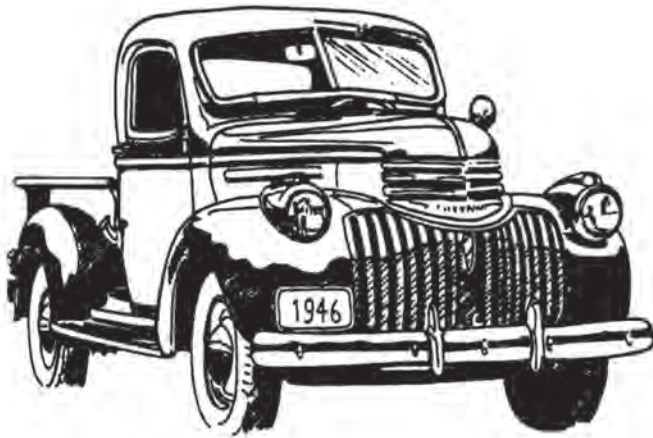

1936-9 Trk Choke, Throttle, Lights Black



3.521 3.481 2.486
1940-46 Trk Choke, Throttle, Lights Rose Tan

WINDOW RISER KNOBS

1939 Trk Window Knob
Black

1940-46 Trk Window
Rose Tan



16.270

1940-46 Trk Ash Tray Rose Tan



16.120



16.183

1947-53 Trk Vent Knob Maroon 1954 Trk Black



9.650

1954 Trk Windshield Wiper Black GMC Grey



2.906

1954-9 P.U. Turnsignal Knob Black

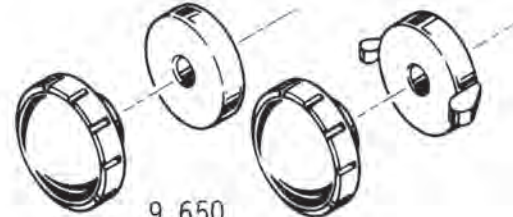

9.650

1954 Trk Radio Black GMC Grey

Radio Knobs—See Section 360T

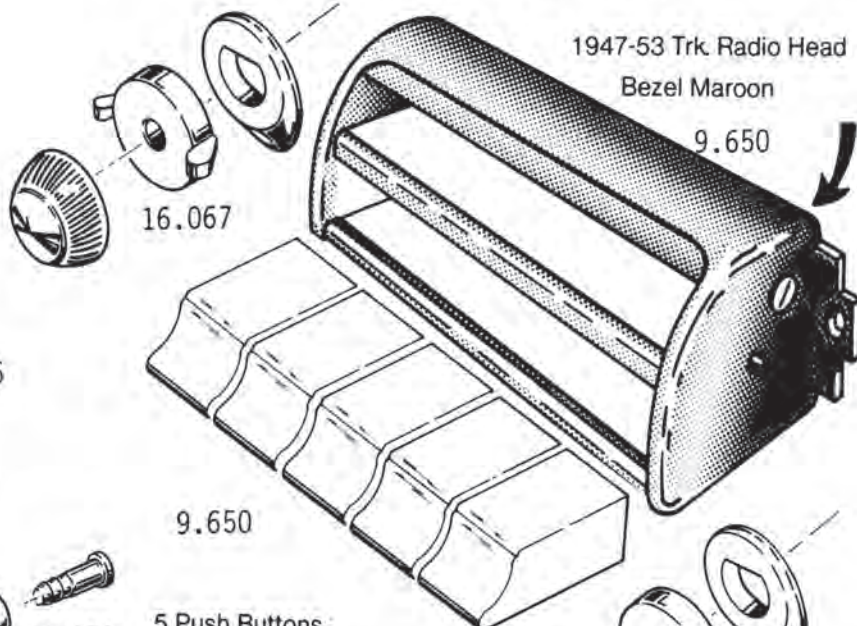

1947-53 Trk Radio Head
Bezel Maroon

9.650



5 Push Buttons

1947-53 Trk 4 Piece Set

9.650

1947-53 Trk Radio Escutcheon Maroon

Section 340T: Traffic Viewers, Dash Knobs, Cables & Cigarette Lighters



Format = Part No., Year, Description, Original Chevrolet Parts Book Group No., Price and Unit of Measure.

Traffic Light Viewer



986550 50-56
Superb reproduction.
(10.201-15) \$45.00 EA



986550G 50-56
"GUIDE". (10.201-30) .
\$35.00 EA

Steering Column Insulator



3657031 41-46
U-bolt with fasteners.
(6.765-15) . \$15.00 EA



3681057A 34-46
Steering column to dash, brown exc
COE. (6.758-15) \$13.50 EA



598145 34-46
Steering column to dash, black exc
COE. (6.758-15) \$1.75 EA



3685524 47-53
Steering column to dash, black exc
COE. (6.758-15) \$3.00 EA



3700190 54
Steering column to dash.
(6.758-20) \$3.00 EA

Cowl Vent Knob



985261 37-38
Ivory accessory
(original 38) (9.691-15)
\$16.75 EA

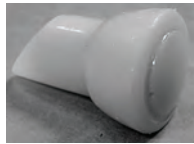

985603 40-46
Ivory accessory (9.691-
40) \$16.00 EA



3656663A 40-46
As original, brown.
(16.13-15) . . \$8.75 EA



3682916A 47-53
Side or top vent,
maroon. (16.13-15) . . .
\$9.00 EA



3131111 54
Black (16.13-15)
\$11.00 EA

Wiper Knob



3685141 47-49
Chrome (16.067-15) \$7.25 EA



3699117 50-53
Maroon (16.067-15) \$7.25 EA



3703853 54
Black (16.067-15)
\$9.00 EA

Emergency Brake Release



3690404 48-51
Handle (chrome).
(4.592-15) . \$13.50 EA



1990717 52-53
Knob (maroon).
(4.6-15) . . \$11.00 EA



1990717A 54
Knob (black). (4.6-15)
\$10.00 EA

Grommet-Emergency Brake Release



3696521 51-54
(9.775-15) . . \$1.75 EA

Knob-Window or Windshield



598910A 39
Window or windshield
crank. Black. (16.27-15)
\$11.00 EA



3654632B 40-46
Window or windshield
crank. Rose tan.
(16.27-15) . \$11.00 EA

Windshield Crank



598909 39
W/ black knob (16.05-15) . . \$37.50 EA



3654631A 40-46
W/ brown knob (16.05-15) . . \$37.50 EA

Providing part numbers speeds up your order, improves accuracy and helps us maintain low prices.

See Illustration Index for core charge information and a list of abbreviations. For Body Model information, see Section 5T.



Section 340T: Traffic Viewers, Dash Knobs, Cables & Cigarette Lighters

Format = Part No., Year, Description, Original Chevrolet Parts Book Group No., Price and Unit of Measure.



598986 37-38
Grommet, windshield
crank to dash.
(16.053-15) . \$3.00 EA

Turn Signal Knob



5939511A. 54-59
(2.906-15). \$11.00 EA

Headlight Knob



1861895. 36-39
Black (2.486-15).
\$9.00 EA

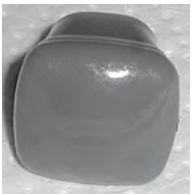

599352 40-46
Rose tan (2.486-15) . .
\$9.00 EA



1990661A. 47-53
(2.486-15). \$11.00 EA



1990661 47-53
With shaft (2.486-15) \$10.00 EA



1990734. 54
Exc forward control.
Black. (2.486-20)
\$9.00 EA



3653818K. 54
With shaft. Black.
(2.485-15) \$13.75 EA

Choke Knob



476495A. 36-39
Black (3.521-15).
\$11.00 EA



3657151A. 40-46
Rose tan (3.521-15) . .
\$11.00 EA



1992564A. 47-53
Chrome over maroon.
(3.521-15) . \$11.00 EA



199637A. 54
Exc Double Duty,
COE, FFC. Black.
(3.521-15) . \$11.00 EA

Choke Cable Assembly



476495 36-39
W/ knob (3.521-15) \$35.75 EA



3657151 40-46
W/ knob (3.521-15) \$39.50 EA



1992564 47-53
W/ knob (3.521-15) \$20.50 EA



199637 54
W/ knob-exc Double Duty, COE, FFC.
(3.521-15) \$20.00 EA

Throttle Knob



476751A. 36-39
Black (3.481-15).
\$9.00 EA



3654274A. 40-46
Rose tan (3.481-15) . .
\$11.00 EA



1991581A. 47-53
Chrome over maroon
(3.481-15) . \$11.00 EA



1992599A. 54
Black exc Double Duty,
COE, FFC. (3.481-15)
\$11.00 EA

Throttle Cable Assembly



476751 36-39
W/ knob (3.481-15) \$35.75 EA

Returns require a return authorization number, Please call.

Section 340T: Traffic Viewers, Dash Knobs, Cables & Cigarette Lighters

Format = Part No., Year, Description, Original Chevrolet Parts Book Group No., Price and Unit of Measure.



3654274 40-46
W/ knob (3.481-15) \$39.50 EA



1991581 47-53
W/ knob (3.481-15) \$20.50 EA



1992599 54
W/ knob exc Double Duty, COE, FFC.
(3.481-15) \$20.00 EA

Shift Knob



374993 29-47
3-speed floor shift
push-on. Black.
(4.009-15) . . \$7.75 EA



374993B 29-54
4-speed screw-on.
Black. (4.009-15)
\$7.50 EA

Column Shift Knob



3686898 47-53
Maroon. (4.009-15) . .
\$6.00 EA



3698233 54-59
Black (4.009-15).
\$8.00 EA

Wire Stop



3655561 All
Adjustable end for
hood, choke, throttle
cables, etc. (8.077-30)
\$1.00 EA

Ash Tray Knob



3658055 40-46
Rose tan (16.12-15) . .
\$12.00 EA



3685694 47-53
Chrome (16.122-15) . .
\$9.00 EA

Cigarette Lighter



986050J All
6v w/ socket & element, no knob.
(9.709-15) \$32.00 EA



986050L 47-53
6v w/ socket & knob maroon w/
chrome ring (original 51-53).
(9.709-15) \$23.50 EA



986050K 47-53
12v w/ socket & knob maroon
w/ chrome ring (original 51-53).
(9.709-15) \$23.50 EA



3707720A 54
6v w/ socket & knob.
(9.709-15) \$18.75 EA



3707720B 54
12v w/ socket & knob.
(9.709-15) \$18.75 EA

Lighter Element



986050A 42-53
6v, fits original Casco (NOS).
(9.709-40) \$20.00 EA

Odds & Ends

Please call for availability on all Odds & Ends parts. Once part is sold, it may no longer be in stock.

375743U 41-46
Choke and throttle bracket (Used)
(3.521-0) \$15.00 EA

3847003U 41-46
Firewall grommet bracket (Used) (3-40)
\$10.00 EA

Providing part numbers speeds up your order, improves accuracy and helps us maintain low prices.

See Illustration Index for core charge information and a list of abbreviations. For Body Model information, see Section 5T.



Section 345T: Tissue Dispenser, Mirrors & Mirror Arms

Format = Part No., Year, Description, Original Chevrolet Parts Book Group No., Price and Unit of Measure.

Tissue Dispenser



986672 53-55
Superb repro, w/ bowtie.
(8.891-15) \$94.50 EA



TISSUE. All
Box of tissue for tissue dispenser. 100
sheets. (-30) \$5.00 EA

Mirror -Rear View (Day/ Night)



985994 37-50
Original 42-50 accessory.
(10.185-15) \$60.00 EA



986632 51-52
Original accessory.
(10.185-15) \$75.00 EA



986948 53-59
Original accessory.
(10.185-15) \$63.00 EA



516506 41-52
Chrome (exc. CBL, CVT, HTP
& SDL). Dims: 6-3/4" x 2-1/2".
(10.185-15) \$32.00 EA

Mirror -Rear View



4584708 53-59
Stainless (10.185-15) \$24.00 EA

Mirror Bracket-Interior



986875 47-53
(16.069-15) \$10.00 EA



986875A. 47-53
Stainless (16.069-15) .
\$7.00 EA



986898 54
(16.069-15) \$17.50 EA



986898A. 54
Chrome (16.069-15) ..
\$20.00 EA

Mirror-Peep



985231A
Original era. 3in. round. Fits left or
right. (10.185-15) \$20.50 EA



985231B
Original era. 4in. round. Fits left or
right. (10.185-20) \$22.50 EA



985235A 37-54
Original 40-50, less GM script, left.
(10.185-20) \$22.50 EA

Mirror Head



3696632 31-54
Exterior. 5" (as original). Fits left or
right side. (16.068-30) \$14.25 EA



3696632B 31-54
Exterior. 5" (chrome). Fits Left or
Right. (16.068-20) \$16.50 EA



3696632RB 47-72
Exterior, rectangular (black). Fits Left
or Right. (16.068-20) \$16.00 EA

Returns require a return authorization number, Please call.

Section 345T: Tissue Dispenser, Mirrors & Mirror Arms

Format = Part No., Year, Description, Original Chevrolet Parts Book Group No., Price and Unit of Measure.



3696632R 47-72
Exterior, rectangular (stainless).
Fits left or right side.
(16.068-15) \$16.00 EA

Mirror Arm -Exterior



592145 36-38
Left (16.069-0)
\$22.50 EA



592146 36-38
Right (16.069-15)
\$22.50 EA



599013L 39-46
Left (16.069-0)
\$25.00 EA



599014R 39-46
Right (16.069-0)
\$25.00 EA



3684883 47-50
Left (16.068-15) \$15.00 EA



3696059 47-54
Left, original 51-54.
(16.068-15) \$19.00 EA



3696059C 47-54
Left, chrome, original 51-54.
(16.068-15) \$30.00 EA



3695368 47-54
Right (16.068-15) \$19.00 EA



3695368C 47-54
Right, chrome (16.068-20) . \$43.50 EA

Screws -Mirror Arm



604714A 47-54
Mirror arm, outside,
stainless steel (2 pcs).
(16.069-20) . \$2.50 SET

Gasket -Mirror Arm



597606 47-54
Mirror arm to cowl,
outside. (16.069-15) . .
\$1.00 EA

Pad -Mirror Arm



597606A 47-54
Mirror arm (rubber w/
beaded edge). (16.069-
40) \$2.50 EA

Odds & Ends

Please call for availability on all Odds & Ends parts. Once part is sold, it may no longer be in stock.

9852364U All
4in. peep Mirror. GM Script (29-0) . . .
\$40.00 EA

3696059U 47-54
Exterior mirror arm. Left, original for
51-54. Need screw & gasket (Used).
(16.068-40) \$15.00 EA

15481 37-54
Mirror w/ arm (not original) (29^000-0).
\$6.00 EA

985231U All
Peep Mirror- 3in. round head (Used)
(29-0) \$10.00 EA

516505U All
Rear view mirror. Painted back (Used).
(10.185-40) \$40.00 EA

985268N 37-48
Vanity Mirror- (NOS) (Unlit) (29-0) . . .
\$75.00 EA

Providing part numbers speeds up your order, improves accuracy and helps us maintain low prices.

See Illustration Index for core charge information and a list of abbreviations. For Body Model information, see Section 5T.



Section 350T: Gauges, Dash Panels, Instrument Glass, Dash Parts, Glove Boxes & Voltage Reducers
 Format = Part No., Year, Description, Original Chevrolet Parts Book Group No., Price and Unit of Measure.

Chevs of the 40's is proud to offer quality gauges from Classic Instruments American made, assembled by hand and used by today's top car builders

Classic Instruments Gauges
SPEEDTACH-ULAR



TWO GAUGES IN ONE!!

\$633.00

Hot Rod Series White Hot Series Vintage Series Silver Series

SpeedTachUlar™ 5" combo gauges shown above, also available with matching auxiliary gauge sets

**Now available in 3-3/8"!!
 Ultimate Speedometer**



Available in same colors/ styles as Ultimate SpeedTachUlar™ (above)
 Sold individually or Quad gauges

\$349.00

\$612.00

3-3/8" Speedo/ Tach 3-3/8" Speedo/ Tach & 3-3/8" Quad

Series Available:

- * All American - 3 styles; Silver, Nickel & Tradition (black)
- * Vintage (tan face) * Silver
- * Hot Rod (black face) * Classic White * White Hot



\$675.00

All American Nickel Series above



\$522.00

All American Series shown above
 3-3/8" Speedo & 3-3/8" Quad



\$486.00

Hot Rod Series shown above
 5 gauge set - 3-3/8" Speedo
 2-1/8" Fuel, Temp, Volts & Oil



\$127.00

Hot Rod Series Tach shown above
 3-3/8"



Classic White Speedo w/ low step bezel above



Classic White Quad w/ radial bezel above



\$560.00

All American Series shown above
 5 gauge set - 3-3/8" Speedo
 2-1/8" Fuel, Temp, Volts & Oil

Billet Aluminum Dash Panels

Land your new gauges in one of our billet aluminum dash panels. These panels will house Classic Instrument gauges listed above and other gauge brands including some stock gauges



\$170.00

#ALUMDASH-47-53
 47-53 Truck 5-hole shown above
 Speedo 3-3/8" & Quad 2-1/8"



\$150.00

ALUMDASHQ-40-46
 40-46 Truck 2-hole shown above



\$150.00

ALUMDASH-40-46
 40-46 Truck 5-hole shown above

Highly Polished, Precision CNC machined gauge panels from 6061 T6 Billet Aluminum
 Some stock, Classic Instruments and Dolphin gauges will fit (instrument bezels-not included)



\$130.00

ALUMDASH5-47-53
 47-53 Truck 5" shown above



\$130.00

ALUMDASHQ-54
 54 Truck 3-3/8" shown above
 (gauges not included)

*Visit our web site or call for additional applications & styles.

Returns require a return authorization number, Please call.



Gauge Cluster (V8)



1500924C4_47-49 47-49
 New set. 12 volt, V-8, Oil (0-60lbs),
 Temp (100-212 deg). Red needles.
 (9.748-15) \$375.00 EA



1500924C12V_47-49 47-49
 New set. 12 volt, 8 cylinder. Oil
 (0-60lbs), Temp (0-220 deg). Red
 needles. (9.748-15) \$375.00 EA



1500924C4_50-53 50-53
 New set. 12 volt, V-8, Oil (0-60lbs),
 Temp (0-212 deg). White needles.
 (9.748-15) \$350.00 EA



1500924C12V_50-53 50-53
 New set. 12 volt, 8 cylinder. Oil
 (0-60lbs), Temp (0-220 deg). White
 needles. (9.748-15) \$375.00 EA



1582460C3 54-55
 New set. 12 volt, 8-cylinder.
 (9.748-15) \$350.00 EA



1500924GC5_47-1 47-51
 GMC, New set. 12 volt, V8. Oil (0-
 60lbs), Temp (100-220 deg). Red
 needles. (9.748-15) \$375.00 EA

858983R8 36-39
 Rebuilt fits V8 (\$150 core).
 (9.748-0) \$425.00 EA

1564308R8 40-46
 Rebuilt fits V8 (\$50 core).
 (9.748-0) \$450.00 EA

1500924R8 47-54
 Rebuilt fits V8 (\$100 core).
 (9.748-15) \$425.00 EA

1119004A
 12v conversion. 1
 per gauge Hi-Tech w/
 voltage not constant. (2.5-15) \$4.00 EA

1119004
 12v conversion. Best
 for fuel gauge. Hi-
 Tech w/ constant volts.
 (2.5-15) \$18.50 EA

1119005
 12v to 6v voltage
 reducer to operate
 heater, radio &
 gauges. Hi-tech,
 delivers constant volts. Superior
 quality. (2.5-15) \$72.00 EA

1119005C
 12v to 6v voltage
 reducer to operate
 heater. (2.5-15)
 \$18.25 EA

Voltage Booster



1119007
 6v to 12v high current booster (3.7-
 5.0 amps) great for: radar detectors,
 CB radios, mobile phones, modern
 stereo radios w/ CD & tape and
 alarm systems (control only).
 (2.5-15) \$100.00 EA

Instrument Glass



1565308A 40-46
 V8 markings w/ temp to 220
 degrees & oil pressure at 60 psi
 (Fits 1940 Car, and 1940-46 Truck).
 (9.748-20) \$29.75 EA

Dash Panel



3847353A 47-53
 Complete metal replacement.
 Superior!. (16.55-15) \$344.25 EA

Dash Paint see Section 15T.

Speedometer Assembly



1567794C 47-50
 0-80 MPH with odometer.
 Complete w/ backing, lens & bezel.
 (9.748-15) \$229.00 EA



1567795C 51-53
 0-90 MPH with odometer.
 Complete w/ backing, lens & bezel.
 (9.748-15) \$229.00 EA

350T



Section 350T: Gauges, Dash Panels, Instrument Glass, Dash Parts, Glove Boxes & Voltage Reducers

Format = Part No., Year, Description, Original Chevrolet Parts Book Group No., Price and Unit of Measure.



1582460C4_54-55 54-55
0-90 MPH with odometer.
Complete w/ backing, lens & bezel.
(9.748-15) \$229.00 EA



1567794GC 47-51
GMC, 0-80 MPH with odometer.
Complete w/ backing, lens & bezel.
(9.748-15) \$229.00 EA

Speedometer



1567794B 47-50
0-80 MPH with odometer.
(9.748-15) \$125.00 EA



1567795B 51-53
0-90 MPH with odometer.
(9.748-15) \$125.00 EA

Gauge Cluster

858983R6 36-39
Rebuilt fits 6 cylinder (\$150 core).
(9.748-15) \$425.00 EA

1564308R6 40-46
Rebuilt fits 6 cylinder (\$100 core).
(9.748-0) \$450.00 EA



1500924C3_47-49 47-49
New set. 6 volt, 6 cylinder. Oil (0-30lbs), Temp (100-212 deg). Red needles. (9.748-15) \$375.00 EA



1500924C6V_47-49 47-49
New set. 6 volt, 6 cylinder. Oil (0-30lbs), Temp (0-220 deg). Red needles. (9.748-15) \$375.00 EA



150924C5_47-49 47-49
New set. 12 volt, 6 cylinder. Oil (0-30lbs), Temp (100-212 deg). Red needles. (9.748-15) \$375.00 EA



150924C6_47-49 47-49
New set. 12 volt, 6 cylinder. Oil (0-30lbs), Temp (100-220 deg). Red needles. (9.748-15) \$375.00 EA



1500924C6V_50-53 50-53
New set. 6 volt, 6 cylinder. Oil (0-30lbs), Temp (0-220 deg). White needles. (9.748-15) \$350.00 EA
1500924R6 47-54
Rebuilt fits 6 cylinder (\$100 core).
(9.748-15) \$425.00 EA



1500924C3_50-53 50-53
New set. 6 volt, 6 cylinder. Oil (0-30lbs), Temp (100-212 deg). White needles. (9.748-15) \$350.00 EA



1500924C6_50-53 50-53
New set. 12 volt, 6 cylinder. Oil (0-30lbs), Temp (0-220 deg). White needles. (9.748-15) \$350.00 EA



1500924C5_50-53 50-53
New set. 12 volt, 6 cylinder. Oil (0-30lbs), Temp (0-212 deg). White needles. (9.748-15) \$350.00 EA



1582460C1_54-55 54-55
6 volt, 6-cylinder.
(9.748-15) \$350.00 EA



1582460C2 54-55
12 volt, 6-cylinder.
(9.748-15) \$350.00 EA

Returns require a return authorization number, Please call.

Section 350T: Gauges, Dash Panels, Instrument Glass, Dash Parts, Glove Boxes & Voltage Reducers
Format = Part No., Year, Description, Original Chevrolet Parts Book Group No., Price and Unit of Measure.



1500924GC1_47-1 47-51
 GMC, New set. 6 volt, 6 cylinder. Oil (0-60lbs), Temp (100-220 deg). Red needles. (9.748-15) \$375.00 EA



1500924GC2_47-1 47-51
 GMC, New set. 12 volt, 6 cylinder. Oil (0-60lbs), Temp (0-220 deg). Red needles. (9.748-15) \$375.00 EA

Gauge -Ammeter



1500928 . . . 47-48
 Ammeter. Red needle. Fits all Comm & Util. (2.515-15)..... \$55.00 EA



1501198 . . . 49-53
 Ammeter. White needle. Fits all Comm & Util. (2.515-15)..... \$55.00 EA

Gauge -Oil Pressure



1507088 . . . 47-48
 Oil pressure gauge. Red needle. Fits all Comm & Util. (1.803-15)..... \$55.00 EA



1504701 . . . 49-53
 Oil pressure gauge. White needle. Fits all Comm & Util. (1.803-15)..... \$55.00 EA

Gauge -Temp



1511898 . . . 47-48
 Temp gauge. Red needle, fits 6 CYL engine only, exc D/D & COE. (1.148-15)..... \$55.00 EA



1511898M . . 47-48
 Temp gauge. Red needle, fits 8 CYL engine only (increased line length), exc D/D & COE. (1.148-15) \$55.00 EA



1512701 . . . 49-53
 Temp gauge. White needle, fits 6 CYL engine only, exc D/D & COE. (1.148-15)..... \$66.00 EA



1512701M . . 49-53
 Temp gauge. White needle, fits 8 CYL engine only (increased line length), exc D/D & COE. (1.148-15) \$61.00 EA

Gauge -Fuel



1516973 . . . 47-48
 Fuel Gauge. 6 Volt. Red needle. Fits all Comm & Util. (3.108-15)..... \$55.00 EA



1516973M . . 47-48
 Fuel Gauge. 12 Volt. Red needle. Fits all Comm & Util. (3.108-15)..... \$55.00 EA



1517169 . . . 49-53
 Fuel Gauge. 6 Volt. White needle. Fits all Comm & Util. (3.108-15)..... \$55.00 EA



1517169M . . 49-53
 Fuel Gauge. 12 Volt. White needle. Fits all Comm & Util. (3.108-15)..... \$55.00 EA

Decal Radio Grille



306543 47-53
 Chevrolet radio grille. Black lettering. (18.55-15) \$3.50 EA

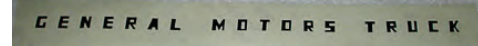

306543G 47-53
 GMC radio grille. (18.55-15) \$4.50 EA

Dash Moulding Speaker Grille



3684033 47-53
 Dash moulding assembly speaker grille w/ script & ashtray assembly (painted). (16.083-15) . . . \$110.00 EA



3684033G 47-53
 Dash moulding assembly speaker grille w/ script & ashtray assembly, GMC (painted). (16.083-15) \$110.00 EA

Clips -Moulding



3654550 40-46
 For moulding across dash (10 pcs). (12.118-40) \$6.25 SET

Instrument Glass



1565308 40-46
 With original markings (Fits 1940 Car, and 1940-46 Truck) (9.748-20) \$26.75 EA



1564308G 40-46
 With original markings (GMC). (9.748-15) \$17.00 EA

350T

Providing part numbers speeds up your order, improves accuracy and helps us maintain low prices.

See Illustration Index for core charge information and a list of abbreviations. For Body Model information, see Section 5T.



Section 350T: Gauges, Dash Panels, Instrument Glass, Dash Parts, Glove Boxes & Voltage Reducers
Format = Part No., Year, Description, Original Chevrolet Parts Book Group No., Price and Unit of Measure.

Decal Instrument Set



858983 36-39
 Instrument set w/ speedo & odometer
 (black center). (9.748-15) ..\$16.75 EA



1564308B 40-46
 Instrument cluster w/ speedo &
 odometer. (0.89444444-15) \$13.00 EA



1564308H 40-46
 Instrument cluster w/
 speedo & odometer (GMC).
 (9.748-15) \$12.75 EA



1500924B 47-50
 Instrument set w/ speedo & odometer.
 (9.748-15) \$10.25 SET



1500924G 47-53
 Instrument set w/ speedo & odometer
 (GMC). (9.746-15) \$10.25 SET



1500924C 51-53
 Instrument set w/ speedo & odometer.
 (9.748-15) \$10.25 SET



1582460C 54
 Instrument set w/ speedo & odometer.
 (9.748-15) \$10.25 EA



1582460G 54-59
 Instrument set w/ speedo & odometer
 (GMC). (9.748-15) \$15.00 EA

Bezel-Gauge Cluster



1565472 40-46
 Chrome (Chev & GMC).
 (9.746-0) \$35.00 EA

1565472B 40-46
 Brown w/ chrome (as original).
 (9.746-0) \$47.50 EA

1581526 47-53
 W/ speedo (Chev
 & GMC), chrome.
 (9.746-15) . \$12.00 EA



1582659 54-55
 Chrome. (9.746-0) . . .
 \$13.75 EA



1582659S 54-55
 Stainless. (9.746-0) ..
 \$15.50 EA

Gasket-Instrument



1565309 40-46
 Instrument glass to housing (Chev &
 GMC). (9.749-20) \$4.25 EA



1500925 47-54
 Speedometer Chev
 gauge glass to
 bezel(Chev & GMC).
 (9.749-30) . . \$3.50 PR

Speedometer Hand



1567794 47-50
 Super quality (also 52-
 53 GMC). (9.748-15) .
 \$9.00 EA

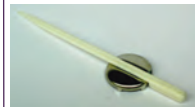

1567795 51-53
 Super! (9.748-15)
 \$7.75 EA

Speedometer Cable



1567793 37-57
 W/ original housing assembly exc
 1939-54. (4.342-20) \$34.50 EA

158829 39-54
 W/ original metal housing assembly. 70"
 length.
 (4.342-30) \$35.25 EA

1588291A 37-57
 Cable w/o housing. 85" length (0.130 dia.).
 (4.342-15) \$15.50 EA

Gauge Repair

1565912R All
 Speedometer gauge repair service.
 Parts extra (9.743-15) . . . \$150.00 EA

Returns require a return authorization number, Please call.

Section 350T: Gauges, Dash Panels, Instrument Glass, Dash Parts, Glove Boxes & Voltage Reducers
Format = Part No., Year, Description, Original Chevrolet Parts Book Group No., Price and Unit of Measure.



1511051R All
Temp gauge repair service. New
capillary tube & restoration. Parts extra
(1.148-15) \$250.00 EA

1500381R All
Electrical gauge repair service. Parts
extra (2.515-30) \$250.00 EA

*\$10 shipping & handling fee for
electrical gauge repair. Parts needed
for repair will be in addition to
servicing.*

Clock Quartz Conversion

609525R All
Convert your stock clock to quartz.
Rebuild service also to bring new life to
your clock (parts extra). (9.772-0) . . .
\$325.00 EA

*\$10 shipping & handling fee for
conversion.*

Bushing In Cylinder Head

 3837160 38-55
For temp gauge. 3/8"
I.D. (1.15-15) \$8.00 EA

Oil Pressure Line

 1399637B 37-54
Engine to gauge
(1.519-15) . . \$17.50 EA

Glove Box-Cloth Lined

 473524C 36-38
W/ clips (16.1-15) \$19.50 EA
598886C 39
W/ clips
(16.1-15) \$19.50 EA
3654001C 40-46
W/ clips
(16.1-15) \$19.50 EA

Glove Box-Like Original



473524 36-38
W/ clips (16.1-15) \$12.00 EA
598886 39
W/ clips
(16.1-20) \$12.75 EA
3654001 40-46
W/ clips
(16.1-20) \$14.25 EA
3676451 47-49
Without clips.
(16.1-20) \$14.25 EA
3704220 50-53
W/ clips
(16.1-20) \$14.25 EA
3701366 54
W/ clips
(16.1-20) \$14.25 EA
3701366G 54
W/ clips (GMC).
(16.1-30) \$15.75 EA

Screw Set

 431616 All
To install glove box
(10.261-40) \$1.75 SET

Glove Box Door

 3698751S 47-53
Stainless (unpainted).
(16.11-15) \$87.00 EA
 3698751 47-53
Stainless with painted details.
(16.11-15) \$87.00 EA

 3693927B 47-53
Hinges (16.115-15) . . .
\$28.75 L&R

Rubber Bumpers

 4072911B 37-39
Glove box door
(rectangle). (11.139-40)
\$4.50 SET

 3765243 40-54
Glove box door
(round). (10.263-40) . .
\$1.00 PR

Glove Box Light

 985772 37-54
w/ bulb (10.275-15) . .
\$11.00 EA

Striker

 3701376 54-59
Glove box latch.
(16.11-20) . . \$7.50 EA

Gasket

 4099314C 40-53
Glove box lock to door.
(16.11-40) . . \$3.75 EA
 4566764A 54
Glove box lock to door.
(16.11-20) . . \$1.75 EA

Glove Box Lock

 4099314 40-53
Assembly with key,
NOS. (16.11-15)
\$30.00 EA
 4566764B 54
Assembly with case &
key. (10.266-15)
\$30.75 EA

Providing part numbers speeds up your order, improves accuracy and helps us maintain low prices.

See Illustration Index for core charge information and a list of abbreviations. For Body Model information, see Section 5T.



Section 350T: Gauges, Dash Panels, Instrument Glass, Dash Parts, Glove Boxes & Voltage Reducers

Format = Part No., Year, Description, Original Chevrolet Parts Book Group No., Price and Unit of Measure.



4099314B40-53
Retainer for glove box
lock assembly. (16.11-15)
\$4.00 EA



459910654-59
Retainer for glove
box lock assembly.
(10.267-20) . . \$3.75 EA



4099314A.40-54
Repair Kit (hook &
pin). (16.11-30)
\$9.00 KIT

Key Blank



369462435-57
Original GM octagon
head. Fits ignition,
door & spare tire
locks. (2.187-30) \$1.75 EA



60127235-54
Original GM round
head. Fits trunk, glove
box & locking gas cap
(2.187-30) \$2.25 EA

Odds & Ends

Please call for availability on all Odds & Ends parts. Once part is sold, it may no longer be in stock.

150092847-48
Ammeter (COMM, Utility) (28*000-0) . .
\$50.00 EA
150147154
Ammeter NOS (28*000-40) . \$37.50 EA
150055840-46
Ammeter. Fits 40 Pass & 41-46 Truck
(NOS). (2.055-15) \$60.00 EA
1501198N49-53
Ammeter. Fits comm & utility 54-55
FFC (NOS) (28*000-0) \$50.00 EA
150099847-51
Amp gauge GMC (GMC-0) . \$45.00 EA
1333139-46
Block off plate for wiper motor. Right
side (NOS) (26<000-0) \$20.00 EA
01651212K All
Chrome knob (9.709-40) \$4.00 EA
1516973G47-53
Cluster gear bezel fits GMC has yellow
face (9.748-0) \$15.00 EA
368403747-53
Dash moulding below speaker
(16.081-0) \$30.00 EA
60335539
Dashboard, flat flaxe cowl, excellent
(26~000-0) \$125.00 EA
1374050
Glove Box Door w/ lock GMC (Used)
(26*000-0) \$25.00 EA
150092447-53
Instrument glass, used (9.748-40)
\$15.00 EA
150546736-39
Oil Gauge NOS (36 Pass, 37-39
COMM) (28~000-0) \$35.00 EA
151520736-39
Oil Gauge NOS (36 Pass, 37-9 COMM)
(28~000-0) \$35.00 EA
150740149-53
Oil gauge white needle (COMM, Utility)
(28*000-40) \$50.00 EA
150637340-46
Oil Gauge- 40 Pass, 41-46 Truck
(NOS) (28-0) \$50.00 EA
150824655-57
Oil Pressure Gauge (1.803-40)
\$50.00 EA

150637941-46
Oil Pressure Gauge GMC 0-80 PSI
NOS (28*000-40) \$65.00 EA
150708847-48
Oil Pressure Gauge Red Needle (NOS)
(28*000-40) \$50.00 EA
150796347-53
Oil Pressure Gauge, 60 lbs (28^000-0)
\$50.00 EA
156547340-46
Retainer - instrument face (9.747-40) .
\$15.00 EA
150609240-42
Shelf worn (1.803-40) \$45.00 EA
858983N34-39
Speedometer 34-36 Master, 39-39
Truck (9.743-0) \$125.00 EA
151196047-53
Temp gauge GMC (GMC-40)
\$100.00 EA
1511960U47-53
Temp gauge GMC. Needs new needle
(Used) (GMC-40) \$60.00 EA

Returns require a return authorization number, Please call.

Section 360T: Radios, Antenna & Related



Format = Part No., Year, Description, Original Chevrolet Parts Book Group No., Price and Unit of Measure.

Voltage Booster -Radio



RADIOCONV.2 All
12v booster for 6v radio
(9.65-15) . . . \$100.00 EA

Antenna



985996R All
2 post side cowl mount.
(9.645-15) \$30.00 EA



984995R All
Cowl or fender top replacement.
Adjustable base (swivels).
(9.645-20) \$21.00 EA



985531 39-46
W/ original side mount posts.
Superior! (9.645-20) \$140.00 EA



986069 47-54
W/ template. Superb Reproduction.
(9.645-15) \$75.00 EA

Antenna Eye Bolt



603797 39-46
Antenna upper eye
bolt for base takes 2
(1941 uses 1). (9.644-20) . . \$21.25 EA

Antenna Base



603795 39-46
Bakelite post base. 39-
40 takes 2, 41 takes
1. (9.644-30)
\$24.25 EA

Antenna Base & Nut



986069A 47-54
Base & nut. Fits
Bakelite. (9.645-15) . .
\$19.75 SET

Antenna Pad



605184 39-46
Rubber pad for
bakelite post (original
antenna). (9.645-15) .
\$9.25 PR



986069C 47-54
Rubber pad for
antenna base.
(9.645-15) . . \$4.50 EA

1937 Radio

985252A 37
Tube set, 6-tube single unit radio
#985252. (9.65-15) \$107.00 SET

1938 Radio

7232768 38
Radio knob, ivory.
(9.65-15) . . \$11.00 EA



1939 Radio

7236509 39
Radio knob, rose tan.
(9.65-15) . . \$11.00 EA



7232626 37-39
Radio dial lens, 2in.
diameter. (9.65-40) . .
\$20.00 EA

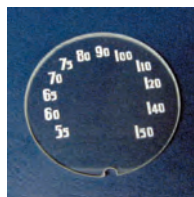

985286A 38-39
Tube set, 6-tube single unit radio #985286.
(9.65-20) \$170.00 SET

1940 Radio

7239043 40
Radio knob, ivory.
(9.65-15) . . \$11.00 EA



985538A 40
Tube set, 5-tube single unit radio #985538.
(9.65-15) \$90.00 SET

1941 Radio

604369 41
Radio knob, chrome
with swirl center.
(9.65-15) . . \$11.00 EA



1213876 40-41
Radio dial lens, 3-5/8in. x 7/8in.,
glass. (9.65-15) \$23.50 EA



7238833 40-41
Radio dial lens, 3-1/2in. x 1-1/4in.,
plastic. (9.65-15) \$22.00 EA

985651A 40-41
Tube set, 5-tube plug in portable radio
#985651.
(9.65-15) \$52.00 SET

985651A 40-41
Tube set, 5-tube plug in portable radio
#985651.
(9.65-15) \$52.00 SET

985696A 41
Tube set, 5-tube single unit radio #985696.
(9.65-15) \$120.00 SET

360T

Providing part numbers speeds up your order, improves accuracy and helps us maintain low prices.

See Illustration Index for core charge information and a list of abbreviations. For Body Model information, see Section 5T.



Section 360T: Radios, Antenna & Related

Format = Part No., Year, Description, Original Chevrolet Parts Book Group No., Price and Unit of Measure.

1942-1946 Radio



724224942-46
Radio knob, ivory w/
copper swirl center.
(9.65-15) . . \$10.00 EA

985792A42-46
Tube set, 5-tube single unit radio #985792.
(9.65-15) \$92.00 SET

1947-53 New Radio

Small size, big features! Original looking unit with current day audio technology. Fits stock dash radio opening without modifications. Shallow 3¼ inch case depth allows room for dash components such as electric wipers, air conditioning, etc. 4 x 45 watts RMS output, allows up to 180 watts of audio power. Original style AM dial scale in foreground with FM dial scale in background. Analog controls look and feel like the original radio. All audio controls are easily accessible: Volume, bass, treble, balance, fader and tuner from original looking controls. CD or XM (satellite) inputs included. LED dial lights which never need replacing. Digitally tuned AM/FM/Stereo front end provides stable, high quality reception with 10 station presets (5 AM, 5 FM). 40 year memory retention (presets, etc) with power disconnected. Inputs for CD.

Maximum power = 180 watts RMS (45 watts x 4 speakers).

Dimensions: 9in. W x 3.25in. H x 4.6in. D.

½" dia. shafts on controls for mounting (same size and thread as original shafts).



986444RG47-53
(9.65-15) \$550.00 EA



986444R47-53
(9.65-15) \$550.00 EA



986444S47-53
Optional speakers. Pair of 4in
x 6in mounted to new radio.
(9.65-15) \$130.00 SET



986771CG54
(9.65-15) \$500.00 EA

1947-1953 Radio



98626447-53
Radio knob, tan.
(9.65-15) . . . \$9.00 EA

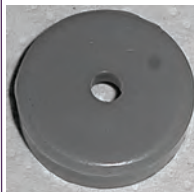

986264A47-53
Disk dummy (knob)
behind front radio
knob. (9.65-15)
\$9.00 EA



986264B47-53
Disk w/ lever (knob)
behind front radio
knob. (9.65-15)
\$9.00 EA



986444C47-53
Radio bezel, teardrop
behind knobs. (9.65-15)
\$11.00 EA



986444A47-53
Radio bezel gasket (2
pcs). (9.65-15) \$3.50 PR



725690247-50
Radio dial lens, molded plastic.
(9.65-15) \$55.00 EA



986444D47-53
Pushbuttons (5 pcs).
(9.65-20) \$29.50 SET



986694D47-53
Radio face housing, maroon.
(9.65-15) \$20.00 EA



368403347-53
Dash moulding assembly speaker
grille w/ script & ashtray assembly
(painted). (16.083-15) . . . \$110.00 EA

Returns require a return authorization number, Please call.

Section 360T: Radios, Antenna & Related

Format = Part No., Year, Description, Original Chevrolet Parts Book Group No., Price and Unit of Measure.



3684033G 47-53
Dash moulding assembly
speaker grille w/ script & ashtray
assembly, GMC (painted).
(16.083-15) \$110.00 EA



9864445 47-53
Rubber seal, radio speaker to dash.
(9.65-15) \$9.50 EA



986444F 47-53
Spacers, front of radio
to dash. Lower (2 pcs).
(9.65-15) . . . \$8.50 PR



986444E 47-53
Spacers, front of radio
to dash. Upper (2 pcs).
(9.65-15) . . . \$8.00 PR

986067A 47-50
Tube set, 6-tube single unit radio #986067.
(9.65-15) \$104.00 SET

986443A 51-53
Tube set, 6-tube single unit radio #986443.
(9.65-15) \$104.00 SET

1954-55 (1st Series) New Radio

*First time a NEW radio has been available for this truck in 50 years! Offers the same features as the 47-53 unit plus:
Chrome plated die cast nose piece looks original.
Includes primered dash bezel exactly like the original (must be painted to match) and correct knobs.
Optional Dash Speaker (shown) provides two 4"x6" 3-way speakers that fit in original 6"x9" opening.*



986771R 54-55
(9.65-15) \$500.00 EA



986771S 54-55
Optional speakers. Pair of 4in x 6in mounted to new radio (not sold separately). (9.65-15) . . . \$100.00 SET

1954 Radio



986694E 54
Radio knob, black
(outer). (9.65-15)
\$11.00 EA



986694J 54
Radio knob, GMC.
Grey (outer). (9.65-15)
\$11.00 EA



986694H 54
Disk dummy (knob)
black behind radio
knob. (9.65-15)
\$11.00 EA



986694K 54
Disk dummy (knob),
grey, GMC, behind
radio knob. (9.65-15) .
\$11.00 EA



986694 54
Disk w/ lever (knob),
black, behind radio
knob. (9.65-15)
\$11.00 EA



986694L 54
Disk w/ lever (knob)
grey, GMC, behind
radio knob. (9.65-15) .
\$11.00 EA



986694C 54
Radio face housing (rough casting)
(9.65-15) \$25.00 EA



986669B 54
Radio dial lens. (9.65-15) ..\$19.00 EA



986668B 54
Radio dial lens, GMC.
(9.65-15) \$14.00 EA



986770C 54
Radio speaker cover,
cardboard. (9.65-15) .
\$10.00 EA

986770A 54
Tube set, 6-tube single unit radio #986770.
(9.65-15) \$110.00 SET



986771BKT 54-55
1st Series radio mounting bracket
(9.65-15) \$40.00 EA

Providing part numbers speeds up your order, improves accuracy and helps us maintain low prices.

See Illustration Index for core charge information and a list of abbreviations. For Body Model information, see Section 5T.



Section 360T: Radios, Antenna & Related

Format = Part No., Year, Description, Original Chevrolet Parts Book Group No., Price and Unit of Measure.

Radio Tubes

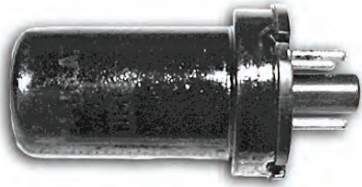

1211924 37-54
OZ-4. Solid state (\$15 core-exchange). (9.65-15) \$40.00 EA

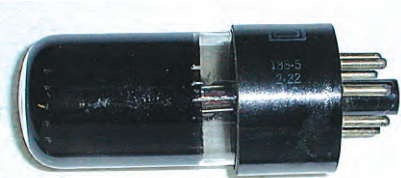

6V6GT All
Glass tubes. (9.65-30) \$30.00 EA

Vibrator



7239124E 37-38
6v w/ negative grounds. Solid state, no more radio hum (if original vibrator doesn't hum, it's time to replace it). (9.65-20) \$55.00 EA



7239124 39-54
6v w/ negative grounds. Solid state, no more radio hum (if original vibrator doesn't hum, it's time to replace it). (9.65-15) \$37.00 EA



7239124R All
12v w/ negative grounds. Solid state, no more radio hum (if original vibrator doesn't hum, it's time to replace it). (9.65-15) \$37.00 EA

Nut-Thin Hex



604275 All
For 1/2in. Shaft-radio
(2 Pc Set) (9.65-40) \$6.00 SET



120369 All
For 3/8in. Shaft-radio
(2 Pc Set) (9.65-40) \$3.00 SET

Note: Radio & Heater Paint see Section 15T.

Odds & Ends

Please call for availability on all Odds & Ends parts; once part is sold, it may no longer be in stock.

605300N 42-48
Knob. Radio (small ivory w/ swirl) (9.65-40) \$15.00 EA

7239124U 39-54
Vibrator - 6 volt used. (1.664-40) \$20.00 EA

Returns require a return authorization number, Please call.

Section 370T: Cowl Vents, Wiper Motors, Wiper Arms, Knobs & Windshield Washers

Format = Part No., Year, Description, Original Chevrolet Parts Book Group No., Price and Unit of Measure.



Header Panel



- 593369 36-38
Mounts above windshield (fiberglass).
(16.562-15) \$86.50 EA
- 598772 39-46
Mounts above windshield (fiberglass).
(16.563-15) \$93.75 EA

Fuel Pump

Tired of your wipers stopping when you get on the accelerator? Replace your fuel pump with one that also has a vacuum pump for consistent wiper movement.



- 5591457M . . . 37-51
W/ vacuum pump
(metal bowl) (3.9-15) .
\$89.00 EA



- 5591457 37-51
W/ vacuum pump
(glass bowl) stops
slow wipers, original
accessory. Also fits
GMC. (3.9-15)
\$125.00 EA



- 5592675M . . . 52-57
W/ vacuum pump
(metal bowl) stops
slow wipers, original
accessory. (3.9-15) . .
\$90.00 EA



- 5592675 52-57
W/ vacuum pump
(glass bowl) stops
slow wipers, original
accessory. (3.9-15) . .
\$125.00 EA

Fuel Pump Rebuild Kit



- 5591844 37-51
W/ vacuum pump
(3.901-15) \$65.00 EA



- 5591825 52-57
W/ vacuum pump (3.9-15) . \$64.00 EA

Cover -Wiper Motor Access Hole



- 593351L 36-38
Left (fiberglass).
(16.563-15) \$19.00 EA



- 593352R 36-38
Right (fiberglass).
(16.563-15) \$19.00 EA

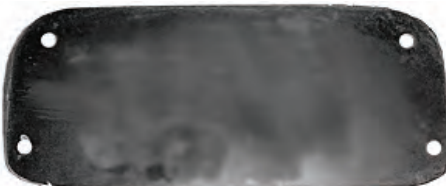

- 593353 36-38
Blank (right hand side w/
out cover-wiper) (fiberglass).
(16.563-15) \$15.00 EA



- 598811L 39-46
Left (fiberglass).
(16.563-15) \$19.00 EA



- 598813R 39-46
Right (fiberglass).
(16.563-15) \$19.00 EA



- 598814 39-46
Blank (fiberglass).
(16.563-15) \$15.00 EA

Wiper Cap



- 4601065
Chrome cap replaces
wiper arm on shaft.
(10.159-15) \$17.25 PR



- 4601065C
Chrome cap replaces
wiper arm on shaft.
Bullet shaped.
(10.159-15) \$13.50 PR

Wiper Motor Electric Kit



- 598989H 37-46
6v, w/ arm & blade easy installation.
(16.064-15) \$155.00 EA
- 598989G 37-46
12v, w/ arm & blade easy installation.
(16.064-15) \$156.50 EA

Providing part numbers speeds up your order, improves accuracy and helps us maintain low prices.

See Illustration Index for core charge information and a list of abbreviations. For Body Model information, see Section 5T.



Section 370T: Cowl Vents, Wiper Motors, Wiper Arms, Knobs & Windshield Washers

Format = Part No., Year, Description, Original Chevrolet Parts Book Group No., Price and Unit of Measure.

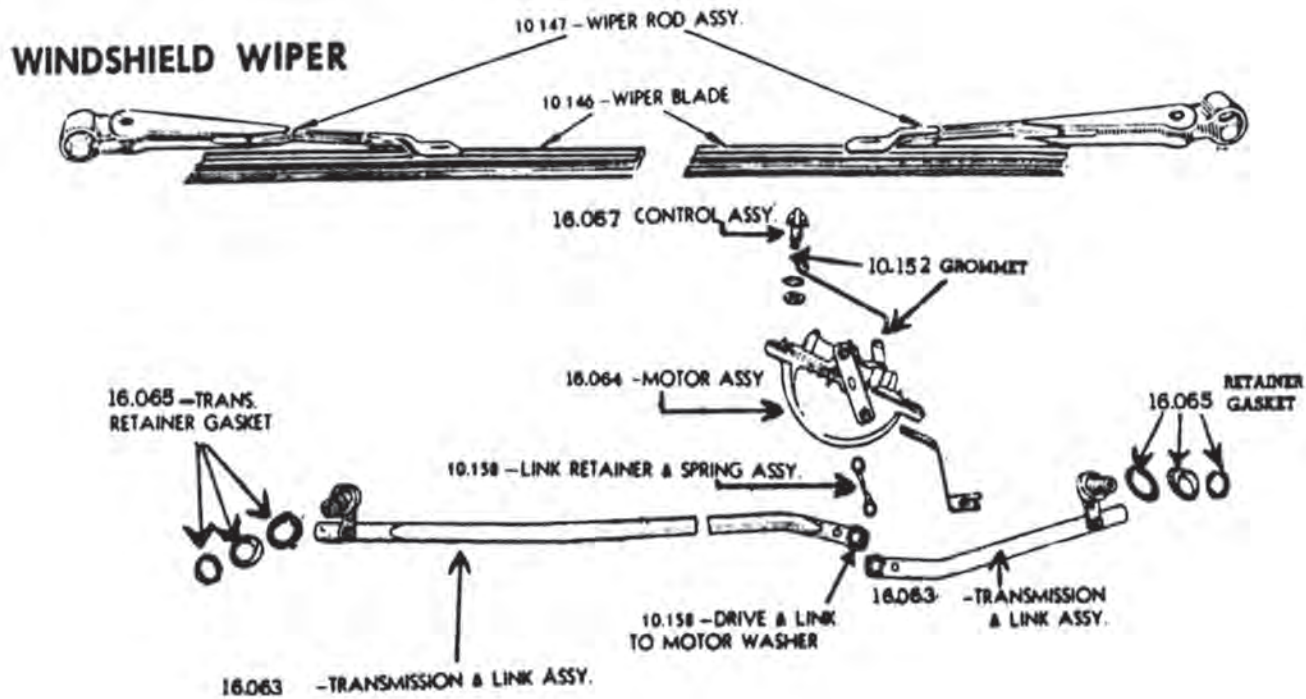

Wiper Motor -Electric



598989E37-46
6v. Also fits GMC,
requires some
modification to fit.

(16.064-15) \$62.00 EA



598989F37-46
12v. Also fits GMC,
requires some
modification to fit.

(16.064-20) \$56.25 EA



4089935M47-53
2 speed & self park (6v).
(16.064-15) \$210.00 EA

4089935N47-53
2 speed & self park (12v), also fits GMC.
(16.064-15) \$210.00 EA

3710004M54
2 speed & self park (6v). Comes w/
original style knob.
(16.064-15) \$192.00 EA

3710004N54
2 speed & self park (12v), also fits GMC.
(16.064-15) \$210.00 EA

Electric Wiper Conversion Kit

Clean Wipe System. Replaces factory wiper system. Comes with 12 volt, two-speed electric motor, complete with bracketing, linkage arms, wiper transmissions, wiper arms & blades, wiring and switch. Designed to fit in stock location above the windshield. For wiper delay add part #4073750D



598989KD39-46
Deluxe Clean Wipe System. Stainless
wiper arms & blades.
(16.064-0) \$349.00 KIT



598988E37-46
Replaces motor & 2 transmissions.
Quiet cable drive & motor can
be mounted outside passenger
compartment for quiet operation.
(16.064-15) \$265.00 KIT

598988F37-46
Intermittent-replaces motor & 2
transmissions. Quiet cable drive & motor
can be mounted outside passenger
compartment for quiet operation.
(16.064-15) \$299.00 KIT

4089934E47-54
Replaces motor & 2 transmissions. Quiet
cable drive & motor can be mounted
outside passenger compartment for quiet
operation.
(16.064-15) \$325.00 KIT

4089934F47-54
Intermittent-replaces motor & 2
transmissions. Quiet cable drive & motor
can be mounted outside passenger
compartment for quiet operation.
(16.064-15) \$359.00 KIT

Returns require a return authorization number, Please call.

Section 370T: Cowl Vents, Wiper Motors, Wiper Arms, Knobs & Windshield Washers

Format = Part No., Year, Description, Original Chevrolet Parts Book Group No., Price and Unit of Measure.



Intermittent Delay Switch



4073750D.
For electric wiper
motors. (10.15-15) . . .
\$64.00 EA

Wiper Arm & Blade (Billet)

For use with electric wiper conversion kits. These arms and blades come in 10 inch lengths. They are designed to be cut to length as needed. All arms have adjustable blade angle feature. The arms come with a brushed finish, but can be finished to suit individual needs.



3683910RL
Angle arm-left hand (curved
windshield). (10.146-15) .. \$39.50 SET



3683910RR
Angle arm-right hand (curved
windshield). (10.146-15) .. \$39.50 SET



3683910S
Straight arm-left or right (flat
windshield). (10.146-15) .. \$39.50 SET

Wiper Arm



3683910A
Stainless. Adjustable length and wiper
angle. (10.146-15) \$30.00 EA

Hose



609742 All
1/2in. ID sold by the inch
(3.003-40) \$0.25 IN

Wiper Transmission & Link Assembly



3683915B 47-53
Like original. (16.063-15) \$120.00 L&R
3703856B. 54-55
54-55 (1st Series).
(16.063-15) \$120.00 L&R

Cowl Vent Knob



3656663A. 40-46
As original, brown.
(16.13-15) .. \$8.75 EA



3682916A. 47-53
Side or top vent,
maroon. (16.13-15). . .
\$9.00 EA



3131111 54
Black (16.13-15)
\$11.00 EA

Cowl Vent Seal



373398 34-38
Non-absorbing, molded.
(16.14-15) \$20.00 EA



3681067 39-46
Non-absorbing, molded.
(16.14-15) \$18.75 EA

3681067A 39-46
Sponge
(16.14-30) \$9.75 EA



3684389 47-50
Side vent, non-absorb molded.
(16.14-40) \$10.75 EA

3684389A 47-50
Side vent, sponge.
(16.14-20) \$6.25 EA



3682856 47-53
Non-absorb molded.
(16.14-20) \$13.50 EA

3682856A 47-53
Sponge
(16.14-15) \$4.00 EA



3703560 54
Non-absorb molded.
(16.14-30) \$16.25 EA

370T

Providing part numbers speeds up your order, improves accuracy and helps us maintain low prices.

See Illustration Index for core charge information and a list of abbreviations. For Body Model information, see Section 5T.





Section 370T: Cowl Vents, Wiper Motors, Wiper Arms, Knobs & Windshield Washers

Format = Part No., Year, Description, Original Chevrolet Parts Book Group No., Price and Unit of Measure.

3703560A 54
Sponge
(16.14-15) \$5.75 EA

Hose

 4027764 39-46
Cowl vent drain.
(16.127-40) \$4.00 EA

 3683657 47-54
Cowl vent drain.
(16.127-15) \$5.00 EA

Bolt

 4023060 39-46
Cowl vent hinge
(shouldered bolt).
(16.135-15)
\$19.50 SET

Wiper Knob

 3685141 47-49
Chrome (16.067-15) . .
\$7.25 EA

 3699117 50-53
Maroon (16.067-15) . .
\$7.25 EA

 3703853 54
Black (16.067-15)
\$9.00 EA

Vacuum Hose

 601607 All
Wiper motor to engine,
1/4in. i.d. (10.155-40) .
\$1.50 FT

Wiper Control Link

 3699117A 47-53
Rod (16.067-15) \$4.25 EA

Grommet-Wiper Control Link

 4093397 47-53
Wiper control link
(16.065-15) . \$1.75 PR

Windshield Washer Hose



604041B 37-50
9 ft, w/ original GM instruction
sheet & firewall grommet.
(8.962-30) \$21.75 KIT

Hose Connector 3-way

 3682929 All
Y wiper & washer,
7/32in. (16.066-40) . . .
\$2.25 EA

Pivot Rubber Bushings

 3746483 47-53
For wiper motor
(10.158-15) . \$1.25 PR

Wiper Motor Pivot Linkage Retainer

 4065091 47-53
For wiper motor (10.158-15) . \$2.50 EA

 4570135 54-57
For wiper motor (10.158-30) . \$5.00 EA

Wiper Motor-Vacuum

SPECIFYALL All
Rebuild your core (please send motor
only-do not send any other parts)
(10.15-15) \$115.50 EA

Wiper Motor-Vacuum Operated Rebuild

\$10 shipping & handling for rebuild service.

Wiper Blade

 985459 29-46
8-1/2in. (10.146-40) \$8.25 EA

 985982 39-46
9in. (10.146-30) \$6.25 EA

 3683905 47-53
10in. (10.146-30) \$7.00 EA

 3683905S 54-59
10in. (10.146-15) \$18.50 EA

 561094S 54-59
11-1/2in. (10.146-15) \$14.00 EA

Wiper Arm

 603047 31-38
7in. stainless arm
(10.147-15) \$24.50 EA

Returns require a return authorization number, Please call.

Section 370T: Cowl Vents, Wiper Motors, Wiper Arms, Knobs & Windshield Washers

Format = Part No., Year, Description, Original Chevrolet Parts Book Group No., Price and Unit of Measure.



598991 39-46
(10.147-30) \$22.50 EA



3697280 47-53
Left (10.147-20) \$20.00 EA



3697282 47-53
Right (10.147-20) \$20.00 EA



3730483 54-59
Left (10.147-20) \$20.00 EA



3722488 54-59
Right (10.147-20) \$20.00 EA

Gasket



593383 36-38
Wiper motor bezel to
cab (16.065-0)
\$1.75 EA



598993 39-46
Wiper motor bezel to
cab (16.065-30)
\$1.50 EA



3685793A 47-53
Wiper transmission
(16.065-15) . \$3.00 PR



3703860A 54
Wiper transmission
(16.065-30) . \$5.25 PR

Chrome Bezel



593384 36-38
Wiper transmission
(16.065-15) \$26.75 EA



598994 39-46
Wiper transmission
(16.065-15) \$27.50 EA



3683911 47-53
Wiper transmission
(16.065-15). \$12.00 PR



3703859 54
Wiper Transmission
(16.065-15)\$24.00 SET

Nuts



3683913 47-59
Retains chrome
wiper bezel to cowl
(16.065-15) . \$5.00 PR

Windshield Washer Nozzles



604354 40-50
Chrome w/ mounting
bracket. (8.798-15). . .
\$20.50 PR

Odds & Ends

Please call for availability on all Odds & Ends parts; once part is sold, it may no longer be in stock.

3656663 41-46
Cowl vent linkage (16.13-0) \$40.00 EA

3654631U 40-46
Handle-Windshield Regulator (32*000-0)
\$25.00 EA

16190 47-53
Top cowl vent door, used (16.125-0) . .
\$15.00 EA

598813U 39-46
Wiper motor access cover. Excellent
condition (Used). (16.563-20)
\$30.00 EA

598811N 39-42
Wiper motor access panel cover.
Brown (NOS) (16.563-0) . . . \$25.00 EA

3683915U 47-53
Wiper trans link left hand (Used)
(16.063-0). \$10.00 EA

Providing part numbers speeds up your order, improves accuracy and helps us maintain low prices.

See Illustration Index for core charge information and a list of abbreviations. For Body Model information, see Section 5T.



Section 380T: Door Handles, Armrests, Door Latches & Strikers

Format = Part No., Year, Description, Original Chevrolet Parts Book Group No., Price and Unit of Measure.

ILLUSTRATIONS ARE COMPLETE ASSEMBLIES.
SEE TEXT FOR AVAILABILITY.

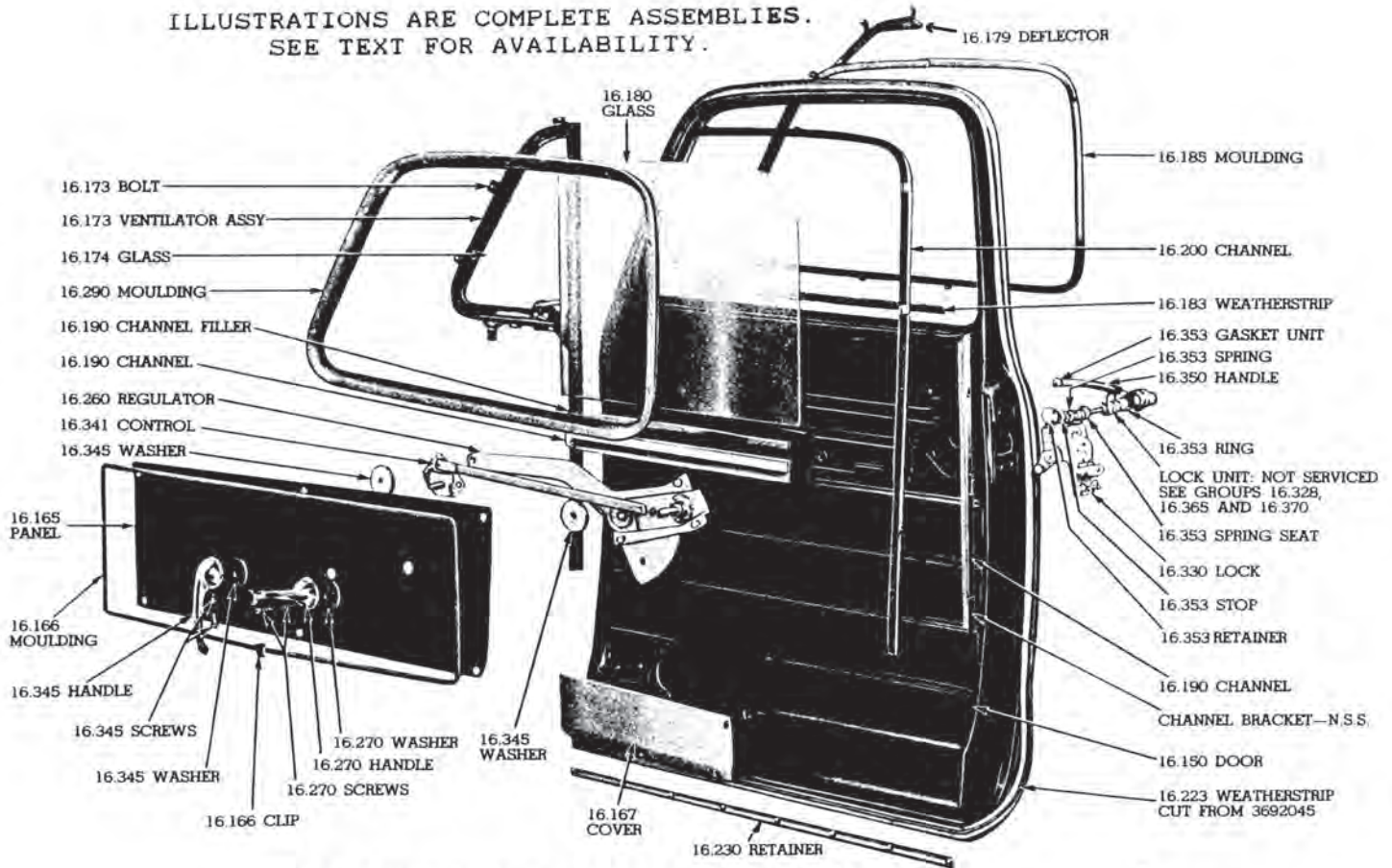

1951-53 CONVENTIONAL CAB DOOR ASSEMBLY

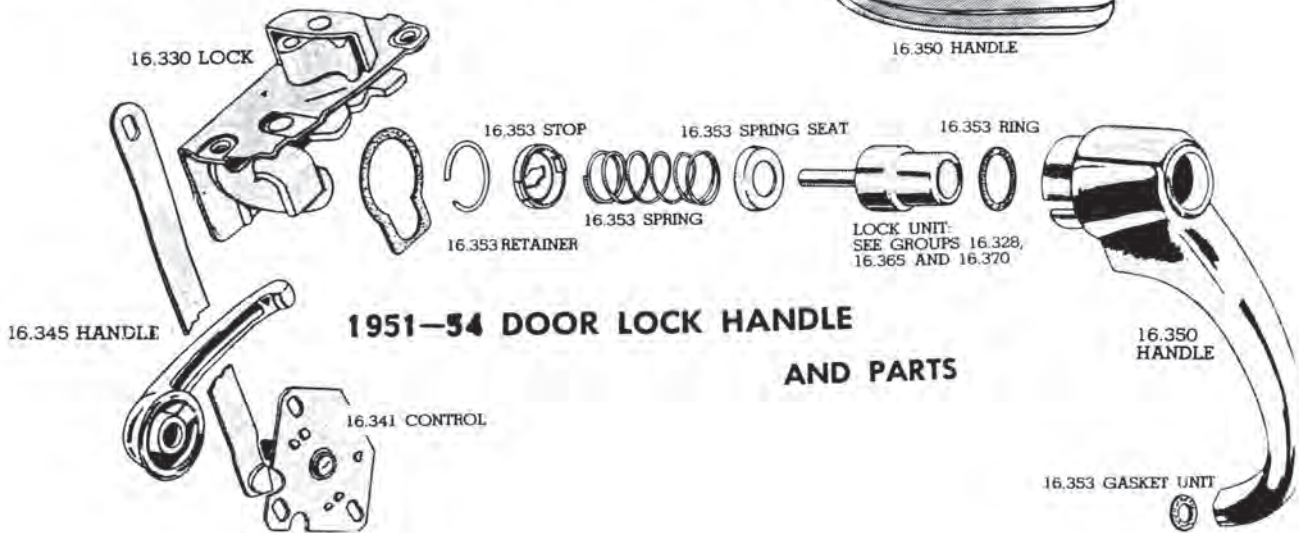
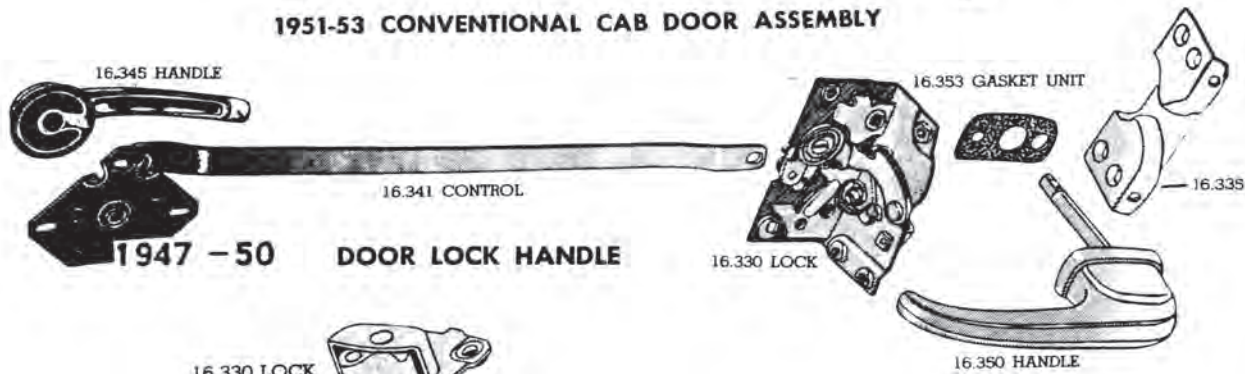

Returns require a return authorization number, Please call.

Section 380T: Door Handles, Armrests, Door Latches & Strikers



Format = Part No., Year, Description, Original Chevrolet Parts Book Group No., Price and Unit of Measure.

Note: Window Cranks see Section 460T.

Door Handle Exterior



3654589 39-46
Non-locking. (16.36-15) . . . \$39.00 EA



3654589B 39-46
Driver side, Chrome non-locking door handle (not original). (16.36-15) \$60.00 EA



3686255 47-51
Left & right (16.36-15) \$56.25 PR



3698881 52-59
Non-locking pushbutton (left side) & right side w/o pushbutton (install yours or use our pt #3700318). (16.35-15) \$51.00 PR

Pushbutton



3700318 52-59
For right side door handle w/ lock cylinder & 2 keys. (16.365-15) \$40.00 EA

Door Handle Exterior Return Spring

3683067A 39-46
Left (16.33-15) \$8.00 EA



3684168 47-51
Exterior (16.33-15) . . . \$5.00 EA

Door Handle Exterior Guard



3698881C 52-59
Chrome (16.35-15) \$18.00 PR

Gasket-Door Handle



603954A 47-51
Door handle & lock (exterior). (16.353-20) \$4.00 SET

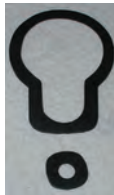

3700098 52-59
Door handle (exterior). (16.353-15) . . . \$3.50 SET

Screw Set



4147641A 47-51
Door handle bezel (exterior) (4 pcs). (16.27-15) . . . \$3.75 SET

Door Lock



3684820 47-53
W/ 2 keys, exterior 47-51 right door, also Panel & Suburban. (16.328-15) \$40.00 EA

Retainer



3676359 47-51
For door lock cylinder. (16.328-15) \$10.00 EA

Door Lock Gasket



1393155A 42-46
Key (exterior). (16.328-20) . \$1.25 EA

Key Blank



3694624 35-57
Original GM octagon head. Fits ignition, door & spare tire locks. (2.187-30) \$1.75 EA



601272 35-54
Original GM round head. Fits trunk, glove box & locking gas cap (2.187-30) \$2.25 EA

Door Lock Knob



3654592 34-40
Small Chrome T-handle (16.392-15) \$14.75 EA



3658537 41-46
Small chrome t-handle. (16.39-15) \$11.50 EA

Door Latch Striker



598777A 39-46
Replacement. (16.335-15) . \$9.75 EA

Providing part numbers speeds up your order, improves accuracy and helps us maintain low prices.

See Illustration Index for core charge information and a list of abbreviations. For Body Model information, see Section 5T.



Section 380T: Door Handles, Armrests, Door Latches & Strikers

Format = Part No., Year, Description, Original Chevrolet Parts Book Group No., Price and Unit of Measure.



3684235B. . . . 47-51
(16.335-15) \$20.00 PR



3753185B. . . . 52-59
(16.335-15) \$24.00 PR



3753185A. . . . 52-59
Left (16.335-15)
\$10.25 EA

Door Latch Assembly



3684167. 47-51
Left (16.335-15) \$40.00 EA



3684166. 47-51
Right (16.335-15) \$40.00 EA



3698813. 52-54
Left (16.335-15) \$50.00 EA



3698814. 52-54
Right (16.335-15) \$50.00 EA

Latch Repair

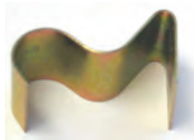

3684167R. . . . 47-63
Repair spring
(16.335-15) . \$3.25 EA

Clutch Head Screw Set



4147641C. . . . 52-54
Door latch striker
(does both doors) (8
pcs). (16.27-30)
\$6.25 EA



3707583A. . . . 47-51
Latch assembly to
door (does both
doors). (16.27-15) . . .
\$6.25 SET



3707583. 52-54
Latch assembly to
door (does both
doors). (16.27-20) . . .
\$6.25 SET

Ferrule



4003748. 29-38
Chrome, w/ grommet,
door handle. (10.537-
40) \$7.75 EA

4082056. 39-46
Chrome, w/ grommet, door handle.
(10.537-40) \$8.00 EA

Rubber Grommet



4125630A. . . . 39-46
Door handle ferrule.
(10.537-15) . \$5.25 EA

Ferrule Tool

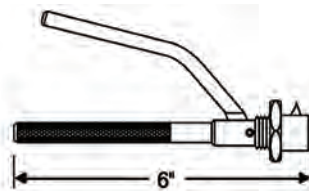

4088134A. All
Installs door handle ferrules.
Return tool in same condition as
sent for a \$20 refund (Does not
work with Ferrule part #4125630).
(10.537-15) \$40.25 EA

Gasket-Door Handle

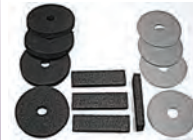

3686114B. . . . 47-54
Interior door & window
handles with door
panel spacers (12pcs).
(16.345-20)
\$10.00 SET

Door Handle Interior



373434B. 34-38
Chrome. (16.345-15) .
\$33.00 EA



3654593. 39-46
Unplated, military army green color
(NOS). (16.345-15) \$20.50 EA



3654593C. 39-46
Chrome interior door handle.
(16.345-15) \$33.00 EA



3848873. 47-66
(16.345-20) \$10.25 EA

Screws



3683258. 47-53
Retains original GM
interior handles.
(16.27-15) . . \$5.00 PR



4147641B. . . . 47-54
Clutch head, attaches
the interior door
handle remote to
the door (6 pcs).
(16.341-20) \$6.25 SET

Returns require a return authorization number, Please call.

Section 380T: Door Handles, Armrests, Door Latches & Strikers



Format = Part No., Year, Description, Original Chevrolet Parts Book Group No., Price and Unit of Measure.

Clutch Head Driver



DRIVER. All
Magnetic driver w/ 5 bits (1/8in.,
5/32in., 3/16in., 1/4in., 5/16in.) with
Chevs imprint. (8.821-15) \$22.25 SET

Return Spring



3698879. 47-54
Fits remote for interior
handle. (16.342-0) . . .
\$7.00 EA

Remote w/ Linkage



3698877. 47-55
Left side for inside handle (original
52-55). (16.341-15) \$28.00 EA

3698878. 47-55
Right side for inside handle (original 52-
55).
(16.341-15) \$28.00 EA

Door Arm Rests



986154. 47-54
Brown (super!) (16.155-15) . \$35.00 EA
986154D 47-54
Black (super!)
(16.155-15) \$35.00 EA
986154M 47-54
Maroon. Like original, Superb! 6" mounting
holes (center-to-center).
(16.155-15) \$42.75 EA

Arm Rest Rubber Pad



3684360. 47-54
(16.155-15) \$20.50 EA

Arm Rest Bracket



3684383. 47-54
Black, plastic. (16.155-15) . \$24.50 EA
3684384. 47-54
Brown
(16.155-15) \$24.50 EA

Metal Trim Plate



3684383A. 47-54
For arm rest. (16.155-15) . \$12.25 EA

Kick Panels



474791. 36-38
Inner. Choose Black, Brown or
Grey. Specify color when ordering.
(16.7-20) \$16.00 L&R

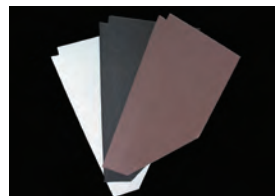

609526. 39-46
Inner. Choose Black, Brown or
Grey. Specify color when ordering.
(16.7-30) \$16.00 L&R



609527. 47-54
Inner. Choose Black, Brown
or Grey (not original).
Specify color when ordering.
(16.7-20) \$16.00 L&R

Door Panels -Cardboard



3700543A. 47-54
Original leather grain Black, Brown or
Maroon. Specify color when ordering.
(16.165-40) \$16.50 L&R
3700543. 47-54
Choose Black, Brown or Grey. Specify
color when ordering.
(16.165-0) \$15.00 L&R

Door Panel-Metal Frames



3686120. 47-54
With clips. (16.166-15) . . . \$35.00 PR
3686120S 47-54
Polished stainless steel with clips.
(16.166-15) \$40.00 PR

Metal Frame Joint Clips



3697673. 47-54
Zinc (16.166-15).
\$1.75 PR



3697673S. 47-54
Polished Stainless
(16.166-15) . \$2.00 PR

Retainer Button



3707152. 54
Door panel cardboard,
use 12. (16.165-40) . .
\$1.00 EA

Providing part numbers speeds up your order, improves accuracy and helps us maintain low prices.

See Illustration Index for core charge information and a list of abbreviations. For Body Model information, see Section 5T.



Section 380T: Door Handles, Armrests, Door Latches & Strikers

Format = Part No., Year, Description, Original Chevrolet Parts Book Group No., Price and Unit of Measure.

Screw Set



3684161A 47-53
Door panel, cardboard,
does both doors (12
pcs). (16.29-40)
\$4.00 SET



3694284B 47-54
Headliner, door panel, window
& windshield garnish mouldings.
(16.29-30) \$14.25 KIT



3694071 47-50
Attaches upper and
lower door frame
glass. (16.19-15)
\$5.00 SET



3684481B 47-54
Window garnish mouldings, 2 doors.
(16.29-30) \$5.50 SET

Interior Screws



3654597C 37-50
8 x 32 x 1/2in. clutch head (10 pcs).
(16.17-15) \$3.25 SET



3654597A 37-50
8 x 32 x 1/2in. clutch head (100 pcs).
(16.17-15) \$21.50 SET

Odds & Ends

*Please call for availability on all Odds
& Ends parts; once part is sold, it may
no longer be in stock.*

3848873U 47-66
Door handle (Used) (16.345-0)
\$15.00 EA

3654593U 39-46
Door handle. Chrome. Good condition.
(13.345-40) \$30.00 EA

3684166U 47-51
Door latch assembly, used fits right
hand (16.335-40). \$30.00 EA

3698813U 52-54
Door latch, left side (Used). (16.335-0)
\$30.00 EA

3658536U 39-42
Door latch, right side (Used). (16.335-0)
\$40.00 EA

598907 39-46
Door Lock Remote (16.341-40)
\$35.00 EA

3654593N 39-46
Exterior door handle (NOS). Shelf
worn. Not plated or painted. (16.345-40)
\$7.50 EA

3695977 51-54
Interior window moulding stainless
steel (left) used in good condition
(16.29-40). \$45.00 EA

3684175U 47-50
Mouldings door garnish & reveal
(36-000-0) \$175.00 L&R

3698885 52-57
Spring-Door Handle Push Button
(33*000-0) \$2.00 EA

Returns require a return authorization number, Please call.

Section 390T: Door Hinges, Pins & Check Links



Format = Part No., Year, Description, Original Chevrolet Parts Book Group No., Price and Unit of Measure.

Door Hinges



603345 39-46
Upper w/ attaching bolts and pins.
Fits left or right. (16.32-15) . \$45.00 EA



603344 39-46
Lower w/ attaching bolts and pins.
Fits left or right. (16.32-15) . \$45.00 EA



3847527B 47-55
Left, upper & lower hinges
(47-53 & 54-55 1st Series).
(16.32-15) \$150.00 SET



3847528B 47-55
Right, upper & lower hinges
(47-53 & 54-55 1st Series).
(16.32-15) \$150.00 SET

Door Hinge Bolt



3847527A 47-55
Includes star lock
washer. 5 per hinge
needed. (-15)
\$1.00 EA

Hinge Seal



3807777 47-55
Back door, Panel &
Suburban (4 pcs).
(16.325-15)
\$11.50 SET

Hinge Pin



598653 29-46
(16.323-20) \$2.00 EA



598653S 29-46
Stainless steel. (16.323-30) . \$6.00 EA



598653A 29-46
For Accessory Mirror.
(16.323-20) \$2.25 EA



3847685 47-54
1/8in. Oversize. (16.323-30) . \$2.00 EA

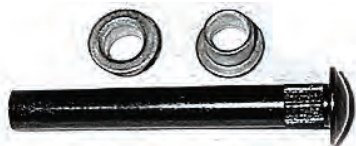

4023559B 39-54
Pin w/ bushings. Fits back door
on Suburban & Panel (3 pcs).
(10.466-30) \$4.00 SET

Door Strap Check Bracket



596409 39-46
Replaces original which
is normally rusted &
broken. (16.44-15)
\$20.00 EA

Door Check Link Assembly



3681747 39-46
W/ rubber, pin & spring.
(16.43-15) \$20.00 EA

Door Check Link Springs



3690447 47-54
(16.323-15) . \$4.50 PR

Check Link Bumper

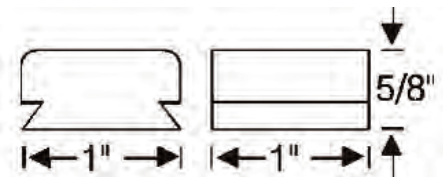

3711312 47-59
Back door (Panel & Suburban)
(16.43-15) \$19.25 PR

Odds & Ends

Please call for availability on all Odds & Ends parts; once part is sold, it may no longer be in stock.

3688765U 47-55
Hinge. Door, left lower (Used) exc
COE. (16.32-0) \$40.00 EA

3688763U 47-55
Hinge. Door, left upper (Used) exc
COE. (16.32-0) \$40.00 EA

3688764U 47-55
Hinge. Door, right upper (Used) exc
COE. (16.32-40) \$40.00 EA

Providing part numbers speeds up your order, improves accuracy and helps us maintain low prices.

See Illustration Index for core charge information and a list of abbreviations. For Body Model information, see Section 5T.



Section 400T: Door Bumpers, Windlace & Weatherstrip

Format = Part No., Year, Description, Original Chevrolet Parts Book Group No., Price and Unit of Measure.

Door Sill Retainer



3683660BA 47-53
Polished billet aluminum door
sill seal, on cab (33-1/4").
(16.23-15) \$90.00 PR

Door Windlace



3847443 36-49
Black rubber (16.225-20) . . . \$37.00 PR
3681081K 37-40
Black vinyl covered
(16.225-15) \$37.00 PR
3681081N 37-40
Brown vinyl covered
(16.225-15) \$37.00 PR
3681081G 37-40
Grey vinyl covered
(16.225-20) \$37.00 PR
3681082 41-46
Black vinyl covered
(16.225-15) \$37.00 PR



3653999 41-46
Brown vinyl covered
(16.225-15) \$37.00 PR
3681082G 41-46
Grey vinyl covered
(16.225-20) \$37.00 PR
3692458A 50-54
Black rubber (16.225-30) . \$46.25 SET
3692458 50-54
Grey tan rubber
(16.225-15) \$37.50 PR
3692458B 50-54
Dark blue, original, 54-55 Deluxe cab
(16.225-0) \$44.25 PR

3692458G 50-54
Dark green, original, 54-55 Deluxe cab
(16.225-15) \$44.25 PR

Windlace Retainer



3685651B 50-55
Left side, door. 3 pcs.
(16.23-15) \$70.00 EA

Door Sill Seal



3681212 37-46
Attaches to cab, black (6 foot length)
(16.225-40) \$19.25 EA
3676019 47-49
Attaches to cab, black
(16.225-30) \$10.50 SET
3700548 50-54
Attaches to cab (black)
(16.225-15) \$12.00 PR
3700547 50-54
Attaches to cab, grey/ brown
(16.225-15) \$23.25 PR
3700548B 50-55
Attaches to cab, dark blue, original, 54-55
Deluxe cab
(16.225-0) \$18.25 PR
3700548G 50-55
Attaches to cab, dark green, original 54-55
Deluxe cab
(16.225-0) \$18.25 PR

Door Sill Seal Retainer

3683660S 47-49
Stainless (door sill seal) on cab.
(16.23-15) \$36.00 EA



3683660 47-49
Steel (door sill seal) on cab.
(16.23-15) \$15.00 EA
3693500S 50-54
Stainless (door sill seal) on cab. 33-5/8"
long.
(16.23-20) \$64.00 SET

3693500 50-54
Steel (door sill seal) on cab. 33-5/8" long.
(16.23-15) \$24.00 PR

Screws



3654597 47-49
Door sill metal retainer
(16 piece) (16.231-40)
\$3.25 SET



3654598 50-54
Door sill metal retainer
(8 pieces) (16.231-40)
\$2.50 SET

Door Weatherstrip



3700548A 37-54
Original 47-54, does 2 doors
(16.225-30) \$27.50 PR



4143075A 39-46
Panel. For both rear doors
(10.694-15) \$16.75 PR



3700548A 47-54
Panel & Suburban, does rear 2 doors
(16.225-40) \$30.50 PR

Metal Retainer



3691189S 47-54
Weatherstrip on door bottom (original
50-59) stainless (16.23-15) \$28.00 PR

3691189 47-54
Weatherstrip on door bottom (original
50-59) (16.23-15) \$16.00 SET

Returns require a return authorization number, Please call.

Section 400T: Door Bumpers, Windlace & Weatherstrip



Format = Part No., Year, Description, Original Chevrolet Parts Book Group No., Price and Unit of Measure.

Weatherstrip Clips



4076045 41-54
Retains back door weatherstrip.
Fits Panel & Suburban (5 pcs)
(10.695-20) \$3.25 SET

Weatherstrip Cement



511114
Black weatherstrip
cement, 5-oz tube.
Superior product!. (8.8-0) . . \$12.75 EA

Door Bumper



3681070 30-46
Door hinge post, 1in. x 1/4in.
thick, held by screw (2 pcs).
(16.4-15) \$5.75 SET

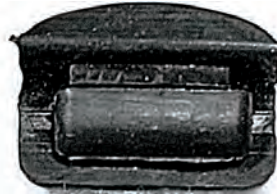

3681078 36-46
Door jamb, rear. 5/8in. x 7/8in.
x 1-7/16in. 41-46 uses 4.
(16.4-40) \$4.25 EA



3684752B 47-54
Door jamb, rear (4 pcs).
(16.4-40) \$3.75 SET

Dovetail Bumper

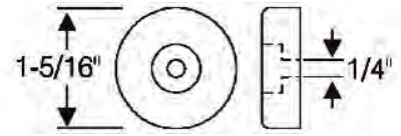

3807343 47-55
Left, back door. Panel,
Suburban (use with old casings).
(16.405-15) \$9.50 EA



1953—Jack Farnsworth, Bellevue, Washington

Providing part numbers speeds up your order, improves accuracy and helps us maintain low prices.

See Illustration Index for core charge information and a list of abbreviations. For Body Model information, see Section 5T.



Section 420T: Glass

Format = Part No., Year, Description, Original Chevrolet Parts Book Group No., Price and Unit of Measure.

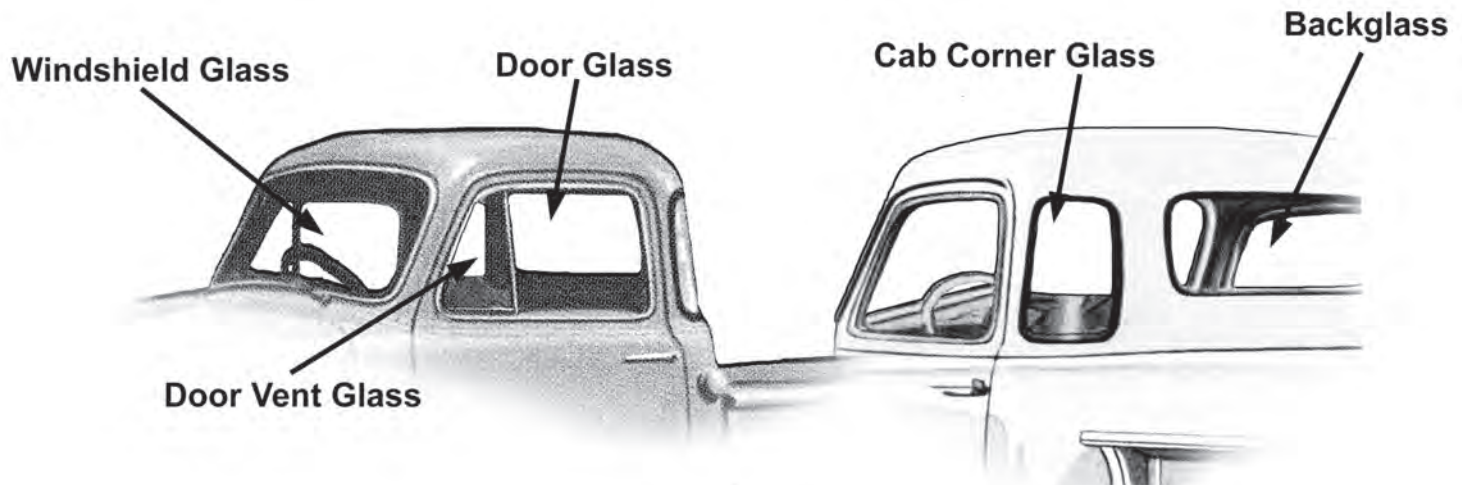

One Piece V-Bent Windshield Glass

Give your truck that clean, customized look with a one piece windshield. No more messy silicone sealing the center seam found on V-Butt windshields. All V-Bent windshields come with rubber seal.



TINTED SHOWN

1021V	39-46
Clear. Sold per side.	
(16.005-15)	\$420.00 EA
1021VCS	39-46
Clear. Sold per side.	
(16.005-15)	\$441.00 EA
1021VT	39-46
Clear. Sold per side.	
(16.005-15)	\$430.50 EA
1021VTS	39-46
Clear. Sold per side.	
(16.005-15)	\$441.00 EA
4235V	47-53
Clear. Sold per side.	
(10.027-15)	\$438.75 EA
4235VCS	47-53
Clear. Sold per side.	
(10.027-15)	\$480.25 EA
4235VT	47-53
Clear. Sold per side.	
(10.027-15)	\$430.50 EA
4235VTS	47-53
Clear. Sold per side.	
(10.027-15)	\$451.25 EA

Back Glass & Frame

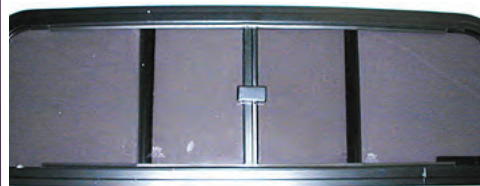

3704319C	47-54
Slider, with snap closer (tinted). Black frame. (16.464-15)	\$185.50 EA

Windshield Glass

Note: Oversize shipping charges apply on all windshields. Please call for rate. Additional \$7 packaging fee each piece.

Note: Flat glass available for most cars and trucks, inquire for prices not listed. Prices are per side on 2-piece windshields. Order 2 (for left or right) for a complete 2-piece windshield. For V-Butt applications add \$3.25 per piece. Specify at time of order if V-Butting your windshield to remove center bar.

Note: Windshield glass dark tint unavailable. All glass is custom made. \$7 packaging fee.

985	37-38
Clear. Sold per side.	
(16.005-15)	\$110.75 EA
985T	37-38
Clear. Sold per side.	
(16.005-15)	\$122.00 EA
985I	37-38
Clear. Sold per side.	
(16.005-15)	\$114.00 EA

985S	37-38
Clear. Sold per side.	
(16.005-15)	\$158.00 EA
1021	39-46
Clear. Sold per side.	
(16.005-15)	\$66.00 EA
1021T	39-46
Clear. Sold per side.	
(16.005-15)	\$77.75 EA
1021S	39-46
Clear. Sold per side.	
(10.027-20)	\$138.75 EA
4235S	47-53
Clear. Sold per side.	
(16.005-15)	\$87.75 EA
4235ST	47-53
Clear. Sold per side.	
(16.005-15)	\$96.50 EA
4235SS	47-53
Clear. Sold per side.	
(16.005-15)	\$138.75 EA
DW362	54
Clear. Sold per side.	
(16.005-15)	\$246.75 EA
DW362S	54
Clear. Sold per side.	
(16.005-15)	\$230.00 EA

Note: Add 10% for green tint; 25% for gray tints. Door & windshield glass dark tint unavailable.

Door Glass

3907	37-38
(16.18-15)	\$58.25 EA
4074	39-40
(16.18-15)	\$71.00 EA
4084S	41-46
(16.18-15)	\$60.50 EA
4236S	47-50
(16.18-15)	\$76.00 EA

Returns require a return authorization number, Please call.

Section 420T: Glass



Format = Part No., Year, Description, Original Chevrolet Parts Book Group No., Price and Unit of Measure.

4236SLSC	47-50
Left side, clear w/ chrome frame.	
(16.18-15)	\$150.00 EA
4236SRSC	47-50
Right side, clear w/ chrome frame.	
(16.18-15)	\$150.00 EA
4377SLS	51-54
Left side w/ sash channel.	
(16.18-15)	\$85.00 EA
4377SRS	51-54
Right side w/ sash channel.	
(16.18-15)	\$85.00 EA
4377S	51-54
(16.18-15)	\$55.75 EA

Note: 1951-54 Door glass can be cut to eliminate the vent window. Call for price.

2907S	51-54
(16.174-15)	\$36.75 EA

Panel Back Glass

2689	37-38
(16.174-15)	\$38.50 EA

Back Glass

2690	37-38
(16.174-15)	\$52.25 EA

Suburban/ Panel Back Glass

2838	39-46
(16.174-20)	\$63.75 EA

Back Glass

DB60	47-54
Panel & Suburban. Clear, left (curved).	
(16.174-20)	\$138.75 EA
DB61	47-54
Panel & Suburban Clear Right (Curved)	
(16.174-20)	\$138.75 EA
DB60T	47-54
Panel & Suburban. Tint, left (curved)	
(16.174-20)	\$138.75 EA
DB61T	47-54
Panel & Suburban Tint Right (Curved)	
(16.174-20)	\$138.75 EA
2839	39-42
For cab w/ die cast frame	
(16.174-15)	\$63.75 EA
2651S	42-46
(16.174-15)	\$63.75 EA
2720S	47-54
Clear.	
(16.174-15)	\$76.75 EA

Rear Corner Cab Glass

Note: Rear corner cab glass can be chopped. Call for price and details.

Rear Corner Cab Glass (laminated)

BB60C	47-54
Clear, laminated (will not fit COE)	
(16.174-30)	\$325.50 PR
BB60G	47-54
Grey, laminated (will not fit COE)	
(16.174-30)	\$351.75 PR
BB60T	47-54
Tint, laminated (will not fit COE)	
(16.174-30)	\$325.50 PR

Suburban Front Side Glass

2719S	47-52
(17.136-15)	\$41.25 EA
3007S	53-54
(17.136-15)	\$44.00 EA

Suburban Rear Side Glass

4237S	47-52
(17.136-15)	\$55.00 EA
4467S	53-54
(17.136-15)	\$55.00 EA
4075	39-46
(17.136-15)	\$77.50 EA
2721S	47-52
(17.136-15)	\$44.00 EA
3008S	53-54
(17.136-15)	\$44.00 EA

Suburban Qtr Rear Glass

4076	39-46
(17.136-15)	\$77.50 EA
4238S	47-52
(17.136-15)	\$60.50 EA
4466S	53-54
(17.136-15)	\$60.50 EA

Odds & Ends

Please call for availability on all Odds & Ends parts; once part is sold, it may no longer be in stock.

BB60C	47-54
Left Corner Glass (Used) (O&E-0)	
\$75.00 EA	
BB61C	47-54
Right Corner Glass (Used) (O&E-0) . .	
\$75.00 EA	

Providing part numbers speeds up your order, improves accuracy and helps us maintain low prices.

See Illustration Index for core charge information and a list of abbreviations. For Body Model information, see Section 5T.



Section 430T: Windshield Rubber, Windshield Frames, Windshield Cranks & Related

Format = Part No., Year, Description, Original Chevrolet Parts Book Group No., Price and Unit of Measure.

Windshield Rubber

3684802A 47-53
W/out mouldings. 1 piece for V-Bent,
V-Butt. (16.04-15) \$65.50 EA

Strap Bracket



475838A 36-38
Windshield crank-out.
(16.045-40) \$26.00 EA



3653708 39-46
Windshield crank-out, billet aluminum.
(16.045-15) \$26.00 EA

Windshield Regulator Rebuild



3654088 36-46
Rebuild service, casting & metal
tape must be good, exchange.
(16.045-15) \$150.00 EA

475838R 36-38
Rebuild service, must reuse metal
strap. Core must be good, exchange.
. \$150.00 EA

Windshield Crank



598909 39
W/ black knob (16.05-15) ..\$37.50 EA



3654631A 40-46
W/ brown knob (16.05-15) ..\$37.50 EA

Grommet



598986 37-38
Grommet, windshield
crank to dash.
(16.053-15) . \$3.00 EA

Knob



598910A 39
Window or windshield
crank. Black. (16.27-15)
\$11.00 EA



3654632B. 40-46
Window or windshield
crank. Rose tan.
(16.27-15) . \$11.00 EA

Windshield Rubber Bumper



3681093 37-46
(16.058-15) \$9.25 PR

Windshield Divider



3651622 39-46
Rubber retainer w/ threaded
steel core, no moulding.
(16.017-15) \$57.25 SET

Windshield Frame



602132 36
Steel, low roof cab, special order
(Super!) (16.01-15) \$340.75 EA



602498B 37-38
Steel (Super!) (16.01-15) . \$340.75 EA

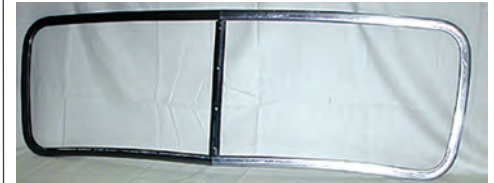

598972 39-46
Steel (Super!) (16.01-15) . \$399.50 EA

Trim Clip

602498A 37-38
Windshield frame. (16.01-15) \$16.50 PR

Windshield Frame Connecting Inserts



592329 39-46
W/ stainless steel screws.
Holds frame halves together.
(16.025-0) \$31.50 SET

Windshield Moulding



3684807 47-53
Complete set. Stainless Steel.
(16.041-15) \$80.00 SET

Returns require a return authorization number, Please call.

Section 430T: Windshield Rubber, Windshield Frames, Windshield Cranks & Related
Format = Part No., Year, Description, Original Chevrolet Parts Book Group No., Price and Unit of Measure.



3684697B 47-53
 Painted with upper & lower caps &
 fasteners. (16.018-15) . . . \$16.00 SET
 3684809 47-53
 Exterior. Stainless windshield division
 trim. (16.017-15) \$39.00 EA



3684697S 47-53
 Interior. Stainless windshield division
 trim. (16.018-15) \$54.50 EA



3676579 39-46
 Exterior. Center aluminum w/ 2 pc
 rubber set. (16.017-15) . . . \$94.50 SET

Windshield Frame Seal

3681322B 36-38
 36 low roof cab, vulcanized. (16.042-40)
 \$31.75 EA
 3681322 39-46
 Vulcanized. (16.042-40) . . . \$31.50 EA

Windshield Rubber

3684695 47-53
 For mouldings. (16.04-15) . . \$35.00 EA
 3684802 47-53
 Without mouldings (no holes in center
 of rubber). (16.04-15) \$35.00 EA
 3703534 54
 For mouldings. (16.04-15) . . \$32.00 EA
 3703533 54
 W/out mouldings. (16.04-15) \$32.00 EA

Setting Tape



603954B 29-46
 Windshield glass (120in. length).
 (10.696-15) \$14.00 SET

Screw Set



3684481A 47-54
 Windshield garnish moulding (14
 pcs). (16.29-40) \$3.75 SET

Odds & Ends

Please call for availability on all Odds & Ends parts; once part is sold, it may no longer be in stock.

3684697U 47-53
 Moulding inside windshield division
 (Used) (16.018-0) \$150.00 EA
 3684809 47-53
 Moulding outer windshield w/
 reinforcement (16.017-40) . . \$50.00 EA
 602132U 40
 Windshield frame (16.01-0) \$200.00 EA
 3684807U 47-53
 Windshield mouldings. Complete
 (Used) (16.041-0) \$150.00 L&R



Section 440T: Door Vent Window Rubber & Related

Format = Part No., Year, Description, Original Chevrolet Parts Book Group No., Price and Unit of Measure.

Vent Window Assembly



3699713G 51-54
Left side assembly with glass.
(16.173-15) \$88.50 EA



3699714G 51-54
Right side assembly with glass.
(16.173-15) \$88.50 EA



3695655 51-55
Left side assembly. Black
frame w/ seals (no glass).
(16.173-15) \$134.50 EA



3695656 51-55
Right side assembly. Black
frame w/ seals (no glass).
(16.173-15) \$134.50 EA

Vent Window Handle



3695417L 51-54
Left. (16.176-15) \$14.00 EA



3695416R 51-54
Right. (16.176-15) \$14.00 EA

Vent Window Rubber



3696027 51-54
Original C shape w/ upper pivot
pins, verticals w/ metal backs.
(16.175-15) \$45.00 PR

Pivot Pin



4173376 51-65
Vent window. Upper
(10.669-40) . \$2.50 PR

Tool

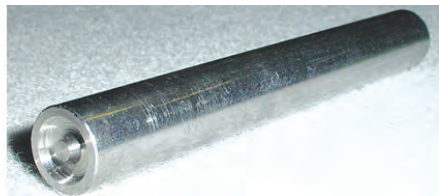

4173376A 49-65
Sets vent window pivot pin.
(10.669-15) \$5.00 EA

Please call for availability on all Odds & Ends parts; once part is sold, it may no longer be in stock.

Odds & Ends

3657394N 41-53
Rear yoke of rear U-Joint, 3/4T.
(13*000-0) \$35.00 EA
596912 37-40
Torque tube U-Joint housing rear
(13*000-0) \$35.00 EA
7500 41-53
U-joint trunion bearing 3/4T Rear
(13*000-0) \$8.00 EA
17110 51-54
Vent Window Frame Pivot, Lower
NORS (32*000-0) \$25.00 PR

Returns require a return authorization number, Please call.

Section 450T: Door Glass Channel Kits, Door Window & Related

Format = Part No., Year, Description, Original Chevrolet Parts Book Group No., Price and Unit of Measure.

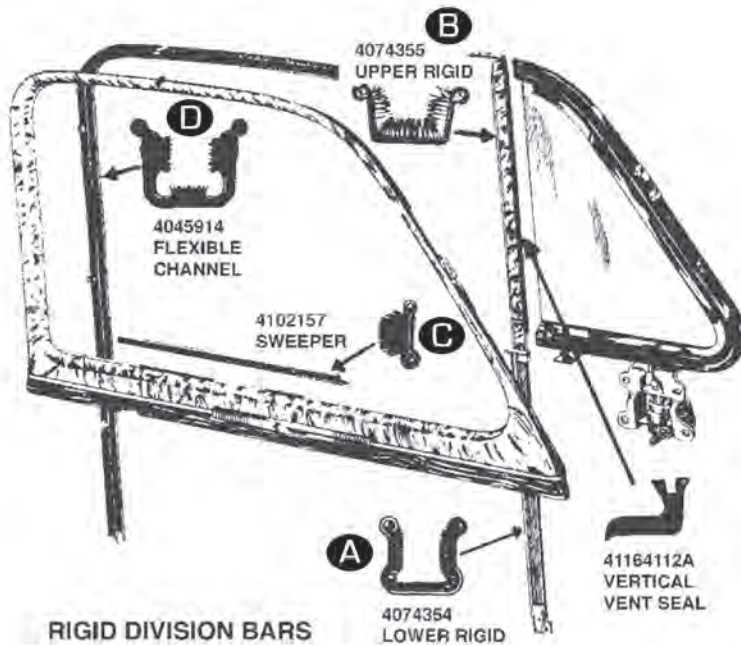

RIGID DIVISION BARS

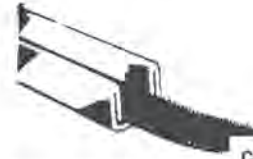

FOR RELINING PERMANENT GUIDE BARS ON A FEW CONVERTIBLES. BLACK MOHAIR LINING MATERIAL WITH RUBBERIZED BACKING TO BE CEMENTED IN PLACE.
CC 22 (1 5/8" WIDE) \$2.50 FT.

For all Nomads & Wagons

'46-'56 GLASS SETTING SEAL USED ON TL GATE ONLY.
01C201PL \$2.75 FT.



LOWER SIDE WINDOW CARRIER GLASS SETTING WITH WEATHER LIP FOR 5/8" CHANNEL DEPTH. '30-'40 CHEV. '46-'56 STATION WAGON
01A201PL \$4.00 FT.

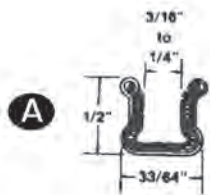

'40-'60 GM RIGID RUN CHANNEL SIDE WINDOW, LOWER
4074354-72" PC. \$28.80 EA
4074354-36" PC. \$14.40 EA

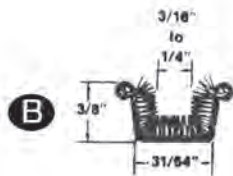

'33-'60 GM CARS RIGID DIVISION BAR WITH STAINLESS STEEL BEAD
4074355-72" PC. \$28.80 EA
4074355-36" PC. \$14.40 EA
ACTUAL SIZE



FLEXIBLE SWEEPER G.M.C. TRUCKS '46-'49 LATE 50's GM CARS STAINLESS STEEL BEAD
3684760-96" PC. \$38.40 EA
3684760-64" PC. \$25.60 EA
3684760-32" PC. \$12.80 EA



FLEXIBLE SWEEPER '33-'60 CHEV
INNER & OUTER BELT-LINE. ALSO SLIDING QTR. WINDOWS. EASILY FORMED FOR QTR.WIND.
STAINLESS STEEL BEAD
4102157-64" PC. \$25.60 EA
4102157-48" PC. \$19.20 EA
4102157-32" PC. \$12.80 EA

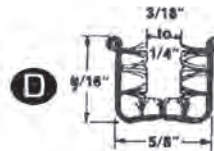

FLEXIBLE GLASS CHANNEL. MOHAIR LINED. CLOTH COVERED. STAINLESS STEEL BEADS. FITS '33-'60 GM SIDE WINDOWS.
4045914-96" PC. \$48.00 EA
4045914-60" PC. \$30.00 EA

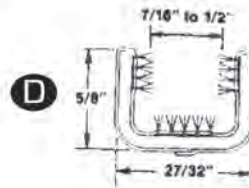

FLEXIBLE GLASS CHANNEL. MOHAIR LINING. '50-'63 CHEV & GMC TRUCKS '41-'64 GM CARS. FOR WINDOWS WITH METAL FRAMES ONLY.
3684434A-96" PC. \$49.92 EA
3684434A-60" PC. \$31.20 EA

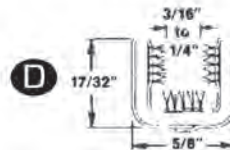

FLEXIBLE, UNBEADED PILE LINED. FITS '33-'62 CHEV & GMC PICKUPS & PANELS WITHOUT FRAMED SIDE GLASS.
598746-96" PC. \$38.40 EA
598746-60" PC. \$24.00 EA



2127 Parkerized
Door window reveal moulding fastener, corner: Chevrolet '41-'48 Special Deluxe Oldsmobile '41-'48, Model 60 Pontiac '41-'48, Models 25 and 27 \$3.00 EA

TO BE SLIPPED ON DOOR PANEL FASTENER STRIP FOR REPAIRS TO REPLACE BROKEN NAILS IN PANEL EDGING.



7/16" NAIL (.460)
ALL GENERAL MOTORS
WF18 \$1.50 (2 pcs)
"NAIL ON" DOOR PANEL REPAIR CLIPS

Providing part numbers speeds up your order, improves accuracy and helps us maintain low prices.

See Illustration Index for core charge information and a list of abbreviations. For Body Model information, see Section 5T.



Section 450T: Door Glass Channel Kits, Door Window & Related.

Format = Part No., Year, Description, Original Chevrolet Parts Book Group No., Price and Unit of Measure.

Garnish Moulding



3684481 47-50
Left side. Primered.
(16.29-15) \$73.25 EA



3684482 47-50
Right side. Primered.
(16.29-15) \$73.25 EA

Window Reveal Mouldings



3684847B 47-54
Stainless. (16.185-15) . . . \$200.00 L&R

Window Shades



987203A 51-54
Accessory. Stainless steel mounts
over door glass. (9.694-15) \$31.00 PR

Glass Channel Kit

Window Channel Kits: These are super complete and include sweepers, rigid channel, flexible channel, stops, screws, clips & rubber bumpers as needed. Complete for 2 doors.

598746B 37-46
(16.2-15) \$84.00 KIT
3684434 47-50
(16.2-15) \$94.50 KIT
3699865B 51-54
(16.2-20) \$102.00 KIT

Note: 1937-1950 Channel Kits are oversized. Special shipping rates apply, please call for rate.

Lower Glass Sash Channel

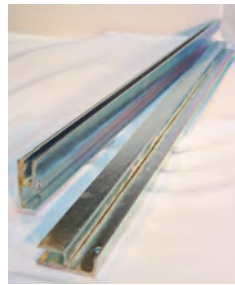

598690 36-40
As original. Left & right.
(16.19-20) \$63.00 SET

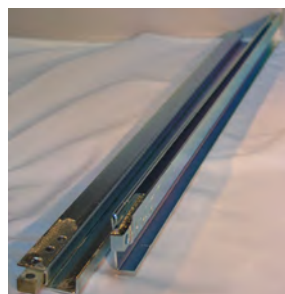

3657491 41-46
As original. Left & right.
(16.19-20) \$63.00 SET



3684169B 47-50
As original. Left & right.)
(16.19-15) \$63.00 SET

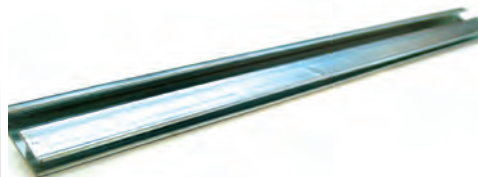

3695551 51-55
51-55 (1st Series)
(16.19-15) \$40.00 EA

Window Wiper



3847051 36-46
Inner & outer rubber
included in channel kit
(4 piece) (16.183-30) .
\$16.25 SET



3847608 47-50
Outer (rubber included
in channel kit).
(16.183-30). \$10.50 EA



3847608A 51-54
Outer (rubber included
in channel kit).
(16.183-30)
\$12.50 SET

Adhesives & Sealers



986199A
3M Contact cement for
rubber to metal. Bonds
instantly. Industrial
quality for gravel
guards, running board
rubber, etc. (8.8-15) . .

\$40.00 QT

Channel Kit Components

3684760 All
Sweeper - wide w/ stainless steel bead
sold by the inch (20-30) . . . \$0.50 IN
3695445 51-54
Rigid channel, goes on rear of vent
window sold by the inch (20-15)
\$11.75 EA
4045914 All
Flex channel with stainless steel bead
(21.998-20) \$49.00 EA
598746 36-46
Flex channel cloth covered sold by the
inch (21.998-20) \$35.25 EA
3684434A 47-50
Flex channel cloth covered sold by the
inch (20-20) \$47.75 EA
4131052 47-54
Window Stop Bumper
(10.716-30) . \$3.50 PR



Returns require a return authorization number, Please call.

Section 450T: Door Glass Channel Kits, Door Window & Related



Format = Part No., Year, Description, Original Chevrolet Parts Book Group No., Price and Unit of Measure.

Weatherstrip Cement

511114
Black weatherstrip
cement, 5-oz tube.
Superior product!. (8.8-0) . . \$12.75 EA

Adhesives

306105
Krazy Glue. Rubber
to metal & rubber to
rubber bonding. Splice window gaskets
& sponge weather strip & more. (8.8-15)
\$3.00 EA

Adhesives & Sealers

GL14
Windshield sealer.
Seals leaks in new &
old installation. Will
not dry out. (Adhesives & Sealers-15) . .
\$7.00 EA

Division Bar

3695498A 51-54
Rigid channel front of door glass.
(16.175-20) \$25.25 PR

Channel (Guide)

3721781A 51-54
W/ brackets, lower rear door glass.
(16.19-20) \$36.00 PR

Setting Tape Door Glass



60395440 37-40
Setting tape for 2 doors (120in.
length). (10.696-20) \$9.25 SET
60395450 41-50
Setting tape for 2 doors (168in. length).
(10.696-20) \$12.75 SET
60395454 51-54
Setting tape for 2 doors (90in. length).
(10.696-20) \$7.00 SET

Window Stop Bumper



3681072 36-46
(16.245-15) . \$3.00 PR

Screws & Sleeve Nuts



3694071 47-50
Attaches upper and
lower door frame
glass. (16.19-15)
\$5.00 SET

Odds & Ends

*Please call for availability on all Odds
& Ends parts; once part is sold, it may
no longer be in stock.*
3657495U 41-46
Frame Door Window Glass (32*000-0).
\$50.00 EA
3684847 47-53
Reveal door mouldings, left (Used)
(16.181-40) \$75.00 EA
3809865 47-50
Window channel retainer, left rear
(32*000-0) \$15.00 EA



Section 460T: Window Crank, Window Regulator & Power Window Kits

Format = Part No., Year, Description, Original Chevrolet Parts Book Group No., Price and Unit of Measure.

Window Regulator

- 594279A 36-46
Repair kit. Left or right side. Includes rivets & spring inside cup. (16.26-0) . \$20.00 KIT
- 3676433A 47-50
Repair kit. Left or right side. Includes rivets & spring inside cup. (-15) \$20.00 KIT

Power Window Conversion -Gear Driven Bolt In

These kits directly bolt into original mounting holes. 1018 cold rolled steel, brass oilite thrust bearings, Delco OEM Motors and gear teeth cryogenically treated for long life. Includes Delco OEM Chrome or Illuminated switches and conduit for wiring. Comes with a lifetime warranty.

- 3684175 36-46
Complete kit with chrome or black switches. (16.18-15) \$465.00 EA
- 3684176 47-50
Complete kit with chrome or black switches. (16.18-15) \$465.00 EA
- 3684177 51-54
Complete kit with chrome or black switches. (16.18-0) \$420.00 EA

Power Window Conversion -Cable Driven

These kits come complete with two cable drive regulators. Uses heavy duty OEM style motors (switches & harness sold separately)



- 3684163 36-46
Trucks WITH vent window. Does NOT include switches or wiring harness (sold separately). (16.8-15) \$360.00 PR

- 3684164A 47-50
Trucks WITHOUT vent window. Does NOT include switches or wiring harness (sold separately). (16.18-15) \$360.00 PR
- 3684164 51-54
Trucks WITH vent window. Does NOT include switches or wiring harness (sold separately). (16.18-15) \$360.00 PR

Power Window Conversion

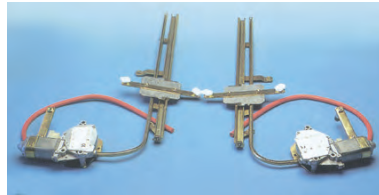

- 477024 37-46
Complete kit for 2 doors. Requires some modification to fit. (16.18-15) \$433.25 SET

Window Crank Switch

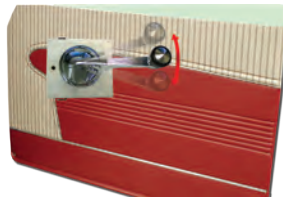

- EWS
Eliminate unsightly generic power switches. Operate your electric windows with a stock window crank by simply rotating the crank up or down 15 degrees! Tough, durable switch allows you to retain a stock look without having to modify or create a location for a new set of switches. Choose window cranks in the Restoration area of this section. (10.797-15) \$99.00 EA

Window Regulator



- 3676433 47-50
Complete with arms. Left. (16.26-20) \$77.50 EA
- 3676434 47-50
Complete with arms. Right. (16.26-20) \$77.50 EA

- 3695521 51-54
Complete with arms. Left. (16.26-20) . . \$85.00 EA
- 3695522 51-54
Complete with arms. Right. (16.26-20) . \$85.00 EA



- 3695521A 47-54
Spring. (16.26-15) . . . \$4.75 EA

Knob

- 598910A 39
Window or windshield crank. Black. (16.27-15) \$11.00 EA
- 3654632B 40-46
Window or windshield crank. Rose tan. (16.27-15) . \$11.00 EA
- 3683723A 47-50
Window crank, chrome. (16.27-15) . . \$11.00 EA
- 3702614D 51-53
Window crank, maroon. (16.27-15) . . \$11.00 EA
- 3702164A 54-57
Window crank, black. (16.27-30) . . \$9.00 EA

Window Crank



- 598910 39
With black knob. (16.27-15) \$38.50 EA



- 3654632A 40-46
With rose tan knob. (16.27-15) \$37.00 EA

Returns require a return authorization number, Please call.



3702164B 47-60
W/ replacement black knob.
(16.27-30) \$12.25 EA



3683723 47-50
W/ chrome knob.
(16.27-30) \$29.25 EA



3699345 51-53
W/ maroon knob.
(16.27-20) \$25.50 EA



3702164 54-57
W/ black knob. (16.27-30) . . \$16.50 EA

Odds & Ends

Please call for availability on all Odds & Ends parts; once part is sold, it may no longer be in stock.

- 3676433N 47-50
Regulator NOS Left (32*000-0)
\$100.00 EA
- 594280U 36-46
Regulator, door glass, right (32*000-0)
\$65.00 EA
- 3676433U 47-50
Regulator, Door Window Left (Used)
(32*000-0) \$65.00 EA
- 3702164BU 47-60
Window crank (Used) (16.2-0) \$6.00 EA
- 3654632U 39-46
Window crank w/ ivory knob (Used)
(16.27-40) \$15.00 EA
- 598800U 41-46
Windshield pillar covers (Used)
(16.563-0) \$15.00 PR



Section 470T: Suburban Quarter Window Rubber & Related

Format = Part No., Year, Description, Original Chevrolet Parts Book Group No., Price and Unit of Measure.

Rectangular Retaining Rubber



4070069 47-54
For quarter window, Suburban (does
two windows) (17.136-0) . . . \$46.00 PR

Channel Kit

4070069C 47-54
W/ quarter window rubber (#4070069).
Fits Suburban. Complete for two
windows (17.136-15) \$99.00 SET

Returns require a return authorization number, Please call.

Section 480T: Rear Window Rubber & Sliding Back Glass



Format = Part No., Year, Description, Original Chevrolet Parts Book Group No., Price and Unit of Measure.

Back Glass & Frame

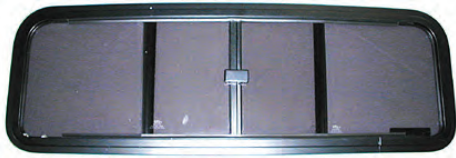

3704319C 47-54
Slider, with snap closer (tinted). Black frame. (16.464-15) \$185.50 EA



3847421 36-38
Low roof cab, vulcanized (16.47-15) \$73.00 EA

599701 36-42
For die cast frame (16.47-30) \$32.25 EA

3847420 39-42
Vulcanized, for die cast frame (16.47-40) \$37.00 EA

3847419 42-46
With lock strip (16.47-30) . \$18.75 SET

3847418 42-46
W/ chrome lock strip (16.47-30) \$18.75 SET

3847417 47-54
W/ lock strip (16.47-20) . . . \$15.00 SET

3847416 47-54
W/ chrome lock strip (16.47-15) \$15.00 SET

Back Glass Rubber

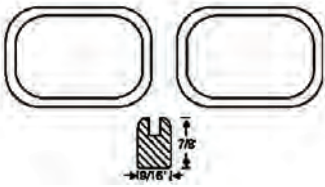

463535 34-38
Panel & Suburban, vulcanized (16.47-15) \$80.50 PR

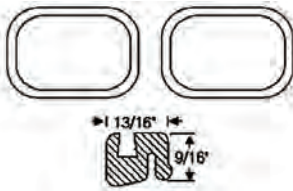

3806252 39-46
Panel & Suburban, vulcanized (16.47-15) \$80.50 PR

3807535A 47-57
Panel & Suburban w/ doors (16.47-20) \$34.00 PR

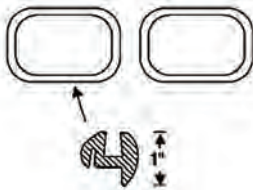

3807535 47-57
Panel & Suburban w/ doors, vulcanized (16.47-15) \$80.50 PR

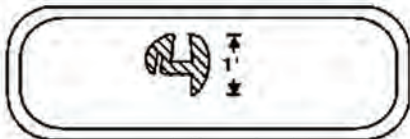

3807917 47-54
Panel & Suburban w/ end gate, vulcanized (16.47-15) \$73.00 EA

Chrome Lock Strip



3847415A 42-54
Back glass (7 ft) (16.469-40) \$12.00 EA

3847415B 47-54
Corner glass (8ft.-6in.) (16.469-40) . . . \$12.00 PR

Tool



3847415T 42-54
Inserts back glass rubber lock strip. (16.469-15) \$24.75 EA

Screw Set



3667020B 37-41
Back glass frame (clutch head). (16.475-15) \$6.75 SET

Rear Corner Glass Rubber



3847415 47-54
W/ lock strip (16.47-20) . . . \$15.00 PR



3847414 47-54
W/ chrome lock strip (16.47-15) \$15.00 PR

Providing part numbers speeds up your order, improves accuracy and helps us maintain low prices.

See Illustration Index for core charge information and a list of abbreviations. For Body Model information, see Section 5T.



Section T:

Format = Part No., Year, Description, Original Chevrolet Parts Book Group No., Price and Unit of Measure.

ADD COLOR AND STYLE TO YOUR TRUCK BED WITH EXOTIC AND DOMESTIC BED WOODS!!

- Kiln Dried and Stabilized, Properly Milled, Sanded, and Ready to Finish.
- Sets are milled to order using only kiln dried "better than cabinet grade" lumber to assure you receive only the highest quality product. All pieces are 3/4" thick, grooved and trimmed to length. Sanded using a multiple-step process providing a uniform and extremely smooth surface, ready to finish right out of the box (does not come stained or with final finish).
- Boards individually numbered for ease of installation and chosen & matched based on color, character and grain.
- Grooves available to fit both OEM and custom-style bed strips at no extra charge.
- Custom widths & lengths are available to meet your specific requirements. Professional packaging to minimize potential damage during shipping. Many other types of woods available.



Additional wood types available

part #	Short Beds	\$ starting at
BWP101	1937-39 CHEVY SHORT BED STEP SIDE W/ 6 BOARDS, 75-7/8"	\$330 SET
BWP102	1940-45 CHEVY SHORT BED STEP SIDE W/ 6 BOARDS, 76-7/8"	\$330 SET
BWP103	1946 CHEVY SHORT BED STEP SIDE W/ 7 BOARDS, 76-7/8"	\$330 SET
BWP104	1947-51 CHEVY SHORT BED STEP SIDE W/ 9 BOARDS, 76-7/8"	\$330 SET
BWP105	1951-1954 CHEVY SHORT BED STEP SIDE W/ 8 BOARDS, 77-1/8"	\$330 SET
part #	Long Beds	\$ starting at
BWP109	1937-45 CHEVY LONG BED STEP SIDE W/ 6 BOARDS, 85-7/8"	\$370 SET
BWP111	1946 CHEVY LONG BED STEP SIDE W/ 7 BOARDS, 85-7/8"	\$370 SET
BWP112	1947-51 CHEVY LONG BED STEP SIDE W/ 9 BOARDS, 85-13/16"	\$370 SET
BWP113	1951-1953 CHEVY LONG BED STEP SIDE W/ 8 BOARDS, 85-13/16"	\$370 SET
BWP114	1954 CHEVY LONG BED STEP SIDE W/ 8 BOARDS, 89"	\$370 SET
part #	1 Ton	\$ starting at
BWP118	1947-51 1-TON CHEVY LONG BED STEP SIDE W/ 8 BOARDS, 107"	\$400 SET
BWP119	1952-54 1-TON CHEVY LONG BED STEP SIDE W/ 8 BOARDS, 107"	\$400 SET



Oversize shipping charges apply

Returns require a return authorization number, Please call.

Section 490T: Complete Bed & Bed Parts

Format = Part No., Year, Description, Original Chevrolet Parts Book Group No., Price and Unit of Measure.



Pros Pick Custom Bed - Chevy

FABRICATED FROM 16 GAUGE, SATIN COATED STEEL (SIMILAR TO GALVANIZED)

- Plug welded construction (no unsightly spot welds).
- Epoxy primed so you can block sand and paint.
- Includes 2 sides, closed stake pockets, front panel and all cross members.
- *TAILGATE, BED STRIPS AND WOOD NOT INCLUDED.**



*54-'55 (1st Series) Chevy Truck shown

25230100	30-36	Standard bed size and height.
(20-0)		\$1,475.00 SET
25237100	37-39	Standard bed size and height.
(20-0)		\$1,475.00 SET
24240100	40-46	Standard bed size and height.
(20-0)		\$1,475.00 EA
25247100	47-53	Standard bed size and height.
(20-0.15)		\$1,475.00 EA
25247T100	47-53	3 inch taller height than standard.
(20-0.15)		\$1,620.00 EA
25254100	54-55	Standard bed size and height. Fits 1st Series.
(20-0)		\$1,620.00 SET

Pros Pick Custom Roll Pan - Chevy



23247100	47-53	Bolt-on, smooth. 1-piece, 12ga. steel. Recess for license plate. Use with Pro's Pick tailgate only (order 4-piece roll pan for stock tailgates).
(-0.15)		\$450.00 EA

Fuel Filler Concealment Kit



LHR5CK
Hide your fill neck in the bed. Motor lifts a bed wood panel for easy access. All stainless & aluminum hardware, hinges, motor & switch included. (17.438-0) \$575.00 SET

Bed Lids

Standard Features and Benefits

- Resin filled composite honeycomb give a durable, long lasting construction.
- Built in stainless steel cross bar hinge is laminated into the truck lid giving our hinge system strength and durability.
- 2 double stage locking system for extra security.
- Dual heavy duty gas struts are mounted to assist in opening & closing the lid.
- Double weather seal helps protect cargo from the elements.
- Neoprene inside trim seal helps protect bed rail from excessive wear and tear.
- Nylon pull strap to assist in closing.

Their classic lids are made out of composite fiberglass to last the test of time just like your classic truck.

- Reduces wind drag and saves fuel.
- Easy to install or remove.
- Proven, tight fit.
- Black, white or primered finish.

***OPTION: Under the lid charcoal carpeting tops the interior of our Traditional Lids giving it a plush look and feel.**

BEDLID-TPC	47-53	Primered finish. With carpet under lid.
(17.499-0.15)		\$1,123.25 EA
BEDLID-TPC	54	Primered finish. With carpet under lid.
(17.499-0.15)		\$1,123.25 EA

BEDLID-BPC	54	Primered finish. With carpet under lid.
(17.499-0.15)		\$1,405.75 EA

Tailgate - Custom

Stock tailgates have exposed hinges that leak rusty water, chains that damage expensive paint and unsightly, poorly designed latches. These custom tailgates are manufactured from 16 gauge, satin coated steel. Hidden hinges concealed into the rear cross member. Hidden latch assemblies actuated by 2 small knobs on the inside of the tailgate. Nylon latch bolts and stainless steel strikers assure smooth, quiet and rust free operation. Mounts to Pro's Pick Custom Beds as well as Stock Beds to add a clean custom look to your original bed.



TAILGATEPROW		Smooth, clean finish. Fits pro's pick and other stock beds.
(-0.2)		\$930.00 EA

Power Tailgate Lift Kit



TG-1		Open and close your tailgate at the touch of a button. Tough universal brackets and a heavy duty screw-type linear actuator provides up to 250 lb lifting capacity for the heaviest of tailgates.
(17.6-0)		\$370.00 KIT

Tailgate Hinges



CH-4053-P	41-53	Original style. Polished stainless steel
(17.625-0.15)		\$100.00 PR

Providing part numbers speeds up your order, improves accuracy and helps us maintain low prices.

See Illustration Index for core charge information and a list of abbreviations. For Body Model information, see Section 5T.



Section 490T: Complete Bed & Bed Parts

Format = Part No., Year, Description, Original Chevrolet Parts Book Group No., Price and Unit of Measure.



CH-4053-PC 41-53
Angle cut polished stainless steel.
(17.625-0.15) \$121.75 PR

Tailgate Hinge Adapter



SLEEVEN 40
Nylon adapter for
use on 41-53 tailgate
hinges to mount 1940
tailgate (1940 larger
than 41-53 hinges).

(17.625-0) \$30.00 PR

Tailgate - Hidden Latch



CL-24EX 47-53
24" cable. Polished stainless
steel latch and anchor.
(17.625-0.15) \$169.50 SET
CL-19-SW 37-46
19-1/2" cable. Polished stainless steel
latch and anchor.
(17.625-0.15) \$169.50 SET

Stock tailgates are "beautiful", they hold the classic look that is near and dear to all enthusiasts. They also carry those tailgate chains that ruin our \$10,000 paint jobs.

When Pros Pick designed this kit they felt the criteria had to be:

- *Anyone could handle the installation.*
- *The tailgate had to slam shut.*
- *No rattles allowed as you drive down the road.*
- *None of the materials used could ever rust.*
- *It had to have check straps that could not damage the paint.*
- *You could install it on a painted bed without damaging the paint job.*
- *It had to look cool, yet be compatible with the vintage look of the truck.*
- *A touch of the release buttons on each side allow the gate to open.*



26300016
Latch kit with 16 inch straps.
(-0.15) \$185.00 SET
26300021
Latch kit with 21 inch straps.
(-0.15) \$185.00 SET

Tailgate Link Assembly



MAK102835 41-53
Remove tailgate chains (modification to bed sides required). Includes instructions. (-0.15) \$75.00 PR

LED Bed Roll Light



MAK102864
Red LEDs. Billet aluminum w/ polished bezel. Dual intensity for tail light and brake/ turn signal. Includes 10" pigtail. Fits 40-66 Chevy, 40-87 GMC. (0-0.15) \$110.00 PR



MAK102865
Amber LEDs. (0-0.15) . . . \$110.00 PR



MAK102866
White LEDs for back up lights.
(0-0.15) \$120.00 PR



LEDBEDLITE
Aluminum housing in 15/16" (red only), 1-1/8", 1-1/4" or 1-5/8" diameters. Choose Amber or Red.
(0-0) \$110.00 PR

Tail light - Truck Bed



MAK102853 41-66
Red. Incandescent bulb (amber also available). (0-0) \$60.00 PR

Returns require a return authorization number, Please call.

Section 490T: Complete Bed & Bed Parts



Format = Part No., Year, Description, Original Chevrolet Parts Book Group No., Price and Unit of Measure.

Bed Roll Reflector



MAK102850 . . .41-66
red insert reflector.
(0-0.15) . . . \$35.25 PR

Stake Pocket Hole Covers



MAK2001190
Paintable steel top, stainless
base (2 pairs needed per bed).
(-0.15) \$15.00 PR

Billet Caps



466423B.37-39
1-1/4in. polished
aluminum w/ bowtie,
covers hole top rear of
bedside. (17.505-0.15)
\$35.00 PR



3806518B. . . .41-55
1-19/32in. polished
aluminum w/ bowtie,
covers hole top rear of
bedside. (17.505-0.15)
\$35.00 PR



3806518C. . . .41-55
1-19/32in. brushed
aluminum, covers hole
top rear of bedside.
(17.505-0.15)

Providing part numbers speeds up your order, improves accuracy and helps us maintain low prices.

See Illustration Index for core charge information and a list of abbreviations. For Body Model information, see Section 5T.



Section 490T: Complete Bed & Bed Parts

Format = Part No., Year, Description, Original Chevrolet Parts Book Group No., Price and Unit of Measure.

Qty Pcs./Sets	Year 19____	1/2 Ton or 3/4 Ton Description	Amount	
			Unit Price	Total
		Complete bed (1/2T) unassembled		
		Complete bed (3/4T) unassembled		
		Complete bed (1/2T) assembled		
		Complete bed (3/4T) assembled		
		Choices:		
		Stake pockets on bedside top flange:		
		with open stake pockets	N/C	
		with closed stake pockets	N/C	
		Tailgate:		
		with script	N/C	
		without script	N/C	
		Upgrades:		
		Welded stake pockets and corner strips to side panels (1/2T) upgrade for unassembled bed kits		
		Welded stake pockets and corner strips to side panels (3/4T) upgrade for unassembled bed kits		
		Tailgate chains—Upgrade to stainless		
		Bed strips—Unpolished stainless steel 1/2T		
		Bed strips—Unpolished stainless steel 3/4T		
		Bed strips—Aluminum with hidden fastener 1/2T (Upgrade for unassembled bed kit 1941–55 only)		
		Bed strips—Aluminum with hidden fastener 3/4T (Upgrade for unassembled bed kit 1941–55 only)		
		Holes prepunched in bed and corner strips 1/2T (Upgrade for unassembled bed kits)		
		Holes prepunched in bed and corner strips 3/4T (Upgrade for unassembled bed kits)		
		Bed to frame hold down bolt kit		
		Special handling/Crate fee/Skid		
			Total:	
Ship to:				
Name:			Home phone:	
Street:			Work phone:	
City:	State:	Zip:	Email address:	

Returns require a return authorization number, Please call.

Section 490T: Complete Bed & Bed Parts

Format = Part No., Year, Description, Original Chevrolet Parts Book Group No., Price and Unit of Measure.



Complete Bed - Assembled

Complete beds include: Front Bed Panel, Bed Side Panels, Stake Pockets, Oak Bed Wood, Steel Bed & Corner Strips, Bed Wood Bolt Kit, Cross Sills, Tailgate, Tailgate Hinges & Tailgate Chain.

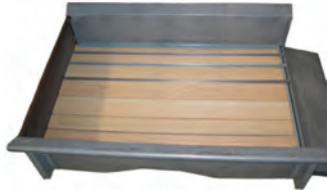

3690611 37-53
1/2T assembled (specify year when ordering). (20-0) \$1,650.00 EA

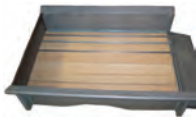

3690611B . . . 37-53
3/4T assembled (specify year when ordering). (20-0.15) . . . \$1,850.00 EA



3690611B55 . 54-55
3/4T assembled. (0-0.15) \$2,494.00 EA

Shown painted for display purposes

Complete Bed - Unassembled

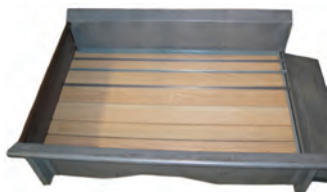

3690610 37-53
1/2T unassembled (specify year when ordering). (20-0) \$1,399.00 EA



369061055 . . . 54-55
1/2T unassembled. (0-0.15) \$1,910.00 EA

Shown painted for display purposes

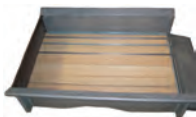

3690610B . . . 37-53
3/4T unassembled (specify year when ordering). (20-0) . . . \$1,470.00 EA



3690610B55 . 54-55
3/4T unassembled. (0-0.15) \$2,243.00 EA

Shown painted for display purposes

Note: Complete Beds are sent Freight Collect. \$75 Crate charge per Complete Bed. (Specify with or without stake pockets holes and fender bolt holes.)

Note: Stainless Corner Strips are difficult to weld and are not recommended by manufacturing company.

Complete Bed Options

3690600H 37-55
Stake pocket holes in top flange of bed side. (17.438-0) \$0.00
3690600NH 37-55
No stake pocket holes in top flange of bed side. (17.462-0) \$0.00 EA

Complete Bed Upgrades

The following items are available as upgrades for the Complete Bed Kits.

Complete Bed Upgrade (Weld Stake Pockets)

3690610W 37-54
Brackets, weld stake pockets & angle strips to side panels (1/2T), an upgrade for unassembled bed kits. (17.438-0.2) \$95.00 SET

3690610BW 37-54
Brackets, weld stake pockets & angle strips to side panel (3/4T), an upgrade for unassembled bed kits. (17.438-0.15) \$114.50 SET

Complete Bed Upgrade (Chains)

3801845SU . . 32-53
Tailgate chains, upgrade to stainless. (17.635-0.15)

3810823SU . . 54-60
Tailgate chains, upgrade to stainless. (17.635-0.15)

Complete Bed Upgrade (Bed Strips)

3690609S 37-54
Strips, unpolished stainless steel, w/ polished bolt heads, 1/2T. (17.438-0.15) \$119.00 SET

3690609BS 37-54
Strips, unpolished stainless steel, w/ polished bolt heads, 3/4T. (17.438-0.4) \$126.00 SET

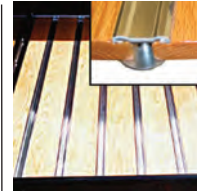

384734S 37-59
ALUMINUM strips with hidden fasteners, 1/2T. (17.438-0) \$175.00 SET

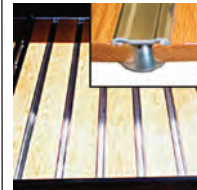

384734BS . . . 37-59
Strips, aluminum with hidden fasteners, 3/4T. (17.438-0) \$245.00 SET

Complete Bed Upgrade (Holes Punched)

3690610P 37-55
Holes pre-punched in bed strips & corner strips, 1/2T. (17.438-0) \$24.00 EA

3690610BP 37-55
Holes pre-punched in bed strips & corner strips, 3/4T. (17.438-0.15) \$34.00 EA

Complete Bed Upgrade (Bolt Kit)

Note: Bed to frame bolt kits are only available with complete bed kits.

Note: All our Stainless bolt kits are all Stainless!!



1937-39 Shown

3690601 37-55
Bed to frame bolt kit, STEEL. 1/2T. (17.447-0) \$24.00 SET

3690602S 37-55
Bed to frame bolt kit, UNPOLISHED STAINLESS STEEL HEADS. 1/2T. (17.447-0) \$34.00 SET



1954-55 Shown

3690603P 37-55
Bed to frame bolt kit, POLISHED STAINLESS STEEL HEADS. 1/2T. (17.447-0) \$46.00 SET

Providing part numbers speeds up your order, improves accuracy and helps us maintain low prices.

See Illustration Index for core charge information and a list of abbreviations. For Body Model information, see Section 5T.



Section 490T: Complete Bed & Bed Parts

Format = Part No., Year, Description, Original Chevrolet Parts Book Group No., Price and Unit of Measure.

- 3690607A 37-55
Bed to frame bolt kit, ZINC. Used with Aluminum bed strips. 1/2T. (17.447-0) . \$27.00 SET
- 3690604 37-55
Bed to frame bolt kit, STEEL. 3/4T. (17.447-0). \$24.00 SET
- 3690605S 37-55
Bed to frame bolt kit, UNPOLISHED STAINLESS STEEL. 3/4T. (17.447-0) . \$34.00 SET
- 3690606P 37-55
Bed to frame bolt kit, POLISHED STAINLESS STEEL HEAD. 3/4T. (17.447-0). \$46.00 SET
- 3690608A 37-55
Bed to frame bolt kit, ZINC. Used with Aluminum bed strips. 3/4T (17.447-0) \$29.00 SET

Front Bed Panel



- 463673 34-40
W/ out hardware, 1/2T & 37-39 3/4 & 1T, 45-3/4in. wide. (20.455-0.15) \$110.00 EA
- 3800261T45 40-45
W/ hardware, 48-1/2in. wide (for 5 bed strips) (20.455-0.15). \$100.00 EA
- 3800261T46 46
W/ hardware, 48-1/2in. wide (for 6 bed strips) (20.455-0.15). \$100.00 EA
- 3810042 47-53
W/ hardware, 50in. wide (1/2T & 3/4T) (20.455-0.15). \$100.00 EA
- 3810042T50 47-50
W/ hardware (1T) (20.455-0.15). \$135.00 EA
- 3810042T53 51-53
W/ hardware (1T) (20.455-0.15). \$135.00 EA
- 3810404 54
W/ hardware (20.455-0.15). \$100.00 EA

Note: Oversize shipping charges apply on all Front Bed Panels. Please call for rates.

Bed Side Panel

Note: Bed Side Panels are sent Freight Collect. \$75 Crate charge per pair. (Specify with or without stake pockets holes.)

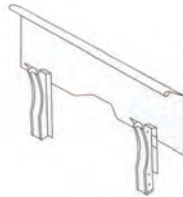

- 46642339 37-39
1/2T w/ stake pocket & bed corner strip, left (20.455-0) \$320.00 EA
- 46642439 37-39
1/2T w/ stake pocket & bed corner strip, right (20.455-0) \$320.00 EA
- 46642340 40
1/2T w/ stake pocket & bed corner strip, left (20.455-0) \$320.00 EA
- 46642440 40
1/2T w/ stake pocket & bed corner strip, right (20.455-0) \$320.00 EA
- 380685746 41-46
1/2T w/ stake pocket & bed corner strip, left (20.455-0.15). \$310.00 EA
- 380685846 41-46
1/2T w/ stake pocket & bed corner strip, right (17.505-0.15). \$310.00 EA
- 380685753 47-53
1/2T w/ stake pocket & bed corner strip, left (17.505-0.15). \$295.00 EA
- 380685853 47-53
1/2T w/ stake pocket & bed corner strip, right (17.505-0.15). \$295.00 EA
- 380651753 41-53
3/4T w/ stake pocket & bed corner strips, left (20.455-0.15). \$415.00 EA
- 380651853 41-53
3/4T w/ stake pocket & bed corner strips, right (20.455-0.15). \$415.00 EA
- 381042954 54
1/2T w/ stake pocket & bed corner strips, left (20.455-0.15). \$370.00 EA

- 381043054 54
1/2T w/ stake pocket & bed corner strips, right (17.615-0.15). \$370.00 EA
- 381251354 54
3/4T w/ stake pocket & bed corner strips, left (17.505-0.15). \$495.00 EA
- 381251454 54
3/4T w/ stake pocket & bed corner strips, right (17.505-0.15). \$495.00 EA

Stake Pockets



- 466423F 34-38
Front (17.462-0.15) \$40.00 EA
- 466423L 34-38
Left rear (17.462-0.15). \$40.00 EA
- 466424R 34-38
Right rear (17.462-0.15). \$40.00 EA
- 3806857F 39-53
Front (specify left or right) (17.462-0.15). \$40.00 EA
- 3806857L 39-53
Left rear (17.462-0.15). \$40.00 EA
- 3806858R 39-53
Right rear (17.462-0.15). \$40.00 EA
- 3810428F 54-59
Front (specify left or right). (17.462-0.15). \$58.50 EA
- 3810429L 54-59
Left rear (17.462-0.15). \$60.00 EA
- 3810430R 54-59
Right rear (17.462-0.15). \$60.00 EA

Bed Strips

- 3847634 All
Short (78in.), steel, 1/2T, no holes. (17.438-0.15) \$9.00 EA
- 3847634S All
Short (78in.), stainless, 1/2T, no holes. (17.438-0.15). \$14.25 EA

Returns require a return authorization number, Please call.

Section 490T: Complete Bed & Bed Parts



Format = Part No., Year, Description, Original Chevrolet Parts Book Group No., Price and Unit of Measure.

3847634SP All Short (78in.), polished stainless, 1/2T, no holes. (17.438-0.15) . . . \$17.00 EA
 3847634P 37-59 Short (74in.-78in.) w/ pre-punched square holes. steel, 1/2T, specify year when ordering. (20.438-0.2) . \$9.00 EA
 3847634X 37-59 Short (74in.-78in.) w/ pre-punched square holes. stainless steel, 1/2T, specify year when ordering. (17.438-0) \$14.00 EA
 3847634Y 37-59 Short (74in.-78in.) w/ pre-punched square holes. polished stainless, 1/2T, specify year when ordering. (17.438-0) \$20.00 EA

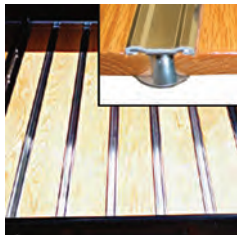

3847634A 37-59 Short (74in.-78in.) aluminum w/ hidden fasteners included (anodized bolt heads hide below strip. Strip end has a blunt finish). Specify year when ordering. (17.438-0) \$30.00 EA
 3847635 All Long (96in.), steel, no holes. (17.438-0.15) \$10.00 EA
 3847635S All Long (79in.-96in.), stainless, no holes. (17.438-0.15) \$19.50 EA
 3847635SP All Long (79in.-96in.), polished stainless, no holes. (17.438-0.15) . . . \$19.50 EA
 3847635P 37-59 Long (79in.-96in.), w/ pre-punched square holes. steel, specify year when ordering. (17.438-0.15) . . . \$9.50 EA
 3847635X 37-59 Long (79in.-96in.), w/ pre-punched square holes. stainless, specify year when ordering. (17.438-0) . \$16.50 EA
 3847635Y 37-59 Long (79in.-96in.), w/ pre-punched square holes. polished stainless, specify year when ordering. (17.438-0) \$24.50 EA

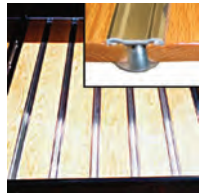

3847635A . . . 37-59 Long (79in.-96in.), aluminum, w/ hidden fastener bolts for hidden fastening included, specify year when ordering. (17.438-0) \$35.00 EA

Note: Bed Strips over 96 inches are available. Special order, call for price.

Note: Oversize shipping charges apply on Bed Strips. Call for rates. Bed Strips over 96 inches are sent freight collect.

Corner Strips

3810803 All Short bed (78in.). Steel, 1/2T, no holes. (17.438-0.15) \$30.00 L&R
 3810803S All Short bed (77-1/8in.). Stainless, 1/2T, no holes. (17.438-0.2) \$60.00 EA
 3810803P 37-59 Short bed (74in.-78in.) w/ pre-punched square holes. steel, 1/2T, specify year when ordering. (17.438-0.4) \$30.00 PR
 3810803X 37-59 Short bed (74in.-78in.) w/ pre-punched square holes. stainless, 1/2T, specify year when ordering. (17.438-0.15) . . . \$50.00 PR
 3810803Y 37-59 Short bed (74in.-78in.), w/ pre-punched square holes. polished stainless, 1/2T, specify year when ordering. (17.438-0.4) \$60.00 PR
 3810804P 37-59 Long bed (74in.-78in.) w/ pre-punched square holes. steel, specify year when ordering. (17.438-0.4) \$36.00 PR
 3810804 All Long bed (79in.-96in.). Steel, no holes. (17.438-0.15) \$15.00 EA
 3810804T All Long bed (79in.-96in.), stainless steel, no holes. (17.438-0.15) . . \$56.00 SET
 3847637SP All Long bed (79in.-96in.), polished stainless steel, no holes. (17.438-0.15) \$56.00 PR
 3810804X 37-59 Long bed (79in.-96in.) w/ pre-punched square holes. stainless, specify year when ordering. (17.438-0.3) . \$56.00 PR

3847636Y 37-59 Long bed (79in.-96in.) w/ pre-punched square holes. polished stainless, specify year when ordering. (17.438-0.4) \$74.00 PR

Note: Corner Strips over 96 inches are available. Special order, call for price.

Note: Oversize shipping charges apply on Corner Strips. Call for rates. Corner Strips over 96 inches are sent freight collect.

Custom Bed Wood

Note: We now offer a Variety of Custom Bed Woods for your truck. See the beginning of this section for details and pricing.

Bed Wood

Note: Oversize shipping charges apply on all Bed Wood. Call for rates.

38474030 37-59 OAK. Sized & grooved, 1/2T. NO HOLES (specify year when ordering). (20.438-0) \$320.00 SET
 3847403OH 40-59 OAK. Sized & grooved, 1/2T. IWTH MOUNTING HOLES (specify year when ordering). (17.438-0) \$348.00 SET
 38474040 37-59 OAK. Sized & grooved, 3/4T. NO HOLES (specify year when ordering). (17.438-0) \$285.00 SET
 3847404OH 40-59 OAK. Sized & grooved, 3/4T. WITH MOUNTING HOLES (specify year when ordering). (17.438-0) \$380.00 SET
 3847403P . . . 37-59 PINE. Sized & grooved, 1/2T. NO HOLES (specify year when ordering). (17.438-0) \$185.00 SET
 3847403PH 40-59 PINE. Sized & grooved, 1/2T. WITH MOUNTING HOLES (specify year when ordering). (17.438-0) \$215.00 SET
 3847404P 37-59 PINE. Sized & grooved, 3/4T. NO HOLES. (specify year when ordering). (17.438-0) \$210.00 SET

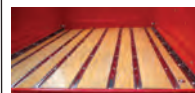

490T

Providing part numbers speeds up your order, improves accuracy and helps us maintain low prices.

See Illustration Index for core charge information and a list of abbreviations. For Body Model information, see Section 5T.



Section 490T: Complete Bed & Bed Parts

Format = Part No., Year, Description, Original Chevrolet Parts Book Group No., Price and Unit of Measure.

3847404PH 40-59
PINE. Sized & grooved, 3/4T. WITH
MOUNTING HOLES (specify year when
ordering).
(17.438-0) \$240.00 SET

Bed Wood -GMC

3847405O 37-39
OAK. Sized & grooved, GMC long
bed. NO HOLES (specify year when
ordering). (17.438-0) . . . \$350.00 SET
3847405OH 37-55
OAK. Sized & grooved, GMC long bed.
WITH MOUNTING HOLES (specify
year when ordering). (17.438-0)
\$380.00 SET

3847405P 37-39
PINE. Sized & grooved, GMC long
bed. NO HOLES (specify year when
ordering). (17.438-0) . . . \$240.00 SET
3847405PH 37-55
PINE. Sized & grooved, GMC long bed.
WITH MOUNTING HOLES (specify
year when ordering). (17.438-0)
\$265.00 SET

Bed Wood Washer



458394W All
Offset square hole, 1/2T (6 piece)
(17.447-0.15) \$6.75 SET
458394WS All
Offset square hole, stainless steel, 1/2T (6
piece)
(17.447-0.15) \$13.25 SET
458395W All
Offset square hole, 3/4T (8 piece)
(17.447-0.15) \$9.00 SET
458395WS All
Offset square hole, stainless steel, 3/4T (8
piece)
(17.447-0.15) \$17.50 SET

Bed Wood & Bed Mount Bolts

458394 37-59
1/2T, zinc-plated, specify year when
ordering. (17.447-0.4) . . . \$33.75 SET

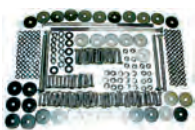

458394S 37-59
Stainless steel, 1/2T.
Specify year when
ordering. (17.447-0) . .
\$72.00 SET

458394S39 . . . 37-39
(1/2 Ton) Stainless
Steel (17.447-0.15) . . .
\$72.00 SET

458394S45 . . . 40-45
(1/2 Ton) Stainless
Steel (17.447-0.15) . . .
\$72.00 SET

458394S46 46
(1/2 Ton) Stainless
Steel (17.447-0.15) . . .
\$72.00 SET



458394S50 47-50
(1/2 Ton) Stainless Steel
(17.447-0.15) \$78.00 SET

458394S53 . . . 51-53
(1/2 Ton) Stainless
Steel (17.447-0.15) . . .
\$74.00 SET

458394S55 . . . 54-55
(1/2 Ton) Stainless
Steel (17.447-0.15) . . .
\$72.00 SET

458394Z 37-59
1/2T, polished (17.447-0) . \$92.00 SET

458393 37-59
3/4T & long bed, zinc-plated, specify year
when ordering.
(17.447-0.4) \$40.00 SET

458393S 37-59
3/4T & long bed, stainless steel, specify
year when ordering.
(17.447-0.4) \$82.00 SET

458393S50 47-50
(3/4t & Long Bed) Stainless Steel
(17.447-0.15) \$88.00 SET

458393Z 37-59
3/4T & long bed, polished, specify year
when ordering.
(17.447-0.4) \$100.00 SET

Bed Mounting Blocks



458394G 36-46
& pads, cypress, 1/2T
(17.447-0.15) \$20.00 SET

458394J 37-46
& pads, cypress, 3/4T
(17.447-0) \$20.50 SET

458394D 47-53
& pads, cypress, 1/2T
(17.447-0.15) \$15.00 SET

458394E 47-53
& pads, cypress, 3/4T
(17.447-0.15) \$16.00 SET

Bed Mounting Rubber Pads

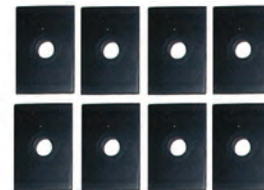

458394F 54-59
1/2T (17.447-0.15) \$6.50 SET

458394H 54-59
Long bed & 3/4T
(17.447-0) \$7.00 SET

Small Crossmember

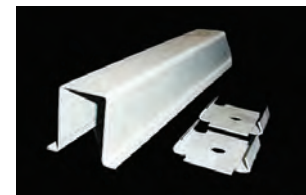

3860566 37-57
Front or center comes with flange
brackets (specify year when
ordering). (17.405-0) \$20.00 EA

386056646 40-46
Front or Center. Comes with flange
brackets. (20.405-0.15) . . . \$23.50 EA

Returns require a return authorization number, Please call.

Section 490T: Complete Bed & Bed Parts

Format = Part No., Year, Description, Original Chevrolet Parts Book Group No., Price and Unit of Measure.



Rear Crossmember



3810032 All
1/2T, no holes (specify year when
ordering) (17.405-0.4) \$95.00 EA

3806578 47-53
3/4T, no holes (17.405-0.15) \$90.00 EA



3713954 54-55
3/4T, no holes (55 1st series)
(17.405-0.15) \$90.00 EA

3806581 47-53
1T, no holes (17.405-0.15) .. \$90.00 EA

Flange Bracket



3860566A. . . . 37-53
Crossmember
(20.405-0.15) \$6.00 EA

Tailpipe Heat Shield

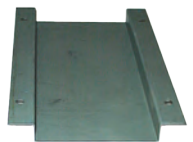

3689481R. . . . 37-46
Under bed. (3.706-0.15)
\$9.25 EA



3689481S. . . . 47-54
Under bed. (3.706-0.15)
\$7.00 EA

Tailgate

**Note: Oversize shipping charges apply.
Please call for rates.**



471196A. 34-39
Chevrolet script, complete,
original 1939. 46-1/2" wide.
(17.615-0.15) \$220.00 EA



471196 34-39
Complete w/out script, also GMC,
original 1934-38. 46-1/2" wide.
(17.615-0.15) \$180.00 EA



3800262D 40
Chevrolet script, complete. 49-1/2"
wide. (17.615-0.15) \$240.00 EA

3800262 40
Complete w/out script, also GMC. 49-
1/2" wide. (17.615-0.15) .. \$200.00 EA



3801850 41-46
Complete. Chevy/ GMC. 48-1/4" wide.
(17.615-0.15) \$160.00 EA



3801850A 41-46
No script. Fits GMC also. 49-1/4"
wide. (17.615-0.15) \$160.00 EA



3806856 47-53
Chevrolet script, complete.
(17.615-0.15) \$210.00 EA

380685H. 47-53
GMC script, complete
(17.615-0.15) \$210.00 EA



3806856B 47-53
Complete w/out script, also GMC.
(17.615-0.15) \$160.00 EA



3810424 54-57
Chevrolet script, complete
(17.615-0.15) \$300.00 EA

3810424S 54-57
Bowtie, complete, flush fit (double
wall) (17.615-0.15) \$220.00 EA

3810424G 54-57
GMC script, complete
(17.615-0.15) \$275.00 EA

3810424A 54-57
Complete w/out script, also GMC
(17.615-0.15) \$160.00 EA

Tailgate - Custom

3801850L 41-46
Complete w/ louvers (7 rows w/
6 louvers each row) (also GMC).
(17.615-0.15) \$210.00 EA

3806856L 47-53
Complete w/ louvers (7 rows w/
6 louvers each row) (also GMC).
(17.615-0.15) \$210.00 EA

3810424B 54-57
49 louvers. Complete (also fits GMC).
(17.615-0.15) \$200.00 EA

Tailgate Cover

3801850D 41-46
Cover, hides the dents, smooth (also
GMC). (17.615-0.15) \$50.00 EA



3806856J 47-53
Cover, hides the dents. 4 rows
of louvers (also fits GMC).
(17.615-0.15) \$60.00 EA

Providing part numbers speeds up your order, improves accuracy and helps us maintain low prices.

See Illustration Index for core charge information and a list of abbreviations. For Body Model information, see Section 5T.



Section 490T: Complete Bed & Bed Parts

Format = Part No., Year, Description, Original Chevrolet Parts Book Group No., Price and Unit of Measure.



3806856M. 47-53
Cover w/ bowtie. 50-7/8" x 15-3/4".
(17.615-0.15) \$80.00 EA

810424C. 54-57
Cover, hides the dents. 7 rows of
louvers. (17.615-0.15) \$65.00 EA

3806856M. 54-87
31-1/2" x 10". Skin w/ bowtie.
(17.615-0.15) \$80.00 EA

Tailgate Skin



3806856HS. 47-53
Skin. No script. Also fits GMC.
(17.615-0.15) \$50.00 EA

3806856A. 47-53
Skin, Chevrolet script.
(17.615-0.15) \$185.00 EA

380685G. 47-53
Skin, GMC script
(17.615-0.15) \$210.50 EA

Tailgate Decal



3800262B. 39-40
Chevrolet script, chrome
(17.615-0.15) \$12.50 EA

3800262C. 39-40
Chevrolet script, black
(17.615-0.15) \$9.00 EA

3800262A. 39-40
Chevrolet script, white
(17.615-0.15) \$9.00 EA



3806856E. 47-53
Chevrolet script, chrome.
(17.615-0.15) \$9.25 EA

3806856F. 47-53
Chevrolet script, black.
(17.615-0.15) \$8.25 EA

3806856D. 47-53
Chevrolet script, white.
(17.615-0.15) \$8.25 EA

3810424F. 54-57
Chevrolet script, chrome
(17.615-0.15) \$9.25 EA

3810424E. 54-57
Chevrolet script, black
(17.615-0.15) \$8.25 EA



3810424D. 54-57
Chevrolet script, white
(17.615-0.15) \$7.00 EA



3806856I. 47-53
GMC script, chrome.
(17.615-0.15) \$11.50 EA

3806856H. 47-53
GMC script, black.
(17.615-0.15) \$7.00 EA

3806856G. 47-53
GMC script, white.
(17.615-0.15) \$7.00 EA

Tailgate Hinges



3806884S. 41-53
Chrome. (17.625-0.15)
\$60.00 PR



463671. 34-39
(17.625-0.15) \$25.25 EA

3806884A. 40
With bushing
(17.625-0.15) \$28.50 EA

3806884. 41-53
(17.625-0.3) \$20.00 EA

3810706. 54-57
Trunion & bolt
(17.625-0.15) \$25.00 PR

Bracket-Tailgate Chain



3801845C. 34-40
Left (17.635-0.15)
\$15.25 EA



3801845B. 34-40
Right (17.635-0.15) . . .
\$15.25 EA

Eye Bolt



3801845D. 34-53
Tailgate chain
(17.635-0.15) \$10.00 EA

Tailgate Chains



3801845J. 32-53
Assembly, zinc plated
(17.635-0.15) \$25.00 PR

3801845S. 32-53
Assembly, stainless
(17.635-0.15) \$50.00 PR

3810823. 54-60
Assembly, zinc plated
(17.635-0.15) \$25.00 PR

3810823S. 54-60
Assembly, stainless
(17.635-0.15) \$50.00 PR

Tailgate Chain Covers



3810750. 32-60
Black rubber (17.635-0.4) \$10.75 SET

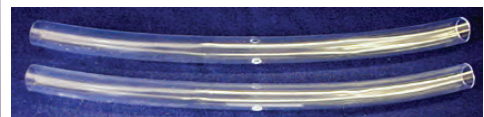

3810750C. 32-60
Clear rubber (17.635-0) \$5.00 PR

Returns require a return authorization number, Please call.

Section 490T: Complete Bed & Bed Parts

Format = Part No., Year, Description, Original Chevrolet Parts Book Group No., Price and Unit of Measure.



Spare Tire Carrier



358451 41-50
 Assembly under bed
 (7.608-0) \$295.00 SET

Please call for availability on all Odds & Ends parts; once part is sold, it may no longer be in stock.

Odds & Ends

3808817 47-55
 Lock support - back door, fits panel
 and suburbans with back door (16.33-0)
 \$35.00 EA



1954—Dale B.

490T

Providing part numbers speeds up your order, improves accuracy and helps us maintain low prices.

See Illustration Index for core charge information and a list of abbreviations. For Body Model information, see Section 5T.



Section 520T: Manuals, Accessory Books, Service Bulletins & Sales Brochures

Format = Part No., Year, Description, Original Chevrolet Parts Book Group No., Price and Unit of Measure.

Parts Book on CD



PART72CD . . . 38-72
38-64 Cars, T38-72 rucks & 53-64 Corvette. (18.2-15) . . . \$30.75 EA

PART61 29-61
29-61 Cars, Trucks & 53-61 Corvette. (18.2-15) \$30.75 EA

Sales brochure

SALE46TP 46
Super Color Reproduction Of Original Brochure (18-15) \$8.25 EA

SALE47TS 47-53
Super Color Reproduction Of Original Brochure (18-15) \$8.25 EA



SALE42T 42
Super color reproduction of original brochure (18-15) \$10.25 EA

Shop Manual on CD

SHOP37CD 37-38
Car & truck on CD (18.3-15) \$30.75 EA



SHOP39CD . . . 39-40
Car & truck manuals on CD. (18.3-15) . . . \$30.75 EA



SHOP41CD . . . 41-48
41-48 Car & 41-46 Truck on CD. (18.3-15) \$30.75 EA



SHOP49CD . . . 49-54
49-54 Cars. (18.3-15). \$30.75 EA



SHOP47CD . . . 47-53
48-52 trucks. (18.3-15) \$30.75 EA



SHOP54CD 54
54-55 (1st Series) Trucks on CD. (18.3-15) \$30.75 EA

Owners Manual



OWNT 37-55
Specify year when ordering (18-40). . . . \$9.00 EA



OWNT40 40
(18-15) . . . \$9.25 EA



OWNTG 41-55
GMC, specify year when ordering (exc 37-40 & 47-48). (18-40) \$7.50 EA



OWN47TG . . . 47-48
(18-15) . . . \$9.75 EA

Folder



OWNFD All
For owners' manual & papers, Chevrolet Motor Division, original type (18-20). \$5.25 EA

Assembly Manual



ASS47 47-54
This gives incredible detail! A must have (original 54). (18.1-15) \$30.75 EA

Bed Assembly



BED00 All
& restoration manual. (18-15) \$4.75 EA

AC Parts Catalog



PARTAC41 . . . 29-41
Oil, fuel & air filters, speedometer cables (18.2-40) . . . \$4.00 EA

Parts Book



PART39 29-42
For 42 & Earlier (18.2-15) \$49.00 EA



PART42W . . . 35-41
Woody wagon & Suburban (18.2-30) . . \$10.00 EA



PART48W . . . 42-48
Suburban (18.2-15) . . \$19.00 EA

Parts Interchange



PART51N . . . 29-52
Chev, Pontiac, Oldsmobile (18.2-15) . \$20.50 EA

Books



BOOK12V All
6v to 12v conversion (19.5-15) . . \$10.25 EA

Returns require a return authorization number, Please call.

Section 520T: Manuals, Accessory Books, Service Bulletins & Sales Brochures

Format = Part No., Year, Description, Original Chevrolet Parts Book Group No., Price and Unit of Measure.



Shop Manuals on CD

All CDs contain the factory service or shop manual and any applicable supplement. The factory manual is essential. It includes coverage on all mechanical and electrical systems. This is where you find specifications, wiring diagrams, diagnostic procedures, troubleshooting, installation and removal, and covers all systems.

CDs contain the body service manual as well. In some cases, the body information is included in the service manual.

Parts books are included on most CDs; check content information for specifics.

Shop & Service Manuals on CD



- DCDGM-51 37
Includes 1937 shop manual, 29-48 parts book for 1937 cars & trucks. (18.3-15) \$55.00 EA
- DCDGM-52 38
Includes 1938 shop manual, 29-48 parts book & 38-68 parts book for 1938 cars & trucks. (18.3-15) \$55.00 EA
- DCDGM-53 39
Includes 1939 shop manual, 39-40 Fisher body manual, 29-48 parts book & 38-68 parts book for 1939 cars & trucks. (18.3-15) \$55.00 EA
- DCDGM-54 40
Includes 1940 shop manual, 39-40 Fisher body manual, 29-48 parts book & 38-68 parts book for 1940 cars & trucks. (18.3-15) \$55.00 EA
- DCDGM-55 41
Includes 1941 shop manual, 29-48 parts book & 38-68 parts book for 1941 cars & trucks. (18.3-15) \$55.00 EA
- DCDGM-56 42-48
Includes 1942-48 shop manual, 29-48 parts book & 38-68 parts book for 1942-48 cars & 42-48 trucks. (18.3-15) \$55.00 EA

- DCDGM-74 47
Includes 1947 shop manual, 29-48 parts book, 38-68 parts book & 47-55 assembly manual for 1947 trucks. (18.3-15) \$55.00 EA
- DCDGM-75 48-53
Includes 1948-53 shop manual, 29-48 parts book, 38-68 parts book & 47-55 assembly manual for 1948-53 trucks. (18.3-15) \$55.00 EA
- DCDGM-76 54
Includes 1954 shop manual, 49-58 parts book & 54-65 parts book for 1954 trucks. (18.3-15) \$55.00 EA

Parts Book on CD

- DCDGM-145 29-72
29-72 parts book. (18.3-15). \$55.00 EA

Shop Manual

- SHOP37 37
Car & truck, full size. Superb! (18.3-15) \$20.50 EA
- SHOP38 38
W/ car & truck, full size. Superb! (18.3-15) \$20.50 EA
- SHOP38P 38
W/ car & truck, 3/4 size photocopy (18.3-15) \$12.00 EA
- SHOP39 39
W/ car & truck, full size. Superb! (18.3-15) \$20.50 EA
- SHOP39P 39
W/ car & truck, 3/4 size photocopy (18.3-40) \$15.00 EA
- SHOP40 40
W/ car & truck, full size. Superb! (18.3-15) \$20.50 EA
- SHOP40P 40
W/ car & truck, 3/4 size photocopy (18.3-15) \$15.00 EA



- SHOP41 41
W/ car & truck, full size. Superb! (18.3-15) \$20.50 EA
- SHOP42 42-48
Car & 42-46 truck, full size. Superb! (18.3-15) \$20.50 EA
- SHOP47 47-53
Original 48-52, full size. Superb! (18.3-15) \$20.50 EA
- SHOP47G 47-54
GMC, full size. Superb! (18.3-15) \$25.50 EA
- SHOP47T 47
Original 1947 Only!! (18.3-15) \$28.00 EA
- SHOP54 54
Full size. Superb! (18.3-15) \$20.50 EA
- SHOP54S 47-54
Steering gear overhaul (18.3-15) \$6.00 EA
- SHOP55 55
1st series, full size (18.3-15) \$10.00 EA

Providing part numbers speeds up your order, improves accuracy and helps us maintain low prices.

See Illustration Index for core charge information and a list of abbreviations. For Body Model information, see Section 5T.



Section 520T: Manuals, Accessory Books, Service Bulletins & Sales Brochures

Format = Part No., Year, Description, Original Chevrolet Parts Book Group No., Price and Unit of Measure.

Good Housekeeping



HOUS1 All
In your car by GM,
Fisher body, removing
17 upholstery stains,
29 pages (18.23-30) . .
\$6.25 EA

Service Bulletins

Note: 1 service bulletin was issued every month (except during WWII) to Chevrolet dealers on fixing new car problems. Introduction issue is previous year so we recommend three years for complete coverage of your vehicle. Invaluable.



SERV 37-54
12 month, specify year
when ordering (18.5-15)
\$16.00 EA

Glove Box Accessory Book



ACC37B 37
Gorgeous color repro
of original w/ pictures
of all those rare
accessories. (18.6-15) .
\$10.25 EA



ACC38B 38
Repro of original w/
pictures of all those
rare accessories.
Sepia, 9in. x 11in.
(18.6-15) . . \$10.25 EA



ACC39B 39
Gorgeous color repro
of original w/ pictures
of all those rare
accessories. (18.6-15) .
\$10.25 EA



ACC40B 40
Gorgeous color repro
of original w/ pictures
of all those rare
accessories. (18.6-15) .
\$10.25 EA



ACC41B 41
Gorgeous color repro
of original w/ pictures
of all those rare
accessories. (18.6-15)
\$10.25 EA



ACC48B 46-48
Gorgeous color repro
of original w/ pictures
of all those rare
accessories. Original
48. (18.6-15)
\$10.25 EA

Accessory Identifying Book



ACC01B 46-78
All accessories 1946-
78 in numerical order,
superb for identifying.
(18.6-15) . . \$25.00 EA

Accessory List



ACC_L 37-54
With part numbers &
prices (great for swap
meets) (specify year
after "ACC"). (18.7-20)
\$3.25 EA

Data Book

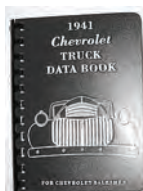

DATA41 41-46
Salesman, all the
specs, original 1941
(18.8-15) . . \$30.00 EA

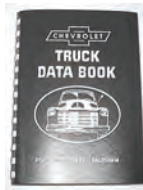

DATA51 47-53
Salesman, all the
specs, original 1950
(18.8-15) . . \$34.50 EA

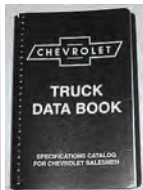

DATA54 54
Salesman, all the
specs 1954 (18.8-15) .
\$30.00 EA

RPO Booklet



RPO47 47
W/ regular production
options (18.8-15)
\$4.75 EA



RPO49 49
W/ regular production
options (18.8-20)
\$6.50 EA



RPO53 53
W/ regular production
options (18.8-20)
\$6.25 EA

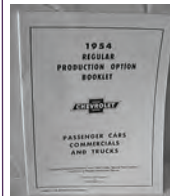

RPO54 54
W/ regular production
options (18.8-20)
\$6.50 EA

Price Guide



PRICE37 37
Advertised delivered
prices of vehicles &
accessories (18.7-20)
\$3.25 EA



PRICE38 38
Advertised delivered
prices of vehicles &
accessories (18.7-20)
\$3.25 EA



PRICE39 39
Advertised delivered
prices of vehicles &
accessories (18.7-40)
\$6.25 EA

Returns require a return authorization number, Please call.

Section 520T: Manuals, Accessory Books, Service Bulletins & Sales Brochures

Format = Part No., Year, Description, Original Chevrolet Parts Book Group No., Price and Unit of Measure.



Casting Numbers



CAST42 29-42
 Identification book
 (18.6-15) . . \$9.00 EA

Sales Brochure



SALET 37-55
 Super color reproduction of original
 brochure (specify year when ordering)
 (18-0) \$6.75 EA



SALE55T2 55
 2nd series (18-15) . . .
 \$6.75 EA

Providing part numbers speeds up your order, improves accuracy and helps us maintain low prices.

See Illustration Index for core charge information and a list of abbreviations. For Body Model information, see Section 5T.



Section 530T: Factory Accessory Installation Books, Sheets & Templates

Format = Part No., Year, Description, Original Chevrolet Parts Book Group No., Price and Unit of Measure.

Accessory Installation Manual



ACC49M	49
Superb (18.9-15)	\$11.25 EA
ACC50M	50
Superb (18.9-15)	\$9.00 EA
ACC51M	51
Superb (18.9-15)	\$9.00 EA
ACC52M	52
Superb (18.9-15)	\$9.00 EA
ACC53M	53
Superb (18.9-15)	\$9.00 EA
ACC54M	54
Superb (18.9-20)	\$15.25 EA
ACC49E	49-54
Per accessory (18.9-15)	\$2.00 EA

Copies of originals wanted: Original accessory instruction sheets 1937-54 or sharp copies.

Antenna Installation Sheets

ACC65I	37-40
Under running board (original 40) (18.9-15)	\$2.00 EA
985531I	39-46
Install instructions (18.9-40)	\$2.00 EA
ACC76I	47-54
Includes template (18.9-15)	\$2.00 EA

Cigarette Lighter Installation Sheet

ACC45I	42-53
(18.9-15)	\$2.00 EA

Compass Installation Sheets

ACC25I	37-42
For glove box (18.9-30)	\$2.00 EA
ACC26I	46-48
For glove box (18.9-30)	\$2.00 EA

Fog Light Installation Sheets

ACC18I	41
(18.9-30)	\$2.00 EA

ACC40I	42-48
(18.9-15)	\$2.00 EA

Gas Filter Installation Sheet

ACC56I	33-56
Genuine AC (18.9-15)	\$2.00 EA

Glove Compartment Lamp Installation Sheet

ACC02I	41-54
(18.9-15)	\$1.00 EA

Heater & Defroster Installation Sheet

ACC23I	47-48
Non-fresh air, also COE (18.9-30)	\$2.00 EA

Heater Installation Sheet

ACC61I	47-53
Recirculating (18.9-40)	\$2.00 EA
ACC47I	47-53
Recirculating, 3000-4000-6000 series (18.9-15)	\$2.00 EA

Horn Installation Sheet

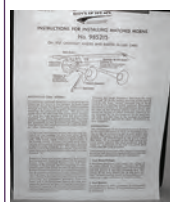

ACC62I	37-38
(Matched) with City & Country switch, original 37 (19.9-40)	\$2.50 EA

ACC09I	37-39
(Matched) with City & Country switch, original 39 (18.9-40)	\$2.50 EA

Town & Country Horn Installation Sheet

ACC10I	40-42
(18.9-40)	\$3.00 EA

Lock & Key Service Manual

ACC89I	All 9 pages (18.9-40)
	\$5.00 EA

Mirror-Vanity Installation Sheet

ACC63I	37-41
With vertical lights (18.9-15)	\$2.00 EA

Mirror-Peep Installation Sheet

ACC53I	37-50
(18.9-40)	\$1.00 EA

Oil Filter Installation Sheet

ACC88I	37-41
Original AC (18.9-40)	\$3.00 EA

ACC66I	42-47
Original AC (18.9-30)	\$4.00 EA

ACC87I	48-49
Original AC (18.9-20)	\$3.00 EA

ACC67I	50-52
Original AC (18.9-15)	\$2.00 EA

ACC68I	53-55
Original AC (18.9-15)	\$2.00 EA

Overflow Tank Installation Sheet

ACC07I	37-48
Install instructions (18.9-30)	\$2.00 EA

ACC08I	49-54
(18.9-30)	\$2.00 EA

Park Light Installation Sheet



ACC60I	37-39
Fender lamps (18.9-15)	\$2.00 EA

Passing Lamp Installation Sheet

ACC19I	41
(18.9-30)	\$2.00 EA

Radiator Insect Screen Installation Sheet

ACC71I	47-53
(18.9-15)	\$2.00 EA

Radio Manual

985538M	40
5 tube, 4 button (original 40) (18.9-40)	\$3.00 EA
985424M	40
8 tube w/ installation (18.9-0)	\$3.00 EA



986067M	47-50
Original 47 (18.9-40)	\$6.00 EA
986771M	54
(18.9-40)	\$6.00 EA

Radio Shop & Service Manual

ACC44I	47-53
Original 50 (18.9-15)	\$9.75 EA

Returns require a return authorization number, Please call.

Section 530T: Factory Accessory Installation Books, Sheets & Templates



Format = Part No., Year, Description, Original Chevrolet Parts Book Group No., Price and Unit of Measure.

Sunvisor

ACC57I All
Application chart for Fulton exterior
visor. (18.9-15) \$2.00 EA

Spotlight Template

AST 39-46
W/ Instruction (0-20) \$2.50 EA



ACC39I 37-54
W/ instruction (18.9-15)
\$2.00 EA

Umbrella Holder Installation Sheet

ACC11I All
(18.9-30) \$2.00 EA

Underhood Lamp Installation Sheet

ACC82I 49-54
(18.9-0) \$1.00 EA

Utility Pocket Unit Installation Sheet

ACC70I 48-50
(18.9-15) \$2.00 EA

Windshield Washer Installation Sheet

ACC59I 38-39
(18.9-15) \$2.00 EA

ACC12I 40-42
(18.9-30) \$2.00 EA

Windshield Wiper Installation Sheet



ACC72I 39-46
Right (18.9-15)
\$2.00 EA

Providing part numbers speeds up your order, improves accuracy and helps us maintain low prices.

See Illustration Index for core charge information and a list of abbreviations. For Body Model information, see Section 5T.



Section 550T: Original Cards, Metal Tags, Decals & Shop Signs

Format = Part No., Year, Description, Original Chevrolet Parts Book Group No., Price and Unit of Measure.

Air Cleaner



AIR350 34-39
Oil bath decal (19.3-0)
\$1.25 EA



AIR37 37
Dry decal (19.3-15) . .
\$2.75 EA



AIR38T 38-46
Dry decal (19.3-20) . .
\$5.25 EA



AIR400T 40-54
Oil bath decal (1-15) .
\$4.00 EA



AIR470T 47-59
Oil bath decal, heavy
duty (1-30) . \$4.75 EA



AIR47T 47-54
Dry decal (19.3-15) . .
\$1.75 EA

Antifreeze

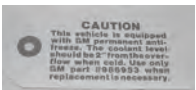

TAG10 All
GM tag (19.1-20)
\$5.25 EA

Battery



TAG03 All
Guarantee card
(19.1-30) \$4.75 EA

Break-in Instructions



TAG11 48-56
Card (19.1-20)
\$5.50 EA



TAG01 39-47
Card (19.1-20)
\$3.50 EA

Cigar Lighter



TAG02 39-50
Card-Casco (19.1-20)
\$3.25 EA

Compass

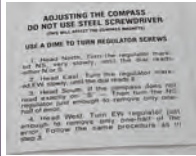

DEC12 37-59
Instruction decal
(19.2-30) . . . \$3.00 EA



TAG23 37-42
Tag (cut in outline of
compass) (19.1-20)
\$2.50 EA

Data Plate (Metal)



PLATE39T . . . 39-41
Right side cowl 1/2T
(19.4-15) . . \$17.00 EA



PLATE42T . . . 42-46
Right side cowl 1/2T
(19.4-15) . . \$18.00 EA



PLATE47T . . . 47-49
Door post 1/2T
(19.4-15) . . \$17.00 EA



PLATE50G 50
Door post 1/2T, GMC (19.4-15)
\$17.00 EA

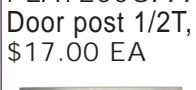

PLATE50T 50
Door post 1/2T
(19.4-15) . . \$17.00 EA

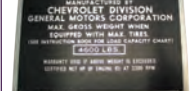

PLATE51T . . . 51-52
Door post 1/2T
(19.4-15) . . \$17.00 EA



PLATE51T . . . 51-52
Door post 1/2T
(19.4-15) . . \$17.00 EA

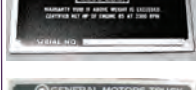

PLATE53G 53
Door post 1/2T, GMC
(19.4-15) . . \$17.00 EA

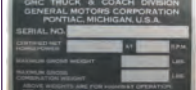

PLATE53G 53
Door post 1/2T, GMC
(19.4-15) . . \$17.00 EA



PLATE53T 53
Door post 1/2T (19.4-15)
\$17.00 EA



PLATE54G 54
Door post 1/2T, GMC
(19.4-15) . . \$17.00 EA



PLATE54T 54
Door post 1/2T
(19.4-15) . . \$17.00 EA

Delco Remy Tag



PLATE07 37
Generator, starter & distributor
(19.4-15) \$10.25 EA



PLATE05 38-54
Generator, Starter or Distributor.
Includes rivets. (19.4-15) . . . \$6.25 EA

Generator Warning Tag



TAG04 All
(19.1-30) . . . \$3.50 EA

Returns require a return authorization number, Please call.

Section 550T: Original Cards, Metal Tags, Decals & Shop Signs



Format = Part No., Year, Description, Original Chevrolet Parts Book Group No., Price and Unit of Measure.

Hat Pin



5040 37-54
Chevy bowtie w/ year (specify year when ordering) (18.8-0) . . . \$4.25 EA

Heater



DEC06 47-55
On/off defroster decal. (19.2-20) . . . \$3.00 EA



DEC07 47-52
Chevrolet round emblem. (19.2-15) . . . \$9.00 EA



DEC08 47-52
GMC round emblem. (19.2-15) . . . \$9.00 EA



DEC29 49-51
Decal-Harrison (19.2-20) . . . \$3.50 EA



DEC09 53
Fresh air round decal. (19.2-15) . . . \$2.50 EA



DEC17 53
Recirculating round decal. (19.2-15) . . . \$3.50 EA



DEC10 53-54
GMC round decal. (19.2-15) . . . \$2.75 EA



DEC16 54-55
Fresh air round decal. (19.2-15) . . . \$2.50 EA



DEC18 54-55
Recirculating round decal. (19.2-15) . . . \$3.00 EA



Key Decal

DEC11 36-54
Glove box (19.2-40) . . . \$5.75 EA

Lubrication Sticker



DEC05 All
Chevrolet script (blue, yellow & white) (19.2-15) . . . \$3.00 SET

Mirror Glare Proof



TAG09 All
Day-night card hangs on mirror arm (nice!) (19.1-20) . . . \$2.50 EA

Oil Filter



DEC30 37-41
Decal. Original, AC Kleer Kleen (19.2-20). \$6.00 EA



DEC04 42-54
Decals-set of 2, original AC (19.2-15) . \$3.50 EA



DEC19 40-49
Decal set (1940's) Fram 3-piece (19.2-20) \$8.00 EA



DEC20 50-59
Decal set (1950's) Fram 4-piece (19.2-20) \$9.75 EA

Overflow Tank Decal



DEC03 39-48
Gold with red wings (gorgeous!) (19.2-40) . \$5.00 EA



DEC28 49-54
(19.2-20) . . . \$6.00 EA

Paint Lacquer

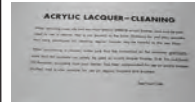

TAG16 53-58
Instruction card (19.1-20) . . . \$3.50 EA

Quality Control Card



TAG15 49-54
(19.1-20) . . . \$3.50 EA

Service Policy



TAG25 37-51
(19.1-20) . . . \$3.50 EA



TAG13 51-59
(19.1-20) . . . \$3.50 EA

Signs



SIGN01
Chevrolet metal sign 12-1/2in. x 15-1/2in. (19.45-0) . . \$31.50 EA

Providing part numbers speeds up your order, improves accuracy and helps us maintain low prices.

See Illustration Index for core charge information and a list of abbreviations. For Body Model information, see Section 5T.



Section 550T: Original Cards, Metal Tags, Decals & Shop Signs

Format = Part No., Year, Description, Original Chevrolet Parts Book Group No., Price and Unit of Measure.



SIGN03
Chevrolet decal (as on
metal sign). (19.45-15)
\$8.75 EA



DEC1451-54
Basket decal (19.2-20)
\$5.25 EA



SIGN02
GMC metal shop sign,
12-1/2in. x 15-1/2in.
(19.45-0) . . \$31.50 EA

Spotlight Card



TAG0837-54
Original S3-S4 hung
on light (19.1-40). . .
\$3.00 EA

Tire Pump Decal



DEC34 All
For hard to find
Monroe tire hand
pump -accessory. (-40). . . . \$5.00 EA

Valve Cover Decal



DEC1547-53
Thriftmaster for 216ci
(19.2-15) \$4.75 EA



DEC25 54
Thriftmaster 235ci
(19.2-15) . . . \$4.75 EA

Warranty Card

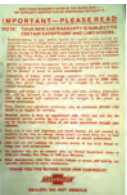

TAG1454-60
(19.1-20) . . . \$3.50 EA

Windshield Washer



DEC0239-50
Decal on metal basket
(19.2-20) . . . \$3.25 EA



DEC1351-54
Lid decal (19.2-20). . .
\$6.00 EA

Returns require a return authorization number, Please call.

Section 560T: Books

Format = Part No., Year, Description, Original Chevrolet Parts Book Group No., Price and Unit of Measure.



Books



BOOK06 47-54
Advanced design 47-54 trucks-10
pages of detailed specs & features
each year (19.5-40) \$4.50 EA



BOOK11
American salvage yard treasures.
(19.5-15) \$22.00 EA



BOOK13
Pictorial history of chevrolet cars
1940-54. (19.5-15) \$40.75 EA

Is one of these trucks yours?



Providing part numbers speeds up your order, improves accuracy and helps us maintain low prices.

See Illustration Index for core charge information and a list of abbreviations. For Body Model information, see Section 5T.



#

303 Aerospace Protectant 25

A

AC Parts Catalog 246
 Accessory Identifying Book 248
 Accessory Installation Manual 250
 Accessory List 248
 Adapter-Air Cleaner 88
 Adhesive 158
 Adhesives & Sealers 26, 229
 Adjuster Assembly 116
 Air Cleaner 252
 Air Cleaner Assembly 87
 Air Filter Element 88, 92
 Alignment Tool 37
 All Purpose Cleaner 21
 All Steel Cab 172
 Alternator 56
 Alternator Pulley 56
 Antenna 205
 Antenna Base 205
 Antenna Base & Nut 205
 Antenna Eye Bolt 205
 Antenna Installation Sheets 250
 Antenna Pad 205
 Anti-Corrosion Compound 25
 Antifreeze 252
 Anti-Rattle Rubber Spacer 115
 Applicator 21
 Arm Rest Bracket 217
 Arm Rest Rubber Pad 217
 Artwork 14
 Ash Tray Knob 195
 Assembly Manual 246
 Auto Dolly 23

B

Back Glass 223
 Back Glass & Frame 222, 233
 Back Glass Rubber 233

Back Up Light 86
 Backing Plate-water Pump 47
 Balls 128
 Bar Table -Custom Wheel 14
 Battery 182, 252
 Battery Cover 58, 174, 182
 Battery Cover Gasket 59
 Battery Hold Down 59
 Battery Mat 59
 Battery Minder 24, 56, 57
 Battery Minder Plus -Battery Charger 24, 56
 Battery Tender Plus 24, 56
 Battery Tender Plus -Battery Charger 24, 56
 Battery Tray 58
 Battery Tray Paint 58
 Bearing 105, 127
 Bearings & Balls For Steering Worm Gear 127
 Beauty Ring 143
 Beauty Rings 143
 Bed Assembly 246
 Bed Lids 235
 Bed Mounting Blocks 242
 Bed Mounting Rubber Pads 242
 Bed Roll Light 82
 Bed Roll Reflector 82, 237
 Bed Side Panel 240
 Bed Strips 240
 Bed Wood 241
 Bed Wood & Bed Mount Bolts 242
 Bed Wood -GMC 242
 Bed Wood Washer 242
 Bee Hive Oil Filter 38
 Bee Hive Oil Filter Bracket 38
 Belt 47, 58
 Bezel-Gauge Cluster 202
 Billet Caps 237
 Billet Park Light Rim 69
 Bleeder Valve 119
 Blue Dots 82
 Body Bolt Kits 177

Returns require a return authorization number, Please call.



Format = Part No., Year, Description, Original Chevrolet Parts Book Group No., Price and Unit of Measure.

Body Deadener	180-182	Bumper Brackets -Alloy	147
Body Mount Pads	177	Bumper Guard	148
Bolt & Bushing	133, 138	Bumper -Rear Axle	139
Bolt & Washer Set	161	Bumper-Axle	133
Bolt -Bumper Guard	148	Bumpers	147
Bolt Set	182	Bumpers (Rubber)	158
Books	246, 255	Bushing	47, 105, 138, 139, 184
Boot	114	Bushing & Bolt W/ Nut	110
Brace (V-Rod)	155	Bushing In Cylinder Head	203
Bracket -Hood Hinge	157, 159	Bushing-Pitman Shaft	128
Bracket-Shift Tube Support	105	Bushings	115, 130, 132, 183
Bracket-Tailgate Chain	244	Bushings -Shock	138
Brake Adjust Hole Plugs	116	Buttery Wax	20
Brake Cleaner	120		
Brake Drum	115	C	
Brake Fluid	25, 119	Cab Back Panel - Lower	172
Brake Hose	116	Cab Back Panel - Upper	172
Brake Light Switch	119	Cab Back Panel Supports	173
Brake Line Junction Block	119	Cab Corner Patch Panel - Inner	172
Brake Line Junction Bolt	119	Cab Corner Patch Panel - Outer	172
Brake Line Sets	116	Cab Front Lower Corner	171
Brake Overhaul Kit	114	Cab Mount	177
Brake Pedal Return Spring	115, 183	Cab Mount Body To Frame	177
Brake Shoe Hold Down	116	Cab Mount Bolt Set	177
Brake Shoe Hold Down Kit	115	Cab Mount Brace (Front)	173
Brake Shoe Return Springs	116	Cab Mount Brace (Rear)	173
Brake Shoe Springs	116	Cab Mount Pads	177
Brake Shoes	115	Cab Mount Rear	177
Break-in Instructions	252	Cab Mount Wood Blocks	177
Briz Bumper License Guard	147	Cab Roof	172
Briz Bumpers	147	Camshaft	35
Bulbs	80	Camshaft Bearings	36
Bulbs -LED	69, 80	Camshaft Thrust Plate & Spacer	36
Bulbs -LED 12 Volt	82	Camshaft Thrust Plate Screws	36
Bulbs -LED 6 Volt	82	Car Wash	20
Bulbs-Halogen	80	Carburetor	93
Bullnose	156	Carburetor Base Gasket	94
Bumper	183	Carburetor Cleaner	93
Bumper Bolt	148	Carburetor Insulator	94
Bumper Bracket	149	Carburetor Parts	94
		Carburetor Rebuild Kit	93

Providing part numbers speeds up your order, improves accuracy and helps us maintain low prices.

See Illustration Index for core charge information and a list of abbreviations. For Body Model information, see Section 5T.



Carpet & Upholstery Cleaner	21	Clutch Linkage Rod	102
Carpet With Pad	182	Clutch Pedal Return Spring	102
Carrier Bearing	110	Column Floor Mounts (Billet Specialties)	124
Casting Numbers	249	Column Floor Mounts (Flaming River)	124
Center Strip	157	Column Shift Floor Mounts (Flaming River)	124
Channel (Guide)	228, 229	Column Shift Knob	195
Channel Kit	232	Compass	252
Channel Kit Components	228	Compass Installation Sheets	250
Check Link Bumper	219	Complete Bed - Assembled	239
Choke Cable Assembly	194	Complete Bed - Unassembled	239
Choke Knob	194	Complete Bed Options	239
Chrome Bezel	213	Complete Bed Upgrade (Bed Strips)	239
Chrome Lock Strip	233	Complete Bed Upgrade (Bolt Kit)	239
Cigar Lighter	252	Complete Bed Upgrade (Chains)	239
Cigarette Lighter	195	Complete Bed Upgrade (Holes Punched)	239
Cigarette Lighter Installation Sheet	250	Complete Bed Upgrade (Weld Stake Pockets)	239
Clamp	88, 114	Complete Bed Upgrades	239
Clamp-Air Cleaner	88	Condenser	61
Clamp-Gas Filler Hose	91	Control Rod Assembly	114
Clay Bar	20	Copper Washer	116
Cleaner-Brake	25	Core Support Bolt Kit	45, 155
Cleaner-Carburetor	25	Core Support Pads & Shims	45, 155
Clevis End Pin	114	Corner Strips	241
Clip	68, 94, 102, 119	Coupling Pin	108
Clips -Moulding	201	Cover -Wiper Motor Access Hole	209
CLK (Cam & Lifter Kit)	32	Cowl Panel - Metal Upper	171
CLK3 (Cam, Lifter Kit & Timing Gears)	32	Cowl Patch Panel Metal Outer	171
Clock	19	Cowl Vent	171
Clock Quartz Conversion	203	Cowl Vent Filler Panel	176
Clocks	19	Cowl Vent Knob	50, 193, 211
Clocks-Large	17	Cowl Vent Seal	211
Cluster Shaft	105	Crank Hole Cover	152, 153
Clutch Bit Holder	23	Cup W/ Chrome Rim	64
Clutch Disc -Rebuilt	102	Custom Bed Wood	241
Clutch Head Bits	23	Custom Harness	66
Clutch Head Bolt	161	Custom Wiring Harness	66
Clutch Head Driver	78, 161, 190, 217	Cylinder Head Bolts	36
Clutch Head Driver W/ Bits	23	Cab Lower Rear Back Panel Crossmember	172
Clutch Head Screw Set	216		
Clutch Head Screws	78		
		D	
		D.A. Plug	56

Returns require a return authorization number, Please call.



Format = Part No., Year, Description, Original Chevrolet Parts Book Group No., Price and Unit of Measure.

Dampner-Balancer	36, 41	Door Lock	215
Dash Moulding Speaker Grille	201	Door Lock Gasket	215
Dash Panel	199	Door Lock Knob	215
Data Book	248	Door Panel-Metal Frames	217
Data Plate (Metal)	252	Door Panels -Cardboard	191, 217
Decal Defroster	51	Door Patch Panel	164, 167, 170
Decal Heater	51	Door Pillar	170
Decal Hub Cap	143-144	Door Sill Retainer	220
Decal Instrument Set	202	Door Sill Seal	220
Decal Radio Grille	201	Door Sill Seal Retainer	220
Decals -Grille	157	Door Strap Check Bracket	219
Defroster Duct Hose	50	Door Weatherstrip	220
Delco Remy Metal Tag	55, 57, 61	Door Windlace	220
Delco Remy Tag	252	Dovetail Bumper	221
Detail Sponge	14, 21, 22	Dowel Pin	108
Detail Spray	20	Drag Link	128
Differential Fill	110	Drag Link Kit	128
Dimmer Switch	79	Drag Link Rebuild Kit	128
Disc Brake Conversion Kit	113	Drag Link Seals	128
Distributor	60, 61	Drive Shaft Bushing	108
Distributor Cap	61	Drive Shaft Seal	108
Division Bar	229	Drivers Side Vent Filler	176
Dome Light Assembly	189	Driving Light	81
Dome Light Lens	189	Driving Lights	74, 81
Door - Metal	170	Drying Towel	21
Door Arm Rests	217	Dual Action Shock	138
Door Bumper	221	Dust Cover	144
Door Check Link Assembly	219	Duster	19
Door Check Link Springs	219		
Door Glass	222		
Door Handle Exterior	215	EK Engine Kit	32
Door Handle Exterior Guard	215	Electric Wiper Conversion Kit	210
Door Handle Exterior Return Spring	215	Emergency Brake Bracket	114, 174
Door Handle Interior	216	Emergency Brake Cable	114
Door Hinge Bolt	219	Emergency Brake Release	114, 193
Door Hinge Post Lower	172	Emergency Pedal Boot	183
Door Hinges	219	Engine Assembly Lube	36, 42
Door Latch Assembly	216	Engine Crank	54
Door Latch Post Lower	172	Engine Kit	32
Door Latch Striker	215	Exhaust Extension	99
		Exhaust System	98

Providing part numbers speeds up your order, improves accuracy and helps us maintain low prices.

See Illustration Index for core charge information and a list of abbreviations. For Body Model information, see Section 5T.



Format = Part No., Year, Description, Original Chevrolet Parts Book Group No., Price and Unit of Measure.

Expansion Plug 37

Eye Bolt 244

F

Fan 46

Felt Body Deadener 184

Felt Floor Seal 179

Fender Braces 161

Fender Cover 24

Fender Front (Fiberglass) 160

Fender Front (Steel) 160

Fender Gaskets 161

Fender Marker (Guide) 161

Fender Rear (Fiberglass) 160

Fender Rear (Steel) 160

Fender Skirts 162

Fender Welt 161

Fender Welting 161

Fenton Headers 96-97

Fenton Intake 2 Carb 87

Ferrule 216

Ferrule Tool 216

Fine Machine Polish 20

Firewall (steel) 171, 175

Firewall Grommets 178

Firewall Pad -Polyurethane w/ Insulation 178

Firewall Pad-Fiber Board w/ Insulation 178

Firewall Pad-Fiberglass w/ Insulation 178

Flange Bracket 243

Flange Plate 98

Flasher Socket 70

Float 90

Floor Insert Over Transmission 174

Floor Kit 176

Floor Pan 173

Floor Panel (from seat forward) 174

Floor Shift Boot 104, 183

Floorboard 165, 168

Floorshift Seal 104, 183

Flywheel Ring Gear 102

Fog Light 74, 81

Fog Light Bracket 74

Fog Light Emblem 74

Fog Light Installation Sheets 250

Fog Light Lens 74

Fog Light Rim 74

Fog Lights 81

Folder 246

French Stitching Option 191

Front Bed Panel 240

Front Leaf Spring 133

Front Mat 182

Front Splash Apron 149

Front Wheel Bearing -Inner 144

Front Wheel Bearing -Outer 145

Front Wheel Bearing Seal 144

Fuel Filler Concealment Kit 235

Fuel Filler Neck 90

Fuel Filter 91

Fuel Pump 92, 209

Fuel Pump Rebuild Kit 92, 209

Fuel Pump to Carb Fuel Line 94

Fuel Stabilizer 25, 89

Fuse Holder 75

G

Gangster Grille 152

Garnish Moulding 228

Gas Caps 91

Gas Filter Installation Sheet 250

Gas Pedal 183, 184

Gas Tank 87

Gas Tank Cleaner 25, 89

Gas Tank Fill Hose Kit 87, 90

Gas Tank Mounting Bracket 90

Gas Tank Mounting Pad 90

Gas Tank Restoration Kit 25, 89

Gas Tank Sealer 89

Gas Tank Sealer Slosh 25

Gas Tank Sending Unit 90

Gas Tank-Die Stamped 89

Gasket 98, 114, 118, 128, 182, 183, 203, 213

Returns require a return authorization number, Please call.



Format = Part No., Year, Description, Original Chevrolet Parts Book Group No., Price and Unit of Measure.

Gasket (Intake-Exhaust Manifold)	41	Generator Bolt & Nut	57
Gasket -Brake Drum	115	Generator Brush Set	57
Gasket -Dome Light Lens	189, 190	Generator Bushing	57
Gasket -Gas Tank Sending Unit	90	Generator Oil Cover	57
Gasket -Hood Emblem	157	Generator Rebuild Kit	57
Gasket -Mirror Arm	197	Generator Rebuild Service	57
Gasket Sealer	26, 42, 47	Generator Warning Tag	252
Gasket Set	161	Glass Bowl	92
Gasket-Axle	110	Glass Channel Kit	228
Gasket-Backing Plate (Water Pump)	47	Glass Cleaner	21
Gasket-Door Handle	215, 216	Glove Box Accessory Book	248
Gasket-Fuel Pump	91	Glove Box Door	203
Gasket-Head	41	Glove Box Light	203
Gasket-Head To Water Outlet	47	Glove Box Lock	203
Gasket-Headlight Bucket	77	Glove Box-Cloth Lined	203
Gasket-In Line Filter Bowl	91	Glove Box-Like Original	203
Gasket-Instrument	202	Glove Compartment Lamp Installation Sheet	250
Gasket-Manifold	42, 95, 98	GM Script Tag	75
Gasket-Oil Distributor Valve	42	Good Housekeeping	248
Gasket-Oil Fill Cap	37, 42	Grease Fitting	131, 139
Gasket-Oil Pan	41	Grille	152-154
Gasket-Overhaul	41	Grille Bolt Kit	154
Gasket-Push Rod Cover	41	Grille Center Strip	152, 153
Gaskets-Running Board To Fender	163	Grille Center Strip Clip	153
Gasket-Thermostat Housing	47	Grille Decals	155
Gasket-Timing Cover	41	Grille Emblem	152, 153
Gasket-Valve Cover	41	Grille Filler Panel	153, 154
Gasket-Valve Grind	41	Grille Lettering	153
Gasket-Water Pump to Block	47	Grille Moulding Clips	153
Gauge -Ammeter	201	Grille Screw Set	153
Gauge Cluster	200	Grille Shell	152
Gauge Cluster (V8)	199	Grille Side Moulding	152
Gauge -Fuel	201	Grille Upper Moulding	153
Gauge -Oil Pressure	201	Grille-Billet Aluminum Bars	152
Gauge Repair	202	Grille-Side Moulding	152
Gauge -Temp	201	Grille-Vertical Bar	154
Gearshift Arm (Flaming River)	124	Grommet -Gas Filler	90
Generator	57	Grommet-Emergency Brake Release	193
Generator Band	57	Grommet-Gas Gauge Wire	91
Generator Bearing	57	Grommets -Bumper	148

Providing part numbers speeds up your order, improves accuracy and helps us maintain low prices.

See Illustration Index for core charge information and a list of abbreviations. For Body Model information, see Section 5T.



Format = Part No., Year, Description, Original Chevrolet Parts Book Group No., Price and Unit of Measure.

Grommet-Wiper Control Link	212	Heat Riser Shaft	98
Ground Strap	59	Heat Riser Spring	98
		Heater	253
Halogen Headlight Conversion	76	Heater & Defoster Motor	51
Halogen Headlight Conversion-Bulb	80	Heater & Defroster Hose	50
Halogen Turn Signal Kit -No Harness	69	Heater & Defroster Hose Clamps	50
Halogen Turn Signal Kit w/ Harness	69	Heater & Defroster Installation Sheet	250
Hand Brake Seal	183	Heater & Defroster Knob	50
Hat Pin	253	Heater & Defroster Nipple	50
Hats	14	Heater & Defroster Shutoff Valve	50
Header Panel	188, 209	Heater Box	51
Header Pipe	98	Heater Control Valve	50
Headlight	80	Heater Control Valve Rebuild Kit	50
Headlight - Halogen with LED Turn Signal. AutoNik Slick Signals	76	Heater Core Rebuild	51
Headlight Bucket	77	Heater Gasket	51
Headlight Bucket Assembly	77	Heater Grommet	50
Headlight Bucket Spring	78	Heater Harness	68
Headlight Bucket/ Housing	76	Heater Installation Sheet	250
Headlight Grommet	77, 161	Heater Motor	51
Headlight Knob	194	Heater Switch	50
Headlight Lens	76, 77	Heater Wiring Harness	50
Headlight Lens Seal	78	Hinge Pin	219
Headlight Pigtailes	67	Hinge Seal	219
Headlight Relay	79	Hold Down Screw	61
Headlight Rim	78	Hood Center Strip	156
Headlight Rim Seal Clip	78	Hood Corners	158
Headlight Stand Mounting Pad	77	Hood Deflector	156
Headlight Switch	78	Hood Emblem	157
Headlight Switch Retaining Nut	79	Hood Handle	158
Headlight Switch Shaft	79	Hood Hinge	157, 159
Headlight Visors	77	Hood Hinge Bolt	156, 158
Headlight Wire Grommet	77	Hood Latch Assembly	156
Headliner Bow	190	Hood Latch Lower Assembly	156, 170
Headliner Conversion	188	Hood Latch Plate	156, 170
Headliner -Die Cut	190	Hood Ornament	156
Headliner Extension	188	Hood Ornament - GMC	157
Headliner -Molded ABS Plastic	188	Hood Side Clips & Bolts	158
Headliner -Molded Fiberglass	188	Hood Side Emblem	157
Headliner Washers	190	Hood Side Moulding	158
		Hood To Cowl Seal	158

Returns require a return authorization number, Please call.



Format = Part No., Year, Description, Original Chevrolet Parts Book Group No., Price and Unit of Measure.

Hood To Grille Seal	158	Intermittent Delay Switch.	211
Hood-Fiberglass	156	[REDACTED]	
Hoodies	14	J-Nut Retainer	190
Horn.	64	Jute Insulation Pad	182
Horn Button	64	[REDACTED]	
Horn Button Assembly	64	K	
Horn Button Contact	64	Key Blank	62, 204, 215
Horn Button Pad	64	Key Decal	253
Horn Button Spring	64	Kick Panel-Metal Repair Panel	174
Horn Button S-wire	64	Kick Panels	190, 217
Horn Contact	64	King Pins	132
Horn Contact Plate	64	Knob	224, 230
Horn Harness	68	Knob-Window or Windshield	193
Horn Installation Sheet	250	[REDACTED]	
Horn Relay.	64	Latch Repair	216
Horn Wire Grommet	64	Leather Conditioner.	21
Horns.	64	LED Bed Roll Light	82, 236
Hose	211, 212	LED Bed Roll Light -Reverse Light	82
Hose Connector 3-way	212	License Fastener.	150
Hose -Fuel Line.	91	License Light Lens.	86
Hose -Gas Tank Filler	91	License Light Pad	86
Hose Set	45	License Plate Bracket	86, 150
Hub Caps -Custom	141	License Plate Frame	150
Hub Caps -Modified.	140-141	Lifters.	35
Hub Caps -Stock	142	Lighter Element	195
[REDACTED]		Line Clamp - Stainless.	88, 104, 113
Ignition Coil	61	Liner.	133
Ignition Coil - Pertronix 6 Volt	60	Lock & Key Service Manual.	250
Ignition Lock	62	Long Tie Rod.	129
Ignition Switch	60, 62	Lower Glass Sash Channel.	228
Ignition Switch Mounting Bracket	62	Lower Hoses	46
Ignition Switch Mounting Plate	62	Lowering Blocks	138
Inner Fender Apron Kit	176	Lubrication Sticker.	253
Inner Fender Panel (Fiberglass) -Front.	161	Lubricator & Bolt Loosener	23
Inner Fender Panel (Steel) -Front	160	Lug Nut	144
Instrument Glass	199, 201	[REDACTED]	
Insulation	178, 182	M	
Insulator.	54	Machine Super Wax	20
Interior Screws.	190, 218	Main Bearings	33
Intermediate Fuel Line.	90	Main Fuel Line.	94
		Main Wire Harness-Chevrolet	66

Providing part numbers speeds up your order, improves accuracy and helps us maintain low prices.

See Illustration Index for core charge information and a list of abbreviations. For Body Model information, see Section 5T.



Main Wire Harness-GMC 67
 Main Wire Harness-Replacement Chevrolet 67
 Main Wire Harness-Replacement GMC 67
 Main Wire Harness-Street Rod 66
 Main Wire Harness-Street Rod Truck 66
 Master Cylinder 117
 Master Cylinder & Brake Booster Assy 112-113
 Master Cylinder Rebuild Kit 117
 MEK1 Engine Kit 32
 MEK2 Engine Kit 32
 Metal Clips 178
 Metal Cover 43
 Metal Elbow 46
 Metal Filler Panel 171
 Metal Frame Joint Clips 217
 Metal Plug 105, 182
 Metal Polish 22
 Metal Prep 25, 89
 Metal Retainer 163, 220
 Metal Trim Plate 217
 Mirror Arm -Exterior 197
 Mirror Bracket-Interior 196
 Mirror Glare Proof 253
 Mirror Head 196
 Mirror -Rear View 196
 Mirror -Rear View (Day/ Night) 196
 Mirror-Peep 196
 Mirror-Peep Installation Sheet 250
 Mirror-Vanity Installation Sheet 250
 Model 1:6 Scale Chevy Small Block 15
 Motor Mount-front 43
 Motor Mount-rear 43
 Moulded Lower Hose 46
 Mount Bracket 56
 Mounting Gasket-Fuel Pump 92
 Mounting Pads 71
 Mud Flaps 161
 Muffler 99
 Muffler Clamp 99
 Muffler Hanger 99

N

Neon Marquee Sign & Clock -72 Length 16
 Neon Marquee Sign -34 Length 17
 Neon Marquee Sign -48 Length 16
 Neon Marquee Sign -Large 10 Foot Length 16
 Neon Sign 14
 Neoprene Gasketing Foam 185-188
 New Radio 206, 207
 Nude Lady 142
 Nuts 213
 Nut-Thin Hex 208

O

Oakie Bushing 108
 Offenhauser Intake 2 Carb 87
 Offenhauser Intake 3 Carb 87
 Offenhauser Valve Cover 33
 Oil Additive 23
 Oil Dip Stick Tube 37
 Oil Distributor Valve 37
 Oil Fill Cap 36
 Oil Filter 253
 Oil Filter Element 38
 Oil Filter Hose 38
 Oil Filter Installation Sheet 250
 Oil Pad 24
 Oil Pan Plug 37
 Oil Pickup-Grommet 37
 Oil Pressure Line 37, 203
 Oil Pump 37
 Oil Pump Drive Gear 38
 Oil Pump Rebuild Kit 37
 One Piece V-Bent Windshield Glass 222
 O-Rings 60
 Overflow Tank 45
 Overflow Tank Decal 45, 253
 Overflow Tank Installation Sheet 250
 Owners Manual 246

P

Pad -Mirror Arm 197

Returns require a return authorization number, Please call.



Format = Part No., Year, Description, Original Chevrolet Parts Book Group No., Price and Unit of Measure.

Pad-Headlight Bucket	77	Plug	118, 182
Paint Lacquer	253	Plugs	60
Paint-Battery Tray	28	Points	61
Paint-cab Interior	28	Polarity Reverse Switch	54, 61
Paint-Carburetor	28	Polishing Ball	22
Paint-Cast Blast	28	Polishing Towel	22
Paint-Engine	27	POR-15 Rust Preventitive Paint	27
Paint-Exhaust	28, 100	Positive Cable	59
Paint-Heater	28, 51	Power Steering Conversion Kit	131
Paint-hub Caps & Trim	28	Power Tailgate Lift Kit	235
Paint-Inner Fender Panel	28	Power Window Conversion	230
Paint-Radio & Heater	28	Power Window Conversion -Cable Driven	230
Paint-Zero Rust	27	Power Window Conversion -Gear Driven Bolt In.	230
Panel Back Glass	223	Pressure Plate Bolt	102
Panel Below Grille	154	Pressure Plate Bolts	102
Park Light Assembly	70	Pressure Plate-Rebuilt	102
Park Light Body	70	Price Guide	248
Park Light Installation Sheet	250	PRK (Piston & Ring Kit)	32
Park Light Lens	71	Pros Pick Custom Bed - Chevy	235
Park Light Lens Gasket	71	Pros Pick Custom Roll Pan - Chevy	235
Park Light Rim	71	Pulley -Water Pump	46
Park Light Rim Screws	71	Pushbutton	215
Parts Book	246	Pushrods	35
Parts Book on CD	246, 247		
Parts Interchange	246	O	
Passing Lamp Installation Sheet	250	Quality Control Card	253
Pedal Pad	183		
Pilot Bearing	101-102	R	
Pilot Bushing	102	Radiator (Copper-Brass)	45
Pinion Bearing	110	Radiator Cap	45, 156
Pinion Seal	110	Radiator Core Support	45, 170, 176
Pin-Lock	116	Radiator Hose Clamps	46
Pistons	34	Radiator Hose Set	46
Pitman Arm	131	Radiator Insect Screen Installation Sheet	250
Pitman Shaft	128	Radiator Petcock	45-46
Pitman Shaft Seal	128	Radiator V-8 (Copper-Brass)	44-45
Pivot Pin	226	Radio	205-207
Pivot Pins	105	Radio Manual	250
Pivot Rubber Bushings	212	Radio Shop & Service Manual	250
Plastigauge	33	Radio Tubes	208
		Rear Axle Bearing	110
		Rear Axle Bearing & Seal	110

Providing part numbers speeds up your order, improves accuracy and helps us maintain low prices.

See Illustration Index for core charge information and a list of abbreviations. For Body Model information, see Section 5T.



Format = Part No., Year, Description, Original Chevrolet Parts Book Group No., Price and Unit of Measure.

Rear Axle Seal 110
Rear Corner Cab Glass 223
Rear Corner Cab Glass (laminated) 223
Rear Corner Glass Rubber 233
Rear Crossmember 243
Rear Leaf Spring 139
Rear Pan 167
Rear Roll Pans 150
Rear Splash Apron 150
Rectangular Retaining Rubber 232
Remote w/ Linkage 217
Resistor 51
Retainer 215
Retainer Button 190, 217
Retainers w/ Screws 157
Return Spring 217
Reveal Mouldings 170
Reverse Idler Gear 105
Revive Polish 20
Ring & Pinion Conversion Kit 110
Ring & Pinion Installation Kit 110
Rings 34
Rocker Arm 35
Rocker Arm Shaft 35
Rocker Assembly 35
Rocker Panel 166, 169
Rocker Panel-Outer 172
Rod 33
Rod Bearing Shims 33
Rod Bearings 33
Rod Bolt & Nut 34
Rod Bolt Boots 34
Rod Dipper 34
Rod Service 33
Roller Bearing Conversion 145
Rotor 61
RPO Booklet 248
RRK Re-ring Kit 32
RRK3 (Re-ring Kit w/ Main Bearings) 32
Rubber Bellows 105

Rubber Boot 85, 118
Rubber Bumpers 203
Rubber Dressing 21
Rubber Grommet 216
Rubber Plug 179
Rubber Ring 127
Running Board Bolt Kit 163
Running Board Brackets 171
Running Board Mat 163
Running Board Step Plate 163
Running Board To Cab Seal 163
Running Boards w/ Built-in Mounting
Points (Fiberglass) 164, 167, 171
Running Boards w/ Built-in Mounting
Points (Steel) 164, 167, 171
Rust Remover 25

S

Sales brochure 246, 249
Screw (Pitman Shaft) 128
Screws & Sleeve Nuts 227, 229
Screws -Mirror Arm 197
Screws-Sealed Beam Retainer Ring 78
Seal 148, 183, 184
Seal & Bumper 183
Sealed Beam Retainer Ring 78
Sealer Slosh 89
Seal-Front Timing Cover 41
Seal-Rear Main 41
Seals 133
Seals -Shackle 139
Seat Belt Anchor Kit 189
Seat Belts 188
Seat Bumpers 191
Seat Cover 191
Seat Frame 191
Service Bulletins 248
Service Policy 253
Setting Tape 225
Setting Tape Door Glass 228
Shackle Rebuild Kit 132, 138

Returns require a return authorization number, Please call.



Format = Part No., Year, Description, Original Chevrolet Parts Book Group No., Price and Unit of Measure.

Shackles	132	Spotlight Handle	75
Shackles -Rear	138	Spotlight Template	251
Shift Fork	105	Spotlights	74
Shift Indicator (Flaming River)	123	Spray Glaze	20
Shift Knob	104, 195	Spring	98, 115
Shock Absorber Fluid	131	Spring & Pivot Pins	105
Shock Conversion Kit	131, 138	Stainless Steel Tubing	24
Shock Link	131	Stake Pocket Hole Covers	237
Shocks	131, 138	Stake Pockets	240
Shop & Service Manuals on CD	247	Stand -Headlight Bucket	76, 161
Shop Manual	247	Starter	54
Shop Manual on CD	246	Starter Band	55
Shop Manuals on CD	247	Starter Brush Set	54
Shop Supplement	247	Starter Bushing	55
Side Covers-Chevy Six Cylinder	33	Starter Drive	54
Side Splash Apron	164, 167, 170-171	Starter Oil Cover	55
Signs	253-254	Starter Pedal	183
Single Action Shock	138	Starter Pedal Return Spring	54
Sleeves-(Metal)	36, 95	Starter Rebuild Kit	54
Small Crossmember	242	Starter Rebuild Service	54
Small Parts Kit	106	Starter Solenoid	54
Smartcharge -Battery Charger	24, 56-57	Starter Solenoid Boot	54
Sockets & Bulbs For Park Lights w/ Turn Signals	70	Starter Solenoid Repair Kit	54
Soft Plug	105	Starter Switch	54
Soft Plug Set	37	Steering Column - Swing Away Kit	123
Sound Deadener-Thermal Protection	27	Steering Column Clamp	127
Sound -Vibration Damping	188	Steering Column Drop (Billet Specialties)	124
Spare Tire Carrier	245	Steering Column Drop (Flaming River)	124
Spark Plug Wire Set	60	Steering Column Insulator	127, 193
Spark Plug Wires	60	Steering Gear Overhaul Kit	127
Speedometer	200	Steering Shaft Support Bearing	126
Speedometer Assembly	199	Steering Shaft-Billet (Flaming River)	125
Speedometer Cable	106, 202	Steering Shaft-Stainless (Flaming River)	125
Speedometer Conversion	103-104	Steering Wheel	126
Speedometer Hand	202	Stools	15
Spindle Nut & Washer	144	Stools -Custom Wheel	14
Sponge Seal	179	Stove Bolt	36
Spotlight	74, 81	Strap Bracket	224
Spotlight Brackets	75	Striker	203
Spotlight Card	254	Stud For Lug Nut	144

Providing part numbers speeds up your order, improves accuracy and helps us maintain low prices.

See Illustration Index for core charge information and a list of abbreviations. For Body Model information, see Section 5T.



Format = Part No., Year, Description, Original Chevrolet Parts Book Group No., Price and Unit of Measure.

Studs In Manifold 98
 Suburban Front Side Glass 223
 Suburban Qtr Rear Glass 223
 Suburban Rear Side Glass 223
 Suburban/ Panel Back Glass 223
 Sunvisor 189, 251
 Sunvisor Assembly 189
 Sunvisor -Exterior 170, 172, 172, 189
 Sway Bar 133
 Swirl & Haze Remover 20
 Switch 74, 86

T

Tail Light 83, 85
 Tail light - Truck Bed 236
 Tail Light Assembly 83, 84
 Tail Light Assembly -Panel & Suburban (optional). . 84
 Tail Light Brackets 85
 Tail Light Panel & Suburban 85
 Tail Light -Panel & Suburban (optional). 84
 Tail Light Pigtails 85
 Tail Lights. 83
 Tailgate 243
 Tailgate - Custom. 235, 243
 Tailgate - Hidden Latch 236
 Tailgate Chain Covers 244
 Tailgate Chains 244
 Tailgate Cover 243
 Tailgate Decal 244
 Tailgate Hinge Adapter 236
 Tailgate Hinges 235, 244
 Tailgate Link Assembly 236
 Tailgate Skin 244
 Tailpipe 99
 Tailpipe Clamp 99
 Tailpipe Hanger 99
 Tailpipe Heat Shield. 99, 243
 Tailshaft Bushing 105
 Tank Straps 90
 Teflon Liner 139

Telescopic (Power) & Tilt Steering Column (Flaming River). 121-123
 Terminal Boards. 68, 78
 Terminal Boot. 90
 Thermometer -Wall Mount. 19
 Thermostat 47
 Throttle Cable Assembly 194
 Throttle Knob. 194
 Throttle Return Spring. 94
 Throw Mats 182
 Throwout Arm Ball. 102
 Throwout Arm Spring. 102
 Throwout Bearing 102
 Tie Rod End. 129
 Tilt Column Wiring Accessories (Flaming River) . . 124
 Tilt Steering Column-Column Shift (Flaming River) 123
 Tilt Steering Column-Floor Shift (Flaming River). . 123
 Timing Gear. 36
 Timing Hole Plug. 37, 62
 Tin Sign 19
 Tinnerman Nuts. 115, 144
 Tire - Black Wall, Bias Ply 144
 Tire - Black Wall, Radial 144
 Tire - White Wall, Bias Ply. 144
 Tire - White Wall, Radial 143
 Tire Care 23, 144-145
 Tire Pump Decal 254
 Tires. 143
 Tissue Dispenser. 196
 Toe Board (Metal) 174
 Tool 102, 109, 226, 233
 Tool Bag. 23
 Tools-Body. 23
 Tools-Engine, Drivetrain 23
 Tools-Interior 23
 Torque Tube. 108
 Town & Country Horn Installation Sheet 250
 Traffic Light Viewer 192-193
 Transmission Gasket Set 105
 Transmission Mount 106

Returns require a return authorization number, Please call.



Format = Part No., Year, Description, Original Chevrolet Parts Book Group No., Price and Unit of Measure.

Transmission Rebuild 106
 Transmission Wire Harness-GMC 67
 Tri-Bar Headlight Cover-Blue Dot 76
 Tri-Bar Headlight Cover-Chrome Bullet 77
 Trim Clip 224
 Trim Plate 183
 Trim Ring 104, 183
 Truck Cover 22
 Truck Cover - Accessories 22
 T-Shirt 14
 Tube 144
 Tube Headers 97
 Tube Shock Mounts 131, 138
 Turn Signal Flasher 69
 Turn Signal Flasher -Audible 69-70
 Turn Signal Flasher -LED 69, 80
 Turn Signal Harness 70
 Turn Signal Knob 70, 194
 Turn Signal Switch 69
 Turntable 14

U

U-Bolt 133, 139
 U-clip 116
 U-joint Assembly 108
 U-joint Lock Plates 108
 U-joint Rebuild Kit 108
 U-joints--Billet-Joint Steering Box (Flaming River) 125
 U-joints--Billet-Joint Steering Column (Flaming River) 125
 U-joints--Stainless Steering Box (Flaming River) . 126
 U-joints--Stainless Steering Column (Flaming River) . 126
 Umbrella Holder Installation Sheet 251
 Undercarriage Spray 21
 Underhood Lamp Installation Sheet 251
 Underhood Light 158
 Universal Battery Boxes 175
 Universal Heater 50
 Universal Heater-Defroster 50
 Upholstery Batting 191

Upper Hose 46
 Utility Pocket Unit Installation Sheet 251

V

Vacuum Advance 62
 Vacuum Advance Line 94
 Vacuum Hose 212
 Valve 34
 Valve & Rocker Cover Set 33
 Valve Cover 33
 Valve Cover Decal 254
 Valve Cover-Acorn Nut 36
 Valve Cover-Grommets 36
 Valve Guide 34
 Valve Seals 35
 Valve Seats 34
 Valve Spring Cap 35
 Valve Springs 35
 Valve Stem Cap 142, 144
 Valve Stem Locks 35
 Vent Window Assembly 226
 Vent Window Handle 226
 Vent Window Rubber 226
 VHT Hi-Temp Engine Enamel 27
 Vibrator 208
 Vintage Chevrolet Cooler 14
 Voltage Booster 199
 Voltage Booster -Radio 205
 Voltage Cut Out 58
 Voltage Reducer 50, 88
 Voltage Regulator 58

W

Windshield Pillar Panel 172
 Windshield Upper Roof Panel Brace 172
 Wall Sign 19
 Warranty Card 254
 Watches 16
 Water Pump 46
 Water Pump -Polished Pulley 46
 Wayne Valve Cover 33
 Weatherstrip Cement 26, 221, 228

Providing part numbers speeds up your order, improves accuracy and helps us maintain low prices.

See Illustration Index for core charge information and a list of abbreviations. For Body Model information, see Section 5T.



Index

Format = Part No., Year, Description, Original Chevrolet Parts Book Group No., Price and Unit of Measure.

Weatherstrip Clips	221	Wiper Motor-Vacuum Operated	212
Web Adhesive Spray	182	Wiper Motor-Vacuum Operated Rebuild	212
Wheel Cylinder Rebuild Kit-Front	118	Wiper Transmission & Link Assembly	211
Wheel Cylinder Rebuild Kit-Rear	118	Wire	68, 75
Wheel Cylinder-Front	118	Wire Assembly	75
Wheel Cylinder-Rear	118	Wire Conduit	86
Windlace Retainer	220	Wire Loom	65,68
Window Crank	230	Wire Looms	60
Window Crank Switch	230	Wire Stop	195
Window Regulator	230	Woodruff Keys	36
Window Reveal Mouldings	170, 228	Wrist Pins	34
Window Shades	228		
Window Stop Bumper	229		
Window Wiper	228		
Windshield Crank	193, 224		
Windshield Divider	224		
Windshield Divider Moulding	190		
Windshield Frame	224		
Windshield Frame Connecting Inserts	224		
Windshield Frame Seal	225		
Windshield Glass	222		
Windshield Moulding	224		
Windshield Regulator Rebuild	224		
Windshield Rubber	224, 225		
Windshield Rubber Bumper	224		
Windshield Washer	254		
Windshield Washer Hose	212		
Windshield Washer Installation Sheet	251		
Windshield Washer Nozzles	213		
Windshield Wiper Installation Sheet	251		
Wing Nut	92		
Wiper Arm	211, 212		
Wiper Arm & Blade (Billet)	211		
Wiper Blade	212		
Wiper Cap	209		
Wiper Control Link	212		
Wiper Knob	193, 212		
Wiper Motor -Electric	210		
Wiper Motor Electric Kit	209		
Wiper Motor Pivot Linkage Retainer	212		

Returns require a return authorization number, Please call.



Referred by: (Name of publication, friend, etc.)		<input type="checkbox"/> Yes, send me additional order forms!	
Credit Card #:		Name on Card:	
Expiration Date:	Card Security Code:	Card Holder's Signature:	
Model # from firewall or door post plate:	Year:	Body: (4Dr, 1/2T, etc.)	Transmission: 3Spd: <input type="checkbox"/> 4Spd: <input type="checkbox"/> Powerglide: <input type="checkbox"/>
Date:	Series: (Master, 210, Bel Air, etc.)		Hydromatic: <input type="checkbox"/> Other: <input type="checkbox"/>
Customer #:		Home phone:	
Name:		Work phone:	
Street:		Fax:	
City:	State:	Zip:	Email address:
UPS: <input type="checkbox"/> *2nd Day: <input type="checkbox"/> *Next Day: <input type="checkbox"/> * Call for rates—(360) 816-0211			

Qty	Part #	Part Description	\$\$\$

<p>Receive Your Parts Up To 2 Weeks Faster! You don't even have to mail this order!</p> <p>Electronic check processing is faster (as much as 10 days faster than mailing us a check!) Try it and receive 4% off your first electronic-check order-by-phone.</p> <p>Sign and date the Check Authorization below and</p> <ul style="list-style-type: none"> • Fax your order and check toll-free to 1-(800)-888-CHEV (2438) or • E-mail your scanned order and check to Chevs@chevsofthe40s.com or • Simply do it all by phone—call toll-free 1-(800)-999-CHEV (2438) <p style="text-align: center;">Check Authorization</p> <p>Signed: _____ Authorized Signee</p> <p>Dated: _____</p> <p>Note: In the event your payment is returned for any reason from your DEPOSITORY, you hereby agree to pay a return fee charge of \$10.00. This charge could be processed through the ACH Check Representation System or by Bank Draft.</p> <div style="text-align: center;"> </div>	Subtotal		
	Total previous page		
	Shipping & handling Estimated shipping & handling fees (continental USA): We ship using UPS only		
	Misc. fees & charges (Packing/Oversize—Certain oversized parts sent truck collect.)		
	WA state residents are charged sales tax. Rates vary depending on region.		
	Total		
Received			
Balance due			

Returns require a return authorization number, Please call.