

GOLDWING

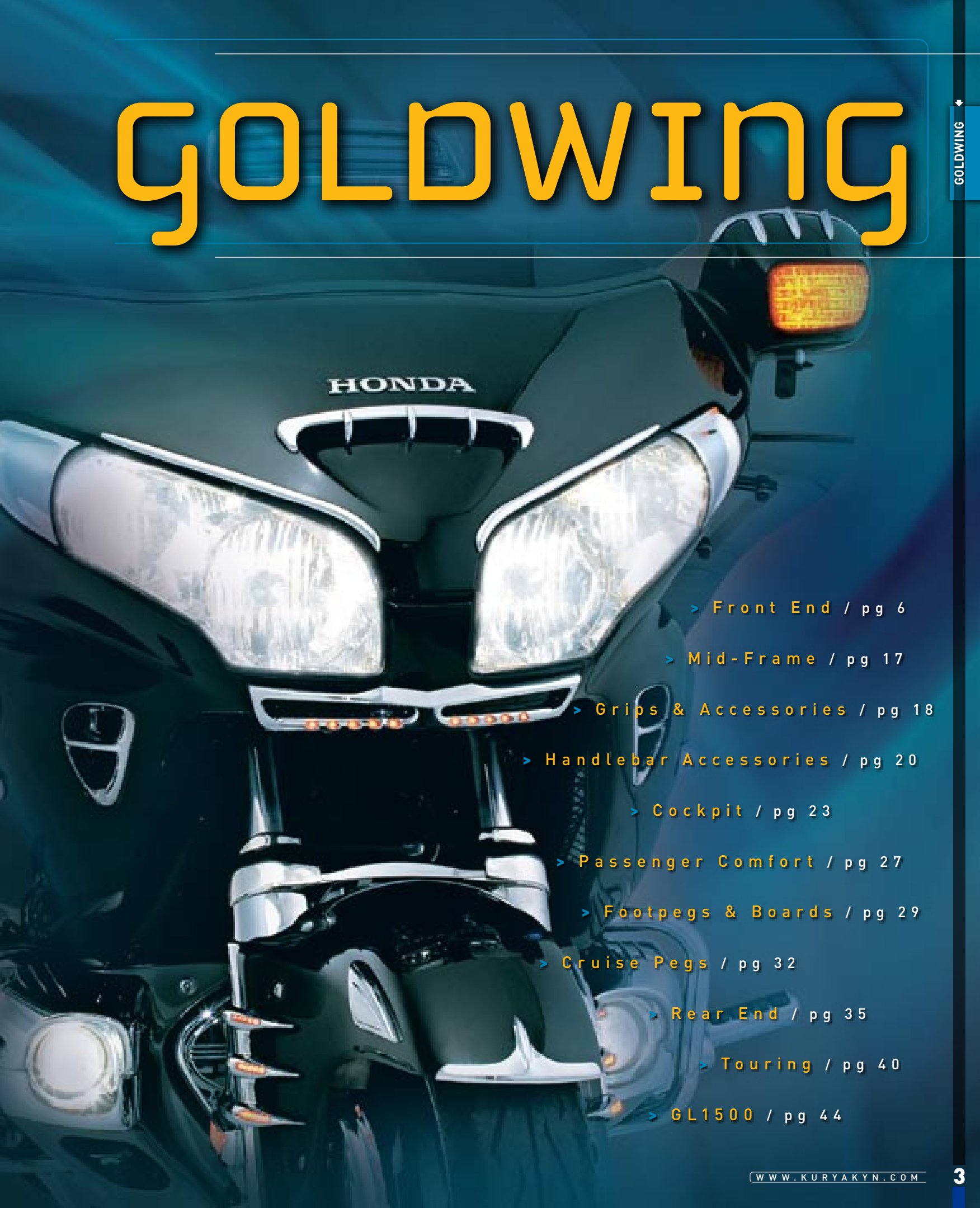

> Front End / pg 6

> Mid-Frame / pg 17

> Grips & Accessories / pg 18

> Handlebar Accessories / pg 20

> Cockpit / pg 23

> Passenger Comfort / pg 27

> Footpegs & Boards / pg 29

> Cruise Pegs / pg 32

> Rear End / pg 35

> Touring / pg 40

> GL1500 / pg 44

GOLDWING

AT-A-GLANCE

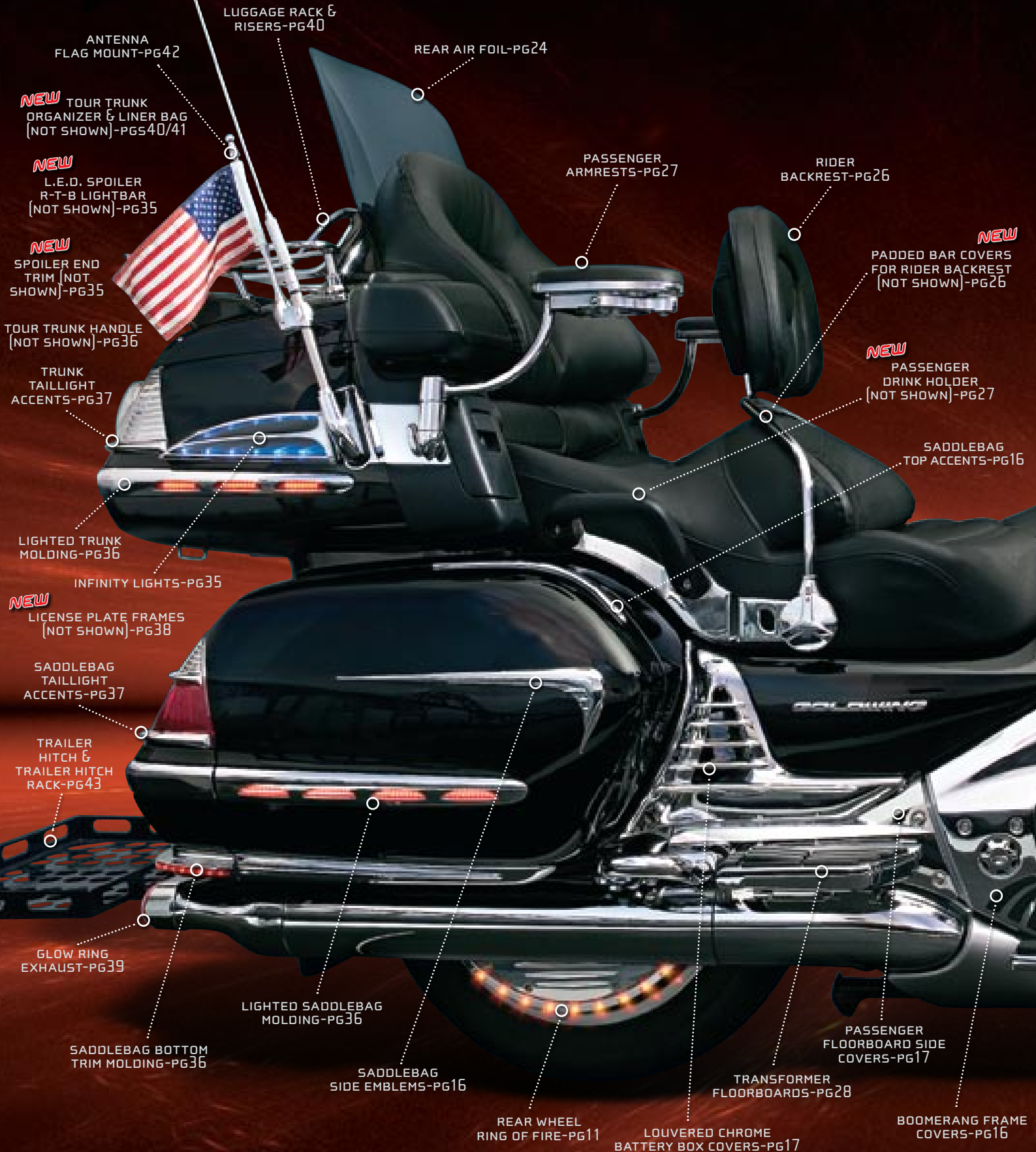

It Doesn't Stop Here! More Products That Fit Your GoldWing Inside!



HANDLEBAR **NEW**
ACCESSORIES
(NOT SHOWN)-PG520/21

ISO-GRIPS FOR
HEATED GRIPS-PG19

CLUTCH & BRAKE
LEVERS-PG18

CHROME **NEW**
COCKPIT COVERS
(NOT SHOWN)
PG23

PERFORMANCE
WINDSHIELD-PG25

BEAR CLAW
MIRROR ACCENT-PG7

NEW
WINDSHIELD TRIM
(NOT SHOWN)-PG7

DRAGON WINGS-PG24

FAIRING
SCOOP TRIM-PG7

CHROME
EYEBROWS-PG7

CHROME TANK TRIM
WITH KNEE PADS **NEW**
(RENDERING SHOWN)-PG23

HIGH PERFORMANCE
HEADLAMP BULBS-PG12

PREMIER SHARK GILLS **NEW**
WITH RADIATOR VENT TRIM-PG13

CHROME GRILL-PG7

FAIRING INTAKE VENT INSERTS-PG15

SHARK SKIN (RENDERING SHOWN)-PG13 **NEW**

FORK BRACE &
CHROME DUST COVERS-PG6

FRONT FENDER
TIP-PG9

SHARK
TOOTH FENDER
ACCENT-PG9

LIGHTED
FORK TOWER
ACCENT-PG10

ROTOR COVERS
& L.E.D. RING OF
FIRE-PG11

AERO HEAD
MARKER LIGHT
PG10

CHROME TIMING
CHAIN COVER
(NOT SHOWN)-PG15

ERGO II **NEW**
CRUISE
MOUNTS-PG33

NEW COWL DRIVING
LIGHTS-PG12 &
LOWER COWL
CHROME COVER-PG15

CHROME
WHEEL SPOKE
COVERS-PG11

L.E.D. FRONT
REFLECTOR
CONVERSION-PG10

BRAKE &
ARM COVER
(NOT SHOWN)
PG30

WIDE BRAKE
PEDAL COVER-PG29

FAIRING
LIGHT II-PG15

LIGHTNING
VALVE COVERS-PG14

DRIVER
FLOORBOARDS
PG29



Rendering Shown

A **FORK BRACE & CHROME DUST COVERS** for GL1800

Küryakyn is pleased to invite you to a wedding...of sorts. Please join us in celebrating the union of our beautiful second generation Chrome Fork Dust Covers with our brawny, high-tech Chrome Fork Brace. This is the only brace on the market that provides the perfect fit & allows for those little variations that are found from bike to bike. A perfect marriage, they work together to improve appearance, handling & ride, while replacing the stock plastic fork bridge. Although they are available separately, this is a couple that was just meant to be.

Fits: '01-'09 GL1800 (except Airbag Models)

	8615	Fork Brace for GL1800 (ea)	\$259.99
NEW	8636	Chrome Fork Dust Covers for GL1800 (pr)	\$51.99
NEW	8637	Fork Brace with Dust Cover for GL1800 (set)	\$299.99

**Updated
Look!**

KÜRYAKYNIZED — FRONT END

B WINDSHIELD TRIM with Turn Signal Accents for GL1800

Patent Pending

You appreciate ooo's & ahh's from onlookers, so here's another chance to amaze the crowd. This Windshield Trim is a huge improvement over the plain black rubber it conceals - a pristine chrome finish punctuated with crisp L.E.D. turn signal accents. The result is a clean transition from the windshield to the fairing & a higher degree of visibility as well. A great look with simple plug-&-play installation!

Fits: All '01-'09 GL1800 Models ('06-'09 GL1800's require P/N 7300 for plug-&-play installation)

1367 | Windshield Trim with Turn Signals (ea) | \$199.99

Built-In Turn Signals!



Rendering Shown

Coming Soon

NEW



C BEAR CLAW MIRROR ACCENT for GL1800

Wrap the top of your mirror with this daring chrome accent. No chintzy chrome trim here, these look great from the driver's position & will dazzle others as you pass them by. With simple peel-&-stick application, these should be a requirement for all GoldWings.

Fits: '01-'09 GL1800 Models

7324 | Bear Claw Mirror Accent (pr) | \$59.99

D FAIRING SCOOP TRIM for GL1800

U.S. Patent D575,200 & D582,818

Add some sophistication & class with this easily installed scoop trim. Render the crowds speechless when you combine with our Chrome Eyebrows for a spectacular look.

Fits: '01-'09 GL1800 Models

7322 | Fairing Scoop Trim (ea) | \$32.99



E CHROME EYEBROWS™ for GL1800

U.S. Patent D575,199

Our Chrome Eyebrows close that unsightly gap between your headlamps & fairing. This beautifully radiused chrome strip melds the fairing components together perfectly. Adding some elegance to your fairing couldn't be easier.

Fits: '01-'09 GL1800 Models

7323 | Chrome Eyebrows for GL1800 (pr) | \$49.99

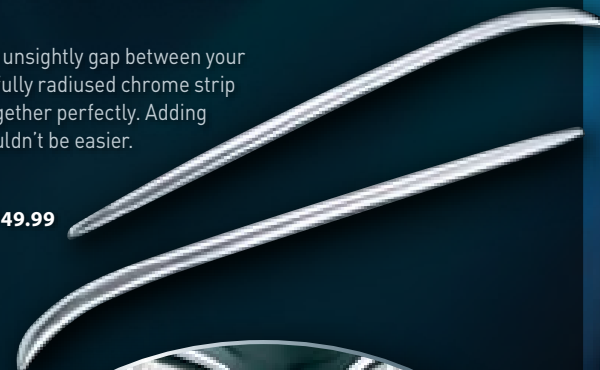

F CHROME GRILL for GL1800 Patent Pending

Incorporate our Chrome Grill (choose lit or unlit) & prepare to smile as onlookers keep children away from what appears to be the chromed air intake for a pavement gobbling monster. The amber L.E.D. running lights really look sharp for that screaming red hot performance. No one needs to know it provides visual horsepower only.

Fits: All '01-'09 GL1800 Models

7327 | Chrome Grill for GL1800 (ea) | \$59.99

7328 | Amber L.E.D. Lighted Grill for GL1800 (ea) | \$119.99

Note: Will not work with Sport/Touring Lamp Kit (P/N 2218).

Comes With or Without Running Lights





Take it to the MAX! Ultra Bright 7-Color L.E.D.'s!

Shown with Our Infinity Lights
(P/N 4622 - pg 35)

NEW SUPER LIZARD LIGHTS for GL1800

These all new seven-color L.E.D. Super Lizard Light kits allow you to simply & easily highlight the flowing lines of your Goldwing! Choose how wild you want to go with our two available kits. Both kits feature 6 of our new Super Lizard Lights while the Premier Kit (P/N 5027) also includes our new Long Lizard Lights! The peel-&-stick installation & simple plug-&-play wiring makes accenting your bike easier than ever!

Fits: '01-'09 GL1800 Models

5026	Super Lizard Starter Kit for GL1800	\$329.99
5027	Premier Super Lizard Maximus Kit for GL1800	\$499.99

Note: P/N 5027 & 4627 will install with one controller. Any additional Lizard lights or Infinity Lights will require an additional Controller for installation.



5027



5026

7-Colors
in One!

7-Color L.E.D. Kits Boast Three Spectacular Modes:

- Single Color Steady Illumination
- Single Color Flashing Illumination With Variable Rate
- Paint Mode: All Lights in Unison Continuously Cycle Through All Seven Colors (Red, Lime, Ice Blue, Sky Blue, Dark Blue, Purple, & Green) with an Adjustable Variable Rate

See More Lizard
Lights - pg 48



L.E.D. FAIRING LIGHTS for GL1800

Give your Goldwing fairing a completely new look by adding our cool L.E.D. accent lights! We offer multiple kits to make your bike a real show stopper! The L.E.D. fairing kits contain 4 lights to set your front fairing scoop & side intake vents ablaze! Available in mesmerizing seven-color L.E.D. technology (P/N 4627), or stunning amber color (P/N 4628). Intensify the excitement by combining these kits with our Fairing Scoop Trim (P/N 7322) & Fairing Intake Inserts (P/N 3900).

Fits: '01-'09 GL1800 Models

4627	L.E.D. Lizard Fairing Lights (set)	\$197.99
4628	L.E.D. Amber Fairing Accent Lights (set)	\$166.99

Note: P/N 4628 for '06-'09 GL1800's requires P/N 7300 for plug-&-play installation.



4627

>> Choose Amber or
7-Color L.E.D.'s!



7303

L.E.D. FRONT FENDER ACCENT for GL1800

Designed to blend with the smooth lines of the GL1800 front fender, this sleek chrome molding encases a slim lens, housing a bright series of L.E.D.'s. Stunning good looks & additional visibility will make this a popular addition to any GL1800.

Fits: '01-'09 GL1800 Models

7303 | L.E.D. Front Fender Accent for GL1800 (pr) | **\$83.99**



SHARK TOOTH FENDER ACCENTS for GL1800

Fill in the gaping holes on your front fender with the stylish Shark Tooth Fender Accents. These little beauties add that finishing touch to the empty holes on the front fender.

Fits: '01-'09 GL1800 Models

7320 | Shark Tooth Fender Accents (pr) | **\$49.99**



7320

FRONT FENDER TIP for GL1800

Combine beauty & protection with our Front Fender Tip! Incorporate our L.E.D. Front Fender Accent (P/N 7303) & create a perfect pair for your front fender! Simple installation.

Fits: '01-'09 GL1800 Models

7321 | Front Fender Tip (ea) | **\$31.99**



7321

FRONT FENDER EXTENSION for GL1800

Keep a lot of water & dirt down on the road where it belongs with this functional chrome accessory. Extends fender just over three inches.

Fits: '01-'09 GL1800 Models

7354 | Front Fender Extension (ea) | **\$31.99**



FRONT FENDER EXTENSION for GL1800

This Front Fender Extension for the GL1800 is a must-have item. Besides looking sharp, this will really tame the road spray when riding in the rain. Extending the fender four inches & made of sparkling chrome & black rubber, this neat little piece is easy to install on stock front fenders, or those with the Honda extension previously installed.

Fits: '01-'09 GL1800 Models

7352 | Front Fender Extension for GL1800 (ea) | **\$69.99**

7353 | Replacement Rubber for 7352 (ea) | **\$17.99**



7340

TRICEPTOR FENDER ACCENT for GL1800

WOW! Add the cutting edge in fender tips or move it back & splash the perfect chrome accent on your front fender. You decide where it looks best. With simple peel & stick installation, this gem will add some spark to your front fender & cover unsightly stone chips.

Fits: '01-'09 GL1800 Models (As fender tip or front fender ornament)

7340 | Triceptor Fender Accent (ea) | **\$41.99**

Note: Additional fitment for some Metric Cruisers - pg 127.

Fender Tip or Chrome Accent!



**All Are
Running Lights
& Turn Signal
Accents!**



**A LIGHTED FORK
TOWER ACCENTS**
for GL1800

Add visibility with class. The three spear towers are filled with L.E.D. running lights with the top spear doubling as a turn signal. With plug-&-play installation & chrome that contours to your front fender, this accent is a must have.

Fits: '01-'09 GL1800 Models (except Airbag Models) ('06-'09 GL1800's require P/N 7300 for plug-&-play installation)

7445 | Lighted Fork Tower Accents for GL1800 (pr) | **\$179.99**

**B AERO HEAD
MARKER LIGHTS** for GL1800

Increase your visibility with these great L.E.D. Marker Lights. With simple plug-&-play installation on either Honda or Kuryakyn Rotor Covers, easily complete the bottom of your front forks while adding a touch of pizzazz.

Fits: '01-'09 GL1800 Models ('06-'09 GL1800's require P/N 7300 for plug-&-play installation)

7458 | Aero Head Marker Lights (pr) | **\$72.99**

Note: Installs on Kuryakyn or Honda Rotor Covers.



C L.E.D. FRONT REFLECTOR CONVERSION
for GL1800

Replace the ho-hum amber reflectors on your lower forks with an array of amber L.E.D.'s! Both running lights & turn signals for an added measure of visibility.

Fits: '01-'09 GL1800 Models ('06-'09 GL1800's require P/N 7300 for plug-&-play installation)

7455 | L.E.D. Front Reflector Conversion (pr) | **\$59.99**

KÜRYAKYNIZED — FRONT WHEEL



E CHROME WHEEL SPOKE COVERS for GL1800

Patent Pending

No need to spend a ton on chroming your wheel. These easy to install chrome accents make a huge statement. Lots of flash especially if you have our Ring of Fire. Very light weight & even distribution so re-balance is not necessary.

Fits: All '01-'09 GL1800 Front Wheels

7569 Chrome Wheel Spoke Covers for GL1800 (set) | \$159.99



ADAPTER PLUG for Front Turn Signal Accents

Enables you to plug-&-play Kuryakyn front turn signal accents into your '06-'09 GL1800. Required with Fairing Light II (P/N 7315 & 7316), Aero Head Marker Light (P/N 7458), L.E.D. Front Reflector Conversion (P/N 7455), Lighted Fork Tower Accents (P/N 7445), Amber Fairing Accent Lights (P/N 4628), & Windshield Trim (P/N 1367).

7300 Required for Plug-&-Play Installation on '06-'09 GL1800 (pr) | \$20.99



REAR WHEEL RING OF FIRE for GL1800

We see your love for the "glow" from the front wheel Ring of Fire; now light the rest of your GoldWing with the Rear Wheel Ring of Fire. With all the mounting hardware you need, these beauties cast that same glow out from under your saddlebags. With Red/Red lighting, let the light shine.

Fits: '01-'09 GL1800 Models

7395 Rear Wheel Ring of Fire (ea) | \$145.99

D L.E.D. RING OF FIRE™ for GL1800

The Chrome Rotor Covers & Ring of Fire will really take center stage on your GL1800. The beautifully chromed disc brake Rotor Covers change the plain, unfinished axle retainer, hub & brake rotor into one sleek gleaming unit. In the daylight, they'll shimmer in the sunshine, but night time brings out another dramatic effect. Brilliant, weather resistant amber L.E.D.'s punctuate the slots in the trim ring, while another inboard set of L.E.D.'s reflect on the front wheel, setting it ablaze with your choice of color.

If you prefer a more subtle look, the chrome Rotor Covers are available without the L.E.D. lighting effects. Separate Ring of Fire kits are available as an upgrade if you choose to add them at a later time or if you desire different colors.

Chrome Rotor Covers with L.E.D. Ring of Fire

Fits: '01-'09 GL1800 (except Airbag Models)

7451 Chrome Rotor Covers with Amber/Amber Ring of Fire (pr) | \$270.99

7454 Chrome Rotor Covers with Amber/Red & Blue Ring of Fire (pr) | \$299.99



7454

Chrome Rotor Covers

Fits: '01-'09 GL1800 (except Airbag Models)

7450 Chrome Rotor Covers (pr) | \$124.99



7450

L.E.D. Ring of Fire

Showcases a vibrant amber shine outward with multiple color options shining inward.

Fits: '01-'09 GL1800 Models (Installs on Kuryakyn or Honda Rotor Covers)

7390 L.E.D. Ring of Fire, Amber Light Shining Inward (pr) | \$145.99

7391 L.E.D. Ring of Fire, Blue Light Shining Inward (pr) | \$179.99

7392 L.E.D. Ring of Fire, Blue & Green Light Shining Inward (pr) | \$179.99

7393 L.E.D. Ring of Fire, Red & Blue Light Shining Inward (pr) | \$179.99



7392



LET THE LIGHT SHINE!



Shown with Lower Cowl Chrome Covers (P/N 3906 - pg 15)

LOWER COWL DRIVING LIGHTS for GL1800

NEW

Dark country roads, dense fog, driving rain, & animals lurking in the ditches are just a few of the many reasons Kuryakyn's Foglight Kit makes such good sense. Super bright 35 watt halogen beams pierce the darkness helping you to see & be seen. Total adjustability from the front of the cowl requires no disassembly so you can place all of this light exactly where you want it. The complete kit includes everything needed for easy installation.

Fits: '01-'09 GL1800 Models (except Airbag Models)



2232	Lower Cowl Driving Lights for GL1800 (pr)	\$169.99
2229	Exact Replacement Driving Light Bulb - 35 Watt Super White H-3 (ea)	\$10.99

Note: 2-1/2" diameter light includes wiring harness with switch.

SPORT/TOURING LAMP KIT for GL1800

1100X Powersports Lamps. This high-quality kit comes complete with two PIAA Powersports 1100X Lamps, two custom mounting brackets, wiring harness, & all necessary hardware & instructions to customize your ride.

Fits: '01-'09 GL1800 Models



2218	Driving Lights for GL1800 (pr)	\$359.99
2221	Replacement Bulb (ea)	\$32.99

Note: Will not install with Chrome Grill (P/N's 7327 or 7328).



SUPER SPOTS Extreme Xenon Super White Bulb

High Power

- Extend visual lighted range approximately 30%
- Extreme white appearance, 4100K color rated
- Affordable price for the light you want



2222	H-4 Style 60/55 Watt (ea) Fits: All GL1500	\$29.99
2223	H-7 Style 55 Watt (ea) Fits: '01-'09 GL1800	\$29.99

Limited Lifetime Warranty from WixTech

Upgrade Your Headlight Bulbs!

PIAA XTREME WHITE PLUS H-7 BULB for GL1800

These 4000k bulbs provide 110 watts of performance from only a 55 watt bulb! This means less draw on your battery while still getting the brilliant white light you need.

Fits: '01-'09 GL1800 or other H-7 applications



2220	PIAA Xtreme White Plus H-7 Bulbs (ea)	\$49.99
-------------	--	----------------

Add Vent Trim to Existing Shark Gills

7319

FEEDING FRENZY



Rendering Shown

CHROME SHARK SKIN RADIATOR GRATE for GL1800

Patent Pending

There's just one part of your GL1800 that still bugs you; the radiator vents. Dress up those boring stock plastic grates & add chromed Küryakyn Shark Skin grates. They incorporate a subtle custom scale mesh behind a stalking chrome creature that looks like it's ready to eat the road.

Fits: All '06-'09 GL1800 Models

7329 | Chrome Shark Skin (pr) | \$69.99

PREMIER SHARK GILLS WITH RADIATOR VENT TRIM for GL1800 **NEW**

Make your mile munching GoldWing look like the asphalt eating predator it is with our Premier Shark Gills with Radiator Vent Trim. The Shark Gills are a racy, one-piece, chrome-plated accent that incorporates a streamlined main beam with six stylish vanes. Our new Radiator Vent Trim frames the opening, instantly giving the fairing vent an aggressive, high-speed appearance. They're held in place with a high-tech adhesive & installation requires no drilling or disassembly of the motorcycle.

Fits: '01-'09 GL1800 Models

Premier Shark Gills **NEW**

7319 | Premier Shark Gills with Fairing Radiator Vent Trim (set) | \$159.99
U.S. Patent D521,417

Shark Gills Only

7314 | Shark Gills (pr) | \$89.99
U.S. Patent D521,417

Fairing Radiator Vent Trim Only **NEW**

7318 | Fairing Radiator Vent Trim (set) | \$79.99
Patent Pending





A LIGHTNING VALVE COVERS for GL1800

U.S. Patent D522,930

With this set of Chrome Valve Covers you can create a sleek, uniform look without compromising the integrity of the stock valve covers & risking leakage or less than perfect fitment. Our chrome covers are held on by a two-sided adhesive pad designed specifically for high temperatures. They fit snugly right on top of the stock valve covers so they look exactly like replacement chrome covers, but without the expense or the potential headaches.

Fits: '01-'09 GL1800 Models

3901	Lightning Valve Cover for GL1800 (set/4)	\$169.99
3902	Replacement Adhesive Pads (set)	\$14.99



B FAIRING INTAKE VENT INSERTS for GL1800

Transform the plain-jane “black hole” fairing air intake vents with stylish chrome inserts. It couldn’t be easier – just clean the inlet surface, peel & stick!

Fits: '01-'09 GL1800 Models

3900 | Fairing Intake Vent Inserts for GL1800 (pr) | \$34.99



C LOWER COWL CHROME COVERS for GL1800

These streamlined beauties cover that blocky looking lower cowl on your Wing & install in minutes. These covers work with or without lower fog lights.

Fits: '01-'09 GL1800 Models

3906 | Lower Cowl Chrome Covers for GL1800 (pr) | \$124.99



Shown with Lower Cowl Driving Lights (P/N 2232 - pg 12)

D CHROME TIMING CHAIN COVER SET for GL1800 U.S. Patent D525,268

If your eyes hurt from looking at the ugly aluminum cam chain cover but you don't want the expense & hassle of having the cover chromed, you're in luck. Our Chrome Timing Chain Cover Set for GL1800 covers the entire timing chain cover in minutes. Just peel-&-stick! The strong adhesive is specially designed for high temperatures. A chrome version of the stock screw-in cap is included in the Chrome Timing Chain Cover Set or is available separately.

Fits: '01-'09 GL1800 Models

3909	Chrome Timing Chain Cover Set for GL1800 (set)	\$93.99
3908	Timing Hole Cap for GL1800 (ea)	\$31.99
3907	Replacement Adhesive Pads (set)	\$5.99



E FAIRING LIGHT II & MIRROR LIGHT KIT for GL1800

Our Fairing Light II & Mirror Lights go together like fireworks & the 4th of July! This kit is very easy to install with it's plug-in capability & will save you money & time! Our Fairing Light II features L.E.D. lighted accents which have both running lights as well as accent blinkers. Finish it all off with our L.E.D. Mirror Lights which have a slim design & do not detract or interfere with the viewable mirror surface, plus they add visibility. Buy the complete kit or purchase items separately — either way we have you covered!

Fits: '01-'09 GL1800 Models ('06-'09 GL1800's require P/N 7300 for plug-&-play installation)

7315	Fairing Light II & Mirror Light Kit (set)	\$124.99
7316	Fairing Light II (pr)	\$83.99
7513	L.E.D. Mirror Lights (pr) <small>Note: Mirror Lights require hard-wire installation when installed without additional Kuryakyn front turn signal accent lighting.</small>	\$59.99

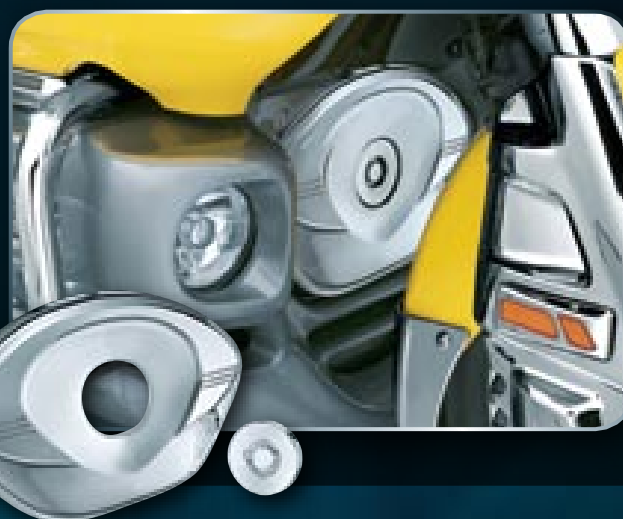



C BOOMERANG FRAME COVERS
with Scuff Protector for GL1800

We've made our enormously popular frame covers even better. We've added carefully designed & perfectly placed rubber scuff protectors in the crucial areas. Very stylish & practical!

Fits: '01-'09 GL1800 Models

3911	Boomerang Frame Covers with Scuff Protector (pr)	\$135.99
3912	Replacement Scuff Protection Rubbers (set)	\$12.99

D SADDLEBAG SIDE EMBLEMS
for GL1800 *Patent Pending*

Accenting this natural saddlebag body line makes a profound visual statement. Create an illusion of depth, forward motion & elegance. Just peel, stick, & admire!

Fits: '01-'09 GL1800 Models

3214	Saddlebag Side Emblems (pr)	\$39.99
-------------	------------------------------------	----------------



E SADDLEBAG TOP ACCENTS
for GL1800

Add some eye candy to your plain-jane saddlebags & some protection to the top corner from those annoying surface scratches. Just stick 'em on & get ready for the compliments.

Fits: '01-'09 GL1800 Models

3207	Saddlebag Top Accents (pr)	\$39.99
-------------	-----------------------------------	----------------

FLOORBOARD COVERS for GL1800

Normally, when you flip your stock passenger floorboards into a stowed position, what greets your eyes is dull, dreary & grey. These chrome-plated covers are an easy, inexpensive way to dress up the bottom side of the stock boards. They attach with the stock fasteners for quick installation.

Fits: '01-'09 GL1800 Models (stock passenger floorboards)

7015	Floorboard Covers for GL1800 (pr)	\$39.99
-------------	--	----------------



PIVOT COVER
for GL1800

This attractive flash of chrome nicely contrasts the matte aluminum finish of the GL1800 perimeter frame. Easy-on, easy-off for service.

Fits: '01-'09 GL1800 Models

7881	Pivot Cover (pr)	\$31.99
-------------	-------------------------	----------------

Note: Not suggested for installation with Boomerang Frame Covers.



KÜRYAKYNIZED — MID-FRAME

B PASSENGER FLOORBOARD SIDE COVERS for GL1800

Directly inboard of the passenger footset is an ugly grey panel that's a total mismatch with the bike's color & stature. This chrome-plated version spruces up the bike nicely & finishes the luxurious look of our Boomerang Frame Covers.

Fits: '01-'09 GL1800 Models

7506 | Passenger Floorboard Side Covers (pr) | \$49.99

A LOUVERED CHROME BATTERY BOX COVERS for GL1800

Patent Pending

Look at those dull, grey stock battery box covers surrounded by all that glowing rich paint & sparkling chrome. They look a little out of place, don't they? These covers feature a lustrous chrome finish, cutting edge louvered styling, & even provisions for adding custom backlighting. Covers this cool will stand out for their contemporary styling & distinctive good looks.

Fits: '01-'09 GL1800 Models

3913 | Louvered Chrome Battery Box Covers (pr) | \$109.99

NEW 3914 | Louvered Chrome Battery Box Covers for Trike Kits (pr) | \$119.99
 Fits: All '01-'09 GL1800 Trikes from Champion, DFT, & The Trike Shop (Road Smith)

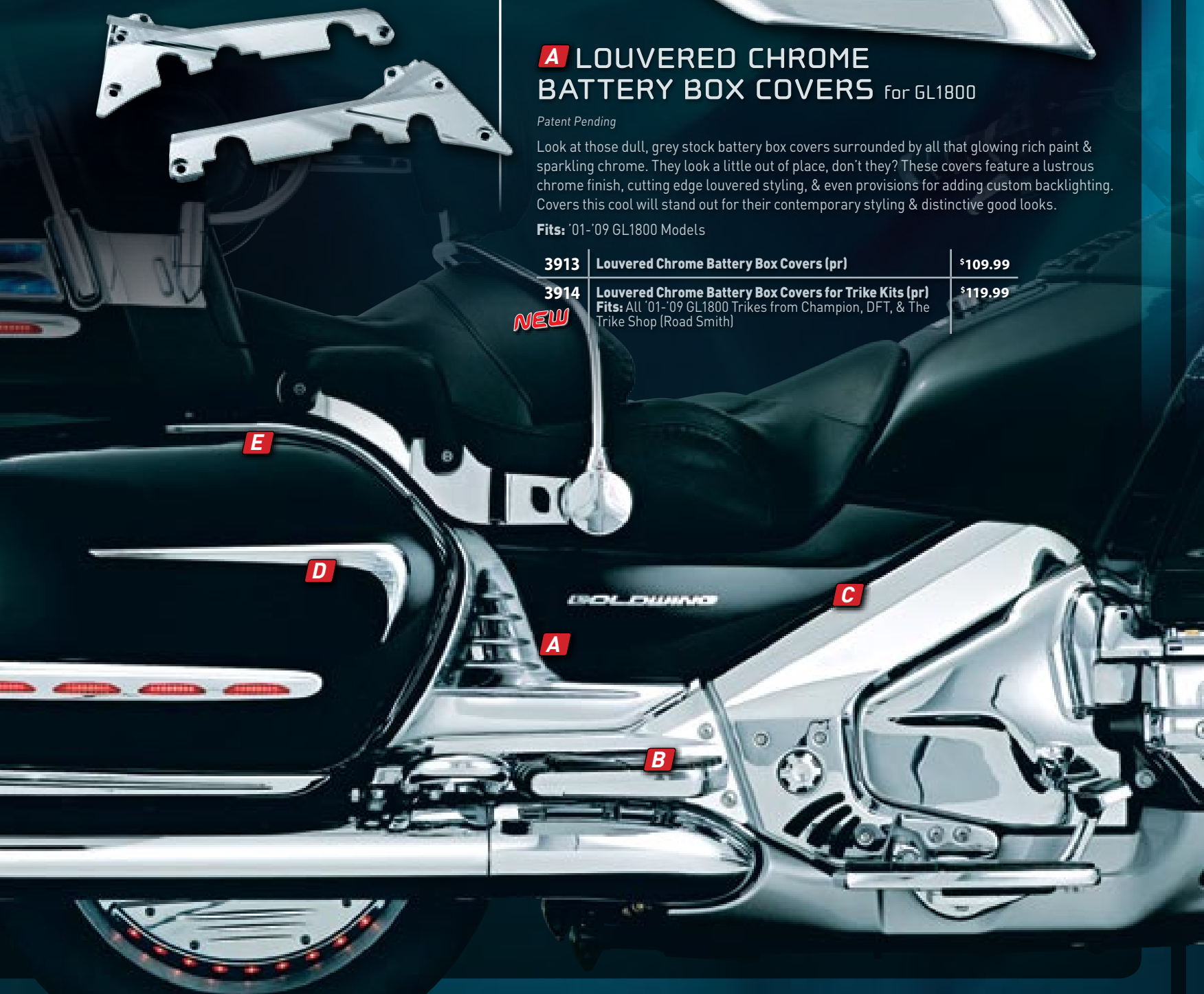

GRIPS & ACCESSORIES

CHROME ADJUSTABLE LEVER SETS for GL1800

A sleek chrome version of the stock GL1800 levers. Riders retain the reach adjustment of their original levers.

Fits: '01-'09 GL1800 Models

7436 | Chrome Adjustable Lever Sets for GL1800 (pr) | \$44.99



WIDESTYLE LEVER SETS

Our own exclusive design with reamed brass bushings. These are wider & more comfortable chrome levers for '90-'00 GL1500 & '01-'09 GL1800. This reduced reach design is also very popular among riders with small hands.

7430 | Chrome Levers (pr) | \$41.99
Fits: GL1500

7435 | Chrome Levers (pr) | \$39.99
Fits: GL1800



CRUISE ASSIST U.S. Patent 4,875,386

The CrampBuster provides a way for comfortable throttle control & dramatically reduces the wrist fatigue often caused by long rides. The CrampBuster will rotate forward all day long. Yet when downward pressure is applied by your hand, the throttle is regulated effortlessly & accurately — without squeezing.

Narrow

Wide

6258 | Fits: Motorcycles with 1" bars (ea) | \$10.99

6254 | Fits: Motorcycles with 1" bars (ea) | \$10.99

6259 | Fits: Motorcycles with 7/8" bars (ea) | \$10.99

6257 | Fits: Motorcycles with 7/8" bars (ea) | \$10.99

Note: Use 6258 & 6254 on grips with 1-7/16" to 1-3/4" outside diameter. Use 6259 & 6257 on grips with 1-1/8" to 1-3/8" outside diameter. Suggested use of 6258 or 6254 with all Kuryakyn Grips.

CRAMPBUSTER



UNIVERSAL THROTTLE BOSS™

Regardless of what type of bike you ride, the Throttle Boss will make riding any distance more comfortable. Designed to fit any type or size grip, the Throttle Boss can be installed in seconds to provide a cushioned "platform" to rest one's palm. When not in use, it can be quickly removed (without tools) & stowed in a jacket pocket, tool bag, etc.

6251 | Universal Throttle Boss (ea) | \$11.99

THROTTLE ROCKER

The Throttle Rocker attaches to the grip with a Velcro strap & allows you to maintain a steady cruising speed without keeping tight grip on the throttle.

Fits: Any application with twist grip throttle

6255 | Right (ea) | \$10.99

6256 | Left (ea) | \$10.99



STILETTO END CAPS

Add some edge to your existing end caps! Installation is a breeze. Screws supplied for use with or without ISO-Throttle Boss.

Fits: All Kuryakyn ISO-Grips (ISO-Grips for use with GL1800 Heated Grips (P/N 6183) requires Smooth Accent Rings for proper installation - Sold separately - pg 18)

6249 | Stiletto End Caps (pr) | \$39.99



KNURLED ACCENT RINGS

6220 | Chrome (pr) | \$8.99

6222 | Blue (pr) | \$8.99

6223 | Gold (pr) | \$8.99

6224 | Purple (pr) | \$8.99

6225 | Green (pr) | \$8.99

6226 | Black (pr) | \$8.99

OPTIONAL LONGER SCREWS

Allows use of up to 3 accent rings (2 if used with Throttle Boss).

6219 | Longer Stainless Screws (Set/8) | \$7.99



SMOOTH ACCENT RINGS

6264 | Black (pr) | \$9.99

6265 | Red (pr) | \$9.99

6266 | Blue (pr) | \$9.99



Mount Over OEM Heated Grips!

Sleeve Style Rubbers



ISO®-GRIPS
For Use with GL1800 Heated Grips

U.S. Patent D411,432 & Patent Pending

Now you can have the luxurious feel & custom look of our ISO-Grips without losing the heat! This clamshell design attaches right over your stock grips allowing the heat to come through.

Fits: '06-'09 GL1800 Models with OEM heated grips.

6183	ISO-Grips for use with GL1800 Heated Grips (pr)	\$99.99
6184	Sleeve Style Replacement Rubbers for P/N 6183	\$20.99

Note: Will only accept Extended Throttle Boss (P/N 6242). Not compatible with P/N's 6250 & 6253. Proper installation for all other grip end accessories requires the installation of Smooth Accent Rings (sold separately- pg 18). Accent Rings are not suggested for use without additional grip end accessories.

REPLACEMENT END CAPS

Direct replacements for ISO or ISO-Flame Grips or a styling update. Includes standard length screws.

Fits: All Kuryakyn ISO-Grips (ISO-Grips for use with GL1800 Heated Grips (P/N 6183) requires Smooth Accent Rings for proper installation - Sold separately - pg 18)

End Caps

6243	Pair	\$25.99
6244	Each	\$13.99

Maltese End Caps

6245	Maltese Cross End Caps (pr)	\$25.99
-------------	-----------------------------	----------------



ISO®-THROTTLE BOSS™

Reduce muscle stiffness & fatigue with this small adjustable "paddle". Position under the palm of one's throttle hand & slightly relax the grip on the throttle - but maintain a constant speed!

6250	ISO-Throttle Boss (ea)	\$17.99
6253	ISO-Throttle Boss (pr)	\$31.99
6242	Extended ISO-Throttle Boss (1/4" longer than standard ISO-Throttle Boss) (ea)	\$20.99

Note: ISO-Grips for use with GL1800 Heated Grips (P/N 6183) will only accept Extended ISO-Throttle Boss (P/N 6242).



Also Available...

KEWLOCK GRIP END HELMET LOCK Dual Function! Add a locking helmet holder & a bar end weight to assist in stabilizing. See pg 84



P/N 6248



NEW GRIP END WEIGHTS
for Kuryakyn Grips

Patent Pending

ISO-Grips are an excellent first step to keep vibration in check, but now you can improve on that comfort! Quickly install on the end of each Grip to add mass & length to reduce handlebar vibration. Also adds a high-tech look to your already hot looking grips!

Fits: All Kuryakyn ISO-Grips (ISO-Grips for use with GL1800 Heated Grips (P/N 6183) requires Smooth Accent Rings for proper installation - Sold separately - pg 18)

6238	Grip End Weights (pr)	\$49.99
-------------	------------------------------	----------------

ISO®-GRIPS for GoldWing U.S. Patent D411,432

Combining style & comfort, Kuryakyn ISO-Grips are a quantum leap forward in hand grip design. Like the popular ISO-Pegs, these grips provide a soft, non-slip surface that dampens operating vibration. Recessed areas between the ISO-Pads permit air flow for added comfort in hot weather. The knurled chrome accent ring adds a classy detail.

Fits: '75-'09 GoldWings

6180	ISO-Grips with Chrome Accent (pr)	\$72.99
-------------	--	----------------

Note: These grips do not support the heated grip option on many late Model bikes. They also are not compatible with OEM bar-end weights found on many bikes. The majority of the time, removing these weights is a simple affair & the vibration absorbing quality of our ISO-Grips more than compensates for the vibration damping lost by removal of the bar-end weight.



Shown with Red Accent Ring (Sold Separately)

HANDLEBAR ACCESSORIES

NEW



1483

Power At Your Fingertips!

ELECTRICAL POWER POINT Patent Pending

Perfect for plugging in your cell phone, iPod, GPS, air pump, or any other electrical device taken on the road. This power point/cigarette lighter will keep them charged. Built into our Silver Bullet light housing & comes with everything you need to connect directly to your battery with a quick disconnect. Mount it above your handlebars or check for tank clearance & mount it below.

1483 | Fits: All GL1500 & 1800 Models (ea) | \$79.99

>> See More Metric Cruiser & Universal Applications for These Products - pgs 92-94

NEW



1487

Conveniently Bring Your Drink With You!

SNAP-N-GO™ DRINK HOLDERS

Patent Pending

Even if you're wearing a full set of leathers, you still shouldn't ride with a cup of hot coffee between your legs. These affordable drink holders mount on either the clutch or brake lever perch or a 1" bar. With secure snap-on mounting, simply Snap-N-Go to install or remove. When removed it leaves an unobtrusive stud on your perch or a small clamp & stud for universal bar application. Select the drink holder style you desire & ride with the plush comforts you deserve.

Fits: All GL1800 & GL1500 Models (Mounting stud replaces clutch or brake perch bolt for mounting)

- | | | |
|-------------|--|----------------|
| 1486 | Snap-N-Go with Stainless Steel Mug (ea) | \$39.99 |
| 1487 | Snap-N-Go with Universal Basket (ea)
<small>Note: Accepts beverage containers from 2-3/8" to 3-1/2" in diameter.</small> | \$39.99 |
| 1469 | Replacement Stainless Steel Küryakyn Travel Mug (ea) | \$17.99 |

Note: Additional Metric Cruiser Fitments - pg 94. 1" clamp not used for GL1800/1500 applications.

Also Available...

GOPRO HERO CAMERA KIT
Document your adventures! Multiple mounting options allow you to record your treks. See pg 161



P/N 860



L.E.D. BATTERY GAUGE

Our L.E.D. Battery Gauge is an array of L.E.D.'s indicating the operating voltage of the bike's electrical system. Green L.E.D.'s represent the normal operating range of your charging system, 12.5v to 14.5v. Amber L.E.D.'s warn the rider that the bike is not charging. If the reading drops below 10v or exceeds 15v, a flashing red L.E.D. will alert the rider of an impending stall or the possibility of damage to the battery &/or sensitive electronic components on the motorcycle. Simple two-wire connection & a compact size (about 2" x 3/4" x 3/16") make installation a breeze.

- | | | |
|-------------|--|----------------|
| 4219 | L.E.D. Battery Gauge, Chrome (ea) | \$39.99 |
| 4218 | L.E.D. Battery Gauge, Black (ea) | \$39.99 |



TECH-TIPS

As with any accessory or accessory holder, do not use accessory or holder while bike is in motion.

UNIVERSAL ACCESSORY MOUNT & DRINK HOLDERS

Attach your cell phone, mp3 player, or nearly any portable device directly to your clutch perch or master cylinder mount with our Universal Accessory Mount. It accepts belt clips, screw mounts, 4 hole AMPS pattern & hook-&-loop straps. Or if bringing along a beverage for those hot or cold days is what you're looking for, the new Universal Drink Holder is for you. With the quick detach thumb screw you can remove the basket for a cleaner look as well. Both styles are equipped with a quick detach thumbscrew that leaves a simple mount when it is not in use.

Fits: All GL1500 & 1800 Models

For Clutch or Brake Perch Mount

1461	Universal Accessory Mount (ea)	\$59.99
1462	Universal Drink Holder with Basket <i>Note: Accepts most average sized cups, cans, bottles & mugs with a 2" to 3 1/2" diameter</i>	\$59.99 NEW
1463	Universal Drink Holder with Stainless Mug	\$59.99 NEW
1429	Replacement Basket for Drink Holder (ea)	\$20.99
1469	Replacement Kuryakyn Travel Mug (ea)	\$17.99

For Universal Bar Mount

1484	Drink Holder with Basket for Round Bars (ea) Fits: 1/2", 5/8", or 3/4" tubing	\$59.99 NEW
1485	Drink Holder with Stainless Mug (ea) Fits: 1/2", 5/8", or 3/4" tubing	\$59.99 NEW



>>Additional Metric Cruiser Applications - pg 94

Mounts on Clutch or Brake Perch!



Mount Your Cell Phone, iPod, GPS & More!

Don't Forget...

PASSENGER DRINK HOLDER
Don't be selfish! Attach another drink holder so your passenger can quench their thirst too! See pg 27



UNIVERSAL ACCESSORY POUCHES

Everybody has things they need to carry; keys, cell phones & iPods. Empty your pockets & make transporting these items easy with our new Accessory Pouch. Designed specifically to bolt directly to your Accessory Mount or universal 1/2" to 1-3/4" round bars. When mounting on round bars, simply strap & go! Remove in seconds.

Fits: Universal Accessory Mount (P/N 1461) or universal 1/2" to 1-3/4" round bars (Not suggested for mounting on GL1800 Handlebars)

1478	Small (3-1/2" Tall, 2-1/4" Wide, 3/4" Deep) (ea)	\$29.99
1479	Large (4-1/2" Tall, 3-1/4" Wide, 3/4" Deep) (ea)	\$29.99

Best When Used With Our Universal Accessory Mounts!



**Mount on Left
or Right Side!**



ACCESSORY SWITCHES for Master Cylinder Reservoir Covers

Keep control of your accent lighting & additional motorcycle accessories at the tip of your fingers with these master cylinder Accessory Switches. Rated for 12V & up to 10 Amp accessories each, these switches add convenience & style to controlling those extras you add to your motorcycle.

Fits: All GL1500 & 1800 Models

7803 | Accessory Switches for Master Cylinder Reservoir Covers (ea) | **\$72.99**

Note: Additional Metric Cruiser Fitments - pg 91.

**Adjust Your Hands
Up to 2" Horizontally &
1-1/2" Vertically**



HANDLEBAR RISERS/SETBACKS for GL1800

With 5 different position options, adjust your handlebars to make your GoldWing the most comfortable ride. With all the parts you need, we don't know anyone who offers this many options & convenience in one set.

Fits: '01-'09 GL1800 Models

7437 | Handlebar Risers for GL1800 (set) | **\$79.99**



MASTER CYLINDER RESERVOIR COVERS

These chrome reservoir covers are an eye-catching replacement that really perk up the master cylinder area. Available plain or with our exclusive Kuryakyn 1500 gold Condor emblem for a distinctive styling touch.

Fits: GL1500 & GL1800 Models

7800	Chrome Reservoir Cover (pr)	\$25.99
7801	Chrome Reservoir Cover with 1500 Gold Condor Emblem (pr)	\$31.99

Note: 1800 Gold Condor Emblem sold separately (P/N 5152 - below).



CONDORS for GL1800

These accents feature a gold electroplate finish & the 1800 emblem in the center. A strong adhesive backing is pre-applied to permit easy mounting. Mini Condors are 1-3/4" wide & Medium Condors are 2-1/4" wide.

5152	Mini Condor for GL1800 (ea)	\$7.99
5153	Medium Condor for GL1800 (ea)	\$8.99

Renderings Shown



NEW

A DASH TOP TRIM Patent Pending

While seated in the cockpit of your decked out Wing, did you ever notice something was missing? We did too. Styled to evoke the look of a classic 50's luxury car, this tasteful dash trim can be admired by the driver, passenger, & anyone viewing your bike from the front. In addition, it also acts as an effective visor for the instrument cluster. Just peel, stick, & enjoy!

Fits: All '06-'09 GL1800 Models

3737 | Dash Top Trim (ea) | **\$79.99**



NEW

B GAS TANK DOOR TRIM Patent Pending

Like a big scoop of vanilla ice cream on a warm piece of apple pie, this Gas Tank Door Trim is delicious when served with our Glove Box Accents. Although tasty by themselves, some things are just better together!

Fits: All '01-'09 GL1800 Models

3738 | Gas Tank Door Trim (ea) | **\$49.99**

C CHROME TANK TRIM WITH KNEE PADS Patent Pending

Every Sunday, you share something with café racers of decades past: You're out there riding the twisties! Those old Triumphs didn't have rubber kneepads on their tanks just for looks- check out the scuff marks on your tank after a vigorous ride. Contoured to match the lines of your Wing, the chrome trim adds style & the rubber pads add function & comfort. This is the perfect addition to protect new paint or cover up existing battle scars.

Fits: All '01-'09 GL1800 Models

3916 | Tank Trim with Knee Pads (pr) | **\$109.99**

Coming Soon



NEW

A



D

B

C

Some People Pinstripe Accent Trim - We Do it in CHROME!

NEW

D GLOVE BOX ACCENTS Patent Pending

While many riders choose to highlight their glove boxes with ordinary pin striping, nothing can match the explosive sizzle of Kuryakyn chrome! This three dimensional trim adds the illusion of speed & reflects light for sparkle & depth not possible with ordinary paint accents.

Fits: All '01-'09 GL1800 Models (except Airbag Models)

3736 | Glove Box Accents (pr) | **\$69.99**



CUSTOM DASH For GL1800

Our custom carbon fiber dashes are an easily installed direct replacement for the stock GL1800 dash.

Fits: '01-'05 GL1800 Models

3711 | Carbon Fiber Pattern Custom Dash (ea) | **\$197.99**

AIRWASTER™

DRAGON WINGS™ VENTED WIND DIRECTORS for GL1800

Patent Pending

Be in control of your riding environment. Dragon Wings put you in charge & allow you to manage & direct the wind with amazing effectiveness. Gain the full protection from your mirrors fully down the sides of your fairing. With two adjustable wind directors per side, you can direct wind down & away or up & into the fairing compartment in varying volumes. Both drivers & passengers benefit from less turbulence, rain & debris. The dark tinted hard-coated polycarbonate adds a high-tech appearance with the best quality available.

Fits: All '01-'09 GL1800 Models

1388 | Dragon Wings for GL1800 (pr) | \$176.99

Note: Do not use Rain-X or other ammonia based cleaning or protection products on this product.



*Experience
the Amazing
Difference!*



REAR AIRFOIL for GL1800

Patent Pending

If you want to greatly reduce buffeting & virtually eliminate annoying back draft this Rear Airfoil is the answer. You will be amazed at the almost still environment created for both driver & passenger when used with your stock windshield, or gain the ultimate in protection with the Performance Windshield. Made from hard-coated polycarbonate, select the Hint of a Tint Clear or Dark Smoked Airfoil that complements as a mere seven inch extension to the passenger seat.

Features:

- Hard-coated polycarbonate for quality, strength, & scratch resistance
- Quick detach
- Hint of a Tint Clear or Dark Smoke tint with aerodynamic styling to complement passenger seat

Fits: All '01-'09 GL1800 Models

1384	Rear Airfoil, Dark Smoke (ea)	\$124.99
NEW 1385	Rear Airfoil, Clear (ea)	\$124.99

Note: Do not use Rain-X or other ammonia based cleaning or protection products on this product.

RIDER TESTIMONY—

Our test riders could not believe the performance & left us with praise for creating a protected cockpit of air for both driver & passenger. The true amazements were “no buffeting or poor handling when passing through the traffic of 18 wheelers.” There is nothing else out there that provides better wind protection unless you’re getting in your car or truck.

Note: Best results reported when using Performance Windshield with Rear Airfoil.

1382

*Excellent
Optical Clarity*

1384

*The Only Place You'll Get a More Calm,
Quiet & Peaceful Riding Environment is
in the Confines of Your Car!*



COCKPIT COMFORT

Witness the Ultimate in Cockpit Comfort while Using Kuryakyn's AirMaster Performance Windshield, Rear Airfoil & Dragon Wings.

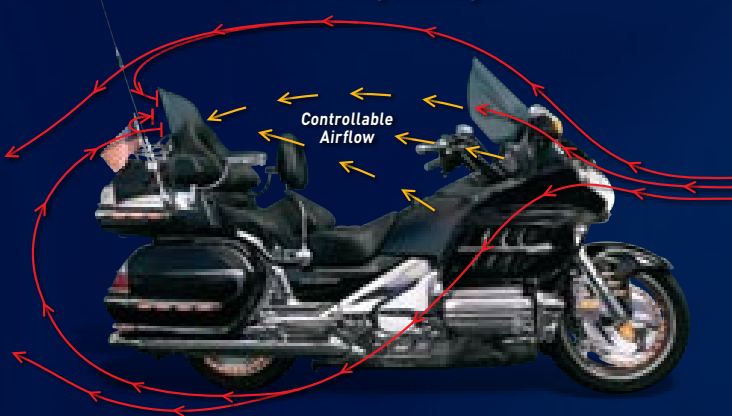

**PERFORMANCE
WINDSHIELD** for GL1800

Being "in the wind" is a big reason why many of us ride. But too much turbulent air detracts from the experience. The new Performance Windshield is only slightly larger than stock, but it's contoured, wider design creates a more calm, comfortable envelope. Optical clarity is excellent & the hint of a tint reduces glare without hindering visibility. Stock mounting points & adjustability are retained similar to stock. Unlike some larger replacement windshields, vehicle stability & handling are not affected & the driver is not crowded by the windshield.

Features:

- Hard-coated polycarbonate for quality, strength, & scratch resistance
- Black gradient with vinyl protectors on lower portion to avoid abrasion

Fits: All '01-'09 GL1800 Models

NEW 1382	Performance Windshield with Rear Airfoil (set)	\$399.99
NEW 1383	Performance Windshield (ea)	\$299.99

Note: Vent not included. The Performance Windshield has the standard cutout for installation of OEM windshield vent. For '01-'02 GL1800's without vent we suggest ordering OEM GL1800 Windshield vent for installation. Do not use Rain-X or other ammonia based cleaning or protection products on this product.

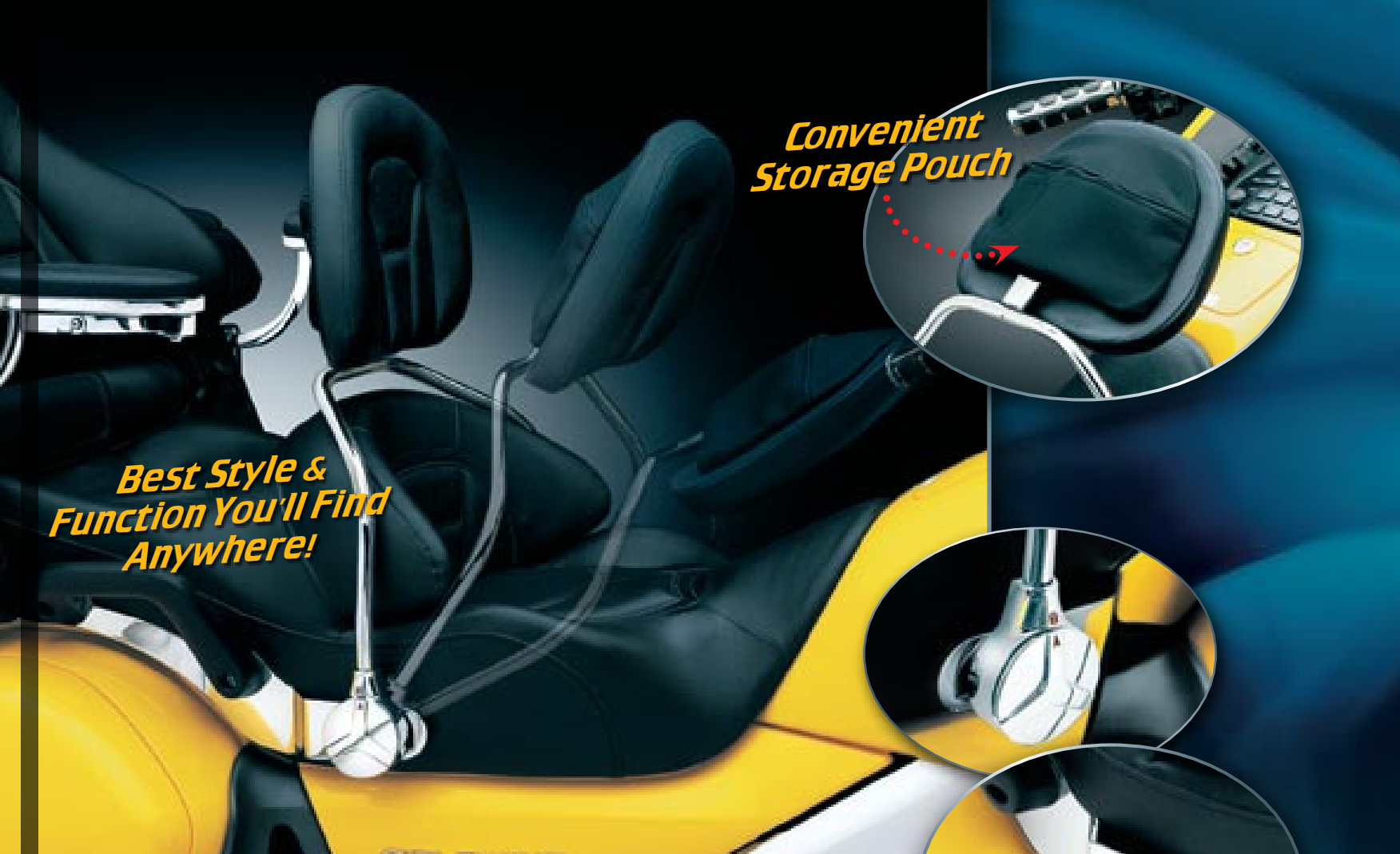

Best Style & Function You'll Find Anywhere!

Convenient Storage Pouch

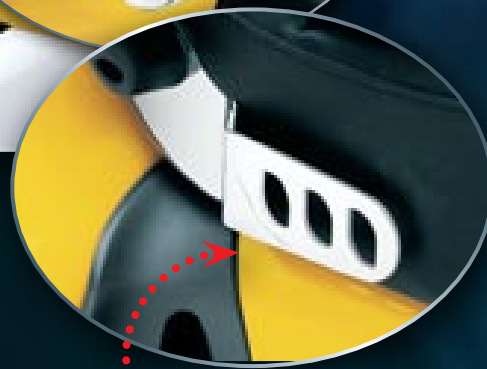

RIDER BACKREST For GL1800 U.S. Patent D528,311 & 7,318,624

Ultimate comfort for the GL1800 rider! Hours in the saddle will feel like minutes in your favorite easy chair when you cruise with our Rider Backrest. Quick release mounts allow easy removal & adjustability to suit each rider. The entire backrest pivots forward at it's anchor points for smooth operation & easy access to the passenger seat. Stylized pivot covers add elegance to the design. The upholstered backrest pad matches the OEM seat in both texture & style & features a convenient rear mounted storage pouch accessible by your passenger for traveling necessities like cameras, sunscreen, sunglasses, tissue, or anything else you like to keep handy.

Fits: '01-'09 GL1800 Models

8990 | Rider Backrest for GL1800 (ea) | **\$299.99**

Three-Position Adjustability



NEW

PADDED BAR COVERS
for Driver Backrest

Don't let your comfort turn into someone else's annoyance. Cover those steel bars—they're cold when it's cold, hot when it's hot, & they're always hard enough to keep reminding your passenger of their presence. You can't get rid of them, so at least make them comfortably soft with these Padded Bar Covers.

Fits: All '01-'09 GL1800 with Kuryakyn Driver Backrest (P/N 8990)

4136 | Padded Bar Covers for Driver Backrest (pr) | **\$49.99**

passenger comfort



1469

STAINLESS STEEL KÜRYAKYN TRAVEL MUG

Add this travel mug to your Küryakyn Can Cooler for the perfect fit in your Passenger Armrest drink holder.

1469	Stainless Steel Küryakyn Travel Mug (ea)	\$17.99
8985	Küryakyn Can Cooler (pr)	\$5.99



Swing-Away Design for Effortless Mounting!



Includes Küryakyn Can Cooler!

PASSENGER ARMRESTS

for GL1800 U.S. Patent D526,952 & 7,114,774

We realize it's hard to imagine being any more comfortable on the back of a GoldWing, but our Passenger Armrests prove that it's possible! The shapely chrome mounting brackets fasten to the trunk & provide a sturdy mount for the swing-away armrests. Our top quality padding matches the OEM texture & color for a 100% factory look. We also have incorporated a handy, swing-out cup holder for the ultimate convenience.

Fits: '01-'09 GL1800 Models

8991	Passenger Armrests for GL1800 (pr)	\$269.99
------	------------------------------------	----------

PASSENGER DRINK HOLDER

for GL1800 Patent Pending

Don't cut a nice ride short because of a "parched passenger!" Here is a great solution to where & how to carry a beverage for them, too. This drink holder mounts to either the right or left seat handle, where it is out of the way, but still within easy reach. Holds a variety of containers from 2" to 3-1/2" in diameter & is easily removed when not in use.

Fits: '01-'09 GL1800 Models

1481	Passenger Drink Holder (ea)	\$59.99
1469	Replacement Stainless Steel Küryakyn Travel Mug (ea)	\$17.99

Note: Stainless Steel Mug (P/N 1469) sold separately.



NEW



1481



Enhance Passenger Comfort!

TRANSFORMER FLOORBOARDS For Passengers

Our Transformer Floorboards blend style, function & comfort! A direct replacement for the dull aluminum stock passenger floorboards that bolt in minutes. These ingenious floorboards also offer a unique hidden retractable passenger cruise peg! A folding arm & footrest deploys to provide an alternate foot position 4-1/2" higher & 5-1/2" farther forward than the stock foot position. When folded down they offer a secure, comfortable perch for passengers. The stock height adjustability is still fully functional on GL1500 SE Models.



7000	Transformer Floorboards Fits: '90-'00 GL1500 SE (pr)	\$228.99
7001	Transformer Floorboards Fits: GL1500 Aspencade (pr)	\$259.99
7005	Transformer Floorboards Fits: '01-'09 GL1800 (pr)	\$249.99
7010	Replacement Rubber Pads for One Transformer Board (set/11)	\$20.99
7009	Replacement Slim Rubber Pads for Swingarms (Both Boards) (set/4)	\$9.99
7008	Replacement End Rubber Pads for Swingarm (set/3)	\$9.99

Note: P/N 7001 will also work on GL1500 Interstate Models that have been equipped with Hondaline Passenger Boards.



*Unique Flip-Out
Cruise Peg!*

FOOTPEGS & BOARDS



DRIVER FLOORBOARD KIT for GL1800

U.S. Patent D528,476; D531,092 & 7,287,773

Gain the ability to put your feet in a more comfortable position, update your foot controls & improve the look of your ride all at once! Our Driver Floorboard Kit includes a built-in heel-toe shifter & a brake lever for the ultimate in comfort & convenience. A great addition to our ISO series, the cushy, full-length ISO rubber inserts absorb vibration for a more comfortable & bearable ride. The boards fold up for easy maneuvering in tight spaces & allows access to the stock kickstand. Installs in minutes.

Fits: '01-'09 GL1800 Models

4038	Driver Floorboard Kit (pr)	\$399.99	4449	Replacement Shift Arm Kit (kit)	\$83.99
4048	Replacement Shift Fork Bushings (ea)	\$10.99	4068	Replacement Rubber Pads (set/10)	\$41.99
4049	Replacement Board Guards (pr)	\$10.99	4069	Replacement Brake Pedal (ea)	\$24.99 NEW



WIDE BRAKE PEDAL COVER for GL1800 with Driver Floorboards

Give me a brake! Preferably a nice wide one that looks great, matches other accessories, & is easily installed!

Fits: Kuryakyn Driver Floorboards for GL1800 (P/N 4038)

4067 | **Wide Brake Pedal (ea)** | **\$31.99**



KICKSTAND EXTENSION

Infinitely adjustable, our Kickstand Extension can be installed on almost any motorcycle to provide improved access to the kickstand. When used with our Driver Floorboard Kit for GL1800 (P/N 4038), it allows the rider to deploy the kickstand without folding up the floorboard.

Fits: Stock OEM Kickstand or Stand-Rite Kickstand (P/N 7104)

7109 | **Kickstand Extension (ea)** | **\$39.99**

Note: For best results use our Stand-Rite Kickstand (P/N 7104 - pg 31).



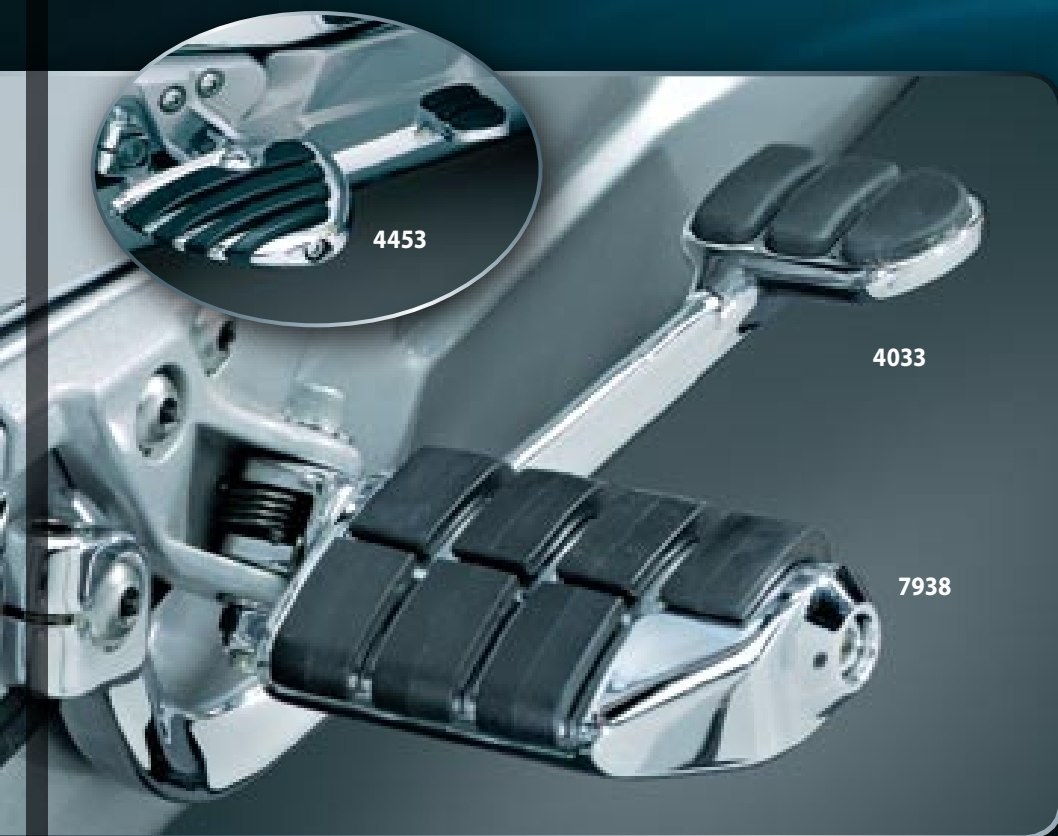

BRAKE ARM WITH PEDAL for GL1800

This replacement brake pedal is pure class. Smooth lines, deep chrome & black rubber ISO-Pads make this a beautiful addition to your Wing. If you are currently using other ISO components such as footpegs, grips & passenger boards, this is a perfect complement & rounds out the set nicely.

4033	Brake Pedal for GL1800 (ea)	\$83.99
4035	Replacement Pads (set /3)	\$7.99

PEGS Equipped with Adapters for GL1800

The first of the GL1800's had barely hit the street when riders began asking us for footpegs for them. Now available with required adapters, these classy, comfortable pegs can be installed in minutes.

7938	Dually ISO-Pegs for GL1800 (pr) <i>U.S. Patent D405,393</i>	\$72.99
8023	Replacement Rubbers for Dually Peg	\$17.99
4453	ISO-Wings for GL1800 (pr)	\$103.99
4454	Replacement Rubbers for ISO-Wings	\$20.99

Note: Other peg styles available. Complete selection - pg 100.



BRAKE PEDAL & ARM COVER for GL1800

For an easy & economical way to improve function & style on your bike, add our Brake Pedal & Arm Cover. The Brake Pedal Cover installs directly over your stock pedal, while the second cover goes directly over the stock arm to completely chrome this area. A simple yet cool upgrade to your stock parts.

Fits: '01-'09 GL1800 Models

4013	Brake Pedal & Arm Cover for GL1800 (set)	\$49.99
NEW 8022	Brake Pedal Cover (ea)	\$31.99

ISO®-BRAKE PEDAL PAD for GL1500

The ISO-Brake Pedal Pad covers the raw, unfinished end of your brake pedal. Beautiful chrome with rubber inserts provide a non-slip surface.

Fits: All GL1500 & all Valkyrie Models (except Rune)

4025	ISO-Brake Pedal Pad (ea)	\$31.99
8081	Replacement Rubber Pads for 4025 (set)	\$10.99

DUALY ISO®-PEGS for GL1500

U.S. Patent D405,393

Direct replacement for the stock rider pegs on all GL1500 & Valkyrie (except Rune).

7945	Dually ISO-Peg for GL1500 & Valkyrie (pr)	\$72.99
8023	Replacement Rubbers for Dually Peg	\$17.99

Note: Other peg styles available. Complete selection - pg 100.



CHROME DRIVER PEG MOUNTS for GL1800

A great looking replacement for the stock painted footpeg mounts. Our chrome units look awesome with our pegs & Boomerang Frame Covers.

Fits: '01-'09 GL1800 Models

4544	Chrome Footpeg Mounts for GL1800 (pr)	\$83.99
-------------	--	----------------





**STAND-RITE
KICKSTAND** for GL1800

We are pleased to be able to offer you a beautifully chromed stand that works perfectly with our state-of-the-art floorboards & shifter & most other accessories you may desire.

Fits: '01-'09 GL1800 Models

7104 | Stand-Rite Kickstand (ea) | \$93.99



**Easy
Shifting!**

Shown with Dually ISO-Peg - pg 30



**HEEL-TOE
SHIFTER** for GL1800

We understand that while a lot of riders may want the convenience of a heel-toe shifter, not everyone wants to convert to floorboards. This simple kit installs in minutes & retains the stock footpegs. For added flair, choose from any of our custom pegs (pg 100) with appropriate adapter.

Fits: '01-'09 GL1800 Models

4039	Heel-Toe Shifter for GL1800 (ea)	\$187.99
4048	Replacement Shift Fork Bushings (ea)	\$10.99
4449	Replacement Shift Arm Kit (kit)	\$83.99



TECH-TIPS

Always check all fasteners on pegs & mounting hardware after installation. The assemblies do not always come pre-tightened, periodic maintenance is recommended.

CHOOSE THE PEGS YOU WANT...

...& Select the Adapter You Need.

**Full Line
of Pegs - pg 100**



**SwingWing Peg
4467**

Swing Out
Cruise Peg

Closed

8808

4467



**SweptWing Peg
4464**



**Pilot Peg
4419**



7939

Splined Adapters

Model	Year	Front	Rear
GL1800	'01-'09	8808	None

Splined Adapters required for SwingWing Pegs (P/N 4467). Floorboards (P/N 4455, 4457 & 7916) will not install on GL1800.

Footpeg Adapters

Model	Year	Front	Rear
GL1800	'01-'09	7939	None
GL1500	'88-'00	7946	None

cruise pegs



OFFSET PEGS with Quick Clamps

U.S. Patent D405,393 & D411,440

This innovative cruise peg setup redefines the term long haul comfort. This system is adjustable enough to accommodate nearly any rider.

Fits: GL1500, Valkyrie, (except Interstate) & most bikes with 1" engine guards

7976 | Offset Dually ISO-Pegs with 1" Clamps (pr) | \$145.99



LONGHORN OFFSETS

U.S. Patent D405,393 & D411,440

Our stylish Longhorn Offsets provide 360° of adjustability so they can be used to position the peg closer to the rider or further away. The mounts' 3-1/4" arm gives an incredible 6-1/2" range of adjustment. Incorporating an innovative locking device, this mount is guaranteed not to slip. These give you a wider range of adjustment than our standard Offset Pegs (P/N 7976) & works great on GoldWings or most bikes with 1" engine guards.

with Dually ISO-Pegs

7980 | Longhorn Offset Dually ISO-Pegs with 1" Clamps (pr) | \$155.99

Mounts Only

7985 | Longhorn Offset Mounts with 1" Clamp (pr) | \$114.99

>> Add Any Male Mount Peg - pg 122

RIGHT ANGLE PEGS with Quick Clamps

U.S. Patent D405,393 & D411,440

A good option for cruise peg mounts on the 1800 - especially for the shorter rider. Because these mounts are attached to the clamp at a right angle, they can be positioned on engine guards in orientations impossible with other clamp-on pegs. This particular setup allows positioning on the 1800 engine guard at the closest point possible to the driver.

4509 | Right Angle Dually ISO-Pegs with 1" Clamps (pr) | \$139.99



1" Engine Guard on GL1800

Ultimate Adjustability!

ERGO II CRUISE MOUNTS for GL1800

Ergo II Cruise Mounts are undeniably the best highway pegs available for the GL1800. The sturdy two-piece clamp assembly comes with either the 6" long arm or Mini Arm. Simply select the arm length that suits your needs. Each mount is easily installed & locates the swingarm mounting point high & tight for excellent cornering clearance. Each arm comes with various footrest options while providing a wide range of adjustability. The Ergo II is sure to please.

Fits: '01-'09 GL1800 Models

Mini Arms (for Taller Riders) **NEW**

4073	with Dually ISO-Pegs (pr) U.S. Patent D405,393	\$209.99
4074	with Switchblade Pegs (pr) U.S. Patent D506,707 & 6,893,038	\$259.99

6" Arms (for Shorter Riders)

4056	with Dually ISO-Pegs (pr) U.S. Patent D405,393	\$199.99
4057	with ISO-Wings (pr)	\$239.99
4064	with Switchblade Pegs (pr) U.S. Patent D506,707 & 6,893,038	\$259.99
4058	with Lighted Cruise Boards (pr)	\$289.99
4059	with Unlighted Cruise Boards (pr)	\$269.99

Note: Kuryakyn Highway Pegs offer a wide range of adjustment. It is the responsibility of the installer or the end user to ensure they do not interfere with the operation or cornering clearance of the motorcycle.



Replacement Arms for Ergo & Ergo II Applications:

Tailor your footpeg placement exactly where you want.

4060	Short Ergo Arm, 4-1/2" (pr)	\$49.99
4061	Long Ergo Arm, 6" (pr)	\$49.99
4071	Mini Ergo Arm (pr) <i>Note: For Ergo II with footpegs only.</i>	\$59.99

REPLACEMENT CLEVIS FOR ERGO OR ERGO II

8061	Replacement Peg Clevis or Update from Boards to Pegs (pr)	\$31.99
-------------	---	---------

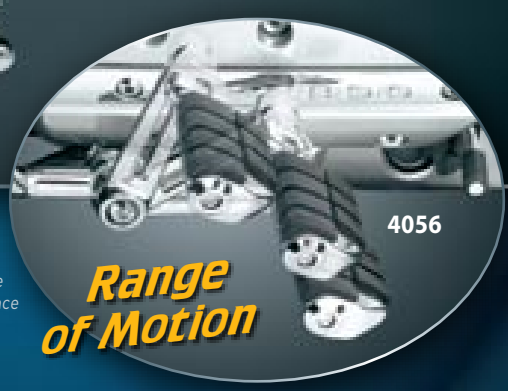

Note: Kuryakyn Highway Pegs offer a wide range of adjustment. It is the responsibility of the installer or the end user to ensure they do not interfere with the operation or cornering clearance of the motorcycle.

L.E.D. TURN SIGNAL ACCENT LIGHTING INSERTS **NEW** for Ergo™ & Ergo II™ Cruise Pegs *Patent Pending*

The more visible you are, the less likely someone's going to pull out in front of you. These accent lighting inserts function as both running & turn signal lights, & are the perfect complement to Ergo Cruise Pegs. Simple to install, they fit right into the slots of short & long Ergo Arms. Be sure to be seen.

Fits: Ergo & Ergo II Cruise Pegs, both long & short arms

4072	Accent Lighting Inserts (pr)	\$69.99
-------------	------------------------------	---------

Note: Not compatible with Mini Arms.



A

B

C

Rendering Shown

Trunk Lid Handle
pg 36

HONDA

Lighted Trunk Molding
pg 36

Saddlebag
Taillight Accents
pg 37

Curved Laydown License
Plate Frame pg 38

L.E.D. Rear Reflector
Conversion pg 37

Lighted Saddlebag Molding
pg 36

Saddlebag Bottom Trim Molding
pg 36

Glow Ring Exhaust
pg 39

**Add Our NEW
Super Lizard Lights
for More Flash - pg 8!**



KÜRYAKYNIZED — REAR END

7-Colors in One!

A INFINITY LIGHTS

For GL1800 Tour Box U.S. Patent 7,029,152

Few GoldWing accessories will leave as many people staring in disbelief as Infinity Lights. Performing double duty, they appear as graceful chrome accents until you bring them to life with the supplied controller. Now, an array of multi-function L.E.D.'s illuminate steadily, flash, or continuously fade through red, lime, ice, sky blue, dark blue, purple & green in a display that gives the illusion of infinite depth. Color, flash speed, & color cycle rate are totally variable & power draw is minimal.

Fits: All '01-'09 GL1800 Models

4622 | Infinity Lights for Tour Box (pr) | **\$299.99**

Note: Works great with or without Passenger Armrests.



B L.E.D. SPOILER RUN-TURN-BRAKE LIGHTBAR **NEW**
for GL1800

Safety & style unite. This new Lightbar mounts up high where people can see it & with super bright L.E.D. lights, people will see it. A direct OEM replacement, plug-&-play into the existing spoiler harness & the main harness behind your license plate. The entire bar lights up as a running & brake light, splits when functioning as turn signals & the desired end flashes bright amber. Safety with flair for your Wing.

Fits: Honda Spoiler for all '01-'09 GL1800 Models

3216 | L.E.D. Spoiler Run-Turn-Brake Lightbar (ea) | **\$119.99**

Coming Soon

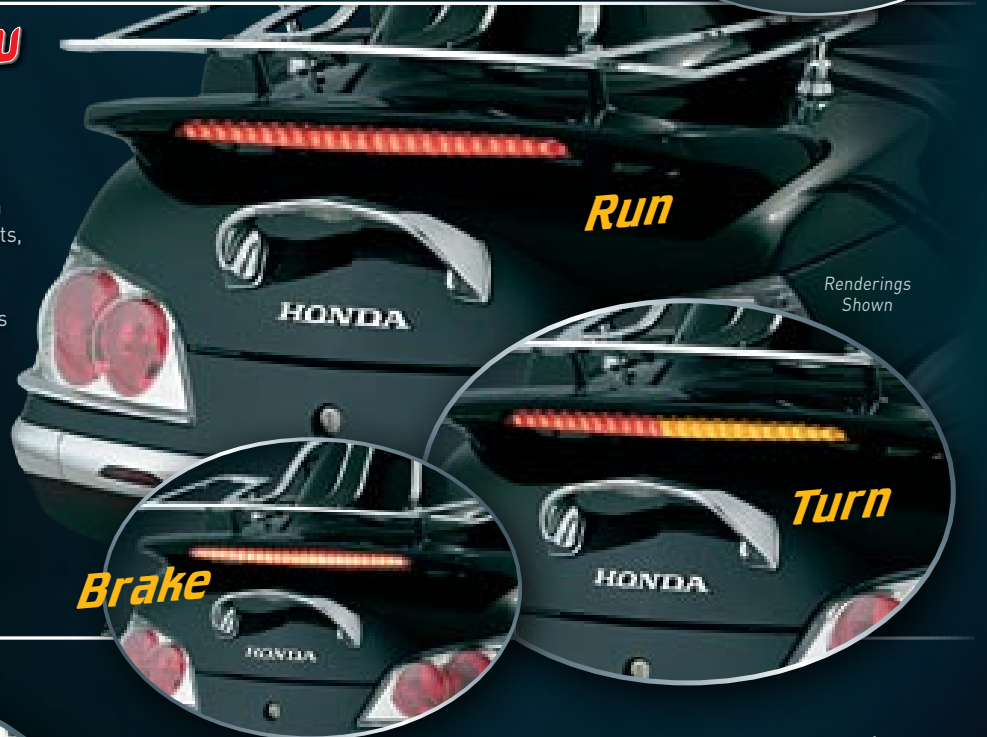

Coming Soon

Renderings Shown

C SPOILER END TRIM **NEW**
with L.E.D. Turn Signals for GL1800 Patent Pending

It's all about visibility. Whether aesthetic or an extra measure of defense against heavy-eyed car jockeys, there's nothing like bright chrome & L.E.D.'s to increase conspicuity. Gleaming chrome spoiler accents deploy brilliant auxiliary turn signals angled outward to help get the attention of surrounding traffic. A simple plug-&-play installation that enhances form & function!

Fits: Honda Spoiler for all '01-'09 GL1800 Models

3217 | Spoiler End Trim with Turn Signals (pr) | **\$119.99**





3201

**Choose Chrome
or Red Lenses!**



3201

LIGHTED TRUNK MOLDING

for GL1800 U.S. Patent D491,493 & 488,105

Pure class best describes this beautiful Lighted Trunk Molding. Styled to be a perfect match for our Lighted Saddlebag Molding, they look incredible in a complete set. Two circuit L.E.D.'s function as both running & brake lights for a highly visible, long lasting light source that places a minimal draw on the electrical system. These great looking moldings install in a fraction of the time as old fashioned light bars.

Fits: '01-'09 GL1800 Models

3201	Red Lens L.E.D. Trunk Molding Set (3 pcs)	\$187.99
3221	Chrome Lens L.E.D. Trunk Molding Set (3 pcs)	\$187.99



3222

Off

3213

**Lit or
Unlit Options**

Glow Ring Exhaust
P/N 7602 - pg 39

LIGHTED SADDLEBAG MOLDING

for GL1800

U.S. Patent D477,551 & D488,105

These chromed replacement lighted moldings add the sparkle & elegance of the old style chromed tubular light bars without the added weight, mounting holes, potential for rust, & maintenance. These replace existing parts on the bike so there is no added bulk. All stock mounting points & hardware are retained.

The state-of-the-art red L.E.D. lights have an eye-catching, brilliant quality that draws minimal power & generates very little heat. These lighted moldings look great by themselves or with the other L.E.D. accessories that we offer for the GL1800. Any other type of light bar is now ancient history.

Fits: '01-'09 GL1800 Models

3202	Red Lens L.E.D. Saddlebag Molding Set (4 pcs)	\$249.99
3222	Chrome Lens L.E.D. Saddlebag Molding Set (4 pcs)	\$249.99



3202

SADDLEBAG BOTTOM TRIM MOLDING for GL1800

Highlight this otherwise dull drab panel with our Bottom Trim Molding. Replace your stock components at the bottom of your saddlebags with lit or unlit moldings. The L.E.D. option adds that finishing touch to completely light up the rear molding of your bike. Perfect complement to our Lighted Trunk Molding & Lighted Saddlebag Molding.

Fits: '01-'09 GL1800 Models

3212	Non-Lighted Saddlebag Bottom Trim Molding (set)	\$119.99
3213	Red Lens Lighted L.E.D. Saddlebag Bottom Trim Molding (set) <small>U.S. Patent D575,008 & D575,201</small>	\$166.99



3213

L.E.D. LIGHTED TRUNK LID HANDLE for GL1800

Style & function become one when you add a handle to the tour trunk while positioning an L.E.D. brake light up higher for added visibility. This handle also works with the Honda spoiler.

Fits: All '01-'09 GL1800 Models

3215	L.E.D. Lighted Trunk Lid Handle for GL1800 (ea)	\$103.99
------	---	----------

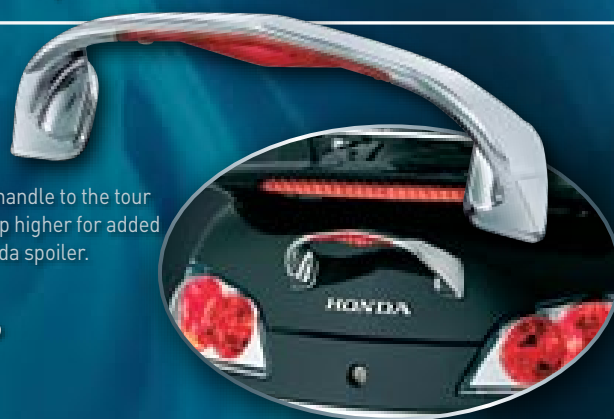

PULSATING BRAKE LIGHT CONTROLLER

Activate up to 6 brake lights to flash automatically & then stay on with a single squeeze of your brakes. Controller does not harm the life of your lights, so ride in confidence & be seen.

Fits: All GL1500 & GL1800 Models

908	Pulsating Brake Light Controller (ea)	\$69.99
-----	---------------------------------------	---------





TRUNK TAILLIGHT ACCENTS For GL1800

Simply peel-&-stick these stylish chrome accents to the bottom edge of your tour trunk brake lights for that perfect sparkle. Looks great alone, but complete the style with Kuryakyn Saddlebag Taillight Accents [P/N 3209]. These accessories also coordinate well with Kuryakyn Trunk & Saddlebag Molding.

Fits: All '01-'09 GL1800 Models

3208 | Trunk Taillight Accents for GL1800 (pr) | **\$39.99**



L.E.D. REAR REFLECTOR CONVERSION For GL1800

Here's yet another way to easily light up the night. This simple conversion kit replaces the stock red reflector found on the rear center panel of the GL1800. With plug-in wiring, the kit will have you styling in minutes. Rear reflector functions as running light & brake light for increased visibility.

Fits: '01-'09 GL1800 Models

7456 | L.E.D. Rear Reflector Conversion (ea) | **\$59.99**



SADDLEBAG TAILLIGHT ACCENTS For GL1800

These simple peel-&-stick chrome accents divide the clear & red section of your GL1800 saddlebag taillight. Looks great alone but complete the style with Kuryakyn Trunk Taillight Accents [P/N 3208]. These little beauties also coordinate well with Kuryakyn Trunk & Saddlebag Molding.

Fits: '06-'09 GL1800 Models Only

3209 | Saddlebag Taillight Accent for GL1800 (set) | **\$51.99**





NEW

CURVED LAYDOWN LICENSE PLATE FRAME

with Run & Brake Lights *Patent Pending*

You've been framed! There won't be any chance of mistaken identity with this slick new license plate frame from Kuryakyn. This new offering presents your plate with a unique curved profile, smooth graceful contours, & a mount that keeps it flush with the rear of the motorcycle. The classy accent light positioned on the bottom contains red L.E.D.'s with an auxiliary run/ brake function & white L.E.D. lighting to illuminate the plate at night. Designed to fit 4" x 7" plates.

Fits: All '01-'09 GL1800 Models

3137	License Plate Frame with Accent Lights for GL1800 (ea)	\$119.99
-------------	---	-----------------

Note: Will not install with Kuryakyn License Area Trim with Lights (P/N 3135 or 3136).



LICENSE AREA TRIM WITH LIGHTS for GL1800

U.S. Patent D528,486

It just seemed to us that the factory forgot something between your saddlebags - it looks so empty. Our trim changes all that. It gives the back of your Wing a whole new personality along with added visibility. Brilliant L.E.D.'s light up while running & go "super bright" when you hit the brake. No cut & splice necessary, just a simple plug-in for wiring.

Fits: '01-'09 GL1800 Models

3135	License Area Trim with Red Light (Red Lens) (ea)	\$124.99
3136	License Area Trim with Red Light (Clear Lens) (ea)	\$124.99

REAR FENDER TRIM for GL1800

This handsome trim strip is a natural complement to the Debris Modulator Mud Flap & our trick Lighted Molding. It installs easily on the bottom edge of the rear fender & provides a classy finishing touch.

Fits: '01-'09 GL1800 Models

9017	Rear Fender Trim (ea)	\$29.99
-------------	------------------------------	----------------





TURNDOWN EXHAUST EXTENSIONS for GL1800

Our sleek Turndown Exhaust Extensions give your GL1800's exhaust a smooth, finished appearance. Beautiful chrome & sturdy steel construction will provide years of trouble-free service. They quickly & easily replace the stock exhaust tips, no modification required!

Fits: '01-'09 GL1800 Models

7606 | Turndown Exhaust Extensions for GL1800 (pr) | \$135.99



GLOW RING EXHAUST EXTENSIONS for GL1800

We can't think of anything that would add more pizzazz to the rear of your Wing. Everyone following you will notice these babies.

Fits: '01-'09 GL1800 Models

7602 | Glow Ring Exhaust Extensions for GL1800 (pr) | \$289.99



Complete Oval of L.E.D.'S!

TRIPLE STRAIGHT EXHAUST EXTENSIONS for GL1800

These burly Exhaust Extensions really make a statement. Their size & six outlets elude to the power of the 1800 c.c. giant. Although the six outlets are massive for the appearance of a high performance exhaust system, they are actually sealed off & the exhaust gases are directed downward, out the bottom of the extension. This will keep the visible end of the extension clean & it will aid in keeping soot off saddlebags & trailers. These extensions easily replace the stock muffler tips & include necessary mounting hardware.

Fits: '01-'09 GL1800 Models

7604 | Triple Straight Exhaust Extensions for GL1800 (pr) | \$176.99

TOURING

Raise Your Luggage Rack 5/8" for Easier Cleaning

7151

7154



LUGGAGE RACK for GL1800

The styling of our Luggage Rack for the GoldWing is as fresh as the look of the GL1800! The billet aluminum construction has a burly look & is extremely strong. Finished in dazzling chrome of course!

Fits: '01-'09 GL1800 Models (will install with Honda Spoiler)

7151 | Luggage Rack (ea) | \$239.99

Note: Luggage Rack Risers sold separately.

LUGGAGE RACK RISERS for GL1800

By popular demand, we now offer a kit to raise our Luggage Rack (P/N 7151) by 5/8" & gives you a larger diameter footprint. This will make cleaning under your rack easier as well as spread the load a bit. Reuses stock mounting holes if you already have a luggage rack.

Fits: '01-'09 GL1800 Models (For use with Kuryakyn Luggage Rack P/N 7151)

7154 | Luggage Rack Risers for GL1800 (set) | \$39.99

LID ORGANIZER BAG for GL1800

Is your trunk compartment beginning to resemble the junk drawer in the kitchen? At least keep important or fragile items at your fingertips with the Lid Organizer Bag. A variety of padded & see-through mesh compartments offer protection & easy accessibility for frequently used items. Who says you can't take it with you? Quick disconnect fasteners & handles make it easily portable.

Included Items: Lid Organizer Bag, 1/4 Turn Mounting Connectors

Dim: 12" Tall x 22" Wide

Fits: All '01-'09 GL1800 Models

4135 | Lid Organizer Bag for GL1800 (ea) | \$51.99

1/4" Turn Quick Detach; Fold-N-Go!

Convenient 5" x 7" Flip-Out Mirror



DELUXE CONVERTIBLE™ LUGGAGE RACK BAG with Protective Cover

Bring everything you need with you! Elastic mesh pockets & multiple pouches make your items readily accessible. 1200 Denier nylon construction, heavy-duty zippers, & zip-out rain cover. Bags also feature mounting straps utilizing both hook-&- loop fasteners & elastic shock cords. Attaches to GL1500 & GL1800 racks as well as most other racks on the market.

4162 | Black (ea) | \$49.99

4165 | Black/Silver (ea) | \$49.99

4170

Handles & Shoulder Strap for Easy Transport!

TOUR TRUNK & SADDLEBAG LINERS

After a long day in the saddle, you want to easily grab your things & get to where you're spending the night. Made of tough black Cordura, these removable Saddlebag & Tour Trunk Liners not only keep things organized, they have handles & an included shoulder strap to make unloading & carrying your luggage quick & easy.

Fits: '01-'09 GL1800 Models

4170	Saddlebag Liners (pr) Dim (each): 23" tip to tail slanted saddlebag liners, 10" tall x 6" wide	\$64.99
4177	Tour Trunk Liner (ea) Dim: 21" wide, 15" tall x 8" deep	\$54.99



4177

NEW



4170

DAILY TOUR BAG

The perfect day bag! The Daily Tour Bag provides just enough room for items needed on a full day or overnight journey. The semi-rigid bag holds its shape empty or full & mounts about anywhere on the back of your bike.

Mounting Options:

- Large or small Tour-Pak luggage rack
- Backrest with or without a luggage rack (with 10" of clearance from the top of the backrest down)
- Solo luggage rack

Features:

- Large front hatch & end hatch allow ample access for loading & unloading
- Side pockets for additional storage
- Waterproof zippers with rain cover
- 1200 Denier & semi-rigid construction for durability & shape retention

Included Items: Bag, Shoulder Strap, Adjustable Universal Straps, "Y" Strap & Rain Cover

Dim: 12" Long x 10" High x 15" Wide **Cubic Inches:** 1,800

4133 | Daily Tour Bag | \$124.99



Additional Luggage Options - pg 151

GRANTOUR BAG

With multiple mounting options (sissy bar, luggage rack, passenger seat) this versatile bag is the ultimate companion for weekend trips or short tours. A semi-rigid internal framework serves two purposes. It helps the main compartment hold its shape – even when empty – & it provides adjustable lumbar support for the rider's back. Large zipper pulls are glove-friendly & the retractable locking device keeps bag right where you want it. Made of 1200 Denier & leather, the weather-resistant GranTour Bag comes with a rain cover for added protection.

Included Items: Bag, Passenger Seat Mounting Pad System, Adjustable Straps, Retractable Lock, Rain Cover, & Backrest Pad

Dim: 18" Tall x 14" Deep x 20" Wide **Cubic Inches:** 3,744

4141 | GranTour Bag | \$189.99



Use As a Driver Backrest!





ANTENNA FLAG MOUNT WITH FLAG

This is definitely an easy, out of the way antenna base flag mount. Made of sturdy aluminum, this flag is 4 1/2" x 8 1/2" with a total height of about 12". Just tighten a set screw & hit the road with pride.

4233	Antenna Flag Mount with Flag for GL1800 (ea) Fits: '01-'09 GL1800 Models with stock antenna or over approximately a 0.6" tube	\$69.99
4253	Antenna Flag Mount with Flag for GL1500 (ea) Fits: All GL1500	\$69.99



FLAG POLE & HOLDER For Luggage Racks

Fly your flag proudly. Highly stylized holder allows you to adjust the angle of the staff without tools. Use the flagpole included in the kit for a blended, one-piece look, or insert your own pole – the tapered holder will secure a 1/4" to 3/8" flagpole. Two versions are offered; one specifically designed for our Luggage Rack for GL1800 (P/N 7151) & one designed for our Tubular Luggage Rack for GL1500 (P/N 7150) or any other racks or rails constructed of 1/2" tubing. Includes a 4-1/2" x 8-1/2" American flag.

4216	Flag Pole & Holder (ea) Fits: Kuryakyn Luggage Rack for GL1800 (P/N 7151)	\$79.99
4215	Flag Pole & Holder (ea) Fits: Kuryakyn Luggage Rack for GL1500 (P/N 7150) or other 1/2" tubing applications	\$79.99



PRIMOSHIELD™ FULL & HALF COVERS

Lightweight, compact & water-resistant bike covers offered in full or half sizes. A soft fabric liner protects your windshield & fairing from abrasion. The bottom panels are heat/scorch resistant & includes an elastic hem coupled with reinforced grommets & shock cords to ensure a great fit.

4120	Full Cover, Black (ea)	\$69.99
4122	Full Cover, Silver (ea)	\$69.99
4121	Half Cover, Black (ea)	\$49.99
4123	Half Cover, Silver (ea)	\$51.99



ANTENNA MOUNT FLAG

Secure this American flag to your bike's antenna quickly & easily. Includes both an American Flag & a plain, customizable white flag to help you stand out at the next rally. (Flags measure 6" x 8").

4217	Antenna Mount Flag (ea)	\$17.99
-------------	--------------------------------	----------------

VERTICAL MOUNT FLAG

Pride. Love of country. Respect. Whatever the reason you choose to display Old Glory or remember our P.O.W.'s, these flags deserve to be displayed with honor & in their best light. Mount straight, securely, & with dignity. Fits most luggage racks or any 1/2" tubing including front fender rails. American Flag is 6" x 11" & P.O.W. MIA Flag is 6" x 9".



4254	1/2" Vertical Flag Mount (kit) Fits: Kuryakyn Luggage Rack for GL1500 (P/N 7150) or Universal on 1/2" horizontal tube	\$69.99
4255	3/4" Vertical Flag Mount (kit)	\$69.99



Wiring Harness & Relay All in One Kit!

TRAILER WIRING HARNESS & RELAY

Safely & properly apply the load from the trailer lighting to the battery & not to the rest of the bike's wiring/relays/fuses with this Trailer Wiring Harness & Relay. Select the Universal or GoldWing specific Plug-&-Play kit that plugs inline to the bike's main rear harness. All kits finish up by connecting directly to your battery & wiring to your trailer plug. Add the 5 to 4 Converter for trailers with 4-wire connectors & it plugs right inline to the Kuryakyn Trailer Wiring Harness & Relay. This is the easiest wiring you'll ever have to do.

7665	Plug-&-Play Wiring Harness & Relay for GL1800 (ea)	\$69.99
7666	Plug-&-Play Wiring Harness & Relay for GL1500 (ea)	\$69.99
7667	Universal Wiring Harness & Relay (ea)	\$69.99
7669	Plug-&-Play Universal 5 to 4 Wire Trailer Hitch Converter (ea)	\$29.99

Note: Receptacle kits are not included because the style of receptacle used on trailers varies from manufacturer to manufacturer.

DEBRIS MODULATOR MUD FLAP For GL1800

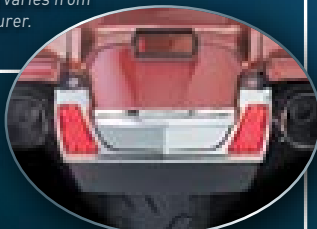

Helps reduce road spray & leaves the dirt behind you. Black & chrome with 2 stylized lenses. The run-&-brake function of these lights adds an extra measure of visibility to boot!

Fits: '01-'09 GL1800 Models

7251	Debris Modulator Mud Flap (ea)	\$155.99
7248	Mounting Kit for use without Kuryakyn Trailer Hitch (ea)	\$39.99
7249	Mounting Kit for use with Kuryakyn Trailer Hitch (ea)	\$22.99
7646	Mudflap Adapter Required when using Debris Modulator with Mounting Kit (P/N 7248) & Exhaust Extension (P/N 7604 or 7602) (ea)	\$25.99



No Need to Loosen the Pipes and/or Saddlebags for Installation!

TRAILER HITCH for GL1800

Our Trailer Hitch for the GL1800 is good looking, strong, & very easy to install. This hitch features a 6 point mounting system for superior strength & rigidity. Installation can be performed easily with the bike on it's center stand & requires only a few common hand tools. When installed, the mounting framework is completely out of sight. Only the hitch ball assembly & front mounting points are visible. The rear support plate is easily removed for quick & effortless tire changes. We feel there is no stronger, easier to install hitch available from any source, at any price.

Fits: '01-'09 GL1800 Models

7647	Trailer Hitch for GL1800 (ea)	\$299.99
-------------	--------------------------------------	-----------------

TRAILER HITCH RACK **NEW** for GL1800

Bring a fully loaded cooler or those extra items with you that just don't seem to fit in your trunk. Simply install the mounting plate beneath your trailer hitch ball & this rack quickly attaches or detaches in seconds.

Dim: 18" Wide x 12" Long x 1-1/2" Deep Weight = 6-1/2lbs

Fits: Kuryakyn Trailer Hitch (P/N 7647) & Universal Applications*

7643	Trailer Hitch Rack (ea)	\$159.99
-------------	--------------------------------	-----------------

Note: Requires Trailer Hitch (P/N 7647) for installation, sold separately. This product is not intended to be used while pulling a trailer. Suggested weight limit is 35lbs for appropriate handling & cornering.

**Universal mounting under hitch ball. Requires a flat/unrestricted area 5" wide x 2-1/2" long & ball stud able to accept a 1/4" spacer. Will not install with Trailer Hitch Receptacle (P/N 9183).*

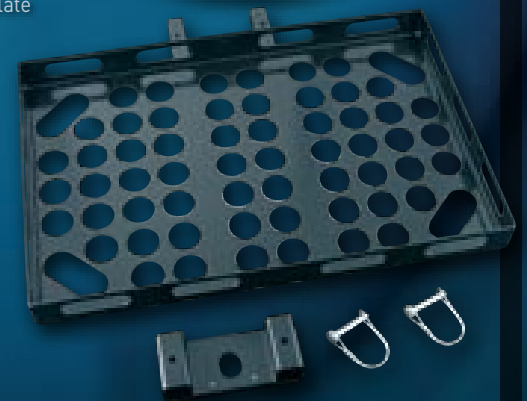

TRAILER HITCH BALL COVER

Fits: All 1-7/8" & 2" balls (Includes foam lining)

7658	Trailer Hitch Ball Cover (ea)	\$10.99
-------------	--------------------------------------	----------------

TRAILER HITCH RECEPTACLE

5-pin receptacle with a chrome mounting bracket.

9183	Trailer Hitch Receptacle, Universal (ea)	\$48.99
-------------	---	----------------

Note: Will not install with Trailer Hitch Rack (P/N 7643).



GL1500

See More...

- >> Grips & Grip Accessories - pg 18
- >> Pegs & Brake Accessories - pg 29
- >> Touring Accessories - pg 40

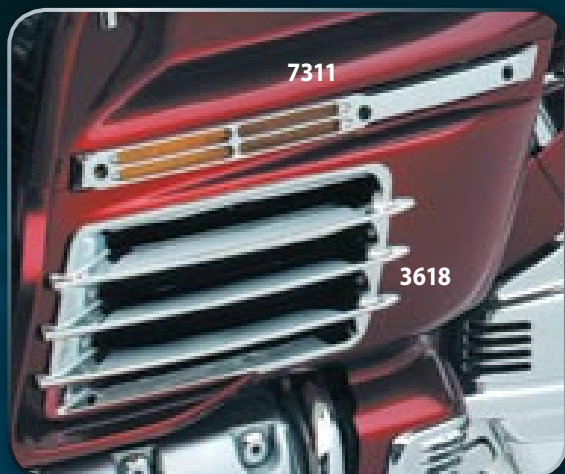

FAIRING SIDE MOLDING TRIM for GL1500

This one-piece Fairing Side Molding Trim really adds sparkle to the GL1500 fairing. Gently radiused edges & angles create a flowing appearance that complements the lines of the fairing. For the ultimate effect, use these in combination with our Fairing Exit Grills.

Fits: All GL1500 Models

7311 | Fairing Side Molding Trim (pr) | \$62.99

CHROME FAIRING EXIT GRILL COVERS for '98-'00 GL1500

Tired of looking at the "black hole" in the side of your GL1500 fairing? Transform that dark void into a gleaming, aggressively styled chrome accent. With our Fairing Side Molding Trim you'll be the talk of the town!

Fits: '98-'00 GL1500 Models

3618 | Chrome Fairing Exit Grill Covers (pr) | \$72.99

Note: No need to disassemble fairing for installation.



LUGGAGE RACK for GL1500

No other rack on the market compares with this gleaming chrome trunk addition. It includes the Kuryakyn exclusive ISO-Mount Kit which reduces stress at the mounting points & lessens the possibility of cracking or damaging the lid. Works with or without the OEM spoiler.

Fits: All GL1500 Models

7150 | Luggage Rack with Mounting Kit (ea) | \$89.99

7155 | Luggage Rack Mount Kit (ea) | \$16.99

TUBULAR GRILL for GL1500

Add a whole new look to your GL1500 with our classy chrome tubular steel radiator grill.

7550 | Tubular Radiator Grill (ea) | \$72.99



L.E.D. RING OF FIRE™ for GL1500

Enhance your wheel with super-bright rows of L.E.D.'s. Amber L.E.D.'s shine outward & your choice of color shine inward. Lazer Spoke Accents (P/N 3699) are the perfect complement!



7400 | L.E.D. Ring of Fire, Amber Light Shining Inward (pr) | \$124.99

7403 | L.E.D. Ring of Fire, Red & Blue Light Shining Inward (pr) | \$176.99

7404 | L.E.D. Ring of Fire, Green Light Shining Inward (pr) | \$169.99

LAZER™ SPOKE ACCENTS for GL1500

Intensify flashes of sunlight or reflect rays of color from your Ring of Fire with these great accents.



3699 | Lazer Spoke Accents (set) | \$93.99

HIGH OUTPUT CHARGING SYSTEM for GL1500

With two & one half times the output of the stock charging system, this is the solution to charging problems on GL1500's even if the bike is loaded with electrical accessories. The 90 amp alternator features temperature compensated voltage regulation, a full 12 month warranty, & delivers an amazing 60 amps even at idle!



500 | 90 Amp Alternator for GL1500 (ea) | \$439.99

501 | 90 Amp Alternator with Generation III Battery for GL1500 (ea) | \$535.99

502 | Compufire Generation III Battery (ea) | \$149.99

AUTOLITE™ SPARK PLUGS

Upgrade to high performance by swapping out your original equipment plugs. Fine wire platinum increases ignition power & extends the life of these superior plugs.



Fits: '88-'00 GL1500, '96-'03 Valkyrie, '84-'87 GL1200

325 | Autolite Platinum Spark Plugs, MP4164 (pr) | \$14.99



DIAMOND LIGHTS

3098	with Red Lens (pr)	\$41.99
3100G	with Red Lens (ea)	\$25.99
3100H	with Red Lens (ea)	\$25.99
3600	Diamond Light Lens Grills, Chrome (pr)	\$11.99
3103	Replacement Bulb - #161 Low Intensity (ea)	\$1.99



REPLACEMENT HEADLIGHT BULBS

These bulbs are the most common H-4 bulbs used in motorcycle applications. They have a 3-prong (P43t style) base. Direct replacement for '80-'97 GL & all Valkyrie (except Interstate) as well as all other bikes using H-4 style bulbs with a P43t base.

2137	90/100 Watt (Clear) - High Intensity	\$9.99
2134	55/60 Watt (Rainbow) - Foul Weather; Rain or Fog	\$12.99
2144	55/60 Watt (Premium Blue) - Our Brightest; Light Most Closely Resembles Sunlight	\$12.99
2142	55/60 Watt (Blue/White) - Equal to 100 Watt Clear	\$19.99

Also Available...

HIGH PERFORMANCE HEADLAMP BULB
Extreme super white bulbs. See pg 12



P/N 2222

CONDORS for GL1500

Stick-on application. Mini Condors are 1-3/4" wide & Medium Condors are 2-1/4" wide.



5151

5150	Mini Condor for GL1500 (ea)	\$7.99
5151	Medium Condor for GL1500 (ea)	\$8.99

LICENSE LIGHT BAR for GL1500

Add this bar to the back end of your Wing for added visibility.



3300	License Light Bar (ea)	\$72.99
------	------------------------	---------



4052

Maximum Comfort Cruise Pegs for GL1500!

ERGO CRUISE PEGS

Ergonomically designed for maximum driver comfort, these mounts make possible an unbelievable range of adjustment for the tall, short or in-between rider. The articulated mounting bracket is made of highly polished stainless steel for extreme strength, great looks & simple installation. The 6" long chrome swingarm has an ingenious locking mechanism & is canted at a 6 degree angle which angles the pegs just the right amount for ideal comfort.

Fits: '98-'00 GL1500 & All Valkyrie (except Interstate)

4050	Ergo with Dually ISO-Pegs (pr) <small>U.S. Patent D405,393</small>	\$199.99
4040	Ergo with Lighted Cruise Boards (pr)	\$289.99
4041	Ergo with Unlighted Cruise Boards (pr)	\$270.99
4052	Ergo with ISO-Wings (pr)	\$218.99



4050



4041



4040



4054

CRUISE FOOTREST MOUNTS WITH PEGS OR BOARDS for '88-'97 GL1500

The innovative cast mount provides a wide range of adjustment front to back to accommodate riders of just about any height. The mount also angles the pegs inward slightly for even more driver comfort.

7330	Cruise Mounts with Dually ISO-Pegs (pr) <small>U.S. Patent D405,393</small>	\$155.99
4054	Cruise Mounts with Unlighted Floorboards (pr)	\$199.99



7330

ERGO TO ERGO II UPDATE

For riders wishing to update their original Ergo Pegs to the Ergo II type clamp. Retains existing arm & footrest.

Fits: '01-'09 GL1800 Models

4063	Ergo to Ergo II Update (pr)	\$124.99
------	-----------------------------	----------

