

2010

IKEA®

ALL CATALOGUE PRICES ARE MAXIMUM PRICES VALID UNTIL 18 JULY 2010

VANVIK king-size bed frame €339 See page 170



KARLSTAD 2-seat sofa
See page 49

€349



IKEA.IE

Offer of the week

All year round, we like to bring you some extra special treats. Great products - great deals! Each offer-of-the-week is only available while stocks last. So grab your diary and put a great big ring round the dates, and check your store for details.

31 August - 13 September 2009

DRACAENA MARGINATA potted plant

€3.59

DRACAENA MARGINATA potted plant
Pot size Ø17cm. Plant H75cm. 501.272.28

14 - 20 SEPTEMBER



MARTORP 2-seat sofa bed

€249

PRICE AFTER OFFER €389

MARTORP 2-seat sofa bed
170×86, H87cm. Bed size: 115×185cm.
Grey black. 601.714.71

28 SEPTEMBER - 4 OCTOBER



LACK triangular side tables

€5.99/ea

PRICE AFTER OFFER €7.99/ea

LACK triangular side tables
Printed and embossed finish.
55×55, H45cm. White. 301.494.34 Birch effect. 801.494.36

12 - 18 OCTOBER



LEKSVIK 4-drawer chest

€59.99

PRICE AFTER OFFER €99

LEKSVIK 4-drawer chest
Stained solid pine. 95×49, H82cm. 700.341.91

19 - 25 OCTOBER



RIMSBO table lamp

€14.99

PRICE AFTER OFFER €29.99

RIMSBO table lamp
Nickel-plated steel/glass.
Max. 75W. H47cm. 601.060.46

9 - 15 NOVEMBER



NORDBY 3-piece art panel sets

€44.99/ea

PRICE AFTER OFFER €59.99/ea

NORDBY 3-piece art panel sets
118×76cm.
Blue and white flowers. 201.747.54
Pink flower. 401.747.53
Country lane. 601.747.52
London. 801.747.51
Jetty/blue sky. 901.747.55

23 - 29 NOVEMBER



NORDEN gateleg table

€89.99

PRICE AFTER OFFER €109

NORDEN gateleg table
Solid birch. 26/89/152×80, H74cm. 000.715.82

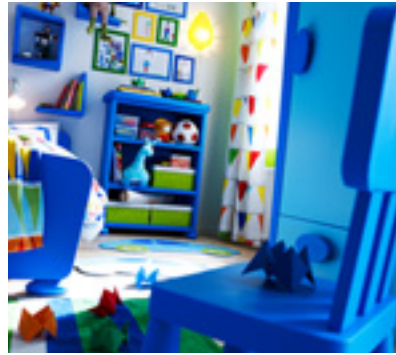

What's your personal passion?

Colour? Technology? The view from your bedroom window? You know what does it for you. And that makes you the best person to design your home.

Opening our new store in Dublin has been an exciting step forward for us. We know you'll love our 2010 product range, but we also know that YOU are the secret ingredient that will give your home that something extra.

So why not start by playing around with what you already have? Try moving your sofa to a new spot. Then add a colourful rug, a new chair or some storage. Done! The rewards are rich, and instant.

This year's catalogue gives you 380 pages of great ideas from our range – functional, well-designed furnishings at prices that make easy changes even easier. For even more, check out our web site. Or come to the store and try out beds, sink into sofas and "live" in inspirational rooms. Discover a world that works wonders for you and your home! Welcome to IKEA!

Martin Hansson
Country Manager
IKEA IRELAND



Contents

16	Living room Living rooms, sofas, armchairs, sofa beds, coffee tables, TV solutions, storage furniture
90	Dining Dining rooms, tables, chairs and stools, dining sets
112	Kitchen Kitchens, interior fittings, door styles and pricing, kitchen planning tools
140	Bedroom Bedrooms, bedroom ranges, beds, chests, mirrors, wardrobes, mattresses
190	Youth room Youth bedrooms
200	Bathroom Bathrooms, bathroom ranges, organisers
212	Textiles Bed textiles, quilts and pillows, curtains and blinds, cushions, rugs
246	Children's IKEA Children's rooms, nursery, baby, storage, play furniture and toys
266	Workspaces Workspaces, desks and storage, laptop solutions, work chairs, drawer units
290	Home organisation Hallways, clothes and shoes organisers, storage ranges, boxes, small organisers
304	Cooking and eating Knives, pots and pans, baking tools, food storage, tableware, serving
322	Lighting Floor lamps, table lamps, ceiling lamps, integrated lighting
334	Decoration Vases, candle holders, plant pots, wall decoration, frames and pictures
348	Buying guides Product parts and prices
360	Information Offer of the week 2 IKEA FAMILY 360 Shopping at the store 366 Services 370 Guarantees 374 WEEE 378 Store information 379 Index A-Z 382 Restaurant 383



BILLY bookcases

€39/ea

MARKÖR coffee table

€129

BILLY bookcases €39/ea. 80x28, H202cm. Black. 701.040.99. IKEA STOCKHOLM 3-seat sofa €1499. 212x89, H72cm. Elegant dark brown. 001.031.83. MARKÖR coffee table €129. See page 69.



BILLY bookcases

€39/ea

BILLY bookcases €39/ea 80x28, H202cm. Red. 001-181-20. KRAMFORS 2-seater sofa €499 178x97, H74cm. Myrby red. 998-493-48. LACK side table €5.99 55x55, H45cm. Red. 701-042-56.

LACK side table

€5.99

BILLY bookcases with doors

€59/ea

LACK side tables

€5.99/ea

BILLY bookcases C25/ea 80x28, H106cm. White. 636.883.10 BILLY BYOM doors C17/ea 40x98cm. White. 301.040.82
KLIPPAN 2-seat sofas C299/ea 180x88, H66cm. Skinnarp white. 301.385.29 LACK side tables C5.99/ea 55x55, H45cm. White. 200.114.13

Some things definitely get better with age.
Take the price of our BILLY bookcase.



*Gillis Lundgren
designed the first
BILLY 30 years ago.
41 million bookcases
worldwide later,
it's more up-to-date
than ever..*

The BILLY bookcase costs much less today than when it was conceived 30 years ago. Because the greater quantity we make of a designer product, and the flatter we make its flat-packs, the more we save on production and transportation costs. Savings that go directly to you.

We're all from Småland

If you want to really understand someone, take a look at their home. Nose along their bookshelves, peer at their pictures, have a snoop in the bathroom cabinet, (if you're that brazen). It's the background that explains the foreground.

This is our background. Home is an area of southern Sweden known for its poor soil, thrifty attitude and hard-working (stubborn!) people. You can't farm thin soil the same way you can a fertile field. You have to work harder, adapt your ideas and do things differently.

That's not so very different from making flat-packed, self-assembled furniture in an industry long known

for "custom-made" and "high-end." Now we've come a long way from being a one-store company in the stony fields of Småland. But at the same time, it feels like nothing at all has changed. For us, it's still about doing more with less, challenging convention, being careful with money and not letting a single thing go to waste. (Good for prices, and good for the planet).

And we've never lost sight of our dream to give everyone the chance of a better everyday life at home.

That's why we pack things in flat boxes, and ask you to lend a hand by driving your purchases home and assembling them yourself.

And it's why we source products from sawmills and door factories, anywhere you might not expect high quality furnishings to be produced, to get prices lower.

We've found people all over the world who, deep down, are Smålanders at heart, just like us. People who hate to throw money down the drain. People who know the value of money, and are willing to work a little harder for something they believe in.

Together we are IKEA.





SALONG vases
€8.59/ea

EXPEDIT bookcase

€69

KARLSTAD 3-seat sofa €699 Soft, hard wearing and easy care leather. 206x93, H80cm. Grann white. 601.391.22 **VEJMON coffee table €139** 140x66cm. Birch veneer. 501.366.71 **SALONG vases €8.59/ea** H20cm. Turquoise. 301.531.38 **€9.99/ea** H31cm. 501.550.04 **EXPEDIT range** Painted and foil finish **Bookcase €159** 185x39, H185cm. Walnut effect. 401.562.83 **Inserts with door €17/ea** White. 401.665.69 **2-drawer inserts €30/ea** White. 801.665.67 **Bookcase €69** Can be used vertically or horizontally. 79x39, H149cm. Walnut effect. 601.562.82

Living room

Totally love it
... practically live in it!

TYGLÖSA
stretcher frames
€4.59/ea

KLIPPAN 2-seat sofa

€189

SMEDSTA
swivel armchairs
€169/ea

Expand your thinking, not your budget.

Transformations can be quick, simple and inexpensive. Change your sofa covers for an easy update. Create your very own carpet from layers of rugs, and get a new look every time you rearrange them. And why not show off your creative talents? Just grab a stretcher frame and head for our groovy textiles department. Everyone will admire the results - and your thrift!

SMEDSTA swivel armchairs €169/ea

Removable covers:
100% cotton. Designer:
Ulf Quensel. 66x95, H100cm.
White/Leaby white. 598.601.92

NORDEN benches €59/ea
Solid birch. 150x35, H45cm.
400.592.96

KLIPPAN 2-seat sofa €189
Extra covers are available
for variation and renewal.
Removable cover: 100% cotton.
180x88, H66cm. Lappmon
multicolour. 298.483.90

VITEN rugs €95/ea
Hand-knotted. Woolmark:
100% pure new wool.
140x200cm. White. 800.849.20

LACK bookcases €95/ea
Painted finish.
105x38, H190cm.
White. 801.036.26

KASSETT range
Painted and paperboard. White.
Boxes for paper
with lids €6.99/2pk
28x35, H18cm. 901.154.88

Magazine boxes
with lids €11.99/2pk
33x38, H30cm. 801.154.84

IKEA 365+ BRASA pendant lamps €55/ea

Give directed light, good for
illuminating, for example,
dining tables or coffee tables.
Light source is sold separately.
Powder-coated steel.
Max. 100W. Ø45cm.
White. 801.316.72

TYGLÖSA stretcher frames €4.59/ea
Make a unique picture by
fastening your favourite
fabric to the frame.
Fabric not included. Solid pine.
50x50cm. 701.260.44

TERTIAL work lamps €5.99/ea
Adjustable arm and head
for easy light direction.
Lacquered steel. Max. 60W.
Silver colour. 403.702.83

IKEA PS VADMAL throw €32.99
Hand-woven. 100% wool.
165x75cm. natural/grey.
501.421.44

IKEA PS PENDEL floor clock €159
Wood/Glass.
56x17, H198cm.
Black. 601.396.93



Layering your curtains will help keep the heat inside, and the cold outside. Varying their weight and using some translucent materials also allows you to let light in however you want to.

KIVSTA shade

€24.99

EKTORP 3-seat sofa

€349

ERSLEV rug

€24.99

MARKÖR coffee table €129 2 drawers in the table underframe, suitable for storing remote controls, etc. Stained solid pine. 90×90, H52cm. Dark brown. 201.157.88

GALEJ tealight holders €0.99/4pk Glass. H6cm. 364.180.00

EKTORP 3-seat sofa €349 Easy to keep clean; removable machine washable cover. Cover: 100% cotton. 215×88, H88cm. Blekinge white. 798.058.40

ERSLEV rug €24.99 Hand-woven. 100% cotton. 140×200cm. Grey. 801.574.93

KIVSTA shade €24.99 Polystyrene plastic, 100% cotton. Ø40, H25cm. Orange. 901.527.20

JANUARI floor lamp base €24.99 Nickel-plated steel. Max.100W. H135cm. 901.325.34

RITVA curtains with tie-backs €29.99/pair 100% cotton. 145×300cm. Grey. 101.564.87

WILMA curtains €11.99/pair 35% cotton, 65% polyester. 145×300cm. White. 800.431.71

MARKÖR bookcase €269 Fittings for wall fastening included. Can also be used as a stylish room divider. Stained, tinted lacquered solid spruce. 151×36, H192cm. Dark brown. 101.058.55

A complete living room for under
€235



1. KLOBO 2-seat sofa €109

Removable cover: 100% cotton. 146x78, H72cm.

Lussebo natural. 200.983.88

2. SOLSTA PÅLLBO footstool €14.99

Easy to keep clean. Removable, machine washable cover:

100% cotton. 39x39, H38cm.

Ransta natural. 701.093.13

3. SVEJE rug €10.99

100% cotton. 90x150cm.

White/black. 201.470.63

4. LACK side table €5.99

Easy to assemble. Painted and foil finish. 55x55, H45cm.

White. 200.114.13

5. LACK TV bench €49.90

Open back makes cable organising easy. Particle board, fibreboard,

ABS plastic, Acrylic paint.

Max. load 65kg. 149x55, H35cm.

White. 001.053.23

6. LERBERG shelf unit €15.99

Low weight. Easy to move about when needed. Powder-coated steel.

60x35, H148cm. White. 801.572.47

7. KVART floor lamp €16.99

Adjustable arm for easy light direction. To be used with reflector bulb only. Painted steel. Max. 40W.

H1.2m. Black. 601.524.15

8. LERBERG DVD/CD wall shelves €4.99/ea

Suitable for CDs and DVDs.

Hang horizontally for CDs and vertically for DVDs. Different wall materials require different types of fixing devices, sold separately.

Powder-coated steel.

85x10, H16cm. White. 001.572.46

€233.83



LERBERG shelf unit
€15.99

LACK side table
€5.99



REGOLIT
pendant lamp shade
€2.99

KARLSTAD 3-seat sofa

€359

KARLSTAD 3-seat sofa

€429

Somewhere everyone can do their own thing ... but together

While the kids are battling it out on the computer, you might want to just relax quietly and catch up on the day's events. With textiles, lighting and rugs, you can create different rooms within a room - and everyone gets to enjoy their own space, as well as the pleasure of each other's company.

POÄNG range

Layer-glued, bent birch frame.

Armchair €99

Provides relaxing resilience. 68×83, H94cm. Birch veneer/ Webbing black. 801.557.81

Footstool €49

68×53, H39cm. 201.557.60

BILLY bookcases €39/ea

Adjustable shelves. Adapt space between shelves to suit your needs. Can be completed with doors, available in different colours and designs. Foil finish. 80×28, H202cm. White. 836.882.10

KARLSTAD range

Removable, washable cover: 100% cotton.

3-seat sofa €359

206×93, H80cm. Blekinge white. 398.405.34

3-seat sofa €429

Rannebo red/white. 898.594.32

KLUBBO coffee table €69

Table top in painted finish.

Leg frame in chrome-plated steel. 118×59, H27cm.

White. 901.339.39

White. 601.350.20

HEMMET rug €179

Latex backing keeps the mat firmly in place. Machine woven. 80% wool, 20% nylon. 200×300cm. Black. 601.175.73

IKEA 365+ BRASA

floor lamp €105

Dimmer function. Adjust the light intensity according to need. Powder-coated steel. Max. 100W. Ø58, H152cm. White. 501.487.68

REGOLIT pendant lamp shade €2.99

Handmade shade. Each one is unique. To be completed with HEMMA cord set. Rice paper. Ø60cm. White. 501.034.11

BENNO TV bench with panel €99

Reinforced back panel for a flat screen TV. No need to drill holes in the wall.

Cables can be hidden at the back. Only for flat screen TV. Foil finish. Max. load 50kg.

120×40, H134cm.

White. 901.339.39

IKEA PS TOTT textile €19.99

Ready to cut fabric.

100% linen. 300×90cm.

White/black. 901.441.55

IKEA STOCKHOLM 3.5-seat sofa

€1399

We resisted everything, except temptation

When creating the IKEA STOCKHOLM collection, we gave in completely to desire. Desire for luxury, for the finest materials - like mohair, velvet, linen, and real leather. So it did get a bit expensive. (For IKEA, that is). But the prices are still infinitely lower than you'll find elsewhere for top-end designer style. And it's all entirely irresistible.

IKEA STOCKHOLM 3.5-seat sofa €1399
Removable cover: 77% cotton, 23% polyester.
237×93, H71cm. Sandbacka red. 701.476.02
IKEA STOCKHOLM coffee table €175
Oak veneer. 170×60, H45cm. 601.037.93
IKEA STOCKHOLM throw €29.99
42% mohair, 30% acrylic, 18% wool,
10% polyester. 130×170cm. Pink. 401.051.23
IKEA STOCKHOLM bowl €24.99
Stainless steel. Ø42cm. 901.100.61

Superb quality for everyone at [IKEA.IE/STOCKHOLM](https://www.ikea.ie/stockholm)

IKEA®
STOCKHOLM



LIATORP storage/TV bench

€1057

SIGNE rugs

€1.89/ea



LIATORP helps you think smart, even when your space is small. With design details like removable cornices and plinths, you can create a custom-made look that fits neatly into your scheme of things.

- EKTORP 3-seat sofa €449**
Removable, machine washable cover: polypropylene plastic. 215x88, H88cm. Klinto blue. 698.493.16
- SOCKERÅRT vase €13.99**
Can also be used as a jug. Enamelled steel. Designer: Sigga Heimis. H22cm. White. 801.484.65
- ROFYLLD rocking chairs €34.99/ea**
Clear and tinted solid rubberwood. 42x68, H56cm. Red/rubberwood. 101.148.88
- SIGNE rugs €1.89/ea**
Machine washable, easy to keep clean. Hand-woven. 100% cotton. 60x90cm. Multicolour. 300.523.99
- HEMNES daybed frame with 3 drawers €359**
Product with four functions: sofa, single bed, bed for two and storage. Mattress and bedlinen are sold separately. Painted and foil finish. 87x211, H86cm. Bed size: 80x200cm. White. 500.803.15
- LIATORP storage/TV bench €1057**
Cornice and plinth rail help create a uniform expression when two or more units are connected together. Painted finish and tempered glass. 337x49, H214cm. White. 598.722.51
- LINDVED side table €16.99**
Powder coated steel. Ø50, H68cm. White. 301.256.97

TYLÖSAND sofa combination €1328 Easy to keep clean: removable dry-clean cover. 5 cushions included. Removable cover: 55% cotton, 41% viscose/rayon, 4% polyester. 241/251x91, H76cm. Everöd black. 798.673.57

IKEA PS KARLJOHAN side tables €59/ea Solid birch. Ø47, H27cm. 401.415.07

ALSEDA stool €24.95 Banana leaves. Ø60, H18cm. 200.339.19

BESTÅ/FRAMSTÅ TV/storage combination €707 Foil finish and tempered glass. 360x49, H154cm. Ash effect. 298.627.10

IKEA PS MASKROS pendant lamp €105 Gives a soft mood lighting. ABS plastic. Max. 75W. Ø80cm. 801.462.49

BESTÅ wall shelves €45/ea 4 adjustable shelves. Adjust spacing according to needs. Foil finish. 120x20, H64cm. Black-brown. 501.021.43

KARLSKRONA lounge chair €139 Hand-woven. Each piece of furniture is unique. Rattan. 150x72, H85cm. 600.752.57

HÄSTÖ headrest €6.99 801.405.82



Create your own home cinema with **FRAMSTÅ** panels. Attach your TV directly to them, and feed the cables through the pre-cut hole. Which means you can focus on the film, rather than an unattractive tangle of wires.

**BESTÅ/FRAMSTÅ
TV/storage combination**

€707



ALSEDA stool

€24.95



BEDDINGE LÖVÅS
3-seat sofa bed

€319

BEDDINGE LÖVÅS 3-seat sofa bed €319 Removable, washable cover: 100% cotton. 200×104, H91cm. Bed size: 140×200cm. Laxbro cerise. 498.600.98
BESTÅ range Foil finish Wall shelves €45/ea 120×20, H64cm. White. 801.340.53
BESTÅ TOMBO glass doors €35/ea Tempered glass. 60×64cm. 201.035.54
Shelf unit/height extension units €60/ea 120×40, H64cm. White. 401.340.50
BESTÅ VARA doors €15/ea 60×64cm. White. 801.344.30

Let your room work for you 24/7



BRÅDA laptop support
€11.99

Portable and easily stored away

BRÅDA laptop support €11.99
The fabric is removable and washable, easy to keep clean. Cover: 100% cotton. Upholstery material: Plastic. Almås white/beige. 001.157.94



The perfect hideaway

DIGNITET curtain wire €9.99
Stainless steel. Max. load 5kg. L500cm. 600.752.95
WILMA curtains €11.99/pair
35% cotton, 65% polyester. 145×300cm. White. 800.431.71



From social scene...

BEDDINGE storage box €24.90
The bed storage box goes under the sofa-bed. Will hold quilts and pillows for two. Foil finish. 165×69, H16cm. Silver colour. 100.367.20

BEDDINGE storage box
€24.90



.... to totally serene Just pull and unfold
BEDDINGE LÖVÅS 3-seat sofa bed €319 Laxbro cerise. 498.600.98

ANTIFONI floor/
reading lamp

€49.99

Your sofa sees a lot of action, day after day. Endless sitting, lolling and lounging - all in the name of relaxation. So we push a 100kg. weight 50,000 times against each design of seat, to make sure it will take the pace, whoever's taking a little rest.

Mounting your flat screen looks stylish, but also makes it much more stable, which is useful with kids around. And we've made sure our wall bracket for flat TVs can hold up to 60kg. TV bracket is sold separately.

It's the odd chocolate stain or spilt drink that you want to remove, not the lovely rich colour of your beautiful sofa. So we test our colours for fastness, even faced with the aftermath of your favourite foodie fiends.

Sometimes sofas have to handle an overflow of people. So it's good to know that we test the designs of our armrests by pushing a 90kg. weight onto them 5,000 times.

Find DVD. Replace DVD. Take out CD... and so it goes on. And on. But we test-drive BESTÅ drawers 30,000 times to ensure they always work smoothly for you.

It's surprising how many times you slide across those doors to watch or hideaway the TV. We try it 20,000 times, to simulate real life.

EKTORP right-hand
chaise longue

€320

Has anyone ever heard of a "sit-still room"?

Precisely. Which is why we make furniture for real life. It's not afraid of your kids' sticky fingers. Or your friend who always plops himself down on the sofa armrest. Or the way teenagers tend to bang cupboard doors closed. We put all our furniture through endurance testing to make sure it can stand up to everyday life. EKTORP sofas and BESTÅ storage are just two of our products that come with a 10-year quality guarantee. Which means you can get on with exactly what the living room is intended for... the business of living.



BESTÅ and EKTORP have a 10-year guarantee. Find out more on page 374.

EKTORP range

Removable, machine washable cover: polypropylene plastic. Idemo red.

Left-hand chaise

longue €320
86x163, H87cm. 798.628.35

Right-hand chaise

longue €320
86x163, H87cm. 998.628.39

BESTÅ/INREDA / TV storage combination with sliding doors €809

Reinforced back panel for a flat screen TV. (TV bracket sold separately.) No need to drill holes in the wall and cables can be hidden at the back. Foil finish and tempered glass. White. 398.717.90

ANTIFONI floor/reading lamp €49.99

Halogen bulb included; extra bulbs are available. Transformer conventional, separate plug-in 50/60 Hz. Painted steel. Max. 40W. H150cm.

Black. 101.287.86

STRIND side table €69

Castors make it easy to move. Table top and shelf in tempered glass. Frame in nickel-plated, lacquered steel. Ø50, H62cm. White/nickel-plated. 201.571.08



GRUNDTAL
cabinet lighting
€19.99/ea

BILLY bookcases,
80x28, H202cm

€69/ea

End the drama, by knowing exactly where you'll find that favourite book

BILLY bookcases €69/ea

Four adjustable shelves. Adapt space between shelves according to your needs. Oak veneer. 80x28, H202cm. 900.666.47

BENNO TV bench with panel €119

Reinforced back panel for a flat screen TV. No need to drill holes in the wall and cords can be hidden at the back. Oak veneer. Max. load 50kg. 120x40, H134cm. 701.339.40

RIBBA picture ledges €8.99/ea

The picture ledge makes it easy to vary your favourite motifs as often as you like. Foil finish. Max. load 7.5kg. L115cm. Black. 301.525.96

BILLY bookcases €49/ea

Narrow shelves help you to use small wall spaces effectively by accommodating small items in a minimum of space. Oak veneer. 40x28, H202cm. 600.857.13

BENNO DVD towers €35/ea

Holds 180 CDs or 88 DVDs or 40 video cassettes. Oak veneer. 20x17, H202cm. 500.666.49

GRUNDTAL cabinet lighting €19.99/ea

Nickel-plated steel. Max. 20W. 001.298.71

BILLY book/magazine rails €10/ea

Edging that attaches to the shelf, keeps your magazines and books in place. Anodised aluminium. W76cm. 701.463.44

BILLY/BYOM bookcases with glass doors €75/ea

Foil finish. Door panels: tempered glass. 80x28, H106cm. White. 198.503.45

KOLDBY cow hide €199

101.572.17

KARLSTAD armchairs with long covers €249/ea

Easy to keep clean - removable, machine washable cover. Cover: 100% cotton. 90x93, H80cm. Blekinge white. 098.485.41

IKEA 365+ BRASA floor lamp €105

Dimmer function. Adjust light intensity according to need. Powder-coated steel. Max. 100W. Ø58, H152cm. Black. 301.488.49

TUNDRA floor with click-lock function €9.99/m²

Laminated surface. A hard wearing floor for offices and all areas in the home except wet rooms. 1pk covers 2.39m². Oak effect. 800.700.13



KRAMFORS sofa combination

€1198



Who cares about crumbs, spills or stains? Not KRAMFORS. Made from easy care leather, it can be wiped clean to remove the marks your little ones like to leave behind.

KRAMFORS sofa combination €1198

Seat surfaces and armrests in heavy, hard wearing, easy care grain leather. Practical for families with children. A seating range that allows you to create combinations according to your own needs and ideas. 260x97/160, H74cm.

Marig dark brown. 598.600.88

KOMISK triple cushion cover €16.99

Three connected cushion covers. Complete this with three pillows 65x65cm. to create a multi-functional cushion. To be completed with 3 GOSA ASTER pillows 65x65cm. 100% cotton. 195x65cm. Red. 401.600.77

KAJSA TRÄD cushion cover €5.99

Fits GOSA ASTER 65x65cm. 100% cotton. 65x65cm. White/black. 401.516.81

BESTÅ range Foil finish. White. BESTÅ storage offers different cabinets and doors so you can create personal storage that's built around your space and needs. Shown here with:

BESTÅ NORUM doors €25/ea
Foil finish. 60x38cm.

High-gloss white. 501.035.57

BESTÅ NORUM doors €35/ea
Foil finish. 60x64cm.

High-gloss white. 301.035.58



For more BESTÅ see BESTÅ buying guide at page 348.

Great design comes from expansive minds, with inexpensive ideas

IKEA PS cabinet

€79



Designed by:
Nicolai Wiig Hansen

Designing and producing this cabinet at an industrial locker factory gave us a cool price for a red-hot design.

IKEA PS cabinet €79

Powder-coated steel. 119x40, H63cm. Red. 801.001.90



Designed by:
Nike Karlsson

Trimming dimensions by the millimetre made the package smaller, the transportation smarter and the price lower.

LILLBERG rocking chair €129

Solid birch and 100% cotton. 68x94, H85cm. Gräsbo white. 098.398.05



LAMPAN table lamp
€3.59



Designed by:
Carl Öjerstam and
Magnus Elebäck

The lampshade itself is the packaging – no box needed.

LAMPAN table lamp €3.59

Plastic. Max. 40W. Shade Ø19cm. H29cm. Red. 100.961.15



Designed by:
Noboru Nakamura

Very curvaceous. Very flat-packable. Very cost effective.

POÄNG armchair €79

Birch veneer and 100% cotton. 68x83, H100cm. Alme natural. 398.054.32



Designed by:
Ehlén Johansson

Designing and producing tealight holders in a fuse factory was a brilliant flash of genius.

IKEA PS tealight holders €9.99/12pk

Glazed feldspar porcelain. Ø5, H4.5cm. White. 264.967.10



Designed by:
Thomas Sandell and
Chris Martin

Now any room can be your guest room.

IKEA PS LÖVÅS 2-seat sofa €375

100% cotton. 163x111, H86cm. Bed size 160x205cm. Roma light beige. 398.301.39



Designed by:
Monika Mulder

Peekaboo! Kids can lower the hood of this swivel armchair for a private hideaway, or spin round in it and have some fun!

IKEA PS LÖMSK swivel armchair €49.99

Plastic and 100% polyester. 59x62, H75cm. Blue/white. 401.002.53

IKEA PS wardrobe tidy
€25



Designed by:
Mia Cullin-Gustafsson

A wardrobe that works a bit like a tent – it folds down small, but there's loads of space inside when you assemble it.

IKEA PS wardrobe tidy €25

100% polyester. 52x68, H164cm. Black. 601.224.71



Designed by:
Maria Vinka

Unused banana leaves woven into a very useful, stackable, transport-friendly chair.

IKEA PS GULLHOLMEN rocking chair €49

Banana fibres. 62x68, H75cm. 500.395.52

MAMMUT children's chair
€12.99



Designed by:
Morten Kjelstrup and
Allan Östgaard

A sturdy kids' chair inspired by big animals – and small price tags.

MAMMUT children's chair €12.99

Plastic. 39x67cm. Seat H30cm. Blue. 200.994.96

At IKEA, form follows function... and a really low price!

IKEA PS: BECAUSE WE THINK, AND THINK AGAIN

Creativity is timeless and limitless. That's our design philosophy. So for the new IKEA PS collection, our intrepid teams travelled the globe, finding inspiration in more slow moving worlds, to inform the high tech life of today. From the small villages of India to the deep forests of Sweden. From the great plains of Africa to a small town called Älmhult. New ideas, from ever fertile imaginations.

The IKEA PS NEVER ENDING DESIGN

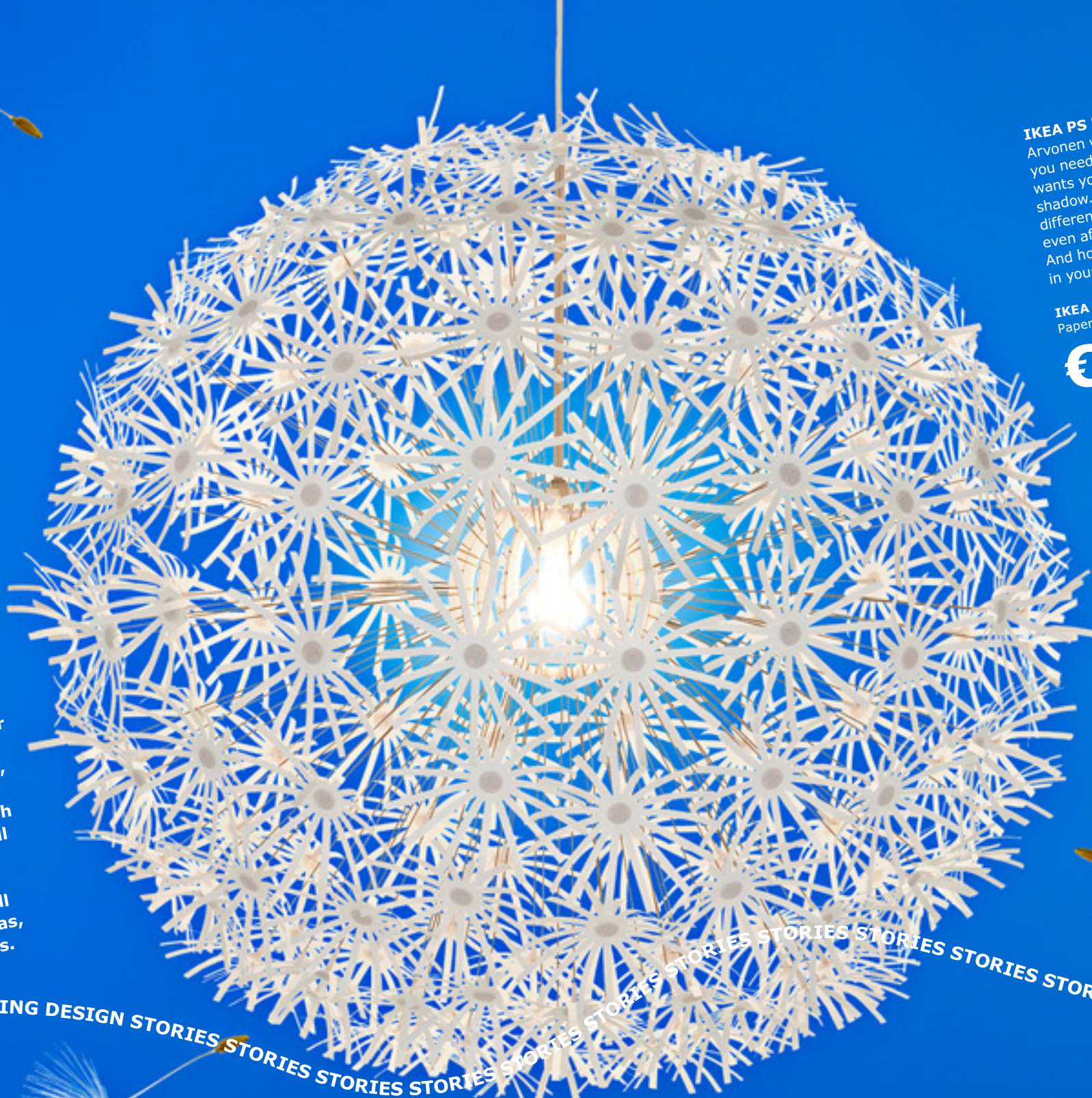

IKEA PS MASKROS was created by Marcus Arvonen with your own input in mind. First, you need to put it together. But Marcus also wants you to consider the interplay of light and shadow. Because this lamp will look and feel different in every room, in every home. It may even affect everyone's mood differently. And hopefully, it will sow a seed of inspiration in your life, just like our design stories.

IKEA PS MASKROSEN pendant lamp €105
Paper. Ø80cm. 801.462.49

€105

STORIES STORIES STORIES STORIES STORIES STORIES STORIES STORIES STORIES STORIES



Discover some of the stories at IKEA.IE/PS

Find yourself a comfy sofa... from the comfort of your own home



EKTORP 3-seat sofa €399
Idemo black. 398.394.94



EKTORP 2-seat sofa €345
Blekinge pink. 898.493.01



EKTORP 3-seat sofa €399
Idemo dark blue. 998.240.17



KLIPPAN sofa €159
Alme white. 398.262.84



KLIPPAN 2-seat sofa €159
Almås red. 998.262.81



LILLBERG 2-seat sofa €189
Black/Gräsbo black. 898.397.93



EKTORP 3-seat sofa €399
Idemo red. 498.628.27



EKTORP 3-seat sofa €399
Idemo beige. 598.058.41



EKTORP 3-seat sofa €349
Blekinge white. 798.058.40



KARLSTAD 3-seat sofa €429
Rannebo red/white. 898.594.32



KARLSTAD 2-seat sofa €339
Sivik light blue. 998.404.75



KARLSTAD 3-seat sofa €519
Linneryd natural. 598.405.28



KARLSTAD 3-seat sofa €699
Tufted/Grann black. 201.391.19



KARLSTAD 2-seat sofa €299
Blekinge white. 098.404.94



KARLSTAD 2-seat sofa €399
Korndal brown. 898.405.03



KRAMFORS 3-seat sofa €629
Myrby red. 398.493.51



KRAMFORS 2-seat sofa €539
Fröjel black/white. 098.396.07



KRAMFORS 2-seat sofa €499
Myrby dark grey. 798.396.04



KRAMFORS 3-seat sofa €589
Risede light grey. 198.366.89



KRAMFORS 2-seat sofa €499
Myrby yellow. 298.396.06



KRAMFORS 3-seat sofa €799
Marig dark brown. 301.558.49



TYLÖSAND 3-seat sofa €739
Everöd black 998.562.25



TYLÖSAND 3-seat sofa €739
Everöd orange. 698.299.31



TYLÖSAND 3-seat sofa €669
Kungsvik sand. 798.192.91



ÄLVROS 3-seat sofa €899
Mjuk dark brown. 401.554.48



ÄLVROS 2-seat sofa €799
Mjuk light beige. 501.554.19



ARILD 3-seat sofa €949
Karaktär black. 400.847.62



IKEA STOCKHOLM 3-seat sofa €1499
Elegant dark brown. 001.031.83



IKEA STOCKHOLM 3.5-seat sofa €1399
Sandbacka red. 701.476.02



IKEA STOCKHOLM 3.5-seat sofa €999
Röstånga white. 701.031.32

With so many fabric and seating options to choose from, it's just not possible to show you them all here! So we suggest you take a look online. There are no closing times to worry about, and you'll have the store completely to yourself...Visit IKEA.IE



IKEA.IE



EKTORP 3-seat sofa
€449



EKTORP 3-seat sofa
€349

EKTORP LÖVÅS
 3-seat sofa bed
€869

EKTORP TULLSTA
 armchair
€135

FOTHULT
 2-seat sofa
€189

EKTORP - Removable, washable, change-your-mindable covers

EKTORP sofas really stand up to everyday life. The washable covers mean spills and stains are never the enemy. And neither are little kids (or grown-up ones), as the durable cushions are made to retain their shape. With a wide choice of seating options and coordinating covers, you'll find EKTORP looks and feels right at home.



EKTORP has a 10-year guarantee. Find out more on page 374.

EKTORP range Removable, machine washable cover: 100% cotton.

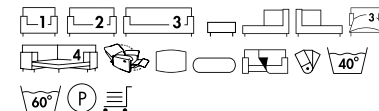

For an explanation of these symbols go to page 359.

LEFT PAGE:

EKTORP 3-seat sofa €449

215x88, H88cm. Byvik multicolour. 098.296.89

EKTORP TULLSTA armchair €155

80x72, H78cm. Natural/Simris red. 998.306.45

THIS PAGE:

1. EKTORP 3-seat sofa €349

Blekinge white. 798.058.40

2. EKTORP 2-seat sofa €349 175x88, H88cm. Idemo red. 498.637.75

3. EKTORP corner sofa combination €880

Bed mechanism is sold separately. 243x88, H88cm. Idemo beige. 298.128.43

4. EKTORP LÖVÅS 3-seat sofa bed €869 Clever hidden storage in the backrest. 221x103, H99cm. Bed size: 160x198cm. Idemo black. 498.495.72

5. EKTORP armchair €289

104x88, H88cm. Klintbo blue. 598.493.07

6. EKTORP JENNYLUND armchair €179

78x81, H84cm. Simris blue. 498.305.01

7. EKTORP MUREN recliner €349

The frame cover is fixed. 86x93, H97cm. Idemo beige. 201.149.77

8. EKTORP TULLSTA armchair €135 80x72, H78cm. Blekinge natural/white. 198.408.32

9. EKTORP BROMMA footstool €125 Storage space under the seat for magazines, toys, etc. 81x61, H45cm. Blekinge pink. 298.492.76

10. EKTORP right-hand chaise longue €340 86x163, H87cm. Hovby white/black. 598.394.69

11. FOTHULT 2-seat sofa €189

Fixed cover. 146x88, H85cm. 100.896.95

See all EKTORP designs, sizes and colours at IKEA.IE/EKTORP



KARLSTAD 2-seat sofa combination

€699

KARLSTAD - Why go out for the evening?

Every part of KARLSTAD has been designed to make your life a little more comfortable. The back cushions are extra soft to sink into, while the highly resilient foam seats support your body nicely. And the armrests have padding on the inside (great for leaning into), as well as on top, giving you a comfy place to perch.



KARLSTAD has a 10-year guarantee. Find out more on page 374.

KARLSTAD
3-seat sofa
€359



1



2



3



4

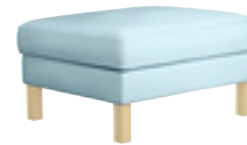

5



6



7



8



9



KNIHULT
2-seat sofa
€249

10

KARLSTAD range. Unless otherwise stated, all covers are removable.

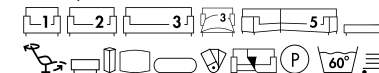

For an explanation of these symbols go to page 359.

LEFT PAGE:

2-seat sofa combination €699
Cover: 87% cotton, 13% polyester.
244×93/158, H80cm.
Korndal brown. 698.529.31

THIS PAGE:

1. 3-seat sofa €359
Cover: 100% cotton. 206×93, H80cm.
Blekinge white. 398.405.34

2. 2-seat sofa combination €699
Removable armrests make it easy to add on a chaise longue. Cover: 87% cotton, 13% polyester. 244×93/158, H80cm.
Korndal blue. 298.424.68

3. Corner sofa combination €899 Cover: 87% cotton, 13% polyester. 240/280×93, H80cm.
Korndal green. 298.404.45

4. 2-seat sofa with long cover €349
Cover: 100% cotton. 166×93, H80cm.
Blekinge white. 798.485.47

5. Footstool €109 Cover: 92% cotton, 8% polyester. 80×64, H48cm.
Sivik light blue. 298.403.51

6. Chaise longue €290
Cover: 100% cotton. 78×158, H80cm.
Rannebo red/white. 598.594.24

7. Armchair €299 Cover: 87% cotton,

13% polyester. 90×93, H80cm.
Korndal red. 898.404.09

8. Armchair €189 Cover: 92% cotton, 8% polyester. 71×72, H80cm.
Dillne multicolour. 998.402.96

9. Swivel armchair €299 Adjustable rocker function, lever under the seat. Fixed cover: 100% wool. 84×90, H109cm.
Ullevi orange. 901.177.60

10. KNIHULT 2-seat sofa €249
Fixed cover: 100% cotton. 139×81, H74cm.
Ransta dark grey. 401.200.86
All **KARLSTAD** sofas come with birch legs. For an additional cost, you can choose from four other options.

See all **KARLSTAD** designs, sizes and colours at IKEA.IE/KARLSTAD



POÄNG armchair
€114

POÄNG – Feels every bit as good as it looks

POÄNG proves that style and comfort really can go hand in hand. Take a seat and you'll discover why its ergonomic design has been a firm favourite for over 30 years. But we don't just rest on our laurels, (comfortable as they may be). We've made a few improvements. You now have not only a wonderfully wide selection of frames and fabrics to suit your style, but also a new rocking chair to aid your relaxation.



POÄNG has a 10-year guarantee. Find out more on page 374.



1

POÄNG
 armchair
€79



2



3



4

POÄNG
 rocking chair
€275



5



6



7



8



9

POÄNG range
 Frames: Stained beech veneer or birch veneer. Removable covers.

LEFT PAGE:
Armchair €114 68x83, H100cm. White/Såganäs white. 998.609.44
Footstool €55 68x53, H39cm. White/Såganäs white. 098.606.51
STRIND coffee table €159
 With castors for easy moving. Separate shelf for storage magazines. Steel. Nickel-plated. Ø100, H40cm. White. 001.571.09

THIS PAGE:

1. Armchair €79 68x83, H100cm. Birch/Alme natural. 398.054.32
2. Armchair €99 68x83, H94cm. Birch/webbing natural. 201.557.79
3. Armchair €99 68x83, H94cm. Birch/webbing black. 801.557.81
4. Rocking chair €275 68x83, H94cm. Birch/Lockarp white. 898.610.05
5. Armchair €109 68x83, H100cm. Brown/Dala natural. 598.607.24
6. Armchair €130 68x83, H100cm. White/light grey. 098.609.48

7. Armchair €235 68x83, H100cm. Birch/Lockarp grey. 098.402.48
8. Armchair €130 68x83, H100cm. Black/Eslöv black/white. 398.608.24
9. Armchair €89 68x83, H100cm. Birch/Alme medium red. 598.251.94

See all POÄNG frames and fabrics at [IKEA.IE/POANG](https://www.ikea.ie/poang)



IKEA STOCKHOLM 3.5-seat sofa

€1399

IKEA STOCKHOLM - Looks expensive. Feels expensive. Isn't. But absolutely isn't.

Once you take a seat, the price becomes even harder to believe. IKEA STOCKHOLM gives you extra everything. High quality materials, like leather, solid wood, velvet and linen. Plus great design, to enjoy for many, many years.



IKEA STOCKHOLM has a 25-year guarantee. Find out more on page 374.

IKEA STOCKHOLM 3.5-seat sofa €999



1



2



3



4



5



6



7



8



9



10

IKEA STOCKHOLM range

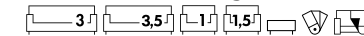

For an explanation of these symbols go to page 359.

LEFT PAGE:

- 3.5-seat sofa €1399**
237x93, H71cm.
Sandbacka beige. 501.476.03
- Coffee table €175**
170x60, H45cm.
Golden brown. 601.037.93

THIS PAGE:

- 1. 3.5-seat sofa €999**
Röstänga white. 701.031.32
- 2. 3.5-seat sofa €1109**
Gammelbo light brown. 301.031.34
- 3. 3.5-seat sofa €1399**
Sandbacka red. 701.476.02
- 4. 1.5-seat armchair €589**
112x93, H71cm.
Gammelbo beige. 401.031.57
- 5. 1.5-seat armchair €649**
Sandbacka black. 701.475.41
- 6. Pouffe €159**
Swivel function. 60x51, H41cm.
Sandbacka beige. 201.475.91

7. Easy chair €279

- 60x80, H71cm.
Figur grey. 601.474.95
- 8. Easy chair €279**
Figur beige. 101.474.93
- 9. Easy chair €269**
Blad multicolour. 701.031.70
- 10. Easy chair €269**
Blad brown. 401.031.76

See all IKEA STOCKHOLM designs, sizes and colours at IKEA.IE/STOCKHOLM



TYLÖSAND footstool

€180



KLIPPAN 4-seat sofa

€299

TYLÖSAND - Solves all seating puzzles, piece by piece



TYLÖSAND
3-seat sofa

€669

1. Sofa combination €940
Removable cover: 55% cotton, 41% viscose/rayon, 4% polyester. Everöd red-brown. Chaise longue combination €760 298.714.27
Footstool €180 91×60, H46cm. 298.628.52

2. Left-hand chaise longue €490
Removable cover: 55% cotton, 41% viscose/rayon, 4% polyester. 91×150, H76cm. Everöd black. 198.562.05

3. 3-seat sofa €669
Removable cover: 100% polyester. 240×91, H76cm. Kungsvik sand. 798.192.91

Removable cover: 55% cotton, 41% viscose/rayon, 4% polyester. 150/241×91/150, H76cm. Everöd orange. 698.312.98

KLIPPAN - Giving you a whole spectrum of choices



KLIPPAN
2-seat sofa

€215

KLIPPAN range
4-seat sofa €299 Removable cover: 100% cotton. 250×88, H66cm. Vansta dark blue. 098.728.90

Pouffe €64 Removable cover: 100% cotton. 54×54, H39cm. Vansta dark blue. 598.492.65

1. 2-seat sofa €215 Removable cover: 75% cotton, 23% polyester, 2% elastane/spandex. 180×88, H66cm.

Genarp white. 998.612.60 **2. 2-seat sofa €499** Cover: Leather. 180×88, H66cm. Fräsig red. 600.831.77

3. Pouffe €64 Removable cover: 100% cotton. Karrum dark green/yellow. 798.483.83

4. SKRUVSTA swivel armchair €99 Height adjustable armchair, swivels to preferred height. Cover: 100% cotton. Steel. 66×68, H72cm. Alme black. 000.451.74



KRAMFORS sofa combination
€870

KRAMFORS - Sit wherever you like

There's room for everyone on KRAMFORS. If you can't find a space to park on the extra-deep seat cushions, there are plenty more on the wide, low armrests, or on the strong, cushioned back. Combine different sections together and create your own social centre.



KRAMFORS has a 10-year guarantee. Find out more on page 374.



KRAMFORS range Removable covers.

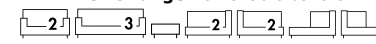

For an explanation of these symbols go to page 359.

LEFT PAGE:

Sofa combination €870

Cover: 77% cotton, 23% polyester. 260x97/160, H74cm. Myrby red. 198.493.33

THIS PAGE:

1. 3-seat sofa €589 Cover: 52% cotton, 30% viscose/rayon, 18% linen. 223x97, H74cm. Risede light grey. 198.366.89

2. 3-seat sofa €629

Cover: 74% cotton, 22% polyester, 3% viscose/rayon, 1% linen. 223x97, H74cm. Myrby yellow. 098.396.26

3. Sofa combination €870

Cover: 74% cotton, 22% polyester, 3% viscose/rayon, 1% linen. 260x97/160, H74cm. Myrby yellow. 198.396.83

4. 2-seat sofa €499

Cover: 77% cotton, 23% polyester. 178x97, H74cm. Myrby red. 998.493.48

5. Right-hand chaise longue €450

105x160, H74cm. Fröjel black/white. 698.395.67

6. Footstool €219

Cover: 77% cotton, 23% polyester. 98x86, H45cm. Myrby red. 298.493.18

7. Footstool €219 Cover: 74% cotton,

24% polyester, 2% viscose/rayon. Myrby dark grey. 798.395.19

8. Sofa combination €830

Cover: 74% cotton, 24% polyester, 2% viscose/rayon. 310x97, H74cm. Myrby dark grey. 598.366.73

9-10. TIRUP swivel armchairs €249/ea

Moulded highly resilient polyurethane foam gives rounded shapes and excellent, durable seating comfort. Fixed cover: 100% cotton. 78x79, H88cm. Eldris black/yellow. 101.200.78
 Eldris black/white. 501.200.76

See all KRAMFORS designs, sizes and colours at IKEA.IE/KRAMFORS



IKEA PS GULLHOLMEN rocking chair €49
Banana fibres. 62×68, H75cm. 500.395.52



KARLSKRONA lounger €139
Rattan. 150×72, H85cm. 600.752.57
HÄSTÖ headrest €6.99
100% cotton. Assorted colours. 801.405.82



BYHOLMA armchair €85
Stained rattan. 68×72, H92cm. Grey. 601.583.04
MARIEBERG chair cushion €12.99
Use both sides. 100% cotton. Laila natural. 900.802.38



HEJKA rocking chair €99
Peeled rattan. 80×86, H73cm. 201.167.21
HEJKA chair cushion €14.99
100% cotton. White. 001.405.24



ALSEDA stool €24.95
Banana leaves. Ø60, H18cm. 200.339.19



SKRUVSTA swivel armchair €99
Height adjustable armchair, swivels to preferred height. Cover: 100% cotton. Seat 48×45, H47-55cm. Rappsta multicolour. 901.407.65



LILLBERG range Removable cover: 100% cotton. 68×94, H85cm.

Rocking chair €129 Stained solid beech or birch. Black/Gräsbo black. 498.397.90
Rocking chair €129 Solid birch. Birch/Gräsbo white. 098.398.05



LILLBERG 2-seat sofa €189
Adjustable back allows you to sit or rest comfortably. Removable cover: 100% cotton. 128×94, H85cm. Black/gräsbo white. 298.398.14



LILLBERG 3-seat sofa €249
Adjustable back allows you to sit or rest comfortably. Removable cover: 100% cotton. 188×94, H85cm. White. 598.398.17



KLOBO 2-seat sofa €109

KLOBO 2-seat sofa €109
Cover: 100% cotton. 146×78, H72cm. Lussebo natural. 200.983.88



SOLSTA OLARP armchair €54.99

SOLSTA OLARP armchair €54.99
Cover: 100% cotton. 66×62, H63cm. Ransta natural. 400.998.48



SOLSTA PÄLLBO footstool €14.99

SOLSTA PÄLLBO footstool €14.99
100% cotton. 39×39, H38cm. Ransta natural. 701.093.13

Why pay more?

Good quality, function and low price



Designed by:
Noboru Nakamura

€99

POÄNG armchair 68×83, H94cm.
Birch veneer/webbing natural. 201.557.79



POÄNG have a 10-year everyday quality guarantee. Find out more on page 374.





ÄLVROS corner sofa combination

€1299

ÄLVROS -Indulgence even your wallet will appreciate

ÄLVROS 3-seat sofa with reclining function

€1199



1



2



3



4

ÄLVROS range

Seat surfaces and armrests in soft, hard wearing, easy care grain leather. Practical for families with children. Legs: Solid beech **Corner sofa combination €1299** Rounded shape provides a lot of space and great seating comfort in the whole corner section. 296x150, H92cm. Mjuk light beige. 401.555.23

1. 3-seat sofa with dual reclining function €1199 Sofa with

2 built-in recliners. Pull the lever on the side of the armrest to lower the back and bring up the footrest. 198x96, H92cm. Mjuk medium red. 601.554.71 **2. Footstool with storage €279** 76x76, H44cm. Mjuk light beige. 901.555.30 **3. Swivel/rocking/reclining/armchair €649** 102x94, H92cm. Mjuk black. 001.554.93 **4. 2-seat sofa €799** 172x96, H92cm. Mjuk black. 101.554.21

Leather seating – A comfortable choice for you and your budget

KLIPPAN 2-seat sofa

€499



KLIPPAN 2-seat sofa €499

Durable, easy care split leather. Practical for families with children. 180x88, H66cm. Fräsigt red. 600.831.77



KARLSTAD 3-seat sofa €699

Soft, hard wearing and easy care leather, which ages gracefully. 206x93, H80cm. Grann dark brown. 101.265.65



KARLSTAD chaise longue €599

Soft, hard wearing and easy care leather. 78x158, H80cm. Grann white. 801.390.84



KRAMFORS sofa €1198 Seat surfaces and armrests in heavy, hard wearing, easy care grain leather. Practical for families with children. Designer: Mia Gammelgaard. 260x97/160, H74cm. Marig dark brown. 598.600.88

KRAMFORS 3-seat sofa

€799



KRAMFORS 3-seat sofa €799

Seat surfaces and armrests in heavy, hard wearing, easy care grain leather. Practical for families with children. Designer: Mia Gammelgaard. 223x97, H74cm. Marig beige. 101.558.50



ARILD 3-seat sofa €949

Seat surfaces and armrests in heavy, hard wearing, easy care grain leather. Back cushion is kept in place by a zipper. 207x94, H81cm. Karaktär bright white. 901.211.92



IKEA STOCKHOLM 3-seat sofa €1499

Heavy, easy care leather that ages gracefully. Combines with other products in the IKEA STOCKHOLM range. 212x89, H72cm. Elegant dark brown. 001.031.83



STOCKHOLM has a 25-year guarantee. Find out more on page 374.



ARILD and KARLSTAD have 10-year guarantees. Find out more on page 374.



SÄTER 2.5-seat sofa €279

SÄTER 2.5-seat sofa €279

Durable, easy care split leather. Practical for families with children. 197x82, H75cm. Fräsigt dark brown. 001.194.62



EKTORP PIXBO 3-seat sofa bed

€799

Sofa beds – Can a comfy sofa become a comfy bed?

The answer is yes. Keeping you comfortable 24/7 is our main priority, which is why some of our sofa beds come with a mattress choice. And since practical things matter as well, all of our sofa beds have either built-in storage or separately sold storage boxes. So whether the sofa bed is for you or for your guests, you can feel confident that total comfort will be the order of the day, or night.

EKTORP PIXBO 3-seat sofa bed €799

Clever hidden storage in the backrest. Removable cover: 100% cotton. 221x103, H99cm. Bed size: 160x198cm. Blekinge white. 598.494.57
ALVINE VACKER king-size quilt cover set €59.99/5pcs
 100% cotton. Quilt cover 240x220cm. 4 pillowcases 50x80cm. Multicolour. 501.596.53

Easy coordination

Like many of our sofa beds, EKTORP is part of a coordinated seating range.



1

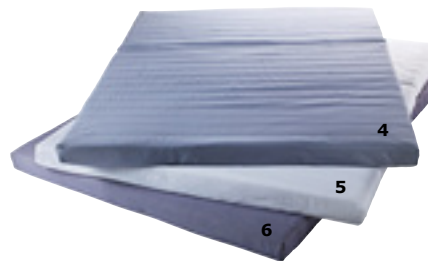

Small space

From handy chair beds to sofa beds that unfold in different ways, it's easy to find the one that fits your space.



2



7



Quick conversion

Fold down the backrest and to sleep you go! A sofa bed that's easy to convert helps you save time.



3



8



9

10

1. EKTORP LÖVÅS 3-seat sofa bed €869

Clever hidden storage in the backrest. Removable cover: 100% polyester. 221x103, H99cm. Bed size: 160x198cm. Idemo red. 698.629.92

2. LYCKSELE LÖVÅS 2-seat sofa bed €245

Readily converts into a bed big enough for two. Removable cover: 78.7% cotton, 20% polyester, 1.3% elastane/spandex. 142x100, H87cm. Bed size: 140x188cm. Henån blue. 398.400.15

3. IKEA PS LÖVÅS 2-seat sofa bed €375

Readily converts to a big bed for two. 2 cushions included. Removable cover: polyester fibres. 163x111, H86cm. Bed size: 160x205cm. Roma light beige. 398.301.39

4-6. Choose from 3 different mattresses

to create a combination that suits you.

4. PIXBO MURBO mattress €170

160x198cm. 10cm. thick. 101.296.20

5. PIXBO HÅVET mattress €230

Mattress filled with high resilience polyurethane foam with a top layer of latex. Follows the contours of your body and helps keep your backbone straight. 160x198cm. 10cm. thick. 901.296.16

6. PIXBO LÖVÅS mattress €130

160x198cm. 10cm. thick. 501.296.18

7. LYCKSELE LÖVÅS chair bed €179

Small and easy to position. Readily converts into a single bed. Removable cover: 78.7% cotton, 20% polyester, 1.3% elastane/spandex. 80x100, H87cm. Bed size: 80x188cm. Henån blue. 198.399.99

8. IKEA PS storage case 2-seat sofa bed €59

The storage box can be placed under the sofa bed for bed linen, etc. Plastic and polyester. 104x71, H12cm. Grey. 201.403.49

9. LYCKSELE storage case for 2-seat sofa bed €30

The storage box can be placed under the sofa bed for bedlinen, etc. 96x55, H20.5cm. Black. 601.169.60

10. LYCKSELE storage case chairbed €15

The storage box can be placed under the armchair bed for bedlinen, etc. Plastic and polyester. 47x55, H20.5cm. Black. 401.169.61

BEDDINGE LÖVÅS
3-seat sofa bed

€378



BEDDINGE - The sofa bed that takes itself seriously

Some people think a sofa bed is a bit of a compromise on comfort. Not us. BEDDINGE guarantees you total relaxation, and an easy life. You get to personalise it with your own choice of four mattress options. And with removable, washable covers, plus a bedlinen box underneath, you've literally got it made, 24/7.

BEDDINGE LÖVÅS
3-seat sofa bed

€279

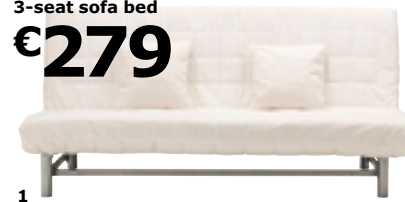

1



2

BEDDINGE LÖVÅS
3-seat sofa bed

€319

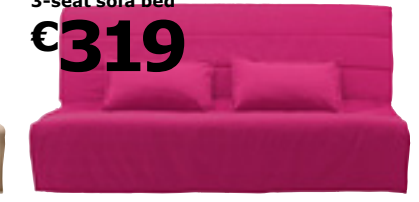

3



4



5

EXARBY
3-seat sofa bed

€160



6



7



9



8

9

10

11

12

BEDDINGE LÖVÅS range

Removable cover. 2 cushions included.

LEFT PAGE:

3-seat sofa bed €378

Cover: 70% cotton, 30% viscose/rayon. 200x104, H91cm. Bed size: 140x200cm. Sandvik green. 998.399.00

BEDDINGE cushion €29.99 Support your arms. Sandvik green. 598.398.84

THIS PAGE:

1. 3-seat sofa bed €279

Ransta white. 298.588.88

2. 3-seat sofa bed €378

Sandvik beige. 598.483.36

3. 3-seat sofa bed €319

Laxbro cerise. 498.600.98

4. 3-seat sofa bed €319

Laxbro red. 498.398.70

5. 3-seat sofa bed €378

Sandvik brown. 798.399.01

6. EXARBY 3-seat sofa bed €160

Fixed cover: 100% cotton. 185x85, H83cm. Bed size: 120x185cm. Almås natural. 698.249.57

7. BEDDINGE storage box €24.90

Foil finish. 165x69, H16cm. Silver colour. 100.367.20

8. SUVERÄN mattress pad €55

Washable mattress pad. Keeps your sofa bed fresh for longer. 140x200cm. 2cm. thick. 101.199.42

9-12. Mattress size 140x200, 12cm. thick.

9. BEDDINGE RESMO mattress €230

Pocket springs provide support for your body where needed, relieve pressure on your shoulders and hips and help keep

your backbone straight. 301.035.82

10. BEDDINGE MURBO mattress €130

Polyurethane foam mattress with a top layer of high resilience polyurethane foam that follows the contours of your body and helps keep your backbone straight. 701.020.57

11. BEDDINGE HÅVET mattress €200

Mattress filled with high resilience polyurethane foam with a top layer of latex. Follows the contours of your body and helps keep your backbone straight. 901.020.56

12. BEDDINGE LÖVÅS mattress €110

A simple, firm polyurethane foam mattress for use every night. 501.020.58

 See all BEDDINGE designs, sizes and colours at [IKEA.IE/BEDDINGE](https://www.ikea.ie/BEDDINGE)



EKTORP corner sofa bed combination €1130
Pull-out box for storing bed linen, etc.
Removable cover: 100% cotton.
243/243x88, H88cm. Bed size: 144x200cm. Idemo beige. 298.128.00



EKTORP LÖVÅS 3-seat sofa bed €869
Readily converts into a roomy bed for two.
Removable cover: 100% cotton.
221x103, H99cm. Bed size: 160x198cm.
Idemo red. 698.629.92



KARLSTAD 3-seat sofa bed with storage €779
Storage space under the seat for pillows and quilts for two.
Removable cover: 86% cotton, 14% polyester. 226x93, H83cm. Bed size: 140x200cm. Korndal green. 698.403.11



MÅNSTAD corner sofa bed combination €649
Extra storage space in the end section for bedlinen etc. Fixed cover: 100% cotton.
240x90/155, H73cm. Bed size: 140x204cm. Gobo dark grey. 401.260.93



ÄLVROS 3-seat sofa bed €1119
Fixed cover: Leather. 208x98, H92cm.
Bed size: 133x180cm.
Mjuk light beige. 301.554.44



TYLÖSAND 3-seat sofa bed with storage €929
Removable cover: 55% cotton, 41% rayon.
240x91, H76cm. Bed size: 140x200cm.
Everöd red-brown. 898.628.87



LILLBERG 3-seat sofa bed with storage €299
Storage concealed under the seat.
Removable cover: 100% cotton.
207x97, H88cm. Bed size: 120x200cm.
Birch/Gräsbo white. 698.398.50



SOLSTA 2-seat sofa bed €149.99
Readily converts into a bed.
Fixed cover: 100% cotton.
137x78, H72cm.
Bed size: 118x205cm.
Ransta dark grey. 900.871.07

Wait, there's more! If the one you want isn't here, you'll find it in the store or at IKEA.IE/SOFABEDS

Why pay more?

Good quality, function and low price



€379

HAGALUND 2-seat sofa bed
Removable cover: 100% cotton.
150x86, H91cm. Bed size: 120x196cm.
Blekinge white. 698.437.48



LACK side tables

€8.99 /ea



LACK side tables €8.99/ea

Printed and embossed finish. 55x55, H45cm. Birch effect. 401.042.70
Walnut effect. 201.530.73 Oak effect. 601.113.40 Black-brown. 801.042.68



RAMVIK coffee table €89

Top in tempered glass protects the wooden panel from stains. Two people are required to assembly. Ash veneer. 120x58, H40cm. Black-brown/glass. 101.037.19



STRIND side table €69

Table top and shelf in tempered glass. Frame in nickel-plated, lacquered steel. Ø50, H62cm. White/nickel-plated. 201.571.08



SMÅDAL coffee table

€49.90

SMÅDAL coffee table €49.90

Separate shelves for storing magazines, etc. help to keep your table top stylishly clear. Foil finish. 87.5x56.5, H43cm. White. 501.417.76



EXPEDIT coffee table €49.90

Top in tempered glass protects the wooden panel from stains. Frame in printed and embossed finish. 78x78, H38cm. Glass/walnut effect. 001.477.33



KLUBBO coffee table €79

Table top in painted ash veneer. Legs in chrome-plated steel. 118x59, H27cm. Black-brown. 801.350.19



LIATORP coffee table €199

Practical storage space underneath the table top. Table top in tempered glass. Frame in painted finish. 93x93, H51cm. White/glass. 500.870.72



VEJMON coffee table €139

Separate shelf for storing magazines etc, helps to keep your table top stylishly clear. Birch veneer. 140x66, H47cm. 501.366.71



LACK coffee table €19.99

Separate shelf for storing magazines etc, to keeps your things organised and the table top clear. Combines with other products in the LACK range. Printed and embossed finish. 90x55, H45cm. Black-brown. 401.042.94



KLUBBO 2-piece table set €69

Slot together to save space. Table tops in painted finish. Legs in chrome-plated steel. 50x50, H47cm. White. 101.350.27



MARKÖR coffee table €129

2 drawers in the table underframe, suitable for storing remote controls etc. Stained solid pine. 90x90, H52cm. Dark brown. 201.157.88



LILLBERG coffee table

€69

LILLBERG coffee table €69

Solid birch. Designer: Nike Karlsson. 120x69, H43cm. 801.537.96



LACK coffee table

€29.90

LACK coffee table €29.90

Separate shelf for storing magazines etc, to keeps your things organised and the table top clear. Combines with other products in the LACK range. Printed and embossed finish. 118x78, H45cm. Birch effect. 201.042.90



KLUBBO coffee table €59

Table top in tinted lacquered ash veneer. Legs in chrome-plated steel. 78x78, H37cm. 401.350.21



KLINGSBO coffee table €65

Table top in tempered glass. Frame in powder-coated steel. 116x78, H49cm. Black/clear glass. 901.285.65



EXPEDIT coffee table €59

Top in tempered glass protects the wooden panel from stains. Tempered glass. 118x59, H38cm. 501.529.44



LACK side table

€5.99

LACK side table €5.99

Easy to assemble. Coordinates with other products in the LACK range. Painted and foil finish. 55x55, H45cm. Light blue. 601.513.12



BESTÅ/FRAMSTÅ
TV/storage combination
€467

BESTÅ/FRAMSTÅ Gives your TV a custom-made home. And then some.

Do you want to show off your state-of-the-art TV? Or to be able to put it out of sight sometimes? It's your choice. And what about the rest of your proud possessions? With BESTÅ storage and FRAMSTÅ panels, you can build the perfect solution to store not only your TV, but also your DVDs, posh sound system, umpteen CDs, books, favourite photos, prized ornaments.... Need we go on?



BESTÅ/FRAMSTÅ/INREDA has a 10-year guarantee. Find out more on page 374.



BESTÅ storage combination
€182

BESTÅ storage combination
€272

- BESTÅ system** Frames in different sizes. Allows you to create a solution to suit the size of your TV.
- BESTÅ/FRAMSTÅ TV/storage combination €467** Foil finish and tempered glass. 240×40, H166cm. Black-brown. 498.629.74
- 1. BESTÅ TV/storage combination €534** Foil finish and tempered glass. 240×40, H192cm. Black-brown. 498.655.81
- 2. BESTÅ TV/storage combination €618** Foil finish and tempered glass. 240×40, H192cm. White/high-gloss white. 198.629.75
- 3. BESTÅ storage combination on legs €443** Price including wall cabinet. Foil finish.

- Storage unit on legs: 240×49, H36cm. White/high-gloss black. 298.620.55
- 4. BESTÅ storage combination €640** Foil finish, tempered glass and powder-coated steel. 240×40, H256cm. Ash effect. 098.621.55
- 5. BESTÅ/FRAMSTÅ TV/storage combination €182** The panel is hollow, to hide your cables inside. Foil finish. 120×40, H134cm. White. 898.627.12
- 6. BESTÅ/FRAMSTÅ storage combination €979** Foil finish and tempered glass. 360×49, H154cm. Black-brown/high-gloss brown. 698.629.73
- 7. BESTÅ storage combination €272** BESTÅ underframe makes it easier to keep

- the surface under your storage clean. Foil finish, tempered glass and chrome-plated steel. 240×40, H48cm. Ash effect. 498.621.63
- 8. BESTÅ/INREDA TV/storage combination with sliding doors €390** Sliding doors save space when open, and hide the TV when you are not tuning in. Foil finish. 240×40, H128cm. Ash effect. 998.621.46
- 9. BESTÅ TV/storage combination €564** Foil finish. 240×40, H192cm. White/high-gloss red. 698.660.23
- i* BESTÅ/FRAMSTÅ buying guide on page 348. And so much more at IKEA.IE/BESTA

INREDA - The inside story of BESTÅ

INREDA interior organisers

1. Extra shelves €6/ea

Tempered glass. Max. load 10kg. 56×36cm. 301.034.74

2. Wine racks €6/ea

Can be placed flat or tilted, change to suit your needs. Plastic. 56×35cm. Max. load 10kg. Smoked. 401.339.51

3. Tray €7

Plastic. Max. load 10kg. 52×35cm. Smoked. 001.339.53

4. Magazine shelves €6/ea

Bent front edge keeps newspapers and magazines in place. Powder-coated steel. Max. load 4kg. 56×44cm. 401.050.24

5. Pull-out frames €30/ea

Pull out fully for easy overview and access to the contents. To be completed with SUMMERA drop files, INREDA shelf insert or INREDA storage with compartments. Anodised aluminium. 53×36cm. 501.444.97

Insert with 4 compartments €8

Grey. 101.167.74

6. Drawers €20/ea

Smooth running drawer with stop keeping it in place. Foil finish and tempered glass. 60×40, H16cm. Silver colour. 701.050.27

7. Cabinet lighting €39.99/ea

Plastic. Max. 13W. L56cm. White. 701.157.76

8. Fully-extending drawers €35/ea

To be completed with BESTÅ drawer front. Foil finish. 60×40cm. Dark grey. 201.175.65

9. Ladder €30 The ladder can only be rested on the top panel. Powder-coated steel. 39×220cm. 001.044.65

10. GRUNDTAL spotlights

€17.99/3pk See page 330

11. Cabinet lights €16.99/ea

Adjustable shade. Steel/Aluminium. Silver colour. 001.193.82



1
INREDA
wine racks
€6/ea

4
INREDA
magazine shelves
€6/ea

10

7
INREDA
cabinet lighting
€39.99/ea

5

6

INREDA drawers
€20/ea

8
INREDA fully-extending
drawers
€35/ea

11

9

Find the ideal storage for your TV



**BESTÅ/FRAMSTÅ
TV/storage combination**
€256

BESTÅ/FRAMSTÅ TV/storage combination C256
When FRAMSTÅ panel is hung on the wall, max. 4 panels can be used, vertically. When FRAMSTÅ panel stands on the floor, or on a shelf unit from BESTÅ system, max. 8 panels can be used, vertically. FRAMSTÅ panel must always be attached to the wall. Foil finish. 120×49, H154cm. White. 198.627.20



BESTÅ/FRAMSTÅ TV/storage combination C838 Choose between open or closed storage, to display or put away your possessions as you wish. Foil finish and tempered glass. 300×40, H230cm. Ash effect. 998.641.45



FRAMSTÅ TV panel C189
This furniture must be fixed to the wall with the wall fastener included. Foil finish and tempered glass. 120×160cm. White/glass. 398.669.63



LIATORP storage/TV bench C1117
Four doors in tempered glass keep your favourite items dust free, but still visible. Painted finish. 337×49, H214cm. White. 798.424.37



STIBY TV/storage combination C889
Particleboard, ash veneer, tinted acrylic. 312×52, H220cm. Ash veneer/glass white. 298.587.70



TRÄBY TV/storage combination C689
Ash veneer and tempered glass. Designer: Tord Björklund. 286×40, H170cm. 498.627.28



MAVAS entertainment centre
€59

MAVAS entertainment centre C59
Room for a TV, DVD player and other media equipment. Create your own complete entertainment center. Foil finish. Max. load 45kg. 150×25/36, H150cm. White. 701.406.34



FRIEL TV panel with sliding door C165
A sliding door saves space, and lets you show off your swanky screen, or tuck it away, as you like. Painted finish. Designer: Ehlén Johansson. 198×25, H72cm. White. 701.161.15



LILLBERG TV bench C89
Solid wood, a durable natural material. Solid birch. Designer: Nike Karlsson. 180×40, H43cm. 901.537.91



BESTÅ TV/storage combination
€351

BESTÅ TV/storage combination C351
BESTÅ legs make it easier to keep the surface under your storage clean. Foil finish. 240×40/49, H164cm. Black-brown. 698.629.87



BESTÅ BURS TV/storage combination C369
Melamine foil finish. Unit on legs: 180×40, H48cm. White. 698.504.56



BESTÅ BOÅS TV storage unit C150
Foil finish and tempered glass. Max. load 50kg. 120×40, H128cm. White. 101.447.34



BESTÅ ÄDAL TV bench
€99

BESTÅ ÄDAL TV bench C99
Smooth running drawer with stop, keeping it in place. Foil finish. Designer: Mikael Warnhammar. Max. load 65kg. 120×40, H55cm. Black-brown. 801.447.40



LEKSVIK TV bench C159
A remote control will work through the glass; adjust your volume with the door closed. Stained solid pine and tempered glass. Max. load 60kg. 95×62, H75cm. 000.338.64



MOSJÖ TV bench
€29.90

MOSJÖ TV bench C29.90
1 adjustable shelf; adjust spacing according to your own needs. Foil finish. Max. load 45kg. 90×40, H38cm. Black-brown. 901.447.30

BENNO TV bench with panel
€99



BENNO TV bench with panel €99
 Reinforced back panel for a flat screen TV. No need to drill holes in the wall. Cables can be hidden at the back. Only for flat screen TV. Foil finish. Max. load 50kg. 120x40, H134cm. White. 901.339.39



BENNO TV bench on castors €55
 Castors included for easy mobility. Only for flat screen TV. Birch veneer. Max. load 30kg. 118x38/42, H51cm. 301.044.78

LACK TV bench
€49.90



LACK TV bench €49.90
 Open back makes organising cables easy. Printed and embossed finish. Max. load 65kg. 149x55, H35cm. Black-brown. 201.053.41



SVIND TV bench €119
 Rotates 360 degrees. Powder-coated steel, aluminium and tempered glass. Max. load 65kg. 94x55, H48cm. Glass/silver colour. 801.135.45

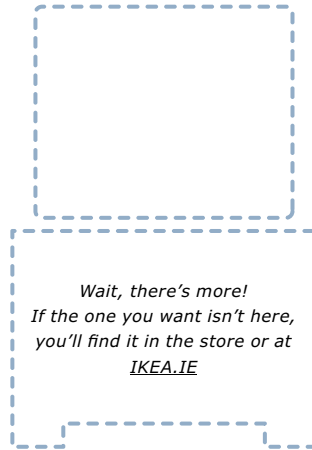

*Wait, there's more!
 If the one you want isn't here,
 you'll find it in the store or at
IKEA.IE*

GREVBÄCK TV bench
€39.90



GREVBÄCK TV bench €39.90
 Drawer with stop for increased safety. Foil finish. Max. load 60kg. 93x50, H57cm. Antique effect. 701.044.38



MARKÖR TV bench €229
 Stained and tinted solid spruce and tempered glass. Max. load 100kg. 138x53, H72cm. Dark brown. 201.025.16



LIATORP TV bench €199
 Smooth running drawers with drawer stop. Cable outlet at the back keeps cables in place. Painted finish. Max. load 100kg. 145x49, H45cm. White. 801.166.00

SMÅDAL TV bench
€49.90



SMÅDAL TV bench €49.90
 2 adjustable shelves. Adjust spacing according to need. Particleboard, foil. Max. load 50kg. 117x40, H37.5cm. White. 801.417.70

Why pay more?
 Good quality, function and low price



Designed by:
 Jon Karlsson

€59

MAVAS entertainment centre
 Foil finish. 150x25/36, H150cm. Max. load 45kg. Black-brown. 401.406.35. White. 701.406.34

Also available in:



White





BENNO
DVD tower, white
€18.99

BILLY book/
magazine rails
€7/ea

BILLY/BENNO/BERGSBO - For organised entertainment

Make leisure time more enjoyable by being able to find the things you love, fast. BILLY, the choice of book lovers for over 30 years, helps you create a personal library, while BERGSBO will showcase coffee-table books and other collectables. Complement these with BENNO for the perfect home for your TV, CDs and DVDs.



BENNO DVD
tower, white
€18.99

BILLY
bookcase
€39

BILLY bookcase
€49

FLÄRKE
bookcase
€19.99

LEFT PAGE:

BERGSBO bookcase with glass doors €249 Adjustable shelves. Adapt the spaces between shelves to suit your book sizes. Foil finish. 120×40, H202cm. White. 901.366.88
BILLY bookcase €25 Foil finish. 40×28, H202cm. White. 400.857.14
BILLY book/magazine rails €7/ea Anodised aluminium. W36cm. 901.463.43
BENNO DVD tower €18.99 See no. 1.
BILLY bookcases €39.90/ea See no. 3.
BILLY book/magazine rails €10/ea W76cm. 701.463.44

THIS PAGE:

1. BENNO DVD tower Holds 180 CDs or 88 DVDs or 40 video cassettes. 20×17, H202cm. **€18.99** White. 073.053.10
€35 Birch veneer. 873.052.07
2. BERGSBO bookcase with glass doors €249 Foil finish. Doors in tempered glass. 120×40, H202cm. Red. 101.366.87
3. BILLY bookcase €39 Adjustable shelves. Adapt spaces between shelves to suit your books. Foil finish. 80×28, H202cm. White. 836.882.10
4. BILLY bookcase €39 Foil finish. 80×28, H202cm. Blue. 801.473.38

5. BILLY bookcase €49

Narrow shelves help you to use small wall spaces effectively, accommodating small items in a minimum of space. Oak veneer. 40×28, H202cm. 600.857.13
6. BILLY/BILLY BYOM bookcase with glass doors €183 Birch veneer. 160×28, H106cm. 598.507.44
7. BILLY bookcase corner combination €288 Foil finish. 78/118×28, H237cm. White. 798.641.27
8. FLÄRKE bookcase €19.99 Foil finish. 59×25, H171cm. Birch effect. 500.817.44

i **BILLY buying guide on page 350.**
 And so much more at
IKEA.IE/BILLY

Mix it. Match it. Play around a bit...
Whoever thought storage could be
such fun?

- 1. EXPEDIT bookcase €69**
Painted and foil finish.
79×39, H149cm. White. 701.030.85
- 2. EXPEDIT 2-drawer insert €30**
Foil finish. 33×37, H33cm.
Black. 201.569.48
- 3. LACK wall shelves €4.99/ea**
Painted finish. 30×26cm, H5cm.
Black. 701.036.22 Red. 901.036.21
- 4. LACK side tables €5.99/ea**
Painted and foil finish. 55×55, H45cm.

- Light blue. 601.513.12 Red. 701.042.64
Yellow. 801.513.11
- 5. LACK shelving unit €69**
Painted finish. Max. load 50kg.
35×38, H190cm. Black. 201.531.72
- 6-9. EXPEDIT range**
Painted and foil finish.
- 6. Bookcase €99**
149×39, H149cm. White. 400.476.75
- 7. Inserts with doors €17/ea**

- 33×37, H33cm. Red. 901.157.56
- 8. Shelving unit €89**
89×39, H149cm. White. 501.477.35
- 9. Coffee table €59**
Printed and embossed finish. Table top
in tempered glass. 118×59, H38cm.
Glass/walnut effect. 001.477.28
- 10. LACK bookcase €95**
Painted finish. 105×38, H190cm.
Black. 001.531.54

1

5

LACK wall shelves
€4.99 /ea

2

4 4

LACK side tables
€5.99 /ea

4

6

7

8

9

EXPEDIT
coffee table
€59

10

LACK... our most colourful language



LACK range

Painted, printed and embossed or foil finish.

1. Bookcases €95/ea

105x38, H190cm. White. 801.036.26
Light blue. 401.513.08

2. Shelving units €69/ea

Can be placed vertically or horizontally, for use as a shelf or a bench. Max. load 50kg. 35x38, H190cm. Black. 201.531.72
Red. 401.056.27

3. Wall shelves €10.99/ea

Different wall materials require different types of fixing device. 110x26cm.
White. 500.110.15 Light blue. 001.513.10
Red. 901.036.35 Birch effect. 601.036.32
Walnut effect. 001.530.74

Black. 100.110.17

Also available:

Wall shelves €19.99/ea

190x26cm. Birch effect. 601.037.50
Black-brown. 401.037.51

White. 000.110.13

Walnut effect. 701.530.75

4. Wall shelves €4.99/ea

30x26cm. White. 501.036.18
Red. 901.036.21 Black. 701.036.22

5. Wall shelves €19.99/ea

Max. load 15kg. 130x26cm.
White. 501.036.23 Red. 201.056.28
Black. 001.056.29

6. Side tables €5.99/ea

Easy to assemble. 55x55, H45cm.
Light blue. 601.513.12 White. 200.114.13

Red. 701.042.64 Black. 200.114.08

7. Coffee table €19.99

90x55, H45cm. Birch effect. 101.042.95

8. Coffee table €29.90

118x78, H45cm. Walnut effect. 601.530.71

9. TV bench €49.90

Open back makes cable organising cables easy. Max. load 65kg. 149x55, H35cm.

Walnut effect. 101.531.58

EXPEDIT... the truly great divide



EXPEDIT range.

Painted, printed and embossed or foil finish.

1. Bookcase €69

Fittings for wall fastening included. Can also be used as a room divider.

Max. load/shelf 13kg. 79x39, H149cm.

2. Shelving unit €49.90

Can be hung on the wall or placed on the floor. Choose the way that best suits your needs. Max. load/shelf 13kg.

79x39, H79cm. White. 201.353.00

3. Shelving unit €89

Fittings for wall fastening included. Can also be used as a room divider. 89x39, H149cm. Walnut effect. 301.529.16

4. Bookcase €99

Fittings for wall fastening included. Can also be used as a room divider.

Max. load/shelf 13kg. 149x39, H149cm.

2-drawer inserts €30/ea

Back of insert in the same colour as the drawers. Looks great from both directions as a room divider. 33x37, H33cm.

Red. 101.157.60

5. Shelving unit €59

Can be placed vertically or horizontally, for use as a shelf or a bench.

Max. load/shelf 13kg. 44x39, H185cm.

Walnut effect. 901.530.79

6. Bookcase €159

Fittings for wall fastening included.

Can also be used as a room divider.

Max. load/shelf 13kg. 185x39, H185cm.

Inserts with doors €17/ea

Back of insert in the same colour as the door. Looks good from both directions in a room divider. 33x37, H33cm.

White. 401.665.69

7. TV storage unit €159

Reinforced back panel for a flat screen TV. No need to drill holes in the wall and cords can be hidden at the back.

Max. load/shelf 13kg. 185x39, H185cm.

Black-brown. 101.030.93



LIATORP sideboard

€249

LIATORP - Handcrafted looks on an everyday budget



LIATORP range

Painted finish. Tempered glass. White.

1. Storage combination €907 Cornice and plinth rail help create a uniform expression when two or more units are connected together. 288x34, H214cm. 398.504.10

2. Bookcase with doors €334 96x34, H214cm. 998.424.36

3. Sideboard €249 Cable outlet at the back keeps cables in place. Max. load 100kg. 145x48, H87cm. 801.165.96

4. Sofa bench €149 133x37, H75cm. 001.050.64

5. Desk €299 Adjustable shelf in the cabinet provides space for a computer; adjust according to need. 145x65, H73cm. 301.036.76



LEKSVIK storage/TV bench

€139

LEKSVIK - Takes tradition into the 21st century



LEKSVIK range Stained solid pine.

1. Bookcase with doors €129 93x32, H198cm. Max. load 100kg. 401.035.05

2. Bookcase €139 100x32, H233cm. Antique stain. 001.151.81

3. TV bench €159 Lockable doors for safe keeping of special possessions. A remote control will work through the glass; adjust the volume with the door closed. Cable outlet at the back keeps

cables in place. Max. load 60kg. 95x62, H75cm. Antique stain. 000.338.64

4. Storage/TV bench €139 Can also be used as a utility bench in the bedroom or hall. Max. load 100kg. 191x45, H47cm. Black. 501.151.88

5. Desk €129 119x60, H74cm. Black. 801.334.02



MARKÖR TV bench
€229

MARKÖR – Naturally sturdy



MARKÖR range
 Stained, tinted solid spruce. Dark brown.
1. Bookcase €269 151×36, H192cm. 101.058.55
2. Bookcase €119 50×34, H192cm. 700.990.26
 Also available: **€149** 89×34, H192cm. 500.990.27
3. TV bench €229 Doors in tempered glass.
 Max. load 100kg. 138×53, H72cm. 201.025.16

MARKÖR coffee table €129
4. Coffee table €129 90×90, H52cm. 201.157.88
5. Desk €199 135×63, H72cm. 201.040.49
6. Bookcase €229 Baskets sold separately.
 186×36, H86cm. 901.110.27

Why pay more?

Good quality, function and low price



€10.99 /ea

LACK wall shelves Painted finish or printed and embossed finish.
 110×26cm. Light blue. 001.513.10
 Black. 100.110.17 White. 500.110.15 Birch effect. 601.036.32
 Oak effect. 001.117.53 Yellow. 201.513.09 Red. 901.036.35
 Walnut effect. 001.530.74 Black-brown. 401.036.33

Design and Quality IKEA of Sweden



just add a favourite movie



ROFYLLD children's rocking chair
€34.99

ROFYLLD children's rocking chair €34.99
101.148.88



KAJSA RAND cushion covers
€10.99 /2pk

RITVA cushion cover €4.99
Cotton. 50x50cm.
Beige. 401.516.95

KAJSA RAND cushion covers €10.99/2pk
Cotton. 50x50cm. Grey. 001.516.78



VÄGHULT candelsticks €0.99/ea
Steel. H3.5cm. White. 801.593.12
Black. 001.593.11



FLÖRT remote control pocket
€9.49

FLÖRT remote control pocket
€9.49 Polyester. Black. 001.669.05



BLANDA MATT serving bowl
€7.99

BLANDA MATT serving bowl €7.99
Solid birch. Ø20, H9cm. 600.572.58



IKEA PS KARLJOHAN side table €59
Solid birch. Ø47, H27cm. 101.499.39



KAJSA VIRKA throw €26.99
Cotton. 130x170cm.
White/multicolour. 301.516.86



IKEA PS KRONA basket €16.99
Palm leaf. Designer: Maria Vinka.
Ø36, H24cm. 701.411.10



DIOD glasses €2.39/ea
Glass. Designer: Anne Nilsson. 25cl.
Brown. 201.498.06 White. 200.919.28



KASSETT DVD boxes with lids €5.49/2pk
21x26, H15cm. Black. 301.532.42



LAMPAN table lamp
€3.59

LAMPAN table lamp €3.59
An energy-saving 7W. bulb is suitable for use. Plastic. Max. 40W.
Shade Ø19, H29cm. Black. 300.961.00

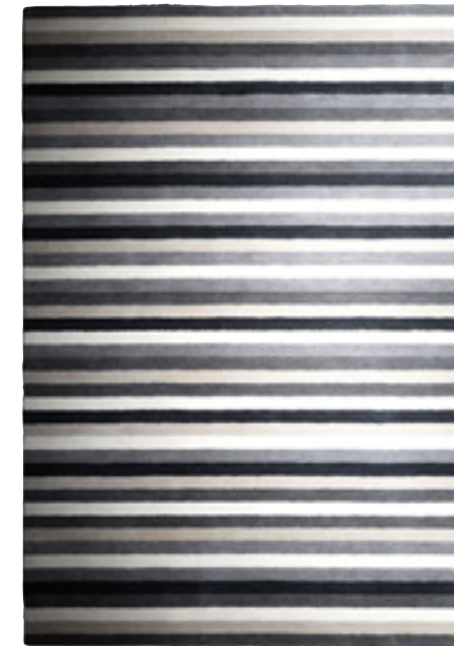

KAJSA rug €219
Wool/nylon. 230x230cm.
Multicolour. 601.520.19



LILLBERG rocking chair
€129

LILLBERG rocking chair €129
100% cotton. Solid birch.
68x94, H85cm. 098.398.05



STORNÅS range
Antique stained solid pine.
Designer: Carina Bengs.
Antique stain.
Table €299
Extendable dining table with
2 extra leaves, so you can
adjust the table size to
suit numbers. Seats 6-10.
201/247/293x105, H74cm.
601.523.40

Buffet €319
165x48, H90cm. 901.568.55
HENRIKSDAL chairs €80/ea
Gobo white/Brown-black.
398.478.18 See page 102
MAJBY armchairs €69/ea
Pad with filling. Armrests
and high back for enhanced
seating comfort. Clear lacquer
rattan. 46x63, H90cm.
Seat H45cm. 001.396.05

STORNÅS table
€299

Dining

Dinners and homework
and coffee for two.
For every day
and for all of you



DIODER multi-use lighting

€59 /4pk

TORSBY table

€119

Small and easy. Not cramped and squeezy

TORSBY table €119

Top in tempered glass, easy to clean. Chrome-plated steel. Designer: Carl Öjerstam. 85x85, H74cm. White. 898.648.10. More sizes on page 104.

BERNHARD chairs €129/ea

Padded seat and back for enhanced seating comfort. Leather and nickel-plated steel. Designer: Ola Wihlborg. 45x50, H77cm. Seat H48cm. Kavát white. 001.530.69. Kavát dark brown. 801.638.04

GILBERT stools €29/ea

Stackable, saving space when not in use. Painted birch veneer. Chrome-plated steel. Seat 33x33, H45cm. White. 601.379.10

BESTÅ storage combinations €40/ea

Foil finish. 60x40, H30cm. Black-brown. 498.707.47

DIODER multi-use lighting €59/4pk

You can shift automatically between 7 different colours or select 1 at a time. Polycarbonate plastic. Ø5.5cm. Multicolour. 001.199.33

HOVEN rug €29.99

Heat-set polypropylene. Makes the rug extra nice and soft to walk on. Machine-tufted. 100% polypropylene. 133x195cm. Blue. 401.316.12

IKEA 365+ LUNTA pendant lamp €39.99

Powder-coated steel. Max. 100W. Ø20cm. White. 101.384.22

SARALISA fabric €5.99/m

100% cotton. W150cm. White. 101.539.74



With two regular sized dining tables instead of one big one, you get a more flexible dining area. You can use each table separately to accommodate different activities, like sewing or playing, then combine them to seat everyone for a family meal.

MELLTORP dining tables €39/ea

Melamine foil. Powder-coated steel. 125x75, H74cm. White. 998.499.75

More sizes on page 105.

HERMAN chairs €14.99/ea

Plastic. Powder-coated steel. 45x50, H78cm. Seat H44cm. White. 701.559.65

Yellow. 501.559.66

MELLTORP occasional table €49

Powder-coated steel. Melamine foil finish. Designer: Lisa Norinder. 95x38, H90cm. White. 998.581.49

ANTILOP high chair with safety belt €13.99

Easy to disassemble and take with you when visiting homes without one of their own.

Plastic. Powder-coated steel. 58x62, H90cm. Seat H55cm. White/silver colour. 000.697.25

MELODI pendant lamps €6.99/ea

Light source is sold separately. Plastic. Max. 75W. Shade Ø28cm. 000.379.80

LACK range

Concealed mounting fittings: the shelf becomes part of the wall. Painted finish.

Wall shelf €4.99

Max. load 3kg. 30x26cm. White. 501.036.18

Wall shelf €19.99

Max. load 8-20kg. 190x26cm. White. 000.110.13

LIDAN baskets €8.99/2pk

Handmade. 100% polypropylene. White. 900.812.90

MELLTORP dining tables

€39/ea



HERMAN chairs

€14.99/ea





Reach in and everything's right there. With drawers that open from both sides, the **NORDEN occasional table** gives you easy access to napkins, candles and that extra place setting for an unexpected guest.

NORDEN range

Designer: Mikael Warnhammar.

Dining table €199

Solid birch. 150/205x90, H74cm. 301.168.72

Occasional table €179

Solid birch. 188x42, H90cm. 600.453.93

Glass-door cabinet €319

3 adjustable glass shelves.

Arrange spacing according to your own storage needs.

Tempered glass.

Tinted, lacquered solid birch.

104x42, H190cm.

Black. 401.168.76

NORDMYRA chairs €39/ea

Stackable, saving space when not in use. Painted finish and solid birch. 47x48, H78cm.

Seat H45cm. White. 100.876.44

TRYGG serving bowls €2.59/ea

Ø28cm. 201.324.53

STYCKE shades €24.99/ea

Different colours and motifs, giving the option to coordinate.

Light source is sold separately. 100% cotton. Designer:

Clive Tompsett. Ø34, H34cm.

Assorted designs. 401.594.94

HEMMA cord sets €2.99/ea

L180cm. 000.678.54

GRUNTAL rails €8.99/ea

Stainless steel.

L120cm. 500.227.64

STYCKE/HEMMA pendant lamps

€27.98 /ea

NORDEN occasional table

€179





LYCKHEM dining table

€129

LYCKHEM range

Painted solid beech. White.
Dining table €129
 Extendable with 1 leaf. Seats 4-8.
 150/200x85, H74cm. 201.379.07
Occasional table €99
 129x41, H90cm. 401.379.06
LANNI chairs €59/ea
 Painted solid rubberwood.
 43x51, H88cm. Seat H44cm.
 White. 300.722.03
LENDA chair pads €3.99/ea
 100% cotton. 42x40cm.
 Beige. 300.998.58

EDEFORS
 dining table
€299



EDEFORS dining table €299

Extendable with 1 extra leaf. Makes it possible to adjust the table size according to numbers. Seats 6-8. Oiled solid oak. 180/228x100, H75cm. 301.013.33

EGON chairs €75/ea

Solid oak. 44x53, H88cm. Seat H45cm. Dark grey. 000.713.80

BJURSTA glass-door cabinet €249

4 adjustable glass shelves. Arrange spacing to suit your storage needs. Oak veneer. 80x40, H190cm. 101.191.69

NORRSTEN
 dining table

€149



NORRSTEN dining table €149

Seats 4. Tempered glass and powder-coated aluminium. 110x110, H74cm. Black. 801.317.33

TOBIAS chairs €79/ea Plastic and powder-coated steel. 55x56, H82cm. Seat H44cm. Black. 701.463.01

NORRSTEN cabinet €379

2 drawers included. This furniture must be fixed to the wall with the wall fastener included. Foil finish and aluminium. 140x42, H127cm. White. 801.356.65



JÄMSUNDA dining table €349

Seats 6. Stained oak veneer. 221x90, H74cm. Brown. 101.466.86

NANDOR chairs €39/ea

Powder-coated steel and unbleached paper. 46x62, H88cm. Seat H45cm. Brown-black. 901.557.90

JÄMSUNDA sideboard €349

2 adjustable glass shelves. Arrange spacing according to your own storage needs. Stained oak veneer. 160x40, H78cm. Brown. 001.168.64



NISSE folding chairs
€11.99 /ea

NORDEN gateleg table
€179

Great ideas make
 small spaces brilliant

LEFT PAGE:
NORDEN gateleg table €179
 Table with drop-leaves makes it possible to adjust size to suit numbers. Seats 2-4. Solid birch. 26/89/152x80, H74cm. 201.047.18

NISSE folding chairs €11.99/ea
 Folds flat to save space when not in use. Powder-coated steel. 45x47, H76cm. Seat H45cm. Black. 301.150.66



GLENN bar stools
€59/ea

BENJAMIN stools €19.99/ea
 Stackable, saving space when not in use. Birch veneer. Seat 37x35, H45cm. 300.450.16

THIS PAGE:
UTBY bar table €119
 Adjustable legs. Stands steady whether on even and uneven surfaces. Seats 4. Stained ash veneer/stainless steel. 120x60, H90cm. Brown-black. 098.434.59

GLENN bar stools €59/ea
 Stackable, saves space when not in use. Suitable for bar height 90cm. Plastic. Chrome-plated steel. 50x48, H89cm. Seat H63cm. White. 601.317.34

JANSJÖ table lamp €19.99
 Includes light diode. Has 50 times longer life than an incandescent bulb, consumes less energy and never has to be replaced. Diode life approx. 50,000 hours. Painted steel. H60cm. Silver colour. 201.287.38



BJURSTA dining table

€199

BJURSTA - Fits you and yours. And everyone else's too...

There's room for every auntie, colleague and friend's brother's neighbour!
Because BJURSTA comes in many different sizes and finishes - and each of them has extra leaves that extend the table. So you can make yourself comfortable. And so can all the others.



Also available in:
Brown-black
Oak

BJURSTA dining table
€149

1

2

4

3

5

LEFT PAGE:
BJURSTA range
Stained ash veneer. Brown-black.
Dining table €199
175/218/260×95, H74cm. 701.162.62
Bench €89
158×36, H45cm. 001.527.34
Glass-door cabinet €249/ea
Tempered glass.
80×40, H190cm. 501.191.67
HENRIKSDAL chairs €80/ea
Machine washable cover: 100% cotton.
Stained solid oak. 51×58, H97cm.
Seat H47cm. Brown-black/gobo white.
398.478.18

THIS PAGE:
BJURSTA range Birch veneer, oak veneer or stained ash veneer.
1. Dining table €179
140/180/220×84, H74cm. Birch. 001.162.65
Oak. 801.162.66 Brown-black. 301.162.64
2. Dining table €109
50/70/90×90, H74cm. Birch. 901.168.45
Oak. 501.168.47 Brown-black. 701.168.46
3. Dining table €149
90/129/168×90, H74cm. Birch. 901.168.07
Oak. 101.168.11 Brown-black. 501.168.09
4. Dining table €199
175/218/260×95, H74cm. Birch. 901.162.61
Oak. 501.162.63 Brown-black. 701.162.62

5. Dining table €199
Ø115/166, H74cm. Birch. 401.167.77
Oak. 001.167.79 Brown-black. 201.167.78
HENRIKSDAL chairs €80/ea
Machine washable cover: 100% cotton.
Solid birch. 51×58, H97cm. Seat H47cm.
Gobo white. 898.050.24

See all BJURSTA pieces, sizes and colours at [IKEA.IE/BJURSTA](https://www.ikea.ie/BJURSTA)



NORDEN dining table C299
The extra leaf can be stored within easy reach under the table top. Painted solid birch. 220/266×100, H75cm. White. 301.168.86



NORDEN dining table C249
The extra leaf can be stored within easy reach under the table top. Solid birch. 220/266×100, H75cm. 101.497.98



NORDEN dining table C249
The extra leaf can be stored within easy reach under the table top. Solid birch. 150/205×90, H74cm. 501.168.71
€249 White. 201.228.97
€199 Birch. 301.168.72



BJURSTA dining table C149
Stained ash veneer. 90/129/168×90, H74cm. Brown-black. 501.168.09



LIATORP round pedestal table C219
The extra leaf can be stored within easy reach under the table top. Painted solid birch. Ø110/155, H74cm. White. 400.722.07



LEKSVIK dining table C249
The extra leaf can be stored within easy reach under the table top. Stained solid pine. Ø126/171, H74cm. 501.160.55



LEKSVIK table €199
Stained solid pine. Designer: Carina Bengs. 160/195/230×87, H74cm. Black. 401.527.27



LEKSVIK table C199
Stained solid pine. Designer: Carina Bengs. 160/195/230×87, H74cm. Antique stain. 801.527.25



MELLTORP dining table C69
Moisture and scratch-resistant finish that is easy to clean. Melamine foil finish. Powder-coated steel. 175×75, H74cm. White. 798.499.76



INGO dining table €35
Can be treated with oil, wax, lacquer or glazing paint for higher resistance and easy care. Combines with other products in the INGO range. Solid pine. 120×75, H73cm. 146.300.09



LEKSVIK drop-leaf table C129
Stained solid pine. 59/89/119×78, H74cm. Antique stain. 401.160.51
Black. 201.160.52

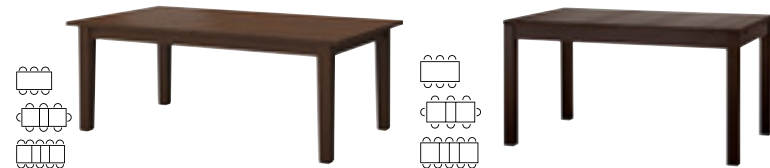

STORNÄS table C349
Stained solid pine. Designer: Carina Bengs. 201/247/293×105, H74cm. Dark brown. 401.523.41



BJURSTA dining table C199
The extra leaves can be stored under the table top. Stained ash veneer. 175/218/260×95, H74cm. Brown-black. 701.162.62



BJURSTA dining table C179
The extra leaves can be stored under the table top. Combines with other furniture in the BJURSTA range. Oak veneer. 140/180/220×84, H74cm. 801.162.66



NORDEN dining table C49
Combines with products in the BJÖRKUDDEN range. Solid birch. 74×74, H75cm. 100.591.65



LOKKA folding table C49
Table with fold-out top, makes it possible to adjust size to suit numbers. Seats 2-4. Fold-out top in painted finish. Powder-coated steel. 107×77/83, H73cm. White. 601.091.96



BJÖRKUDDEN bar table C89
Solid wood, a hard-wearing natural material. Bar stools with seat height 74cm. fit in well with this bar table. Solid birch. 70×70, H102cm. 900.875.41



TORSBY table C199
Tempered glass. Chrome-plated steel. Designer: Carl Öjerstam. 180×85, H74cm. White glass. 298.648.08
€169 Frosted glass. 498.648.07



TORSBY table C139
Tempered glass. Chrome-plated steel. Designer: Carl Öjerstam. 135×85, H74cm. Frosted glass. 898.648.05
€169 White glass. 698.648.06



GRIMLE dining table C199
Melamine foil finish. Moisture and scratch-resistant finish that is easy to clean. Chrome-plated steel. 180×100, H74cm. White. 901.385.93



NORBO wall-mounted drop-leaf table C29
Folds flat, saves space when not in use. Solid birch. 79×59cm. 800.917.13
Antique stain. 300.625.72



MUDDUS drop-leaf table C39
Melamine foil finish and powder-coated steel. Designer: Sandra Kragner. 48/92×60, H74cm. Yellow. 201.525.87
Black. 101.251.13 White. 101.600.74



MELLTORP dining table €29
Melamine foil. Powder-coated steel. 75×75, H74cm. White. 598.499.77



HENRIKSDAL bar stool with backrest €65
Machine washable cover: 100% cotton. Solid oak. 40x51, H102cm. Seat H74cm. Brown-black/gobo white. 898.623.64



HENRIKSDAL chair C99
Machine washable cover: 100% cotton. Solid oak. 51x58, H97cm. Seat H47cm. Blekinge white. 098.500.77

HARRY chair €35



HARRY chair C35
Machine washable cover: 100% cotton. Solid birch. 48x50, H96cm. Seat H47cm. Blekinge white. 401.058.30



HENRIKSDAL chair C99
75% cotton, 25% viscose/ rayon. Stained solid oak. 51x58, H97cm. Seat H47cm. Brown-black/sanne grey/black. 198.622.06



URBAN bar stool C99
Easy to adjust in height using one hand. Chrome-plated steel. Plastic. Designer: Carl Öjerstam. Seat Ø48, H55-74cm. White. 501.356.57



NILS stool C44
Machine washable cover: 100% cotton. Painted solid birch. Seat 34x34, H47cm. Black/Eslöv white/black. 798.503.85



INGOLF stool C29
Painted solid rubberwood. Designer: Carina Bengs. Seat 40x30, H45cm. White. 001.522.82

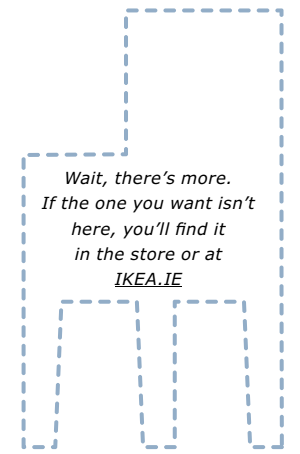

BÖRJE chair C49
Washable cover: 100% cotton. Solid birch. 44x55, H100cm. Seat H47cm. Gobo white. 501.162.01



INGOLF chair C49
Stained solid pine. 43x52, H91cm. Seat H44cm. 601.461.08
INGOLF chair pad C6
100% cotton. 45x56cm. Dark blue/white. 000.770.18



KAUSTBY chair C49
Stained solid pine. 44x48, H103cm. Seat H46cm. Dark brown. 001.100.51
KAUSTBY chair pad C6
100% cotton. 43x37cm. Blue. 601.639.23



STEFAN chair C15.99
Stained solid pine. 42x49, H90cm. Seat H45cm. Black. 700.338.70



GILBERT chair C39
Stackable, saving space when not in use. Stained oak veneer. 47x47, H85cm. Seat H43cm. Brown-black. 201.127.18



TOBIAS chair C79
Plastic/chrome-plated steel. 55x56, H82cm. Seat H44cm. Transparent. 201.150.38



URBAN chair C29
Stackable, saving space when not in use. Plastic. 52x51, H81cm. Seat H45cm. Red. 900.872.49



HERMAN chair C14.99
Stackable, saving space when not in use. Plastic/powder-coated steel. 45x50, H78cm. Seat H44cm. Black. 001.559.64



NILS chair with armrests C70
Machine washable cover: 100% cotton. Painted solid birch. 60x57, H80cm. Seat H47cm. Black/Blekinge white. 198.487.05



BERNHARD chair C89
100% cotton. Nickel-plated steel. 45x50, H77cm. Seat H48cm. Black. 701.376.84



ELIAS chair with armrests C59
Pad with filling and armrests for enhanced seating comfort. Steel and paper string. 100% cotton. 61x58, H83cm. Seat H45cm. Black. 501.396.03



NORVALD chair C49
Painted birch veneer and solid birch. 43x48, H83cm. Seat H45cm. Black. 701.150.45
NORVALD chair pad C10
76% wool, 24% nylon. 43x37cm. Black. 501.419.79



JEFF folding chair C7.99
Plastic. Galvanized steel. 42x49, H78cm. Seat H45cm. Black. 300.704.02



EDGAR folding chair C49
Birch veneer. Chrome-plated steel. 45x53, H83cm. Seat H46cm. 301.411.69



NISSE folding chair C25
Folds flat to save space when not in use. Plastic. Chrome-plated steel. 45x47, H76cm. Seat H45cm. High-gloss white. 101.150.67



EVERT stools C3.99/ea
Stackable, saving space when not in use. 100% plastic. Seat Ø24, H45cm. Green. 101.181.84 Black. 601.181.86 Yellow. 401.181.87

FUSION
table and 4 chairs

€299



FUSION table and 4 chairs €299
Stained ash veneer. Chrome-plated steel.
Table 84x84, H75cm. Chair 61x53, H76cm.
Seat H46cm. 900.925.52

MELLTORP/HERMAN
table and 2 chairs

€49*



MELLTORP/HERMAN table and 2 chairs €49*
Melamine foil. Plastic. Powder-coated steel. Table 75x75, H74cm.
Chair 45x50, H78cm. Seat H44cm. White/black. 398.644.07
*Save €9.98 compared to purchasing these items individually.

BJÖRKUDDEN/BERTIL
table and 4 chairs

€199*



BJÖRKUDDEN/BERTIL table and 4 chairs €199*
Solid birch. Table 119x74, H74cm.
Chair 39x49, H87cm. Seat H45cm. 298.437.88
*Save €16.00 compared to purchasing these items individually.

LAVER table
and 4 chairs

€89



LAVER table and 4 chairs €89
Top in tempered glass, easy to clean surface. Plastic.
Powder-coated steel. Table 110x76, H73cm. Chair 39x40, H77cm.
Seat H45cm. Silver colour/white. 501.528.16

Why pay more?

Good quality, function and low price



Designed by:
Carina Bengs

€99

JOKKMOKK table and 4 chairs
Stained solid pine. Table 118x74, H74cm.
Chair 41x47, H90cm. Seat H44cm.
Antique stain. 800.865.75



just add hungry guests



FÄRGRIK 18-piece service
€22.99

FÄRGRIK 18-piece service C22.99
201.455.73



IKEA PS KÄLLA glasses C4.79/3pk
Glass. 21cl. 501.413.66



VÄGHULT candles
€4.79/9pk

VÄGHULT candles C4.79/9pk
Ø59mm. Assorted colours. 101.519.51
GLIMMA candle holders C1.59/6pk
201.141.71



TROLSK serving plate C6.99
Melamine. 34x34cm. White/green. 201.329.76



IKEA PS BJUDA
carafe C6.99
Glass. 1.3L. 301.413.67



FANTASTISK paper napkins C1.19/50pk
40x40cm. Green. 001.498.31



IKEA PS BRUNN vase C11.99
Glass and stainless steel. Ø13, H17cm. 901.477.57



LYFT 24-piece cutlery set C15.99
Stainless steel and plastic. White. 001.498.12



PANNÅ
place mat
€1.79

PANNÅ place mat C1.79
Plastic. Ø37cm. Green. 601.526.08
FÄRGRIK HÖGST range Earthenware.
Light green/white Deep plate C4.39 Ø24cm. 801.644.79
Plate C3.99 Ø27cm. 201.644.77



CECILIA fabric C2.59/m
Cotton. W150cm. White/green/black. 201.539.83



TRYGG
serving bowl
€2.59

TRYGG serving bowl C2.59
Glass. Ø28, H15cm. 201.324.53

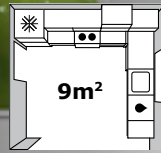

APPLÅD kitchen
*What's in the kitchen price? See page 132

€1285*

**APPLÅD black kitchen
with FAKTUM frame €1285***
APPLÅD doors/drawer fronts
in painted finish. Styled with
METRIK black powder-coated
aluminium handles, STRECKET
aluminium handles and NUMERÅR
solid birch worktop.

Kitchen

The real dream?
A kitchen where
performance matches
good looks

Everyone's favourite is on the menu

With 45 desirable door styles to choose from, you can be sure that we've got something to whet your appetite at IKEA Kitchens. Tactile wood, vibrant colours, gorgeous gloss, gleaming glass - you name it, you can choose it. Styles to suit your taste, prices to have you licking your lips in anticipation of a kitchen you've been dreaming of. Then all you have to decide is what to make for dinner.



BEKVÄM step stool
€14.99

APPLÅD white/APPLÅD black/ABSTRAKT high-gloss red/RUBRIK APPLÅD yellow/RUBRIK APPLÅD orange kitchen with FAKTUM frame €2512*

APPLÅD doors/drawer fronts in painted finish. ABSTRAKT doors/drawer fronts in foil finish. RUBRIK APPLÅD doors/drawer fronts in painted finish. Styled with STRECKET aluminium handles and NUMERÅR white laminate worktop with white laminate/stainless steel effect edge.

DOMSJÖ single-bowl inset sink €129
 Fits cabinet frames min. 60cm. wide. Coloured glazed

fireclay. 53x45, H18.3cm. White. 398.220.35

BEKVÄM step stool €14.99
 Solid birch. 45x39, H48cm. 001.505.08

TOKIG salad spinner €4.59
 Plastic and rubber. Ø23, H14cm. White. 601.486.78
BRAVUR clock €49.99
 Batteries sold separately. Steel/Glass. Ø57cm. Black. 600.989.75



A really easy way to give your kitchen a whole new look is to change the cabinet doors. We have lots of colours and styles to choose from on page 132.

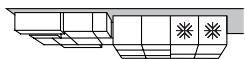

15m²

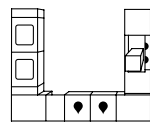

**ABSTRAKT/APPLÅD/
 RUBRIK APPLÅD kitchen
 €2512***

*What's in the kitchen price?
 See page 132.



See all our fabulous kitchen styles at [IKEA.IE/KITCHEN](https://www.ikea.ie/kitchen)





ÄDEL kitchen

€1963*

GRUNDTAL rails

€6.99/ea

SVEJE rug

€10.99

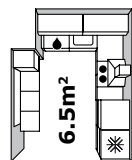

ÄDEL birch kitchen
€1963*

*What's in the kitchen price?
See page 132.

You dream, plan and decide. We can help with the rest.

Once your kitchen plan is ready, come to the IKEA store to finalise the details, place your order and choose any services you may want. For example, we can deliver the new kitchen to your home. Maybe along with someone who can assemble and install it for you!

ÄDEL birch kitchen with FAKTUM frame/AVSIKT roll-front cabinet €1963*

ÄDEL doors/drawer fronts in solid birch/birch veneer. AVSIKT roll-front cabinet in foil finish. Styled with VÄRDE brushed nickel-plated aluminium handles and PRÄGEL white laminate worktop. **NUTID MWN 410 microwave combi with forced air €629†** PRF €5 price less PRF €624 Microwave oven and forced air oven in one. Saves space and allows you to combine both functions. 59.5×56, H45.5cm. White. 601.237.53 **GRUNDTAL rails €6.99/ea** Stainless steel. L80cm. 100.113.95 **GRUNDTAL S-hooks €2.49/5pk** L7cm. 700.113.97 **SVEJE rug €10.99** 100% cotton. 90×150cm.

Red/white. 301.482.36 GRUNDTAL countertop lighting €45/ea

3 halogen bulbs included. Spare bulbs are available. Steel. Max. 10W. 55.5×8, H2.5cm. Grey. 901.157.80

ANTIFONI work lamp €34.99

Halogen bulb included. Extra bulbs are available. Minimum safe distance to illuminated objects: 50cm. Painted steel. Max. 40W. Shade Ø10, H50cm. Silver colour. 901.288.05

MALTE bar stool €39

Seat with handles, making the stool easy to move about. Suitable for bar height 90cm. Painted solid birch and birch veneer. 44×29, H67cm. Seat H63cm. Red. 001.305.58



All IKEA FAKTUM kitchens have a **free 25-year guarantee.** Find out more on page 374.



Make use of all the space you have. The AVSIKT roll-front cabinet offers clever storage for big kitchen utensils. That leaves you a nice clear worktop, which looks good, and also makes the perfect place to surf the net, when you get time off from cooking.

†PRF - Producer recycling fund

The price of this electrical item includes a Producer Recycling Fund contribution. This ensures that waste electrical and electronic equipment is collected and recycled in a responsible manner. The amount is subject to change please see page 378 for more information or visit IKEA.IE/WEEE

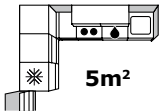

5m²

ABSTRAKT kitchen

€1503*

*What's in the kitchen price?

See page 132.

IKEA Kitchens... where real life measures up to your dreams

Any kitchen dream can be fulfilled. Measure out your space, (or have us do it for you), then plug the data into IKEA.IE/KITCHENPLANNER and away you go! You can plan your new kitchen online, repositioning cabinets and switching materials. Then bring all your dreams to the IKEA store, to make them come true. No need to close your eyes and count to ten. Just open them wide and look in at IKEA!

ABSTRAKT high-gloss grey kitchen with FAKTUM frame €1503*
ABSTRAKT doors/drawer fronts in foil finish. Styled with KLIPPIG aluminium handles and PRÄGEL white wood effect laminate worktop.

FASTBO wall panels €12/ea
Reversible for variation. Solid colour on one side, pattern on the other. Can be cut to desired size. Laminate. 60x50cm. Paisley pattern

black/white. 701.405.87
IKEA 365+ frying pan €16.99
Works well on all types of hob, including induction. Stainless steel coated with Teflon® Platinum. Ø24cm. 901.012.07
HYLLIS shelving units €8.99/ea
Suitable for both indoor and outdoor use. Galvanized steel. 60x27, H140cm. 401.037.27
ADMETE rug €14.99
100% Cotton. 200x70cm. Grey/white. 401.237.25



A quick idea for renewing your kitchen walls is to use FASTBO wall panels. They're easy to put up - including over existing tiles.



FASTBO wall panels
€12/ea



HYLLIS shelving units
€8.99/ea



DOORS AND HINGES Like you, they're on the go all the time in the kitchen - morning, noon and night. Because we know this, we test drive our door designs with a 2kg. weight, 200,000 times, to ensure they can stand up for themselves over many years.

TAPS Dishwashing, spud scrubbing, rinsing your lettuce or your fingers - the tap is at the heart of all the action. So we test our tap designs' durability, by turning them on and off 210,000 times. Then we switch from hot to cold another 140,000 times, and while we're at it, we make sure nothing leaks.

WORKTOPS Your worktop must handle hot pots, spills and splashes of all sorts. So we drench our product designs in water, oil and coffee, and then impact-test the top and edges to make sure they're durable.

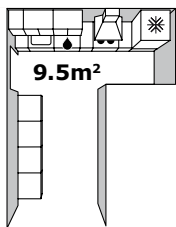

**LIDINGÖ kitchen
€2106***
*What's in the kitchen price?
See page 132.

DRAWERS They're in and out more often than your cat through its catflap at feeding time. To keep your cupboard drawers running smoothly year after year, we test one with a 8.2kg weight, 200,000 times.

APPLIANCES Baking, boiling, sizzling. Appliances certainly get put through their paces. But we offer a **free 5-year guarantee** on all of ours. And with energy-efficient designs, your muffins will rise, but your bills won't...

Made for everyday life. Tested accordingly.

LIDINGÖ white kitchen with FAKTUM frame C2106*
LIDINGÖ doors/drawer fronts in painted finish and glass doors in tempered glass. Styled with ANTIK brushed nickel-plated aluminium handles/knobs and PERSONLIG custom-made black stone worktop.

DÄTID HW570 extractor hood €499
Extraction rate in exhaust mode: 572 m³/h. Noise level at max. exhaust speed: 67 dB (A). 80x48, H99-154cm. Stainless steel. 801.515.56

DÄTID OVD10 forced air oven €449†
PRF €5 price less PRF €444
Energy class: A.
10 functions. Catalytic cleaning. Mechanical clock. 52L. 59.5x56.4, H59.5cm. Stainless steel. 401.451.57

RINGSKÅR single-lever kitchen mixer tap €99
The water flow can be adjusted in two steps making it possible to save water and energy. WRAS approved. Nickel-plated brass. H39cm. Stainless steel colour. 401.315.51

GRUNDTAL rails €6.99/ea
See page 118.
FADO pendant lamp €15.99
Ø30cm. Steel/Glass. 101.961.10



FAKTUM cabinets, RATIONELL drawers & shelves, kitchen fronts, worktops and sinks have a **free 25-year guarantee**. Find out more on page 374.



Taps have a **free 10-year guarantee**. Find out more on page 374.



Appliances have a **free 5-year guarantee**. Find out more on page 374.

† **PRF - Producer recycling fund**
The price of this electrical item includes a Producer Recycling Fund contribution. This ensures that waste electrical and electronic equipment is collected and recycled in a responsible manner. The amount is subject to change please see page 378 for more information or visit IKEA.IE/WEEE

The secret to an efficient kitchen largely lies behind closed doors

ABSTRAKT high-gloss white and RUBRIK copper effect kitchen with FAKTUM frame €3686*

ABSTRAKT doors in foil finish. RUBRIK doors in high-pressure melamine laminate. Styled with STRECKET copper-colour handles and PERSONLIG custom-made high-gloss white laminate worktop.

NUTID HDN SI810 free-hanging extractor hood €569

Ceiling mounted, free-hanging hood with 3 different speeds. Extraction rate in exhaust mode: 560 m³/h. Noise level at max. exhaust speed: 66 dB (A). 79.8x37, H79.5-107.5cm. Stainless steel. 301.238.58

OXSKÅR single-lever kitchen mixer tap €189

Cartridge with hard, durable ceramic discs/seals. Can withstand high friction that

occurs when the discs interact to regulate water temperature. WRAS approved. Chrome-plated brass. H22.5cm. Stainless steel. 901.133.90

RATIONELL waste sorting bin €5.49

Rounded corners - easy to clean. Folding handles keep the bin-liner in place and make the bin easy to carry. Plastic. Designer: Marcus Arvonen. 14L. 27x21, H37cm. 901.548.04

BÅSTIS FLÄCK food bowls €9.99/ea

Anti-slip material on the lower edge keeps the bowl in place. Many big dogs prefer to eat from a food bowl placed above floor level. Can be completed with BÅSTIS stand for food bowls. Stainless steel. 1.5L. Ø26, H10cm. 400.953.17

GRUNDTAL cabinet lighting €19.99/ea

Halogen bulb included. Spare bulbs are available. Brushed nickel-plated steel. Max. 20W. 001.298.71



A pull-out waste sorting station makes recycling less of a chore and more of an automatic part of your everyday routine, for a better environment.



FAKTUM cabinets, RATIONELL drawers & shelves, kitchen fronts, worktops and sinks have a **free 25-year guarantee**. Find out more on page 374.



RATIONELL waste sorting bin

€5.49

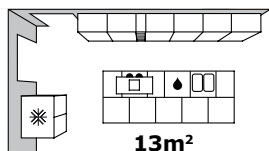

ABSTRAKT/RUBRIK kitchen €3686*

*What's in the kitchen price? See page 132.

RATIONELL 14-piece
divider set for drawers

€15.99



What's the point of a beautiful kitchen if you can't find your big sharp knife?

With RATIONELL interior fittings, you can organise the inside of all your cabinets and drawers so that every little (and big) thing in your kitchen has a home. The wide range of boxes, drawer dividers and trays offers specific solutions for all your storage requirements, and you can add on more RATIONELL organisers as those needs change. And that knife? Top left drawer, to the right. Easy!

1. RATIONELL cutlery tray €19.99 The dividers are removable, allowing you to create larger compartments. Solid beech. 71×49, H6cm. 401.155.51

2-3. RATIONELL dividers Adjustable dividers help you organise the drawer space according to your own storage needs. Aluminium and plastic.

2. 14-piece divider set for drawers €15.99

Frame W80cm. 300.927.29

3. 8-piece divider set for deep drawers €11.99

Frame W80cm. 500.902.44

4. RATIONELL VARIERA box for vegetables €8.99

Box with grid on base prevents moisture from forming, so vegetables stay fresh longer. Tinted birch veneer.

24×24, H15cm. 301.339.61

5. RATIONELL VARIERA box €3.99

Fitted with a handle.

Easy to place in a drawer, on a shelf or on a worktop.

Plastic. 29×18, H10cm.

Transparent. 401.182.72

6. RATIONELL VARIERA box €12.99

Fitted with a handle.

Easy to place in a drawer, on a shelf or on a worktop.

Tinted birch veneer.

48×24, H15cm. 301.167.11

7. RATIONELL corner base cabinet pull-out fitting €119

Adjustable shelves. Adapt spacing according to your personal storage needs.

Fits in a corner base cabinet with right-hand or left-hand door. Melamine foil finish and powder-coated steel.

105×52, H6cm. Grey. 401.167.39



Out-of-the-box cooking

Free-standing kitchen units like UDDEN are easy to choose and use. Just like regular furniture. With minimal planning, you can create an entire kitchen in a unique design, with matching appliances, all for a minimal price too. Just plug in, and start cooking!

UDDEN range

Stainless and powder-coated steel. Painted finish.

Cabinet with door €49

Black. 301.086.45
60×60, H62cm.

Drawer unit €59

Black. 901.082.18
60×60, H62cm.

Single bowl sink with legs €139

Reversible. Can be used with the drainer to the right or left. ATLANT water trap/strainer is included in the price but packed and supplied separately.

126×64, H90cm.

Silver colour. 398.173.88

Console €89

126×64, H90cm.

Silver colour. 800.596.52

Wire shelf €13

60×48, H63cm.

Silver colour. 500.596.58

Kitchen trolley €49

The trolley has 2 adjustable

legs and 2 legs with castors. Easy to move and roll in under UDDEN console. 54×54, H83cm.

Silver colour. 601.169.98

Wall shelf €29/ea

60×17, H60cm.

Black. 601.392.78

UDDEN FC213/18

fridge €459*

PRF €20 price less PRF €439

Reversible. Can be used with the drainer to the right or left. The door can be mounted to open from the left or right.

55×60, H142cm.

Black. 101.514.18

UDDEN CG3 cooker with ceramic hob €449*

PRF €5 price less PRF €444

Energy class: A. Includes functions that you will need for your daily basic cooking.

64.5×64, H90cm.

Black. 701.514.58

UDDEN HW320 extractor hood €149

Extraction rate in

exhausting mode: 336 m³/h.

Noise level at max. exhaust

speed: 69 dB (A). 50×52,

H20cm. 301.514.17



No matter what kind of kitchen you have, a kitchen trolley is a simple way to gain more workspace when and where you need it.

†PRF - Producer recycling fund

The price of this electrical item includes a Producer Recycling Fund contribution. This ensures that waste electrical and electronic equipment is collected and recycled in a responsible manner. The amount is subject to change please see page 378 for more information or visit IKEA.IE/WEEE

FRAMTID HW400 extractor hood

€499

MADE TO FIT Developed to sit perfectly within your IKEA kitchen, our built-in appliances make a seamless match for FAKTUM cabinets, which means they're smooth operators, and look it, too.

EVERYDAY FUNCTIONS
We offer what it takes to meet most cooking needs. From microwave ovens to domino hobs that you can combine – like gas hobs for fast frying, induction hobs for exact heat control, and a grill unit for low-fat cooking.

ENERGY EFFICIENT Appliances from IKEA are definitely that. Our ovens and dishwashers have class A energy rating, and all fridge/freezers have at least class A. And for a low-energy hob – choose the fast induction hob.

FRAMTID OV9 forced air oven with steam function
PRF €5 price without PRF €644

€649

SAFETY Everyone should be allowed in the kitchen. With features like heat-insulating oven doors and child safety locks as standard on all ovens, we make sure our appliances are safe for children.

IKEA appliances match your kitchen and your everyday cooking needs

TIDAHOLM oak/RUBRIK stainless steel kitchen with FAKTUM frame €2403*
TIDAHOLM doors/drawer fronts in lacquered solid oak/oak veneer. RUBRIK drawer fronts in stainless steel. Styled with TYDA stainless steel handles and NUMERÄR solid oak worktop.

FRAMTID HIN2K induction hob €319 2 induction zones. The induction zones transfer heat directly to the base of the cookware and its content, and cools quickly when the cookware is removed. 29x51, H4.3cm. Stainless steel. 701.511.42

FRAMTID HGA2K gas hob €129 2 burners. Heat ups quickly and reacts rapidly and precisely when you regulate the temperature. Makes it easy to adjust the heat according to the food you're cooking. 29x51, H4.1cm. Stainless steel. 801.541.59

FRAMTID HGR1K grill hob €229 1 grill plate. Ceramic plate for low-fat grilling of meat, vegetables and fish. 29x51, H4.1cm. Stainless steel. 201.541.62

FRAMTID HW400 extractor hood €499 3 speed fan. Extraction rate in exhausting mode: 395 m³/h. Noise level at max. exhaust speed: 61 dB (A).

59.8x44, H70–103cm. Stainless steel. 401.565.70
FRAMTID OV9 forced air oven with steam function €649*
PRF €5 price less PRF €644
Energy class: A. * 9 functions. 53L. TYDA handles match the handle on the oven. 59.4x56, H59cm. Stainless steel. 401.562.21
FRAMTID MW6 microwave oven €449
Crisp function. Output power microwave/grill: 1000/800W. 3D emission system. 31L. TYDA handles match the handle on the microwave oven. 59.5x46.8, H42.3cm. Stainless steel. 601.562.01

Browse through all our appliances at IKEA.IE/APPLIANCES

*** All IKEA integrated ovens have an energy class A classification.**



All IKEA appliances have a **free 5-year guarantee.** Find out more on page 374.

†PRF - Producer recycling fund
The price of this electrical item includes a Producer Recycling Fund contribution. This ensures that waste electrical and electronic equipment is collected and recycled in a responsible manner. The amount is subject to change please see page 378 for more information or visit IKEA.IE/WEEE

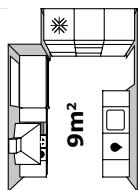

TIDAHOLM oak kitchen €2403*
*What's in the kitchen price?
See page 132.

Pick your style and let the price give you a pleasant surprise!

HÄRLIG kitchen
€399



280cm.



FAKTUM cabinets, RATIONELL drawers & shelves, kitchen fronts, worktops and sinks have a **free 25-year guarantee**. Find out more on page 374.

***What's included in the price?**

The total price includes cabinets, worktops, interior fittings, hinges, cover panels, decostrrips/mouldings, plinths and legs. Your choice of appliances, sinks, taps, knobs/handles and lighting are not included.

TAKE IT HOME TODAY

This symbol means that your kitchen doors are normally available for you to take home today. If you'd like help instead, or in case there is a temporary sell-out, home delivery later is available for an extra charge.

DIRECT DELIVERY

These doors are "order only" and will be delivered directly to you by us. Ask at the store about delivery prices.



€399
HÄRLIG white
Melamine foil finish.

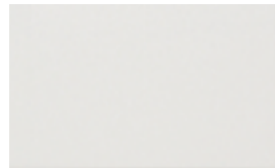

€599
APPLÅD white
Painted finish.



€599
APPLÅD black
Painted finish.



€599
NEXUS birch veneer
Tinted birch veneer.

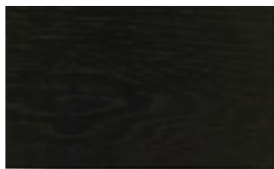

€599
NEXUS brown-black
Stained oak veneer.

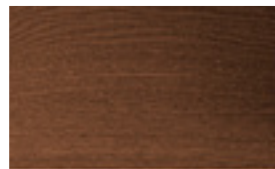

€599
NEXUS brown
Stained oak veneer.

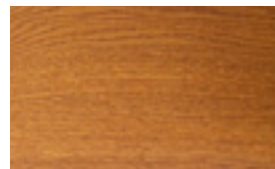

€599
NEXUS yellow-brown
Stained oak veneer.



€699
ÅDEL yellow-white
Foil finish.

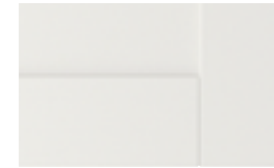

€699
ÅDEL white
Foil finish.



€699
STÅT white
Painted finish.



€699
LIDINGÖ white
Painted finish.



€849
KULLAVIK oak
Solid oak.

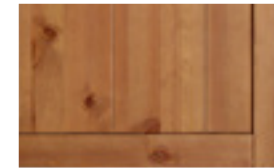

€849
FAGERLAND antique stain
Stained solid pine.



€849
ÅDEL birch
Solid birch/birch veneer.



€849
TIDAHOLM oak
Tinted solid oak/oak veneer.

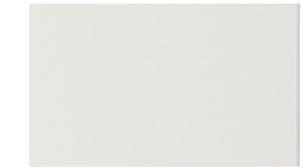

€849
ABSTRAKT high-gloss white
High-gloss foil finish.



€999
ABSTRAKT high-gloss grey
High-gloss foil finish.



€999
ABSTRAKT high-gloss red
High-gloss foil finish.



€999
ABSTRAKT high-gloss black
High-gloss foil finish.

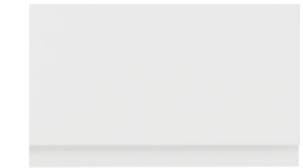

€999
SOLÅR white
Foil finish.



€1199
SOLÅR beech
Solid beech/beech veneer.



€1199
ULRIKSDAL oak
Solid oak.

You can do it yourself, or let us do it for you

You can save money by doing it all yourself, or you can choose from our range of services and let us do it for you. We can arrange everything from financing and delivery, to a fully installed ready-to-use kitchen including plumbing, electrics and all carpentry work. All at an everyday low price.

Next step? Make your dream a reality!



The 3D kitchen planner is available at the IKEA store or can be downloaded at

IKEA.IE/KITCHENPLANNER

Want more inspiration?

For even more kitchens with different expressions and solutions check out our web site, the kitchen brochure and the IKEA store, where you can open drawers and look inside cabinets for real.

Want to start planning?

Measure your kitchen space first and then start planning, using the 3D planner that you can download from IKEA.IE/KITCHENPLANNER. Or use the pop-out puzzle in the kitchen brochure. Add lighting, wall organisers and trolleys to make your kitchen even more functional, and more personal.

Need help?

We can arrange everything from delivery and a fully installed ready-to-use kitchen including plumbing, to electrics and all carpentry work. All at an everyday low price. Read more on page 372.

Pick up the new kitchen brochure in the store or order it at IKEA.IE/BROCHURES



Why pay more?

Good quality, function and low price



€399

HÄRLIG white kitchen with FAKTUM frame
Melamine foil finish. White.
What's in the kitchen price?
See page 132

Design and Quality IKEA of Sweden



just add a sweet tooth



IKEA 365+ 3-tiered serving stand

€13.99

IKEA 365+ 3-tiered serving stand

€13.99
Glass/stainless steel. 31x27, H34cm. 401.017.33

ENVIS 2-piece rubber spatula set €5.39
Melamine and silicone. 801.349.58



TEKLA tea towels €0.30/ea



TEKLA tea towels €0.30/ea
Cotton. 50x65cm. White/red. 101.009.09



DRÖMMAR 2-piece baking tin set €7.99
Steel, coated with Teflon(R) Prima. 501.330.45



SOCKERÄRT vase €22.99
Steel, enamel. 301.484.63
MIXA 3-piece kitchen utensil set €0.69 961.276.06



MAGASIN rolling pin €2.49
Solid birch. L43cm. 764.856.05



DRÖMMAR 2-in-1 spring form tin €10.59
Baking tin with two different bases. Capacity 2.3L or 2.6L. Steel coated with Teflon® Prima. Ø23cm. Red. 101.330.47



IDELIG mixing bowls €8.49 2.5L. 801.297.11
€10.49 4L. 901.297.15



BEKVÄM step stool €14.99

BEKVÄM step stool €14.99
Solid aspen. 45x39, H48cm. 001.505.08



BURKEN jar with lid €2.99

DRÖMMAR 6-piece pastry cutter set €4.49
Stainless steel. 301.330.46
BURKEN jar with lid €2.99
Glass/aluminium. 1.1L. 861.301.00

DUKTIG 7-piece children's baking set €10.99
201.301.66



Whatever your style, find a floor to suit it



TUNDRA floor

€9.99/m²



TUNDRA has a 10-year guarantee. Find out more on page 374.



- 1-7. TUNDRA floor with click-lock function**
Easy to lay, laminated flooring, with no adhesive required. A hard-wearing floor suitable for offices and all areas in the home, except wet rooms. Laminate. One pack covers 2.39/m².
1. €9.99/m² White. 801.030.18
2. €9.99/m² Maple effect. 200.700.11
3. €9.99/m² Oak effect. 800.700.13
4. €9.99/m² Antique effect. 600.700.14
5. €9.99/m² Medium brown. 601.030.19
6. €9.99/m² Dark brown. 201.370.78
7. €9.99/m² Black/white patterned. 901.519.47
- 8. MARKLAND floor €25.99/m²**
Built-in underlay, dampens sound and eliminates the need for a separate underlay when installing the floor. Laminate. One pack covers 1.81m².
White. 601.380.90
- 9. SLÄTTEN floor with click-lock function €5.99/m²**
Laminate. One pack covers 2.30m².
Beech effect. 201.448.80



8



SLÄTTEN floor
€5.99/m²

9



TRONDHEIM king-size bed frame €259
Painted finish. 171×210, H115cm.
(Mattress and bed slats sold separately). White. 498.615.64
PAX TONNES wardrobe with sliding doors €890
Minimum ceiling height required: 240cm. (Interior fittings sold separately). Tempered glass/aluminium. 300×66, H236cm. White. 898.627.50
STAVE mirror €29
40×160cm. White. 201.259.85
WILMA curtains €11.99/pair
35% cotton, 65% polyester. 145×300cm. White. 800.431.71

TRONDHEIM king-size bed frame
€259

STAVE mirror
€29

Bedroom

A private space for you...
and 30 of your
favourite jumpers



ASPELUND
double bed frame
€99

ASPELUND
3-door wardrobe
€179

How to turn plain white into a spectrum of colours

A basic white bedroom is full of infinite possibility, and you really don't need masses of money to make it happen. Just paint the town with textiles. They're an easy way to liven up a room without busting your budget. And since they're so simple to switch, you can ring the changes time and time again. See this room transformed at

IKEA.IE/BEDROOMS

ASPELUND double bed frame €99

Foil finish. 170×209, H110cm. Takes mattress size 140×200cm. (Mattress and bed slats sold separately). White. 198.615.70

BEATA BLAD double quilt cover set €34.99/5pcs

Bedlinen densely woven from fine yarn. Soft and durable quality. Available in several sizes. 100% cotton. Quilt cover 240×220cm. 4 pillowcases 50×80cm. Orange. 201.458.13

CECILIA fabric €2.59/m

Comes in a choice of patterns. 100% cotton. W150cm. Orange/pink/white. 001.539.84

TYGLÖSA stretcher frame €4.59

Make a unique picture by fastening your favourite fabric to the frame (fabric not included). Solid pine. 50×50cm. 701.260.44

ASPELUND 3-door wardrobe €179

A mirror door saves space and makes the room feel larger. Knobs included. Foil finish. 130×54, H190cm. White. 801.572.14

RITVA curtains with tie-backs €29.99/pair

Easily hemmed to desired length with the iron-on hemming strip included. 100% cotton. 145×300cm. Orange. 701.564.89

BAROMETER work lamp €39.99

Nickel-plated steel. Max 40W. Shade Ø14.5cm, H48cm. 100.895.82

ANDRUP rug €29.99

Handwoven. 80% wool, 20% nylon. 250×80cm. 401.515.77



Artwork made from several TYGLÖSA stretcher frames and various IKEA metre fabrics including CECILIA. See all IKEA metre fabrics at the IKEA store or at IKEA.IE/TEXTILES

PAX HEMNES wardrobes
with 3 doors

€400/ea



HEMNES
8-drawer chest
€239



Multiple mirrors take the guesswork out of getting ready to go out. Hanging three in a row, with the outside two on hinges, lets you see how gorgeous you look, from every angle.

PAX HEMNES wardrobes with 3 doors €400/ea

Stained solid pine and foil finish. (Handles and interior fittings sold separately) 150x60, H236cm.

Black-brown. 498.417.12

PAX shelves €10/2pk

Foil finish. 50x58cm.

Black-brown. 701.216.35

KOMPLEMENT storage with 9 compartments €20

Pulls out to give easy overview and access to contents.

100% polyester. Designer:

Magnus Elebäck. 50x58cm.

Grey. 901.393.33

KOMPLEMENT

drawers €23/ea

Slides smoothly in and out.

Provided with drawer stops.

Foil finish. 50x58cm.

Black-brown. 101.216.76

STAVE mirror

combination €107

Stained solid oak. 160x160cm.

Black-brown. 798.626.56

HEMNES 8-drawer

chest €239 Extra roomy

dimensions give excellent space

for storage. Stained solid pine.

162x51, H97cm.

Black-brown. 501.212.50

ALVINE RUTA rug €149

Reversible. Two identical

sides for even wear.

100% pure wool. 170x240cm.

White/yellow. 501.682.85

AINA cushion cover €4.99

Cotton/linen blend.

Combines the softness of

cotton with the lustre and

texture of linen. Fits inner

cushions 50x50cm. 55% linen,

45% cotton. 50x50cm. Light

grey. 101.600.12

RITVA cushion cover €4.99

Cotton. 50x50cm.

Beige. 401.516.95

LEVANGER
mirror

€79



EDLAND
dressing table

€179



When it comes to taking a good look at yourself, two lamps are better than one. Placed on either side of your mirror, they give an even light and no shadows falling across your face.

EDLAND dressing table €179 Smooth running drawers with pull-out stop. Stained solid pine. 125x57, H74cm. Grey. 701.628.62

NILS stool €35 Machine washable cover is easy to keep clean. 100% cotton. Painted solid birch. 34x34, H47cm. Black/Blekinge white. 198.503.88

LILLHOLMEN range Stainless steel.

Accessories stand €14.99 Ø20, H30cm. 101.493.93

Table mirror €12.99 One side with magnifying mirror glass. W22, H43cm. 800.741.86

ÅRSTID wall lamps €16.99/ea Adjustable head for easy light direction. Supplied with pull switch. 70% polyester, 30% cotton. Nickel-plated steel with brushed finish. Max. 40W. Shade Ø16cm. Off-white. 701.987.00

LEVANGER mirror €79 Can be hung horizontally or vertically. Mounting fittings included. Brass finish. 95x58cm. Gold colour. 301.212.51

EDLAND linen cabinet €399 Smooth running drawer with pull-out stop. 3 adjustable shelves included. Stained solid pine. Tempered glass. 92x51, H194cm. Grey. 301.628.64

EDLAND king-size bed frame €299 Painted finish. 168x210, H210cm. Takes mattress size 160x200cm. (Mattress and bed slats sold separately). White. 298.615.41

A complete
bedroom
for under
€380

1. DVALA pillowcases €4.99/2pk
100% cotton. 50×80cm.
Black. 401.458.45

**2. ENGAN double
bed frame €89** Foil finish.
Powder-coated steel.
145×205, H40cm. Takes mattress
size 140×200cm. (Mattress and
bed slats sold separately).
Walnut effect. 098.615.37

**SULTAN FLORVÅG double
polyurethane foam
mattress €89**
140×200cm. 801.397.34

**SULTAN LURÖY slatted
bed bases €15/ea**
17 slats of layer-glued birch
provide support for your body.
70×200cm. 501.602.08

3. ENGAN 2-door wardrobe €99
Particle board, foil, ABS plastic.
Designer: Henrik Preutz.
78×52, H198cm. 501.587.57

**4. KVART wall/clamp
spotlight €4.99**
Painted steel. Max. 40W.
Shade Ø8.5cm. White. 400.947.99

5. RITVA throw €6.99
63% acrylic, 25% polyester,
12% mohair. 130×170cm.
Green. 001.516.97

**6. ULSBERG bedside
table €25**
Powder-coated steel/tempered
glass. 47×47, H57cm. Dark grey/
frosted glass. 201.631.28

7. LUPIN Venetian blind €9.99
Solid paulownia wood.
80×130cm. Natural. 501.175.16

**8. KAJSA BLAD double quilt
cover set €14.99/5pcs**
100% cotton.
Quilt cover 200×200cm.
4 pillowcases 50×80cm.
White/grey. 801.512.45



ENGAN
2-door wardrobe
€99



€373.95

Fingers crossed for a rainy day

HOPEN double bed frame **€149**

Foil finish. 163×217, H86cm.
Takes mattress size
140×200cm. (Mattress and
bed slats sold separately).
Black-brown. 598.497.98

ANDREA SATIN king-size quilt cover set **€59.99/5pcs**

Available in several sizes.
100% cotton.

Quilt cover 240×220cm.

4 pillowcases 50×80cm.

Multicolour/purple. 401.456.47

KAJSA VIRKA throw **€26.99**

100% cotton. 130×170cm.

Striped white/multicolour.

301.516.86

HOPEN 4-drawer chests **€159/ea**

Smooth-running drawers with
pull-out stop. Handles included.

Foil finish. Tempered glass.

80×49, H86cm.

Black-brown. 801.295.89

TUPLUR roller blind **€13.99**

Blackout blind. Special coating
that does not let any light
through. Total width including
fittings 124cm. 100% cotton.

120×195cm. White. 600.495.17

IKEA PS SVARVA table

lamp **€105**

Adjustable head for easy

light direction. 100% cotton.

Painted solid beech. Max. 75W.

Shade Ø43, H70cm.

White. 201.474.78

LACK wall shelves **€4.99/ea**

Concealed mounting fittings.

The shelf becomes part of

the wall. Painted finish.

Max. load 3kg. 30×26, H5cm.

Red. 901.036.21

BERYLL wall

spotlights **€19.99/ea**

Halogen bulbs included.

Extra bulbs are available.

Transformer included.

Lacquered plastic.

Max. 20W. D15cm.

Black. 301.397.17

KOLDBY cowhide **€199**

The hide will retain its

natural appearance and

quality over a long time.

Sizes vary from 3.2m² to 5m².

Cowhide. 101.572.17

LUDE sheepskin **€29.99**

Wool is soil-repellent and

hard-wearing. Sheepskin.

95×60cm. White. 832.351.10

DEGERNES bed storage

box **€29/ea** Easy to push in

and pull out from under the

bed thanks to the glides.

Rattan. 100% cotton.

90×60cm, H20cm. 300.395.86



HOPEN 4-drawer chests
€159/ea

HOPEN double bed frame
€149



MALM
6-drawer chest
€99

Little bedroom + loads of stuff = precisely what great storage was made for

Just because you want to cut the clutter, it doesn't mean you want to jettison the jeans, jumpers, platforms, postcards or pink feather boa just yet! With boxes up high and storage below the bed, you get to keep the lot, love letters included, and still keep control of your surroundings.

LEFT PAGE:

PAX UGGDAL wardrobe with sliding doors €550

Tempered glass and aluminium. 200x66, H236cm.

Birch effect/grey. 798.695.68

MALM 2-drawer chest €39

Can also be used as a bedside table. Available in different sizes. Particle board, birch veneer, acrylic lacquer.

40x48, H56cm. 900.539.18

MALM 6-drawer chest €99

Birch veneer.

80x48, H123cm. 400.539.30

STAVE mirror €29

Solid birch.

40x160cm. 101.259.81

KNUBBIG table lamp €16.99

Mouth-blown glass,

each lamp is unique.

Max. 40W. Ø20, H21cm.

Black. 701.305.07

IKEA 365+ RISP double quilt cover set €44.99/5pcs

Quilt cover with contrasting sides for variation.

The pillowcases feature different colours.

50% lyocell, 50% cotton.

Quilt cover 240x220cm.

4 pillowcases 50x80cm.

Black/white. 101.233.69

KASSETT clothes boxes €8.49/ea

43x55cm H18cm.

See page 300.

SVEJE rug €10.99

150x90cm. Machine-woven.

Black/white. 201.470.63

GRUNDTAL spotlights

€17.99/3pk

Provides a focused light; good

for lighting up smaller areas.

Nickel-plated. 301.193.52

EKBY JÄRPEN/EKBY

BJÄRNUM shelves €29.99

See page 282

THIS PAGE:

1. KOMPLEMENT

5-compartment trouser hanger €35

Pulls out for easy overview

and access. Holds minimum

14 pairs of trousers.

100% polyester. Powder-coated

steel and plastic. 100x58cm.

Beige. 401.411.40

2. SAMLA box with lid €11.99

Polypropylene plastic.

79x57, H18cm. 55L.

Transparent. 698.713.88

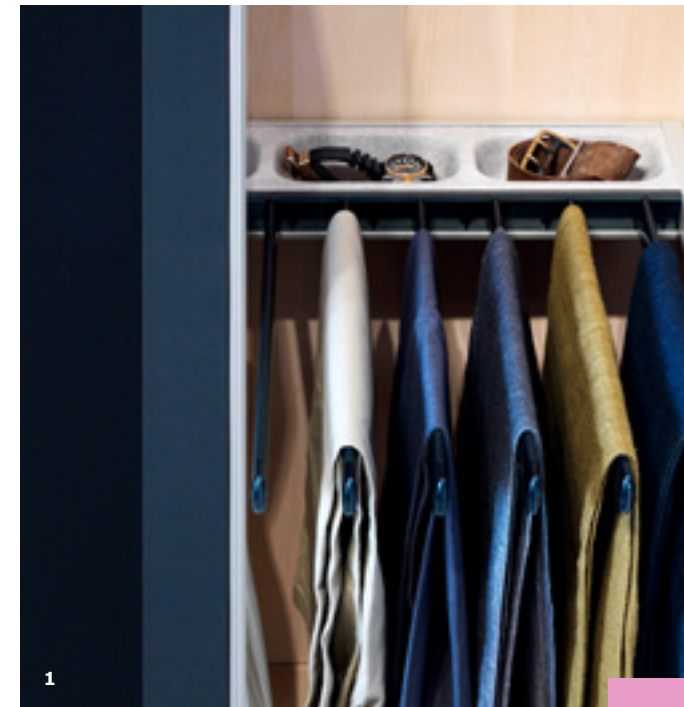

1



2

SAMLA box with lid

€11.99

Think smart. Not small.



Fold it
NISSE folding chairs €11.99/ea
 Plastic and powder-coated steel. 45x47, H76cm. Black. 301.150.66

Screen it
ALVINE FLÄTA curtains €9.99/pair
 100% polyester. 145x300cm. 801.601.98

HEMNES daybed
€359



Extend it
HEMNES daybed frame with 2 drawers €359
 Stained solid pine. 86x207, H91cm. Takes mattress size 80x200cm. (Sold separately). Black-brown. 601.628.86



LEKSVIK drop-leaf table
€129

Convert it
LEKSVIK drop-leaf table €129
 Stained solid pine. 59/89/119x78, H74cm. Black. 201.160.52



ODDA bedside table
€39

Move it
ODDA bedside table €39
 Painted finish. 61x45, H44cm. White. 501.205.47



HEMNES 6-drawer chest €199 Stained solid pine. 110x51, H132cm. Blue. 901.212.48
ALVINE LJUUV single quilt cover set €24.99/3pcs
 Available in several sizes. 100% cotton. Quilt cover: 150x200cm. 2 pillowcases: 50x80cm. Multicolour. 201.596.16



See all our beautiful
bedroom styles at
[IKEA.IE/BEDROOMS](https://www.ikea.ie/bedrooms)

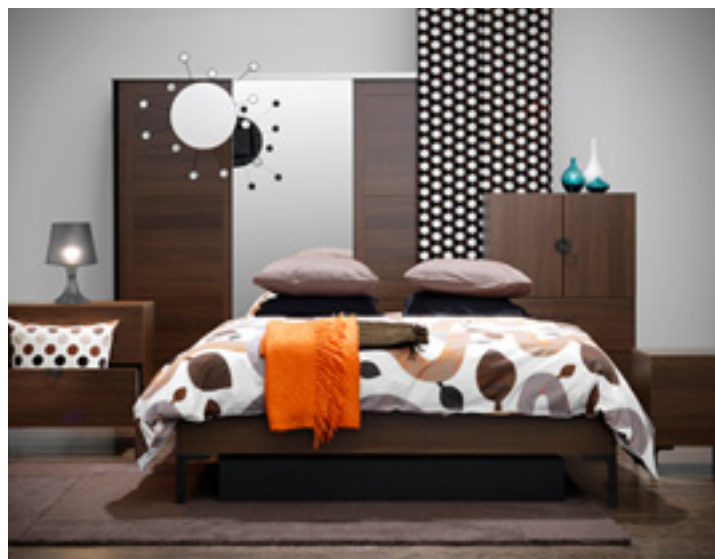
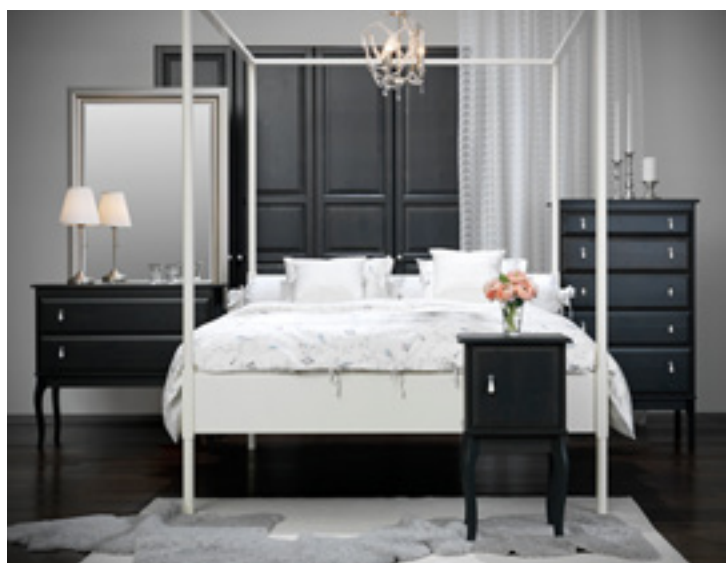



HEMNES king-size bed frame

€239

HEMNES – Traditional with a twist

You can love the traditional look but still keep up with the times. With HEMNES, it's easy to start with simplest white or black, and then bring on a burst of colour. Beds, tables, chests, a freestanding wardrobe - mix different pieces and finishes from this flexible range, for a bedroom that's practically traditional but never, ever dull.

HEMNES
daybed frame
€359



HEMNES
3-drawer chest
€139



LEFT PAGE:

HEMNES king-size bed frame €239
Adjustable bed sides allow you to use mattresses of different thicknesses. Painted finish. 170×207, H121cm. Takes mattress size 160×200cm. (Mattress and bed slats sold separately). White. 298.497.90

HEMNES bedside table €39
Stained solid pine. 46×35, H70cm. Red. 501.241.59

PAX BIRKELAND 4-door wardrobe €420
Painted finish. 200×60, H236cm. White. 298.308.61

THIS PAGE:

HEMNES range Stained solid pine.
1. Daybed frame €359 Painted finish. 87×211, H86cm. Takes mattress 80×200cm. (Mattress and bed slats sold separately). 500.803.15
2. Bedside table €59 39×39, H75cm. Black-brown. 701.418.60
3. Bedside table €39 46×35, H70cm. Black-brown 901.212.34
4. Storage bench €159 Painted finish. 140×41, H58cm. White. 501.418.56
5. 6-drawer chest €199 110×51, H132cm. Blue. 901.212.48
6. Linen cabinet €199 Tempered glass. 110×51, H132cm. Yellow. 301.418.57

7. 3-drawer chest €139 110×51, H97cm. Black-brown. 901.595.71
8. 8-drawer chest €239 162×51, H97cm. Black-brown. 501.212.50
9. Mirror chest €219 Extra roomy proportions mean more space for storage. Painted finish. 110×51, H191cm. White. 801.607.06
10. Wardrobe €339 110×61, H198cm. Black-brown. 901.418.59

See all HEMNES designs, sizes and colours at IKEA.IE/HEMNES



MALM double bed frame
€129

MALM – Simplicity and sanctuary

In a busy life, a MALM bedroom provides a fuss-free escape. Different options mean you choose the storage to suit your needs. So, unruly socks are tamed, and bedside clutter cleared. All MALM designs have a clean look and are specifically styled to work together, for a bedroom that's as peaceful as it is functional.

Available in three finishes



Black-brown

Birch

Oak



LEFT PAGE:

MALM range oak veneer.

4-drawer chest €89
 120x48, H55cm. 901.430.90

4-drawer chest €79
 80x48, H100cm. 000.625.97

Bedside table €39
 50x40, H77cm. 100.569.30

Double bed frame €129
 156x210, H77cm. Takes mattress size 140x200cm. (Mattress and bed slats sold separately). 998.498.81

THIS PAGE

MALM range Birch veneer.

1. Headboard €89
 Designer: Eva Lilja Löwenhielm.

160x5, H124cm. 101.605.02
 see SULTAN bed on page 186

2. STAVE mirror €19.99
 70x70cm. 701.259.78

Dressing table €99
 Designer: Eva Lilja Löwenhielm.

3. King-size bed frame €139
 176x210, H77cm. Takes mattress size 160x200cm. (Mattress and bed slats sold separately). 698.498.49

3-piece headboard/bed shelf set €129
 Concealed storage for things that you want to keep within easy reach.

177x31, H77cm. 401.094.18

4. 6-drawer chest €139
 160x48, H78cm. 800.539.33

5. 6-drawer chest €99
 80x48, H123cm. 400.539.30

6. 4-drawer chest €79
 80x48, H100cm. 700.539.24

7. 3-drawer chest €59
 80x48, H78cm. 300.539.21

Glass top €13
 80x48cm. Transparent grey. 401.426.58

8. 2-drawer chest €39
 40x48, H56cm. 900.539.18

See all MALM designs at IKEA.IE/MALM



MANDAL king-size
bed frame with
storage boxes
€279

MANDAL – Lets solid pine shine



MANDAL range
Stained solid pine. Pine/black.

1. King-size bed frame with storage boxes €279
160×202, H27cm. Takes mattress size 160×200cm.
(Mattress and bed slats sold separately). 801.213.38

2. Bedside table €49
45×49, H52cm. 201.212.75

3. 6-drawer chest €159
139×48, H79cm. 001.212.62

4. Headboard €99
240×28, H62cm. 501.212.74

5. Wardrobe combination €339
119×60, H207cm. 301.212.65

BODÖ range Powder-coated steel. Solid pine. Black.

Bed frame €39
123×200, H33cm. Takes mattress size up to 120×200cm. (Mattress and bed slats sold separately). 001.048.56

Bedside table €6.99
55×30, H33cm. 201.048.55

Shelf with 3 boxes €25
54×44, H106cm. 401.048.59

Wardrobe unit €29
113×50, H196cm.601.048.58

BODÖ 4-piece bedroom suite

€99.99





ASPELUND
double bed frame
€99



EDLAND
bedside table
€79

ASPELUND – Nirvana for your bedroom, heaven for your wallet



1

ASPELUND range Foil finish. White.

1. Double bed frame €99

150x209, H110cm. Takes mattress size 140x200cm. (Mattress and bed slats sold separately). 198.615.70

2. Bedside table €25

The door can be hung open to the right or the left. 36x35, H63cm. 401.572.06



2

ASPELUND
bedside table
€25



3

3. Bed storage box €39

160x68, H17cm. 201.572.12

4. 4-drawer chest €139

170x44, H79cm. 601.598.36

5. 2-door wardrobe €129

1 adjustable shelf and 1 clothes rail included. 91x54, H190cm. 101.598.34



4



5

EDLAND – 18th century goes flat pack, verily forsooth



1

EDLAND range
1. Dressing table €179 Stained solid pine. Designers: T. Christensen/K. Legaard. 125x57, H74cm. Grey. 701.628.62

2. Bedside table €79 Stained solid pine. 40x40, H73cm. Grey. 901.628.56

3. 2-drawer chest €159 Stained solid pine. 116x46, H83cm.



2



3



4

Grey. 501.628.58
4. 2-door wardrobe €399 1 clothes rail and 1 shelf included. Stained solid pine. 91x51, H194cm. Grey. 801.628.66

5. King-size bed frame €299 Painted finish. 168x210, H210cm. Takes mattress size 160x200cm. (Mattress and bed slats sold separately). White. 298.615.41



5



ANEBODA 3-drawer chests

€49 /ea

ANEBODA – Simply Scandinavian

ANEBODA double bed frame

€69



2



3



4



5



ANEBODA 2-door wardrobe

€69

- 1. ANEBODA double bed frame €69** Foil finish. 145×213, H71cm. Takes mattress size 140×200cm. (Mattress and bed slats sold separately). White. 898.497.54
- 2. ANEBODA bedside table €39** Smooth running drawer with pull-out stop. 40×40, H72cm. White. 301.217.60
- 3. ANEBODA 3-drawer chest €49** Smooth running drawers with pull-out stop. 80×40, H100cm. White. 701.217.63

- 4. KOLJA mirror €12.99** Glass. 60×60cm. 948.899.00
- 5. ANEBODA 2-door wardrobe €69** Adjustable, self-closing hinges make the wardrobe both good-looking and practical. Handles included. 81×50, H180cm. White. 901.217.62



ENGAN – So much for so little

ENGAN double bed frame

€89



2



3



4



5



ENGAN 2-door wardrobe

€99

- 1. ENGAN double bed frame €89** Foil finish. 145×205, H40cm. Takes mattress size 140×200cm. (Mattress and bed slats sold separately). Walnut effect. 098.615.37
- 2. ENGAN bedside table €39** Foil finish. 39×41, H52cm. Walnut effect. 901.587.55
- 3. ENGAN 2-drawer chest €69** Smooth running drawers with pull-out stop. Foil finish. Designer: Henrik Preutz. 78×41, H70cm. Walnut effect. 101.587.35

- 4. KOLJA mirror €17.99** Glass. Ø55cm. 301.335.22
- 5. ENGAN 2-door wardrobe €99** A mirror door saves space and makes the room feel larger. 1 clothes rail and 1 shelf included. Foil finish and glass. 78×52, H198cm. Walnut effect. 501.587.57



1

2

3

4

5

MALMA
mirrors
€1.59/ea

STAVE mirror
€49

MONGSTAD
mirror
€99

KRABB mirrors
€9.99/ea

6

7

8

9

10

- 1. HEMNES mirror €79**
Full length mirror. Solid pine. 75×165cm. White. 700.349.16
- 2. STAVE mirror €19.99**
Solid oak. 70×70cm. 901.259.77
- 3. JONDAL mirror €49**
Full length mirror. Polyurethane plastic cover. Glass. 60×140cm. Dark brown. 100.738.78
- 4. MALMA mirrors €1.59/ea**
Stained solid pine. 26×26cm. Red. 301.508.18
- 5. NORESUND mirror €19.99**
Powder-coated steel. Glass. 74×74cm. Black-brown. 900.817.23
- 6. LEVANGER mirror combination €147** Create your own combination of 3 mirrors. The hinges needed to create this solution are included with LEVANGER 50×140cm. Brass. Glass. 155×140cm. Gold colour. 998.626.60
- 7. KRABB mirrors €9.99/ea**
Full length mirrors. Can be hung horizontally or vertically. Glass. 20×160cm. 948.903.00
- 8. STAVE mirror €49**
Full length mirror. Can be hung horizontally or vertically. Solid birch. 70×160cm. 001.259.86
- 9. KOLJA mirror €39**
Full length mirror. Can be hung horizontally or vertically. Glass. 60×140cm. 201.335.32
- 10. MONGSTAD mirror €99**
Full length mirror. Can be hung horizontally or vertically. Stained oak veneer. Glass. 94×190cm. Black-brown. 000.815.91

i Find all our mirrors at the **IKEA** store or at IKEA.IE



GRIMSTAD king-size bed frame C489
87% cotton, 13% polyester.
182x234, H109cm. Takes mattress size
160x200cm.* Korndal beige. 298.499.50

140cm. 160cm.



VANVIK king-size bed frame C339
100% cotton. 168x237, H108cm.
Takes mattress size 160x200cm.*
Blekinge white. 498.615.59

140cm. 160cm.



FLORÖ king-size bed frame C319
100% cotton. 168x215, H112cm.
Takes mattress size 160x200cm.*
Gobo dark beige. 398.500.14

140cm. 160cm.



GRIMEN king-size bed frame C379
100% wool. 189x229, H38cm.
Takes mattress size 160x200cm.*
Ullevi grey. 098.499.32

140cm. 160cm.



HEMNES king-size bed frame C219
Stained solid pine. 170x207, H121cm.
Takes mattress size 160x200cm.*
Black-brown. 298.497.71

90cm. 140cm. 160cm. 180cm.



HOPEN king-size bed frame C169
Foil finish and steel. 183x217, H86cm.
Takes mattress size 160x200cm.*
Black-brown. 398.497.99

140cm. 160cm.



**MALM king-size
bed frame**
€139

MALM king-size bed frame C139
Painted ash veneer. 177x211, H77cm.
Takes mattress size 160x200cm.*
Black-brown. 298.498.46

90cm. 140cm. 160cm. 180cm.



**TRONDHEIM king-size
bed frame C259** Painted finish.
171x210, H115cm. Takes mattress size
160x200cm.* White. 498.615.64

140cm. 160cm.



IBESTAD king-size bed frame C209
Powder-coated steel. 188x242, H125cm.
Takes mattress size 160x200cm.*
Silver colour. 498.499.11

140cm. 160cm.



LILLESAND double bed frame C119
Powder-coated steel. 148x207, H131cm.
Takes mattress size 140x200cm.*
Black. 098.499.70

140cm. 160cm.



**ANEBODA double
bed frame**
€69

ANEBODA double bed frame C69
Foil finish. 145x213, H71cm.
Takes mattress size 140x200cm.*
White. 898.497.54

140cm. 160cm.



**DALSELV double
bed frame**
€49

DALSELV double bed frame C49
Solid pine and steel. 161x209, H97cm.
Takes mattress size 140x200cm.*
500.216.32

90cm. 140cm. 160cm.

*For all bed frames shown on this page, the mattresses and bed slats are sold separately.

Why pay more?
Good quality, function and low price



Designed by:
Carina Bengs

€89

LEIRVIK double bed frame
Powder-coated steel. 148x209, H146cm. Takes
mattress size 140x200cm. (Mattress and bed
slats sold separately). White. 098.499.65



PAX – One word, many definitions

PAX is one wardrobe system, with a host of different personalities. (Far more than we can show here!). With doors in a variety of styles, and frames in different heights and widths, it can go from sleek and space-saving, to big and rustic. You customise it to suit your style, and build it to fit your space. See all the PAX size and design options available to create your own definitive style, and start planning at IKEA.IE/PAXPLANNER



PAX and KOMPLEMENT have a 10-year guarantee. Find out more on page 374.



1

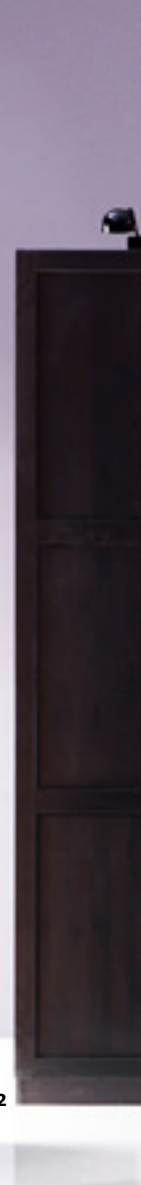

2



PAX LYNGDAL wardrobe with sliding doors

€550

3



PAX BIRKELAND wardrobe

€105

4

5

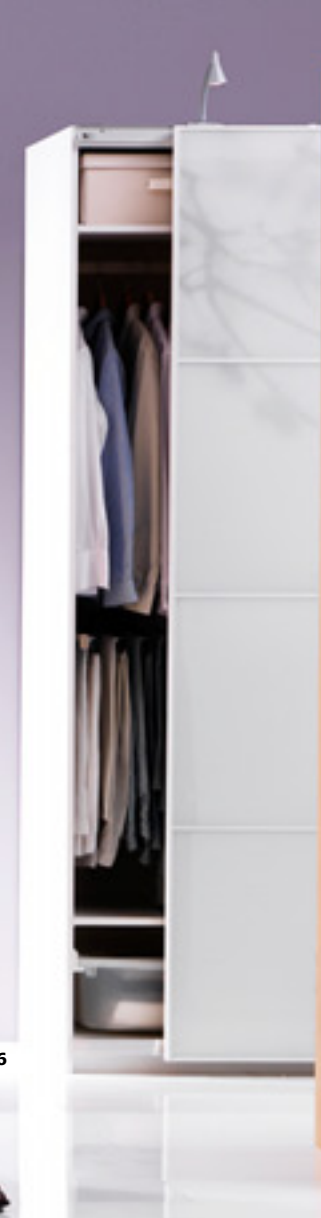

6



7

- 1. **PAX BERGSBO wardrobe with 2 doors €170** Tempered glass and foil finish. 100×60, H236cm. Black-brown/white. 198.717.48
- 2. **PAX HEMNES wardrobe with 2 doors €210** Stained solid pine and foil finish. 100×60, H201cm. Black-brown. 198.507.60
- 3. **PAX LYNGDAL wardrobe with sliding doors €550** Tempered glass,

- aluminium and foil finish. 200×66, H236cm. Oak effect/glass. 198.504.06
- 4. **PAX HAKADAL wardrobe with sliding doors €670** Birch veneer and foil finish. 200×66, H236cm. 798.647.83
- 5. **PAX BIRKELAND wardrobe €105** White. 098.264.88
- 6. **PAX TONNES wardrobe with sliding doors €890** Tempered glass, powder-coated aluminium and foil finish.

- 300×66, H236cm. White. 898.627.50
- 7. **PAX UGGDAL wardrobe with sliding doors €550** Tempered glass, aluminium and foil finish. 200×66, H236cm. Oak effect/grey. 198.698.54

For all PAX combinations the interior fittings are sold separately.



KOMPLEMENT
trouser hanger
€35

KOMPLEMENT
wire baskets
€10/ea

KOMPLEMENT
shoe racks
€8/ea

KOMPLEMENT – Takes PAX from deep space to astronomical storage system

Turn your fabulous PAX wardrobe into an out-of-this-world storage solution with KOMPLEMENT interior organisers. From sweaters to shoes, ties to tiaras, whatever you're wearing this season, KOMPLEMENT can cater for the lot.

- 1. KOMPLEMENT storage with 18 compartments C29**
100% polyester. 100×58cm. 901.465.26
- 2. KOMPLEMENT trouser hanger with 5 compartments C35**
Powder-coated steel. 100×58cm. 401.411.40
- 3. KOMPLEMENT add-on clothes rail C5**
Powder-coated steel. W54-77cm. 801.411.62
- 4. KOMPLEMENT wire baskets C10/ea**
Powder-coated steel. Max. load 15kg.

- 100×58cm. 301.067.88
- 5. KOMPLEMENT drawers C29/ea**
Solid birch. 100×58cm. 201.033.80
- 6. KOMPLEMENT shelves C9/ea**
Tempered glass. 50×58cm. 801.466.64
- 7. KOMPLEMENT rack with 16 hooks C5.99/ea**
Pull out for easy access. Plastic. Max. load 6kg. 56×5cm. 601.498.47
- 8. KOMPLEMENT storage with 9 compartments C20**
100% polyester. 50×58cm. 901.393.33

- 9. KOMPLEMENT shoe racks C8/ea**
Can be fitted slanting for storage of shoes, or level for clothing. Powder-coated steel. 100×35cm. 801.411.57
- 10. KOMPLEMENT shoe organiser C39**
Powder-coated steel. 100×58cm. 201.079.72

 **KOMPLEMENT interior fittings buying guide on page 358.**

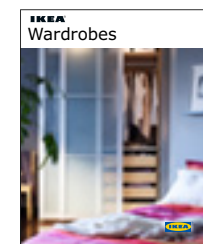

Pick up your wardrobe brochure at the IKEA store or view it online at IKEA.IE



STOLMEN
storage combination

€314

STOLMEN – Imagination on legs



1



2



3



4



5

STOLMEN
mirror with
storage unit
€100

STOLMEN range Aluminium and painted finish. White.

BIG PICTURE:

Storage combination C314 227×50, H210-330cm. 798.709.82
Storage combination C98 127×50, H210-330cm. 198.709.80

1. **Storage combination C528** 284×50, H210-330cm. 898.562.97
2. **Storage combination C283** 180/150×H210-330cm. 398.389.51
3. **Storage combination C136** 125×50, H210-330cm. 998.495.41
4. **Storage combination C317** 160×50, H210-330cm. 798.676.92
5. **Mirror with storage unit C100** 50×50, H210-330cm. 098.495.45



ELGÅ ANEBODA FENSTAD
wardrobe with sliding doors

€310

ELGÅ – Spend less, shop more!



1



2



3



4



5

ELGÅ ANEBODA
wardrobe with
sliding doors
€210

ELGÅ range Foil finish. Glass.

1. **ELGÅ ENGAN FENSTAD wardrobe with sliding doors C255** 145×58, H203cm. Grey. 498.614.13
2. **ELGÅ ANEBODA FENSTAD wardrobe with sliding doors C310** 217×58, H203cm. White. 598.614.41
3. **ELGÅ ENGAN wardrobe with sliding doors C230** 145×58, H203cm. Grey. 698.614.07

4. **ELGÅ FENSTAD wardrobe with sliding doors C380** 217×58, H203cm. Grey. 198.614.38
5. **ELGÅ ANEBODA wardrobe with sliding doors C210** 145×58, H203cm. White. 098.614.10

i **ELGÅ and STOLMEN wardrobe systems buying guides on pages 352 & 358.**



EDLAND 5-drawer chest €239
Stained solid pine. Designers: T. Christensen/K. Legaard. 82x52, H136cm. Grey. 101.628.60



VINSTRA 6-drawer chest €359
Foil finish. 160x44, H82cm. Off-white. 301.439.60



HOPEN 8-drawer chest €239
Foil finish and tempered glass. 160x49, H86cm. Black-brown. 201.295.92



TRONDHEIM 4-drawer chest €179
Painted finish. Designer: Magnus Elebäck. 106x50, H118cm. White. 601.645.07



ASPELUND 3-drawer chest €99

ASPELUND 3-drawer chest €99
Foil finish. 88x44, H110cm. White. 801.598.35



HEMNES 3-drawer chest €139
Stained solid pine. 110x51, H97cm. Red. 101.212.47

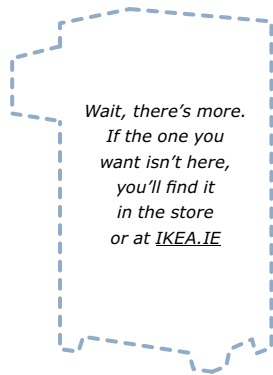

*Wait, there's more.
If the one you want isn't here,
you'll find it in the store
or at IKEA.IE*



HEMNES 3-drawer chest €149

HEMNES 3-drawer chest €149
Painted finish. 110x51, H97cm. White. 200.678.29



MALM 3-drawer chest €59
Birch veneer. 80x48, H78cm. 300.539.21



KULLEN 3-drawer chest €29

KULLEN 3-drawer chest €29
Foil finish. 70x40, H72cm. 600.930.58



ENGAN 4-drawer chest €99
Foil finish. Designer: Henrik Preutz. 117x41, H41cm. 001.587.45



RAST 3-drawer chest €19.99

RAST 3-drawer chest €19.99
Solid pine. 62x30, H70cm. 753.057.09

Why pay more?

Good quality, function and low price

€69

ASPELUND 2-drawer chest
Smooth running drawers with pull-out stop. 87x44, H79cm. White. 001.572.13



just add pyjamas



FELICIA throw
€9.99

FELICIA throw €9.99
Acrylic. 130x170cm. Cerise. 801.087.37



BLOMSTER bowl €9.99
Glass. 37x9, H8.5cm.
Assorted colours. 901.300.83
Pot-pourri sold separately.



ALVINE ÖRTER king-size quilt
cover set €18.99/5pcs 001.621.63.



ALINA 2-piece bedspread
and cushion cover set €49.99
001.626.34.



SKIMRA/JANUARI
table lamp
€17.98

SKIMRA shade €5.99
Cotton. Ø16, H29cm.
Assorted colours.
601.541.36
JANUARI table
lamp base €11.99
H35cm. 801.325.44



PERSIKA vase
€6.99

PERSIKA vase €6.99
Mouth blown, each vase has been shaped
by a skilled craftsman. Painted glass.
H17cm. Pink. 501.565.22



DEKAD alarm
clock €4.99
Wind the clock
every 24 hours.
Steel. Black.
800.626.64



TINDRA scented
candle in a glass €1.49
H8cm. Red. 501.353.32



ALVINE GÅVA cushion cover €3.99
Cotton. 801.599.15.



LÅNGASJÖ frames
€3.99/2pk

LÅNGASJÖ frames €3.99/2pk
Frames made from handmade paper.
Polyester/cotton. 50x60cm.
White/assorted patterns. 701.462.40

LJUVLIG mug
€1.09



LJUVLIG range Glass.
Mug €1.09 21cl. Lilac. 901.328.93
Side plate €1.19
Ø20cm. Dark lilac. 801.317.47



SLUMRA pillowcases €2.59/2pk
Polyester/cotton. 50x80cm.
Light pink. 001.459.46

ALVINE RÄFFLA cushion cover €7.99
Cotton. 65x65cm. Red/blue/natural. 301.599.13



MYSA GRÄS
quilts
€4.59/ea

MYSA GRÄS single quilts €4.59/ea 901.314.26.
GOSA SLÅN pillow €1.79 301.253.05.



SULTAN HAGAVIK double sprung mattress

€259



Good night, everyone

Side sleepers, back sleepers, pile-on-the-covers or throw-wide-the-window sleepers. A bed all to yourself or a haven for two. Everyone has a different way of sleeping, and SULTAN mattresses are designed to suit them all.

At IKEA.IE and the IKEA store, we make it easy for you to find the bed that best matches your needs. For night-after-night comfort that's customised for you... and you, and you, and, yes, that guy over there too.



SULTAN has a 25-year guarantee. Find out more on page 374.

SULTAN HAGAVIK double sprung mattress €259
Active pocket springs provide very precise body support and relieve pressure on your shoulders and hips.
140x200cm. Light grey. 901.562.90



SULTAN HJARTDAL
double sprung mattress

€459

You spend a lot of time on your mattress. A third of your life, actually. But that doesn't mean that finding the right mattress has to be difficult – or dull. So let's get down to what really matters. Comfort is personal, and choosing a mattress should be about you. That's why we develop SULTAN mattresses to correspond to individual sleeping needs.

Weight and height



Your weight and height help determine how firm your mattress should be. The lighter you are, the softer the mattress.

Sleeping position



We all have a favourite way of sleeping. Side-sleepers need a softer mattress to allow the shoulders and hips to sink in, while back-sleepers need the support of a firmer mattress.

Body shape



Broad-shouldered? Curvy? Weight and height don't give you the whole picture. Different bodies have different support needs, as well.

Temperature



The right sleeping temperature is essential to a good night's sleep. Some of our mattresses are constructed to be especially good at transporting heat and moisture away from the body.

Find your mattress match with our easy online guide

[IKEA.IE/MATTRESSES](https://www.ikea.ie/mattresses)

SULTAN HJARTDAL double sprung mattress €459 Pocket springs in 5 zones and a layer of memory foam provide very precise support for your body. 140×200cm. White. 801.566.86

SULTAN ATNA double mattress base €199 The springs provide support for your body. 140×200cm. White. 401.588.09 **SULTAN legs €13/4pk** Stainless steel. H20cm. 300.451.44

Sprung mattresses provide excellent ventilation and distribute weight evenly to avoid pressure on any one part of your body.



80cm 90cm 140cm 160cm 180cm

SULTAN HJELMÅS sprung mattress* €459
Pocket springs in 5 zones and a layer of latex provide a very precise support for your body. 160×200cm. White. 501.566.59
SULTAN ATNA mattress base €239
Legs are sold separately. 160×200cm. White. 201.588.10



80cm 90cm 140cm 160cm

SULTAN HEIDAL sprung mattress €599 Natural materials and active pocket springs provide very precise body support and relieve pressure on your shoulders and hips. 160×200cm. White. 901.109.90
SULTAN LAXEBY slatted bed bases €60/ea 80×200cm. Light grey. 801.099.11

Foam and latex mattresses cushion your movements and contour to your body. Many are divided into comfort zones for precise support.



90cm 140cm 160cm

SULTAN ENGENES latex mattress €499 18cm. thick layer of latex in 5 comfort zones provides good pressure-relieving capacity, enabling your body to relax more fully. 160×200cm. White. 901.399.79
SULTAN LAXEBY slatted bed bases €60/ea 80×200cm. Light grey. 801.099.11



80cm 90cm 140cm 160cm 180cm

SULTAN HAGAVIK sprung mattress €299 Active pocket springs provide very precise body support and relieve pressure on your shoulders and hips. 160×200cm. Light grey. 501.562.92
SULTAN AUKRA mattress base €199
Legs are sold separately. 160×200cm. Light grey. 201.587.73



80cm 90cm 140cm 160cm

SULTAN HJARTDAL sprung mattress €499 Pocket springs in 5 zones and a layer of memory foam provide a very precise support for your body. 160×200. White. 201.566.89
SULTAN LAXEBY slatted bed bases €60/ea 80×200cm. Light grey. 801.099.11



90cm 140cm 160cm

SULTAN FOSSING polyurethane foam mattress €439 High resilience foam in 5 zones, a layer of latex and natural materials provides good comfort. 160×200cm. White. 001.444.33
SULTAN LAXEBY slatted bed bases €60/ea 80×200cm. Light grey. 801.099.11



80cm 90cm 140cm 160cm

SULTAN HARESTUA sprung mattress €129
A layer of springs provide support for your body. 160×200cm. Dark grey. 001.565.86
SULTAN AKSDAL mattress base €79/ea
Legs are sold separately. 80×200cm. Dark grey. 001.588.54

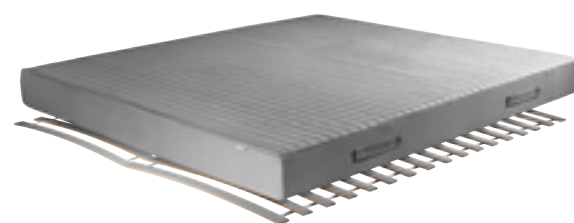

80cm 90cm 140cm 160cm

SULTAN HUGLO sprung mattress* €159
Springs and extra wadding provide support for your body. 160×200cm. Dark grey. 001.563.79
SULTAN LURÖY slatted bed bases €20/ea 80×200cm. Light grey. 301.602.09



90cm 140cm 160cm

SULTAN FÅVANG polyurethane foam mattress* €239 High resilience foam in 5 zones provides good comfort. 160×200cm. White. 301.444.36
SULTAN LURÖY slatted bed bases €20/ea 80×200cm. Light grey. 301.602.09

All mattresses featured on this spread are king-size.



Three things that will help you sleep better tonight

Try before you buy at the IKEA store

No amount of information beats trying out a mattress. So before you buy, come into the IKEA store for a lie-down. And relax. When you've made up your mind our delivery service can help you get your mattress home.

Your perfect match

Find your mattress match with our easy online guide [IKEA.IE/MATTRESSES](https://www.ikea.ie/mattresses)

90 days to decide

We want you to love your SULTAN mattress. So if, for any reason, you're not happy with your choice, we'll exchange it. And there's no rush. You have 90 days to sleep on it!

Try your **SULTAN** mattress at home for 90 days

It's important to us that you love your new SULTAN mattress. So, if after a while you discover that it's too firm, too soft, or too something else, just bring back the mattress and try out a new one*. And there's no rush. You have 90 days to feel comfortable with your decision! What's more, all our SULTAN mattresses come with a 25-year Everyday Quality Guarantee.



SULTAN has a
25-year guarantee.
Find out more on page 374.

*Excludes children's mattresses – SULTAN DRÖMMA, SULTAN SNARKA, SULTAN BLUNDA, SULTAN SUSSA and SULTAN SLUMRA. Terms and conditions apply. See in store or visit [IKEA.IE](https://www.ikea.ie) for details.

YOUR SPACE



LERBERG DVD/CD wall shelves
€4.99 /ea

fold hook when not in use

mobile cabinet

comfy sofa bed

The definition of freedom? A sofa bed! Ideal for when you're having an impromptu sleepover, or just hanging out with friends, it adjusts in seconds, ready for bedtime if your mates are staying. It's just one of our great ideas for transforming your room, and your social life. Pass the popcorn!



STORÅ loft bed frame
€239

loft bed = floor space

2

Make room for your friends at IKEA.IE/SPACEMAKER



3-in-1 cushion

3

1. IKEA PS LÖVÅS 2-seat sofa bed €350
2 cushions included. Easy to keep clean. Removable, machine-washable cover: 100% cotton. Sofa size 163x205, H86cm. Bed size 160x205cm. Boden dark blue. 598.301.38

BJÄRNUM folding hooks €10.90/3pk
Folding - saves space when not in use.

Nickel-plated aluminium. Designer: Sarah Grönvall. 3x8, H8cm. 601.525.90

LERBERG DVD/CD wall shelves €4.99/ea
Suitable for both CDs and DVDs. To be hung horizontally for CDs and vertically for DVDs. Powder-coated steel. 85x10, H16cm. Dark grey. 701.155.21

IKEA PS cabinets on castors €39/ea
Lock and key included. Lockable for safe storage and a bit of privacy. Powder-coated steel. Max. load 60kg. 60x40, H50cm. White. 200.866.82

VIKA FURUSKOG/VIKA FURUSUND table combination €123
Untreated wood. Can be treated with

oil, wax or glazing paint. Solid pine. 120x60, H72cm. 598.688.76

TORBJÖRN swivel chair €34.99
Polyester, cotton and powder-coated steel. Seat 40x43, H42-50cm. Alme black. 501.337.62

2. STORÅ loft bed frame €239
Be aware of the risk to young children

of falling from the upper bunk. The ladder mounts on the right or the left side of the bed. Takes mattress size 140x200cm. (Sold separately). Stained solid pine. 153x213, H214cm. Black. 001.608.66

MANDAL 6-drawer chest €159
Painted finish. 139x48, H79cm. Black. 001.212.62

3. KOMISK triple cushion cover €16.99
Three connected cushion covers. Combine with three pillows 65x65cm. to create a multi-functional cushion/seat. Takes three GOSA ASTER pillows 65x65cm. 100% cotton. 195x65cm. Black. 801.600.80



order + easy styling

ODDA wardrobe
€259

find-fast storage

FREDRIK workstation
€99

flexible workstation

1

So many things, so little space? Then this room idea might be for you. Space-saving storage boxes, hooks and shelves make tidying up, getting dressed and styled (and even having friends over) really simple.

- 1. VIPPA hooks €2.99/4pk**
 Aluminium. H10cm. 066.837.84

ODDA wardrobe combination €259
 6 shelves, 2 drawers and 1 clothes rail included. The bottom drawers have castors so they're easy to move about. Painted finish. 119x55, H200cm. Black/white. 901.205.74

KOMPLEMENT multi-use hanger €4
 Takes up as little space as a clothes hanger but can store 28 different accessories. Polypropylene. 43x85cm. White. 701.089.12

FREDRIK workstation €99
 Holds monitor up to 19". The table top can be mounted at different heights. Adjust according to need. Powder-coated steel and melamine foil. Max. load 50kg. 98x62, H149cm. White. 801.414.83

FREDRIK 11-piece workstation set €12.99
 Includes: 1 waste paper basket, 1 cable holder, 1 book end, 3 hooks (max. load 10kg.), 3 paper holders, 1 pen cup and 1 small storage cup. The items in the set can be attached to the workstation and moved around according to need. Polyester and plastic. Designers: W. Braasch/N. Cortolezzis. Red. 301.383.17
- 2. ODDA bed frame with headboard €99**
 Under the bed there is space for ODDA underbed, ideal as an extra bed. Painted finish. 97x207, H100cm. Takes mattress size 90x200cm. (Mattress and bed slats sold separately). White. 701.205.51

ODDA storage box on castors €49
 Can also be used as an extra seat and a table. Painted finish. 99x54, H36cm. White/black. 301.205.53

VÄNNA mirror €7.99
 Glass. 29x58cm. 901.601.74

Do it your own way at
IKEA.IE/SPACEMAKER



storage box = seat or table

2

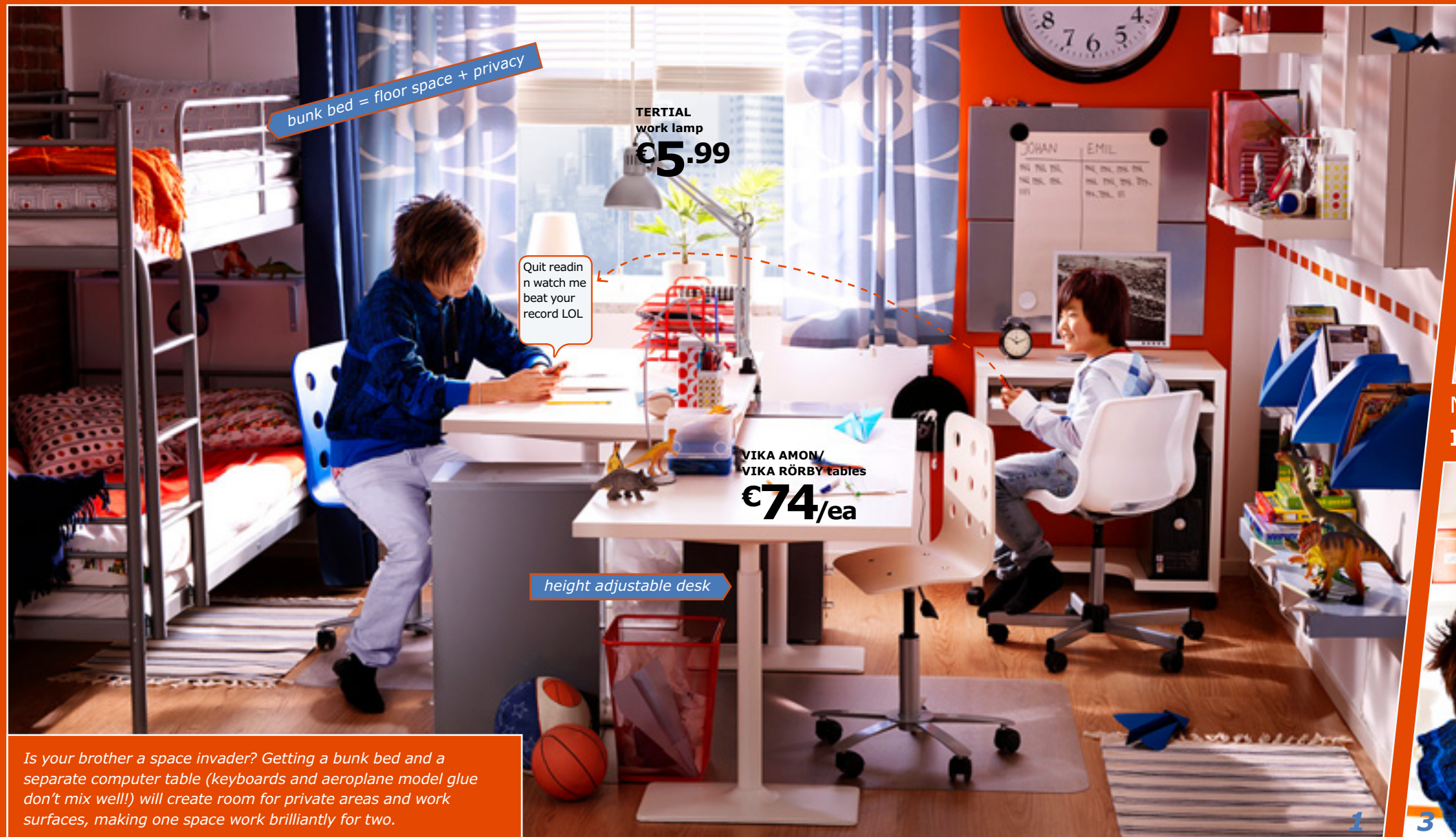

bunk bed = floor space + privacy

TERTIAL work lamp
€5.99

Quit readin
n watch me
beat your
record LOL

VIKA AMON/
VIKA RÖRBY tables
€74/ea

height adjustable desk

Is your brother a space invader? Getting a bunk bed and a separate computer table (keyboards and aeroplane model glue don't mix well!) will create room for private areas and work surfaces, making one space work brilliantly for two.



Make room for all YOUR stuff at
IKEA.IE/SPACEMAKER



ÄTRAN lockable
cabinets
€24.90/ea

1. TROMSÖ bunk bed frame €129
Powder-coated steel. 97×208, H159cm. Takes mattress size 90×200cm. (Sold separately). Silver colour. 600.502.90

JULES swivel chair €47.99
Painted beech plywood and powder-coated steel. Seat 44×42, H41–53cm. Blue/silver colour. 598.483.17

VIKA AMON/VIKA RÖRBY tables €74/ea
The trestle is adjustable to various heights between 60 and 75cm. Adjust according to need. Painted finish and powder-coated steel. 150×75, H60–75cm. White. 398.687.59

TERTIAL work lamp €5.99
Adjustable arm and head for easy

directing of light. Light source is sold separately. Lacquered steel. Max. 60W. Shade Ø17cm. Silver colour. 403.702.83

JULES junior desk chair €38.99
Painted beech plywood and powder-coated steel. Seat 35×32, H38–51cm. White/silver colour. 298.568.65

KOLON floor protectors €19.99/ea
Suitable for flat-woven rugs, and most types of flooring, except cork. Protects flooring against wear and dirt. Plastic. 120×100cm. 448.811.00

SNILLE swivel chair €24.99
Plastic and powder-coated steel. Seat 46×39, H39–51cm. White. 698.166.41

MIKAEL computer table with castors €39.99
Pull-out panel makes keyboard and mouse easy to reach. Painted finish. Max. load 25kg. 77×50, H76cm. White. 100.770.46

2. KASSETT range
Painted paperboard. Boxes with lids €6.99/2pk

28×35, H18cm. Orange. 501.505.15
Magazine files €5.99/2pk
10×25, H32cm. Orange. 401.505.11

3. ÄTRAN lockable cabinets €24.90/ea
The cabinet can be wall-mounted with the opening to the right or left. Powder-coated steel. 35×15, H45cm. White. 245.865.10

*Uh-ooh, I can hear you
Fluffy – stay away from
my beads!*

LUSY BLOM
cushions
€5.99/ea

for reading
and chilling out

styling corner

for homework and hobbies

EIDE single
bed frame
€49

Express yourself without breaking the bank – functional basics get along just fine with fun, decorative accessories that you can change whenever you like. After all, your very own space should work for you tomorrow, as well as today.



2

1

- 1. EIDE single bed frame €49**
Powder-coated steel. 95x205, H26cm. Takes mattress size 90x200cm. (Mattress and bed slats sold separately). Black/white. 301.609.59
- LUSY BLOM cushions €5.99/ea**
100% cotton. 65x30cm. Blue/multicolour. 301.518.27
- SLÄTTHULT decoration sticker €14.99**
Happy flowers. Self-adhesive: easy to fit onto smooth, clean and dry surfaces. Paper. 501.510.01
- LILL curtains €4.59/pair**
Can be cut to desired length: no hemming needed. 100% polyester. 280x300cm. White. 100.702.62
- VÄNNA mirror €39**
Mounting fittings included. Can be hung horizontally or vertically. Glass and powder-coated steel. 40x120cm. Red. 901.213.33
- PAX BALLSTAD wardrobe €90**
Melamine finish. 50x60, H236cm. White. 498.416.70
Knobs and handles are sold separately.
- SNILLE swivel chair €24.99**
Height adjustable for comfortable sitting posture. Plastic and powder-coated steel. Seat 46x39, H39–51cm. Yellow. 598.590.99
- SMÅDAL desk €69**
Foil finish. Designer: Carina Bengs. 90x54, H74cm. White. 301.417.77
- 2. BÄSTIS cat bed €12.99**
Easy to keep clean. Removable, machine-washable cushion. 100% polyester. Ø59, H16cm. Turquoise/light green. 901.342.22

Create your very own world at
IKEA.IE/SPACEMAKER

Energise yourself!



LUSY BLOM rugs €36.99/ea Polypropylene. 133x195cm. White/multicolour. 301.517.09

just add parents (not)

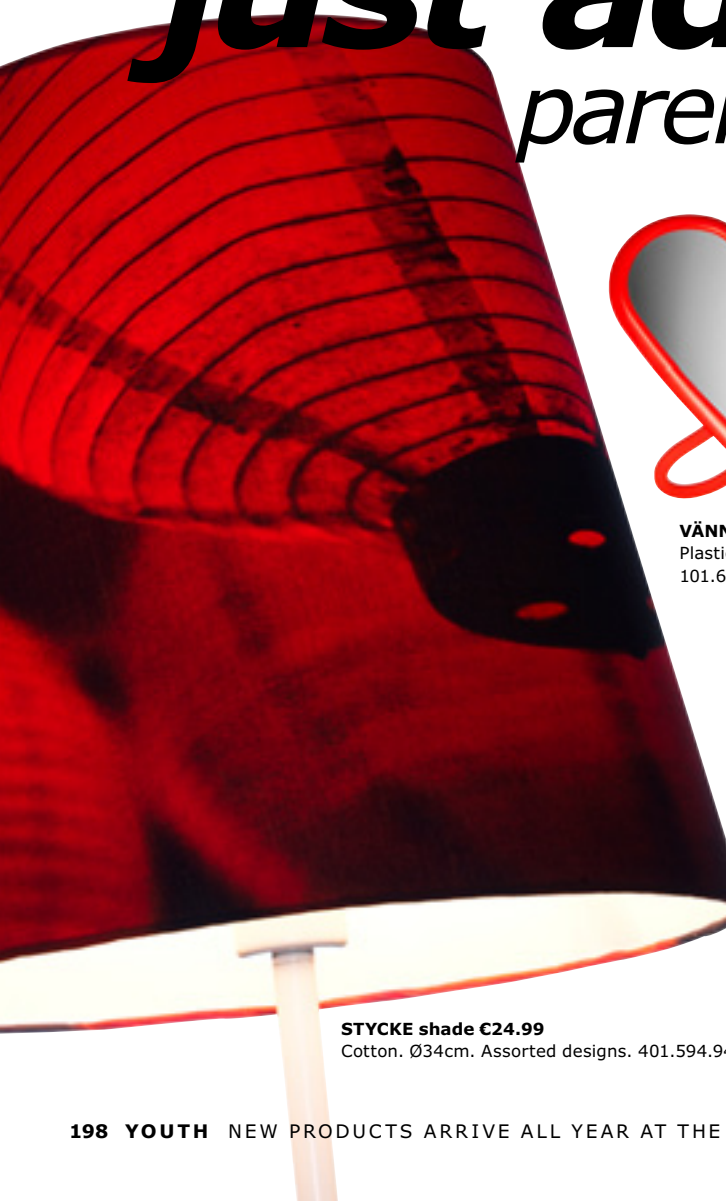

STYCKE shade €24.99 Cotton. Ø34cm. Assorted designs. 401.594.94



VÄNNA mirror €5.99

VÄNNA mirror €5.99 Plastic. 28x25cm. 101.601.73



Put a lid on it... for easy storage (and speedy tidying up :))

KNODD bin with lid €11.99 Steel. 16L. Assorted colours. 701.404.55



EVERT stool €3.99

EVERT stool €3.99 Plastic. Seat Ø24, H45cm. Green. 101.181.84

STACKABLE EXTRA SEAT

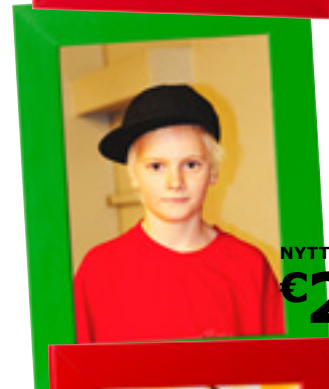
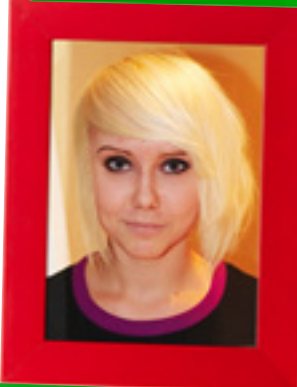

NYTTJA frames €2.99/2pk

NYTTJA frames €2.99/2pk Foil finish. 13x18cm. Assorted colours. 101.170.33

KVART floor lamp €16.99

KVART floor lamp €16.99 Steel. Max. 40W. Shade Ø8.5, H120cm. 201.523.99

SLÄTTHULT decoration stickers €14.99 Plastic and paper. 701.510.00

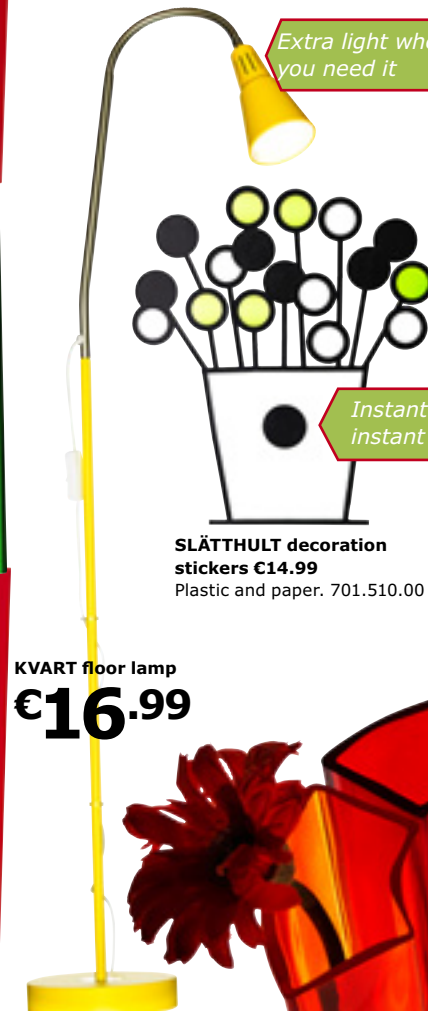

Extra light wherever you need it

Instant deco - instant style



KEEP AN EXTRA QUILT COVER AT HAND FOR SPONTANEOUS SLEEPOVERS...

LUSY VÄV single quilt cover set €6.99/3pcs Cotton. Quilt cover: 200x150cm. 2 pillowcases: 50x80cm. 601.492.58



SOMRIG vases €1.99/ea Several vases can be put together to form shapes, like a circle or a wavy line. Painted glass. H18cm. Pink/red. 001.510.51

LUSY bedspread/blanket €19.99

LUSY bedspread/blanket €19.99 100% polyester. 150x240cm. Green/yellow. 801.553.90





GRUNDTAL
glass shelves
€17.99/ea

GODMORGON 2-door mirror cabinets €299/ea
Foil finish and tempered glass. 100x14, H96cm. 601.476.45
GRUNDTAL glass shelves €17.99/ea
Stainless steel and tempered glass. 100x12cm. 001.485.82
GODMORGON/BRÄVIKEN 2-drawer washstand combination €499
Foil finish. 120x48, H90cm. 798.590.41
GRUNDTAL washbasin mixer tap with strainer €79/ea
Lacquered brushed finish brass. H25cm. 101.441.78

GODMORGON 2-drawer washstand with, BRÄVIKEN double washbasin and GRUNDTAL legs (excludes mixer taps)

€499

Bathroom

Turning morning rush hour
into quality time



1



2

LILLÅNGEN
single washbasin
€75

Tiny bathroom? Maybe. Room for all your stuff? Definitely.

Some things are hard to get your head around. Like the fact that the smaller the kids are, the more paraphernalia they seem to require. And that the smallest room in the house has to store rather a lot of it. How do you handle this? With LILLÅNGEN - small in stature but big on storage muscle, it makes the impossible possible. Now, you may not be able to get your head around that either, but you can take our word for it.

THIS PAGE:

1. ANORDNA LYX 3-piece pull-out storage unit set €14.99

Plastic. 40×37cm. White. 900.980.40

2. LILLÅNGEN single washbasin €75

Strainer and water trap are included. Towel hanger, soap dish and tray included. Coloured glazed fireclay. Stainless steel. 40×41, H13cm. White. 001.354.19

RIGHT PAGE:

LILLÅNGEN range

Foil finish. Stainless steel.

Mirror cabinet €49

Inside sized for ANORDNA interior fittings. 40×21, H64cm. White. 301.377.23

High cabinet €110

Shown with adjustable shelves. Adapt spacing according to needs. 1 shelf included. Interior fittings sold separately. 40×38, H194cm. White. 598.582.93

Washbasin cabinet €149

1 shelf included. Washbasin: coloured glazed fireclay. 40×41, H92cm. 498.585.71

LIDAN door-mounted storage €17.99

100% polypropylene. 30×100cm. 501.546.60

FÖRSIKTIG children's stool €1.99

Anti-slip protector on underside makes the stool stand steady.

Plastic. 37×24, H13cm. White/blue. 601.010.63

NÄCKTEN bathroom mat €1.69

Latex backing keeps the mat firmly in place. 100% polypropylene. 44×67cm. White. 700.756.38

RISTEN 4-piece set of boxes €4.49

100% polypropylene. 3 pieces 10×10, H10cm. and 1 piece 29.5×12, H9.5cm. White. 200.900.52

BÄSTIS hooks €1.99/ea

Made from soft rubber. H12cm. Assorted colours. 600.953.21

LIDAN door-mounted storage

€17.99

LILLÅNGEN high cabinet

€110



GODMORGON 2-drawer washstand with NORRVIKEN double washbasin and GRUNDTAL legs (excludes mixer taps)

€374

GODMORGON range - Full size for family traffic

A double washbasin in practically the same space as a single one! The result? Everyone gets the space they need, even in smaller bathrooms. Generous drawers with adjustable dividers embrace everything with open arms. From fluffy towels to make-up. All easy to find, easy to put away.



GODMORGON has a 10-year guarantee. Find out more on page 374.

GODMORGON mirror
€24.99

Finishes available

White	Birch	White/Black-Brown



LEFT PAGE:
GODMORGON/NORRVIKEN 2-drawer washstand €374
Handles included. Foil finish/solid birch. Polyester/crushed marble. Legs in stainless steel. 100x48, H85cm.
DALSKÅR washbasin mixer taps with strainers €69/ea
Chrome-plated brass gives a hard and durable surface that is easy to clean. H18cm. 801.441.65
GRUNDTAL glass shelf €17.99
Stainless steel. Tempered Glass. 100x12cm. 001.485.82

THIS PAGE:
1-6. GODMORGON range Birch veneer/solid birch. Tempered glass shelves.

1. Mirror €24.99
70x96cm. 301.501.11
2. High cabinet €169
Handle and hinges included. 40x37, H160cm. 401.475.33
3. Mirror cabinet €169
40x14, H96cm. 201.489.96
4. 2-door mirror cabinet €199
60x14, H96cm. 401.476.46
5. Wall cabinet €75
40x14, H96cm. 301.475.62
6. 2-door wall cabinet €89
60x14, H96cm. 101.475.63
7. GODMORGON/NORRVIKEN washstand with a drawer €309
Handle included. Birch veneer/solid birch. Polyester/crushed marble. Legs in stainless steel. 100x48, H85cm. 898.587.72

8. GODMORGON/NORRVIKEN 4-drawer washstand €454
Handles included. Birch veneer/solid birch. Polyester/crushed marble. Legs in stainless steel. 120x48, H85cm. 298.588.12
9. GODMORGON/BRÅVIKEN 2-drawer washstand €519
Handles included. Birch veneer/solid birch. Polyester/crushed marble. Legs in stainless steel. 140x48, H90cm. 198.588.60

Mixer taps sold separately.

GODMORGON buying guide on page 354. And so much more at the IKEA store.

LILLÅNGEN mirror cabinet combination

€69

LILLÅNGEN washbasin cabinet combination (excludes mixer tap)

€191

LILLÅNGEN range - The space ace

Stuff. Every bathroom's got it. Lots of it. And it has to go somewhere, whatever size your bathroom. Enter LILLÅNGEN, a bathroom giant in disguise. The LILLÅNGEN modular solution creates space while taking up next to none. It even gives you parking space around the basin for those items in constant daily use.

Finishes available



White



White/
Glass and
aluminium

LILLÅNGEN wall cabinet

€55

1



2



3



4

LILLÅNGEN high cabinet

€95



5



6



7



8



LEFT PAGE:

LILLÅNGEN washbasin cabinet combination C191

Includes door and 2 end units.
Coloured glazed fireclay.
60x41, H92cm. White. 098.586.05

DALSKÄR washbasin mixer tap with strainer C69

Chrome-plated brass.
H18cm. 801.441.65

LILLÅNGEN mirror cabinet combination C69

Includes door and 1 end unit.
60x21, H64cm. White. 998.582.72

LIDAN 4-piece basket set C9.99

Handmade. Each basket is unique.
100% polypropylene. 700.812.91

GRUNDTAL glass shelf C12.99

Tempered Glass. 60x12cm. 300.478.93

THIS PAGE:

LILLÅNGEN range Foil finish.

1. Wall cabinet C55

Tempered glass shelf. 60x21, H40cm.
White/aluminium. 001.378.33

2. Mirror cabinet C49

40x21, H64cm. White. 301.377.23

3. End unit C20

19x19, H64cm. White. 501.380.76

4. High cabinet C95

40x38, H179cm. Legs in stainless steel.

White/aluminium. 101.378.18

5. Washbasin cabinet C149

Coloured glazed fireclay.

Legs in stainless steel.

40x41, H92cm. Aluminium. 498.585.71

6. Washbasin cabinet combination C201

Includes door and 2 end units.

Coloured glazed fireclay.

Legs in stainless steel. 60x41, H92cm.

White/aluminium. 798.586.21

7. 2-door washbasin cabinet C193

Coloured glazed fireclay.

Legs in stainless steel.

80x41, H92cm.

Aluminium. 298.587.13

8. 3-drawer unit C94

Legs in stainless steel.

40x39, H79cm.

White/Aluminium. 998.585.35

Mixer taps sold separately.

i LILLÅNGEN buying guide

on page 355. And so much

more at the IKEA store.



FREDEN washstand with HÖLLVIKEN washbasin (excludes mixer tap)

€239



FLÄREN cabinet with door and drawer

€119



1

FREDEN washstand with HÖLLVIKEN washbasin €239
2 adjustable shelves included. Stained solid pine. Coloured glazed fireclay. 80×55, H89cm. Black-brown. 498.627.33
APELSKAR washbasin mixer tap with strainer €49.90
Chrome-plated. H10cm. 201.017.91

1. FREDEN washstand €120 80×52, H81cm. Black-brown. 201.411.84



2



3

2. FREDEN shelving unit €109 45×45, H143cm. Black-brown. 601.411.82
3. FREDEN mirror cabinet €79 2 adjustable shelves included. Tempered glass. 81×17.5, H62cm. Black-brown. 801.411.81

4. FREDEN wall cabinet €59 2 adjustable shelves included. Tempered glass. 45×17.5, H62cm. Black-brown. 901.411.85



4

FREDEN wall cabinet
€59



1

FLÄREN range Painted finish.
1. Washbasin cabinet €140 84×55, H78cm. White. 600.897.06
2. Cabinet with door and drawer €119 3 adjustable shelves included. Tempered glass door. 39×34, H126cm. White. 600.897.11
3. Wall cabinet €69 1 fixed shelf and 2 adjustable shelves included. Tempered glass door. 39×16, H74cm. White. 400.897.12



2



3



4



5

FLÄREN mirror cabinet
€79

4. Mirror cabinet €79 2 adjustable shelves included. 60×16, H74cm. White. 200.897.08
5. High cabinet €209 1 fixed shelf and 3 adjustable shelves included. Tempered glass door. 42×42, H198cm. White. 800.897.05

GRUNDTAL
door hanger

€6.99

1

2

GRUNDTAL
4-bar towel holder

€13.99

3

LILLHOLMEN
towel holder

€6.99

1. GRUNDTAL door hanger €6.99

Stainless steel. 39×11cm. 900.612.49

2. GRUNDTAL range Toilet roll holder €5.99

17×12, H3cm. 200.478.98

Glass shelf €12.99

Tempered glass. 60×12cm. 300.478.93

4-bar towel holder €13.99

Swivels to the left or right.
46×25cm. 600.478.96

3. LILLHOLMEN range

Lacquered stainless steel.

Glass shelves €17.99/ea

Tempered glass.
60×13cm. 400.741.69

Toilet brush €12.99

Interior plastic container is
easy to remove for cleaning.

Ø10, H46cm. 500.741.78

Cotton pad holder €6.99 601.494.04

Accessories stand €14.99

Ø20, H30cm. 101.493.93

Towel holder €6.99 501.493.86

Why pay more?

Good quality, function and low price

€7.99 / 2pk



Designed by:
Siggja Heimis

LIDAN toilet bags
100% polypropylene. 701.546.59





1

2

3

4

1. ALVINE LJUV king-size quilt cover set €39.99/5pcs
100% cotton.

Quilt cover 240×220cm.
4 pillowcases 50×80cm.
Multicolour. 601.596.24

2. ALVINE RUND curtains €24.99/pair

Thin, sheer curtains to let in daylight. 51% polyester, 49% cotton. 145×300cm. White. 801.602.02

3. ALVINE ÖRTER king-size quilt cover set €18.99/5pcs
100% cotton.

Quilt cover 240×220cm.
4 pillowcases 50×80cm.
Multicolour. 001.621.63

4. ALINA 3-piece bedspread and cushion cover set €69.99
100% cotton.

Bedspread 260×280cm.
Cushion covers 65×65cm.
White. 101.626.43

ALVINE ÖRTER king-size quilt cover set

€18.99 /5pcs

Textiles

Fresh colours and patterns.
Changing your tune has never been so simple

i See all ALVINE designs, sizes and colours at IKEA.IE/ALVINE

Bedroom boosters



MYSKMALVA
single quilt cover set
€4.99 /3pcs

- 1. MYSKMALVA single quilt cover set €4.99/3pcs**
52% polyester, 48% cotton.
Quilt cover 150×200cm.
2 pillowcases 50×80cm.
White/blue. 101.515.88
- 2. IKEA 365+ RISP single quilt cover set €25.99/3pcs**
50% lyocell, 50% cotton.
Quilt cover 150×200cm.
2 pillowcases 50×80cm.
Blue/white. 201.233.35
- 3. DVALA pillowcases €4.99/2pk**
100% cotton. 50×80cm.
Red. 401.499.71
- 4. IKEA 365+ RISP single quilt cover set €25.99/3pcs**
50% lyocell, 50% cotton.
Quilt cover 150×200cm.
2 pillowcases 50×80cm.
Red/white. 601.233.38
- 5. BEATA BLAD single quilt cover set €19.99/3pcs**

- 100% cotton.
Quilt cover 150×200cm.
2 pillowcases 50×80cm.
Orange. 101.458.04
- 6. BRUNKRISSLA single quilt cover set €15.99/3pcs**
100% cotton.
Quilt cover 150×200cm.
2 pillowcases 50×80cm.
Red. 200.398.03
- 7. DVALA single quilt cover set €11.99/3pcs**
100% cotton.
Quilt cover 150×200cm.
2 pillowcases 50×80cm.
White. 001.540.78

- 8. JORUN FORM single quilt cover set €7.99/3pcs**
100% cotton.
Quilt cover 150×200cm.
2 pillowcases 50×80cm.
Green/white. 201.457.09
- 9. ANDREA SATIN single quilt cover set €34.99/3pcs**
100% cotton.
Quilt cover 150×200cm.
2 pillowcases 50×80cm.
Beige/multicolour. 001.456.25
- 10. ANDREA SATIN single quilt cover set €34.99/3pcs**
100% cotton.

- Quilt cover 150×200cm.
2 pillowcases 50×80cm.
Purple/multicolour. 101.456.39
- 11. OFELIA TÅNG single quilt cover set €8.99/3pcs**
100% cotton.
Quilt cover 150×200cm.
2 pillowcases 50×80cm.
Grey/white. 501.317.96
- 12. BIBBI SNURR single quilt cover set €15.99/3pcs**
100% cotton.
Quilt cover 150×200cm.
2 pillowcases 50×80cm.
Blue. 901.242.18



DVALA single quilt cover set
€11.99 /3pcs

OFELIA TÅNG
single quilt cover set
€8.99 /3pcs



SIDE SLEEPER A high pillow allows you to lie straight and really relax.



BACK SLEEPER A medium height pillow gives the best support to your head and neck.



STOMACH SLEEPER Choose a low pillow to minimise muscle tension and pressure on your neck.



How did you sleep last night?

Whatever sleep position and bed temperature you prefer, there's a GOSA pillow and a MYSA quilt to meet your needs. Choose the shape and design to suit your preferences, and it's simple to set just the right comfort level for a good night's rest. Pick your favourites from the online quilts and pillows guide at [IKEA.IE/QUILTANDPILLOW](https://www.ikea.ie/quiltandpillow)

1. GOSA VIDE/KÄRNA pillow €38.99

For side sleepers. Filling: Polyurethane memory foam and 100% polyester microfibre. 50x80cm. 798.497.40

2. GOSA VÄDD pillow €6.99

For side sleepers. Filling: Polyester fibre balls. 50x80cm. 101.291.68

3. IKEA 365+ FAST pillow €24.99

For side/back sleepers. The high part of the pillow is specially designed for those who sleep on their side, while the low part

provides good support if you sleep on your back. 33x50cm. 301.316.03

4. GOSA SYREN pillow €12.99

For side sleepers. A high pillow for those who prefer sleeping on their side. Keeps your head, neck and spine aligned and straight, so you can relax. Filling: 100% polyester microfibre. 50x80cm. 501.312.06

5. GOSA SYREN pillow €10.99

For back sleepers. Filling: 100% polyester microfibre. 50x80cm. 701.312.05

6. GOSA VÄDD pillow €5.99

For back sleepers. Filling: Polyester fibre balls. 50x80cm. 501.291.47

7. GOSA KLÄTT pillow €5.99

For side/back sleepers. Filling: Polyurethane foam. 33x50cm. 101.252.93

8. GOSA SYREN pillow €8.99

For stomach sleepers. Filling: 100% polyester microfibre. 50x80cm. 701.311.73

9. GOSA VÄDD pillow €4.99

For stomach sleepers. A low pillow for

those who prefer sleeping on their stomach. Your neck will be bent less and strain on your muscles will be reduced. Filling: polyester fibre balls. 50x80cm. 001.252.60

10. GOSA SLÅN pillow €1.79

For stomach sleepers. Filling: Polyester fibres. 50x80cm. 301.253.05

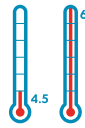

TOG RATING 4.5 OR 6 Perfect if you feel hot at night or sleep in a warm room. Thin, lightweight quilts with a TOG rating of 4.5 or 6 are the least warm.

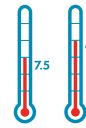

TOG RATING 7.5 OR 9 The medium warm quilts are good for those who want the feeling of a warm quilt but don't need extra insulation.

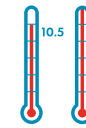

TOG RATING 10.5 OR 12 Our thick, warm quilts. Choose TOG rating 10.5 or 12 if you tend to feel chilly, or like to keep your room cool.

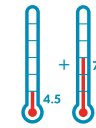

ALL SEASONS QUILTS, TOG RATING 4.5 + 7.5 One cool, thinner quilt and one warm, thicker quilt. Use them together or separately for three levels of warmth and year-round comfort.



MYSA GRÄS quilt, 4.5 TOG
€4.59



MYSA STRÅ quilt, 7.5 TOG
€15.99



MYSA STRÅ quilt, 10.5 TOG
€22.99



MYSA STRÅ quilt 4.5 + 7.5 TOG
€23.99

- 1. MYSA STRÅ quilt, 4.5 TOG €10.99**
Synthetic quilt with hollow fibre filling, giving it a soft and airy feel. Filling: Polyester hollow fibres. 901.314.26
- 2. MYSA RÖNN quilt, 6 TOG €19.99**
Filled with down/feathers which absorb and transport moisture away from the body. Filling: 85% duck feathers, 15% duck down. 150x200cm. 001.319.11
- 3. MYSA GRÄS quilt, 4.5 TOG €4.59**

- A thin, lightweight quilt for those who often feel warm and prefer a cool quilt. Filling: Polyester fibres. 150x200cm. 901.314.26
- 4. MYSA LJUNG quilt, 7.5 TOG €110**
Temperature-regulating inner fabric reacts to your body temperature to keep you comfortable during sleep. Filling: 50% modal, 50% polyester. 150x200cm. 801.318.46
- 5. MYSA VETE quilt, 7.5 TOG €47.99**

- Filled with down/feathers which absorb and transport moisture away from the body. Filling: 60% duck down, 40% duck feathers. 150x200cm. 401.319.14
- 6. MYSA STRÅ quilt, 7.5 TOG €15.99**
Synthetic quilt with hollow fibre filling giving it a soft and airy feel. Filling: Polyester hollow fibres. 150x200cm. 801.291.98
- 7. IKEA 365+ MYSA quilt, 12 TOG €44.99**

- Filling of 50% modal absorbs and transports moisture away to keep you comfy at night. Filling: 50% modal, 50% polyester. 150x200cm. 701.321.82
- 8. MYSA RÖNN quilt, 12 TOG €34.99**
Filled with down/feathers which absorb and transport moisture away from the body. Filling: 85% duck feathers, 15% duck down. 150x200cm. 101.313.88
- 9. MYSA STRÅ quilt, 10.5 TOG €22.99**
Synthetic quilt with hollow fibre filling

- giving it a soft and airy feel. Filling: Polyester hollow fibres. 150x200cm. 301.292.14
- 10. IKEA 365+ MYSA quilt, 4.5 + 7.5 TOG €60**
Filling of 50% modal absorbs and transports moisture away to keep you comfy at night. Filling: 50% modal, 50% polyester. 150x200cm. 501.321.97
- 11. MYSA VETE quilt, 4.5+7.5 TOG €75**
Filling with a high proportion of down gives a soft and warmth-insulating quilt. Filling:

- 60% duck down, 40% duck feathers. 150x200cm. 601.314.80
- 12. MYSA STRÅ quilt, 4.5 + 7.5 TOG €23.99**
Synthetic quilt with hollow fibre filling giving it a soft and airy feel. Filling: Polyester hollow fibres. 150x200cm. 301.292.28
- All quilts featured on this spread are single.*
- See all GOSA and MYSA styles, sizes and colours at [IKEA.IE/QUILTANDPILLOW](https://www.ikea.ie/quiltandpillow)

SKYDDA LÄTT
mattress protector

€3.59

1



2



4

SKYDDA HÖGT
mattress protector

€24.99

3



1. SKYDDA LÄTT mattress protector €3.59

Outer fabric: 52% polyester, 48% cotton.
Filling: polyester fibres.
90×200cm. 401.405.41

2. SKYDDA MJUK pillow protector €18.99

Outer fabric: 100% lyocell.
Filling: 100% polyester.
50×80cm. 501.442.61

3. IKEA 365+ SKYDDA pillow

protector €6.99 Cover: 55% lyocell,
45% cotton. Filling: 100% polyester.
50×80cm. 701.409.07

IKEA 365+ SKYDDA mattress protector €17.99 Cover: 100% cotton.
Filling: 100% polyester.

90×200cm. 101.483.36

4. SKYDDA HÖGT mattress

protector €24.99 Top: 80% cotton,
20% polyester. Polyurethane coating.
140×200cm. 601.527.74



SKYDDA MJUK pillow protector has a temperature regulating lining that keeps your head comfortable all night long. It will also shield your pillow from spills and wear for a long time.

Why pay more?

Good quality, function and low price

€6.99 / 3 pcs



Designed by:
Cilla Ramnek

LUSY VÄV single quilt cover set
100% cotton. Quilt cover 150×200cm.
2 pillowcases 50×80cm. Multicolour. 601.492.58



FLYN LILL
panel curtains

€2.59/ea

SARITA
curtains
€7.99/pair

FLYN BEATA panel curtains

€35/3pk

The best sort of window shopping

They make it easy to be eco-friendly, by reducing heat loss. And whenever you're ready for a new combination, it's simple to update with a different, functional and personal expression. Find more options to treat your windows at [IKEA.IE/CURTAINSANDBLINDS](https://www.ikea.ie/curtainsandblinds)

FLYN BEATA panel curtains €35/3pk Panel curtains that block out the sun, but let in light. Use with KVARTAL curtain hanging system. 100% polyester. 60x300cm. Multicolour. 801.490.64

FLYN LILL panel curtains €2.59/ea Thin, sheer panel curtains which let in daylight. Use with KVARTAL curtain hanging system. 100% polyester. 60x300cm. Assorted colours. 401.416.68

SARITA curtains €7.99/pair Thin, sheer curtains which let in daylight. 100% polyester. 145x300cm.

Dark lilac. 501.091.92 **SOLVEIG panel curtains €15/ea** Heavy material which reduces sound and sunlight, and ensures privacy. Use with KVARTAL curtain hanging system. 80% paper, 20% polyester. 60x300cm. Black. 101.602.86



LINDMON
Venetian blinds

€19.99/ea

The KVARTAL suspension system is creative enough to give you endless possibilities. The rails can be cut to size or connected piece by piece. Go around corners and create soft curves. Mount to the ceiling or to the walls, and combine up to six layers of panels and curtains.

LEFT PAGE:

1. KVARTAL suspension system Aluminium and steel.

Wall fittings €4/ea

Max. load 5kg. L14.5cm.

Aluminium colour. 801.646.86

Corner pieces €4/ea

Aluminium colour. 700.793.68

Draw rods €4/ea L110cm.

Aluminium colour. 100.793.66

Single track rails €6.99/ea

Max. load 5kg. L140cm.

Aluminium colour. 000.793.62

Top and bottom rails €6/pk

L60cm. Aluminium colour.

300.793.70

SOLVEIG panel

curtains €15/ea

80% paper, 20% polyester.

60×300cm. Green. 701.631.64

White. 601.625.27

LINDMON Venetian

blinds €19.99/ea Solid lime.

80×155cm. Natural. 600.843.51

RITVA curtains with

tie-backs €29.99/pair

Curtains that block out the sun,

but let in light. 100% cotton.

145×300cm. White. 800.638.33

RIKTIG hooks, gliders

and clips set €5.99

Galvanized steel. 001.541.44

Curved. Max. load 5kg.

401.437.66

Single track rails €6.99/ea

L140cm. 000.793.62

Corner pieces €4/ea

700.793.68

Ceiling fittings €3/ea

Max. load 5kg.

H2.5cm. 300.793.65

ALVINE STRECK curtains

with tie-backs €39.99/pair

Heavy material, reduces sound

and sunlight, provides privacy.

100% cotton. 145×300cm.

Beige/yellow. 801.602.21

LINDMON range

Solid hardwood. White.

Venetian blinds €54.99/ea

120×250cm. White. 400.843.33

Venetian blinds €29.99/ea

60×250cm. White. 900.843.35

2. ANNO TUPPLUR panel

curtains €10/ea

Panel curtain that block out

the sun, but let in light.

60% polyester, 40% cotton.

60×300cm. Beige. 700.781.42

DIVISION 12-piece

suspension set for panel

curtains €15.99 Aluminium.

Max. load 5kg. L130–230cm.

Silver colour. 301.151.13

THIS PAGE:

1. KVARTAL suspension

system Aluminium colour.

Single track rails €6/ea



See all KVARTAL designs and sizes at [IKEA.JE/KVARTAL](https://www.ikea.com/US/en/kvartal)



1



2

ANNO TUPPLUR
panel curtains

€10/ea



1

2

3

4

4

5

6

7

8

9

10

11

12

12

WILMA curtains

€11.99 /pair

LENDÅ
curtains

€19.99 /pair

LILL
curtains
€4.59 /pair

- 1. HEDDA BLAD curtains**
€14.99/pair 70% polyester, 30% cotton. 145×300cm. White/black. 601.174.84
- 2. SARITA curtains**
€7.99/pair Thin, sheer curtains that let in the daylight. 100% polyester. 145×300cm. Black. 501.454.30
- 3. LILL curtains** €4.59/pair
Thin, sheer curtains that let in the daylight. 100% polyester. 280×300cm. White. 100.702.62
- 4. WILMA curtains**
€11.99/pair 35% cotton, 65% polyester. 145×300cm. Bright red. 100.780.17
Bright green. 301.523.51
- 5. OFELIA BLAD curtains**
€24.99/pair Thin, sheer curtains that let in the daylight. 52% polyester, 48% cotton. 145×300cm. White. 801.355.52
- 6. IKEA STOCKHOLM BLAD curtains** €74.99/pair
55% linen, 45% cotton. 145×300cm. Green. 901.031.26
- 7. FELICIA curtains with tie-backs** €37.99/pair
Curtains that block out the sun's glare, but let in light. 100% polyester. 145×300cm. Orange. 801.416.66
- 8. LENDÅ curtains with tie-backs** €19.99/pair
Curtains that block out the sun, but let in light. 100% cotton. 140×300cm. Light blue. 000.901.14
- 9. ALVINE KOTTAR curtains** €39.99/pair
Curtains that block out the sun's glare, but let in light. 58% linen, 42% cotton. 145×300cm. White/grey. 401.602.18
- 10. RITVA curtains with tie-backs** €29.99/pair
Curtains that block out the sun's glare, but let in light. 100% cotton. 145×300cm. Grey. 101.564.87
- 11. JORUN LÖV curtains** €59.99/pair
100% cotton. 145×300cm. Multicolour/black. 801.437.50
- 12. MERETE curtains** €34.99/pair
100% cotton. 145×300cm. Purple. 401.209.82
Dark blue. 801.209.80



KAJSA
panel curtain
€12

1



ANITA curtains
with tie-backs
€44.99/pair

2



3



TUPLUR roller
blind
€13.99

4

The living daylights

It's easy to control incoming daylight to suit your room. Use a blind, and layer with curtains or panels to create your own style. You can update the room by changing these for a look whenever you like. See more window solutions at [IKEA.IE/WINDOWTEXTILES](https://www.ikea.ie/windowtextiles)

1. KAJSA panel curtain €12

100% polyester. 60×300cm.

White. 001.523.43

ANNO TUPPLUR panel curtain €10

60% polyester, 40% cotton.

60×300cm. White. 300.781.44

ENJE roller blind €24.99

Roller blind that filters the light. Reduces reflections on TV and monitor screens.

65% polyester, 35% nylon. 120×250cm.

Purple. 401.306.36

2. ANITA curtains with tie-backs €44.99/pair

Heavy material reduces sound and sunlight, and gives privacy.

Jacquard-woven, a technique which gives a decorative pattern.

100% polyester. 145×300cm.

White. 501.602.51

LINDMON venetian blind €29.99

The adjustable slats can be tilted, raised and lowered for full control of light,

sun and view. Available in several widths and lengths. Solid wood. 120×155cm.

Brown. 500.843.23

3. ALVINE FLÅTA curtains €9.99/pair

Thin, sheer curtains that let daylight in. 100% polyester.

145×300cm. White. 801.601.98

LUPIN Venetian blind €11.99

Solid paulownia wood. 100×130cm.

Natural. 201.175.13

4. KAJSA curtains €34.99/pair

Curtains that block out direct sun, but let in light. 100% cotton.

145×300cm. Grey/beige. 101.550.01

TUPLUR roller blind €13.99

Blackout blind. Special coating that does not let any light through. 100% cotton.

120×195cm. White. 600.495.17

GÅNGBAR 5-piece curtain rod set €22.99

See page 232.



BESKÅDA 6-piece
curtain rod set
€6.99

IRJA 5-piece
curtain rod set
€1.79

1. HÅVA 6-piece curtain rod set €34.99 Complete set with wall fittings, curtain rod and finials, ready to mount. Curtain rings are sold separately. Brush-finished nickel-plated steel. Max. load 5kg. L140cm. 001.448.62
2. LUMMIG 5-piece curtain rod set €15.99 Complete set with wall fittings, curtain rod and finials, ready to mount. Powder-coated steel. Max. load 5kg. L140cm.

White. 001.448.76 Black. 401.448.55
3. IRJA 5-piece curtain rod set €1.79 Complete set with wall fittings, curtain rod and finials, ready to mount. Powder-coated steel. Max. load 5kg. L140cm. White. 701.171.72
4. BESKÅDA 6-piece curtain rod set €6.99 Complete set with wall fittings, curtain rod and finials, ready to mount. Steel and aluminium. Max. load 5kg. L120–210cm. Black. 501.448.74

Also available in L210–385cm.
€10.99 701.693.16
5. GÅNGBAR 5-piece curtain rod set €22.99 Complete set with wall fittings, curtain rod and finials, ready to mount. Steel and aluminium. Max. load 5kg. L140cm. Natural. 301.448.70 Dark brown. 201.492.55
6. VÅGEN 6-piece curtain rod set €6.99 Complete set with wall fittings, curtain rod and finials, ready to mount. Curtain



DIGNITET
hanging system
€17.99



DEKA 15-piece curtain
wire & clips set
€2.99



8. DEKA 15-piece curtain wire rings are sold separately. Steel and Plastic. Max. load 5kg. L120–210cm. Silver colour. 901.448.72 Also available in L210–385cm **€10.99** 701.693.02
7. DIGNITET hanging system €17.99 Stainless steel. Max. load 5kg.
Corner pieces €3.50/ea 400.780.30
Curtain rings with clips €4.50/24pk 200.759.47
Curtain wire €9.99 L500cm. 600.752.95
8. DEKA 15-piece curtain wire
& clips set €2.99 Complete set with wall fittings, curtain wire and clips, ready to mount. Comprises: 1 curtain wire, 2 wall fittings and 12 clips. Clear lacquered nickel-plated steel. Max. load 5kg. L300cm. 200.793.42
9. TROLIG 13-piece curtain rod set €6.59 Complete set with curtain rod and curtain rings, ready to mount. Aluminium and rubber. Max. load 3kg. L80–120cm. Aluminium colour. 901.455.03

+
No drilling required here.
TROLIG curtain rod is spring
loaded and ready to be
mounted straight away.



CECILIA fabric

€2.59/m

ELISABET fabric

€7.99/m

1. SARALISA fabric €5.99/m
Comes in a choice of patterns.
100% cotton. W150cm.
Black/white. 801.539.75
Multicolour/orange. 501.539.72
White/black/green. 301.572.16

2. CECILIA fabric €2.59/m
Comes in a choice of patterns.
100% cotton. W150cm.
Grey/black. 901.509.19
White/orange/pink. 001.539.84

3. SY 7-piece start box €6.99
Contains basic sewing accessories:
a pair of scissors, sewing threads,
pins, needles, a seam picker
and a tape measure. 300.671.12

4. ELISABET fabric €7.99/m
Comes in a choice of patterns.
100% cotton. W150cm.
Multicolour/black. 301.545.00
Multicolour/orange. 101.545.01
Multicolour/pink. 801.544.99

5. TYGLÖSA stretcher frame €4.59
Create a unique piece of art,
by fixing your favourite fabric
to the frame. Fabric not included.
Solid pine. 50x50cm. 701.260.44

Why pay more?

Good quality, function and low price

€11.99 / pair

WILMA curtains

35% cotton, 65% polyester. 145x300cm.
Black. 801.241.29 Bright green. 301.523.51
White. 800.431.71 Bright red. 100.780.17

Enjoy a change of scene



ANJA cushion
€1.99

POLARVIDE throw
€3.59

RITVA
cushion cover
€4.99

KAJSA RAND cushion covers
€10.99 /2pk

IRMA throw
€1.99

- 1. LUSY BLOM cushion €5.59**
100% cotton. 30×65cm.
Blue/multicolour. 301.518.27
- 2. KAJSA VIRKA throw €26.99**
100% cotton. 130×170cm.
White/multicolour. 301.516.86
- 3. RITVA cushion cover €4.99** Zip. Cover is easy to remove for washing.
100% cotton. 50×50cm.
Black. 801.141.54
- 4. KAJSA TRÅD cushion cover €5.99**
100% cotton. 65×65cm.
Black/white. 401.516.81
- 5. ANJA cushion €1.99**
100% cotton. 30×45cm.
Multicolour. 801.454.19
- 6. POLARVIDE throw €3.59**
100% polyester. 130×170cm.
Green. 401.229.43
- 7. AINA cushion cover €4.99**

- Cotton/linen blend. Combines the softness of cotton with the lustre and body of linen. 55% linen, 45% cotton. 50×50cm. Light grey. 101.600.12
- 8. ALVINE LÖV cushion €19.99** Buttons. Cover is easy to remove for washing.
100% cotton. 50×60cm.
Grey/green. 601.785.90
- 9. KAJSA LINJE cushion cover €3.99**
100% cotton. 50×50cm.
Green/multicolour. 401.516.76
- 10. ALVINE RÖR cushion covers €9.99/2pk**
Yarn-dyed. The colours stay fast, wash after wash.
100% cotton. 40×60cm.
Green/grey/white. 101.599.47
- 11. ALVINE GÅVA cushion cover €3.99**
100% cotton. 50×50cm.

- Multicolour/red. 801.599.15
- 12. GRANAT cushion €2.99**
100% cotton. 50×50cm.
Red. 400.805.61
- 13. KAJSA RAND cushion covers €10.99/2pk**
Cushion covers in matching colours. 100% cotton.
50×50cm. Orange/multicolour. 201.516.77
- 14. IRMA cushion €0.79**
50% cotton, 50% polyester.
35×35cm. Light blue.
200.722.13
- 15. RITVA cushion cover €4.99**
100% cotton. 50×50cm.
White. 701.141.59
- 16. IRMA throw €1.99**
100% polyester. 130×170cm.
Light blue. 000.704.89
- 17. OFELIA BLAD**

- cushion €14.99**
Zip. Cover is easy to remove for washing. 75% cotton, 17% polyester, 8% nylon.
40×60cm. White. 601.786.27
- 18. ALVINE SNURR throw €23.99**
66% acrylic, 22% wool, 12% polyester. 130×170cm.
Off-white. 701.600.09
- 19. OFELIA VÅG cushion €12.99**
Cotton velvet with extra lustre and softness - nice and soft against the skin.
40×60cm. White. 601.786.32



Lovely to look at.
(And sit, lie or jump up and
down on...)

A rug is about more than just looks. It adds comfort and joy, somewhere nice to sit when all your friends are round, or have a lovely lie down when they've all gone home. It softens footsteps, and makes a room feel warm, even without the heating

ANDREA rug €199 Wool is soil repellent and hard wearing. 100% pure wool. Designer: Jon Eliason. 170x240cm. Yellow-green. 701.637.48 Also available: Purple. 301.637.50

IMFORS coffee table €95 Separate shelf for storing magazines, etc. Keeps your things organised, and the table top clear. Table top in painted finish. Nickel-plated steel legs. Ø80, H50cm. White. 501.036.99

OFELIA throw €23.99 80% acrylic, 12% wool, 8% polyester. 130x170cm. White. 301.396.23

ANDREA rug

€199



IKEA STOCKHOLM FIGUR rug

€349



IKEA STOCKHOLM FIGUR wool rug is hand knotted with Tibetan knots, making the rug extra long-lasting with natural variations in the structure.

THIS PAGE:

IKEA STOCKHOLM FIGUR rug €349

Top quality wool with beautiful sheen and lustre. Hand knotted. 100% pure new wool. 170×240cm. Multicolour/pink. 301.407.54

RIGHT PAGE:

1. HAMPEN rug €39.99

Machine woven. 100% polypropylene. 133×195cm. Green. 101.225.53

2a. LUSY BLOM rug €36.99

Heat-set polypropylene, makes the rug extra nice and soft to walk on. Can be completed with STOPP or STOPP FILT anti-slip/rug underlay for enhanced safety and comfort. 100% polypropylene. 133×195cm. Red/multicolour. 301.517.09



HAMPEN rug

€39.99

1



2a

2b

2



3

4



HEMMET rug

€119

2b. BELLINGE rug €10.99

Machine woven. 85% cotton, 15% polyester. 120×180cm. Red/multicolour. 201.532.66

3. ALVINE rug €149

Wool is soil repellent and hard wearing. Hand woven. 100% pure new wool. 170×240cm. Pink/multicolour. 201.596.78

4. HEMMET rug €119

Latex backing keeps the mat firmly in place. Machine woven. 80% wool, 20% nylon. 165×240cm. Dark orange. 301.520.11
For added safety complete your rug with **STOPP anti slip underlay** to use for tiled/wooden floors. 100% polypropylene. **€3.59** 65×125cm. 500.935.39
€8.99 165×235cm 700.935.38

STOPP FILT anti slip underlay to use on carpeted floors. 100% polyester **€3.99** 65×125cm. 101.322.60
€9.99 165×235cm 901.322.61

 See more rugs at at the **IKEA** store or at [IKEA.IE/RUGS](https://www.ikea.ie/rugs)

HOVEN rug

€29.99

1

2

KAJSA TRÄD rug

€115

3

1. HOVEN rug €29.99

Heat-set polypropylene. Makes the rug extra nice and soft to walk on.

100% polypropylene. 133×195cm. Beige. 501.385.85

2. KARBY rug €14.99 100% polypropylene. 133×190cm. Beige/brown. 800.940.47

3. KAJSA TRÄD rug €115 80% wool, 20% nylon. 140×200cm. Green/multicolour. 701.520.14

4. JORUN rug €34.99

100% polypropylene. 133×195cm. Black. 901.417.17

5. HULDA VILSE rug €29.99 100% polypropylene. 133×195cm. White/dark blue. 501.568.43

6. ALVINE RAND rug €149 100% pure new wool. 170×240cm. Grey/white/black. 101.682.87

7. KOLDBY cowhide €199 The hide will retain its natural

appearance and quality over a long time. Area 3.20–4.50sq.m. 101.572.17

8. IKEA STOCKHOLM rug €209 100% wool. 200×300cm. Black/grey. 801.407.56

9. ERSLEV rug €24.99 100% cotton. 140×200cm. Grey. 801.574.93

10. LUDDE sheepskin €24.99 Grey. 601.141.12

€29.99 White. 832.351.10



KOLDBY cowhide

€199



LUDDE sheepskin White

€29.99



JYLLINGE rugs
€8.99
 /ea



HELLUM rug
€54.99



Why pay more?
 Good quality, function and low price

€39.99
 /ea

1. TÄRNBY rug €85

Hard wearing. Hand woven.
 100% jute. 180x250cm. 600.501.72

2. DRAGÖR rug €29.99

Reversible, contrasting sides for variation.
 100% polypropylene. 140x200cm.
 Beige/light brown. 000.864.90

3. ERSLEV rug €24.99

Reversible, with two identical sides for even wear. 100% cotton. 140x200cm. White. 000.700.88

4. JYLLINGE rugs €8.99/ea

Choice of 3 rugs, each with a different colour combination. 100% cotton. 120x180cm. Assorted colours. 901.499.40
5. EGEBY rugs €47.99/ea 100% sisal. 133x195cm. Beige. 000.801.86
 Dark brown/natural colour. 101.005.27
 Light green/natural colour. 901.005.28
 Medium blue/natural colour. 301.105.92

6. HELLUM rug €54.99

Hand woven.

7. ALVINE RUTA rug €149

Wool is soil repellent and hard wearing. 100% pure new wool. 170x240cm. White/yellow. 501.682.85
VITTEN rug €95 Wool is soil repellent and hard wearing. Hand knotted. 100% pure new wool pile. 140x200cm. White. 800.849.20

HAMPEN rugs

100% polypropylene, latex. 133x195cm.
 Black. 001.241.52 Green. 101.225.53
 Red. 801.224.32 White. 301.225.52





SVÄVA swing €39.99

Swinging develops a child's sense of balance and coordination. It also brings a feeling of well-being and relaxation - big on endorphins! SVÄVA swing is recommended only for age 3 upwards. Different ceiling materials require different types of fixing devices, purchased separately. Use the ones suitable for the ceilings in your home. 100% polyester cover with steel frame. Ø92, H160cm. Black/red. 400.991.98

BARNSLIG PARK rug €15.99

100% nylon. 80x140cm. Black/white. 301.448.13

SVÄVA swing

€39.99

children's IKEA

Home is the biggest
bestest playground



1



2

SMILA BLOMMA
wall lamps
€6.49
/ea

When life is all about exploring, why go to bed and risk missing out on something fun? By making bedtime a special time, it should be easier to get your child's sleep routine right on track. Soft lighting for story time, their favourite cuddly toy, and a cosy bed could be all it takes. Who knows, you might even start nodding off yourself.

THIS PAGE:

1. VITAMINER range
Designer: Sirpa Cowell.
VITAMINER HJÄRTA quilt cover and pillowcase set €12.99/2pcs
100% cotton.
Quilt cover 150×200cm.
Pillowcase 50×80cm.
201.632.89

VITAMINER BLOMMA curtains with tie-backs €29.99/pair
52% cotton, 48% polyester.
120×300cm. 401.613.07
2. SMILA BLOMMA wall lamps €6.49/ea
Tamper-proof against inquisitive little fingers.
Polypropylene plastic.
Max. 25W. Ø34, D7.5cm.
Light pink. 400.979.48

RIGHT PAGE:

KURA reversible bed €139
Switched around, the bed quickly converts from a low bed to a high one. Bed-sides are reversible, allowing you to choose two different colours to change the look of the bed.
Solid pine. 99×209, H116cm.
Takes mattress size 90×200cm. (Mattress and bedlinen are sold separately.) 801.239.93

KURA bed tent €10
Fits KURA reversible bed only. 100% polyester.
100×150, H100cm.
Blue/white. 401.162.06
VITAMINER HJÄRTA rugs €4.99/ea
100% nylon. 67×64cm.
Pink. 101.626.00

EKBY VIKTOR shelves €3.99/ea
Brackets are sold separately. Foil finish.
Max. load 15kg. 75×28cm.
Blue. 101.674.76
Red. 201.679.61

EKBY STÖDIS brackets €1/ea
Suitable for 19cm. and 28cm. deep shelves.
Reinforced polypropylene plastic. 17×17cm.
Blue. 501.674.60
Red. 801.679.63

PATRULL corner bumpers €4.99/8pk
Reduce the risk of your child getting hurt on sharp edges. Easy to fit: simply stick on.
Plastic. White. 901.150.92



KURA reversible bed
with bed tent

€149

Child safety is invaluable, but it doesn't have to cost a fortune

When it comes to your children, there's nothing more important than their safety. That's why all IKEA children's products are tested to make sure they live up to the strictest safety standards in the world. So when deciding on SNIGLAR for your child, you can be sure you're choosing safety, while saving money.



THIS PAGE:
SNIGLAR cot
See below.

RIGHT PAGE:
SNIGLAR range
Solid beech.
Cot €49
The bed base can be placed at two different heights. 66×124, H80cm. Takes mattress size 60×120cm. (Sold separately). 001.157.51
Changing table €30
Easy to reach the storage underneath while keeping

one hand on your baby. 72×53, H87cm. 200.452.05
VITAMINER RAND 4-piece bedlinen set for cot €11.99
100% cotton.
Fits cot size 60×120cm. Multicolour. 601.613.25
SMILA BAGGE wall lamp €6.49
Gives a soft, mood light. Polypropylene plastic. Max. 25W. 32×23, H6.5cm. Green. 900.728.70

VITAMINER blanket €4.99
100% polyester. 90×90cm. Green. 801.647.66
LÄTTSAM 3-piece set of changing table storage boxes €7.99
Can be hung or used free standing. Polypropylene plastic. White. 701.032.07
NOGA under-cot storage €49
60×120cm. White finish. 101.284.23
KORALL mobile €5.99
ø20cm. Multicolour. 400.946.95

+

To keep pace with growing children, our cots can be set at two heights. As your child gets older and learns how to sit up, lower the bed base to minimise the risk of falling.



SNIGLAR cot
€49

SMILA BAGGE
wall lamp
€6.49



By having storage close by, you can keep a watchful eye, and a caring hand, on your baby at all times. Once they're out of the nappy stage, remove the changing top and the unit converts into a regular chest of drawers.

LEKSVIK range

Antique stained solid spruce.

Cot €95

The bed base can be positioned at two different heights.

One cot side can be removed when the child is big enough to climb into/out of the bed. 66x123, H83cm. Takes mattress size 60x120cm.

(Mattress and bedlinen are sold separately). 801.086.62

Changing table/chest €145

Can be modified as the child grows. The changing table converts easily into an ordinary chest of drawers.

86x58, H94cm. 198.425.34

High cabinets €129/ea

42x42, H184cm. 001.086.61

Wall shelf €29.99

90x19, H22cm. 201.086.60

FABLER bed canopy €12.99

A bed canopy gives privacy and creates a special den feeling which kids love.

Cotton/polyester. Ø50, H240cm.

Multicolour. 201.308.78

FABLER KAMRATER range

Beige.

Quilt cover & pillowcase set for cot €12.99/2pcs

100% cotton.

Quilt cover 110x125cm.

Pillowcase 55x35cm.

101.532.43

Curtains with tie-backs €22.99/pair

60% cotton, 40% polyester.

120x300cm. 201.532.33

Rug €18.99

100% cotton. 70x140cm.

401.532.46

FABLER mobile €9.99

Recommended from birth.

Polyester/cotton. Ø27cm.

Multicolour. 201.327.16



FABLER bed canopy
€12.99

LEKSVIK cot
€95

LEKSVIK changing table/cabinet
€145





1



2



3

LEKA baby gym
€24.99



4



5

FABLER 3-piece eating set
€10.99



6

ANTILOP highchair
€13.99



7



8

Play time, lunch time... and cuddle time!

1. BARNSLIG PARK mobile €4.99
Bold black and white pattern and figures that face down, to stimulate your child looking up at them. Recommended from birth. 100% polyester. Ø16cm. Black/white. 401.448.03
2. FABLER rattles €3.49/ea
Low sound level, adapted to sensitive baby ears. 100% polyester. Designer: Silke Leffler. L24cm. Orange. 201.572.93 Turquoise. 001.572.94

3. LEKA baby gym €24.99
Reaching out for toys develops your baby's hand-eye coordination. Birch plywood. 701.081.77
4. BARNSLIG muslin squares €3.99/3pk
Use as a towel or a washcloth, for the changing table or at mealtimes. 100% cotton. 70x70cm. Blue/green. 001.299.08
5. FABLER 3-piece eating set €10.99
The plate has a high edge, to make it

easier for your child to keep food where you want it, (not on the floor!) Melamine. Multicolour. 501.326.73
6. ANTILOP highchair with safety belt €13.99
Easy to disassemble and take on visits to friends. Plastic and powder-coated steel. 58x62, H90cm. White/silver colour. 000.697.25
7. VITAMINER blankets €4.99/ea
100% polyester. 90x90cm.

Green. 801.647.66 Pink. 501.647.63 Orange. 301.647.64 Turquoise. 001.647.65
8. BARNSLIG sleeping bag €10.99
Can be used anywhere, any time - when travelling, in the cot, whilst feeding, etc. - giving your child a familiar environment, wherever they are, whatever they're doing. Recommended for ages 0-6 months. Fabric: 100% cotton. Filling material: 100% polyester. L75cm. Pink. 801.505.52



**MAMMUT
bed frame**
€159



MAMMUT range
Painted finish and plastic.
Bed frame €159 89×170, H70cm. Takes mattress size 70×160cm.
(Mattress and bedlinen are sold separately). 198.374.91

Bedside table €19.99 48×39, H39cm. 900.991.67
Wardrobe €129 84×50, H186cm. Light blue/blue. 800.991.63
3-drawer chest €99 77×45, H73cm. Light blue/blue. 900.991.53

MAMMUT shelf unit
€89



MAMMUT range
Foil finish and plastic. Blue/light blue (Also available in pink/red).
Shelf unit €89
Versatile storage for big and small things such as toys, books, CDs, board games, storage. 77×34, H99cm. 601.175.68
Wall shelves €3.99/ea
Practical storage for small items. 33×21, H33cm. 800.991.77



**HENSVIK
storage unit**
€65

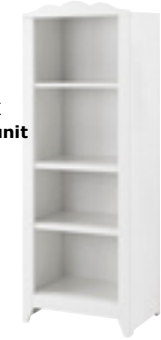

HENSVIK range
Solid beech. Painted and foil finish. White.
Cot €99 The bed base can be placed at two different heights. One bedside can be removed when the child is big enough to climb into/out of the bed. 66×123, H85cm.

Takes mattress size 60×120cm. (Mattress and bedlinen are sold separately). 701.160.02
Storage unit €65 60×41, H165cm. 100.747.07
Wardrobe €109 75×48, H169cm. 901.113.91
Cabinet with shelf unit €85 75×41, H161cm. 500.772.47



**LEKSVIK
wardrobe**
€199

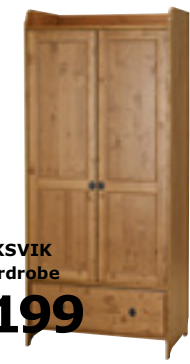

LEKSVIK range Antique stained solid wood.
Cot €95 The bed base can be placed at two different heights. One bedside can be removed when the child is big enough to climb into/out of the bed. 66×123, H83cm. Takes mattress size 60×120cm. (Mattress and bedlinen are sold

separately). 801.086.62
High cabinet €129 42×42, H184cm. 001.086.61
Wardrobe €199 80×50, H184cm. 201.086.36
2-drawer chest €119 89×41, H94cm. 101.086.51



TROFAST frame
94x44, H91cm

€69

TROFAST storage boxes
42x30, H10cm

€2/ea

TROFAST - The guardian of toys

Lots of toys need lots of looking after. So which candidate is ideal for the job? We recommend TROFAST – a flexible toy storage system made to even sit and play on, with different coloured boxes your child will love to choose from. Get to know TROFAST even better at IKEA.IE/TROFAST

TROFAST range Frames in solid pine or white foil finish. Storage boxes in plastic.

1. Frame €69
94x44, H91cm. Pine. 800.636.73

Storage boxes €2/ea
42x30, H10cm. Green. 600.940.72

Storage boxes €3/ea
42x30, H23cm. White. 956.851.00

Pink. 501.158.62 Red. 501.155.79

2. Frame €49 44x30, H176cm.
Pine. 200.636.66 **Shelves €10/2pk**
42x30cm. Pine. 700.635.84

Storage boxes €2/ea 42x30, H10cm.
Green. 600.940.72 White. 800.892.39

Storage boxes €4/ea 42x30, H36cm.
White. 200.892.42 Blue. 400.565.37

3. Frame €59
94x44, H52cm. Pine. 200.875.25

Storage boxes €4/ea 42x30, H36cm.
White. 200.892.42 Blue. 400.565.37

4. Frame €39
44x30, H91cm. Pine. 000.636.72

Storage boxes €2/ea
42x30, H10cm. White. 800.892.39

Storage boxes €4/ea
42x30, H36cm. Blue. 400.565.37

5. Frame €39
46x30, H179cm. White. 001.002.50

Storage boxes €2/ea 42x30, H10cm.
White. 800.892.39 Green. 600.940.72

Storage boxes €3/ea
42x30, H23cm. Pink. 501.158.62

White. 956.851.00 Red. 501.155.79

Shelves €8/2pk
42x30cm. White. 900.914.54

6. Frame €25 46x30, H94cm.

White. 300.914.52 **Storage box €2**
42x30, H10cm. White. 800.892.39

Storage box €3 42x30, H23cm.
Red. 501.155.79 **Storage box €4**
42x30, H36cm. White. 200.892.42

All boxes available with Lids
Lid €1 40x28cm. White. 574.545.00

We recommend that you fix the furniture to the wall with the safety brackets included, then it won't tip over when children clamber onto it.



EKORRE hanging seat
€28.99



RUSIG rocker
€8.99



Play is serious stuff

It's not all just fun and games. Play is how children learn, develop and become who they are. While children can play with almost anything, our toys are safe, durable and specifically designed to spark creativity. So you can watch your child grow, and enjoy peace of mind.

LEFT PAGE:

1. KRITTER range Painted solid rubberwood and plastic.
Children's chairs €14.99/ea
 27×29, H53cm.
 Blue. 001.537.00
 White. 401.536.99
Children's table €23.99
 59×50, H50cm.
 Blue. 401.537.03

2. EKORRE hanging seat €28.99
 Swinging develops balance and coordination. It makes the kids feel good, too! Recommended for age 3 and upwards. To be completed with SAGOSTEN air element. 100% polyester. Rope length 2m. Silver colour. 198.093.51
3. RUSIG rocker €8.99
 Rocking helps develop a child's sense of balance, and apparently helps the brain to sort sensory impressions. Recommended from age 18 months. Plastic and synthetic rubber. 79×39, H33cm. Black. 801.316.29

4. LEKSVIK range

Painted solid rubberwood.
Children's table €39.99
 Ø70, H50cm. White. 401.391.61
Children's stool €9.99
 25×25, H30cm.
 White. 801.392.77
Children's chairs €13.99/ea
 29×29, H59cm.
 Red. 601.477.06

THIS PAGE:

IKEA PS LÖMSK swivel armchair €49.99
 100% polyester and plastic. 59×62, H75cm. White/blue. 401.002.53
SPARKA soft toy football €3.79
 100% polyester. Ø20cm. 401.244.09



IKEA PS LÖMSK swivel armchair
€49.99



Pull down the hood and block out the world - it's fun and a great way for children to relax. And with a swivel chair, children also get to improve their balance and coordination.



1



2

DUKTIG 10-piece
tea/coffee set
€9.99



3

MÅLA easel
€17.99



4



6

MÅLA felt-tip
pens/stamps
€1.09/6pk



5

DUKTIG 7-piece baking set
€10.99



7

TITTA FOLK
finger puppets
€4.99/10pk

1. DUKTIG range

Encourages role play. Children develop social skills by imitating grown-ups and inventing their own roles.

16-piece cutlery set €5.99

Miniature cutlery for play. Comprises 4 forks, knives, spoons and teaspoons. Stainless steel with rounded edges. 601.301.69

Glasses €3.99/8pk

Miniature drinking glasses and goblets for

play. Made of durable plastic. 401.301.70

Plates/bowls €9.99/12pk

Miniature dinner plates and deep plates for play. Made of stoneware. 701.301.64

2. DUKTIG 10-piece coffee/tea set €9.99

Recommended for age 3 upwards. Stoneware. Multicolour. 901.301.63

3. MÅLA easel €17.99

Folds flat. Space-saving when not in use. Recommended for age 3 upwards.

Only use whiteboard markers on the whiteboard. May be completed with MÅLA drawing paper roll. Solid pine. 43x62, H118cm. White. 500.210.76

4. FABLER KO soft toy €4.99

All soft toys are good at hugging, comforting and listening and are fond of play and mischief. In addition, they are reliable and tested for safety. Recommended from birth. 100% polyester. L40cm. Black/white. 101.327.45

5. DUKTIG 7-piece baking set €10.99

Encourages role play. Children develop

social skills by imitating grown-ups and inventing their own roles. Recommended for ages from 3 years. Aluminium, steel and solid wood. 201.301.66

6. MÅLA felt-tip pens/stamps

€1.09/6pk Felt-tip pen and stamp in one. Recommended for age 3 upwards. L18cm. Assorted colours. 200.848.62

MÅLA paint/draw storage €8.99

Combined holder for paper roll, pens and paints. Place on a level surface. Recommended for ages 3 upwards. Solid pine. 58x18, H21cm. 101.493.50

7. TITTA FOLK finger puppets €4.99/10pk

One size. Suitable for any puppeteer in the family. 10 different dolls - one for each finger. 100% polyester. 901.592.79



1



2

VITAMINER BIL
rug
€4.99



3



5



6

VITAMINER HJÄRTA
rug
€4.99



7

**1. FABLER KROKODIL
soft toy €8.99**

100% polyester.
L60cm. 001.442.06

2. VITAMINER BIL rug €4.99

100% nylon. 50x90cm.
Blue/green. 701.625.98

**3. BARNSLIG DJUR
cushions €5.99/ea**

100% polyester. 43x43cm.
Blue. 401.101.29

**4. VITAMINER VIMPEL
blanket €12.99**

100% polyester. 120x180cm.
Multicolour. 901.613.24

**5. FABLER GRODA
soft toy €2.99**

100% polyester. L28cm.
Green. 201.414.00

**6. VITAMINER HJÄRTA
rug €4.99**

100% nylon. 67x64cm.
Pink. 101.626.00

**7. VITAMINER range
100% cotton.**

**VITAMINER TRUMMA
quilt cover and pillowcase
set for cot €6.99/2pcs**

Quilt cover 110x125cm.
Pillowcase 55x35cm. 001.613.28

**VITAMINER VIMPEL
quilt cover and pillowcase
set €9.99/2pcs**

Quilt cover 150x200cm.
Pillowcase 50x80cm. 601.613.11

**VITAMINER BIL
quilt cover and pillowcase
set €12.99/2pcs**

Quilt cover 150x200cm.
Pillowcase 50x80cm. 901.613.00

Why pay more?

Good quality, function and low price

€59.99

TROFAST storage combination with boxes

Foil finish and plastic. 99x44, H56cm.
White/blue. 498.613.90



JULES junior desk chair €38.99
Painted finish, powder-coated steel. Seat 35×32, H38–50cm.
White/silver colour. 298.568.65
VIKA AMON/VIKA ALEX table combination €152.50
Foil finish. Designer: Johanna Asshoff. 200×60, H73cm.
White. 498.652.70
BRÅDA laptop support €11.99
Plastic top, 100% cotton cover.
51×38, H8cm. Black/grey. 601.157.91

BRÅDA laptop support
€11.99

Workspaces

Work, surf or play
in total comfort,
anywhere you want to.

No room for a workspace?
Think again...



THIS PAGE:
ALVE desk €249
Drawer for keyboard and mouse, saves space on your desk. Stained solid pine. 152x65, H74cm. Black-brown. 401.365.96

GREGOR swivel chair €79
Height adjustable for comfortable sitting position. Unbleached paper and powder-coated steel. 100% cotton cover. Seat 45x47, H42-53cm. Blekinge white. 401.363.46

RIGHT PAGE:
ALVE laptop table €69
Table with work surface and storage inside for a laptop. Turns any small space into a functional workspace. Holds laptops up to 17". Stained solid rubberwood. Powder-coated steel. Designer: Karl Malmvall. H60-72cm. Black-brown. 901.486.29

ALVINE LÖV cushion €19.99
Buttons. Cover is easy to remove for washing. For best results, iron on the

embroidered side while still damp. 100% cotton. 50x60cm. Grey/green. 601.785.90

EKBY JÄRPEN/EKBY STILIG wall shelves €28.99/ea
Painted finish. 119x28, H34cm. White. 198.703.48

FORSÅ work lamp €19.99
Nickel-plated steel. Max. 40W. Shade Ø12, H50cm. 101.467.66

EKTORP BROMME footstool €125 See page 47. 298.492.76

+

The laptop table has a flip-open top that increases the work surface when you need it, but folds down for use as a side table.



A complete
workspace for
under
€180

**1. EXPEDIT desk
combination €125.99**

Comprises: EXPEDIT desk,
EXPEDIT book shelf and
EXPEDIT door insert.
Printed and embossed finish.
Designer: Tord Björklund.
154×79, H149cm.
Walnut effect. 298.703.43

2. SNILLE swivel chair €24.99

Height adjustable for comfortable
seating position. This chair is
tested and approved for home use.
Plastic/powder-coated steel.
Seat 46×39, H39–51cm.
White. 698.166.41

**3. DOKUMENT letter
tray set €9.99**

Compartments pull out for easy
access. Powder-coated steel.
29×35, H25cm.
Orange. 801.532.49

**4. STRIKT 4-piece
desk set €8.49**

Comprises: 1 box for paper,
1 pencil-box and 2 memo
boxes. Paperboard and cotton.
26×16, H7cm. Dark red. 201.666.45

5. MIL work lamp €8.99

Halogen bulb included.
Extra bulbs are available.
The lamp must be placed
at least 20cm. from other objects,
as halogen bulbs get very hot.
Painted steel and plastic.
Max. 25W. Shade Ø9, H40cm.
White. 201.338.10



1



2



3



4



5

€178.45





GALANT table combination
€175

GALANT - The shape-shifting desk range that can grow to fit the job

For a professional quality office at home, start with a desk in a shape that suits the way you work. Add legs which can be adjusted to the height you like to sit at, and some smart storage for the things you need nearby. As your needs grow, just keep adding.



GALANT has a 10-year guarantee. Find out more on page 374.

GALANT left-hand corner desk
€199



GALANT desk
€99



LEFT PAGE:

- GALANT table combination €175**
Tempered glass. Powder-coated steel. Designer: Olle Lundberg. 160×91, H60–90cm. White. 998.692.18
- GALANT drawer unit on castors €119**
Foil finish. 46×62, H63cm. White. 301.379.21
- KLÄPPE swivel chair €289**
See page 278

THIS PAGE:

- 1–9. GALANT range**
- 1. Left-hand corner desk €199**
Foil finish. Powder-coated steel. 160×120, H60–82cm. White/silver colour. 698.521.15
- 2. Conference table €179** Birch veneer.

Powder-coated steel. 195×110, H60–90cm.

Birch veneer/silver colour. 598.628.60

3. Right-hand corner desk €229

Birch veneer. Powder-coated steel.

160×120, H60–82cm.

Birch veneer/silver colour. 298.070.35

4. Left-hand desk €290

Oak veneer. Powder-coated steel.

200×160, H60–82cm.

Silver colour. 398.074.69

5. Desk €664

Stained ash veneer/solid beech. Powder-

coated steel. 300×200cm, H60–82cm.

Black-brown/silver colour. 298.612.06

6. Desk with drawer €227

Tempered glass. Chrome-plated steel.

160×80, H60–90cm. Black. 398.628.56

7. Left-hand corner desk €229

Stained ash veneer/solid beech.

Powder-coated steel. 160×120, H60–82cm.

Black-brown/silver colour. 198.369.67

8. Desk €99

Foil finish. Powder-coated steel.

160×80, H60–90cm. White. 698.577.64

9. Desk €175

Stained ash veneer/solid beech.

160×80, H60–82cm.

Black-brown/silver colour. 398.370.13

i GALANT buying guide on page 353. And so much more at IKEA.IE/GALANT



EFFEKTIV – Until you go 100% paperless, we suggest you get 100% better storage

EFFEKTIV storage gives you a place for everything, so you can get on with the job at hand. With a wide range of base units, frames, fronts, doors, legs and interior fittings, you can create a storage system that fits your needs, in the space you have available. Its coordinating materials and colours make it the perfect partner to the GALANT desk range.



EFFEKTIV has a 10-year guarantee. Find out more on page 374.



1



2



3



4



5



6

EFFEKTIV storage combination

€355



7



8



9

EFFEKTIV storage combination

€205



LEFT PAGE:

EFFEKTIV range Birch veneer. Handles sold separately.

Storage combinations €175/ea 85×43, H94cm. 298.666.28

Storage combination €820 Tempered glass. Aluminium. 170×43, H174cm. 298.707.67

SKIMRA/JANUARI table lamp €21.98 See page 326

THIS PAGE:

EFFEKTIV range Handles sold separately.

1. Storage combination with glass-doors €810 Birch veneer. 170×43, H174cm. 198.628.62

2. Storage combination with cabinets €215 Foil finish. Tempered glass. 85×43, H94cm. White/glass. 998.629.38

3. Storage combination with doors €100 Foil finish. 85×43, H94cm. White. 398.504.86

4. Storage combination/base with supporting legs €325 Birch veneer. 85×43, H134cm. 898.371.62

5. Storage combination on legs €245 Tinted beech veneer. Plastic. 85×43, H94cm. 598.520.93

6. Storage combination €205 Stained ash veneer. Aluminium. 85×43, H94cm. Black-brown. 198.310.93

7. Storage combination €355 Stained ash veneer. Aluminium. 85×43, H94cm. Black-brown. 098.647.48

8. Storage combination on legs €340 Oak veneer. Aluminium. 170×43, H94cm. 398.377.15

9. Roll-front storage cabinet €350 Birch veneer. Aluminium. 85×43, H134cm. 898.647.49

 **EFFEKTIV buying guide on page 352.** And so much more at IKEA.IE/EFFEKTIV



SIGNUM
charging station
€8.99

1



2



3

ASPVIK roll-front
computer cabinet
€199

4



5

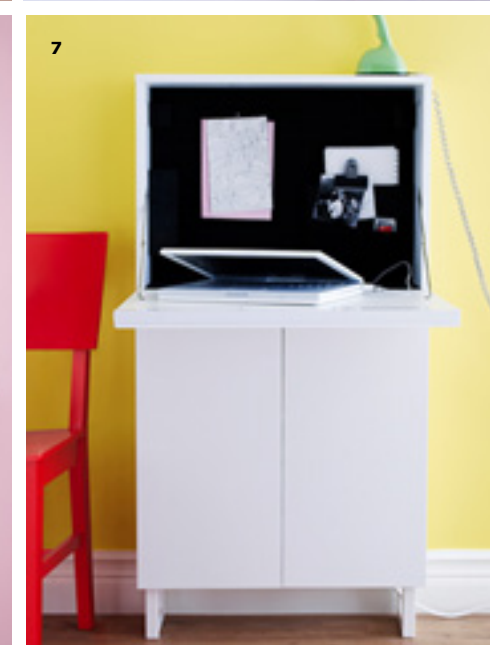

7



8

BRÅDA
laptop support
€3.49

Easy ways to stay connected

1. SIGNUM charging station €8.99

Inside compartment for storing cables, chargers and sockets out of sight but close at hand. Plastic. Designer: Marcus Arvonen.

36×28, H25cm. White. 501.382.98

2. DAVE laptop table €22.99

Adjustable height and angle of inclination of table top, to suit your seating arrangements.

Powder-coated finish. Max. load 6kg. 60×50, H60-72cm. Black. 001.208.18

3. BESTÅ BURS range Foil finish.

Designer: Mikael Warnhammar.

Desk €229

180×40, H74cm. Red. 201.473.55

Wall shelf €120

Max. load 35kg. 180×26, H26cm. Red. 701.037.59

SKRUVSTA swivel chair €119

See page 278.

FORSÅ work lamp €19.99

See page 326.

4. ASPVIK roll-front computer cabinet €199

Pull-out shelf serves as a

work surface for keyboard and mouse or as storage space at a different height. Foil finish. 60×60, H175cm. White. 501.540.47

5. GUSTAV laptop table €129

Table with a pull-out work surface and storage for your laptop. Turns any small space into a functional workspace. Birch veneer/solid birch. 128×43cm. 501.155.98

6. IKEA PS laptop workstation €45.99

Powder-coated steel. Max. load/open front 25kg. 70×20, H58cm. White. 101.391.34

7. LUDVIG laptop workstation €109

Foil finish. Designers: C. Halskov/H. Dalsgaard. Max. load/open front 10kg. 60×19, H117cm. White. 401.461.71

8. BRÅDA laptop support €3.49

Retaining edge keeps laptop in place. Plastic. Designer: Sarah Grönvall. 42×31, H9cm. Black. 601.501.76



Choosing the right work chair is easier than you think

Although it does require a little thought. Think about the different things you'll be busy doing when you're sitting on the chair - typing, drawing? And how much time you'll spend on them. A basic height-adjustable chair offers all the comfort you'll need for shorter periods of time. But for full-time work, you may want to vary sitting positions. Make your perfect choice at the store, or by visiting IKEA.IE

THIS PAGE:

MARKUS swivel chair C149
Cover: leather look and 100% polyester. Seat 53x47, H40-51cm. Black. 201.031.01

RIGHT PAGE:

- 1. TORBJÖRN swivel chair C34.99**
Seat cover: 100% cotton. Back cover: 100% polyester. Seat 40x43, H42-50cm. Alme red. 901.451.93
Alme black. 501.337.62
- 2. SNILLE swivel chair C24.99**
Plastic. Seat 46x39, H39-51cm. Yellow. 598.590.99
- 3. RUTGER/JULES swivel chair C72.99**
100% polyurethane, 100% cotton. 41x41, H42-54cm. Black/silver colour. 198.425.05
- 4. JULES swivel chair C47.99**
Painted beech plywood. Seat 44x42, H41-53cm. Blue/silver colour. 598.483.17
- 5. RICKARD swivel chair C22.99**
Cover: 100% cotton. Reinforced polyamide plastic. Seat 42x38, H43-58cm. Ransta dark grey. 901.426.94
- 6. NOMINELL swivel chair C99**
Cover: 100% cotton. Seat 43x44, H41-51cm. Hult black. 800.748.41
- 7. KARSTEN swivel chair C75**

- Leather look. Cotton seat cover. Seat 51x47, H40-52cm. Henån black/black. 901.224.98
- 8. KLEMENS swivel chair C65**
Cover: 100% cotton. Seat 45x47, H45-59cm. Alme red. 101.455.02 Arms available in **€8.99** Black. 401.478.11
 - 9. SKRUVSTA swivel chair C119**
Cover: Leather look, 100% cotton. Seat 48x45, H47-55cm. Idhult white. 800.731.77
 - 10. VERNER swivel chair C79**
Cover: leather look. Seat 52x47, H43-54cm. White. 101.638.93
Black. 701.638.90
 - 11. KLÄPPE swivel chair C289**
Height adjustable seat and backrest for maximum support regardless of body height. Cover: leather look. Seat 44x37-54, H40-52cm. Black/silver colour. 100.703.61
 - 12. JERRIK swivel chair C239**
Cover: 100% wool. Seat 48x47, H39-51cm. 001.426.84
 - 13. VERKSAM swivel chair C199**
Cover: 100% wool. Seat 45x40-53, H39-51cm. Ultuna dark blue. 300.748.53
Arms available **€25** 200.139.97
 - 14. MARKUS swivel chair C149**
Cover: leather look and 100% polyester. Seat 53x47, H40-51cm. Black. 201.031.01

BASIC These height-adjustable chairs are designed for basic comfort when you're only sitting for a few hours at a time.



ADJUSTABLE These chairs have more adjustable features for a healthier workspace at home.



OFFICE APPROVED These highly ergonomic chairs have several adjustable features and are approved for office use.



All of our office-approved chairs have a 10-year guarantee. Find out more on page 374.



VIKA GLASHOLM/VIKA LINDVED table combination

€79

How to build VIKA

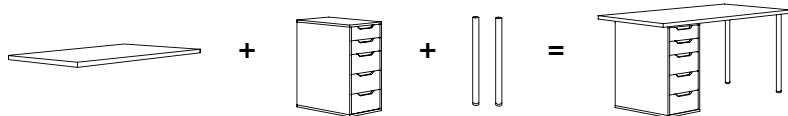

VIKA - Design your own table

Create a workspace that suits your needs, style and budget with the VIKA table bar. Just choose your preferred table top, and complete it from a wide range of legs and storage units. Find your favourite among the many combinations possible at IKEA.IE/VIKA

VIKA BLECKET/VIKA ARTUR table combination

€129



LEFT PAGE:

VIKA GLASHOLM/VIKA LINDVED table combination €79 Plastic feet protect the floor against scratching. Tempered glass. Powder-coated steel. Designers: C. Abild Jessen/K. Malmvall. 150×80, H70cm. Glass/black. 798.656.31

TORBJÖRN swivel chair €34.99 Seat cover: 100% cotton. Back cover: 100% polyester. Seat 40×43, H42–50cm. Alme red. 901.451.93

FORSÅ work lamp €19.99 Adjustable arm and head for easy light direction. Steel. Pigmented powder coating. Max. 40W. Shade Ø12, H50cm. 101.467.66

THIS PAGE:

1. VIKA GRUVAN/VIKA FAGERLID table combination €149 Tempered glass. Painted and foil finish. 140×70, H72cm. Glass/white. 498.521.35

2. VIKA BLECKET/VIKA ARTUR table combination €129

Adjustable to different positions for flat or angled table top. High-pressured melamine laminate. Tempered glass. Solid birch. 150×75, H71–93cm. White/birch. 998.629.57

3. VIKA AMON/VIKA ANNEFORS table combination €90

Printed and embossed, painted finish. 150×75, H70cm. Black-brown/white.

398.713.99

4. VIKA FURUSKOG/VIKA FURUSUND table combination €123

Untreated wood. Can be treated with oil, wax or glazing paint. Solid pine. 120×60, H70cm. 898.709.05

5. VIKA AMON/VIKA ANNEFORS table combination €71.50

Painted finish. Powder-coated steel. 200×60, H70cm. White/black. 798.714.01

6. VIKA AMON/VIKA CURRY table combination €19.99

Pre-drilled holes for legs, for easy assembly. Painted finish. Powder-coated steel. 100×60, H70cm. White. 798.316.22



EKBY JÄRPEN shelves, 119x28cm

€14.99/ea

Miles of shelves.
Masses of brackets.
Umpteen combinations.
Take your pick.

Find your favourite at [IKEA.IE/EKBY](https://www.ikea.ie/EKBY)

LEFT PAGE:

EKBY JÄRPEN shelves €14.99/ea
Painted finish. Max. load 30kg.
119x28cm. White. 900.250.44

EKBY BJÄRNUM brackets €15/2pk
Nickel-plated aluminium.
The bracket covers the edge of the shelf, so this can be cut to desired width and the cut edge will be concealed.
Suitable for 28cm. deep shelves. 3x28, H12cm.
Aluminium. 101.361.35

THIS PAGE:

1. EKBY STÄTLIG shelf €15.49
Solid wood, can be cut to desired width. Brackets are sold separately. Oiled solid birch. 79x19cm. Max. load 15kg. Birch. 000.941.88

EKBY STILIG brackets €6/ea
Suitable for 19cm. deep shelf. Painted solid wood. 2.5x17, H23cm. White. 101.432.11

2. EKBY JÄRPEN shelf €9.99
Painted finish. Brackets are sold separately. Max. load 15kg. 79x19cm. White. 900.569.88

EKBY ROBERT brackets €7/ea
Suitable for 19cm. and 28cm. deep shelves. Nickel-plated aluminium. 3x20, H25cm. Aluminium. 301.400.04

3. EKBY LEKSVIK shelf €19.99
Stained solid pine. Brackets are sold separately. 119x28cm. Max. load 30kg. Antique stain. 201.405.04

EKBY HÅLL brackets €3/ea
Reversible. Fit both 19cm. and 28cm. deep shelves. Powder-coated steel. 3x18, H24cm. Black. 567.027.80

4. EKBY HENSVIK shelf €17.99
Painted finish. Brackets are sold separately. Max. load 30kg. 119x28cm. White. 701.406.86

EKBY VALTER brackets €4/ea
Painted solid birch. Suitable for 28cm. deep shelf. 3x28, H31cm. Black. 801.674.73



1

EKBY STILIG brackets

€6/ea

2

3

4



ALEX 6-drawer unit on castors €95
Easy to place where you want it. The drawers are designed for A2-size papers. Painted foil finish. 67x48, H66cm. White. 301.043.22



ALEX 9-drawer unit €95
High unit with many drawers, means plenty of storage in a minimum of floor space. Foil finish. Designer: Johanna Asshoff. 36x48, H115cm. White. 401.467.60



GALANT 2-drawer unit on castors €139
Adjustable file frame in lower drawer. Can be adjusted to A4 or letter-size papers. Birch veneer/solid birch. 46x62, H63cm. 301.169.66



ANDY 3-drawer unit on castors €19.99
Drawers with stops, to keep them in place. The drawers are designed for A4-size papers. Steel. 37x37, H59cm. Silver colour. 800.913.98
Red. 501.517.94

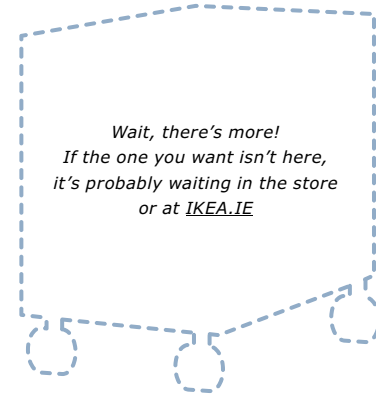

ERIK 3-drawer unit on castors €59
Lockable for safe storage of top secret things! Lock and key included. Powder-coated steel. 41x50, H57cm. Silver colour. 001.043.33
White. 101.518.09



ASPVIK 2-drawer unit €89
Combination lock. Easy to choose your own code for safe storage of papers and office accessories. Foil finish. 45x50, H56cm. Black. 701.382.02
Blue. 901.382.01 White. 701.348.12



MIKAEL 3-drawer unit on castors €49.99
The lower drawer can be assembled without base to store drop files. Printed and embossed finish. 37x50, H69cm. Black-brown/white. 200.866.63



HELMER drawer unit on castors €29.99
HELMER 6-drawer unit on castors €29.99
Slot for label on each drawer. Helps keep contents organised and easy to find. 6 labels included. Powder-coated steel. 28x43, H69cm. Silver colour. 201.078.73

Why pay more?
Good quality, function and low price

€34.99/ea

TORBJÖRN swivel chairs
Seat cover: 100% cotton. Back cover: 100% polyester. Seat 40x43, H42-50cm. Alme black. 501.337.62 Alme red. 901.451.93

Design and Quality IKEA of Sweden



just add wireless



IKEA PS clock
€29.99

IKEA PS clock €29.99
Steel. H48cm. Red. 601.161.54



FÄRGRIK mugs €0.69/ea
Stoneware. 30cl. Black. 401.439.93



DAVE laptop table
€22.99

DAVE laptop table €22.99
Powder-coated finish.
60x50, H51-81cm.
Red. 101.518.14



LAGRA table lamp
€3.99

LAGRA table lamp €3.99
101.463.37



STRIKT 4-piece desk set €8.49
201.666.45



DROPS collage frame
€6.99

DROPS collage frame €6.99
Fits 7 photos.
Plastic. 10x15cm.
Black. 300.656.79



KNÖS storage rack
for writing materials €8.49
Plastic. 32x10, H20cm. Black. 101.299.60



STRIKT magazine files €8.49/2pk
Cotton and paperboard.
Dark red. 401.666.49



GRAPEFRUKT plant pot €7.59
601.538.44



IKEA PS laptop workstation
€45.99

IKEA PS laptop workstation €45.99
701.379.19.



SIGNUM cable bags
€9.99/2pk

SIGNUM cable bags €9.99/2pk
Polyester and plastic.
801.383.10



HAMPEN rug €39.99
Polypropylene. 133x195cm. Red. 801.224.32



KAJSA TRÅD cushion cover €5.99
401.516.81.
IKEA PS STOFF throw €21.99
901.461.21.

286 WORK NEW PRODUCTS ARRIVE ALL YEAR ROUND AT THE IKEA STORE

You know what they say: two heads are better than one...



URBAN chairs
€29/ea

URBAN chairs €29/ea Plastic. Seat 45x40, H45cm. Red. 900.872.49
DOCKSTA dining table €149 Painted finish. Ø105, H75cm. White. 400.636.32

So join our Business Network!

Log on to IKEA BUSINESS Network, and enjoy a heads-together with some like-minded entrepreneurs, online. You'll find plenty of design ideas to inspire you at the IKEA store. But here's a great way to get the inside information on how other people have equipped their own businesses with IKEA furnishings. And on top of that, you get to network, share ideas and actively promote your business. All the planning tools you need to design or energise your working environment will be right there at your fingertips.

The IKEA BUSINESS Network: real people, real businesses, real solutions.

Start energising your business now at
[IKEA.IE/BUSINESS](https://www.ikea.ie/business)

**IKEA®
BUSINESS**
A better life at work

TJUSIG range

Painted solid hardwood/ stainless steel.

Designer: Henrik Preutz.

Hat racks €29.99/ea

79×32, H25cm. White. 401.526.33

Shoe racks €34.99/ea

2 shoe racks can be stacked together.

Connection fittings included.

79×32, H37cm. White. 301.526.38

Rack with 5 hooks €9.99/ea

60cm, H8cm. 501.569.56

BUMERANG curved clothes

hangers €5.99/8pk

Painted solid wood with steel hooks.

W43cm. White. 501.600.48

TJUSIG hat racks

€29.99 /ea

TJUSIG shoe racks

€34.99 /ea

Homeorganisation

To transform
the space you have
into all the space
you need



When gloves, bags, keys and scarves are "room-mates", the entrance to your home may look cluttered, even if it's actually quite organised. This cabinet has 16 hooks inside to organise everything, and a mirror door to hide it all away.

SKÄR range

With legs only at the front, to allow the cabinet to stand flush against walls with skirting-board. Foil finish.

Cabinet with mirror €99.99

53x19, H187cm.

Black. 301.453.27

3-compartment shoe cabinet €69.99

Holds 6 pairs of shoes. 49x19,

H153cm. Black. 501.453.26

EKBY JÄRPEN shelves €9.99/ea

Brackets are sold separately.

Stained ash veneer.

Max. load 15kg. 79x19cm.

Black-brown. 000.943.48

€14.99/ea 119x28cm.

Black-brown. 200.943.47

EKBY BJÄRNUM

brackets €13/2pk

The brackets cover the edge

of the shelf. This can be cut to

a desired width and the cut

edge will be concealed.

Suitable for 19cm. deep shelf.

Nickel-plated aluminium.

19x12cm. 901.361.36

€15/2pk 28x12cm. 101.361.35

KASSETT CD boxes

with lids €4.99/2pk

Hold 22 CDs. Painted

paperboard. 16x26, H15cm.

Black. 301.532.37

VIPPA hooks €2.99/4pk

Aluminium. H10cm. 066.837.84

LYCKA boot

hangers €3.49/ea

Boot hangers with hooks.

Save floor space and prevent

boots from sagging. Painted

solid mango wood and

powder-coated steel.

Designers: T. Christensen/

K. Legaard. H58cm.

Black. 901.478.61



SKÄR 3-compartment shoe cabinet

€69.99



PORTIS hat and coat stand
€29.99

HEMNES shoe cabinets with 4-compartments €94.99/ea
 With legs only at front to allow cabinets to stand flush against walls with skirting-boards. Each holds 8 pairs of shoes. Painted finish.
 Designers: K. Hagberg/M. Hagberg. 107×22, H101cm. White. 601.561.21
HEMNES mirror €79 75×165cm. 700.349.16 **PORTIS hat and coat stand €29.99**
 Powder-coated steel. W60, H191cm. Black. 000.997.89



TJUSIG range Painted solid hardwood. Stainless steel.
 Designer: Henrik Preutz
Hat rack €29.99 79×32, H25cm. Black. 201.526.34 **Shoe rack €34.99** Holds 6 pairs of shoes. 79×32, H37cm. Black. 101.526.39
Hat and coat stand €49.99 45×45, H191cm. Black. 701.596.66



STÄLL range Solid birch. Stainless steel.
 Designer: Sarah Grönvall.
Hat rack €49.99 75×33, H22cm. 401.526.66 **Shoe rack €59.99**
 Holds 6 pairs of shoes. 75×35, H34cm. 201.526.67
SANDNES shoe cabinet with 4-compartments €99.99
 Holds 12 pairs of shoes. Birch veneer. 69×17, H165cm. 901.118.95



PLINGA shoe rack €11.99
PLINGA range Powder-coated steel.
Hat rack €8.49 75×31, H21cm. White. 001.525.93
Shoe rack €11.99 Holds 6 pairs of shoes. 75×39, H36cm. White. 801.525.94 **TRONES shoe cabinets €29.99/3pk**
 Holds 6 pairs of shoes. Plastic. Each compartment 51×18, H39cm. Black. 301.108.32



BISSA shoe cabinet €23.99
BISSA range Particle board, foil finish.
Hall unit €39.99 36.5×40.5, H181cm. 001.478.51 **Shoe cabinet with 2-compartments €23.99** Each compartment holds 4 pairs of shoes. 49×28, H93cm. 001.485.63 **DRÖNA box €3.99**
 100% polyester. 33×38, H33cm. Assorted colours. 401.335.45



GORM shelving unit

€17.49

Clever storage with room to recycle gives you a clear floor, and a clear conscience!

LEFT PAGE:

GORM range

Untreated wood. Can be treated with oil or glazing paint for that personal touch, and a more durable surface. Solid wood.

Shelving unit €17.49

4 shelves included. Adjust spacing to suit. Max. load/shelf 50kg. 78×35, H174cm. 300.585.08

Storage combination

€104.50 Max. load/shelf 50kg. 206/76×35, H110/233cm. 298.695.56

SAMLA range

Polypropylene plastic.

Boxes €0.99/ea

28×20, H14cm. 5L. Transparent. 701.029.72

Lids €0.90/ea

Fit 5L boxes. 28×20cm. Transparent. 101.103.00

Boxes €1.79/ea

39×28, H14cm. 11L. Transparent. 401.029.78

Lids €1.10/ea

Fit 11L and 22L boxes. 39×28cm. Transparent. 501.102.99

SORTERA boxes with lids €9.99/ea

Folding lids for easy access to contents in stacked boxes. Not suitable for outdoor use. Ideal for sorting out your rubbish

indoors, ready to be taken for recycling. Plastic. 39×55, H28cm. 37L. White. 900.763.64

THIS PAGE:

1. GORM clip-on baskets €3/ea

To be hung on a shelf. Easy to move as required. Steel. 29×27, H15cm. Black. 700.933.07

2. SAMLA box with lid €3.59

Transparent or easy overview of the contents. 39×28, H28cm. 22L. 798.508.75



1



2

SAMLA box with lid

€3.59



1



2

ANTONIUS basic desktop unit on castors

€35



3

BRODER storage combination

€49



4

4. BRODER storage combination €73.00 The height extension posts need to be fixed to the ceiling with screws. The ceiling fitting can also be turned and screwed onto a sloping ceiling. Galvanized steel, solid wood. Max. load/shelf 30kg. 128x36.5, H140-319cm. 698.714.73

5. BRODER storage combination €133.50 Galvanized steel. Max load/shelf 100kg. 126x60, H209cm. 298.563.75



5



6

HYLLIS shelving units €8.99/ea

6. HYLIS shelving units €8.99/ea Plastic feet for use on the underside included. Will protect your floor against scratches. This furniture must be fixed to the wall with the included wall fastener. Galvanized steel. 60x27, H140cm. 401.037.27



Under staircases, slanting ceilings, in awkward spaces – our BRODER storage system goes wherever you want it to, thanks to multi-adjustable height extension posts.

1. NOSTALGISK clothes box with lid €9.99

Fits PAX wardrobe. Painted paperboard. 43×55, H18cm. White. 701.195.19

2. MÄLLA clothes boxes with lids €12.99/ea

Fit PAX wardrobe. 65% polyester, 35% cotton with fibreboard base. 42×56, H30cm. Black/white

flower. 101.545.63

3. BRANÄS basket €10.99

Hand woven, each basket is unique. Rattan. 32×35, H16cm. 900.280.66

4. NOSTALGISK boxes with lids €9.99/2pk

Fit BESTÅ bookcase. Painted paperboard. 28×35, H18cm. White. 701.194.87

5. KASSETT boxes with

lids €6.99/2pk

Fit BESTÅ bookcase. Painted paperboard. 28×35, H18cm. Orange. 501.505.15 White. 901.154.88

6. KASSETT DVD boxes with lids €5.49/2pk

Fit BILLY bookcase. Painted paperboard. 21×26, H15cm. Black. 301.532.42

7. NOSTALGISK 3-piece set

of boxes with lids €12.99

Sizes: 1 box Ø16, H9cm., 1 box Ø21, H11cm. and 1 box Ø26, H13cm. Painted paperboard. White. 001.302.66

8. KASSETT clothes box with lid €8.49

Fits PAX wardrobe. Painted paperboard. 43×55, H18cm. White. 901.155.01

9. NÄSUM chest €49.99

Banana fibre.

54×35, H28cm. 101.572.98

10. KASSETT CD boxes with lids €4.99/2pk

Fit BILLY bookcase. Painted paperboard. 16×26, H15cm. Green. 001.154.59

11-12. STRIKT range

Fits BESTÅ bookcase. 100% cotton, paperboard. Dark red.

11. 4-piece desk set €8.49

Comprises: 1 box for paper, 1 pencil box and 2 memo boxes. 201.666.45

12. Box with lid €5.99

28×35, H18cm. 801.666.52

13. NOSTALGISK 3-piece set of boxes with lids €12.99
 Sizes: 1 box Ø16, H9cm., 1 box Ø21, H11cm. and 1 box Ø26, H13cm. Painted paperboard. Red. 001.507.54

14. KAJSA boxes with lids €15.99/3pk

Sizes: 1 box Ø18, H8cm., 1 box Ø28, H12cm. and 1 box Ø38, H16cm. 100% cotton.

Multicolour/stripe. 801.556.63

15. LEKMAN box €10.99
 Fits BONDE and EXPEDIT bookcases. Plastic. 33×37, H33cm. 900.596.18

16. NÄSUM basket €15.99

Banana fibre. 32×35, H32cm. 201.454.79

17. KASSETT magazine boxes with lids €11.99/2pk

Fits BONDE and EXPEDIT bookcases. Painted paperboard. 38×33, H30cm. Black. 901.532.39

18. BRANÄS basket €15.99

Hand woven, each basket is unique. Rattan. 32×35, H32cm. 774.392.12



Personal treasures deserve a special place. BRANÄS boxes are great for love letters, favourite magazines or maybe your child's drawings. Like many of our boxes, it also fits our EXPEDIT bookcase perfectly, so you can maximise use of your storage space.



KASSETT boxes with lids
€6.99 /2pk

KASSETT magazine boxes with lids
€11.99 /2pk



KNÖS CD storage box
€5.99

1



DOKUMENT magazine files
€5.49 /2pk

2

THIS PAGE:
1. DOKUMENT magazine files €5.49/2pk Powder-coated steel. 10×26, H32cm. Silver colour. 301.532.56
KNÖS range
 Plastic and paperboard.
Storage rack for writing materials €8.49
 32×10, H20cm. Black. 101.299.60
CD storage box €5.99
 15×26, H15cm. Black. 201.299.69
2. DOKUMENT range
 Powder-coated steel.
Letter tray set €9.99
 Compartments pull out for easy access. 29×35, H27cm. White. 101.449.32
Magazine files €5.49/2pk
 10×26, H32cm. Orange. 501.532.55
KASSETT CD boxes with lids €4.99/2pk
 Label holder and labels included, to indicate contents for easy overview. Holds 22 CDs. Painted paperboard. 16×26, H15cm. Orange. 801.505.14 White. 801.154.60

Why pay more?

Good quality, function and low price



€17.49 /ea

GORM shelving units
 4 shelves included. Adjust spacing according to need. Solid wood. 78×35, H174cm. 300.585.08

Design and Quality IKEA of Sweden





FÄRGRIK mugs

€0.69/ea

MEDALJ pot with lid, 5L

€31.99



FÄRGRIK range

Stoneware.

Designer: Maria Vinka.

Also available in different colours.

Mugs €0.69/ea

30cl. White. 601.439.92

Plates €1.99/ea

Ø27cm. White. 201.316.70

Bowls €1.49/ea

Ø16cm. White. 301.316.55

MEDALJ pot with lid €31.99

Stainless steel. 5L. 901.004.44

SVALKA glasses €3.59/6pk

Glass. 20cl. 100.151.24

Cooking and eating

Chop, stir, mix, bake,
set the table ... enjoy!



IKEA 365+ GNISTRA bread knife

€10.59

Good quality knives don't have to cost a fortune

Forged, molybdenum/vanadium stainless steel blades with a full tang – the metal goes all the way through the handle – for better balance and durability. Speciality functions for tasks like filleting, carving or paring. Durable handles tough enough to use every day, and designed to fit comfortably in your hand. These are just some of the features that you will find in IKEA knife ranges. And with the affordable prices of these professional quality knives, you'll have more money left for other important things, like your food shopping!

THIS PAGE:

1. IKEA 365+ GNISTRA bread knife €10.59

Molybdenum/vanadium stainless steel, plastic and synthetic rubber. L23cm. Black. 401.493.20

2. SLITBAR cook's knife €23.59

Sturdy blade, for easy cutting of meat or root vegetables. Molybdenum/vanadium stainless steel, pakkawood. L21cm. Dark brown. 301.310.71

3. GYNNSAM paring knife €8.19

Small and handy, for easy peeling and trimming of fruit and vegetables. Molybdenum/vanadium stainless steel, plastic. L8cm. Dark grey. 501.349.50

2. IKEA 365+ GNISTRA cook's knife €10.99

Molybdenum/vanadium stainless steel, plastic and synthetic rubber. Designer: Håkan Olsson. L20cm. 601.493.24

3. GYNNSAM filleting knife €11.59

Molybdenum/vanadium stainless steel, plastic. L16cm. Dark grey. 701.349.49

4. HAKE 5-piece knife set €3.59

Comprises: bread knife 18cm. utility knife 10cm., cook's knives 13 and 19cm., and knife block 11×10, H33cm. Solid pine, stainless steel, plastic. 600.558.67

RIGHT PAGE:

1. SLITBAR range

Molybdenum/vanadium stainless steel, pakkawood. Dark brown.

Bread knife €23.59

L21cm. 101.310.67

Cook's knife €23.59

L21cm. 301.310.71

Cook's knife €21.99

L16cm. 301.310.66

Utility knife €15.49

L12cm. 001.310.63

Sharpening steel €17.59

L25cm. 701.489.89



The GYNNSAM and IKEA 365+ GNISTRA knife ranges have a 15-year guarantee. All knives in the SLITBAR range have a 25-year guarantee. Read more about all of our guarantees on page 374.



HAKE 5-piece knife set

€3.59

It's easy to choose your pots and pans

1. Choose functions.

Wok, frying pan or pot? It all depends on what you like to cook.

2. Choose materials.

Aluminium, stainless steel or cast iron? Each material serves a different purpose.

3. Choose sizes.

Single servings or family meals? The more people you cook for, the bigger the pots and pans you'll need.

With our online guide you can find your pots and pans in just a few clicks! [IKEA.JE/POTSANDPANS](https://www.ikea.com/uk/en/potsandpans)



All pots and pans in the IKEA 365+ cookware range include either a 5-year or a 15-year guarantee. The FAVORIT range has either a 10-year or a 25-year guarantee. Read more about all of our guarantees on page 374.

IKEA 365+ 7-piece cookware set €63.99

Comprises: pot with lid 5L, pot with lid 3L, saucepan with lid 1L and frying pan Ø28cm. All in metal, safe to use in the oven. Stainless steel, frying pan coated with Teflon® Platinum. 301.011.68



IKEA 365+ 7-piece cookware set

€63.99

YOU SAVE €15.97



IKEA 365+ frying pan, Ø28cm
€21.99

IKEA 365+ range Works well on all types of hob, including induction. Made entirely in metal, safe to use in the oven as well as on the hob. Stainless steel.

Saucepan with lid €10.99 0.6L. 801.011.56

Saucepan with lid €16.99 Teflon® Platinum coated stainless steel. 1L. 801.131.59 **Pot with lid €23.99** Teflon® Platinum coated stainless steel. 3L. 001.131.58

Pot with lid €23.99 5L. 001.011.55

Frying pan €21.99 Teflon® Platinum non-stick coated stainless steel. Ø28, H5cm. 101.012.06

Casserole dish with lid €43.99 Oven-safe glass, also suitable for use in the oven. 5L. 701.011.66

Sauté pan with lid €23.99 Ø24, H7cm. 101.011.69



FAVORIT grill pan
€41.99

FAVORIT range Works well on all types of hob, including induction. Made entirely in metal, safe to use in the oven as well as on the hob. All items (except frying pan and grill pan) are made up of three layers: two layers of stainless steel with an intermediate layer of aluminium: makes the pan durable and gives quick and even heat that is easy to regulate.

Saucepan with lid €22.99 1L. 200.834.62

Pot with lid €33.99 4L. 800.834.64

Pot with lid €53.99 8L. 100.877.00

Frying pan €41.99 Teflon® Professional coated aluminium. 23×33, H5cm. 000.834.58

Grill pan €41.99 Enamelled cast iron. 28×28, H4.5cm. 400.834.61

Sauté pan with lid €39.99 Teflon® Professional coated stainless steel. 3L. 200.834.57

Sauteuse with lid €36.99 2.5L. 600.835.54



SKÄNKKA pot with lid, 5L
€22.99

SKÄNKKA range Made from aluminium: spreads heat quickly and makes it easy to regulate so the food won't get burnt and stick to the pan. Non-stick Teflon® Select coated aluminium.

Pot with lid €18.99 3L. Grey. 601.294.58

Pot with lid €22.99 5L. Grey. 401.294.59

Grill pan €19.99 28×28, H4cm. Grey. 801.294.57

Wok with lid €22.99 Ø28, H8cm. Grey. 601.294.63

SKÄNKKA 6-piece cookware set €52.99

Comprises: pots with lid 3L and 5L, saucepan 1L and frying pan Ø28cm. Grey. 601.495.31

Buy complete set and save €14.97

ANNONS 5-piece cookware set
€8.99



1



2



3

GRILLA grill pan
€8.99



4

PYRA wok
€4.59



5

KAVALKAD frying pan, Ø28cm
€4.99

1. ANNONS 5-piece cookware set €8.99

Comprises: saucepan 0.8L, saucepan with lid 1.4L and pot with lid 2.4L. Works well on all types of hob, including induction. Stainless steel. 001.735.57

2. SNITSIG 7-piece cookware set €32.99

Comprises: saucepan with lid 1L, pot with lid 3L, pot with lid 5L and frying pan Ø24cm. Works well on all types

of hob, including induction. Stainless steel.

Non-stick coated stainless steel frying pan. 601.393.63

3. GRILLA grill pan €8.99

Thick base prevents food from getting easily burnt and stuck to the pan. Teflon® Classic coated aluminium. 36x26, H5cm. Black. 500.550.85

4. PYRA wok €4.59

Works well on all types of hob, including induction. Non-stick coated steel.

Ø35, H10cm. Black. 101.123.75

5. KAVALKAD frying pan €4.99

Low weight makes the pan easy to handle, even when full. Teflon® Classic coated aluminium. Ø28, H4cm. Black. 601.393.20

STABIL splatter screen €3.29

Fits most frying pans up to Ø32cm. Stainless steel. Ø33cm. 101.125.30

Why pay more?

Good quality, function and low price

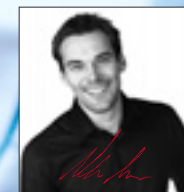

Designed by:
Marcus Arvonen

€13.99

SNITSIG pot with lid

Works well on all types of hob, including induction. Stainless steel. 5L. 801.297.25





DRÖMMAR 2-in-1
spring form tin

€10.59



BULLAR 2-piece
baking tin set

€5.79



DRÖMMAR
pie dish

€5.99



What could make baking more fun? Lots of lovely little helpers.

THIS PAGE:
DRÖMMAR 2-in-1 spring form tin €10.59
Baking tin with two different bases. Non-stick Teflon® Prima coated steel. Capacity 2.3L and 2.6L. Red. 101.330.47
DRÖMMAR cake doilies €3.59/4pk
Can be washed and reused. Plastic. Ø18cm. Assorted colours. 801.330.44
FLÄCKIG jug €1.29

Plastic. 1L. White. 701.349.68
1. BULLAR 2-piece baking tin set €5.79
Comprises: baking tin with removable base, Ø22cm. and pie dish, Ø28cm. Non-stick coated steel. Brown. 301.330.51
2. DRÖMMAR pie dish €5.99
Loose base makes turning out the pie crust easy. Non-stick Teflon® Prima coated steel. Ø31, H3cm. Red. 601.330.35

3. DRÖMMAR 14-piece pastry cutter set €6.59
Several sizes and shapes for everything, from making marzipan decorations to cutting cookies. Plastic. Ø23, H4cm. Light blue. 801.330.39
4. IDELIG mixing bowl €8.49
Melamine. Ø20, H15cm. 2.5L. White/red. 801.297.11

5. DRÖMMAR 2-piece baking tin set €7.99
Horse shaped. Non-stick Teflon® Prima coated steel. Sizes: 75ml. and 0.7L. Designer: Monika Mulder. Red. 501.330.45



PRUTA 17-piece
food saver set

€3.59



Go directly from freezer to microwave. The flip-up vent releases steam without your having to open the lid. And because the lid is leak proof, soup will be on your menu, not all over your picnic bag.

THIS PAGE:
PRUTA 17-piece food saver set €3.59
Basic set of food savers for everything from ham, cheese etc. to individual portions of food or meals. Several food savers can be stacked inside one another to save space when storing. Plastic. Transparent/green. 601.496.73

RIGHT PAGE:
1. IKEA 365+ food savers €2.39/ea
Plastic, synthetic rubber. 17×17, H6cm. White/red. 900.667.13
2. DROPPAR jars with lids €2.99/ea
Glass, stainless steel. 0.9L. 801.125.41
3. DISTANS range
Several food savers can be stacked inside one another to save space when storing. Plastic. Designer: Ola Wihlborg. White/blue.
Food savers €1.49/3pk
14×14, H7cm. 401.496.69
Food savers €1.19/3pk
Ø11, H8cm. 0.4L. 601.496.68
4. RARITET range
Transparent: makes it easy to find what you're looking for. Designer: Ulf Quensel.
Jar €6.99
Plastic. Measuring cup in the lid makes your cooking easier. 21×11, H15cm. 901.667.36
Food saver €4.59
Does not discolour from tomato sauce, etc. Plastic, synthetic rubber. 19×14, H7cm. 001.667.31



IKEA 365+ food savers

€2.39/ea

1



2



3



4



LJUVLIG plate

€2.39

1



2

FÄRGRIK plate, Ø31cm

€3.99

Choose your style.
Coordinated tableware
to suit your taste.

LEFT PAGE:

1. IKEA 365+

Glazed porcelain.

Plates €4.39/ea

25×25cm. Beige. 901.334.92

Side plates €2.99/ea

18×18cm. Dark grey.

101.334.86

Forks and knives from

24-piece cutlery set €27.99

Comprises: 6 forks, knives,

spoons and teaspoons.

Stainless steel. 901.162.18

IKEA 365+ IVRIG red wine

glasses €2.99/ea

Mouth blown each piece is

unique. Glass. 48cl. 501.330.69

IKEA 365+ IVRIG wine

glasses €1.99/ea

30cl. 901.256.99

2. LJUVLIG range Glass.

Plate €2.39

Ø27cm. Dark lilac. 101.317.36

Bowl €1.19

Ø11cm. Lilac. 101.317.55

DATA knife and fork from

24-piece cutlery set €24.99

Comprises: 6 forks, knives,

spoons and teaspoons.

Stainless steel. 800.917.65

DIOD glass €2.39

Glass. 25cl. White. 200.919.28

3. LUGN range

Glazed stoneware.

Plates €0.49/ea

Ø23cm. Beige. 001.331.23

Bowls €0.49/ea

Ø14cm. Beige. 801.331.24

BONUS spoons from

16-piece cutlery set €2.99

Comprises: 4 forks, knives,

spoons and teaspoons.

Stainless steel. 500.871.85

REKO glass €1.19/6pk

Stackable: saves space when

stored. Glass. 17cl. 800.940.14

4. TRIVSAM range

Glazed stoneware.

Deep plate €4.79

Ø32cm. Yellow. 901.326.28

Serving bowl €9.99

Ø32cm. Yellow. 201.470.82

DRAGON knife and fork from

24-piece cutlery set €24.99

Comprises: 6 forks, knives,

spoons and teaspoons.

Stainless steel. 900.917.60

RÄTTVIK red wine

glass €1.79

Mouth blown, each piece is

unique. Glass. 35cl. 500.302.12

THIS PAGE:

FÄRGRIK plate €3.99

Stoneware. Designer: M. Vinka.

Ø31cm. Black. 401.316.50

FÄRGRIK HÖGST

bowl €2.99

Earthenware. Ø16, H7cm.

White/dark lilac. 601.644.80



3



4

TRIVSAM serving bowl

€9.99

LUGN bowls
€0.49/ea





IKEA 365+ range
Products come in different colours/patterns.
Microwave and dishwasher safe. Glazed porcelain.
Mug €2.29 30cl. Dark grey. 201.324.48
Bowl €2.39 Ø16cm. Beige. 901.334.73

IKEA 365+ DRÖM bowl €3.59 16x16cm. Multicolour. 301.324.24
Deep plate €2.99 Ø25cm. White. 763.201.10
Side plate €2.29 18x18cm. Light turquoise. 101.334.91
Plate €5.79 Ø32cm. White/dark grey. 601.334.79

FÄRGRİK mug
€0.69



FÄRGRİK range
Products come in different colours/patterns.
Microwave and dishwasher safe.
Mug €0.69 Stoneware. 30cl. Green. 601.317.67
FÄRGRİK MELLAN bowl €2.99 Earthenware. Ø16cm. White/black. 201.644.39

FÄRGRİK deep plate €2.59 Stoneware. Ø24cm. White. 201.316.65
FÄRGRİK MELLAN side plate €2.99 Earthenware. Ø21cm. White/black. 001.644.35
FÄRGRİK plate €1.99 Stoneware. Ø27cm. Black. 601.316.49
FÄRGRİK HÖGST plate €6.59 Earthenware. Ø31cm. Dark lilac/white. 001.644.78

TRIVSAM side plate
€2.99



TRIVSAM range
Products come in different colours/patterns.
Microwave and dishwasher safe. Stoneware.
Espresso cup and saucer €2.49 12cl. Yellow. 301.333.91
Coffee cup and saucer €3.59 40cl. Green. 501.333.90
Bowl €2.39 Ø17cm. Green. 001.326.42

Deep plate €3.49 Ø24cm. Green. 901.326.33
Side plate €2.99 Ø23cm. Yellow. 601.326.39
Plate €4.79 Ø32cm. Green. 401.326.35

DINERA range Stoneware.
Deep plates €2.39/ea Ø22cm. Beige. 900.919.20
Plates €2.39/ea Ø26cm. Beige. 100.570.67
Plate €2.59 30x20cm. Beige. 500.919.22
VÄNLIG jug €2.29 Stackable: saves space when stored. Glass. 1L. 101.316.99

IKEA 365+ IVRIG red wine glasses €2.99/ea
Mouth blown each piece is unique. Glass. 48cl. 501.330.69
CHARMIG fork, knife and spoon from 24-piece cutlery set €35.99
Comprises: 6 forks, knives, spoons and teaspoons. Stainless steel and plastic. Black. 201.290.02



DINERA deep plates

€2.39/ea

TRYGG
serving bowl
€2.59



1

SNUDDA
lazy susan
€6.49



2



IKEA 365+ 3-tiered
serving stand
€13.99

4



5

1. TRYGG serving bowl €2.59

Glass. Ø28cm. 201.324.53

2. SNUDDA lazy susan €6.49

Turning function in base: easy to serve from. Solid birch. Max. load 12kg. Ø39cm. 900.744.83

ÖPPEN bowl €0.69

Glass. Ø14cm. H5cm. 401.379.11

DIOD glass €2.39 Mouth blown, each piece is unique. H8cm. 201.498.06

BLANDA BLANK bowl €2.39

Stainless steel. Ø12cm 300.814.67

3. BLANDA BLANK bowl €7.99

Space-saving when stored: small sizes can be stacked inside bigger sizes in the same range. Stainless steel. Ø28cm. 500.572.54

BLANDA MATT bowl €7.99

Solid birch. Ø20cm. 600.572.58

4. IKEA 365+ 3-tiered serving stand €13.99

Detachable plates: you can combine

them and vary the height as you like.

Glass, stainless steel.

31x27, H34cm. 401.017.33

5. SMARTA range

Stoneware. White.

Oven/serving dishes €2.39/ea

Oven safe. Ø9cm. 001.329.15

Serving plate €5.99

Ø30cm. 601.445.38

Why pay more?

Good quality, function and low price



€3.49 / 6pk



Designed by:
Henrik Preutz

VÄNLIG glasses

Stackable: saves space when stored.
Glass. 33cl. 601.317.05



LJUSÅS SALBO table lamp

€39.99

LJUSÅS SALBO
table lamp €39.99

Glass and 100% cotton.
Max. 100W. Shade Ø16.5,
H61cm. White. 201.230.43

IKEA 365+ BRASA pendant
lamps €55/ea

Powder-coated steel.
Max. 100W. Shade Ø45, H22cm.
Black. 501.384.15

IKEA 365+ SÅNDA range

Powder-coated aluminium.
Spotlights €35/ea Max. 35W.
Ø7cm. 401.316.93
Ø10cm. 901.316.95

Tracks €20/ea

114cm. 601.316.92

GYLLEN wall lamp €49.99

Glass. Max. 40W. 20x56cm.
Black/white. 398.611.35

GYLLEN wall lamp

€49.99

Lighting

Bringing every space
in your home to life



1. IKEA 365+ LUNTA floor lamp €95

Chrome-plated steel. 35% cotton, 65% polyester. Max. 100W. Shade Ø30, H164cm. 801.488.42

2. BAROMETER floor/reading lamp €55

Powder-coated steel. Max. 75W. Shade Ø16, H146cm. Red. 201.487.17

3. KIVSTA shade €24.99

100% cotton. Ø40, H25cm. Orange. 901.527.20

JANUARI floor lamp base €24.99

Shade sold separately. Nickel-plated steel. Max. 100W. H135cm. 901.325.34

4. JANSJÖ floor lamp €34.99

Painted steel and aluminium. H131cm. Silver colour. 901.287.25

5. RUTBO floor lamp €44.99

Waxed paper. Max. 75W. 30x25.5, H114cm. White. 301.178.43

6. KVART floor lamp €16.99

Painted steel. Max. 40W. Shade Ø8.5, H120cm. Silver colour. 701.207.11

7. ERSERUD shade €19.99

100% cotton. Ø34, H33cm. Assorted colours. 501.235.17

JANUARI floor lamp base €24.99

Shade is sold separately. Powder-coated steel. Max. 100W. H135cm. White. 801.568.65

8. SAMTID floor/reading lamp €44.99

Nickel-plated steel. Max. 100W. Shade Ø25, H152cm. White. 201.521.15

9. IKEA PS SVARVA table lamp €105

Painted solid beech and 100% cotton. Max. 75W. Shade Ø43, H70cm. White. 201.474.78

10. DUDERÖ floor lamp €9.59

Paper and painted steel. Max. 40W. Shade Ø30, H137cm. White/black. 401.483.54

KVART floor lamp

€16.99

JANSJÖ floor lamp

€34.99

DUDERÖ floor lamp

€9.59



1



3



4



5



6



2



7



8



9

1. LJUSÅS UVÅS table lamp C44.99
Dimmer function. Adjust the light intensity according to needs. Glass and 100% cotton. Max. 100W. Shade Ø24.5, H42cm. Black. 301.230.47 ☺

2. FORSÅ work lamp C19.99
Adjustable arm and head for easy light direction. Nickel-plated steel. Max. 40W. Shade Ø12, H50cm. 101.467.66

3. IKEA 365+ BRASA table lamp C69 Dimmer function. Adjust the

light intensity according to needs. Powder-coated steel. Max. 100W. Ø45, H69cm. White. 901.450.46 ☺

4. SKIMRA shade C5.99 Light source is sold separately. 100% cotton. Ø16, H29cm. Assorted colours. 601.541.36

JANUARI table lamp base C15.99
Powder-coated steel. Max. 75W. H45cm. White. 901.568.84

5. LYKTA table lamp C10.99
Mouth blown glass, each lamp is unique.

Painted glass. Max. 40W. Shade Ø14, H24.5cm. Cerise. 401.569.71

6. LAGRA work lamp C3.99 Adjustable head for easy light direction. Can be coordinated with other lamps in the same range. Painted steel. Max. 25W. Shade Ø9, H42cm. Black. 101.463.37

7. ÅRSTID table lamp C24.99
Nickel-plated steel. 70% polyester, 30% cotton. Max. 75W. Shade Ø22, H56cm. Off-white. 200.138.60

8. KNUBBIG table lamp C16.99
Mouth-blown glass, each lamp is unique. Max. 40W. Ø20, H21cm. Cherry-blossoms/frosted white. 001.305.01

9. SPARSAM low energy bulbs E27 11W C2.99/2pk 901.314.07
SPARSAM bulbs are up to 80% more energy efficient and can last up to 10 times longer compared to standard incandescent light bulbs.

SPARSAM low-energy bulbs 20W have been awarded "Best in Test" by Which? magazine December 2008.



SPARSAM has a 3-year guarantee. Find out more on page 374.



KRISTALLER 3-armed chandelier
€39.99

IKEA 365+ LUNTA pendant lamp
€29.99

MELODI pendant lamp
€6.99

1. FADO pendant lamp €15.99
 Shade in mouth-blown glass, each one unique. Steel. Max. 75W. Ø30cm. White. 101.961.10

2. IKEA 365+ LUNTA pendant lamp €39.99
 Powder-coated steel. Designers: A. Nilsson/H. Preutz/T. Eliasson. Max. 100W. Ø20cm. White. 101.384.22

3. KRISTALLER 3-armed chandelier €39.99
 Tinplated steel. Glass. Ø32cm. Silver colour. 800.894.61

4. IKEA 365+ BRASA pendant lamp €55
 Powder-coated steel. Max. 100W. Ø45cm. White. 801.316.72

5. KULLA pendant lamp €69
 Powder-coated steel. Max. 100W. Ø50cm. Black. 001.465.40

6. IKEA 365+ LUNTA pendant lamp €29.99
 Halogen bulb included. Spare bulbs are available. Powder-coated steel. Designers: A. Nilsson/H. Preutz/T. Eliasson. Max. 35W. Ø11cm. Yellow. 101.407.69

7. IKEA 365+ LUNTA pendant lamp €29.99
 Glass. Max 40W. Ø11cm. White. 901.316.62

8. LERAN pendant lamp €34.99
 Handmade shade, each one unique. Bamboo and rattan. Max. 100W. Ø29cm. Natural. 201.155.52

9. KLAVSTA shade €8.99
 65% polyester, 35% cotton. Ø23, H24cm. Assorted colours. 801.536.40

10. MELODI pendant lamp €6.99
 Plastic. Max. 75W. Ø28cm. 000.379.80



Glass door cabinets with glass shelves and lights inside not only give you a good overview, they also create a cosy atmosphere in the whole kitchen.

Cabinet lighting gives you directed light concentrated on a specific area, great for illuminating your lovely kitchen cabinets.

Worktop lighting provides a good, even light that's perfect for when you're chopping, cooking and washing up.



GRUNDTAL spotlights

€17.99 /3pk

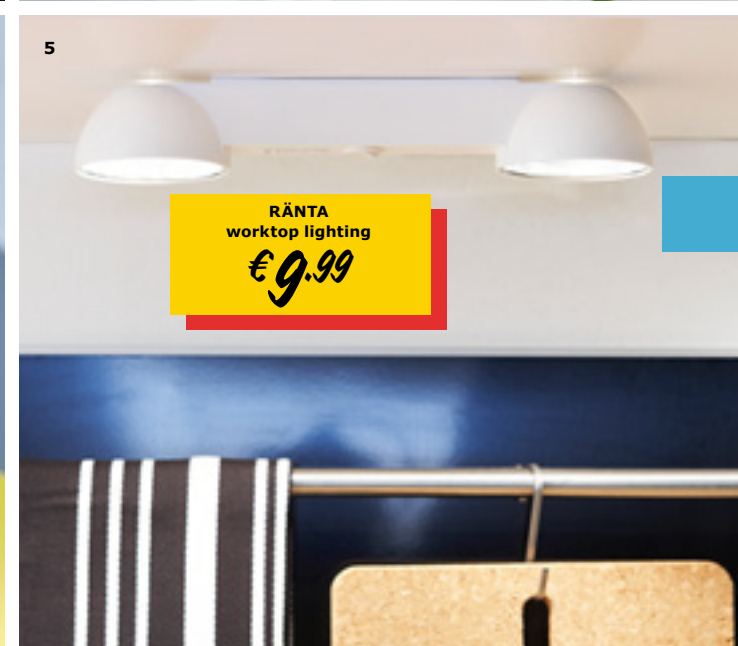

RÄNTA
worktop lighting
€9.99

Don't rely on carrots for good vision

Having the right kind of kitchen lighting may not improve the height of your soufflés, but it will make cooking more pleasant, and also safer. See what lighting can do for you at [IKEA.IE/LIGHTING](https://www.ikea.ie/lighting)

1. GRUNDTAL cabinet lighting €19.99

Halogen bulb included. Spare bulbs are available. Nickel-plated steel. Max. 20W. 001.298.71

2. GRUNDTAL spotlights €17.99/3pk

3 halogen bulbs included. Spare bulbs are available. Powder-coated steel. Max. 10W. White. 001.283.86

3. GRUNDTAL worktop lighting €45

3 halogen bulbs included. Spare bulbs are available. Steel and plastic. Max. 10W. 55.5x8, H2.5cm. White. 201.250.18

4. FORMAT cabinet lighting €19.99

Adjustable track, for easy direction of illumination. Powder-coated steel. Max. 20W. Black. 001.495.53

5. RÄNTA worktop lighting €9.99

2 halogen bulbs included. Spare bulbs are available. Plastic. Max. 25W. 701.446.94



INREDA cabinet lighting

€21.99/ea



2



3

LAGRA spotlight
€2.99

1. INREDA cabinet lighting €21.99/ea
Halogen bulb included. Spare bulbs are available. The lamp must be placed minimum 30cm. from other objects, as the reflector bulb gets very hot. Aluminium. Max. 20W. 801.298.72
INREDA cabinet lighting €39.99/ea
To be used with ANSLUTA cord system, sold separately. Possible to connect together into a system of up to 10 units. Aluminium. Max. 13W. L56cm.

White. 701.157.76
2. DIODER lighting strips €49.99/4pk
Includes light diodes. Has 30 times longer life than an incandescent bulb, consumes less energy and never has to be replaced. Plastic. L25cm. White. 001.194.19
3. LAGRA spotlight €2.99
Adjustable head for easy light direction. Plastic. Max. 25W. Shade Ø9cm. Black. 001.463.33

⊕
Movie nights are always cosy, but watching TV in a dark room can strain your eyes. Avoid hard contrasts, by placing a light source above and behind the TV. We recommend DIODER lighting strip.

Why pay more?

Good quality, function and low price



Designed by:
Michiko Nakata

€8.99/ea

KNUBBIG table lamps Mouth-blown glass. Each lamp is unique. Max. 25W. Ø12, H11cm. Cherry blossoms/frosted white. 101.304.59
Flower black. 001.594.10



BIGARRÅ range

Stoneware.

Designer: Eva Sjödin.

Vase €9.99

H12cm. Black. 701.517.31

Candlestick holder €2.99

H5cm. Black. 901.520.89

SALONG vase €8.59

Glass. Designer: Johanna

Jelinek. H20cm. Turquoise.

301.531.38

Remember! Never leave a
burning candle unattended.

BIGARRÅ vase

€9.99

Decoration

It's the loving
touches that tell
you you're home



SNÄRTIG vases
€0.59/ea

1



2



STJÄLK vases
€7.99/ea

3



4



5



SOMRIG vases
€1.99/ea

6



7



8

PÄLITLIG vase
€1.59

The shape of things
to come...

1. SNÄRTIG vases €0.59/ea
Glass. H18cm. 401.131.80
SNÄRTIG artificial flowers €0.79/ea
Gerbera. H33cm.
Assorted colours. 101.391.91
2. BIGARRÅ vase €35
Stoneware. Designer: Eva Sjödin.
H40cm. Black. 801.413.41

3. STJÄLK vases €7.99/ea
Each vase is mouth blown and has been shaped by a skilled craftsman.
Glass. 14x14, H16cm. 401.528.45
4. BLOMSTER vases €7.99/ea
Mouth blown, each vase has been shaped by a skilled craftsman.
Glass. H24cm. 301.136.18

5. SOCKERÅRT vase €13.99
Can be used as a jug. Enamelled steel.
Designer: Sigga Heimis.
H22cm. White. 801.484.65
6. SOMRIG vases €1.99/ea
Several vases can be put to together to form shapes, e.g. a circle or a wavy line.
Painted glass. Designer: Per Ivar Ledang.
H18cm. Blue and lilac. 801.510.52

7. BLADET vase €8.99
Glass. H30cm. 601.505.53
8. PÄLITLIG vase €1.59
Stackable in order to save space when not in use. Glass. Designers: K. Hagberg/M. Hagberg. H18cm. 401.510.92



1



2

**BORRBY lantern
for block candle**
€7.99



3



4

**NEGLINGE
tealight holders**
€0.49/ea



A 6-hour burning time means you can light the candles ready to welcome your guests, and they'll last all evening. Just remember never to leave a lit candle unattended.

For more inspirational ways to use candles safely, log on to IKEA.IE/CANDLEGUIDE

LEFT PAGE:

1. MJÖNÄS tealight holders €3.99/ea

Mouth blown; each candle holder is shaped by a skilled craftsman. Glass. H9cm. Assorted red shades. 101.521.11

2. BORRBY lantern for block candle €7.99

Suitable for both indoor and outdoor use. Steel and glass. 15x15, H28cm. 301.561.08

FLORETA FIN block candle €1.99

Burning time approx. 30 hours. Paraffin/vegetable wax. Ø7, H10cm. Lilac. 201.519.60

3. NÄSSJÖ candle holders €8.99/ea

Round. Dual function: one side is suitable for a block candle and the other for a candle in a metal cup. Aluminium. Ø14, H11cm. 401.520.77

FENOMEN block candle €1.59

Burning time approx. 45 hours. Paraffin/vegetable wax. Ø7, H15cm. Natural. 001.032.82

4. NEGLINGE tealight holders €0.49/ea

Dual function: one side is suitable for a household candle and the other for a tealight. Glass. Designers: K. Hagberg/M. Hagberg. H5cm. 901.520.94

VÄGHULT candles €2.29/8pk

Burning time approx. 6 hours. Paraffin/vegetable wax. H19cm. Green/lilac/black/orange. 601.519.44

TINDRA scented tealights €2.99/36pk

Burning time approx. 3.5 hours. Aluminium. Ø38mm. Green. 901.353.25

THIS PAGE:

1-3. new RÖNÄS candlesticks

Soft slide protector underneath, prevents damage to the underlying surface and keeps the candlestick firmly in place. Aluminium.

Designer: Ehlén Johansson.

1. €5.99 H23cm. 501.520.72

2. €4.29 H18cm. 101.520.74

3. €7.99 H28cm. 601.520.76

JUBLA chandelier candles €5.59/20pk

Burning time approx. 6 hours.

100% stearin. H19cm.

Natural. 801.228.99



1

2

3



1



2



3

GRAPEFRUKT plant pot
€7.59



4

MANDEL plant pots with saucers
€3.59 /ea



5



6

RÖNNBÄR plant pot with saucer
€9.99

1. KARDEMUMMA plant pots €1.59/ea

Fit flowerpots up to 11cm. in diameter. Earthenware. Inside Ø12, H10cm. White/assorted patterns. 901.130.88

2. BIGARRÅ plant pot with saucer €11.99

Draining hole in the bottom of the plant pot allows excess water to drain off. Stoneware. Inside Ø23, H16cm. Black. 201.413.39

3. GRAPEFRUKT plant pot €7.59

Fits flowerpots up to 14cm. in diameter. Plastic. Designer: Monika Mulder. Inside Ø14, H17cm. Red. 601.538.44

4. MANDEL range

Silicone-treated red clay. **Plant pots €2.59/ea**
 The shape and height of the pots make them suitable for orchids, etc.

Fits flowerpots up to 12cm. in diameter. Inside Ø12, H17cm. Grey-brown. 701.188.50

Saucers €1/ea

Outside Ø12, H1.5cm. Grey-brown. 601.310.41

5. NEKTARIN self-watering plant pots €5.99/ea

The self-watering insert provides constant moisture for plants. Plastic. Inside Ø22, H23cm. White. 101.538.46 Dark grey. 701.538.48

6. RÖNNBÄR range

Red clay. **Plant pot €5.99**
 Drainage hole in the bottom allows excess

water to drain off. Fits flowerpots up to 31cm. in diameter. Inside Ø35, H32cm. 501.188.46

Saucer €4

Outside Ø37, H6cm. 101.199.99

Find these and many more plants at your local IKEA store.



Big fan of orchids? So are we. That's why we've created a plant pot that leaves a nice space for oxygen between the orchid and the base of the pot, helping your beautiful orchid to stay fresh and healthy.

RIBBA – Gallery style without the silly prices

They help you express your artistic side, even if you can't draw a straight line. And they give you that expensive gallery look minus the high price tags. RIBBA is a range of frames in different sizes and finishes that are easy to combine. If you need a hand, we've collected some ideas to get you started at IKEA.IE/WALLDECOGUIDE

1–14. RIBBA frames

Mounts included. Foil finish with glass front panel.

- 1. €10.99** 30×40cm. Black. 101.325.28
- 2. €10.99/ea** 30×40cm. Aluminium colour. 801.010.43
- 3. €9.99** 23×4.5, H23cm. White. 000.780.32
- 4. €12.99** 50×23cm. White. 400.783.32
- 5. €22.99/ea** 50×70cm. White. 300.783.37
- 6. €8.99/ea** 21×30cm. Aluminium colour. 201.531.53
- 7. €4.99** 13×18cm. White. 700.783.35
- 8. €6.99** 18×24cm. Aluminium colour. 001.010.37
- 9. €4.99** 13×18cm. Black. 001.325.24
- 10. €8.99/ea** 21×30cm. White. 701.531.55
- 11. €12.99** 50×23cm. Black. 501.325.26
- 12. €10.99** 30×40cm. White. 601.010.44
- 13. €16.99** 40×50cm. White. 200.783.33
- 14. €4.99** 13×18cm. Aluminium colour. 201.010.36
- 15. SLÄTTHULT decoration stickers €14.99/pk**
Self-adhesive, easy to fit onto smooth, clean and dry surfaces. Plastic, paper. Green. 501.509.97



RIBBA frames
30x40cm
€10.99/ea

RIBBA frame 50x23cm
€12.99

RIBBA frame
40x50cm
€16.99



NYTTJA frames

€2.99/2pk

1



2



3

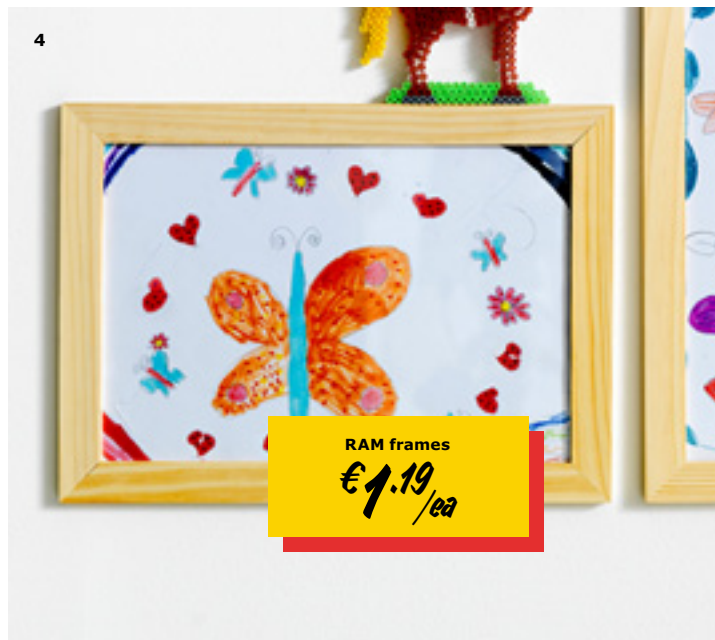

4

RAM frames
€1.19/ea

1. NYTTJA frames C2.99/2pk
Can be hung on the wall, or stood on a shelf, horizontally or vertically, to suit your room. Foil finish. Plastic front. 13x18cm. Assorted colours. 101.170.33

2. FJÄLLSTA frame C6.99
Mount included. Stained solid birch. Glass front. 13x18cm. Dark brown. 001.126.15

3. RIBBA frame C12.99
Can be hung horizontally or vertically, to fit the space available. Can also be used without mount, to display a larger picture. Mount included. Foil finish. Glass front. 50x23cm. Walnut effect. 901.618.52

4. RAM frames C1.19/ea
Front protection in durable plastic, safe to use with children around. Unfinished wood – can be treated with oil, wax or stain for a personal touch. Solid pine. 21x30cm. 300.288.42

Why pay more?

Good quality, function and low price



Designed by:
Emma Dafnäs

€2.29/ea

SUPERFIN vases
Glass. H29cm. Assorted colours. 601.131.79



the NEVER ENDING job.

We have decided to help create a world where we take better care of the environment, the earth's resources, and each other. We know that sometimes we are potentially part of the problem. So, we're working hard to become a part of the solution. We're weighing up the pros and cons, continually examining and changing things. All these steps, however small, across lots of different areas, add up to something... something with a noticeable impact. The job has already started, and it is a never-ending one. You can follow our progress at IKEA.IE



IMPROVEMENT #28
KASSETT magazine file is made from 80% recycled paper, and now comes from us folded flat. This means more files per truck, for less impact on the environment (and a better price). Each pallet now holds five times as many KASSETT. CO₂ emissions from transporting it have decreased by 75%.



IMPROVEMENT #1 When we design IKEA packaging, "pretty" is not our top priority. We don't design flat-packs to sell more but to save more. Flat-packs mean fuller loads and reduced vehicle use with fewer emissions. Our use of recyclable packaging helps too, requiring minimal new raw materials. We feel brown cardboard is one of our best friends – it saves costs and the environment.

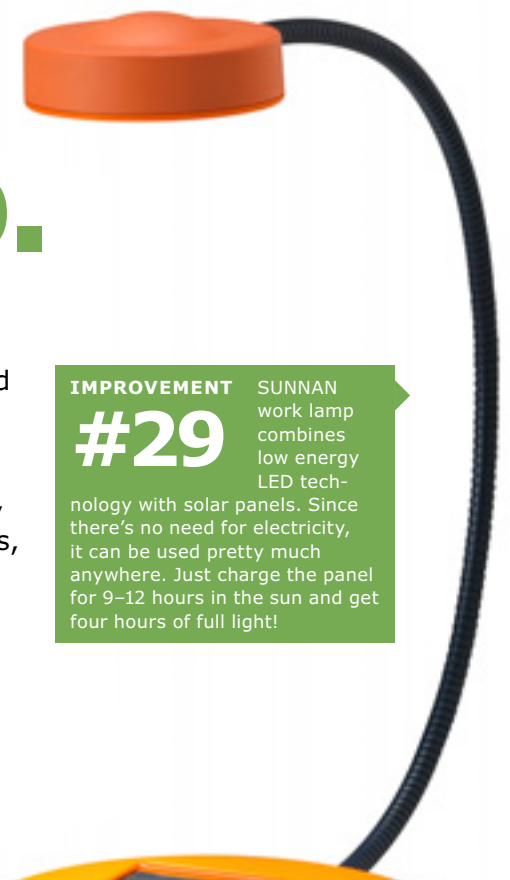

IMPROVEMENT #29 SUNNAN work lamp combines low energy LED technology with solar panels. Since there's no need for electricity, it can be used pretty much anywhere. Just charge the panel for 9–12 hours in the sun and get four hours of full light!

IMPROVEMENT #9 NORDEN table in birch. Introduced in 1998, it was probably the first time anyone had thought of making furniture from the knotty top part of the birch tree instead of burning it as firewood or grinding it for chipboard production.



IMPROVEMENT #18 The cotton in DVALA bed-linen, called "Better Cotton" is grown in a more sustainable way, using substantially less water, chemical fertilisers and pesticides. Not only that, the fabric is woven using 15% less cotton but feels just as good as comparable bedlinen.



IMPROVEMENT #23 Since 2003, the IKEA Social Initiative has been making donations from teddy bear and soft toy sales to children's projects all over the world. For a number of weeks each year, the IKEA Social Initiative donates 1 euro for every soft toy sold to projects run by UNICEF and Save the children. So far, 16.7 million euros have helped fund projects in more than 20 countries in Asia, Africa and Central and Eastern Europe.

IMPROVEMENT #30 RINGSKÅR taps come with a flow control function. The water flow can be adjusted in two steps with the lever, so customers can avoid the unnecessary wastage of water. Most IKEA taps are fitted with a Pressure Compensating Aerator (PCA) that can reduce water use by 30%.



IMPROVEMENT #40 The versatile NÅSUM basket is made from what most people would consider waste: remnants from banana trees after the harvest.

IMPROVEMENT #44 At IKEA, we hate waste! This is why we take every opportunity to turn leftovers from production into raw material for other products. LUSY BLOM cushion is one good example. It is filled with leftovers from IKEA quilt production, so we can make sure the content is safe and healthy as well as making use of the material that would otherwise be wasted.



IMPROVEMENT #36 SPARSAM low energy bulbs are a great alternative to traditional incandescent bulbs. They last ten times longer and the energy consumption is reduced by up to 80% over the bulb's life time. One 20-watt bulb provides as much light as a 100-watt incandescent bulb, without getting anywhere near as hot. IKEA will phase out incandescent bulbs in favour of more environmentally friendly alternatives before Sept 1, 2010. IKEA customers can return low energy bulbs to all IKEA stores for recycling.



A never ending job! All the improvements that we make for a sustainable and better life for as many people as possible can be seen at IKEA.IE

BUYING GUIDES

ANORDNA

See LILLÅNGEN/ANORDNA on page 355.

ANTONIUS How to build your system:

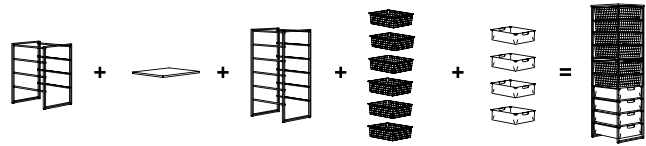

Start by screwing the desktop in place on the small frame.
Screw the feet supplied to the large frame, and adjust them so that the frame stands straight and steady on the floor.
Continue building by securing the small frame on top of the large one.
Use the stabiliser clips supplied to link the two frames together.
Finish off by adding the wire baskets and textile drawers you need.

ANTONIUS

Width×Depth×Height (cm.)

	Frame 44×54×70cm. 901.200.22 €8		Wall upright L90cm. 300.130.20 €3 L180cm. 500.130.19 €4
	Frame 44×54×102cm. 701.200.23 €12		Brackets , 2pk L52cm. 100.584.44 €3 Fits to wire shelf 51cm. deep.
	Wire basket 42×53×15cm. 101.200.21 €5		Brackets , 2pk L24cm. 900.130.17 €1.50 Fits 28cm. deep shelves.
	Drawer 42×53×14cm. White fabric 301.200.20 €4		Shelf 79×28cm. White 101.048.13 €4
	Drawer 25L 42×55×16cm. Transparent 501.012.33 €5 plastic		Shelf 79×36.5cm. White 401.048.16 €5.50
	Drawer 50L 42×55×32cm. Transparent 301.012.34 €7 plastic		Wire shelf 79×51cm. 801.012.36 €6.50
	Desk top 44×55cm. White 601.048.20 €4.50		Drying rack 79×51cm. 500.943.60 €9
	Desk top 119×60cm. White 001.048.18 €17		Clothes rail L79cm. 601.012.37 €3.50
	Leg adjustable , 2pk..... 52×60-89cm. Min. H60cm, max. H89cm. 301.012.29 €12		Laundry bag White 101.012.30 €6 Black 501.037.84 €6

	Stand for laundry bag ... 38×35×67cm. 101.038.04 €5.99
	Laundry bag with stand 52×25×69cm. Silver colour/white 601.190.44 €18.99
	Hoistable clothes dryer 60×120cm. Silver colour 001.190.42 €17.99
	Folding clothes dryer 70×160cm. Silve colour 801.190.43 €32.99
	Basket insert 24×37×7cm. Transparent 500.435.73 €1.50
	Castor , 4 pack..... Ø4.9, H5.5cm. 143.689.80 €2.50
	Shoe rack 79×36.5cm. Silver colour 600.943.50 €9
	Hanger with 6 knobs 52×15cm. Silver-colour 400.584.47 €2.50

Read more about ANTONIUS on page 298 or go to IKEA.IE/ANTONIUS

BESTÅ/FRAMSTÅ/INREDA How to build your system:

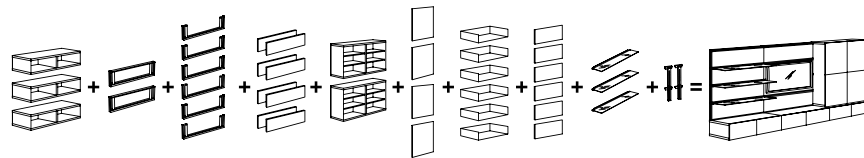

Combine the BESTÅ system any way you like and customise a storage and TV solution to suit your needs. Complement with FRAMSTÅ panel system, specially designed to be used with BESTÅ, and it will be easy to hang up a flat screen TV or FRAMSTÅ glass shelves. Add boxes and interior fittings from the INREDA series. There are handles, knobs and lighting to choose from.

BESTÅ

Width×Depth×Height (cm.)

	Shelf unit , 4 shelves..... 30×20×192cm. Beech effect 201.021.06 €35 Ash effect 101.371.54 €35 Black-brown 801.021.08 €35 White 401.340.45 €35		Shelf unit , 4 shelves..... 60×20×192cm. Beech effect 901.021.03 €45 Ash effect 801.371.55 €45 Black-brown 401.021.05 €45 White 201.340.46 €45		Shelf unit , 4 shelves..... 60×40×192cm. Beech effect 801.021.27 €60 Ash effect 401.371.57 €60 Black-brown 401.021.29 €60 White 801.340.48 €60
--	---	--	---	--	---

	Shelf unit , 8 shelves..... 120×40×192cm. Beech effect 201.021.30 €100 Ash effect 301.371.53 €100 Black-brown 801.021.32 €100 White 701.340.44 €100
--	--

	Shelf unit , 3 shelves..... 60×40×128cm. Beech effect 601.021.33 €55 Ash effect 601.371.56 €55 Black -brown 101.021.35 €55 White 001.340.47 €55
--	--

	Shelf unit , 6 shelves.... 120×40×128cm. Beech effect 901.021.36 €85 Ash effect 501.371.52 €85 Black-brown 501.021.38 €85 White 901.340.43 €85
--	---

	Shelf unit , 2 shelves..... 60×40×64cm. Height extension unit Beech effect 901.021.55 €35 Ash effect 601.371.61 €35 Black-brown 501.021.57 €35 White 001.340.52 €35
--	---

	Shelf unit , 4 shelves..... 120×40×64cm. Height extension unit Beech effect 601.021.52 €60 Ash effect 001.371.59 €60 Black-brown 201.021.54 €60 White 401.340.50 €60
--	--

	Shelf unit , 1 shelf 60×40×38cm. Height extension unit Beech effect 801.021.46 €30 Ash effect 801.371.60 €30 Black-brown 401.021.48 €30 White 201.340.51 €30
--	--

	Shelf unit , 2 shelves..... 120×40×38cm. Height extension unit Beech effect 201.021.49 €45 Ash effect 201.371.58 €45 Black-brown 801.021.51 €45 White 601.340.49 €45
--	--

	Wall shelf , 4 shelves 120×20×64cm. Height extension unit. Beech effect 001.021.45 €45 Ash effect 401.371.62 €45 Black-brown 501.021.43 €45 White 801.340.53 €45
--	--

	Bench 120×49×26cm. Beech effect 101.021.97 €45 Ash effect 701.371.51 €45 Black-brown 501.021.95 €45 White 101.340.42 €45
--	---

	BOÅS TV storage unit 120×40×128cm. Beech effect 701.447.31 €150 Ash effect 501.447.32 €150 Black-brown 801.447.35 €150 White 101.447.34 €150
--	---

	JÄGRA TV bench 120×60×54cm. Beech effect 601.057.06 €109 Black-brown 401.057.07 €109 White 801.037.68 €109
--	---

	ÅDAL TV bench 120×40×55cm. Beech effect 201.447.38 €99 Ash effect 601.447.41 €99 Black-brown 801.447.40 €99 White 001.447.39 €99
--	---

	BURS TV bench 180×41×49cm. High-gloss white 301.160.80 €249 High-gloss red 901.037.58 €249 High-gloss black 801.339.30 €249
--	--

	BURS wall shelf 180×26×26cm. High-gloss white 101.160.81 €120 High-gloss red 701.037.59 €120 High-gloss black 601.339.31 €120
--	--

	Rails for sliding doors , 2pk . Aluminium Door hardware included. L120cm, 1 door 101.058.36 €14 L180cm, 2 doors 901.058.37 €20
--	--

	HOLMBO door High-gloss brown 60×38cm. 501.166.54 €40 60×64cm. 201.166.55 €55 60×128cm. 801.166.57 €80
--	--

	HOLMBO drawer front High-gloss brown 60×26cm. 001.166.56 €25
--	---

	NORUM door High-gloss white 60×38cm. 501.035.57 €25 60×64cm. 301.035.58 €35 60×128cm. 501.166.68 €60
--	---

	NORUM drawer front . High-gloss white 60×26cm. 901.035.55 €18
--	--

	TOFTA door High-gloss red 60×38cm. 801.035.65 €30 60×64cm. 601.035.66 €40 60×128cm. 101.166.65 €65
--	---

	TOFTA door High-gloss black 60×38cm. 201.339.14 €30 60×64cm. 901.339.15 €40 60×128cm. 401.339.13 €65
--	---

	TOFTA drawer front High-gloss red 60×26cm. 801.044.47 €20
--	--

	TOFTA drawer front High-gloss black 60×26cm. 701.339.16 €20
--	--

	TOMBO Clear glass, aluminium 30×192cm. 501.342.38 €30 60×38cm. 401.035.53 €25 60×64cm. 201.035.54 €35
--	--

	TOMBO drawer front Clear glass, aluminium 60×26cm. 301.342.39 €20
--	--

	VARA door 60×38cm. Beech effect 401.034.78 €10 Ash effect 701.371.70 €10 Black-brown 601.034.77 €10 White 001.344.29 €10
--	---

	VARA door 60×64cm. Beech effect 001.058.32 €15 Ash effect 501.371.71 €15 Black-brown 801.058.33 €15 White 801.344.30 €15
--	---

	VARA door 60×128cm. Beech effect 801.034.81 €25 Ash effect 901.371.69 €25 Black-brown 001.034.80 €25 White 201.344.28 €25
--	--

	VARA drawer front 60×26cm. Beech effect 101.034.65 €7 Ash effect 301.371.72 €7 Black-brown 701.034.67 €7 White 601.344.31 €7
--	---

	VEGBY glass door 60×38cm. Beech effect 201.078.68 €20 Ash effect 401.371.76 €20 Black-brown 001.035.26 €20 White 601.035.28 €20
--	--

	VEGBY glass door 60×64cm. Beech effect 001.078.69 €30 Ash effect 201.371.77 €30 Black-brown 401.035.29 €30 White 801.035.27 €30
--	--

	VEGBY glass door 60×128cm. Beech effect 601.166.63 €45 Ash effect 601.371.75 €45 Black-brown 801.166.62 €45 White 401.166.64 €45
--	---

	Castor , 2pk Ø7.5cm. Chrome-plated 401.341.87 €10
--	--

	Castor , 2pk Ø7.5cm. Grey 001.432.16 €4
--	--

	Leg , adjustable 2pk Aluminium 501.341.82 €10
--	--

	Leg , adjustable 2pk Chrome-plated 801.341.90 €7
--	---

	Leg , adjustable 2pk Grey 801.432.17 €3
--	--

	Push opener 2pk 701.342.42 €5
--	--

	Underframe Chrome-plated 60×40cm. 201.341.88 €30 120×40cm. 001.341.89 €50
--	--

Read more about BESTÅ on page 70 or go to IKEA.IE/BESTÅ

➤ BESTÅ/FRAMSTÅ/INREDA

FRAMSTÅ

Width×Depth×Height (cm.)

	Base unit 120×32cm.
Aluminium	901.461.78 C30

	Add-on unit 120×32cm.
Aluminium	301.461.81 C25

	Panel filling, 2pk 120×32cm.
Beech effect/ walnut effect	201.461.91 C6
Ash effect/ light beige	801.461.93 C6
White/ black-brown	801.461.88 C6

	Panel filling, 2pk 120×32cm.
Glass, black	401.461.90 C14
Glass, grey	101.498.35 C14

	Glass shelf
120×21cm.	401.498.34 C18
60×21cm.	701.461.79 C11

	Wall bracket for flat screen TV
Galvanized	401.461.85 C25

	Angled connection 3pk
Galvanized	501.461.80 C5

	Straight connection 3pk
Galvanized	201.461.86 C3

 Read more about FRAMSTÅ on page 70 or go to IKEA.IE/FRAMSTA

INREDA

Width×Depth×Height (cm.)

	Bookends 2pk 17×7cm.
Silver colour	801.049.99 C2.99

	Bookends 2pk 17×7cm.
Smoked	801.339.54 C2.99

	Magazine ends, 2pk 24×7cm.
Silver colour	501.050.28 C5

	Magazine ends 2pk 24×7cm.
Smoked	901.339.58 C3.99

	Magazine shelf 56×44cm.
Silver colour	401.050.24 C6
Smoked	501.339.55 C7

	Drawer 60×40cm.
Silver colour	701.050.27 C20

	Drawer without front 60×40cm.
Grey	901.057.19 C9

	Drawer without front 60×49cm.
Grey	901.069.69 C12

	Fully extendable drawer Dark grey
60×40cm.	201.175.65 C35
60×49cm.	401.185.97 C40

	DVD rack 51×33cm.
Grey	101.053.70 C6

	CD rack 51×33cm.
Grey	301.053.69 C6

	Box 4 pieces
Smoked	101.339.57 C15

	Extra shelf 56×36cm.
Glass	301.034.74 C6

	Pull-out frame
Silver colour	501.444.97 C30

	Tray 52×35cm.
Smoked	001.339.53 C7

	Wine rack 56×35cm.
Smoked	401.339.51 C6

	Ladder 39×220cm.
Silver colour	001.044.65 C30

	Charging station 56×33×12cm.
Grey	701.167.71 C8

	Drawer mat 51×73cm.
Grey	901.167.70 C4

	Insert with 2 compartments 51×33cm.
Grey	501.167.72 C7

	Insert with 4 compartments 51×33cm.
Grey	101.167.74 C8

	Cabinet/picture lighting
Silver colour	001.193.82 C16.99

	Cabinet lighting L56cm.
Aluminium/white	701.157.76 C39.99

	Cabinet lighting
Aluminium colour	801.298.72 C21.99

 Read more about INREDA on page 72 or go to IKEA.IE/INREDA

BILLY

Width×Depth×Height (cm.)

	Bookcase 40×28×106cm.
Beech veneer	400.964.30 C32
Birch veneer	900.857.02 C32
Oak veneer	700.857.03 C32
White	800.857.07 C12.99

	Bookcase 40×28×202cm.
Beech veneer	200.964.31 C49
Birch veneer	400.857.09 C49
Oak veneer	600.857.13 C49
White	400.857.14 C25

	Bookcase 80×28×106cm.
Beech veneer	400.940.30 C49
Birch veneer	936.907.07 C49
Oak veneer	100.666.46 C49
White	636.883.10 C25

	Bookcase 80×28×202cm.
Beech veneer	200.940.31 C69
Birch veneer	136.906.07 C69
Blue	801.473.38 C39
Oak veneer	900.666.47 C69
White	836.882.10 C39
Red	001.181.70 C39
Black	701.040.99 C39

	Extra shelf 36×26cm.
Beech veneer	801.041.07 C7
Birch veneer	701.041.03 C7
Oak veneer	001.041.06 C7
White	201.041.05 C6
Glass	701.100.38 C6

	Extra shelf 76×26cm.
Beech veneer	900.940.37 C10
Birch veneer	536.909.07 C10
Oak veneer	500.773.46 C10
White	936.891.10 C9
Glass	036.909.00 C9

	Height extension 40×28×35cm.
Beech veneer	900.946.07 C19
Birch veneer	600.946.04 C19
Oak veneer	100.946.06 C19
White	800.946.03 C16

	Height extension 80×28×35cm.
Beech veneer	300.940.40 C25
Birch veneer	736.908.07 C25
Oak veneer	100.773.48 C25
White	536.893.10 C19

	BYOM glass door 40×35cm.
Beech veneer	101.166.70 C20
Birch veneer	001.166.75 C20
Oak veneer	901.166.71 C20
White	501.166.73 C13

	BYOM glass door 40×98cm.
Beech veneer	401.339.65 C35
Birch veneer	201.339.66 C35
Oak veneer	601.339.69 C35
White	401.339.70 C25

	BYOM glass door 40×194cm.
Beech veneer	001.040.88 C50
Birch veneer	901.040.84 C50
Oak veneer	701.040.80 C50
White	601.040.85 C35

	BYOM door 40×98cm.
Beech veneer	201.040.87 C35
Birch veneer	501.040.81 C35
Oak veneer	301.040.77 C35
White	301.040.82 C17

	MOREBO glass door Aluminium
40×96cm.	401.040.91 C30
40×193cm.	201.040.92 C50

	NYCKELBY glass door Floral pattern
40×96cm.	801.040.89 C30
40×193cm.	601.040.90 C50

	Book/magazine rail Aluminium
W36cm.	901.463.43 C7
W76cm.	701.463.44 C10

	Corner fittings, 2pk
Galvanized	401.041.09 C4

	BERGSBO cabinet 120×40×202cm.
Red	101.366.87 C249
White	901.366.88 C249

	BENNO TV bench on castors
118×51cm.	
Min. depth 38cm, max. depth 42cm.	
Beech veneer	501.044.77 C55
Birch veneer	301.044.78 C55
Oak veneer	701.044.81 C55
White	901.044.80 C45

	BENNO TV bench with panel
120×40×134cm.	
Beech	301.339.42 C119
Birch	101.339.43 C119
Oak	701.339.40 C119
White	901.339.39 C99

	BENNO DVD tower 20×17×202cm.
Beech veneer	100.941.35 C35
Birch veneer	873.052.07 C35
Blue	201.477.51 C18.99
Oak veneer	500.666.49 C35
White	073.053.10 C18.99
Red	401.181.68 C18.99
Black	801.040.94 C18.99

 Read more about BILLY on page 78 or go to IKEA.IE/BILLY

BRODER How to build your system:

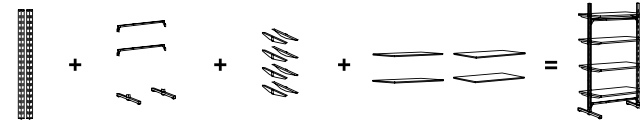



Start by thinking about what you want to store and how much room you have. Once you have these answers, it's easy to choose the basic combination you need in the BRODER storage system.

BRODER

Width×Depth×Height (cm.)

	Post Galvanized
H99cm.	101.171.27 C8
H204cm.	301.171.26 C13

	L-foot with brace Galvanized
D41cm.	001.171.23 C11
D64cm.	201.171.22 C13

	T-foot with brace Galvanized
D60cm.	401.171.21 C12

	Height extension post and foot Galvanized
	001.201.25 C10

	Suspension rail Galvanized
W90cm.	901.171.28 C3
W130cm.	301.201.24 C6

	Wall upright Galvanized
H97cm.	501.171.25 C5.50
H217cm.	801.171.24 C9

	Bracket center/adjustable, 2pk
D27cm.	901.171.33 C3.50
D58cm.	101.171.32 C7

	Bracket 27cm. front, 2pk ... Galvanized
D27cm.	401.171.35 C2.50

	Bracket 58cm. front, 2pk ... Galvanized
D58cm.	001.171.37 C5.50

	Shelf Galvanized
Sheet metal/mesh.	
79×36.5cm.	901.201.40 C12
79×60cm.	301.171.31 C13
119×36.5cm.	

EFFEKTIV How to Build:

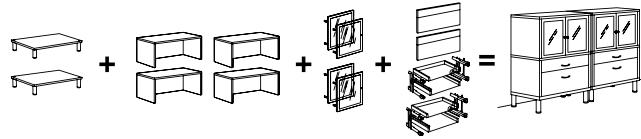

Think carefully about what you need to store – the interior fittings you choose determine what base and which add-on units you need. Start building from the bottom with a mobile or stationary base. Work your way up – add-on units come in two different heights. Add drawers, file frames or shelves and choose fronts and doors that suit your needs as well as your taste – there are several different materials and colours to choose from. Complement with accessories and choose handles or knobs from our wide range.

EFFEKTIV

Width×Depth×Height (cm.)
Handles are sold separately.

Base with castors 85×50×14cm.
Grey 200.440.17 **C35**

Base with supporting legs.....
85×50×14cm.
Grey 700.440.10 **C25**

Base with legs 85×43×14cm.
Silver colour 700.718.95 **C35**

Plinth 85×43×14cm.
Birch veneer 500.611.09 **C35**
Beech veneer 601.052.35 **C35**
Oak veneer 501.090.69 **C35**
Black-brown 001.052.38 **C35**
White 901.378.81 **C30**

Add-on unit, low 85×43×40cm.
Birch veneer 200.432.30 **C40**
Beech veneer 901.051.87 **C40**
Oak veneer 700.725.26 **C40**
Black-brown 300.725.28 **C40**
White 101.378.75 **C28**

Add-on unit, high 85×43×80cm.
Birch veneer 200.747.78 **C70**
Beech veneer 101.053.51 **C70**
Oak veneer 200.725.19 **C70**
Black-brown 600.725.17 **C70**
White 501.378.78 **C50**

Wall cabinet frame 85×36×42cm.
Birch veneer 300.501.40 **C45**
Beech veneer 401.052.41 **C45**
Oak veneer 300.723.35 **C45**
Black-brown 900.723.37 **C45**
White 701.378.82 **C30**

Door, low, 2pk 40×38cm.
For add-on unit 85×40cm.
and wall cabinet frame 85×42cm.
Birch veneer 501.051.89 **C25**
Beech veneer 701.051.88 **C25**
Oak veneer 301.090.65 **C25**
Black-brown 101.051.91 **C25**
White 901.378.76 **C16**
High-gloss black 701.511.75 **C45**
High-gloss white 901.208.14 **C45**

Aluminium/glass 601.094.55 **C45**
Aluminium/glass
Patterned 001.519.42 **C45**

Door, high, 2pk 40×78cm.
For add-on unit 85×80cm.
Birch veneer 901.053.85 **C35**
Beech veneer 201.053.84 **C35**
Oak veneer 101.090.66 **C35**
Black-brown 701.053.86 **C35**
White 701.378.77 **C20**
High-gloss black 001.511.88 **C55**
High-gloss white 601.208.15 **C55**

Aluminium/glass 901.094.54 **C55**
Aluminium/glass
Patterned 801.519.43 **C55**

Roll-front W85cm.
For add-on unit 85×40cm.
and wall cabinet frame.
Aluminium 000.725.39 **C65**

File frame W85cm.
For add-on unit 85×40cm.
Silver colour 300.439.51 **C40**

File frame front W85cm.
For add-on unit 85×40cm.
Birch veneer 601.053.58 **C20**
Beech veneer 001.053.56 **C20**
Oak veneer 701.090.68 **C20**
Black-brown 401.053.59 **C20**
High-gloss black 701.512.03 **C30**
White 101.378.80 **C17**
High-gloss white 201.208.17 **C30**

Extra glass shelf 80×36cm.
For use in add-on units only.
201.055.34 **C10**

Drawer without front W85cm.
Set of 2 801.383.53 **C85**

Drawer front, 2pk W85cm.
For add-on unit 85×40cm.
Birch veneer 401.052.17 **€20**
Beech veneer 601.052.16 **€20**
Oak veneer 901.090.67 **€20**
Black-brown 201.052.18 **€20**
High-gloss black 701.512.22 **C35**
White 301.378.79 **€15**
High-gloss white 401.208.16 **C30**

Drawer insert with 3 compartments
Felt/anthracite 001.181.65 **C9.99**

Drawer insert with 5 compartments
Felt/anthracite 301.181.64 **C9.99**

SUMMERA drop files 16pk
Assorted colours 100.647.08 **C10.99**

i Read more about EFFEKTIV on page 274
or go to IKEA.IE/EFFEKTIV

ELGÅ How to Build:

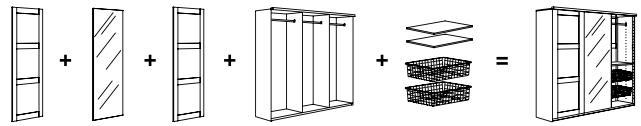

There are 3 simple steps to follow.
1. Pick your style. Choose between 3 different sliding doors.
Combine with the mirror door to add function and make the room feel larger.
2. Choose frames. There are 2 different widths and 2 colours.
3. Choose interiors. Decide on the number of shelves and wire baskets depending on your storage needs. Clothes rails are included.

ELGÅ

Width×Depth×Height (cm.)

Wardrobe frame 145×58×203cm.
2 clothes rails are included.
Grey 601.603.40 **C160**
White 201.603.42 **C160**

Wardrobe frame 217×58×203cm.
3 clothes rails are included.
Grey 801.603.39 **C200**
White 201.603.37 **C200**

ANEBODA sliding door 73×196cm.
Transparent white 401.603.17 **C25**

ENGAN sliding door 73×196cm.
Walnut effect 601.603.16 **C35**

FENSTAD sliding door 73×196cm.
Mirror glass 201.603.18 **C60**

Shelf 2pk
Grey 601.603.59 **C12**
White 401.603.60 **C12**

Wire basket 2pk
Grey 201.603.61 **C13**

i Read more about ELGÅ on page 177
or go to IKEA.IE/ELGA

FRAMSTÅ

See [BESTÅ/FRAMSTÅ/INREDA](#) on page 70

GALANT How to build your system:



Choose a table top of a suitable size and a frame to go with it according to your workspace needs. Also choose legs – both A-legs and T-legs are adjustable in height. When you need to, you can extend your work surface by adding extension tops and frames in various shapes and sizes (glass tops and conference table top excluded). Find more information about which table tops, frames and legs can be combined, further on in this buying guide.

GALANT

Width×Depth×Height (cm.)

	-160- -80- -160-	-160- -120- -60-	-160- -200- -60-	-200- -200- -60-	-180- -100-		
Table tops including frames	Also available in 120×80 and 120×60 in all colours except glass.	Also available in a right-handed version.	Also available in a right-handed version.	Also available in a right-handed version.			
The price is valid with silver coloured legs.							
Beech veneer	€141 598.316.99	€175 298.359.29	€169 398.359.24	€229 898.359.26	€293 698.359.27	€344 498.359.28	-
Birch veneer	€141 298.068.18	€175 698.068.16	€169 998.069.47	€229 198.069.46	€293 998.075.60	€344 798.075.61	-
Oak veneer	€141 498.363.53	€175 598.370.12	€169 598.369.70	€229 998.369.68	€293 598.373.47	€344 798.373.46	-
White	€99 198.495.16	€133 198.521.13	€139 998.521.14	€199 698.521.15	€233 498.521.16	€284 298.521.17	-
Black-brown	€141 898.363.32	€175 398.370.13	€169 798.369.69	€229 198.369.67	€293 198.373.49	€344 398.373.48	-
Glass	€147 398.429.86	€181 598.429.90	-	-	-	-	€159 198.429.87
White glass	€147 698.708.45	€181 998.708.44	-	-	-	-	€193 998.429.88
Black glass	€147 498.708.46	€181 198.708.43	-	-	-	-	-

Other table tops and extension tops including frame							Drawer unit
Beech veneer	€49 898.437.47	€54 298.374.76	€61 098.374.77	€54 998.437.56	€143 098.703.58	-	€139 101.169.67
Birch veneer	€49 798.233.87	€54 098.218.91	€61 898.215.47	€54 198.437.60	€143 298.703.62	-	€139 301.169.66
Oak veneer	€49 298.437.45	€54 798.374.74	€61 898.374.78	€54 598.437.58	€143 698.703.60	-	€139 801.169.64
White	€39 098.521.18	€44 898.521.19	€41 698.521.20	€44 498.521.21	€133 898.703.59	-	€119 301.379.21
Black-brown	€49 098.437.46	€54 498.374.75	€61 698.374.79	€54 398.437.59	€143 498.703.61	-	€139 501.169.65
Glass, white	-	-	-	-	-	€139 698.704.40	-

A-legs H60-90
Silver colour 400.574.57 **€9**
Chrome-plated 001.055.54 **€19**

Cable trunk 79×13cm.
Felt 101.460.78 **€10.99**

T-legs H60-82
Silver colour 200.569.15 **€35**

Drawer 43×55cm.
Grey 701.464.95 **€40**

i Read more about GALANT on page 272
or go to IKEA.IE/GALANT

GODMORGON How to build your system:

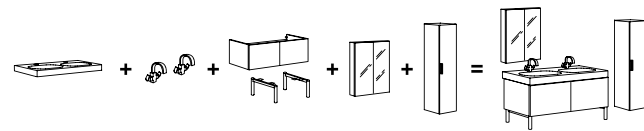

When planning your bathroom, start by considering the horizontal space available for the washbasin, since this is the busiest feature of most bathrooms. GODMORGON range offers three widths of washbasin: 100cm., 120cm. and 140cm. and with single or double sinks. Finally, once you've chosen the sink, you choose your tap, based on what function and design you want. With our functional bathroom organisers, you can make use of the entire space available, making the bathroom even bigger!

GODMORGON

Width×Depth×Height (cm.)
Handles and knobs are ordered separately.

BRÅVIKEN washbasin 1 sink
100×48×10cm. 301.354.46 **C229**

BRÅVIKEN washbasin 2 sinks
120×48×10cm. 101.354.47 **C249**

BRÅVIKEN washbasin 2 sinks
140×48×10cm. 901.354.48 **C269**

NORRVIKEN washbasin 1 sink
100×48×2cm. 801.356.08 **C159**
120×48×2cm. 601.356.09 **C179**
140×48×2cm. 201.356.11 **C209**

NORRVIKEN washbasin 2 sinks
100×48×2cm. 901.461.97 **C179**
120×48×2cm. 701.461.98 **C209**
140×48×2cm. 501.461.99 **C239**

ODENSVIK washbasin 2 sinks
100×48×2cm. 001.356.12 **C129**
120×47×2cm. 801.356.13 **C169**
140×47×2 cm. 601.356.14 **C189**

DALSKÄR mixer tap with sink strainer
Chrome-plated 801.441.65 **C69**

GRUNDTAL mixer tap with sink strainer
Stainless steel 101.441.78 **C79**

KATTSKÄR mixer tap with sink strainer
Chrome-plated 001.441.69 **C59**

LÅNGSKÄR mixer tap with sink strainer
Chrome-plated 701.441.75 **C119**

Washstand 100×47×39cm.
Birch veneer 901.476.15 **C130**
Black-brown/white 401.475.28 **C130**
White 101.475.20 **C180**

Washstand 100×47×58cm.
Birch veneer 401.476.13 **C180**
Black-brown/white 201.475.29 **C180**
White 301.475.19 **C230**

Washstand 120×47×39cm.
Birch veneer 701.476.16 **C180**
Black-brown/white 801.475.31 **C180**
White 701.475.22 **C230**

Washstand 120×47×58cm.
Birch veneer 601.476.12 **C230**
Black-brown/white 001.475.30 **C230**
White 501.475.18 **C280**

Washstand 140×47×39cm.
Birch veneer 801.476.11 **C230**
Black-brown/white 601.475.32 **C230**
White 901.475.21 **C280**

Washstand 140×47×58cm.
Birch veneer 201.476.14 **C280**
Black-brown/white 601.475.27 **C280**
White 701.475.17 **C320**

GRUNDTAL legs, 2pk ..Round/stainless steel.
22×45cm. 401.485.75 **C15**
25×45cm. 201.485.76 **C15**
41×45cm. 101.485.72 **C20**
44×45cm. 701.485.74 **C20**

GRUNDTAL legs, 2pk . Square/stainless steel.
22×45cm. 501.519.30 **C15**
25×45cm. 301.519.31 **C15**
41×45cm. 101.519.32 **C20**
44×45cm. 901.519.33 **C20**

MOLGER legs, 2pk Birch.
22×45cm. 201.505.45 **C15**
25×45cm. 001.505.46 **C15**
41×45cm. 801.505.47 **C20**
44×45cm. 601.505.48 **C20**

Wall cabinet with 1 door
40×14×96cm.
Birch veneer 301.475.62 **C75**
Black-brown 801.475.26 **C75**
White 601.475.13 **C85**

Wall cabinet with 2 doors
60×14×96cm.
Birch veneer 101.475.63 **C89**
Black-brown 001.475.25 **C89**
White 801.475.12 **C99**

High cabinet 40×37×160cm.
Birch veneer 401.475.33 **C169**
Black-brown/white 301.475.24 **C169**
White 901.475.16 **C189**

Mirror cabinet
40×14×96cm. 201.489.96 **C169**
60×14×96cm. 401.476.46 **C199**
70×14×96cm. 901.476.44 **C209**
100×14×96cm. 601.476.45 **C299**

Mirror
40×96cm. 101.491.28 **C17.99**
60×96cm. 301.491.32 **C24.99**
70×96cm. 301.501.11 **C24.99**
100×96cm. 901.491.29 **C34.99**
120×96cm. 501.491.31 **C49.99**
140×96cm. 701.491.30 **C59.99**

Read more about **GODMORGON** on page 204 or go to IKEA.IE/GODMORGON

GORM How to build your system:

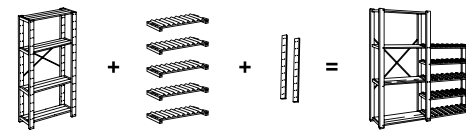

Start by thinking about what you want to store and the space you have available. To the first section, you need posts in a suitable height, shelves that fit your things and a cross-brace to stabilise the combination. After that, you can expand sideways.

GORM

Width×Depth×Height (cm.)

Shelving unit 78×35×174cm.
Softwood 300.585.08 **C17.49**

Shelving unit 78×55×174cm.
Softwood 000.585.19 **C29.99**

Post, 2pk
H110cm. 200.585.23 **C2.50**
H174cm. 000.585.24 **C3.50**

Height extension post, 2pk
H59cm. 700.585.06 **C1.50**

OBSERVATÖR cross-brace
L100cm. 877.496.00 **C3**

Corner shelf
D31cm. 100.585.09 **C7**
Length from corner: 76cm.

Corner shelf
D51cm. 600.585.16 **C9.50**
Length from corner: 76cm.

Shelf
31×50cm. 500.585.12 **C3.50**
31×77cm. 500.585.07 **C5**

Shelf
51×50cm. 400.585.22 **C5**
51×77cm. 400.585.17 **C7**

Bottle rack, holds 8 bottles
31×77cm. 100.585.14 **C5.50**

Clip-on basket
700.933.07 **C3**

End cap, 2pk
Plastic 900.933.06 **C1**

Read more about **GORM** on page 297 or go to IKEA.IE/GORM

KOMPLEMENT

See **PAX/KOMPLEMENT** on page 356.

LILLÅNGEN/ANORDNA How to build your system:

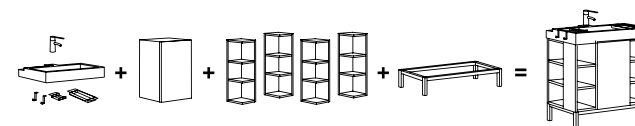

When planning your bathroom, start by considering the horizontal space available for the washbasin, since this is the busiest feature of most bathrooms. LILLÅNGEN range offers three widths of washbasin: 40cm., 60cm. and 80cm. Finally, once you've chosen the sink, you choose your tap, based on what function and design you want. With our functional bathroom organisers, you can make use of the entire space available - making the bathroom even bigger!

LILLÅNGEN

Width×Depth×Height (cm.)
Handles and knobs are ordered separately.

Washbasin, accessories included 1 sink,
white
40×41cm. 001.354.19 **C75**
60×41cm. 301.354.32 **C85**
80×41cm. 101.354.33 **C95**

HÖLLVIKEN washbasin White
60×41cm. 300.744.00 **C99**

DALSKÄR mixer tap with sink strainer
Chrome-plated 801.441.65 **C69**

GRUNDTAL mixer tap with sink strainer
Stainless steel 101.441.78 **C79**

KATTSKÄR mixer tap with sink strainer
Chrome-plated 001.441.69 **C59**

LÅNGSKÄR mixer tap with sink strainer
Chrome-plated 701.441.75 **C119**

Washbasin cabinet with 1 door
40×38×64cm.
Birch effect 301.376.95 **C49**
White 701.376.98 **C49**
White/aluminium 701.377.02 **C59**

with 2 doors 60×38×64cm.
Birch effect 101.376.96 **C59**
White 501.376.99 **C59**
White/aluminium 501.377.03 **C69**

with 2 doors 80×38×64cm.
Birch effect 801.376.69 **C69**
White 401.376.66 **C69**
White/aluminium 001.376.68 **C79**





Washbasin base cabinet with 2 doors 60×38×51cm.
Birch effect 501.377.17 **C59**
White 201.377.14 **C59**
White/aluminium 301.377.18 **C69**



3-drawer unit
..... 40×39×64cm.
Birch effect 101.378.42 **C69**
White 701.378.39 **C69**
White/aluminium 901.378.43 **C79**



End shelf 19×19×64cm.
Birch effect 901.380.84 **C20**
White 501.380.76 **C20**



» LILLÅNGEN/ANORDNA

	Leg frame 40x36x15cm. Stainless steel 201.378.65 €15
	Leg frame 60x36x15cm. Stainless steel 501.378.64 €17
	Leg frame 80x36x15cm. Stainless steel 701.378.63 €19
	Mirror cabinet 40x21x64cm. Birch effect 201.378.13 €49 White 301.377.23 €49
	Mirror cabinet 60x21x64cm. Birch effect 601.378.11 €59 White 601.378.06 €59

	Mirror cabinet 80x21x64cm. Birch effect 001.378.09 €69 White 201.378.08 €69
	Wall cabinet 60x21x40cm. Birch effect 301.378.36 €45 White 101.378.23 €45 White/aluminium 001.378.33 €55
	Wall cabinet 80x21x40cm. Birch effect 001.378.28 €55 White 401.378.26 €55 White/aluminium 801.378.29 €65



	High cabinet 40x38x179cm. Birch effect 501.378.16 €85 White 001.378.14 €85 White/aluminium 101.378.18 €95
	Shelf, 2pk 40x37cm. Birch effect 601.485.79 €9 White 801.546.49 €9
	Glass shelf 30x19cm. 101.572.03 €3 40x19cm. 301.572.02 €5



 Read more about LILLÅNGEN on page 206 or go to IKEA.IE/LILLÅNGEN

LILLÅNGEN/ANORDNA

ANORDNA

Width×Depth×Height (cm.)

	ANORDNA LYX 3-piece storage unit set , White 30×19 600.980.27 €6.99 40×19 900.980.35 €8.99
	ANORDNA LYX 3-piece pull-out storage unit set White 40×37 900.980.40 €14.99

	ANORDNA MEST 3-piece pull-out storage unit set White 40×37 300.980.38 €14.99
	ANORDNA MEST 2-piece storage unit set White 30×19 800.980.26 €4.49 40×19 200.980.34 €5.99

 Read more about ANORDNA on page 202 or go to IKEA.IE/ANORDNA

PAX/KOMPLEMENT with hinged doors How to build your system:

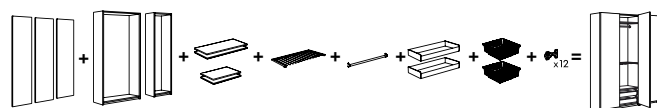

There are 3 simple steps to follow.

1. Pick your style from our wide selection of hinged or sliding doors in different colours.
 2. Choose frames. Consider how much space you have available in your bedroom.
 3. Choose interiors. Think through your day-to-day needs and choose from the KOMPLEMENT range.
- Below are some suggestions of combinations without interior fittings. Simply pick out the wardrobe that has the style, size and colour for you and fill it with the interior of your choice.

PAX Hinged doors

Width×Depth (cm.) Height (cm.)	50×60		100×60	
	201	236	201	236
BALLSTAD door white. Frame in white.	€70 598.418.77	€90 498.416.70	€100 598.418.82	€130 998.418.80
BERGSBO door white. Frame in white.	–	€100 998.627.83	–	€150 098.627.87
BIRKELAND door white. Frame in white.	€105 098.264.88	€130 898.264.89	€170 498.265.61	€210 298.265.62
BIRKELAND door grey. Frame in grey.	–	€130 998.628.01	–	€210 598.628.03
DRAMMEN door glass/aluminium. Frame in white.	€105 798.265.07	€130 598.265.08	€170 998.265.73	€210 798.265.74
FEVIK door oak effect/frosted glass. Frame in oak.	€105 398.416.61	€130 998.416.63	€170 498.418.73	€210 898.418.71
FEVIK door black-brown/frosted glass. Frame in black-brown.	–	€130 798.492.45	–	€210 598.492.46
HEMNES door black-brown. Frame in black-brown.	€125 798.507.57	€150 798.416.64	€210 198.507.60	€250 898.420.12
LOMEN door high-gloss white. Frame in white.	€125 898.274.98	€150 698.274.99	€210 098.276.66	€250 898.276.67
NEXUS door birch. Frame in birch.	€105 398.646.62	€130 698.647.12	€170 698.646.65	€210 598.647.17
NEXUS black-brown. Frame in black-brown.	€105 598.627.04	€130 098.626.88	€170 098.627.06	€210 298.626.92
NEXUS oak Frame in oak	€105 598.418.58	€130 798.418.57	€170 798.418.62	€210 998.418.61
VIKEDAL mirror door. Frame in white.	€105 398.265.47	€130 198.265.48	€170 498.266.03	€210 298.266.04

Above examples of combinations in 50 and 100cm. width. Prices include 18mm. thick melamine frame in either white, oak, grey, black-brown or birch, doors and hinges. Interior fittings, handles and knobs are sold separately. These combinations can be used together to make bigger solutions. Minimum ceiling height of 210 or 244cm. respectively. More combinations are available in store.

PAX/KOMPLEMENT with sliding doors How to build your system:

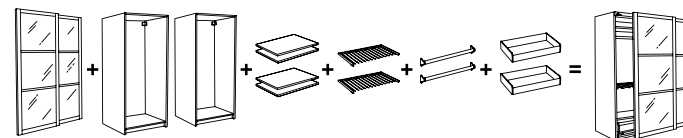

PAX Sliding doors

Width×Depth (cm.) Height (cm.)	150×66	200×66	150×66	200×66
	201	201	236	236
PAX BIRKELAND white. Frame in white.	€425 398.506.98	€500 798.507.00	€530 998.507.04	€670 498.507.06
PAX EIKESDAL oak. Frame in oak.	–	–	€590 098.521.56	€730 998.417.00
PAX HAKADAL birch. Frame in birch.	–	€500 198.715.31	€530 198.647.81	€670 798.647.83
PAX LYNGDAL glass/aluminium. Frame in white.	€400 098.503.36	€430 298.503.35	€450 198.503.93	€550 498.503.96
PAX LYNGDAL glass/aluminium. Frame in black-brown.	€400 298.503.64	€430 798.503.66	€450 898.504.17	€550 698.504.18
PAX MALM oak/oak. Frame in oak.	–	€295 298.421.85	–	–
PAX MALM mirror/oak. Frame in oak.	–	€315 098.421.86	–	–
PAX MALM mirror/mirror. Frame in white	–	€335 598.431.69	–	–
PAX TONNES white/glass. Frame in white	–	–	€590 998.627.40	€730 198.627.44
PAX ÅRDAL grey. Frame in oak	€400 098.506.85	€430 298.506.89	€450 198.506.56	€550 898.506.10
PAX UGGDAL grey/aluminium. Frame in white	–	–	€450 698.695.21	€550 298.695.23

Prices include 18mm. thick melamine frame in either white, oak, grey, black-brown or birch, and doors. Interior fittings are sold separately. Minimum ceiling height of 210 or 244cm. respectively. Above combinations can be used together to make bigger solutions. More combinations are available in store.

 Read more about PAX on page 172 or go to IKEA.IE/PAX





>> PAX/KOMPLEMENT

KOMPLEMENT

Interior fittings for PAX

WidthxDepthxHeight (cm.)

	PAX shelves, 2pk 50x58cm.		
	Birch	401.569.14	€10
	Black-brown	701.216.35	€10
	Grey	201.659.19	€10
	Oak effect	501.215.37	€10
	White	800.148.71	€10

	PAX shelves, 2pk 100x58cm.		
	Black-brown	001.216.34	€16
	Birch	801.569.12	€16
	Grey	901.659.30	€16
	Oak effect	601.215.27	€16
	White	200.148.74	€16

	ShelvesGlass/grey		
	50x58cm.	801.466.64	€9
	100x58cm.	101.466.53	€15

	Wire basket Beige		
	50x58x16cm.	901.067.90	€6
	100x58x16cm.	301.067.88	€10

	Add-on clothes rail Beige		
	54-75cm.	801.411.62	€5

	Drawer Solid birch		
	50x58x16cm.	001.033.81	€23
	100x58x16cm.	201.033.80	€29

	Drawer Black-brown		
	50x58x16cm.	101.216.76	€23
	100x58x16cm.	901.216.77	€29

	Drawer Grey		
	50x58x16cm.	701.659.31	€23
	100x58x16cm.	701.659.26	€29

	Drawer Oak		
	50x58x16cm.	101.214.45	€23
	100x58x16cm.	901.214.46	€29

	Drawer White		
	50x58x16cm.	001.214.55	€23
	100x58x16cm.	001.214.60	€29

	Storage with compartments		
	Transparent/grey	001.473.99	€20
	50x58cm.	401.473.97	€36

	Storage with 9 compartments .. Grey/		
	felt	901.393.33	€20

	Storage with 18 compartments Grey/		
	felt	901.465.26	€29

	Storage with compartments .. Textile/		
	white	801.079.74	€15

	Basket, 3pkTextile/white		
	30x34x32cm.	501.079.75	€35

	Box Set of 6		
	White	900.505.90	€9.99
	Black	901.225.87	€9.99

	Clothes rail Beige		
	50cm.	401.411.64	€3
	100cm.	601.411.63	€5

	Lid White		
	50x58cm.	500.194.17	€3
	100x58cm.	900.194.15	€5

	Plastic box White		
	50x58cm.	700.194.21	€4.99
	100x58cm.	500.194.22	€9.99

	Rail, 2pk White		
		600.194.26	€3

	Trousers hanger with 5 compartments ..		
	Beige	401.411.40	€35

	Shoe rack Beige		
	50cm.	001.411.61	€5
	100cm.	801.411.57	€8

	Shoe organiser Beige		
	100x58cm.	201.079.72	€39

	Rack with 16 hooks Beige		
		601.498.47	€5.99

	Box Set of 6		
	White	900.505.90	€9.99
	Black	901.225.87	€9.99

	Clothes rail Beige		
	50cm.	401.411.64	€3
	100cm.	601.411.63	€5

	Lid White		
	50x58cm.	500.194.17	€3
	100x58cm.	900.194.15	€5

	Plastic box White		
	50x58cm.	700.194.21	€4.99
	100x58cm.	500.194.22	€9.99

	Rail, 2pk White		
		600.194.26	€3

 Read more about KOMPLEMENT on page 174 or go to IKEA.IE/KOMPLEMENT

	Hook Steel		
	8cm.	700.602.79	€3

	Suspension fittings Aluminium		
	Individual	600.762.85	€2
	6pk	100.896.62	€12

	End fittings, 2pk Aluminium		
		701.066.06	€3

	Mirror with storage unit		
		401.067.35	€49

 Read more about STOLMEN on page 176 or go to IKEA.IE/STOLMEN

STOLMEN How to build your system:

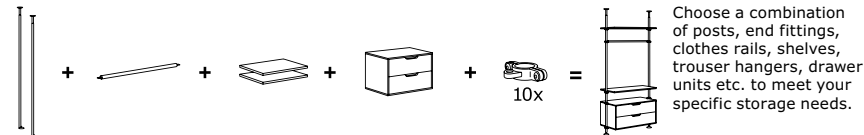



STOLMEN

STORAGE SOLUTION

WidthxDepthxHeight (cm.)

	Post Aluminium		
	210-330cm.	700.602.84	€25

	Shelf White		
	55x50cm.	900.602.83	€11
	110x50cm.	100.602.82	€17

	Chest of drawers White		
	55x50x45cm.	700.615.56	€59
	110x50x45cm.	000.624.70	€79

	Clothes rail Silver-colour		
	55cm.	100.602.77	€4
	110cm.	300.602.76	€7

	Trousers hanger Silver-colour		
	110cm.	200.624.69	€15

	Shoe rack Silver-colour		
	55cm.	400.624.73	€7
	110cm.	600.624.72	€14

TRÄBY

Each frame in the TRÄBY storage range is unique. That's because they're made of lacquered ash veneer, which has natural shifts in colour. By combining the frames with drawers, doors, glass doors and glass shelves, you can create a personal solution with room for all your things. If you want to accommodate larger objects, you can adjust the partition in the shelving unit. Hang the frames directly on the wall, or complement with legs and place the units on the floor. However you choose to use them, the result is guaranteed to be unique.

TRÄBY

WidthxDepthxHeight (cm.)

	Shelf unit* 80x39x80cm.		
	Ash veneer	901.050.69	€70
	*Partition wall is adjustable		

	Shelf unit* 80x39x41cm.		
	Ash veneer	101.050.68	€45
	*Partition wall is adjustable		

	Shelf unit 41x39x80cm.		
	Ash veneer	701.050.70	€45

	Shelf unit 41x39x41cm.		
	Ash veneer	501.050.71	€35

	Door 35x35cm.		
	Ash veneer	601.050.61	€12

	Drawer, 2pk 35x35x35cm.		
	Ash veneer	201.050.63	€25

	Leg, 4pk H10cm.		
	Ash	501.142.35	€6

	Glass shelf 35x36cm.		
	Clear glass	101.152.89	€6

	Glass door 35x35cm.		
	Clear glass	801.050.60	€15

	TV storage unit 126x40x170cm.		
	Ash veneer	001.473.42	€259

 Read more about TRÄBY on page 75 or go to IKEA.IE/TRÄBY

SOFA SYMBOL GUIDE

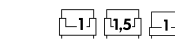

Armchair



Swivel chair, rocker



Recliner

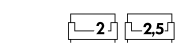

2 or 2.5-seat sofa,
3 or 3.5-seat sofa,
4 or 5-seat corner sofa

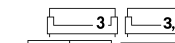

2 or 3-seat sofa with
right or left armrest

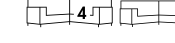

Chaise longue right or
left, with or without
armrest



Footstool



Chair bed, sofa bed
Corner sofa bed



Choice of cushions



Legs

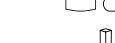

Choice of covers



Removable covers



Genuine leather

IKEA leather sofas and
armchairs display this symbol:
the sign of genuine leather.



Washing instructions,



Dry-clean



Take it home today

This symbol means that your sofa is available in store for you to take home today.



Delivery charge applies

This symbol means that you need to order your sofa and then it will be delivered to you at an extra delivery cost.



If you like IKEA you'll love IKEA FAMILY

- Up to 25% off selected products*
- Free quarterly home furnishing magazine*
- Inspirational emails packed with offers and ideas*
- Special offers on meals in the restaurant*
- 25% off special IKEA FAMILY range products*
- Invitations to in-store home furnishing events*
- Offers in the Swedish Food Market*
- Free tea and coffee Monday – Friday*



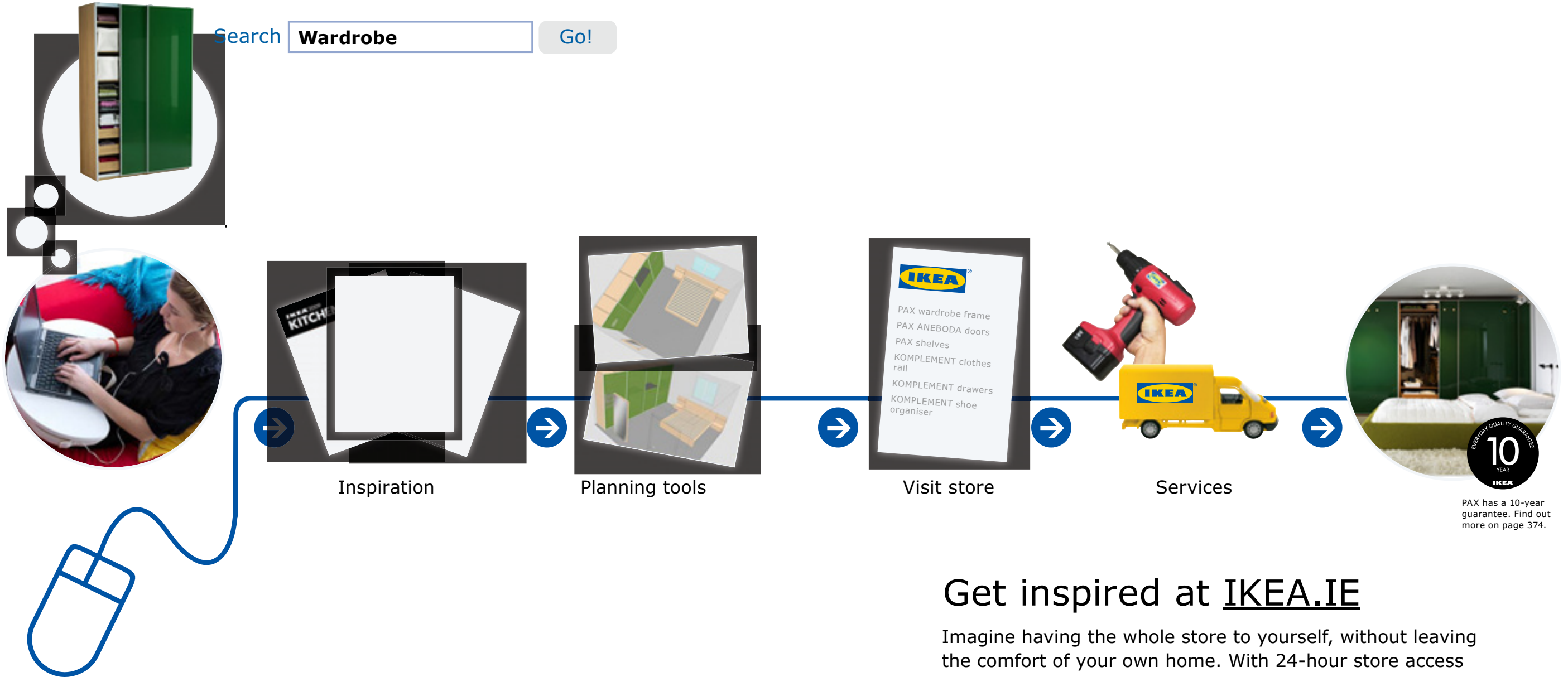

Get inspired at [IKEA.IE](https://www.ikea.ie)

Imagine having the whole store to yourself, without leaving the comfort of your own home. With 24-hour store access just a quick click away, you can use our interactive inspiration guides and online planning tools to design your home as often as you like. And you're always welcome, any time, any day of the week at [IKEA.IE](https://www.ikea.ie)

Giving is receiving...

Whatever the big occasion, you'll get a really big thank-you in return, when you treat someone to an IKEA Gift Card.



"Congratulations on the latest addition to your family!"



Your choice of value, their choice of everything. It's the gift that's guaranteed to put a smile on any face! Just pick up a card in store, and pay at the checkout.

Recycling... sorted



SORTERA storage boxes, 37L

€9.99 /ea

At IKEA we know recycling can get a little messy. So to help out, we've introduced a range of handy waste bins, bags and boxes.

Bottles, board and baked bean tins, tasty takeaway menus or less pleasant letters from the tax man, it all needs to be sorted. But ideally without turning half your home into a rubbish dump.

Why not try SORTERA boxes to help you sort your wheat from your chaff, or your carrot tops from your cardboard? You'll love how easy they make the job. (So will your bin men).

Everyone wants to live in that green and pleasant land. And with stylish recycling storage to make things simpler, we can all do our bit to help.



This is the IKEA way.



At IKEA, you don't need anyone to hold your hand while you shop

Together we keep
IKEA prices low

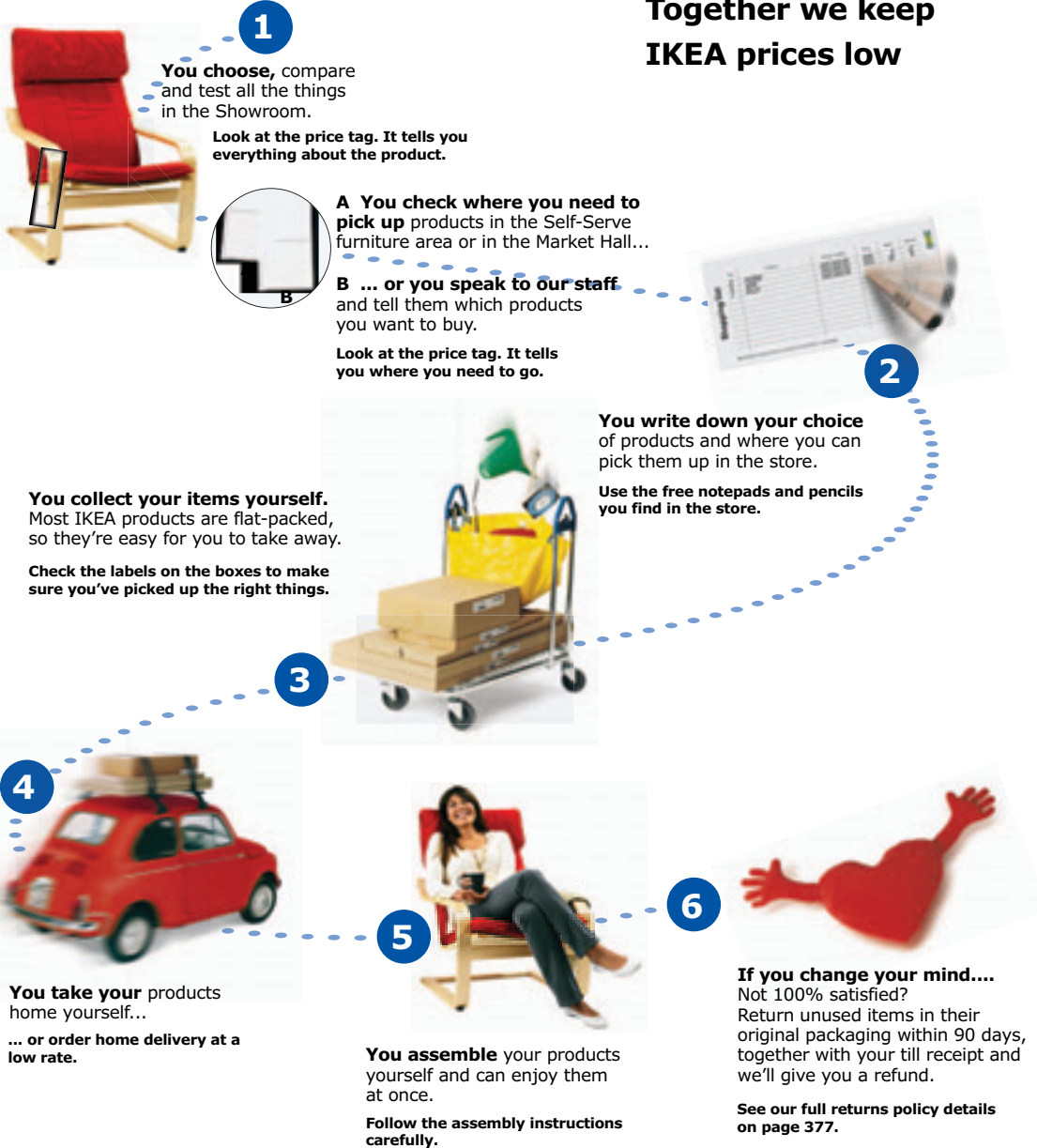



Get a hands-on feel for things in our realistic and inspiring showrooms



Yipeeeee!!!



No need to go hungry while you shop



Lots of Swedish treats in the Food Market

A shopping trip to please the whole family

A trip to the IKEA store really offers something special for everyone, whatever their age, or their agenda! Fantastic new furnishing ideas for your home, an exciting adventure for your kids, or tasty meals all round, in our restaurant. And it's all under one roof.

Try everything for size in the showrooms

You'll love the inspiring ideas and furnishings in realistic room settings at IKEA. Stretch out on a sofa, discover the true meaning of comfort on our beds, or let your children choose fun furniture for their own rooms. In the Market Hall, there's all sorts, from apple slicers to zebra striped pillows. Cutlery, candles, frames and fabulous lighting, plus all the pots, pans and paraphernalia you need for your kitchen. Find exactly what you've been wishing for, in our own cave of wonders.

Let the kids play while you shop

Let's face it – kids don't exactly love shopping. They've got far more interesting things to do. Like playing. Småland is a supervised play area and ballroom, where you can leave the kids, free of charge in safe hands, while you shop in peace. (Terms and conditions apply, please see in store for details)

Enjoy a break at the restaurant

We don't believe in running with your fuel guage on empty – try our restaurant, with a full menu of healthy, high quality Swedish and local dishes at really low prices. It's totally child-friendly, with high chairs, changing facilities and a play area.

Bring home a taste of Sweden

If you can't get enough of our famous meatballs, have no fear: you can pick some up in the Swedish food market to take home for later. Our gravadlax and caviar may also be on your menu tonight - or perhaps some tasty biscuits for coffee time tomorrow!

Plan your dreams

With IKEA, it's easy to become an interior designer...
We provide all the tools you need, and it won't cost you a penny!



Kitchen planner

Your dream kitchen is within easy reach. Just grab your mouse and log on to our web site, where a free planning tool can be downloaded to your PC. With this, you can feed in your kitchen measurements, choice of units, finishes and features, to try out different layouts and see how they look! It's all in 3D, so you can even enjoy a virtual walk through your dreams!



Office planning & PAX wardrobe planner

The same easy design software that we offer for kitchen planning also exists for designing your ideal workspace or PAX wardrobe. Log on to our web site and look for the office planner or PAX wardrobe planner feature. Input your requirements to create your dream workspace or PAX wardrobe and see how it shapes up, in lifelike 3D.



Selection brochures

Our main catalogue gives you as much detail and information as we can find space for in 380 pages. But we've so much more to tell you! Lots of it you can access online, but to give you something else to mull over at your leisure, we also produce a wide range of additional brochures, for specific products and areas of your home. They're all free, and you can pick them up when you visit us in store or you can view them online at IKEA.IE



Measuring services

An essential part of the planning process, accurate measuring helps you to ensure your new kitchen will fit and function properly. If measuring is not your cup of tea, not a problem, we can do it for you. This bespoke measuring service is to enable an IKEA approved service provider to accurately record the dimensions of your room to enable you to plan and design your new kitchen. A small charge is payable directly to the service provider for the appointment which is refundable when you spend €2000 or more on your new IKEA kitchen excluding installation costs.



Home furnishing support

Our coworkers are always ready to assist you by offering useful advice, hot tips and ideas, helping you create the home you've always wanted.

Need some extra help?

Whenever you need support to realise your dreams, we're there for you.



Transport service

Home delivery

Most of our products are designed and packaged in such a way that you can easily get them home in your own car. But for those things that aren't, you can arrange home delivery, for a reasonable charge.

Ask in store for details.

Customer order service

Some of your purchases you can't take home with you directly, like made to order sofas. Our store staff can advise you when you visit the store.



Assembly service

Do you want help assembling your furniture? IKEA products are designed to be assembled by the customer. However, if you would prefer, we can recommend an independent service provider who offers home assembly services in your area. See in store for details.



Installation service

Do you need help installing your kitchen? Professional kitchen installation help can save you valuable time, especially when it comes to the trickier bits like installing worktops, appliances, sink and taps, or installing kitchen units. You can choose one, or all of the items from our Kitchen Installation Service menu. For further information please contact a member of staff in the Kitchen department in store or call the Service Centre on 1890 987 938. Please note that the rate charged for the use of 1890 numbers may vary among different service providers.



General conditions for all guarantees

What is Guaranteed?

The extent of the guarantee given for each product is described alongside each product below.

Duration of Guarantee

Each guarantee lasts for the number of years stated against each product below, starting from the date of purchase.

What will IKEA do to correct the problem?

IKEA will examine the product and decide, in its sole discretion, if it's covered under the relevant guarantee. If IKEA decides that a product is covered by the guarantee, IKEA will then, at its choice, either repair the defective product or replace it with the same or a comparable product. In these cases, IKEA will be responsible for the costs of repairs, spare parts, labour and travel for repair staff that IKEA incurs, provided that the product is accessible for repair without IKEA incurring any additional expenditure to gain access. This will not apply in cases where repair work has not been authorized by IKEA. IKEA and the IKEA repair staff will not be liable or responsible for any damage caused to products or property caused when trying to gain access to the product(s) in the course of repair. IKEA repair staff will not take unreasonable risks in attempting to access the product(s) in question. Any defected parts removed in the course of repair works will become the property of IKEA. If the item is no longer sold by IKEA, IKEA will provide an appropriate replacement. IKEA will decide at its discretion, what will constitute an appropriate replacement. Replacements offered will be of similar quality and price of the original product

Conditions for the guarantees

The guarantees are valid from the date of purchase at IKEA. The original purchase receipt is required as proof of purchase and must be submitted to IKEA at the time of claiming against the relevant guarantee.

Exclusions

The guarantees do not apply to products that have not been stored, assembled or used in accordance with the IKEA instructions or products which have not been cleaned following the specific IKEA care instructions. The guarantees do not cover normal wear and tear, cuts or scratches, or damage caused by impacts or accidents. The guarantees do not apply if products have been placed outdoors or in a humid environment or if the products have been used for non-domestic purposes (unless otherwise stated). The guarantees does not cover consequential or incidental damages. The guarantees are for the benefit of the original purchaser of the product. They are not transferable. For details see the guarantee conditions and description for every product.

Care instructions

To be able to rely on this guarantee you need to follow the specific care instructions for every product. You will find all care instructions in the IKEA stores and on the IKEA web site: IKEA.IE

General legal rights:

This guarantee gives you specific legal rights. This guarantee does not, in any way, affect the rights given to you by law.

How to reach us if you need service:

Contact your local IKEA store. You will find the address and phone number on page 378 of the IKEA catalogue or at IKEA.IE. Save your sales receipt as proof of purchase. Proof of purchase is required for the guarantees to be valid.

Everyday quality guarantees



GALANT, EFFEKTIV What is covered under this guarantee?

The guarantee covers defects in material and workmanship on all main parts in the GALANT system and the EFFEKTIV storage range.

Products not covered under this guarantee

This guarantee does not apply to GALANT cable organiser, GALANT cable trunk, EFFEKTIV drawer insert with 3 compartments and EFFEKTIV drawer insert with 5 compartments. See also general conditions on this page.



JERRIK, KLÄPPE, MARKUS, VERKSAM What is covered under this guarantee?

This guarantee covers defects in material and workmanship on the following components:

- The structural frame • Moving parts.

See also general conditions on this page.



TUNDRA What is covered under this guarantee?

We guarantee that in normal use the flooring will not wear through, not fade from sunlight and not stain permanently. TUNDRA flooring

complies with User Class 31 of EN 13329 which means it is suitable for use in all rooms in a home, except for rooms such as bathrooms, damp cellars and basements and rooms with a floor drain, and is also suitable for light commercial use, such as flooring with light wear in small offices and meeting places – not in shops. See also general conditions on this page.



EKTORP, KRAMFORS, KARLSTAD, VRETA, ARILD ÄLVROS What is covered under this guarantee?

This guarantee covers defects in material and workmanship in the following components:

- Frame • Base linen/supporting fabrics • Legs • Fittings • Armrests • Filling • PIXBO HÄVET mattress • KARLSTAD armchair mechanism.

This guarantee applies to domestic use only.

Products not covered under this guarantee

This guarantee does not apply to:

- ARILD fixed leather cover • KARLSTAD fixed leather covers, fabric covers or comfort cushions sold separately • KRAMFORS removable fabric covers sold separately or the fixed leather cover • VRETA fixed leather cover • ÄLVROS fixed leather cover • EKTORP comfort cushions and covers sold separately, EKTORP TULLSTA, EKTORP JENNYLUND, EKTORP MUREN and EKTORP BROMMA.

See also general conditions on this page.



POÄNG

What is covered under this guarantee?

The guarantee covers defects in material and workmanship in the following components of POÄNG armchair frames and POÄNG footstool frames:

- Layer-glued frame • Fittings • Supporting fabric

This guarantee applies to domestic use only.

Products not covered under this guarantee

This guarantee does not apply to POÄNG cushions, POÄNG covers and POÄNG children's armchair or any other products sold separately. See general conditions on page 374.



IKEA STOCKHOLM

What is covered under this guarantee?

The guarantee covers defects in material and workmanship in the following components of IKEA STOCKHOLM 3-seat leather sofa, 3.5-seat fabric sofa and 1.5-seat armchair frames and cushions:

- Frame • Fittings • Legs • Armrests • Base linen/supporting fabric • Filling.

This guarantee applies to domestic use only.

Products not covered under this guarantee

This guarantee does not apply to the IKEA STOCKHOLM fabric and fixed leather covers for the 3.5 seat sofa and 1.5 seat armchair. Other products from the IKEA STOCKHOLM collection are not covered under this guarantee. See also general conditions on page 374.



VAXHOLM

What is covered under this guarantee?

This guarantee covers defects in material and workmanship in the following components of VAXHOLM frames and cushions:

- Frame • Fittings • Legs • Armrests • Base linen/supporting fabric • Filling. This guarantee applies to domestic use only.

Products not covered under this guarantee

This guarantee does not apply to VAXHOLM covers and loose cushions included when buying seating moduls. See also general conditions on page 374.



BESTÅ

What is covered under this guarantee?

This guarantee covers defects in material and workmanship in BESTÅ system (all products), FRAMSTÅ system (all products) and the following products in INREDA range: drawer, drawer without front, fully extendable drawer, pull-out frame, shelf insert, extra shelf 26x16cm., extra shelf 56x16cm. and extra shelf 56x36 cm. This guarantee applies to domestic use only.

Products not covered under this guarantee

This guarantee does not apply to: All INREDA products not mentioned under the headline "What is covered under this guarantee". See also general conditions on page 374.



SULTAN

What is covered under this guarantee?

This guarantee covers defects in material and workmanship in the following components of the SULTAN mattresses and/or bed bases described above:

- Wooden frame and springs in wooden base spring mattresses. • Springs in reversible spring mattresses. • Foam core in foam mattresses. • Latex core in latex mattresses. • Wooden frame and slats in slatted bed bases. • Electric motor in electrically operated beds (5-year guarantee, starting from the date of purchase). This guarantee applies to domestic use only.

Products not covered under this guarantee

All mattress pads: SULTAN SANDANE, SULTAN TOLG, SULTAN TRANDAL, SULTAN TÅRSTAD, SULTAN TJÖME, SULTAN TVEIT, SULTAN TAFJORD; slatted bed base SULTAN LADE; children's mattresses SULTAN DRÖMMA, SULTAN SNARKA, SULTAN BLUNDA, SULTAN SUSSA, SULTAN SOVA; and children's mattress pad SULTAN SLUMRA. See also general conditions on page 374.



PAX/KOMPLEMENT

What is covered under this guarantee?

This guarantee covers defects in material and workmanship in the following components of the PAX/KOMPLEMENT wardrobes and interior fittings described:

- Frames • Doors • Hinges • Sliding door mechanism • Drawer gliders • Shelves and clothes rails. This guarantee applies to domestic use only.

Products not covered under this guarantee

KOMPLEMENT wire basket, KOMPLEMENT box in plastic and textile, KOMPLEMENT pull-out shelf in transparent plastic, KOMPLEMENT trouser hanger and KOMPLEMENT shoe organiser. See also general conditions on page 374.



GODMORGON

What is covered under this guarantee?

This guarantee covers defects in material and workmanship in the following furniture, washbasins, mixer taps, interior fittings and water trap:

- GODMORGON Furniture • GRUNDTAL and MOLGER legs • ODENSVIK Fire clay washbasins and included watertrap • BRÄVIKEN, NORRVIKEN and BREDVIKEN crushed marble washbasins and included watertrap • LEDSKÄR, LÅNGSKÄR, KATTSKÄR GRUNDTAL and DALSKÄR washbasin mixer taps.

This guarantee applies to domestic use only.

Products not covered under this guarantee

• Aerator – expandable item in the washbasin mixer taps. See also general conditions on page 374.



SPARSAM

What is covered under this guarantee?

This guarantee covers function, materials and workmanship in all low-energy bulbs and tubes in the SPARSAM range.

What is not covered under this guarantee?

This guarantee does not apply if the product has been placed in a temperature under -10 degrees Celsius or over +40 degrees Celsius. If used in a humid environment such as a bathroom or conservatory, SPARSAM may only be used with luminaires approved for wet locations. See also general conditions on page 374.

To find out more pick up the EVERYDAY QUALITY folders in your local store

**FAKTUM/RATIONELL****What is covered under this guarantee?**

This guarantee covers defects in material and workmanship in the following kitchens or parts of kitchens. This guarantee applies to domestic use only.

FAKTUM kitchen system**What products are covered under this guarantee?**

This guarantee covers all of the following parts of the FAKTUM kitchen system: • Cabinet frames • Door fronts • INTEGRAL hinges • RATIONELL fully-extending drawers • RATIONELL shelves of tempered glass and melamine • RATIONELL wire baskets • Plinths • Legs • Cover panels • Deco strips/mouldings • Worktops that are at least 3.8cm. thick • Sinks • PERFEKT shelf and wine shelf • RATIONELL bottom trays for base cabinet • RATIONELL drawers under oven • RATIONELL floor-level drawers • RATIONELL dish drainers for wall cabinet

Products not covered under this guarantee

Knobs, handles and worktops that are less than 3.8cm. thick. Any product or part of product not listed above. See also general conditions on page 374.

VÄRDE free-standing kitchens**What products are covered under this guarantee?**

This guarantee covers defects in material and workmanship on all the parts in the VÄRDE free-standing kitchen range, with the exception of the products listed below.

Products not covered under this guarantee

VÄRDE knobs and handles, appliances, mixer taps, shelves and wall shelves in solid wood are not covered by this guarantee. See also general conditions on page 374.

**LAGAN kitchen system**

LAGAN is not covered by this guarantee. LAGAN is still subject to minimum legal protections under Irish law.

APPLIANCES**What is covered under this****guarantee?**

The guarantee covers faults of the appliance, which have been solely caused by faulty construction or material faults from the date of purchase from IKEA. This guarantee applies to domestic use only. The exceptions are specified under the headline "What is not covered under this guarantee?" Within the guarantee period, the costs to remedy the fault e.g. repairs, parts, labour and travel will be covered, provided that the appliance is accessible for repair without IKEA incurring any additional expenditure to gain access. IKEA and the IKEA repair staff will not be liable or responsible for any damage caused to products or property caused when trying to gain access to the product(s) in the course of repair. On these conditions the EU guidelines (Nr. 99/44/EG) and the respective local regulations are applicable. Any defective parts removed in the course of repair works will become the property of IKEA.

How long is the guarantee valid?

This guarantee is valid for 5 years from the original date of purchase of the IKEA appliance from IKEA. LAGAN appliances have a 2-year guarantee. If service work is carried out under guarantee, this will not extend the guarantee period for the repaired or replaced appliance, or for the new parts.

Which appliances are covered under this guarantee?

The 5-year guarantee is valid for all IKEA appliances, except for LAGAN appliances, which have a 2-year guarantee.

Appliances not covered under this guarantee.

All appliances purchased from IKEA before 1 August 2007.

Who will execute the service?

The IKEA service provider will provide the service through its own service operations or authorised service partner network.

What is not covered under this guarantee?

• Normal wear and tear. • Deliberate or negligent damage, damage caused by failure to observe operating instructions or incorrect installation, damage caused by chemical or electro-chemical reaction, rust, corrosion or water damage including but not limited to damage caused by excessive lime in the water supply, damage caused by abnormal environmental conditions. • Consumable parts including batteries and lamps.

• Non-functional and decorative parts which do not affect normal use of the appliance, including any scratches and possible colour differences. • Accidental damage caused by foreign objects or substances and cleaning. • Damage to the following parts: ceramic glass, accessories, crockery and cutlery baskets, feed and drainage pipes, seals, lamps and lamp covers, screens, knobs, casings and parts of casings. Unless such damages can be proved to IKEA's satisfaction to be due to production faults. • Cases where no fault could be found during a technician's visit. • Repairs not carried out by our appointed service providers and/or an authorised service contractual partner or where non-original parts have been used. • Repairs caused by installation which is faulty or not according to specification. • The use of the appliance in a non-domestic environment i.e. professional use. • Transportation damages. If a customer transports the product to their home or other address, IKEA is not liable for any damage that may occur during transport. However, in case of IKEA delivery of the product to the customer's delivery address, then eventual damages to the product that occurs during this delivery will be covered by IKEA (but not under this guarantee). For claims under this last particular condition the customer should contact IKEA Customer Service at IKEA.IE • Cost for carrying out the initial installation of the IKEA appliance. These restrictions do not apply to fault-free work carried out by a qualified specialist using our original parts in order to adapt the appliance to the technical safety specifications of another EU country. See also general conditions on page 374.

• Repairs caused by installation which is faulty or not according to specification. • The use of the appliance in a non-domestic environment i.e. professional use. • Transportation damages. If a customer transports the product to their home or other address, IKEA is not liable for any damage that may occur during transport. However, in case of IKEA delivery of the product to the customer's delivery address, then eventual damages to the product that occurs during this delivery will be covered by IKEA (but not under this guarantee). For claims under this last particular condition the customer should contact IKEA Customer Service at IKEA.IE • Cost for carrying out the initial installation of the IKEA appliance. These restrictions do not apply to fault-free work carried out by a qualified specialist using our original parts in order to adapt the appliance to the technical safety specifications of another EU country. See also general conditions on page 374.

• Repairs caused by installation which is faulty or not according to specification. • The use of the appliance in a non-domestic environment i.e. professional use. • Transportation damages. If a customer transports the product to their home or other address, IKEA is not liable for any damage that may occur during transport. However, in case of IKEA delivery of the product to the customer's delivery address, then eventual damages to the product that occurs during this delivery will be covered by IKEA (but not under this guarantee). For claims under this last particular condition the customer should contact IKEA Customer Service at IKEA.IE • Cost for carrying out the initial installation of the IKEA appliance. These restrictions do not apply to fault-free work carried out by a qualified specialist using our original parts in order to adapt the appliance to the technical safety specifications of another EU country. See also general conditions on page 374.

• Repairs caused by installation which is faulty or not according to specification. • The use of the appliance in a non-domestic environment i.e. professional use. • Transportation damages. If a customer transports the product to their home or other address, IKEA is not liable for any damage that may occur during transport. However, in case of IKEA delivery of the product to the customer's delivery address, then eventual damages to the product that occurs during this delivery will be covered by IKEA (but not under this guarantee). For claims under this last particular condition the customer should contact IKEA Customer Service at IKEA.IE • Cost for carrying out the initial installation of the IKEA appliance. These restrictions do not apply to fault-free work carried out by a qualified specialist using our original parts in order to adapt the appliance to the technical safety specifications of another EU country. See also general conditions on page 374.

• Repairs caused by installation which is faulty or not according to specification. • The use of the appliance in a non-domestic environment i.e. professional use. • Transportation damages. If a customer transports the product to their home or other address, IKEA is not liable for any damage that may occur during transport. However, in case of IKEA delivery of the product to the customer's delivery address, then eventual damages to the product that occurs during this delivery will be covered by IKEA (but not under this guarantee). For claims under this last particular condition the customer should contact IKEA Customer Service at IKEA.IE • Cost for carrying out the initial installation of the IKEA appliance. These restrictions do not apply to fault-free work carried out by a qualified specialist using our original parts in order to adapt the appliance to the technical safety specifications of another EU country. See also general conditions on page 374.

• Repairs caused by installation which is faulty or not according to specification. • The use of the appliance in a non-domestic environment i.e. professional use. • Transportation damages. If a customer transports the product to their home or other address, IKEA is not liable for any damage that may occur during transport. However, in case of IKEA delivery of the product to the customer's delivery address, then eventual damages to the product that occurs during this delivery will be covered by IKEA (but not under this guarantee). For claims under this last particular condition the customer should contact IKEA Customer Service at IKEA.IE • Cost for carrying out the initial installation of the IKEA appliance. These restrictions do not apply to fault-free work carried out by a qualified specialist using our original parts in order to adapt the appliance to the technical safety specifications of another EU country. See also general conditions on page 374.

• Repairs caused by installation which is faulty or not according to specification. • The use of the appliance in a non-domestic environment i.e. professional use. • Transportation damages. If a customer transports the product to their home or other address, IKEA is not liable for any damage that may occur during transport. However, in case of IKEA delivery of the product to the customer's delivery address, then eventual damages to the product that occurs during this delivery will be covered by IKEA (but not under this guarantee). For claims under this last particular condition the customer should contact IKEA Customer Service at IKEA.IE • Cost for carrying out the initial installation of the IKEA appliance. These restrictions do not apply to fault-free work carried out by a qualified specialist using our original parts in order to adapt the appliance to the technical safety specifications of another EU country. See also general conditions on page 374.

• Repairs caused by installation which is faulty or not according to specification. • The use of the appliance in a non-domestic environment i.e. professional use. • Transportation damages. If a customer transports the product to their home or other address, IKEA is not liable for any damage that may occur during transport. However, in case of IKEA delivery of the product to the customer's delivery address, then eventual damages to the product that occurs during this delivery will be covered by IKEA (but not under this guarantee). For claims under this last particular condition the customer should contact IKEA Customer Service at IKEA.IE • Cost for carrying out the initial installation of the IKEA appliance. These restrictions do not apply to fault-free work carried out by a qualified specialist using our original parts in order to adapt the appliance to the technical safety specifications of another EU country. See also general conditions on page 374.

• Repairs caused by installation which is faulty or not according to specification. • The use of the appliance in a non-domestic environment i.e. professional use. • Transportation damages. If a customer transports the product to their home or other address, IKEA is not liable for any damage that may occur during transport. However, in case of IKEA delivery of the product to the customer's delivery address, then eventual damages to the product that occurs during this delivery will be covered by IKEA (but not under this guarantee). For claims under this last particular condition the customer should contact IKEA Customer Service at IKEA.IE • Cost for carrying out the initial installation of the IKEA appliance. These restrictions do not apply to fault-free work carried out by a qualified specialist using our original parts in order to adapt the appliance to the technical safety specifications of another EU country. See also general conditions on page 374.

• Repairs caused by installation which is faulty or not according to specification. • The use of the appliance in a non-domestic environment i.e. professional use. • Transportation damages. If a customer transports the product to their home or other address, IKEA is not liable for any damage that may occur during transport. However, in case of IKEA delivery of the product to the customer's delivery address, then eventual damages to the product that occurs during this delivery will be covered by IKEA (but not under this guarantee). For claims under this last particular condition the customer should contact IKEA Customer Service at IKEA.IE • Cost for carrying out the initial installation of the IKEA appliance. These restrictions do not apply to fault-free work carried out by a qualified specialist using our original parts in order to adapt the appliance to the technical safety specifications of another EU country. See also general conditions on page 374.

• Repairs caused by installation which is faulty or not according to specification. • The use of the appliance in a non-domestic environment i.e. professional use. • Transportation damages. If a customer transports the product to their home or other address, IKEA is not liable for any damage that may occur during transport. However, in case of IKEA delivery of the product to the customer's delivery address, then eventual damages to the product that occurs during this delivery will be covered by IKEA (but not under this guarantee). For claims under this last particular condition the customer should contact IKEA Customer Service at IKEA.IE • Cost for carrying out the initial installation of the IKEA appliance. These restrictions do not apply to fault-free work carried out by a qualified specialist using our original parts in order to adapt the appliance to the technical safety specifications of another EU country. See also general conditions on page 374.

• Repairs caused by installation which is faulty or not according to specification. • The use of the appliance in a non-domestic environment i.e. professional use. • Transportation damages. If a customer transports the product to their home or other address, IKEA is not liable for any damage that may occur during transport. However, in case of IKEA delivery of the product to the customer's delivery address, then eventual damages to the product that occurs during this delivery will be covered by IKEA (but not under this guarantee). For claims under this last particular condition the customer should contact IKEA Customer Service at IKEA.IE • Cost for carrying out the initial installation of the IKEA appliance. These restrictions do not apply to fault-free work carried out by a qualified specialist using our original parts in order to adapt the appliance to the technical safety specifications of another EU country. See also general conditions on page 374.

• Repairs caused by installation which is faulty or not according to specification. • The use of the appliance in a non-domestic environment i.e. professional use. • Transportation damages. If a customer transports the product to their home or other address, IKEA is not liable for any damage that may occur during transport. However, in case of IKEA delivery of the product to the customer's delivery address, then eventual damages to the product that occurs during this delivery will be covered by IKEA (but not under this guarantee). For claims under this last particular condition the customer should contact IKEA Customer Service at IKEA.IE • Cost for carrying out the initial installation of the IKEA appliance. These restrictions do not apply to fault-free work carried out by a qualified specialist using our original parts in order to adapt the appliance to the technical safety specifications of another EU country. See also general conditions on page 374.

• Repairs caused by installation which is faulty or not according to specification. • The use of the appliance in a non-domestic environment i.e. professional use. • Transportation damages. If a customer transports the product to their home or other address, IKEA is not liable for any damage that may occur during transport. However, in case of IKEA delivery of the product to the customer's delivery address, then eventual damages to the product that occurs during this delivery will be covered by IKEA (but not under this guarantee). For claims under this last particular condition the customer should contact IKEA Customer Service at IKEA.IE • Cost for carrying out the initial installation of the IKEA appliance. These restrictions do not apply to fault-free work carried out by a qualified specialist using our original parts in order to adapt the appliance to the technical safety specifications of another EU country. See also general conditions on page 374.

• Repairs caused by installation which is faulty or not according to specification. • The use of the appliance in a non-domestic environment i.e. professional use. • Transportation damages. If a customer transports the product to their home or other address, IKEA is not liable for any damage that may occur during transport. However, in case of IKEA delivery of the product to the customer's delivery address, then eventual damages to the product that occurs during this delivery will be covered by IKEA (but not under this guarantee). For claims under this last particular condition the customer should contact IKEA Customer Service at IKEA.IE • Cost for carrying out the initial installation of the IKEA appliance. These restrictions do not apply to fault-free work carried out by a qualified specialist using our original parts in order to adapt the appliance to the technical safety specifications of another EU country. See also general conditions on page 374.

• Repairs caused by installation which is faulty or not according to specification. • The use of the appliance in a non-domestic environment i.e. professional use. • Transportation damages. If a customer transports the product to their home or other address, IKEA is not liable for any damage that may occur during transport. However, in case of IKEA delivery of the product to the customer's delivery address, then eventual damages to the product that occurs during this delivery will be covered by IKEA (but not under this guarantee). For claims under this last particular condition the customer should contact IKEA Customer Service at IKEA.IE • Cost for carrying out the initial installation of the IKEA appliance. These restrictions do not apply to fault-free work carried out by a qualified specialist using our original parts in order to adapt the appliance to the technical safety specifications of another EU country. See also general conditions on page 374.

• Repairs caused by installation which is faulty or not according to specification. • The use of the appliance in a non-domestic environment i.e. professional use. • Transportation damages. If a customer transports the product to their home or other address, IKEA is not liable for any damage that may occur during transport. However, in case of IKEA delivery of the product to the customer's delivery address, then eventual damages to the product that occurs during this delivery will be covered by IKEA (but not under this guarantee). For claims under this last particular condition the customer should contact IKEA Customer Service at IKEA.IE • Cost for carrying out the initial installation of the IKEA appliance. These restrictions do not apply to fault-free work carried out by a qualified specialist using our original parts in order to adapt the appliance to the technical safety specifications of another EU country. See also general conditions on page 374.

• Repairs caused by installation which is faulty or not according to specification. • The use of the appliance in a non-domestic environment i.e. professional use. • Transportation damages. If a customer transports the product to their home or other address, IKEA is not liable for any damage that may occur during transport. However, in case of IKEA delivery of the product to the customer's delivery address, then eventual damages to the product that occurs during this delivery will be covered by IKEA (but not under this guarantee). For claims under this last particular condition the customer should contact IKEA Customer Service at IKEA.IE • Cost for carrying out the initial installation of the IKEA appliance. These restrictions do not apply to fault-free work carried out by a qualified specialist using our original parts in order to adapt the appliance to the technical safety specifications of another EU country. See also general conditions on page 374.

• Repairs caused by installation which is faulty or not according to specification. • The use of the appliance in a non-domestic environment i.e. professional use. • Transportation damages. If a customer transports the product to their home or other address, IKEA is not liable for any damage that may occur during transport. However, in case of IKEA delivery of the product to the customer's delivery address, then eventual damages to the product that occurs during this delivery will be covered by IKEA (but not under this guarantee). For claims under this last particular condition the customer should contact IKEA Customer Service at IKEA.IE • Cost for carrying out the initial installation of the IKEA appliance. These restrictions do not apply to fault-free work carried out by a qualified specialist using our original parts in order to adapt the appliance to the technical safety specifications of another EU country. See also general conditions on page 374.

**FAVORIT**

Valid for all pots & pans without non-stick coating (incl. cast iron pots & pans)

**FAVORIT**

Valid for all pots & pans with non-stick coating

**IKEA 365+**

Valid for all pots & pans without non-stick coating

**IKEA 365+**

Valid for all pots & pans with non-stick coating

What is covered under this guarantee?

This guarantee covers function, materials and workmanship in all cookware in the above listed range. The guarantee covers: • Stability of the base. • Washing in a domestic dishwasher (with the exception of non-stick coated items or items made of cast iron which we recommend should be washed by hand. • Non-stick properties on non-stick "pans".

What is not covered under this guarantee?

This guarantee does not cover changes in the appearance of the cookware unless they have a significant effect on function. See also general conditions on page 374.

**SLITBAR****GYNNSAM, IKEA 365+ GNISTRA****What is covered under this guarantee?**

This guarantee covers function, materials and workmanship in all knives in the above listed range. This means that, in normal domestic use and provided that our care instructions are followed, the knives will still work as well as they did when they were new, even after the guarantee time has expired. In order to ensure that the knives continue to work in this manner you should use them (for cutting food only) and should clean the knife by hand once a day and regularly sharpen them. The guarantee covers: • Sharpness of the knife. The knife shall be sharp when you buy it and you will be able to keep it sharp so it can function properly, every day. The knife blade is made of a steel that is hardened so that it is possible to sharpen the knife to original sharpness anytime during the guarantee period. • Durable handle. The handle of the knife should not crack, break or come loose from the blade so that the knife is not possible to use. • That there will not be any corrosion on the knife blade.

Products not covered under this guarantee

The following products in the SLITBAR range are not covered under the guarantee: • SLITBAR carving fork (part of a set with carving fork and carving knife) • SLITBAR knife block dark brown/stainless steel • SLITBAR sharpening steel 25 diamond coated/stainless steel dark brown. See also general conditions on page 374.



It's ok to change your mind

No nonsense return policy

Return unused items in their original packaging within 90 days, together with your till receipt for a full refund. Our 90 days returns policy does not apply to cut fabric, or goods ordered to your specification e.g. made to order sofas. This policy is in addition to your statutory rights.

Cancellations policy

Items ordered in store, to be delivered to you at a later date, can only be cancelled free of charge within 24 hours from the date on which the order was paid for. After this period, a handling fee of €75 applies to any cancellation. Orders for made to order sofas, once confirmed, cannot be cancelled at any time. This policy is in addition to your statutory rights.

Love or exchange

When it comes to mattresses, we offer something special. It is important to us that you love your new SULTAN mattress. So, if after a while you discover that it is too firm or too soft just bring back the mattress and try out a new one. And there's no rush. You have 90 days to sleep on it. You may exchange your mattress once within 90 days if you don't love it, provided your merchandise is not found by IKEA to be dirty, marked, damaged or abused. This policy is valid on all new Sultan mattresses and does not include Sultan bed bases, Sultan bed slats or Sultan mattress pads. This policy is in addition to your statutory rights. See full policy details in store or visit IKEA.IE/BEDROOMS

Price guarantee

Catalogue prices are valid until 18 July 2010. NOTE: We reserve the right to adjust our prices according to any alteration of VAT or any other changes beyond our reasonable control, e.g. major currency fluctuations. Although we do try

to ensure that all information in this catalogue is correct at the time of going to print, we apologise for any alteration to products or range that may be made during its life. Please also note that some articles may vary in size and colour from that shown. (All delivery services are charged separately, and are not included in catalogue prices.)



IKEA Recycles

IKEA believes that it should have an overall positive impact on people and environment. We take actions in our stores to minimise our carbon footprint in all areas of our business. This includes taking responsibility for recycling of our own waste and other items from our customers. IKEA Dublin has a current goal of 90% recycling and is moving towards zero waste to landfill operation.

What is WEEE, battery and accumulators regulation?

The W.E.E.E. (Waste Electrical and Electronic Equipment) and Battery regulation is a legislation that means importers and manufacturers of electrical and electronic equipment (EEE) batteries and accumulators have obligations to finance the collection and recycling of household WEEE and waste batteries in Ireland.

How does it work?



WEEE and Waste batteries covers any household appliance with a plug or a battery that has been discarded at the end of their useful life. Along with waste batteries (i.e AAA, AA), WEEE must not be discarded in a normal rubbish bin or worse still dumped illegally as they may contain chemicals and metals that could cause harm to human health and the environment if not managed properly. The crossed out wheelie bin on all appliances and batteries is to remind us not to put them in the rubbish bin but to separate them for recycling.

How is all that paid for?

Prices of electrical items include a contribution to the producer recycling fund (PRF) to ensure these items are managed in a sustainable way at the end of their useful lives. Where applicable these PRFs are shown visibly to the consumer on the price of new equipment. You will see this on all relevant products in IKEA.

What will IKEA do?

To fulfil these obligations IKEA Dublin will offer free of charge the following services

- Collection for waste batteries and low energy bulbs (CFLs) in our customer services department (no purchase necessary).
- Free drop off facility for WEEE articles in customer services for like for like purchase, this means if you buy a microwave you can return a microwave free of charge for us to recycle for you within 15 (fifteen) days of purchase.
- We will pick up free of charge any large household appliances on a like for like sales basis. Please see our web site or in store for terms and conditions.
- If the product is not ready when we deliver, you can still return it free of charge within 30 (thirty) days from the date of purchase.
- Want to know more about IKEA and the environment, visit IKEA.IE or see in store for details.

It's free to recycle!



Good to know before visiting the store



Disability facilities

For our visitors with disabilities, we are pleased to offer the following services at IKEA stores: Wheelchairs, a hearing loop system, safety alerter pagers and service information and assisted shopping.



Stock availability

If you want to phone an IKEA store,(see below for telephone numbers), a 24-hour automated system helps you check stock availability, store opening hours, events, directions and payment options.



Gift card

The IKEA Gift Card is easy to give, and very easy to use. If you can't decide what to buy friends or family, let them decide, with an IKEA Gift Card. You can buy IKEA Gift Cards up to a maximum value of €250 each. Select a design at the checkout and tell the cashier the value you would like on it. It's that simple! Terms and conditions apply. Ask in store for details.



Payment options

We accept cash, Visa, Maestro, MasterCard, Laser and the IKEA Gift Card.

Contact us



Ask Anna

Need a little more help with your shopping choices? You can use our Ask Anna service, to learn more about the IKEA product range, and about any of our additional services that you might find particularly helpful. Anna is just a click away on your computer. Look for her online.



For more information

Visit us online at IKEA.IE You can access product details, check stock availability, store directions, opening hours, and much more. You can also get started on those new designs you've been promising yourself, with our online Kitchen and Office 3D planners for P.C. users. You can also call us on 1890 987 938, please note that the rates charged for the use of 1890 numbers may vary among different service providers.

You'll find us here!

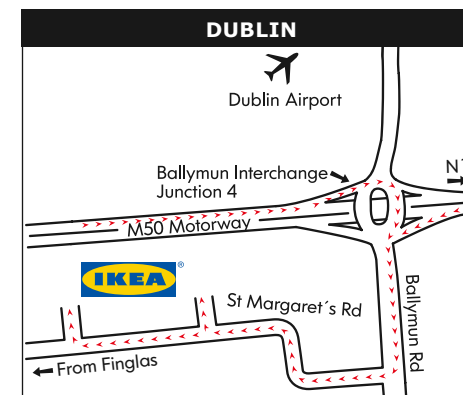

St. Margarets Road
Ballymun, Dublin D11
Phone: 1890 987 938
IKEA.IE

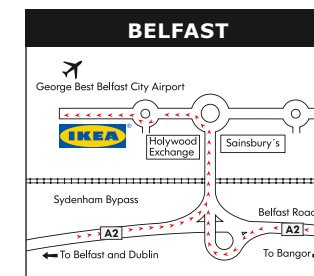

Hollywood Exchange
306 Airport Road West, Belfast BT3 9EJ
Phone: 0845 355 1113
IKEA.CO.UK/BELFAST

For more information on opening times and directions of your IKEA store visit IKEA.IE/DUBLIN

Great meal, fantastic price!



ROLLOVER WEDNESDAYS*

MEATBALLS with potatoes,
cream sauce and lingonberry jam ~~€3.95~~

€1.50

Rollover Wednesdays at the IKEA store all day from 11am,
every Wednesday from 1 September until 31 December 2009

*Valid Wednesdays only.

Every day at IKEA

- Free organic baby food in combination with an adult meal
 - Free refills on coffee, tea & soft drinks
 - Daily organic offer
 - Daily vegetarian offer
 - A big variety of dishes, including a taste of Sweden
 - Play area for children
 - UTZ* Certified coffee
 - Good quality at a low price
- For more information about our offers, visit IKEA.IE/FOOD
- * Certified - produced with care for people and the environment.

24 AUGUST - 13 SEPTEMBER*

PRINCESS CAKE with coffee ~~€1~~
€0.65



*Valid Mondays to Fridays. Offer excludes weekends.

14 SEPTEMBER - 4 OCTOBER*

2 for 1 Breakfast offer

Our 6-item breakfast,
priced at €1.75, includes
back bacon, sausage, scrambled free range
eggs, tomato, baked beans, hash brown

* Breakfast served only on Saturday & Sunday.

5 - 25 OCTOBER*

SHRIMP SANDWICH ~~€2.95~~
2 for 1



* Valid Mondays to Fridays. Offer excludes weekends.

26 OCTOBER - 15 NOVEMBER*

PASTA WITH TOMATO SAUCE ~~€1.95~~
€1.75



* Valid Mondays to Fridays. Offer excludes weekends.

16 NOVEMBER - 6 DECEMBER*

"Better than half price..."
SWEDISH FOOD MARKET OFFER ~~€9.95~~

6-PIECE MEATBALL COMBINATION
€4.95



* Valid Mondays to Fridays. Offer excludes weekends.

7 - 27 DECEMBER*

MARINATED SALMON PLATE ~~€3.90~~
2 for 1



*Valid Mondays to Fridays. Offer excludes weekends.

Index

Accessories..... 334-345
 Armchairs.....50
 Appliances (kitchen).....123-131
 Art.....342

Baby-care/furniture.... 250-257
 Basement storage..... 296-299
 Bar stools..... 101, 107
 Bathroom..... 200-211
 Bathroom organisers...202, 210
 Bed bases..... 184-187
 Bed frames..... 170
 Bed textiles..... 214-223
 Bed sofas.....62-67
 Bedrooms..... 140-189
 Bedroom collections.....158-167
 Bedside tables/chests..... 178
 BEDDINGE sofa-beds.....64
 BESTÅ storage..... 70-75
 BILLY bookcases.....78
 BJURSTA tables.....102
 Blankets.....236
 Blinds.....226, 231
 Bookcases.....78-83
 Bookcase lighting.....332
 Boxes.....300
 BRODER storage.....299
 Brackets/shelves.....282
 Buffets.....90
 Bunk beds.....190, 194

Candles.....338
 Candle holders.....338
 Ceiling lamps.....328
 Chairs (armchairs).....50
 Chairs (dining).....106
 Chairs (office).....278
 Chests of drawers.....178
 Children's IKEA.....246-265
 Clothes organisers.....174
 Coat and hat stands/racks...294
 Coffee tables.....68
 Computer tables.....268, 276
 Cook and Eat.....304-321
 Cots.....250-253, 257
 Crockery.....308-311
 Curtains.....224-235
 Cushions.....236
 Cutlery.....111, 318

Decoration..... 334-345
 Decoration stickers.....196, 342
 Desks.....272, 276, 280
 Desk accessories.....302
 Desk lamps.....326
 Desk chairs.....278
 Dining chairs.....92-103, 106
 Dining collections.....92-103
 Dining.....90-109
 Drawer units.....284
 Drop-leaf tables.....100, 104
 DVD/Audio storage.....78
 Duvet covers.....212-217
 Duvets.....220

EFFEKTIV storage..... 274
 EKTORP sofa range.....246
 Entrance/Hall furnishings.....290-295
 Extending tables.....102-105

FAKTUM kitchens.....112-125
 Floor lamps.....324
 Flooring.....138
 Food storage.....314
 Footstools.....46-49, 52-61
 Free-standing kitchens.....128
 Frames/pictures.....344-346

GALANT desks.....272
 Garage/storage.....296-299
 Glass-door cabinets.....79
 Glasses.....316-321
 GOSA pillows.....218

Hall/entrance furnishings.....290-295
 Hat and coat stands/racks...294
 Heavy-duty storage.....296-299
 HEMNES bedroom furniture...158
 Highchairs.....94, 254
 Home office furniture...266-285
 Home organisation.....290-303
 Home entertainment.....70-87

IKEA 365+ tableware...316-321
 IKEA 365+ cookware.....308

KASSETT boxes.....300
 Kitchen.....112-135
 Kitchen cabinet doors.....132
 Kitchen services.....132
 Knives.....306
 KARLSTAD sofa range.....48
 KOMPLEMENT fittings.....174
 KVARTAL curtain-hanging system.....226, 232

Lamps/shades.....326
 Leather sofas/chairs.....39, 55
 Lighting.....322-333
 Living rooms.....18-39

Mattresses/pads.....182-189
 MALM bedroom furniture.....160
 Media furniture.....70-87
 Mirrors.....168
 MYSA quilts.....220

Occasional tables.....96
 Office furniture.....266-285
 Organising.....290-303

PAX wardrobes.....172
 Pendant lamps.....328
 Photo frames.....342-345
 Pictures/frames.....344-346
 Picture lighting.....332
 Pillows.....218

Pillowcases.....216
 Plates.....316-319
 Plants and pots.....340
 Play furniture.....260-263
 POÅNG armchairs.....50
 Pots and pans.....308-311

Quilts.....220
 Quilt covers.....212-217

Rail systems.....226, 232
 RATIONELL interior fittings..126
 Reading lamps.....326
 Recliners.....60
 Rugs.....238-245

Saucepans.....309
 Seating.....106
 Serving dishes.....320
 Shades (window).....224-235
 Sheets.....216
 Shelves/brackets.....282
 Shelving units.....80-87,296-299
 Shoe racks/cabinets.....294-297
 Sideboards.....99
 Side tables.....68
 Sinks (bathroom).....200-209
 Sinks (kitchen).....114, 128
 Small Business.....288
 Small organisers.....300-302
 Slats (for bed).....186
 Sofas.....44-67
 Sofa beds.....62-67
 Soft toys.....262-264
 Spotlights.....330-332
 Stackable chairs.....100, 107
 Stools.....100, 107
 Storage units.....70-87
 SULTAN mattresses.....182-189
 Swivel chairs (work).....278
 Storage units.....298-301, 70-85
 Swivel chairs (work).....278

Tables.....98-105
 Table lamps.....326
 Table tops.....280
 Tableware.....316-321
 Textiles.....212-245
 Throws.....236
 Toy storage.....258
 Toys.....262-264
 TROFAST storage.....258
 Trolleys (kitchen).....129
 TV solutions.....70-77,84-87

Underbed boxes.....152, 164,
 Uplighters.....324
 Utensils (kitchen).....308-311
 Utility room storage.....296-299

Vases.....336
 Video/audio storage.....70-87
 VIKA table tops.....280
Wardrobes.....142-177

Washbasins/stands.....200-209
 Wall decoration.....342
 Wall lighting.....328-330
 Wall shelves.....282
 Working.....266-285
 Workstations.....268, 276
 Work chairs.....278

Youth room.....190-197

IKEA Information
 Environmental policy.....88
 IKEA Business.....288
 IKEA FAMILY.....360
 IKEA website.....362
 WEEE Information.....378
 Store Information.....379
 Quality guarantees.....374
 Services.....370
 Shopping at the store.....366
 Special offers.....2
 Restaurant.....380

Buying Guides
 ANORDNA interior fittings...355
 ANTONIUS.....348
 BESTÅ storage.....348
 BILLY bookcases.....350
 BRODER storage.....350
 EFFEKTIV storage.....352
 ELGÅ wardrobes.....352
 FRAMSTÅ fittings.....350
 GALANT desks.....353
 GOMORGON.....354
 GORM storage.....355
 INREDA fittings.....350
 KOMPLEMENT fittings.....356
 PAX wardrobes.....356
 STOLMEN storage.....358
 TRÅBY storage.....359



Salmon with vegetable medallions

€4

Stuffed salmon, rich in omega 3, with vegetable medallions, chive and dill sauce

Organic soup of the season*
 €1.75/ea

*Organic and vegetarian soup will vary according to season

Children's meals from €1.25

Choose from lots of tasty and healthy dishes in the kids' menu.

Princess cake
 €1

Swedish pastry made of sponge cake, raspberry jam, whipped cream and green marzipan.

Free for members!*

*Monday to Friday in the restaurant

All coffee sold and served at IKEA is UTZ Certified - produced with care for people and the environment.

If you like Swedish design...
 ... you'll love Swedish food!

IKEA® FOOD

€5.99 /ea

LACK side tables Painted and foil finish or printed and embossed finish. 55x55, H45cm. White. 200.114.13 Black. 200.114.08 Red. 701.042.64 Light blue. 601.513.12 Yellow. 801.513.11

© Inter IKEA Systems B.V. 2009. 91110



ALL CATALOGUE PRICES ARE MAXIMUM PRICES VALID UNTIL 18 JULY 2010

For directions and opening times of your IKEA store, visit our web site at:



IKEA.IE