

If you don't see what you are looking for in our catalog, take a look at our new and improved web site at CGFORDPARTS.COM



On the web site you will find additional parts and thousands of additional pictures in full color.

Fast, secure checkout with new customer account features.

The staff at C & G will help your restoration project go smoothly . . .



Kyle Allen is celebrating his 22nd year here at C&G. With over 30 years experience in the antique Ford parts field, Kyle can offer his assistance in answering your questions regarding FORD parts and their applications. Kyle has restored his own vehicles and is usually found cruising car shows teaching his daughters the fine art of restoration judging. Kyle hails from sunny San Diego and is an avid classic car enthusiast



Clyde and Gail Bangiola now retired, with their 1940 Ford Coupe.



Teresa Jordan is our office manager since 1996. Teresa's exceptional organizational skills and iron-will keep the efficiency high and the bloopers, blunders and gaffes to a minimum at C&G. An avid off road enthusiast, Teresa cruises the SoCal deserts in an F350, driving the family, toys, and trailer to the desert. Teresa hails from Escondido.



Cody Hill with a chopped 1949 Ford Custom hauling his surfboard and a love for all old Fords, Cody has the passion and knowledge to get your order right and make your call an enjoyable experience... dude!



John MacQueen has been in the automotive field for over 25 years. Enthusiastically attending swap meets and car shows, John meets our customers on a regular basis and follows their progress part by part. A native Californian, John and the Missus make Escondido their home.

Charisse Allen is known across the country (and the world) for her prowess in organizing shipments and ensuring packaging invincibility, Charisse utilizes an up to date computer scanning and tracking system to ensure you get all your parts delivered in a timely manner.





Ordering InformationPage 3

Automotive Parts

AccessoriesSection 1Page 8
 BatterySection 18Page 134
 Beauty RingsSection 4Page 32
 Body TrimSection 56Page 323
 Books/CDs/DVDsSection 2Page 16
 BrakesSection 5Page 33
 BumpersSection 33Page 223
 ClutchSection 13Page 99
 ConvertibleSection 48Page 296
 CoolingSection 14Page 104
 Cowl VentSection 36Page 237
 DashSection 40Page 246
 DecalsSection 60Page 346
 DoorSection 45Page 267
 EmblemsSection 26Page 194
 EngineSection 11Page 76
 ExhaustSection 9Page 69
 FenderSection 27Page 198
 FirewallSection 37Page 238
 FloorboardSection 44Page 267
 Floor matsSection 43Page 266
 FrameSection 10Page 72
 Front AxleSection 6Page 48
 Fuel SystemSection 16Page 121
 GeneratorSection 17Page 131
 GlassSection 38Page 240
 Glove BoxSection 42Page 263
 GrilleSection 15Page 114
 HardwareSection 61Page 352
 HeadlinerSection 49Page 299
 HeaterSection 35Page 232

HoodSection 28Page 204
 HornSection 24Page 176
 Hub CapsSection 3Page 31
 IgnitionSection 20Page 142
 InteriorSection 41Page 260
 License PlateSection 23Page 173
 LightsSection 22Page 154
 MirrorsSection 32Page 220
 PaintSection 62Page 358
 Patch PanelsSection 55Page 315
 Pick-Up BedSection 57Page 326
 Quarter WindowSection 50Page 300
 RadioSection 34Page 227
 Rear AxleSection 8Page 63
 Rear WindowSection 51Page 302
 RumbleSection 54Page 311
 Running BoardSection 29Page 211
 Spare TireSection 53Page 310
 SpeedometerSection 31Page 218
 StarterSection 19Page 138
 SteeringSection 7Page 54
 Street RodSection 59Page 340
 SwitchesSection 21Page 150
 TransmissionSection 12Page 92
 TrunkSection 52Page 304
 VentSection 46Page 284
 WindowSection 47Page 288
 WindshieldSection 39Page 241
 WiperSection 30Page 212
 WiringSection 25Page 178
 Woodie/WagonSection 58Page 331

IndexPage 359
Order FormPage 367
Catalog AbbreviationsInside Back Cover

***Prices subject to change
 without notice.***

*Parts subject to availability.
 Not responsible for typographical errors.*

©2009 C & G Early Ford Parts, Inc. All rights reserved.
 No parts of this catalog may be reproduced without written
 consent of
 C & G Early Ford Parts, Inc.

7 REASONS TO ORDER FROM C&G...

1. **Quality**
Our commitment is to give you top quality parts at competitive prices. We only sell the highest quality reproduction parts available. We will not sacrifice quality for lower prices.
2. **Service**
Customer satisfaction is our top priority, we go above and beyond merely "answering the phone". We are committed to helping you with ordering the correct parts for your vehicle. Old Ford parts and customer service are what we do!
3. **Convenience**
You can place your order five ways at C&G Early Ford Parts.
 1. Call our toll free order line and speak with one of our knowledgeable salespeople.
 2. Order online at www.cgfordparts.com.
 3. Fax your order 24 hours a day.
 4. Mail in your order.
 5. Walk in and place your orders.
4. **Selection**
"One call gets 'em all". We stock over 22,000 reproduction parts from more than 300 manufacturers, vendors and suppliers. We also carry N.O.S. (new old stock) parts when available. If you do not find the part you are searching for, simply ask us if it is available. New parts are added to our inventory daily.
5. **Simple Returns**
If you are not satisfied with your purchase, simply give us a call to return it **within** 30 days for a refund, credit, or exchange. The item must be in original condition, uninstalled, unaltered and in original packaging.
6. **Shipping**
Place your order by 1:00 PM Pacific Time and we will ship all in stock items the same day with no "out today fees" or other extra charges..
7. **FREEBIES**
Order \$500.00 or more at one time and receive a FREE C&G T-shirt upon request.

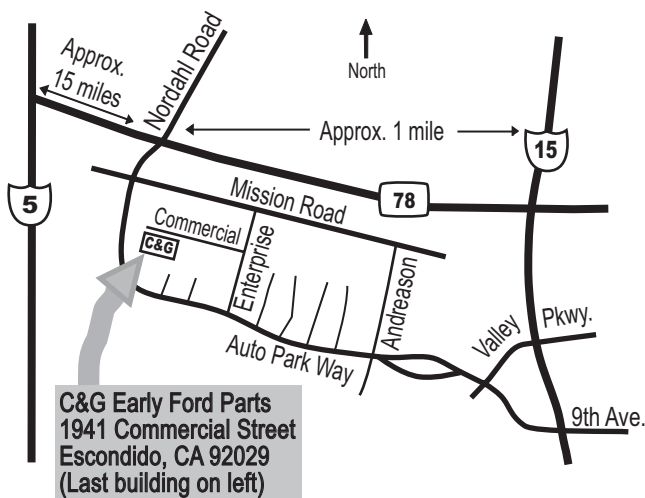

ORDERING INFORMATION & POLICIES

Ordering

Place your order by 1:00 p.m. Pacific Time for same-day shipping of all in stock items.

Phone Orders

Toll Free Order Line: (800) 266-0470. We accept phone orders Monday-Saturday. When placing your order, please provide your customer number, the year and model of your vehicle and the part number. Do you have technical questions?

Please call (760) 871-0445 for free customer technical support.

FAX Orders

Please fill out our order form located in the back of the catalog. Simply use our Toll Free Fax Line: (888) 836-7353 and fax it over. No Form? Write the part numbers and quantities needed along with your name, daytime telephone number, fax number and email address if you have one and fax it over.

Online Orders

Shop online from our secure website, 24/7 at www.cgfordparts.com. We will email you a confirmation when your order is processed.

Mail Orders

Please fill out our order form completely, located in the back of our catalog. In an effort to serve you better, please include a daytime phone number and an email address if you have one.

Walk-in Orders

We invite you to drop by and visit our showroom whenever you are in the beautiful San Diego area. We can fill your order while you wait!

Customer Number

Please provide your customer number on all orders. If you do not have a customer number yet, what are you waiting for? Come enjoy spectacular service and selection! Place your first order with us! (It really is painless)

Customer Service

Please call (760) 740-2400 or email us at info@cgfordparts.com for any questions regarding availability of parts not listed in our catalog, to check on an order, or any other order related questions we can answer for you.

Technical Support

For our valued customers we have free dedicated tech support. Not a customer? What are you waiting for? Come enjoy our fantastic customer service and tech support, place an order today! Please call (760) 871-0445 or email us at info@cgfordparts.com. We will do our best to get an answer for any tech questions regarding Ford parts and their applications.

Price Changes

Because of fluctuations in manufacturing and supplier costs, prices are subject to change without notice. We don't like it any more than you do; unfortunately, it is a part of life. Therefore, if there have been price increases, we will do our best to notify you. For our fax and mail in orders, we will give you a call or send you a note.

NO "OUT TODAY" FEES!



PAYMENT/SHIPPING

Credit Cards

For your convenience, we accept Visa, MasterCard, Discover and American Express. Please provide us with the name on your card, billing address, credit card number, and expiration date. ALL CREDIT DATA IS AUTOMATICALLY ENCRYPTED FOR YOUR PROTECTION!

Prepayment

Personal or company checks are accepted on mail-in orders but will delay your order 14 days due to bank clearance time. For prompt service, please pay with a Postal Money Order or cashier's check. Checks will NOT be accepted at our store location..

NSF Checks

There will be a \$25.00 charge for any returned checks.

Refused Shipments

Unless directed to do so by us, any orders refused delivery by the customer will be charged a 20% restocking fee PLUS freight charges back to C&G.

Shipping

Continental USA: All orders are shipped via UPS Ground Service, US Mail or truck freight. Delivery time varies depending on your location. UPS Next Day, Second Day and 3 Day shipments are available at an additional fee imposed by the carrier. Rates vary depending on weight and dimensions of boxes.

Alaska & Hawaii

All orders are shipped via UPS ground or priority mail. Rates vary depending on weight and dimensions of boxes.

International

All orders are sent by United States Postal Service-Global Express, or UPS according to size and weight limitations. In order to avoid errors, please be specific when ordering parts by including part numbers, year, model, body style, number of cylinders and any special modifications made. All orders must be prepaid with a Credit Card or Cashier's Check (payable in U.S. Funds, through a U.S. bank). A handling fee of \$10.00 or 3.5% of the total, whichever is greater, will be applied to each invoice on all foreign shipments for customs paperwork and specialized boxing and packaging requirements.



Bongo, (one of our friendly customers) checking for small parts amongst the popcorn.

Returns

- Inspect your order upon arrival!
- No returns will be accepted after 30 days without 20% restock fee!
- Absolutely no returns accepted for any reason after six months. No returns on electrical parts, special order parts, or printed matter.
- All returns must have prior authorization. Please call 760-740-2400 for a RMA number.
- All returns must be in original condition and packaging.
- We will not accept returns for parts that have been installed, painted or altered in any way.
- All returned parts will be inspected by our technicians or in some cases by the supplier's technicians (their rules) prior to issuing a credit.
- Please have your order number ready and advise if you would like to exchange the part or receive a refund. If you elect to have an exchange part sent, we will charge you for the part and shipping, and then refund you when we receive your return. Returns must be accompanied by a copy of your invoice along with the Return Authorization number.

We are always ready and willing to provide the customer service needed to help you with your order.

Now let us explain why all the rules...

Once your order is filled our system automatically begins a reorder and restock process. This process includes many behind the scenes activities in our house and at the supplier's house. Our data shows us that this process takes about 30 days to complete. In the meantime if you encounter an issue with your parts and notify us within 30 days (the sooner the better!) this allows us time to avoid our supplier's restock fees. Electrical returns data shows that the number one issue is customer abuse. Special order parts are hard to find parts that the supplier will not take back. Printed matter has been photocopied and the original returned to us many times. After 30 days from invoice date unfortunately we have to charge the restocking fee of 20%, the same one we get charged from our suppliers.

Damaged Shipments

- Inspect your order upon arrival!
- Keep original box and all packaging materials
- Call us to advise you received a damaged package within 24 hours of receipt
- Advise carrier of damaged package
We insure everything we ship, except First Class Mail!
Call us if you encounter any issues with the carrier

Shortages

- Inspect your order upon arrival!

All orders are physically double checked and then electronically scanned when placed into the box to avoid errors. If you are missing a part:

1. Be sure to check the invoice and make sure the item(s) were actually shipped.
2. Please double check all small bags, boxes and packing materials for the missing item(s) before calling. We sometimes include them in there to avoid losing them.
3. Be sure to keep the box and entire contents in the condition you received them. Please have your customer number and order number available.

Back Orders

When placing your order, please advise if you would like us to back order parts that are out of stock, or if you would like to cancel them. Generally, we only back order parts that are expected to arrive within 30 days and are over \$25.00. Shipping charges will apply to all back orders. If you no longer need a back ordered part, please call and cancel to avoid unnecessary shipping charges.

Core Charges

A Core charge will apply if you do not send in your rebuildable core prior to placing your order or if it is not identical to the part purchased. The Core charge will be returned upon receipt and inspection of the old part. All cores must be suitable for reconditioning. Cores requiring extra repair will result in extra charges. Some parts are sold on an exchange only basis.

Sales Tax

California residents are required to add the appropriate sales tax to their orders. Current rate is 8.75%.

Liability

C&G Early Ford Parts will not be held liable for property damage, personal injury, consequential damages, transportation, installation adjustment, or any other expenses that may arise from such parts. Our warranty shall be limited to replacement or repair of such defective parts within 30 days of invoice. A copy of the invoice must be provided. This warranty is made in lieu of any and all warranties expressed or implied, including the warranties of merchantability or fitness.

Shipping Fees

If you place your order before 1:00 PM Pacific Time and the parts are in stock, we guarantee "out today" at no additional charge! After 1P.M, because of daily order volume or your place in the queue, we cannot guarantee "out today" service.

- C&G has no minimum order charge/requirement.
- C&G customers are charged actual shipping costs imposed by the carriers. (Includes insurance.)
- C&G adds \$3.00 to all U.S. orders for packaging materials and boxes. Overseas orders add USD \$10.00 (for customs forms, packaging materials, boxes and any specialized shipping requirements).

- You may expedite your order by requesting Next Day, Second Day, or Three Day delivery services. Charges will vary depending on the weight and dimensions of your order. All back orders are cancelled after 90 days.
- Shipping may be requested through alternative carriers. (i.e.) U.S. Mail or a trucking company. In cases of truck freight carriers, you will be charged actual shipping costs plus crating costs, insurance and any additional fees imposed by these carriers.

THE FOLLOWING CHARGES ARE IMPOSED BY THE CARRIERS!

- **Oversize and Overweight Charges**
UPS requires some items be billed a minimum rate of 30, 70, 90 or 120 pounds because of package dimensions and/or weight.
(i.e.) Batteries, brake drums, bumpers, floor mats, patch panels, large fiberglass items, window channel kits, truck headliners and catalog items where noted.
- **Additional Handling**
UPS stipulates if an item is over 60" long, is odd shaped, or its second largest size is over 30 inches, they require an "additional handling" fee. (i.e.) Bed strips, bumpers, floor mats, window channel strips, exhaust parts, firewall insulators, tailgates, truck headliners, fender aprons, floor pans, patch panels, grills and catalog items where noted.
- UPS requires an additional "delivery area surcharge" to some rural destinations based on zip code.
- UPS requires that businesses operated from a residence that do not have an entrance open to the public be charged the "residential rate".

UPS Ground Shipment Delivery Time from C&G



About the Cover

Special thanks to the following people for permission to use their photos on the cover:



1940 Sedan Delivery
C&G Early Ford Parts



1954 Ford Convertible
Alex Gamble



1956 Pickup
Jack Lee



1942 Mercury Woodie
Nick Alexander

Here's our baby when we adopted it...



Here we are now...



Annual Open House...





Section 1 Accessories

RADIATOR CAP

Chrome Quail Radiator Cap



32 Pass B-18385-CHea. 59.00

Greyhound Radiator Cap

Requires #B-8100-RK



32 Pass B-18390ea. 99.50
 33 Pass 40-18390-Aea. 99.50
 34 Pass 40-18390-Bea. 99.50
 34-36 PU 46-18390ea. 99.50

Radiator Cap Repair Kit

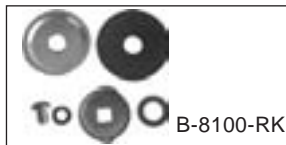

32-34 Pass B-8100-RKkit. 25.00
 32-36 PU B-8100-RKkit. 25.00

Greyhound Ornament



35 Pass 48-18390ea. 99.50
 36 Pass 68-18390ea. 99.50

EXHAUST DEFLECTOR

Accessory Exhaust Deflector



All Pass & PU 51A-18259-A, Ford scriptea. 16.00
 All Pass & PU 51A-18259-B, V-8ea. 16.00
 All Pass & PU 51A-18259-P, plainea. 15.00



49-55 Pass 8A-18259, fin type w/chrome topea. 49.95

LUGGAGE RACK

Luggage Rack

Complete with mounting brackets and trim. It is primmered and ready to paint or powder coat. 34-36 can use original spare tire.

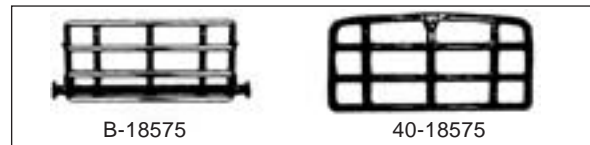

*32 Pass B-18575ea. 325.00
 *33 Pass 18-18575ea. 565.00
 *34 Pass 40-18575ea. 565.00
 *35-36 Pass 48-18575ea. 565.00

Luggage Rack Emblem



34-36 Pass 46-16608, V8ea. 17.50

WIND WING

Chrome Wind Wing Bracket Sets

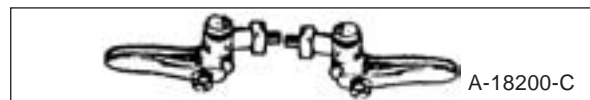

28-32 Cpe A-18200-Cset. 80.00
 28-32 Sdn A-18200-Cset. 80.00
 30-35 Roadster A-18200-Bset. 90.00
 30-35 Phaeton A-18200-Bset. 90.00



68-18200

36	Roadster	68-18200set.	125.00
36	Phaeton	68-18200set.	125.00

Wind Wing Bracket Pad



A-18265

32-35	Roadster	A-18265set.	10.00
32-35	Phaeton	A-18265set.	10.00
36-38	Roadster	48-18262-Sset.	40.00
36-38	Phaeton	48-18262-Sset.	40.00

MIRROR

Stainless Wind Wing Mirror



B-17700-WWC

32-36	Pass	B-17700-WWCea.	30.00
-------	------	-------------	----------	-------

Accessory Sun Visor Mirror



21A-18208

35-37	Pass & PU	48-17676ea.	55.00
42-49	Pass & PU	21A-18208ea.	55.00

VENT SHADES

Door Window Vent Shades

Polished stainless steel. This is a nice dress up item as well as functional.

48-52	PU	7C-18246pr.	46.00
53-55	PU	BAAA-18246pr.	48.00
56	PU	B6C-18246pr.	46.00

LIGHT SWITCH

Accessory Hood & Trunk Light Switch

This replaces original mercury switch. For use with your original light housing

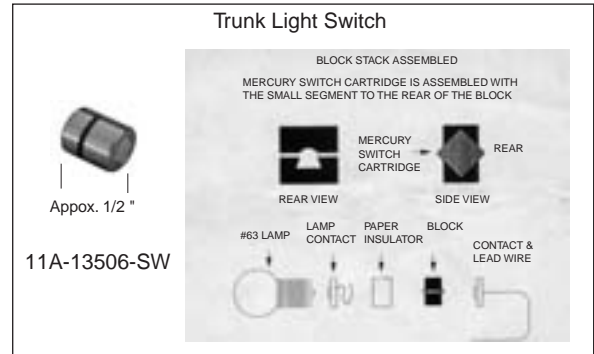

41-48	Pass	11A-13506-SWea.	40.00
-------	------	--------------	----------	-------

FOG LIGHTS/SPOTLIGHT

Unity bracket kits are designed to insure an installation on a horizontal plane at exactly the right place. The bracket kit determines the direction of the hole and assures the drill coming through at the proper spot inside the vehicle.

Fog Light

Brackets are sold separately.



FL-420AP-4015A

All	Pass & PU	FL-420AP-4015A, 5", 6V, Ford scriptpr.	210.00
All	Pass & PU	FL-520AP-F-2, 5", 12V, Ford scriptpr.	174.00

Fog Light Brackets

32-41	Pass	FLB-Bpr.	47.50
39-50	Merc	FLB-Bpr.	47.50
32-47	PU	FLB-Bpr.	47.50

Fog Light Bulbs

U-4015A,	6V, 5", amberea.	40.00
U-4012A,	6V, 6", amberea.	47.00
U-4415A,	12V, 5", amberea.	25.00
U-4412A,	12V, 6" amberea.	25.00



Spot Lights

Brackets are sold separately.



All	Pass	SL-250C-H, 12V, 5", w/15-1/2" long shaft, w/black handle.....ea.	170.00
All	Pass	SL-250K-H, 12V, 5", W/12-1/2" long shaft, w/black handle.....ea.	170.00
35-54	Pass	SL-50A-4515-F-1, 6V, 5", Ford script, w/ivory handle.....ea.	220.00
35-54	Pass	SL-250A-H, 6V, 5", w/ivory handle.....ea.	220.00
All	PU	SL-250C-H, 12V, 5", w/15-1/2" long w/shaft, w/black handle.....ea.	170.00
All	PU	SL-250K-H, 12V, 5", w/12-1/2" long w/shaft, w/black handle.....ea.	170.00
35-54	PU	SL-50A-4515-F-1, 6V, 5", Ford script, w/ivory handle....ea.	220.00
35-54	PU	SL-250A-H, 6V, 5", w/ivory handle.....ea.	220.00

Spot Light Brackets



35-40	Pass	SLB-66L, LH.....ea.	54.00
35-40	Pass	SLB-66R, RH.....ea.	54.00
41-48	Pass	SLB-17L, LH.....ea.	50.00
41-48	Pass	SLB-17R, RH.....ea.	50.00
49-51	Conv	SLB-29L, LH.....ea.	43.00
49-51	Conv	SLB-29R, RH.....ea.	43.00
49-51	Pass	SLB-27L, LH.....ea.	43.00
49-51	Pass	SLB-27R, RH.....ea.	43.00
49-51	Wagon	SLB-26L, LH.....ea.	43.00
52-54	Conv	SLB-44L, LH.....ea.	28.00
55-56	Pass	SLB-84L, LH.....ea.	122.50
55-57	T-Bird	SLB-88L, LH.....ea.	54.00
35-37	PU	SLB-55L, LH.....ea.	55.00
38-47	PU	SLB-69L, LH.....ea.	50.00
38-47	PU	SLB-69R, RH.....ea.	50.00
48-49	PU	SLB-66L, LH.....ea.	54.00
48-49	PU	SLB-66R, RH.....ea.	54.00

Spot Light Bulbs

All		U-4515, 5" ,6V.....ea.	33.00
All		U-4535, 6", 6V.....ea.	33.00
All		UH-7604, 5",12V.....ea.	43.00

Spot Light Top Ornament

35-54	Pass	SL-FORDTAG.....ea.	15.00
35-54	PU	SL-FORDTAG.....ea.	15.00

Spot Light Handle

35-54	Pass & PU	SL-6450, ivory.....ea.	22.00
-------	-----------	------------------------	-------

TIRE COVER

Continental Kit Tire Cover

55-56	Pass	B5A-1351-SS, stainless.....ea.	150.00
-------	------	--------------------------------	--------

SEAT BELTS

Seat Belt

Black with plastic buckle and red push button. Includes hardware



All	All	SB-60, 60".....ea.	19.95
All	All	SB-74, 74".....ea.	22.95

60" Seat Belts

Available in various colors using a chrome aircraft style buckle. Hardware is included. Usually used for rear seat application or thin floor mounted seats.

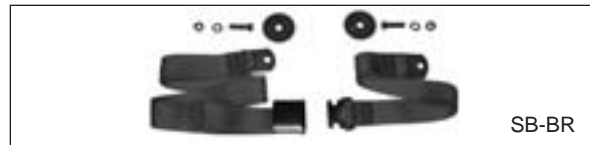

All	All	SB-BK, Black.....ea.	24.95
All	All	SB-BL, Blue.....ea.	24.95
All	All	SB-PB, Powder Blue.....ea.	24.95
All	All	SB-EB, Electric Blue.....ea.	24.95
All	All	SB-DB, Dark Blue.....ea.	24.95
All	All	SB-TQ, Turquoise.....ea.	24.95
All	All	SB-GN, Light Green.....ea.	24.95
All	All	SB-LGN, Light Green.....ea.	24.95
All	All	SB-MG, Military Green.....ea.	24.95
All	All	SB-BN-60, Dark Brown.....ea.	24.95
All	All	SB-AP-60, Medium Beige.....ea.	24.95
All	All	SB-SA, Saddle.....ea.	24.95
All	All	SB-PR, Parchment.....ea.	24.95
All	All	SB-GY, Grey.....ea.	24.95
All	All	SB-WT, White.....ea.	24.95
All	All	SB-IY, Ivory.....ea.	24.95
All	All	SB-SV, Silver.....ea.	24.95
All	All	SB-MR, Maroon.....ea.	24.95
All	All	SB-RD-60, Red Wine.....ea.	24.95
All	All	SB-DR, Dark Red.....ea.	24.95
All	All	SB-BR, Bright Red.....ea.	24.95
All	All	SB-OR, Orange.....ea.	24.95

74" Seat Belts

Available in various colors using a chrome aircraft style buckle. Hardware is included.



All	All	SB-BK-74, Black.....ea.	34.95
All	All	SB-BL-74, Light Blueea.	34.95
All	All	SB-PB-74, Powder Blueea.	34.95
All	All	SB-EB-74, Electric Blueea.	34.95
All	All	SB-DB-74, Dark Blueea.	34.95
All	All	SB-CB-74, Cobalt Blueea.	34.95
All	All	SB-TQ-74, Turquoise.....ea.	34.95
All	All	SB-GN-74, Greenea.	34.95
All	All	SB-MG-74, Military Greenea.	34.95
All	All	SB-LG-74, Lime Greenea.	34.95
All	All	SB-BN-74, Brownea.	34.95
All	All	SB-RT-74, Rust Brownea.	34.95
All	All	SB-AP-74, Antelopeea.	34.95
All	All	SB-TN-74, Tan.....ea.	34.95
All	All	SB-GY-74, Grey.....ea.	34.95
All	All	SB-WT-74, Whiteea.	34.95
All	All	SB-IY-74, Ivoryea.	34.95
All	All	SB-CH-74, Charcoal.....ea.	34.95
All	All	SB-SV-74, Silverea.	34.95
All	All	SB-MR-74, Maroon.....ea.	34.95
All	All	SB-RD-74, Red Wineea.	34.95
All	All	SB-DR-74, Dark Redea.	34.95
All	All	SB-BR-74, Flame Red.....ea.	34.95
All	All	SB-OR-74, Orangeea.	34.95
All	All	SB-PU-74, Purple.....ea.	34.95
All	All	SB-YL-74, Yellow.....ea.	34.95

35 Coupe



Ken Magers

KEY RINGS

Key Rings



KR-118, "Ford".....ea.	3.50
KR-119C, Falcon.....ea.	3.50
KR-124, Mustangea.	3.50
KR-126, "Thunderbird"ea.	3.50
KR-405, "Ford Truck"ea.	3.50

FORD TAGS

Ford Tags



AT-718.....ea.	.20
----------------	-----

DIE CAST COLLECTIBLE

1/43 Die Cast Collectible



48	Wagon	ACC-94251-BU, burgundy.....ea.	7.00
48	Wagon	ACC-94251-T, turquoise.....ea.	7.00
55	Crown Vic	ACC-94202-B, black and white ..ea.	5.50
55	Crown Vic	ACC-94202-P, pink and white.....ea.	5.50
34	PU	ACC-94232-G, greyea.	5.50
34	PU	ACC-94232-R, red.....ea.	5.50
48	PU	ACC-94212-C, cream.....ea.	5.50
48	PU	ACC-94212-R, red.....ea.	5.50
53	F100	ACC-94204-B, blueea.	5.50
53	F100	ACC-94204-W, whiteea.	5.50



1/32 Die Cast Collectible

- 48 PU ACC-FDJ-FTE, green.....ea. 15.95
- 56 PU ACC-FDJ-FFS, red.....ea. 15.95

1/24 Die Cast Collectible



- 38 Truck ACC-20058, firetruck, open cab .ea. 64.95

1/18 Die Cast Collectible

Wagon models include surf board. Sportsman models include top and top boot.



- 46 Sportsman ACC-46SPT-B, burgundyea. 64.95



- 48 Wagon ACC-48WDY-B, burgundyea. 61.50
- 48 Wagon ACC-48WDY-C, creamea. 61.50
- 55 Crown Vic ACC-92138-B, black w/redea. 29.95



- 55 Crown Vic ACC-92138-P, pink w/white.....ea. 29.95
- 48 PU ACC-92218-G, light green.....ea. 28.95



- 48 PU ACC-92218-R, red.....ea. 31.00
- 53 PU ACC-92148-B, burgundy.....ea. 27.50



- 53 PU ACC-92228-O, wrecker, orange ..ea. 43.95

BAG/DECAL

C&G Bag

Great for traveling or tools. Black in color with C&G logo embroidered on side.



- BAG-CGea. 19.95

C&G Early Ford Parts Oval Decal

Just ask for it!, We will give you one!



- All 00-DECAL, 5" x 3"ea. Free

PATCHES/DICE/HAT PIN

Embroidered Oval Patch

- 9647, "Ford V8".....ea. 3.50
- 9647, "Ford V8".....ea. 3.50

Dice



- FD-R, red w/white dots.....pr. 4.50
- FD-BL, blue w/white dots.....pr. 4.50
- FD-BK, black w/wht dotspr. 4.50
- FD-W, white w/black dots.....pr. 4.50

Hat Pin

Same "85" emblem as the 1938 standard hood ornament #81A-8259-A.

- 81A-8259-HP.....ea. 40.00

SHIRTS

Adult T-shirt

New design with a B-24 Liberator, 1940 sedan delivery, and 60HP flathead bomb. C&G Logo on front, sorry no pocket. 100% cotton.



- T-40-M-W, white, medium.....ea. 12.00
- T-40-L-W, white, large.....ea. 12.00
- T-40-XL-W, white, XL.....ea. 12.00
- T-40-XXL-W, white, 2XL.....ea. 14.00
- T-40-XXXL-W, white, 3XL.....ea. 16.00

Aloha Shirts



- HS-DEUCE-B-XL, X-Large, black background with colorful 32 Fordsea. 42.95
- HS-DEUCE-B-2XL, 2X-Large, black background with colorful 32 Fordsea. 44.95
- HS-COOL50-L, Large, blue and white background w/misc carsea. 42.95
- HS-COOL50-XL, X-Large, blue and white background w/misc carsea. 42.95
- HS-COOL50-2XL, 2X-Large, blue and white background w/misc carsea. 44.95
- HS-CHOP-L, Large, blue background with 32-37 Fords.....ea. 42.95

- HS-CHOP-XL, X-Large, blue background with 32-37 Fords.....ea. 42.95
- HS-CHOP-2XL, 2X-Large, blue background with 32-37 Fords.....ea. 44.95
- HS-CUSTOM-L, Large, black background w/misc hotrod cars and trucksea. 42.95
- HS-CUSTOM-XL, X-Large, black background w/misc hotrod cars and trucksea. 42.95
- HS-CUSTOM-2XL, 2X-Large, black background w/misc hotrod cars and trucksea. 44.95
- HS-50DINNER-L, Large, black background with hotrods and dinersea. 42.95
- HS-50DINNER-XL, X-Large, black background with hotrods and dinersea. 42.95
- HS-50DINNER-2XL, 2-X Large, black background with hotrods and dinersea. 44.95
- HS-WOODY-T-L, Large, beige and tan background with a woody and palm treesea. 42.95
- HS-WOODY-T-XL, X-Large, beige and tan background with a woody and palm treesea. 42.95
- HS-WOODY-T-2XL, 2X-Large, beige and tan background with a woody and palm treesea. 44.95
- HS-A50I-L, LARGE blue background with T-birds, Corvettes, and Nomadsea. 42.95
- HS-A50I-XL, X-LARGE blue background with T-birds, Corvettes, and Nomadsea. 42.95
- HS-CC-L, LARGE, California coast sceneryea. 42.95
- HS-CC-XL, X-LARGE, California coast sceneryea. 42.95
- HS-WS-G-L, LARGE, woodies and surf boards on a tan backgroundea. 42.95
- HS-CARHOP-L, LARGE, car hop serving food.....ea. 42.95
- HS-CARHOP-XL, X-LARGE, car hop serving food.....ea. 42.95
- HS-IS-N-XL, X-Large, blue background, with surf boards, hula girls, woodiesea. 42.95
- HS-IS-S-2XL, 2X-Large, slate background, with surf boards, hula girls, woodiesea. 44.95



BEARS

Ford Bear Key Chain

Official licensed bear



ACC-1ea. 2.99

TOOLS

Multi-Tool

Helps with the installation or removal of window rubbers. The specially shaped ball tip keeps from tearing or gouging rubber seals.

All TL-1002ea. 15.00

Window Seal Stick

Made of durable plastic. Good for installing windows, not sharp enough to cut your skin, scratch your paint or tear the rubber. Has a flat end to scrape old rubber off.

TL-1001ea. 3.50

Escutcheon Tool

This handy tool allows you to depress on the escutcheon with your body while keeping your hands free to remove the pin. Tool is made from steel and is rubber coated on the ends to protect your escutcheons.

32-50 Pass TL-111ea. 15.00
 39-50 Merc TL-111ea. 15.00
 32-52 PU TL-111ea. 15.00

PICTURES

Black and White Pictures.

Most of these pictures are Ford factory photos. Some are of restored cars or factory line drawings. Pictures measure 18" x 12".

POSTERS-15,
 Henry Ford's Workshopea. 4.00
 32 All 1932-29, V8 engineea. 4.00
 32 Pass 1932-30, new car dealershipea. 4.00



32 Roadster 1932-2, 3/4 front viewea. 4.00
 32 Sdn Dly 1932-41, period garage areaea. 4.00
 32 Wagon 1932-26ea. 4.00

33 Wagon 1933-17ea. 4.00
 33 Sdn Dly 1933-16ea. 4.00
 34 Pass 1934-29, assembly lineea. 4.00
 34 Roadster 1934-26, in showroomea. 4.00
 34 Cpe 3W 1934-6ea. 4.00
 34 Wagon 1934-14ea. 4.00
 35 Pass 1935-22, assembly lineea. 4.00
 35 Pass 1935-21, european auto expoea. 4.00
 35 Wagon 1935-17ea. 4.00
 35 Sdn Dly 1935-16ea. 4.00
 36 Pass 1936-22, assembly lineea. 4.00
 36 Pass 1936-30, body assemblyea. 4.00
 36 Pass 1936-29, engine assemblyea. 4.00
 36 Pass 1936-25, auto expoea. 4.00
 36 Roadster 1936-2ea. 4.00
 36 Cabriolet 1936-14ea. 4.00
 36 Cpe 3W 1936-7ea. 4.00
 36 Cpe 5W 1936-5ea. 4.00
 36 Wagon 1936-18ea. 4.00
 37 Sdn Dly 1937-13ea. 4.00
 37 Wagon 1937-16ea. 4.00
 37 Wagon 1937-26, 3/4 front viewea. 4.00
 37 Wagon 1937-27, with peopleea. 4.00
 39 Pass 1939-32, dealer showroomea. 4.00
 39 Pass 1939-15, auto expoea. 4.00
 39 Wgn 1939-38, in showroomea. 4.00
 39 All 1939-35, car hauler with cars and trucksea. 4.00
 39 Pass 1939-33, assembly line, engine to frameea. 4.00
 39 Sdn 2D 1939-36, standardea. 4.00
 39 Wagon 1939-10, side viewea. 4.00
 39 Wagon 1939-13, with peopleea. 4.00
 39 Wagon 1939-16, side viewea. 4.00
 39 Wagon 1939-21, side viewea. 4.00
 40 Pass FORD-1940-1, accessory displayea. 50.00
 40 Pass 1940-18, engine assemblyea. 4.00
 40 Pass 1940-16, frame assemblyea. 4.00
 40 Pass 1940-33, dealer showroom with cars and partsea. 4.00
 40 Pass 1940-27, first 40 Ford to be registered in Oregonea. 4.00
 40 Pass 1940-28, loading dock at Consolidated Freightwaysea. 4.00
 40 Sdn Dly 1940-9ea. 4.00
 40 Wagon 1940-11, 3/4 front viewea. 4.00



40 Wagon 1940-15ea. 4.00
 40 Wagon 1940-26, side view with golfersea. 4.00
 41 Pass 1941-5, dealer parts showroomea. 4.00

41	Pass	1941-17, car hauler with new 1941 Ford'sea.	4.00
41	Wagon	1941-4ea.	4.00
41	Wagon	1941-9, side viewea.	4.00
41	Wagon	1941-10, 19,000,000th Ford made with Edsel Fordea.	4.00
41	Wagon	1941-12ea.	4.00
42	Wagon	1942-4, side viewea.	4.00
42	Wagon	1942-8ea.	4.00
46	Pass	1946-13, assembly lineea.	4.00
46	Pass	1946-10, new Fords arrive at dealerea.	4.00
46	Pass	1946-17, loading new 1946 Ford's on transportsea.	4.00
46	Pass	1946-16, unloading new 1946's in front of dealershipea.	4.00
46	Conv	1946-15, crashing from bridgeea.	4.00
46	Sportsman	1946-8, top downea.	4.00
48	Wagon	1948-6, assembly lineea.	4.00
49	Wagon	1949-5ea.	4.00
50	Conv	1950-4ea.	4.00
50	Pass	1950-17, new cars on carrierea.	4.00
50	Conv	1950-14, at drive-in with car hopea.	4.00
50	Wagon	1950-2ea.	4.00
52	Conv	1952-9, in dealer showroomea.	4.00
53	Pass	1953-13, assembly lineea.	4.00
53	Pass	1953-11, end of assembly lineea.	4.00
53	Conv	1953-12, pace car, rear viewea.	4.00
55	Pass	1955-11, at Motorama showea.	4.00
55	Wagon	1955-9, with police making an arrestea.	4.00
56	Pass	1956-10, assembly lineea.	4.00
42	Merc Wgn	MERC 1942-8ea.	4.00
46	Merc Sptsm	1946-14, assembly lineea.	4.00
47	Merc Sptsm	MERC 1947-1ea.	4.00
49	Merc Conv	1949-11, with airplaneea.	4.00
49	Merc Wgn	MERC 1949-2ea.	4.00
50	Merc	1950-5, assembly lineea.	4.00
32	PU	1932-27, roadster pickupea.	4.00
33	PU	1933-15, roadster pickupea.	4.00
34	Panel	1934-23ea.	4.00
39	C.O.E.	1939-39, fleet of C.O.E.'sea.	4.00
40	C.O.E.	1940-30, U.S. Forestryea.	4.00
42	Panel	1942-9ea.	4.00
40	C.O.E.	1940-31, front end viewea.	4.00
50	PU	1950-15, new trucks being loaded on carrierea.	4.00
51	PU	1951-10, new trucks at 1951 auto showea.	4.00
55	Panel	1955-10, at Shell gas stationea.	4.00

POSTERS

Wavecrest Poster

Posters from the annual woodie show in Encinitas California. 24" x 18".

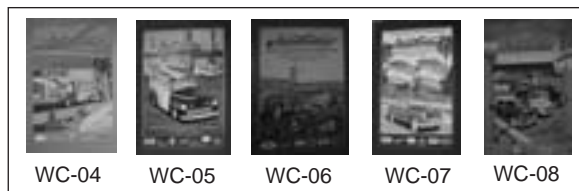

WC-03, 2003ea.	30.00
WC-04, 2004, 25th annualea.	25.00
WC-05, 2005ea.	20.00
WC-06, 2006ea.	15.00
WC-07, 2007ea.	15.00
WC-08, 2008ea.	15.00





101551 101561



V-16 V-42 V-46



V-50 V-51



101521 101531 101541



V-18 V-12 V-17



M-50 M-52

Section 2 Books/CDs/DVDs

We stock a large variety of books for Ford cars and Trucks. Most books we carry are reprints of the originals that were supplied by Ford. The other books we carry are a very good source of information. Whether you are restoring your old Ford, building a hot rod, or you just like collecting books, we have a book for you!

C&G EARLY FORD PARTS CATALOGS

C&G 932-1956 Ford Parts Catalog

32-56	109A-CAT3256-NC, allow 6-8 weeks for delivery	ea.	Free
32-56	109B-CAT3256-US, expedited delivery to U.S.	ea.	5.00
32-56	109C-CAT3256-CM, delivery to Mexico or Canada	ea.	11.00
32-56	109D-CAT3256-OS, delivery overseas	ea.	13.00

C&G 1957-1979 Pickup, 1961-1967 Econoline

57-79	PU	209A-CAT5779-NC, allow 6-8 weeks for delivery	ea.	Free
57-79	PU	209B-CAT5779-US, expedited delivery	ea.	5.00
57-79	PU	209C-CAT5779-CM, delivery to Canada or Mexico	ea.	11.00
57-79	PU	209D-CAT5779-OS, delivery overseas	ea.	13.00

C&G 1957-1972 Passenger

Passenger includes: Fairlane, Falcon, Galaxie, Mustang, Comet, Cougar, Ranchero.

57-72	Car	CATALOG-57-70N/C, allow 6-8 weeks for delivery	ea.	Free
57-72	Car	CATALOG-57-70, expedited delivery	ea.	5.00
57-72	Car	CATALOG-57-70CM, delivery to Canada or Mexico	ea.	11.00
57-72	Car	CATALOG-57-70OS, delivery overseas	ea.	13.00

OWNERS MANUAL

Owner's Manual

32-34	Pass	V-18, 4 cyl.....	ea.	10.00
33	Pass	V-26, V-8.....	ea.	10.00
34	Pass	V-11, V-8.....	ea.	10.00
35	Pass	V-12.....	ea.	10.00
36	Pass	V-17.....	ea.	10.00
37	Pass	V-20.....	ea.	10.00
38	Pass	V-21.....	ea.	10.00
38	Pass	V-27, 60hp	ea.	10.00
39	Pass	V-22.....	ea.	10.00
40	Pass	V-16.....	ea.	10.00
41	Pass	V-23.....	ea.	10.00
42	Pass	V-42.....	ea.	10.00
46	Pass	V-46.....	ea.	10.00
47	Pass	V-47.....	ea.	10.00
48	Pass	V-48.....	ea.	10.00
49	Pass	V-49.....	ea.	10.00
50	Pass	V-50.....	ea.	10.00
51	Pass	V-51.....	ea.	10.00
52	Pass	101521	ea.	10.95
53	Pass	101531	ea.	10.95

54	Pass	101541ea.	10.95
55	Pass	101551ea.	10.95
56	Pass	101561ea.	10.00
39	Merc	M-1ea.	10.00
40	Merc	M-40ea.	10.00
41	Merc	M-41ea.	10.00
42	Merc	M-42ea.	10.00
46	Merc	120461ea.	10.00
47	Merc	120471ea.	10.00
48	Merc	120481ea.	10.00
49	Merc	M-49ea.	10.00
50	Merc	M-50ea.	10.00
51	Merc	M-51ea.	10.00
52	Merc	M-52ea.	10.00
53	Merc	M-53ea.	10.00
54	Merc	M-54ea.	10.00
55	Merc	M-55ea.	10.00
56	Merc	M-56ea.	10.00
55	T-Bird	102551ea.	10.00
56	T-Bird	102561ea.	10.00
32	PU	V-19, V-8ea.	10.00
32-34	PU	V-18, 4 cylea.	10.00
33	PU	V-28, V-8ea.	10.00
34	PU	V-30, V-8ea.	10.00
35	PU	V-29ea.	10.00
36	PU	V-31ea.	10.00
37	PU	V-37-Tea.	10.00
38	PU	V-38-Tea.	10.00
39	PU	V-39-Tea.	10.00
40	PU	V-40-Tea.	10.00
41	PU	V-41-Tea.	10.00
42	PU	V-42-Tea.	10.00
46	PU	111461, 1/2-1 tonea.	10.00
47	PU	111471, 1/2-1 tonea.	10.00
48	PU	111481, F1 thru F8ea.	10.00
49	PU	111491, F1 thru F8ea.	10.00
50	PU	111501, F1 thru F8ea.	10.00
51	PU	V-40ea.	10.00
52	PU	V-52-Tea.	10.00
53	PU	TR-53ea.	10.00
54	PU	TR-54ea.	10.00
55	PU	TR-55ea.	10.00
56	PU	TR-56ea.	10.00

Owner's Service Certificate

39-41	Pass & PU	DF34ea.	3.00
-------	-----------	------	----------	------

SHOP MANUAL

Manuals on CD

1932-48 includes shop manual, service bulletins, body parts, chassis parts, and transmission repair. 1949-51 Pass includes shop manual, chassis & body parts list illustration & text. 1952-54 Pass includes shop manual, chassis & body parts list illustration & text, and Fordomatic manual. 1955-56 Pass includes shop manual, chassis & body parts list illustration & text, A/C manual, and Fordomatic manual.



CD-5600

32-38	Pass	CD-32-38ea.	54.95
39-48	Pass	CD-39-48ea.	54.95
49-51	Pass	CD-49-51ea.	54.95
52-54	Pass	CD-52-54ea.	54.95
55	Pass	CD-5500ea.	54.95
56	Pass	CD-5600ea.	54.95
49-51	Merc	CD-49-51-LMea.	54.95
52-53	Merc	CD-52-53-LMea.	54.95
54-55	Merc	CD-54-55-Mea.	54.95
56	Merc	CD-5600-Mea.	54.95
32-38	PU	CD-32-38ea.	54.95
39-48	PU	CD-39-48ea.	54.95
49-52	PU	CD-49-52-Tea.	54.95
53	PU	CD-53-Tea.	54.95
54-55	PU	CD-54-55-Tea.	54.95
56	PU	CD-56-Tea.	54.95

Service Instructions



V-2

32	Pass & PU	V-2, 88 pgsea.	16.00
33	Pass & PU	V-4, 47 pgsea.	14.00
34	Pass & PU	V-6, 103 pgsea.	12.00

Service Bulletins



P-14

32-37	Pass & PU	P-10, V-8, 494 pgsea.	40.00
38-40	Pass & PU	P-14, V-8, 572 pgsea.	40.00



41-48 Pass & PU P-17, V-8, 380 pgsea. 40.00

Service Manual

32-41 Pass & PU V-224, 222 pagesea. 34.00
 39-48 Pass & PU V-222, 475 pagesea. 54.00

Repair Manual

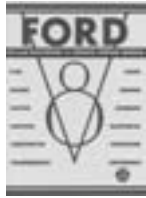

V-14

32-36 Pass & PU V-13, 48 pgs.....ea. 24.00
 37-38 Pass & PU V-14, 34 pgs.....ea. 24.00
 39-40 Pass & PU V-15, 42 pgs.....ea. 24.00

Shop Manuals

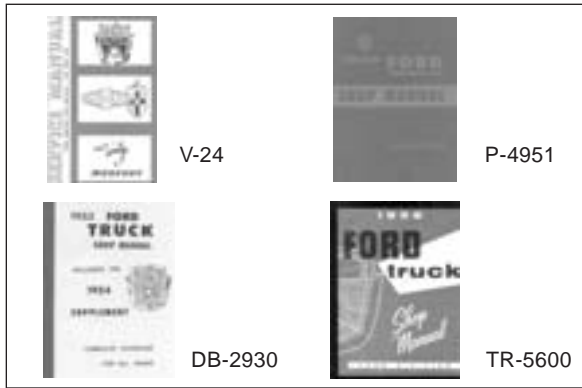

46-48 Pass V-24, 256 pgs.....ea. 30.00
 49-51 Pass P-4951.....ea. 30.00
 52-54 Pass P-5254.....ea. 30.00
 55 Pass CA-5500, 344 pgs.....ea. 33.00
 56 Pass CA-5600ea. 33.00
 46-48 Merc V-24, 256 pgs.....ea. 30.00
 49-51 Merc LM-4951.....ea. 80.00
 52 Merc M-5200ea. 30.00
 53 Merc LM-5300, supplement, use w/M-5200.....ea. 12.00
 54-55 Merc M-5400ea. 40.00
 56 Merc M-5600ea. 45.00
 49-51 Linc LM-4951.....ea. 80.00
 55 T-Bird CA-5500, 344 pgs.....ea. 33.00
 56 T-Bird CA-5600ea. 33.00
 57 T-Bird CA-5700ea. 33.00
 46-47 PU V-24, 256 pgs.....ea. 30.00
 48-51 PU TR-4900, w/52 PU supplementea. 29.95
 53 PU DB-2930ea. 50.00
 54-55 PU TR-5400.....ea. 29.95
 56 PU TR-5600.....ea. 29.95

Fuel System Repair Manual



VB-240

38-48 Pass & PU VB-240, 64 pgs.....ea. 12.00

Generator & Starting System Repair Manual

33-47 Pass & PU VB-241, 44 pgs.....ea. 12.00

Official 12-Volt Conversion Guide

A step by step guide to everything you need to know about upgrading a 6 volt electrical system to 12 volt.

32-55 Pass & PU 6V-12VGUIDE, 28 pgs.....ea. 11.00

Wiring Diagram Manual

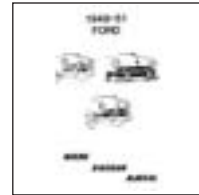

MP-113

49-51 Pass MP-113ea. 6.00
 52-54 Pass MP-114ea. 6.00
 55 Pass MP-115ea. 7.50
 56 Pass MP-116ea. 7.50
 55 T-Bird MP-115ea. 7.50
 56 T-Bird MP-116ea. 7.50

Convertible Top and Window Adjustment Manual

52-54 Conv DG-52-FSMF.....ea. 10.00

MAINTENANCE

Maintenance Manual



C-11

32-48 Pass V-9, 64 pgs.....ea. 10.00
 32-55 Pass C-11, 222 pgsea. 26.00
 32-48 PU V-9, 64 pgs.....ea. 10.00

Maintenance Sheet

55-57 Pass DF76ea. 3.00
 55-57 Merc DL201ea. 3.00
 55-57 PU DF76ea. 3.00

Service Policy

39-40 Pass & PU DF8ea. 3.00
 56 Pass & PU DF29ea. 3.00

ASSEMBLY MANUALS

Electrical Assembly Manual

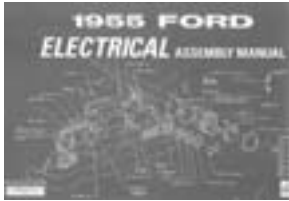

AM-0179

55	Pass	AM-0179ea.	16.00
56	Pass	AM-0181ea.	16.00
55	T-Bird	AM-0098ea.	16.00
56	T-Bird	AM-0096ea.	16.00

Body & Trim Sealant Manual

52	Pass	AM-0172ea.	26.00
53	Pass	AM-0174ea.	26.00
55	Pass	AM-0178ea.	26.00
56	Pass	AM-0180ea.	26.00

Body/Interior Assembly Manual

53	PU	AM-0145ea.	21.00
54	PU	AM-0147ea.	21.00

ENGINE /TRANSMISSION

How to Build Ford Flathead V-8 Horsepower

Covers a build-up of a blown Ardun engine based on a French block. Includes new information on Ardun conversions as well as the latest on flathead goodies.



MB-139914

32-53	Pass & PU	MB-139914, 192 pgsea.	25.95
-------	-----------	--------------------	----------	-------

Rebuilding the Famous Ford Flathead



F-648-A

32-53	Pass & PU	F-648-A, 140 pgsea.	15.00
-------	-----------	------------------	----------	-------

Ford Flathead V-8 Builders Handbook



MB-697

32-53	Pass & PU	MB-697, 160 pgsea.	24.95
-------	-----------	-----------------	----------	-------

Flathead Fever



MB-466

32-53	Pass & PU	MB-466, 80 pgsea.	16.95
-------	-----------	----------------	----------	-------

How to Build the High Performance Street Flathead



MB-126390

32-53	Pass & PU	MB-126390, 88 pgsea.	19.95
-------	-----------	-------------------	----------	-------

Ford Speed Manual

First published in 1952. This is a book on flathead V-8 and 6 cylinder engines and also covers frame modifications.



FB-105

Pass & PU	FB-105, 128 pgsea.	19.95
-----------	-----------------	----------	-------

Souping the Stock Engine

First published in 1950. This book covers flathead V-8 and V-8 60. This book explains general engine performance and shows classic speed equipment. This book also covers Cadillac, Dodge, Chevrolet, Hudson, Offy, and Studebaker engines.



FB-137

Pass & PU	FB-137, 188 pgsea.	15.95
-----------	-----------------	----------	-------

How to Hop Up Ford & Mercury V-8 Engines

This book covers complete engine building for flathead V-8 Ford & Mercury. First printing was 1951.



FB-145

Pass & PU	FB-145, 159 pgsea.	19.95
-----------	-----------------	----------	-------



Blown Flathead



MB-130750-AE

Pass & PU MB-130750-AE, 120 pgsea. 13.00

Standard Catalog of V8 Engines

Starting with the first American built V8 in 1906 through 2002. This book covers all domestic manufactures that made a V8 engine from AMC to Studebaker. Technical data is also covered including cubic inches, torque and horsepower.

All Pass & PU 432-V-8, 288 pagesea. 24.95

Repair Manual

37-48 Pass & PU V-10, 64 pgsea. 12.00

Timing Instruction Manual

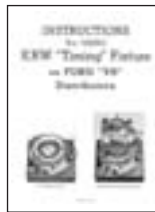

DG-016

32-48 Pass & PU DG-016, KR wilsonea. 8.00

The Ins and Outs of Early Ford Transmissions

This is the best transmission book you will ever have. From the novice to the experienced mechanic. Includes disassembly and reassembly, parts identification, and what gears work together. Excellent black and white pictures.



MVP-TRANS

32-48 Pass MVP-TRANS, 63 pagesea. 35.00

39-48 Merc MVP-TRANS, 63 pagesea. 35.00

32-47 PU MVP-TRANS, 63 pagesea. 35.00

Transmission, Clutch, & Overdrive Repair Manual

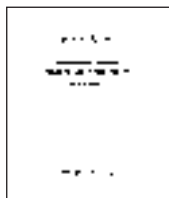

VB-125

32-47 Pass & PU VB-125, 80 pgsea. 12.00

The Overdrive

A complete book on Borg-Warner overdrive transmissions. Includes how the transmission operates, to how to rebuild the overdrive unit. Black and white pictures and diagrams.

49-56 Pass O/D-REBUILD, 16 pgsea. 6.00

49-56 Merc O/D-REBUILD, 16 pgsea. 6.00
 53-56 PU O/D-REBUILD, 16 pgsea. 6.00

REAR AXLE/COLUMBIA

Columbia Axle Installation Instructions

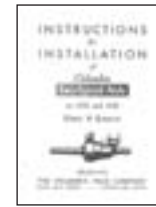

DG-018

33-34 Pass DG-017ea. 4.00
 35-36 Pass DG-018ea. 4.00
 37 Pass DG-019ea. 4.00
 39 Pass 39-COIea. 4.00
 40 Pass DG-020ea. 4.00
 41-48 Pass DG-021ea. 4.00

Columbia Axle Parts List

35-40 Pass DG-022ea. 4.00
 41-48 Pass DG-023ea. 4.00

Columbia Axle Parts & Prices

35-36 Pass CB-35ea. 5.00

Columbia Pamphlet

42-48 Pass LD-002, 4 pgsea. 4.00
 42-48 Merc 42-CSBea. 6.00

Eaton 2 Speed Axle Books

All Truck EA-293/4, 36 pgsset. 25.00

CHASSIS PARTS

Ford chassis parts list books include frame, axle, engine, transmission, cooling & fuel systems, electrical, hood & fender. Most illustrations include basic part number and are helpful for identification.

Chassis Parts List



V-38

FPS-3633

28-32 Pass A-2, 127 pgsea. 16.00
 28-37 Pass V-34, 267 pgsea. 34.00
 28-48 Pass FPS-3633, green book, 802 pgsea. 99.95
 38-41 Pass V-38, 300 pgsea. 34.00
 49-52 Merc MCP-4952, 440 pgsea. 50.00
 28-32 PU A-2, 127 pgsea. 16.00
 28-37 PU V-34, 267 pgsea. 34.00
 28-47 PU FPS-3633, green book, 802 pgsea. 99.95
 38-41 PU V-38, 300 pgsea. 34.00

Chassis Parts and Accessories on CD

28-48	Pass	CD-28-48-DG, 13 volume set, except Mercury	ea.	30.00
49-59	Pass	CD-49-59-DG, 4 volume set except Mercury	ea.	30.00
28-56	PU	CD-28-56-DG, 14 volume set	ea.	30.00

BODY PARTS

These are a reprint of original Ford parts counter books. These books do not show any detailed body pictures, they only show the basic body with part numbers.

Body Parts List

These books contain illustrations and descriptions for the main body components only. For hood, fenders, and running boards, see chassis parts books.



V-37

32	Pass	V-32.....	ea.	18.00
33-34	Pass	V-33.....	ea.	16.00
35-36	Pass	V-35.....	ea.	16.00
37-38	Pass	V-37.....	ea.	16.00
39-40	Pass	V-39.....	ea.	16.00
44-52	Pass	V-44.....	ea.	48.00
53-57	Pass	SF-57	ea.	48.00
32	PU	V-32.....	ea.	18.00
33-34	PU	V-33.....	ea.	16.00
35-36	PU	V-35.....	ea.	16.00
37-38	PU	V-37.....	ea.	16.00
39-40	PU	V-39.....	ea.	16.00
44-52	PU	V-44.....	ea.	48.00
53-57	PU	SF-57	ea.	48.00

COLOR CHIP

Repaint Manual

These helpful books contain paint chips as well as tips to painting.



RMB

V-25

28-36	Pass & PU	RMB, 36 pgs.....	ea.	30.00
37-48	Pass & PU	V-25, 36 pgs.....	ea.	35.00

HARDWARE & TRIM

Hardware & Trim Books

Wondering what some of that missing hardware looks like? These books contain illustrations and descriptions to help decipher what pieces of hardware you may be missing.



AF-01

PF-2

28-34	Pass & PU	AF-01, 68 pgs.....	ea.	12.00
28-38	Pass & PU	PF-2, 168 pgs.....	ea.	24.00

RESTORATION GUIDE

Early Ford V-8 Club Restoration Guides

These books are published by the Early Ford V-8 Club of America to assist you with the restoration of your car. They include the correct colors, coatings, accessories, interior, exterior, and general information.

32	Pass	32REST, 50 pages.....	ea.	19.95
32	Pass	32REST-V2, 2 volume, 620 pages.....	ea.	110.00



33-34REST

33-34	Pass	33-34REST, 456 pages.....	ea.	64.95
-------	------	---------------------------	-----	-------



35-36REST

35-36	Pass	35-36REST, 164 pgs.....	ea.	29.95
-------	------	-------------------------	-----	-------



38-39REST

38-39	Pass	38-39REST, 264 pages.....	ea.	38.50
-------	------	---------------------------	-----	-------



40REST

40	Pass	40REST, 94 pgs.....	ea.	22.95
----	------	---------------------	-----	-------



41-48REST

41-48 Pass 41-48RESTea. 34.95



49-51REST

49-51 Pass 49-51REST, 100 pgs.....ea. 29.95

The Resurrection of Vicky

This book is published by Cars & Parts Magazine, covering their restoration of a 1955 Crown Victoria from start to finish.

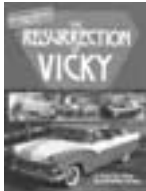

CA-5521

55 Victoria CA-5521, 224 pgs.....ea. 12.95

Collector Car Restoration Bible

Excellent book for the restorer. With 500 color photos showing the how-to's of just about every aspect of restoration from mechanical, electrical, to body work with lead. This is a must for any restorer.

All 432-AJ02, 400 pagesea. 29.99

Ford Pickups 1932-52

This is a beautiful photo history book covering 1932-52 pickups' year by year. Photos include restored and original



MH-100

32-52 PU MH-100, 140 pgs.....ea. 17.00

DETAIL AND SPECIFICATIONS

Ford Closing the Years of Tradition

This book is a "must have" if you are restoring a 1946-48 Passenger car. Reference guide for technical data and accessories. Chassis detail including engine, trans, and brakes.

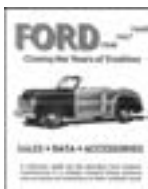

P-15

46-48 Pass P-15, 70+ pagesea. 20.00

Detail & Specification Books

These are copies of the books Ford published for sales representatives to help with general information.



V-43

32	Pass	V-1, 29 pgs.....ea.	10.00
33	Pass	V-3, 29 pgs.....ea.	10.00
34	Pass	V-5, 59 pgs.....ea.	8.00
35	Pass	V-7, 64 pgs.....ea.	8.00
36	Pass	V-8, 64 pgs.....ea.	8.00
32-37	PU	V-41, 32 pgs.....ea.	12.00
38-41	PU	V-43, 37 pgs.....ea.	12.00

Lubrication Chart

32-41 Pass & PU VB-87, 17"x22"ea. 7.50

Quick Facts Books

Reprint of original Ford books you would have seen at a Ford dealer. This book covers everything about the car including colors, interior/exterior, engine, transmission, and options available at that time.



MP-164

MP-36

51	Pass	MP-164, 39 pgsea.	11.00
56	Pass	MP-36, 99 pgsea.	13.00
50	Merc	DG-M50Q.....ea.	6.00
56	T-Bird	MP-36, 99 pgsea.	13.00

Ford Specifications & Accessories

This is an excellent book for specifications of the 1955 passenger cars.



MP-35

55 Pass MP-35, 56 pgsea. 10.95

Standard Catalog of Light Duty Trucks

1896-2000 Helps you find vehicle identification numbers, engine data, and nearly 60,000 updated prices based on the industry standard 1-to-6 vehicle condition rating scale. Nearly 10,000 listings and 3,600 more factory original photos.

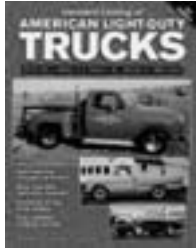

432-PT03

432-PT03, 1088 pgsea. 34.95

SALES BROCHURE

Beautiful color or black and white reprints of the original sales brochures.

Sales Brochures



DG-051

32	Pass	DG-001, foldout typeea.	8.00
32	Pass	DG-002, 24 pgsea.	10.00
33	Pass	DG-003, 12 pgsea.	4.00
33	Pass	DG-004, foldout typeea.	6.00
34	Pass	DG-005, foldout typeea.	8.00
35	Pass	DG-006, 16 pgsea.	8.00
36	Pass	DG-007, 20 pgsea.	6.00
37	Pass	DG-008, 20 pgsea.	8.00
37	Pass	DG-008-F.....ea.	6.00
38	Pass	DG-031, foldout typeea.	7.00
39	Pass	DG-009, 16 pgsea.	8.00
40	Pass	DG-010, 8 pg, foldout typeea.	8.00
40	Wagon	DG-011, foldout typeea.	7.00
41	Pass	DG-041ea.	7.00
42	Pass	DG-042ea.	7.00
46	Pass	DG-046ea.	7.00
47	Pass	DG-047ea.	7.00
49	Pass	DG-049ea.	7.00
50	Pass	DG-050ea.	7.00
50	Crestliner	DG-050Cea.	7.00
50	Wagon	DG-050Wea.	7.00
51	Pass	DG-051ea.	7.00



DG-051V

51 Victoria DG-051Vea. 6.00

51	Wagon	DG-051-Wea.	8.00
52	Pass	52-FSB.....ea.	6.00
52	Pass	DG-052ea.	8.00
52	Conv	DG-052-Cea.	6.00
52	Wagon	DG-052-Wea.	6.00
53	Pass	DG-053ea.	7.00
53	Pass	DG-053-ANV, 50th anniversary ..ea.	8.00
53	Wagon	DG-053-Wea.	6.00
53	Sdn Dly	DG-053-SD.....ea.	8.00
54	Pass	DG-054ea.	8.00
54	Wagon	DG-054-Wea.	6.00
55	Pass	DG-055ea.	7.00
55	Wagon	DG-055-Wea.	8.00
56	Pass	DG-056ea.	7.00
56	Wagon	DG-056-Wea.	10.00
39	Merc	DG-M39.....ea.	8.00
40	Merc	DG-M40.....ea.	8.00
41	Merc	DG-M41.....ea.	8.00
42	Merc	DG-042-Mea.	8.00
46	Merc	DG-M46.....ea.	8.00
47	Merc	DG-M47.....ea.	8.00
49	Merc	DG-M49.....ea.	8.00
50	Merc	DG-M50.....ea.	8.00
51	Merc	DG-M51.....ea.	8.00
51	Merc	DG-M51-C.....ea.	10.00
52	Merc	DG-M52.....ea.	8.00
53	Merc	DG-M53.....ea.	8.00
54	Merc	DG-M54.....ea.	8.00
55	Merc	DG-M55.....ea.	8.00
56	Merc	DG-M56.....ea.	8.00
55	T-Bird	DG-055-TB.....ea.	8.00
56	T-Bird	DG-056-TB.....ea.	8.00
57	T-Bird	DG-057-TB.....ea.	8.00
32	PU	DG-012ea.	6.00
33	PU	DG-013, foldout typeea.	6.00
34	PU	DG-014, foldout typeea.	6.00
34	PU	DG-014-TR.....ea.	10.00
35	PU	V-230.....ea.	8.00
36	PU	DG-015, foldout typeea.	6.00
37	PU	DG-37-Tea.	8.00
37	PU	V-232.....ea.	8.00
38	PU	V-234.....ea.	8.00
39	PU	V-235.....ea.	8.00
40	PU	DG-040-TR.....ea.	8.00
41	PU	DG-041-TR.....ea.	8.00
46	PU	DG-46-Tea.	8.00
51	PU	DG-051-Tea.	8.00
52	PU	DG-052-Tea.	10.00
52	PU	V-239.....ea.	8.00
53	F100	DG-053-Tea.	10.00
54	F100	DG-054-Tea.	10.00
55	F100	DG-055-Tea.	10.00
56	F100	DG-056-Tea.	10.00



ACCESSORY BROCHURE

Often wonder what accessories were available for your old Ford? Here is the answer to your question, a reprint of an original accessory brochure.

Accessory Brochures



DG-51-ACC

33	Pass	DG-025ea.	8.00
34	Pass	DG-026ea.	6.00
35	Pass	DG-027ea.	6.00
36	Pass	DG-028ea.	6.00
37	Pass	DG-037-ACCea.	6.00
38	Pass	DG-029ea.	6.00
39	Pass	DG-030ea.	6.00
40	Pass	DF16ea.	7.00
41	Pass	DG-41-ACCea.	6.00
46	Pass	DG-046-ACCea.	4.00
49	Pass	DG-49-ACCea.	10.00
51	Pass	DG-51-ACCea.	8.00
52	Pass	DG-52-ACCea.	8.00
53	Pass	DG-53-ACCea.	8.00
54	Pass	DG-54-ACCea.	8.00
56	Pass	MP-268ea.	13.00
49	Merc	DG-M49ACCea.	12.00
50	Merc	DG-M50-ACCea.	12.00
51	Merc	DG-M51-ACCea.	12.00
52	Merc	52-MECAea.	8.00
56	Merc	DG-M56-ACCea.	12.00
37	PU	DG-037T-ACCea.	6.00
53	PU	DG-053-TACea.	6.00
56	PU	MP-268ea.	13.00

RADIO INSTRUCTIONS

Are you putting a radio in your old Ford? These were supplied to Ford mechanics to install radios in Ford cars when they were new. These manuals also show operating instructions.

Radio Instruction Manual



RB-41

33-34	Pass	RB-33ea.	6.00
35-36	Pass	RB-36ea.	9.00
37	Pass	RB-37ea.	6.00

38	Pass	RB-38ea.	6.00
39	Pass	RB-39ea.	6.00
40	Pass	RB-40ea.	6.00
41	Pass	RB-41ea.	4.00
42	Pass	RB-42ea.	6.00
46	Pass	RB-46ea.	6.00
47-48	Pass	RB-47ea.	4.00
50	Custom	DF74ea.	4.00
49	Dlx Pass	DF73ea.	4.00
50	Dlx Pass	DF220ea.	4.00
51	Custom	DF139ea.	4.00
51	Dlx Pass	DF75ea.	4.00
52	Pass	DF222ea.	4.00
53	Pass	DF223ea.	4.00
54	Pass	DF122ea.	4.00
49	Merc	DL73ea.	4.00
50	Merc	DL9ea.	4.00
51	Merc	DL72ea.	4.00
52	Merc	DL365ea.	4.00
53	Merc	DL353ea.	4.00
55	Merc	DL11ea.	4.00
56	Merc	DL4ea.	4.00
53-55	F100	TR-5309ea.	6.00

HOW TO BUILD

How to Build a Traditional Hot Rod

This book includes photos and line drawings from the frame, from suspension, and steering, to brakes, engine, and transmission. 160 pages.



VT-HOTROD

VT-HOTRODea.	25.95
-----------	----------	-------

How to Build a Flathead Ford V-8

This book features all the parts and procedures for three distinct engine rebuilds. This book was written with machine shop experience. Detailed information includes all clearances and machining procedures. 250 full color pictures.

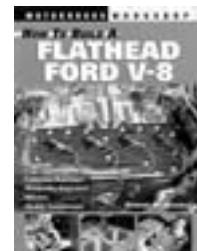

MB-135772

MB-135772-AP, 192 pgsea.	25.95
-----------------------	----------	-------

Builder's Guide to Bolt-Together Street Rods

This book guides the "wannabe" street rod builder through choosing, planning, and building his or her first street rod project. Features detailed info on selecting engines, drivetrains, suspensions, and accessories.



SA-72

SA-72.....ea. 18.95

Building Street Rods, All You Need to Know

A good practical book offering advice on picking the right car to a plan on building the right street rod. Hundreds of tips of working with metal and fiberglass bodies to chassis fabrication and engine rebuilding, to picking out paint and upholstery. Over 200 color photos.

432-SRCB2, 176 pagesea. 24.99

MISC.

'32 Ford Deuce

Excellent book for the 32 enthusiast. A hardbound book that covers the complete history of the 32 Ford. Also included are features on 75 of the top 32 Fords of all time. 250 color and 200 black and white photos.



MB-139630AP

32 Pass MB-139630AP, 324 pagesea. 50.00

Deuce: 75 Years of the '32 Ford

Excellent book FOR ANYONE WHO LIKES 1932 Fords. 200 color and 100 black and white photos that include ford archives, restored cars, and current and vintage hotrods.



CT-413

32 Pass CT-413, hardcover, 192 pagesea. 39.95

Little Deuce Coupe

One of the most recognized hot rods of all time is brought to life in this affectionate look at wild '32 Ford coupes of past and present.



MB-135126

32 Cpe MB-135126, 96 pages, softbound.....ea. 15.95

V-8 Album

Published by The Early Ford V8 Club. A wealth of information on 1932-1953 cars and pick-ups. Includes information on numbers produced, frame numbers, colors, and interiors. Includes Mercury 1939-1953. A must for any early ford lover.



V-8ALBUM

32-53 Pass & PU V-8ALBUM, 350 pagesea. 49.95

River Rouge

Covers the history of Ford's famous assembly plant "River Rouge" from the beginning to present. Includes color and black & white photos. Hardcover.

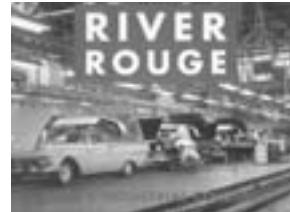

MB-138618

MB-138618, 192 pagesea. 40.00

Ford 100 Years

A comprehensive and authoritative history of the first 100 years of one of the world's most famous car manufacturers.



MB-135942

MB-135942.....ea. 29.95



Ford Fairlane Performance Portfolio 1955-1970

Original magazine articles from Motor Trend, Motor Life, and others covering the cars when they were new.



MB-127365

55-70 Frln MB-127365, 140 pgs.....ea. 24.95

Famous Ford Woodies

Excellent book by Lorin Sorensen. Includes history on 1929-51 Ford and Mercury Woodies with factory photos in black and white and color. Technical data and information make this a must have for any wood restorer. Hardcover.

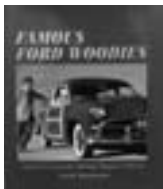

MB-136890-C

MB-136890-C, 248 pagesea. 49.95

Ford Station Wagons Photo History

From the Model T to the Pinto Cruising Wagon, this book chronicles Ford's wagons. Softbound.

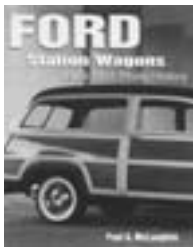

MB-136385-AE

29-91 Wagon MB-136385-AE, 120 pgsea. 24.95

Ford Racing Century

This oversized book is a photo driven look at Ford's voluminous racing history in America.

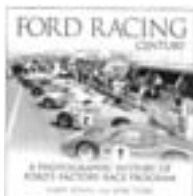

MB-136328

1-79 MB-136328, 304 pages, hardcoverea. 39.95

Ford Pickup Trucks

A new book on Ford trucks from the Model T to the F-series. 237 Color and black and white photos make this a must have for the truck lover.

PU 145423, 192 pagesea. 17.95

Ford F100-F150 1953-96

Packed with factory photos, technical information, original sales literature, specifications and options.



MB-139509

53-96 PU MB-139509, 159 pagesea. 29.95

Ultimate Garages

Illustrated book captures America's fascination with the garage and looks at 24 of the most incredible garages in the United States. The list of garages built by some of the most well-known names in the auto industry, including Bob Lutz, Ken Gross, Brock Yates, Jay Leno, and Bruce Meyer.

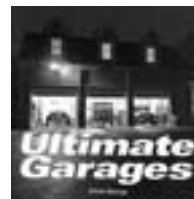

MB-136269

MB-136269, 223 pagesea. 34.95

Lead Sleds

Includes brief histories of cars and all new color photos. It also features supply ideas and detailed information for the dedicated custom techniques, as well as what influenced the builders.

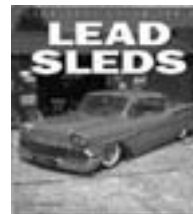

MB-134478

MB-134478, 96 pages 80 color, paperbackea. 15.95

Retro Rods

Find out what hot rod nostalgia is all about. This book features an all color overview of new hot rods built to resemble cars of the '40's and 50's, unique and outrageous customs of the '60's and 70's, and awesome hot rods from the '40's and 50's that have been restored to their former glory.



MB-131575

MB-131575, 96 pagesea. 15.95

Small Fords

This book features all the small cars built by Ford in England and Australia. It includes many tips and techniques on how to restore these cars.



MB-135960

MB-135960, 160 pagesea. 27.95

The Birth of Hot Rodding

Covers profiles of the most influential cars, racers, and events, along with original photos to create definitive history of hot rod racing on the dry lakes. Hardcover



MB-135761

MB-135761-AP, 160 pages.....ea. 39.95

Hot Rod Milestones

Covers 25 of America's Coolest Coupes, Roadsters, and Racers from the late 40's to the mid 60's including each cars history, technical background, and influence is discussed along with information on builders and owners. 250 color photos and 110 black andwhite.



CT980

CT980, 204 pages.....ea. 39.95

The Hemmings Book of Mercurys

This book includes detailed reviews, road tests, and histories that capture the joys of owning a Mercury. Includes hundreds of photos featuring all the details of each model.

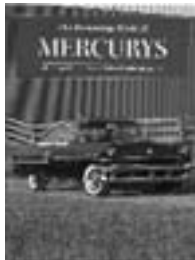

MB-134651

MB-134651-AE, 120 pages.....ea. 19.95

Mercury Automobiles

A photo archive that covers 1939-1959 Mercury cars. 122 black and white photos.

39-59 Merc MB-145953, 128 pagesea. 29.95

Mercury Gold Portfolio 1947-1966

62 Magazine articles from when the cars were new. 200 black and white pictures, 10 color pictures.

47-66 Merc MY-47GP, 176 pagesea. 29.95

Ford's Golden Fifties

Written by Ford historian Lorin Sorensen. This book includes publicity photos and press releases that introduced Mercury, Lincoln convertibles, Hardtop Victorias, Skyliners, and Retractable Hardtops to name a few.



MB-136889-C

MB-136889-C, hardcover, 208 pgs.....ea. 49.95

The Cars that Henry Ford Built

This book covers every car that Henry Ford designed and built at Ford Motor Co. from 1896-mid 40's.

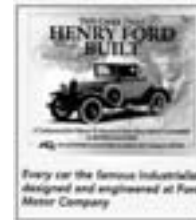

MB-140326

MB-140326, 136 pgs.....ea. 19.95

As Henry Built It

If you are restoring a 1932-38 car or pickup, you need this book. Plenty of illustrations, pictures, and information on chassis, body, and interior.



MCP-100

32-38 Pass & PU MCP-100, 234 pagesea. 45.00

Roy Brizio Street Rods

A history of Roy Brizio Street Rods. 200 Color photos of the dozens of top quality cars that were built in the South San Francisco shop.

MB-145826, 160 pagesea. 35.00



Hot Rods

What started as a craze in Southern California in the 1920's, hot rodding has spread to become a popular pastime on the streets, drag strips, and dry lakes across America. Over 500 photos, along with trends in hot rod history.



MB-135352

MB-135352, 500 series, 400 pgsea. 14.98

Ford Roadster Custom Interiors

A full color book on 1932-34 roadster interiors. Excellent book for roadster lovers or just trying to get an interior idea. By Ron Mangus.

32-34 Roadster CB-261, 160 pgsea. 27.95

Old School Hot Rods

24 different hot rods built more than 40 years ago and still going. With over 200 color pictures it is an enjoyable book for any hot rod lover.

432-OHSR, 176 pagesea. 24.99

Gasser Wars

Drag racing's street classes 1955 to 1968. A great book on vintage drag racing when the cars still looked like street cars. With 100 color and 200 black and white pictures, this is a must have book for any vintage drag racing fan. Softbound.



CT-977-SB

55-68 All CT-977-SB, 192 pagesea. 24.95

Postwar Flathead V-8's Archive

Favorite Fords presented in period B&W photos, complete with detailed captions describing the cars. Original pricing and production numbers provided where available.



MB-135287

46-53 MB-135287, 128 pages, softboundea. 29.95

4x4's Photo History

This book covers every 4x4 built by Ford since the mid 1930s through 1990. Also included are graphs, drawings, specification sheets and the like.

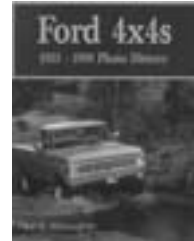

MB-135243

35-90 MB-135243, 120 pages, softboundea. 24.95

Henry's Lady

300 page book covering 1928-1931 Model A's

DB-1002ea. 60.00

The V-8 Affair

This is a good reference book for the 1932-1942 car restorer. Nearly 1,000 illustrations of original and restored cars, showing details of exterior, interior, and chassis, as well as accessories. Hardcover, 303 pgs



DB-1872

DB-1872ea. 60.00

Nifty Fifties

This is a detailed reference book for 1946-59 cars. 1300 photos of cars and parts make this a necessity for the collector or restorer.



DB-1864

DB-1864, 320 pagesea. 60.00

Fords of The Fifties

A very nice book that covers the cars but also the history of Ford from 1949-1959. Very nice color and black and white photos that cover restored cars and when the cars were new.

49-59 Pass MB-130728-AE, 178 pagesea. 24.95

Cars of the Fantastic '50s

Beautiful 192 page hardcover book that covers fifty of the best cars from the big three manufactures and independents. 250 Excellent color photos.

432-CF02, 192 pagesea. 29.99

An Illustrated History of the Ford T-Bird

Packed with over 1,000 illustrations, this book covers 1955-66 T-Birds in a year by year format, showing detailed pictures, options, and accessories.



DB-1924

DB-1924ea. 60.00

Ford Pickup Trucks

Seventy-six color pictures show 1917-1993 Ford pickups. This fun book contains pictures of old sales ads, brochures, and manuals. Full Color. 96 pgs



MB-461

MB-461ea. 15.95

Ford Medium Duty Trucks

Nice book covering 1917-1998 trucks. Includes coverage of all the various models and engines, sales figures, styling and technical developments. 170 black and white photos.

17-98 Truck 10254, 120 pagesea. 24.95

Ford Heavy-Duty Trucks

118 black and white pages of 1948-1998 big trucks.



10137T

10137Tea. 26.95

Catalog of Ford Truck ID Numbers

This is a helpful book for decoding VIN numbers on 1946-1972 Ford pickups, published by Cars & Parts Magazine. Includes the color, trim, transmission, and many other codes to help the pickup owner or buyer. 245 pgs

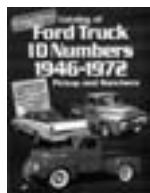

MB-580

MB-580ea. 19.95

Hemmings Motor News

Known as the bible for any car enthusiasts, no matter what make, model or year. Published monthly.

HEMMINGS, current editionea. 5.99

Old Cars Price Guide

Used as a guide for value of old cars and truck. Prices are listed in five various conditions. Published Bi-Monthly.

OLD-PG, current issueea. 4.98

The Hemmings Book of Prewar Fords

13 drive reports of various Fords from 1932-1941. 250 black and white pictures, 16 color pictures.



HMN-A779

32-41 Pass HMN-A779, 120 pgsea. 19.95

The Hemmings Book of Postwar Fords

14 drive reports of various Fords from 1947-1966. 250 black and white pictures, 16 color pictures.



HMN-A759

47-66 Pass HMN-A759, 128 pgsea. 14.95

Ford Hot Rods

This book covers hot rods built before 1960 that have been restored to their modified condition. Model T through 1940 cars are covered in this book with color pictures.



MB-127164

MB-127164, 96 pgsea. 14.95

Ford F-Series Pickup Trucks 1948-1956

A combination of color and black & white pictures of restored and original trucks make this book a must have for any truck lover. Each year is covered separately with valuable information.



MB-127172

MB-127172, 128 pgsea. 24.95

Early V8 Poster

32-48 Cars, 36" x 23" high gloss.

32-48 Pass L-2003ea. 7.00



DVD

The New 1932 Ford V8

60 minutes, black and white.



DVD-2

32 Pass DVD-2.....ea. 24.00

Ford at The 1934-35 Fairs

48 minutes, black and white.

33-34 Pass DVD-3.....ea. 24.00

The New 1935-36 Fords

54 minutes, black and white.

35-36 Pass DVD-4.....ea. 24.00

The New 1937-39 Fords

60 minutes, black and white, and color.

37-39 Pass DVD-5.....ea. 24.00

It's Ford For '40!

50 minutes, black and white, and color.

40 Pass DVD-6.....ea. 24.00

The '49 Ford In Your Future

48 minutes, black and white, and color.

49 Pass DVD-7.....ea. 24.00

The New 1950-51 Fords

60 minutes, black and white, and color.

50-51 Pass DVD-8.....ea. 24.00

The New 1953-54 Fords

60 minutes, black and white, and color.

53-54 Pass DVD-9.....ea. 24.00

The New 1955-56 Fords

60 minutes, black and white, and color.

55-56 Pass DVD-10.....ea. 24.00

Ford and The American Dream

Great story of Ford. Covers model T through the 1970's. 50 minutes of black and white, and color.

03-70 Pass DVD-21.....ea. 24.00

Ford Classics of The Fifties

Shows 1956 Continental Mark 2, 1957 Retractable and 1958 Edsel. 60 minutes, black and white, and color.

56-58 Pass DVD-12.....ea. 24.00

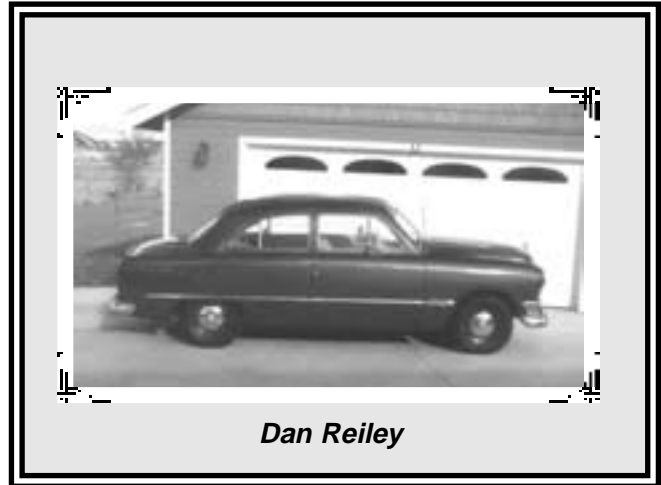

Dan Reiley

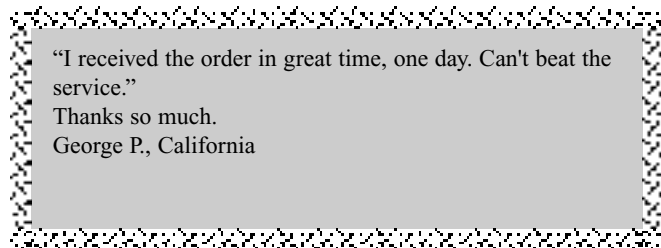

"I received the order in great time, one day. Can't beat the service."
Thanks so much.
George P., California



1933 5 Window Coupe

John C. McKinney

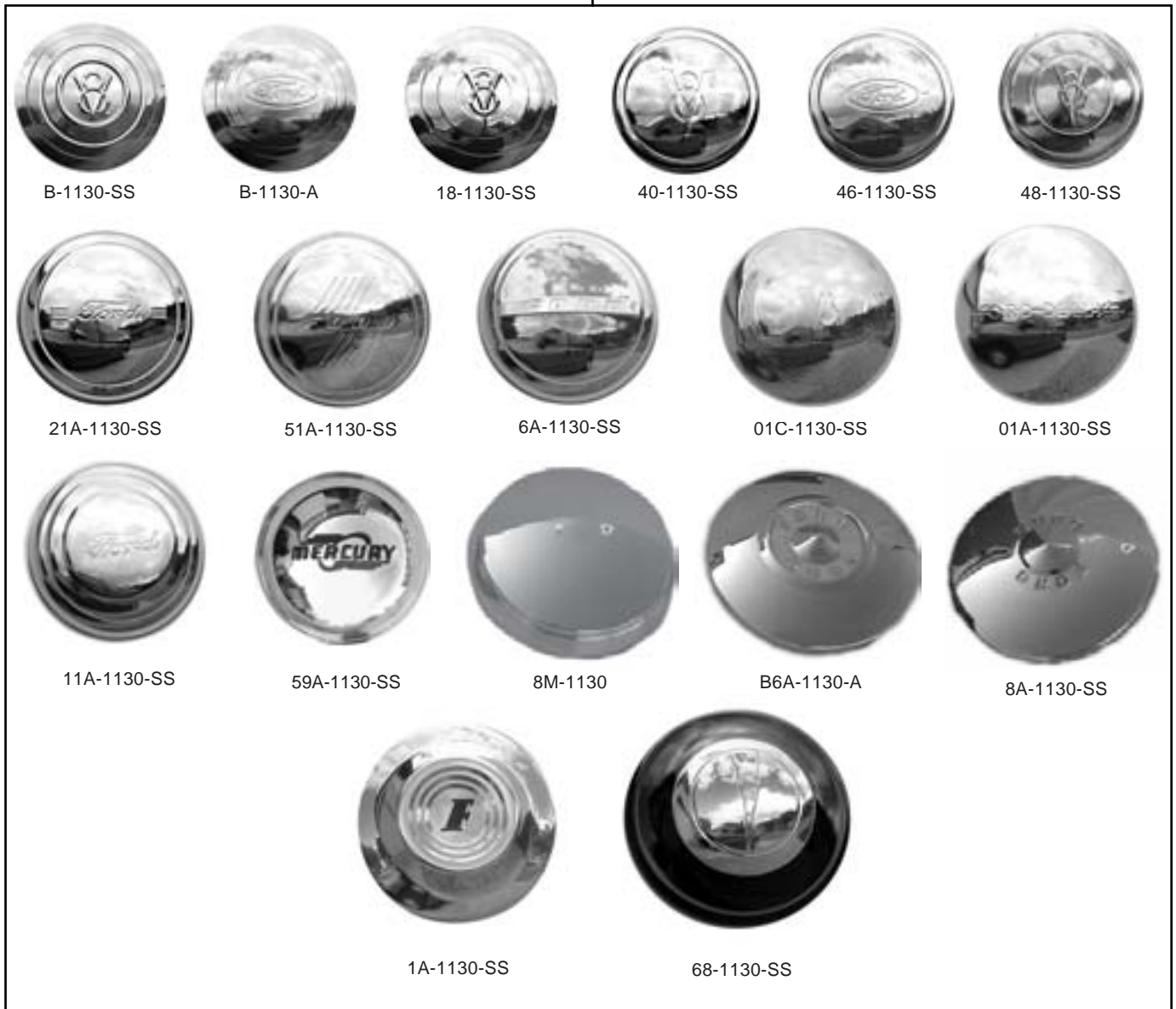

Section 3 Hub Caps

HUB CAPS

Hub Caps

32	Pass	B-1130-SS, V-8.....ea.	30.00
32-33	Pass	B-1130-A, 4 cyl.....ea.	30.00
32-35	Pass	18-1130-BM, smooth w/three ridges.....ea.	30.00
32-35	Pass	40-1130-BM, smooth w/one ridge.....ea.	30.00
33	Pass	18-1130-SS, V-8.....ea.	30.00
34	Pass	40-1130-SS, V-8.....ea.	30.00
34	Pass	46-1130-SS, 4 cyl.....ea.	30.00
35	Pass	48-1130-SS.....ea.	30.00
36	Pass	68-1130-SS.....ea.	48.00

37-39	Pass	68-1130-SS, not original style, replacement.....ea.	48.00
40	Pass	01A-1130-A, not original, w/"V-8".....ea.	35.00
40	Std	01C-1130-SS.....ea.	35.00
40	Dlx	01A-1130-SS.....ea.	35.00
41	Pass	11A-1130-SS.....ea.	35.00
42	Pass	21A-1130-SS.....ea.	35.00
46	Pass	51A-1130-SS.....ea.	35.00
47-48	Pass	6A-1130-SS.....ea.	35.00
49-50	Pass	8A-1130-SS.....ea.	40.00
51	Pass	1A-1130-SS.....ea.	32.00
55	Pass	B5A-1130-A, small, with red painted center.....ea.	47.50
55-56	Pass	B5A-1130-C, full disc.....ea.	80.00
56	Pass	B6A-1130-A, small with white painted center.....ea.	47.50
42	Merc	29A-1130-SS.....ea.	75.00
46	Merc	46M-1130-SS.....ea.	80.00
47-48	Merc	59A-1130-SS.....ea.	80.00
50	Merc	8M-1130.....ea.	27.00



55	T-Bird	B5A-1130-A, small with red painted centerea.	47.50
56	T-Bird	B6A-1130-A, small with white painted centerea.	47.50
32	PU	B-1130-SS, V-8ea.	30.00
32-33	PU	B-1130-A, 4 cyl.ea.	30.00
32-35	PU	18-1130-BM, smooth w/three ridgesea.	30.00
32-35	PU	40-1130-BM, smooth w/one ridgeea.	30.00
33	PU	18-1130-SS, V-8.....ea.	30.00
34	PU	40-1130-SS, V-8.....ea.	30.00
34	PU	46-1130-SS, 4 cyl.ea.	30.00
35	PU	48-1130-SSea.	30.00
36	PU	68-1130-SSea.	48.00
37-39	PU	68-1130-SS, not original style, replacementea.	48.00
40	PU	01C-1130-SSea.	35.00
41-42	PU	11A-1130-SSea.	35.00
46	PU	21A-1130-SSea.	35.00
47-56	PU	6A-1130-SSea.	35.00
48-56	Truck	2J-1130-A, 3/4 ton.....ea.	40.00

Hub Caps with Painted Emblem

32-33	Pass	B-1130-BD, 4cyl.....ea.	35.00
32	Pass	B-1130-VBD, V8.....ea.	35.00
33	Pass	18-1130-BD, V8ea.	35.00
34	Pass	46-1130-BD, 4cylea.	35.00
34	Pass	40-1130-BD, V8ea.	35.00
35	Pass	48-1130-BDea.	35.00
32-33	PU	B-1130-BD, 4cyl.....ea.	35.00
32	PU	B-1130-VBD, V8.....ea.	35.00
33	PU	18-1130-BD, V8ea.	35.00
34	PU	46-1130-BD, 4cylea.	35.00
34	PU	40-1130-BD, V8ea.	35.00
35	PU	48-1130-BDea.	35.00

Baby Moon Hub Caps

All the hub caps listed below fit 40-48 Pass/Merc.

40	Std Pass	01C-1130-BM.....ea.	35.00
40	Dlx Pass	01A-1130BM.....ea.	35.00
41	Pass	11A-1130-BMea.	35.00
42-48	Pass	21A-1130-BMea.	35.00
49-50	Pass	8A-1130-BMea.	40.00
40-48	Merc	29AS-1130-SS.....ea.	44.00
41-42	PU	11A-1130-BMea.	35.00
48-56	PU	21A-1130-BMea.	35.00

Hub Cap Center Medallion



55-56	Pass	B5A-1141-A, for full discea.	25.00
55-56	T-Bird	B5A-1141-A, for full discea.	25.00

**Section 4
Beauty Rings**

BEAUTY RINGS

Outer Beauty Ring

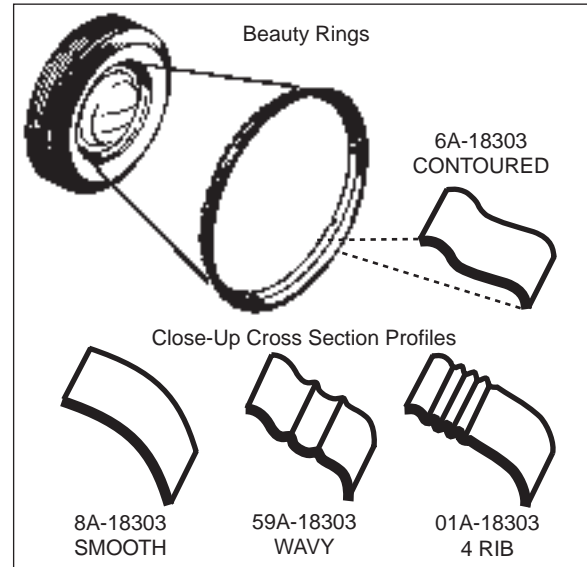

All	Pass & PU	01A-18303-14, 4 rib pattern 14" .ea.	35.00
All	Pass & PU	01A-18303-15, 4 rib pattern 15" .ea.	35.00
All	Pass & PU	01A-18303-16, 4 rib pattern 16" .ea.	35.00
All	Pass & PU	6A-18303-14, contoured 14"ea.	35.00
All	Pass & PU	6A-18303-15, contoured 15"ea.	35.00
All	Pass & PU	6A-18303-16, contoured 16"ea.	35.00
All	Pass & PU	8A-18303-14, smooth 14"ea.	35.00
All	Pass & PU	6A-18303-S15, smooth 15", correct for 1949-51 passenger.....ea.	35.00
All	Pass & PU	59A-18303-14, wavy 14"ea.	35.00
All	Pass & PU	59A-18303-15, wavy 15"ea.	35.00

Inner Beauty Ring

Fits 16" wheel



40-48	Pass	01A-18331ea.	60.00
40-56	PU	01A-18331ea.	60.00

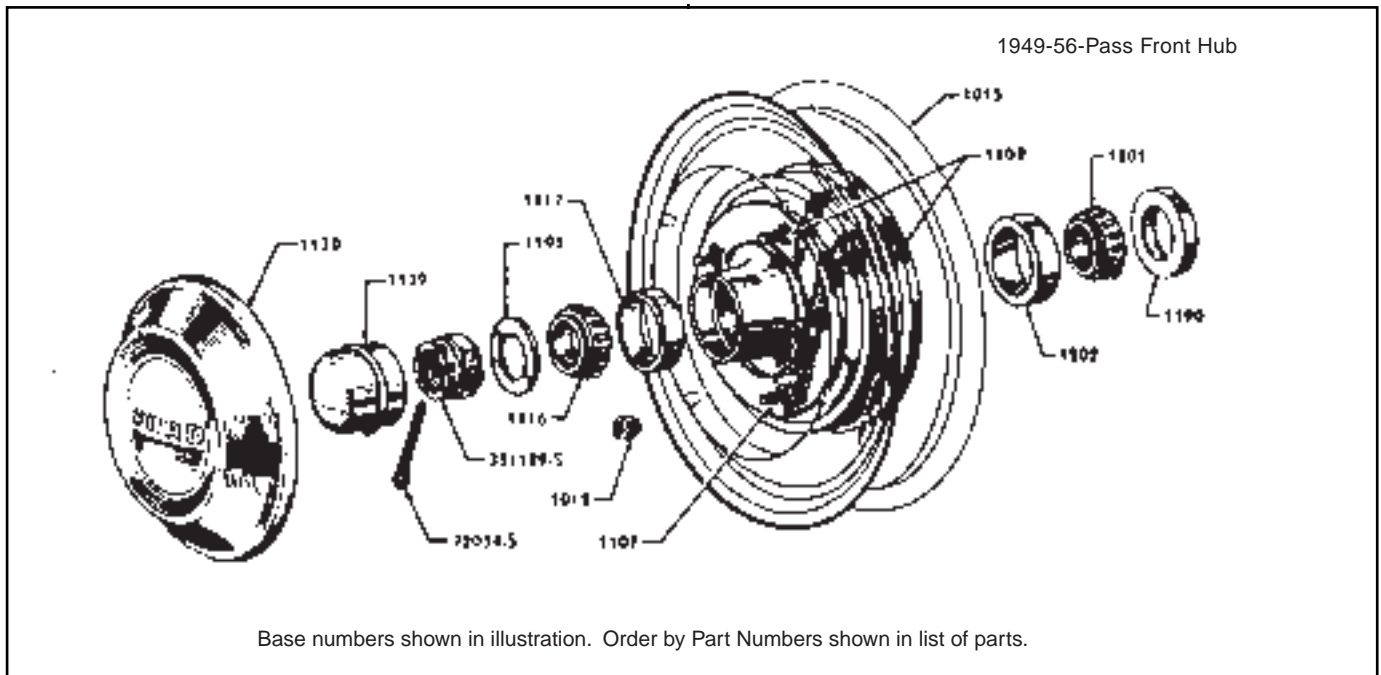

Section 5 Brakes

DRUMS

Wheel Lug Nut

32-70 Pass & PU B-1012ea. .50

Wheel Stud

Front or Rear



32-35	Pass	B-1107	ea.	1.00
36-39	Pass	68-1107, .56" O.D.....	ea.	3.00
40-48	Pass	21A-1107/8-R, must ream stud hole to .600, have to file flat side on head	ea.	3.25
42-48	Pass	51A-1107, use with original drum/hub only	ea.	4.00
46-48	Pass	51A-1107-D, .62" O.D., use w/51A-1125 drum.....	ea.	3.50
49-59	Pass	8A-1107-A.....	ea.	2.50
40-48	Merc	21A-1107/8-R, must ream stud hole to .600, have to file flat side on head	ea.	3.25
42-48	Merc	51A-1107, use with original drum/hub only	ea.	4.00
32-35	PU	B-1107	ea.	1.00
36-39	PU	68-1107, .56" O.D.....	ea.	3.00
40-47	PU	21A-1107/8-R, must ream stud hole to .600, have to file flat side on head	ea.	3.25
46-47	PU	51A-1107-D, .62" O.D., use w/51A-1125 drum.....	ea.	3.50

48-52	PU	8A-1107-A, F-1	ea.	2.50
53-56	PU	8A-1107-A, F-100	ea.	2.50

Front Brake Drum

If you need a new hub for 21A-1125-USA, see 01A-1104. For all other drums, you must use your original hub. Cannot use original studs on 21A-1125-USA or 51A-1125.



40-48	Pass	21A-1125-USA, w/hub mtg. behind must use 21A-1107/8-R when using original hub.....	ea.	125.00
-------	------	--	-----	--------



40-48	Pass	21A-1125-L, w/hub mtg. behind, must use 21A-1107/8-R when using original hub.....	ea.	125.00
40-48	Pass	51A-1125, w/hub mtg. outside	ea.	100.00
49-53	Pass	0A-1125	ea.	100.00
55-56	Pass	B5A-1125	ea.	120.00
40-48	Merc	21A-1125-USA, w/hub mtg. behind must use 21A-1107/8-R when using original hub.....	ea.	125.00
40-48	Merc	21A-1125-L, w/hub mtg. behind, must use 21A-1107/8-R when using original hub.....	ea.	125.00
52-54	Merc	B5A-1125	ea.	120.00
55-56	T-Bird	B5A-1125	ea.	120.00



40-47	PU	21A-1125-USA, w/hub mtg. behind must use 21A-1107/8-R when using original hub.....ea.	125.00
40-47	PU	21A-1125-L, w/hub mtg. behind, must use 21A-1107/8-R when using original hub. looks like a lincoln drum.....ea.	125.00



40-47	PU	51A-1125, w/hub mtg. outsideea.	100.00
48-52	PU	8C-1125, F-1.....ea.	100.00
48-50	PU	8D-1125, F-2, F-3 12" x 2"ea.	115.00
53-63	PU	A8TZ-1125, F-100ea.	110.00

Rear Brake Drum

If you need a new hub for 21A-1125-USA, see 01A-1105. For all other drums, you must use your original hub. Cannot use original studs on 21A-1125-USA or 51A-1125.

40-48	Pass	21A-1125-USA, w/hub mtg. behind must use 21A-1107/8-R when using original hub.....ea.	125.00
40-48	Pass	21A-1125-L, w/hub mtg. behind, must use 21A-1107/8-R when using original hub. looks like a lincoln drum.....ea.	125.00
40-48	Pass	51A-1125, w/hub mtg. outsideea.	100.00
49-54	Pass	AB-1126, except wagonea.	98.00
55-56	Pass	B5A-1126ea.	110.00
40-48	Merc	21A-1125-USA, w/hub mtg. behind must use w/21A-1107/8-R when using original hub.....ea.	125.00
40-48	Merc	21A-1125-L, w/hub mtg. behind, must use 21A-1107/8-R when using original hub. looks like a lincoln drum.....ea.	125.00
40-48	Merc	51A-1125, w/hub mtg. outsideea.	100.00
52-54	Merc	B5A-1126ea.	110.00
55-56	T-Bird	B5A-1126ea.	110.00
40-47	PU	21A-1125-USA, w/hub mtg. behind must use w/21A-1107/8-R when using original hub.....ea.	125.00
40-47	PU	21A-1125-L, w/hub mtg. behind, must use 21A-1107/8-R when using original hub. looks like a lincoln drum.....ea.	125.00
40-47	PU	51A-1125, w/hub mtg. outsideea.	100.00
48-50	PU	8D-1126, F-2, 12" for 8 studsea.	115.00
48-67	PU	A8TZ-1126, F-1, F-100ea.	85.00
56-65	PU	B6D-1126, F-250, F-350ea.	120.00

Rear Brake Drum Retainer

Bolts to backing plate. Will retain the brake drum if your axle breaks.



39-48	Pass	91A-2215set.	34.95
39-48	Merc	91A-2215set.	34.95
39-47	PU	91A-2215set.	34.95

Hydraulic Brake Adapter Kit

For spindles, four pieces.

28-36	Pass & PU	X-2000set.	25.00
-------	-----------	------------------	-------

Wire Wheel Adapters

For bolting 28-35 wire wheels to 40-48 brake drums.

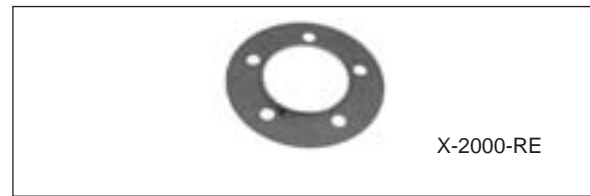

28-35	Pass & PU	X-2000-RE, for use w/replacement 1940-48 drumsea.	20.00
-------	-----------	---	-------

FRONT HUB

Front Brake Drum Hub

For use w/21A-1125-USA brake drum. Studs,races, and dust cap included. Drum will slide over hub. Pressing is not required.



40-48	Pass	01A-1104ea.	160.00
40-48	Merc	01A-1104ea.	160.00
40-47	PU	01A-1104ea.	160.00

Front Hub Dust Cap



32-35	Pass	B-1139ea.	4.00
36-45	Pass	68-1139, threadedea.	5.00
45-54	Pass	51A-1139, no threadsea.	5.00
45-54	Pass	51A-1139-USA, no threadsea.	6.00
49-70	Pass	B5A-1131-Aea.	5.00
39-46	Merc	68-1139, threadedea.	5.00

46-54	Merc	51A-1139, no threads	ea.	5.00
46-54	Merc	51A-1139-USA, no threads	ea.	6.00
55-59	Merc	B5A-1131-A	ea.	5.00
55-62	T-Bird	B5A-1131-A	ea.	5.00
32-35	PU	B-1139	ea.	4.00
36-45	PU	68-1139, threaded	ea.	5.00
45-56	PU	51A-1139, no threads	ea.	5.00

Front Hub Outer Bearing



28-48	Pass	B-1216	ea.	20.00
49-54	Pass	8A-1216	ea.	15.50
55-70	Pass	B5A-1216-A	ea.	8.50
39-48	Merc	B-1216	ea.	20.00
49-51	Merc	8M-1216	ea.	25.50
52-54	Merc	8A-1216	ea.	15.50
54-59	Merc	B5A-1216-A	ea.	8.50
55-62	T-Bird	B5A-1216-A	ea.	8.50
28-47	PU	B-1216	ea.	20.00
48-56	PU	8A-1216	ea.	15.50

Front Hub Outer Race



28-48	Pass	B-1217	ea.	10.00
49-54	Pass	8A-1217	ea.	8.00
55-70	Pass	B5A-1217-A	ea.	5.00
39-48	Merc	B-1217	ea.	10.00
49-51	Merc	8M-1217	ea.	10.50
52-54	Merc	8A-1217	ea.	8.00
54-59	Merc	B5A-1217-A	ea.	5.00
55-62	T-Bird	B5A-1217-A	ea.	5.00
28-47	PU	B-1217	ea.	10.00
48-56	PU	8A-1217	ea.	8.00

Front Hub Inner Bearing



28-48	Pass	B-1201	ea.	20.00
49-54	Pass	8A-1201	ea.	18.50
55-70	Pass	B5A-1201-A	ea.	11.00
39-48	Merc	B-1201	ea.	20.00
49-51	Merc	01Y-1201	ea.	24.00
52-54	Merc	8A-1201	ea.	18.50
54-59	Merc	B5A-1201-A	ea.	11.00
55-64	T-Bird	B5A-1201-A	ea.	11.00
28-47	PU	B-1201	ea.	20.00

48-56	PU	01Y-1201	ea.	24.00
-------	----	----------------	-----	-------

Front Hub Inner Race



28-48	Pass	B-1202	ea.	13.00
49-54	Pass	8A-1202	ea.	7.00
55-70	Pass	B5A-1202	ea.	6.00
39-48	Merc	B-1202	ea.	13.00
49-51	Merc	01Y-1202	ea.	9.00
52-54	Merc	8A-1202	ea.	7.00
54-59	Merc	B5A-1202	ea.	6.00
55-64	T-Bird	B5A-1202	ea.	6.00
28-47	PU	B-1202	ea.	13.00
48-56	PU	01Y-1202	ea.	9.00

Front Wheel Grease Seal



28-34	Pass	B-1190	ea.	2.50
35-48	Pass	48-1190	ea.	4.00
49-53	Pass	8A-1190-A	ea.	5.00
54	Pass	AD-1190-B, NOS	ea.	8.50
55-59	Pass	B5A-1190-A	ea.	4.50
39-48	Merc	48-1190	ea.	4.00
49-51	Merc	8M-1190	ea.	16.00
52-53	Merc	8A-1190-A	ea.	5.00
54-59	Merc	B5A-1190-A	ea.	4.50
55-62	T-Bird	B5A-1190-A	ea.	4.50
28-34	PU	B-1190	ea.	2.50
35-47	PU	48-1190	ea.	4.00
48-56	PU	01Y-1190-A	ea.	5.00

Spindle Nut Cotter Pin

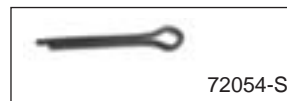

All	Pass & PU	72054-S	ea.	.25
-----	-----------	---------------	-----	-----

Spindle Nut & Cotter Pin

Set includes one nut & one pin.

28-35	Pass & PU	1155	set.	2.25
-------	-----------	------------	------	------

Spindle Nut



36-48	Pass	351129-S	ea.	3.25
36-47	PU	351129-S	ea.	3.25



Replacement Spindle Nut & Special Washer

Replaces original style nut for a more precise adjustment.



32-56 Pass & PU 374504/36set. 5.00

Front Hub Grease Retaining Washer



28-54	Pass	B-1195ea.	2.00
55-69	Pass	C2AZ-1195-Aea.	18.00
39-54	Merc	B-1195ea.	2.00
54-59	Merc	C2AZ-1195-Aea.	18.00
55-69	T-Bird	C2AZ-1195-Aea.	18.00
28-56	PU	B-1195ea.	2.00

REAR HUB/AXLE

Rear Brake Drum Hub

For use w/21A-1125-USA brake drum. Studs, seal, and snap ring included. Requires 68-1225 bearing. Drum will slide over hub. Pressing is not required.



40-48	Pass	01A-1105ea.	225.00
40-48	Merc	01A-1105ea.	225.00
40-47	PU	01A-1105ea.	225.00

Rear Hub Bearing

The 68-1225 bearing is hardened.



28-36	Pass	B-1225-A, 3.12" O.D.ea.	32.00
36-48	Pass	68-1225, 2.78" O.D.ea.	46.00
39-48	Merc	68-1225, 2.78" O.D.ea.	46.00
28-36	PU	B-1225-A, 3.12" O.D.ea.	32.00
36-47	PU	68-1225, 2.78" O.D.ea.	46.00

Rear Hub Grease Seal



28-38	Pass	B-1175, 3.19" O.D.ea.	4.00
38-48	Pass	78-1175, 2.78" O.D.ea.	4.00
39-48	Merc	78-1175, 2.78" O.D.ea.	4.00
28-38	PU	B-1175, 3.19" O.D.ea.	4.00
38-47	PU	78-1175, 2.78" O.D.ea.	4.00
48-53	F-2	8D-1175ea.	13.00
34-47	Truck	BB-1175-C, 4.56" O.D.ea.	20.00

Rear Wheel Bearing Nut

N.O.S. with pin.

40-47	Truck	BB-4252/4254, 2-3/16" I.D., 3" O.D.ea.	10.00
-------	-------	-------------------------------------	----------	-------

Rear Wheel / Axle Seals



49-56	Pass	8A-1177-Aea.	5.00
49-51	Merc	B7A-1177-A, 1-1/2" ID 2-1/2" ODea.	5.00
52-54	Merc	8A-1177-Aea.	5.00
52-54	Merc Wgn	B7A-1177-A, 1-1/2" ID 2-1/2" ODea.	5.00
55-56	Merc	B7A-1177-A, 1-1/2" ID 2-1/2" ODea.	5.00
48-62	PU	B7A-1177-A, 1-1/2" ID 2-1/2" ODea.	5.00

Rear Hub Grease Seal Snap Ring



28-38	Pass	B-1180ea.	2.00
38-48	Pass	78-1180ea.	1.75
39-48	Merc	78-1180ea.	1.75
28-38	PU	B-1180ea.	2.00
38-47	PU	78-1180ea.	1.75

Rear Hub Gasket

Mounts on outside of drum in recess under axle nut washer.

28-48	Pass	B-1183pr.	2.00
39-48	Merc	B-1183pr.	2.00
28-47	PU	B-1183pr.	2.00

Rear Axle Nut Washer

32-48	Pass	351505-S8ea.	.50
32-48	Merc	351505-S8ea.	.50
32-47	PU	351505-S8ea.	.50

Rear Axle Nut and Cotter Pin

Set includes one nut and one pin.

28-48	Pass	1155Aset.	1.50
39-48	Merc	1155Aset.	1.50

28-48 PU 1155Aset. 1.50

Rear Axle Bearing & Retainer

Tech Tip: If it sounds like gravel while your tire is turning, you need bearings now!!!!

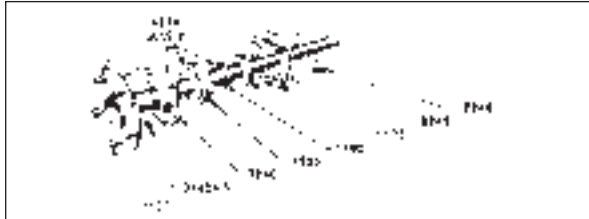

Base numbers shown in illustration.
Order by Part Numbers shown in list of parts.

49-56 Pass 8A-1225/1180set. 28.00



- 49-56 Wgn 8M-1225-A/1180set. 28.00
- 49-51 Merc 8M-1225-A/1180set. 28.00
- 52-54 Merc 8A-1225/1180set. 28.00
- 52-54 Merc Wgn 8M-1225-A/1180set. 28.00
- 55-58 Merc 8M-1225-A/1180set. 28.00
- 48-70 PU 8M-1225-A/1180set. 28.00

Rear Wheel Bearing Retainer Gasket

49-56 Pass 8A-2245ea. 3.00



- 49-56 Wgn 8M-2245ea. 3.00
- 49-52 Merc 8M-2245ea. 3.00
- 48-56 PU 8M-2245ea. 3.00

Backing Plate to Axle Housing Gasket

49-56 Pass 8A-2256ea. 3.00



- 49-56 Wgn 8M-2245-Aea. 3.00
- 49-52 Merc 8M-2245-Aea. 3.00
- 48-56 PU 8M-2245-Aea. 3.00

BACKING PLATE ASSEMBLIES



New Front Backing Plates

New "Bendix" style brakes. Includes: wheel cylinder, brake shoes, and brake shoe springs with adjuster. For 12" drums.

- 32-36 Pass 48-2013, RH or LHea. 225.00
- 37-48 Pass 78-2013, RH or LHea. 225.00
- 39-48 Merc 78-2013, RH or LHea. 225.00
- 32-36 PU 48-2013, RH or LHea. 225.00
- 37-47 PU 78-2013, RH or LHea. 225.00

New Rear Backing Plates

New "Bendix" style brakes. Includes: wheel cylinder, brake shoes, and brake shoe springs with adjuster. For 12" drums. Emergency brake links are sold separately.

- 32-34 Pass 40-2213, RHea. 225.00
- 32-34 Pass 40-2214, LHea. 225.00
- 35-48 Pass 48-2213, RHea. 225.00
- 35-48 Pass 48-2214, LHea. 225.00
- 39-48 Merc 48-2213, RHea. 225.00
- 39-48 Merc 48-2214, LHea. 225.00
- 32-34 PU 40-2213, RHea. 225.00
- 32-34 PU 40-2214, LHea. 225.00
- 35-47 PU 48-2213, RHea. 225.00
- 35-47 PU 48-2214, LHea. 225.00

Emergency Brake Link Kit for New Backing Plate

Includes links and cable tubes for both sides.



- 32-48 Pass LB-2103/04kit. 200.00
- 39-48 Merc LB-2103/04kit. 200.00
- 32-47 PU LB-2103/04kit. 200.00

MASTER CYLINDERS

Brake Fluid

- All Pass & PU DOT-5, 32 oz, siliconeea. 23.95
- All Pass & PU DOT-3, 32 oz, high-tempea. 6.00

New Master Cylinders

Tech Tip: Always bench bleed master cylinders before installation. This keeps air from being trapped in the bore causing a "spongy" pedal.

Always completely flush the brake system before installing new wheel cylinders and or master cylinders. Manufacturer does not warranty items returned as defects when rust, dirt, or scale is found in them.

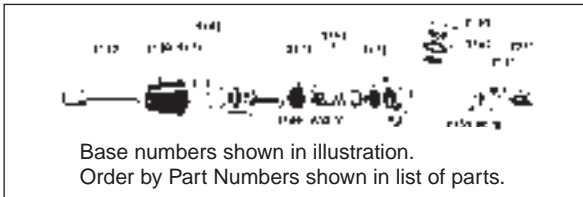

39-48	Pass	91A-2140ea.	99.00
49-51	Pass	A9A-2140, (requires two bushings) 8A-2470ea.	118.00
52-56	Pass	B5A-2140, without powerea.	98.00
39-48	Merc	91A-2140ea.	99.00
49-51	Merc	A9A-2140, some modifications requiredea.	118.00
52-58	Merc	B5A-2140, without powerea.	98.00
55-57	T-Bird	B5A-2140ea.	98.00
39-52	PU	91A-2140ea.	99.00
39-52	Truck	91T-2140, 3/4 & 1 Tonea.	138.00
53-56	PU	B3C-2140, F-100ea.	110.00
53-56	Truck	B3T-2140-A, F-250-600ea.	139.50

Master Cylinder Brake Pedal Bushing

49-51	Pass	8A-2470, 2 req, original bronzeea.	8.00
-------	------	---------------------------------	----------	------

Master Cylinder Rebuild Kit



39-48	Pass	91A-2001-US, made in USAkit.	320.00
39-48	Pass	91A-2004kit.	17.50
49-51	Pass	BPA-2004kit.	15.00
52-65	Pass	B5A-2004, w/std brakesea.	15.00
39-48	Merc	91A-2001-US, made in USAkit.	320.00
39-48	Merc	91A-2004kit.	17.50
49-51	Merc	8M-2004kit.	32.00
52-59	Merc	B5A-2004, w/std brakesea.	15.00
39-56	PU	91A-2001-US, made in USAkit.	320.00
39-56	PU	91A-2004kit.	17.50
39-56	Truck	91T-2004, 3/4 & 1 Tonkit.	13.00

Master Cylinder Filler Cap

39-48	Pass	8C-2162, metalea.	11.00
49-51	Pass	1A-2162-A, plasticea.	13.50
52-59	Pass	AB-2162-C, metalea.	15.00
39-48	Merc	8C-2162, metalea.	11.00
49-51	Merc	1A-2162-A, plasticea.	13.50
52-56	Merc	AB-2162-C, metalea.	15.00
55-60	T-Bird	AB-2162-C, metalea.	15.00
39-52	PU	8C-2162, metalea.	11.00
53-60	PU	1A-2162-A, plasticea.	13.50

Master Cylinder Filler Cap Gasket

39-48	Pass	91A-2167ea.	1.25
49-62	Pass	8M-2167ea.	2.00
39-48	Merc	91A-2167ea.	1.25

49-56	Merc	8M-2167ea.	2.00
55-60	T-Bird	8M-2167ea.	2.00
39-52	PU	91A-2167ea.	1.25
53-60	PU	8M-2167ea.	2.00

Master Cylinder Push Rod



39-48	Pass	91A-2143ea.	14.00
39-51	Merc	91A-2143ea.	14.00
39-56	PU	91A-2143ea.	14.00

Master Cylinder Push Rod Eye Bolt

39-48	Pass	91A-2462ea.	8.00
39-48	Merc	91A-2462ea.	8.00
39-47	PU	91A-2462ea.	8.00

Master Cylinder Boot

39-48	Pass	91A-2180ea.	2.50
49-56	Pass	0A-2180ea.	4.25
52-56	Merc	0A-2180ea.	4.25
39-52	PU	91A-2180ea.	2.50

Master Cylinder Push Rod Plastic Cap

52-56	Pass	B5A-2142ea.	7.00
55-57	T-Bird	B5A-2142ea.	7.00

Master Cylinder Push Rod Bushing

52-64	Pass	B2A-2474-A, 2 req'dea.	Call
-------	------	---------------------	----------	------

Power Brake Booster Check Valve Assembly

54-56	Pass	B4A-2365-A, brassea.	28.00
-------	------	-------------------	----------	-------

Master Cylinder Floor Hole Cover



39-51	Pass	91A-7011136ea.	6.00
39-51	Merc	91A-7011136ea.	6.00
39-52	PU	91A-7011136ea.	6.00
53-56	PU	BAAA-8111136ea.	15.00

WHEEL CYLINDERS

New Front Wheel Cylinder



39-48	Pass	21A-2061-US, RH, made in USA	ea.	56.00
39-48	Pass	21A-2062-US, LH, made in USA	ea.	56.00
49-56	Pass	AD-2061, RH	ea.	27.00
49-56	Pass	AD-2062, LH.....	ea.	27.00
39-48	Merc	21A-2061-US, RH, made in USA	ea.	56.00
39-48	Merc	21A-2062-US, LH, made in USA	ea.	56.00
49-56	Merc	AD-2061, RH	ea.	27.00
49-56	Merc	AD-2062, LH.....	ea.	27.00
55-57	T-Bird	AD-2061, RH	ea.	27.00
55-57	T-Bird	AD-2062, LH.....	ea.	27.00
39-47	PU	21A-2061-US, RH, made in USA	ea.	56.00
39-47	PU	21A-2062-US, LH, made in USA	ea.	56.00
48-60	PU	8C-2062, LH.....	ea.	34.00
48-60	PU	8C-2061, RH.....	ea.	34.00

Front Wheel Cylinder Kit



39-48	Pass	91A-2221, 1 1/4" x 1".....	kit.	5.50
39-48	Pass	21A-2221, 1 3/8" x 1".....	kit.	5.50
49-59	Pass	8M-2221, 1-1/8".....	kit.	5.50
39-48	Merc	91A-2221, 1 1/4 " x1".....	kit.	5.50
39-48	Merc	21A-2221, 1 3/8" x 1".....	kit.	5.50
49-59	Merc	8M-2221, 1-1/8".....	kit.	5.50
55-57	T-Bird	8M-2221, 1-1/8".....	kit.	5.50
39-47	PU	91A-2221, 1 1/4" x 1".....	kit.	5.50
39-47	PU	21A-2221, 1 3/8" x 1".....	kit.	5.50
48-67	PU	A8C-2221, 1-1/16".....	kit.	5.50
39-50	Truck	91T-2221, 1 Ton 1-3/8"	kit.	5.50

New Rear Wheel Cylinder



39-48	Pass	91A-2261-US, RH, made in USA	ea.	55.00
-------	------	------------------------------------	-----	-------

39-48	Pass	91A-2262-US, LH, made in USA	ea.	55.00
49-64	Pass	8A-2261, RH, 7/8".....	ea.	25.50
49-64	Pass	8A-2262, LH, 7/8".....	ea.	25.50
49-59	Wgn	B7A-2261, RH, 15/16".....	ea.	25.00
49-59	Wgn	B7A-2262, LH, 15/16".....	ea.	25.00
39-48	Merc	91A-2261-US, RH, made in USA	ea.	55.00
39-48	Merc	91A-2262-US, LH, made in USA	ea.	55.00
49-51	Merc	8M-2261, RH.....	ea.	26.00
49-51	Merc	8M-2262, LH.....	ea.	26.00
52-54	Merc	B7A-2261, RH, 15/16".....	ea.	25.00
52-54	Merc	B7A-2262, LH, 15/16".....	ea.	25.00
55-56	Merc	8A-2261, RH, 7/8".....	ea.	25.50
55-56	Merc	8A-2262, LH, 7/8".....	ea.	25.50
55	T-Bird	8A-2261, RH, 7/8".....	ea.	25.50
55	T-Bird	8A-2262, LH, 7/8".....	ea.	25.50
56-57	T-Bird	B7A-2261, RH, 15/16".....	ea.	25.00
56-57	T-Bird	B7A-2262, LH, 15/16".....	ea.	25.00
39-47	PU	91A-2261-US, RH, made in USA	ea.	55.00
39-47	PU	91A-2262-US, LH, made in USA	ea.	55.00
39-51	Truck	92Y-2261, 3/4 & 1 Ton	ea.	70.00
48-54	PU	8M-2261, RH.....	ea.	26.00
48-54	PU	8M-2262, LH.....	ea.	26.00
55-56	PU	8A-2261, RH, 7/8".....	ea.	25.50
55-56	PU	8A-2262, LH, 7/8".....	ea.	25.50

Rear Wheel Cylinder Kit

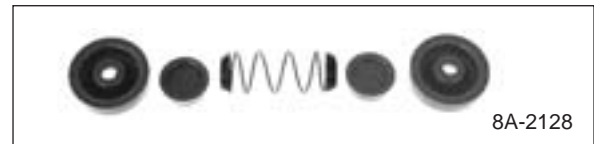

39-48	Pass	91A-2128, 1 1/8"x 1".....	kit.	5.50
49-56	Pass	8A-2128, exc.Wgn, 7/8"	kit.	5.50
49-59	Wgn	B2A-2128, 15/16".....	kit.	5.00
39-48	Merc	91A-2128, 1 1/8"x 1".....	kit.	5.50
49-51	Merc	A8C-2128, 1".....	kit.	5.50
52-54	Merc	B2A-2128, 15/16".....	kit.	5.00
55-56	Merc	8A-2128, 7/8".....	kit.	5.50
55	T-Bird	8A-2128, 7/8".....	kit.	5.50
56-57	T-Bird	B2A-2128, 15/16".....	kit.	5.00
39-47	PU	91A-2128, 1 1/8"x 1".....	kit.	5.50
48-54	PU	A8C-2128, 1".....	kit.	5.50
55-72	PU	8A-2128, 7/8".....	kit.	5.50

Wheel Cylinder Brake Bleeder Screws

These are for original wheel cylinders only.

39-48	Pass	R-90-31, 4 pcs.	set.	5.00
39-47	PU	R-90-31, 4 pcs.	set.	5.00



BRAKE LINES/HOSES

Steel Brake Line Sets

Sold in complete sets. Lines are pre-cut with nuts. Must be bent to fit application.

*39-40	Pass	91A-2269set.	52.00
*41-48	Pass	11A-2269kit.	58.50
*49-50	Pass	8A-2269kit.	65.00
*51	Pass	1A-2269kit.	65.00
*39-40	Merc	99A-2269kit.	58.50
*41-48	Merc	19A-2269kit.	58.50
*39-41	PU	91A-2269set.	52.00
*42-47	PU	21C-2269kit.	52.00
*48-52	PU	8C-2269kit.	52.00
*53-56	PU	BAAA-2269, F-100kit.	52.00

Brake Line Clip

49-51	Pass	51C-14197ea.	3.00
-------	------	-----------	----------	------

Brake Line Clip Bolts

39-48	Pass	H-83-25set.	10.00
39-48	Merc	H-83-25set.	10.00
39-41	PU	H-83-25set.	10.00

Master Cylinder to Junction Block Hose

54	Pass	8A-2079, w/power brakesea.	20.00
52-54	Merc	BC-2078-A, w/power brakesea.	22.00

Front Brake Hose

Two required per vehicle.



28-34	Pass	B-2079, when using 1939-48 hydraulic brakesea.	28.00
35-48	Pass	99A-2079, will work on 1935-38 when using 1939-48 hydraulic brakesea.	18.50
49-53	Pass	8A-2079ea.	20.00
54-56	Pass	AD-2079-Bea.	20.50
39-48	Merc	99A-2079ea.	18.50
49-51	Merc	8M-2079ea.	32.00
52-53	Merc	8A-2079ea.	20.00
54-56	Merc	AD-2079-Bea.	20.50
55-57	T-Bird	AD-2079-Bea.	20.50
28-34	PU	B-2079, when using 1939-48 hydraulic brakesea.	28.00
35-47	PU	99A-2079, will work on 1935-38 when using 1939-48 hydraulic brakesea.	18.50
48-52	PU	8M-2079ea.	32.00
53-56	PU	B7C-2078ea.	18.00

Front Brake Hose to Wheel Cylinder Copper Washer

39-48	Pass	91A-2149ea.	1.25
49-56	Pass	8M-2149ea.	1.25
39-48	Merc	91A-2149ea.	1.25
49-56	Merc	8M-2149ea.	1.25
39-47	PU	91A-2149ea.	1.25
48-56	PU	8M-2149ea.	1.25

Rear Brake Hose

One required per vehicle.

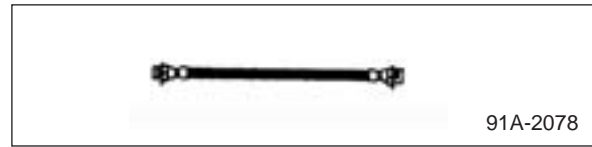

39-48	Pass	91A-2078ea.	16.00
49-51	Pass	8A-2078ea.	20.00
52-56	Pass	AB-2078-C, except wagonea.	22.00
52-56	Wgn	B2AZ-2282-Bea.	20.00
55	Conv	B2AZ-2282-Bea.	20.00
39-48	Merc	91A-2078ea.	16.00
49-51	Merc	8A-2078ea.	20.00
52-56	Merc	AB-2078-Cea.	22.00
52-56	Merc Wgn	B2AZ-2282-Bea.	20.00
55-57	T-Bird	B2AZ-2282-Bea.	20.00
39-41	PU	91A-2078ea.	16.00
42-47	PU	01T-2078ea.	22.00
48-60	PU	8A-2078ea.	20.00
40-56	Truck	01T-2078, 3/4 & 1 Tonea.	22.00

Rear Brake Hose to Brake Line Copper Washer

49-56	Pass	8M-2149ea.	1.25
49-56	Merc	8M-2149ea.	1.25
48-56	PU	8M-2149ea.	1.25

FITTINGS

Master Cylinder Brass Fitting



39-40	Pass	91A-2076ea.	12.00
39-48	Pass	99A-2076ea.	9.50
49-51	Pass	8M-2076ea.	12.00
52-59	Pass	AB-2076-Aea.	9.50
39-48	Merc	99A-2076ea.	9.50
49-51	Merc	8M-2076ea.	12.00
52-58	Merc	AB-2076-Aea.	9.50
55-57	T-Bird	AB-2076-Aea.	9.50
39-41	PU	91A-2076ea.	12.00
42-47	PU	91T-2076ea.	12.00
48-56	PU	8C-2076ea.	12.00

Master Cylinder Fitting Bolt



39-48	Pass	91A-2077-Aea.	6.50
49-51	Pass	91T-2276ea.	8.00

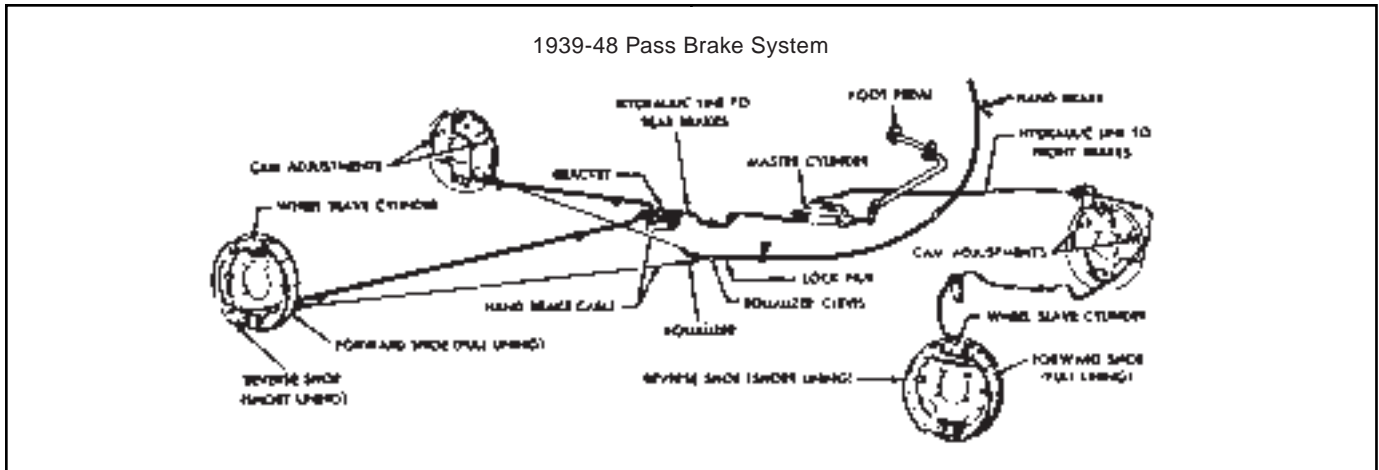

55-56	Pass	91T-2276, w/power brakes	ea.	8.00
39-48	Merc	91A-2077-A	ea.	6.50
49-51	Merc	91T-2276	ea.	8.00
55-59	T-Bird	91T-2276	ea.	8.00
39-56	PU	91A-2077-A	ea.	6.50

Master Cylinder Fitting Copper Washer

39-48	Pass	91A-2151, 1 req'd.	ea.	1.25
39-48	Pass	91A-2152, 1 req'd.	ea.	1.25
49-51	Pass	91A-2152, 2 req'd.	ea.	1.25
52-56	Pass	91T-2154-A, 2 req'd.	ea.	1.25
39-48	Merc	91A-2151, 1 req'd.	ea.	1.25
39-48	Merc	91A-2152, 1 req'd.	ea.	1.25
49-56	Merc	91T-2154-A, 2 req'd.	ea.	1.25
39-56	PU	91A-2151, 1 req'd.	ea.	1.25
39-56	PU	91A-2152, 1 req'd.	ea.	1.25

Brake Light Switch



35-38	Pass	48-13480	ea.	14.00
-------	------	----------	-----	-------



39-56	Pass	01A-13480	ea.	8.50
39-56	Merc	01A-13480	ea.	8.50
35-38	PU	48-13480	ea.	14.00
39-56	PU	01A-13480	ea.	8.50

Front Brake Line Brass Fitting

39-48	Pass	91A-2075	ea.	10.00
49-51	Pass	8A-2075	ea.	9.50
39-48	Merc	91A-2075	ea.	10.00
49-51	Merc	8A-2075	ea.	9.50
39-47	PU	91A-2075	ea.	10.00

Front Brake Line Fitting Bolt



39-48	Pass	91A-2150, LH	ea.	6.50
49-51	Pass	8M-2150	ea.	6.50
56-57	Pass	8M-2150	ea.	6.50
55-58	T-Bird	8M-2150	ea.	6.50
39-41	PU	91A-2150, LH	ea.	6.50

Front Brake Line Fitting Copper Washer

39-48	Pass	91A-2149, 2 req'd.	ea.	1.25
49-56	Pass	8M-2149, 2 req'd.	ea.	1.25
39-53	Merc	91A-2149, 2 req'd.	ea.	1.25
39-47	PU	91A-2149, 2 req'd.	ea.	1.25
48-56	PU	8M-2149, 2 req'd.	ea.	1.25

Rear Brake Line Brass Fitting



39-40	Pass	91A-2074	ea.	12.00
41-48	Pass	99A-2074	ea.	9.50
49-56	Pass	8A-2074	ea.	11.50
39-48	Merc	99A-2074	ea.	9.50
52-53	Merc	8A-2074	ea.	11.50
39-41	PU	91A-2074	ea.	12.00
48-56	PU	8A-2074	ea.	11.50



SHOES/SPRINGS

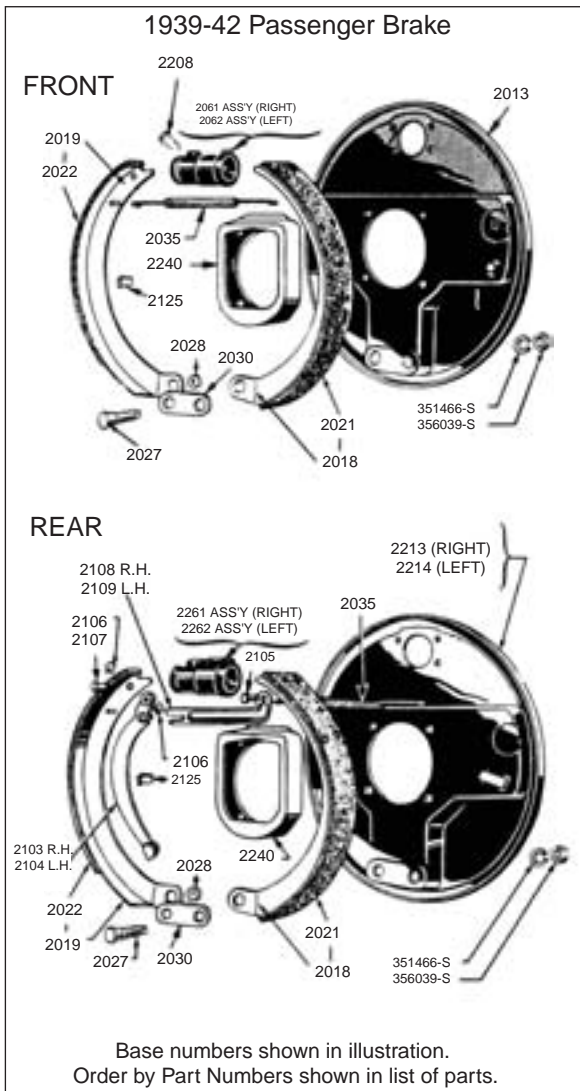

New Front Brake Shoes

No core required. Set includes 4 shoes.



39-41	Pass	91A-2001-N.....set.	79.95
42-48	Pass	21A-2001-N.....set.	79.95
49-54	Pass	154-2001-A, 10 X 2 1/4".....set.	45.00
55-59	Pass	263-2001, 11-1/32 X 2-1/4".....set.	45.00
49-51	Wgn	154-2001-A, 10 X 2 1/4".....set.	45.00
52-54	Wgn	191-2001, 11 X 2".....set.	45.00
55-59	Wgn	263-2001, 11-1/32 X 2-1/4".....set.	45.00
39-41	Merc	91A-2001-N.....set.	79.95
42-48	Merc	21A-2001-N.....set.	79.95
49-54	Merc	191-2001, 11 X 2".....set.	45.00
55-56	Merc	264-2001, 11 X 2 1/2".....set.	43.00
55-56	T-Bird	263-2001, 11-1/32 X 2-1/4".....set.	45.00
39-41	PU	91A-2001-N.....set.	79.95

42-47	PU	21A-2001-N.....set.	79.95
48-66	PU	191-2001, 11 X 2".....set.	45.00
51-72	PU	33-2001, 12 X 2".....set.	60.00
51-72	PU	33B-2001, 12-1/8 X 2".....set.	60.00

New Rear Brake Shoes

No core required. Set includes 4 shoes.



39-41	Pass	91A-2001-N.....set.	79.95
42-48	Pass	21A-2001-N.....set.	79.95
49-54	Pass	151-2201-A, 10 X 1 3/4".....set.	45.00
49-54	Wgn	55-2201, 11 X 1 3/4".....set.	45.00
55-59	Pass	55-2201, 11 X 1 3/4".....set.	45.00
55-59	Wgn	191-2001, 11 X 2".....set.	45.00
39-41	Merc	91A-2001-N.....set.	79.95
42-48	Merc	21A-2001-N.....set.	79.95
49-54	Merc	55-2201, 11 X 1 3/4".....set.	45.00
55-56	Merc	191-2001, 11 X 2".....set.	45.00
55-56	T-Bird	55-2201, 11 X 1 3/4".....set.	45.00
39-41	PU	91A-2001-N.....set.	79.95
42-47	PU	21A-2001-N.....set.	79.95
48-66	PU	55-2201, 11 X 1 3/4".....set.	45.00

Brake Shoe Lining

To reline your old shoes. Set for four wheels, rivets are included.

39-48	Pass	91A-2018.....set.	45.00
39-48	Merc	91A-2018.....set.	45.00
39-47	PU	91A-2018.....set.	45.00

Woven Brake Shoe Lining

To reline your old shoes. Set for four wheels, rivets are included.

32-34	Pass	40-2018-W.....set.	110.00
35-38	Pass	48-2018-W.....set.	135.00
39-48	Pass	91A-2018-W.....set.	115.00
39-48	Merc	91A-2018-W.....set.	115.00
32-34	PU	40-2018-W.....set.	110.00
35-38	PU	48-2018-W.....set.	135.00
39-47	PU	91A-2018-W.....set.	115.00

Brake Shoe Anchor Pin

39-48	Pass	91A-2027.....ea.	10.00
39-48	Merc	91A-2027.....ea.	10.00
39-47	PU	91A-2027.....ea.	10.00

Brake Shoe Anchor Plate

39-42	Pass	91A-2030.....ea.	3.00
39-42	Merc	91A-2030.....ea.	3.00
39-42	PU	91A-2030.....ea.	3.00

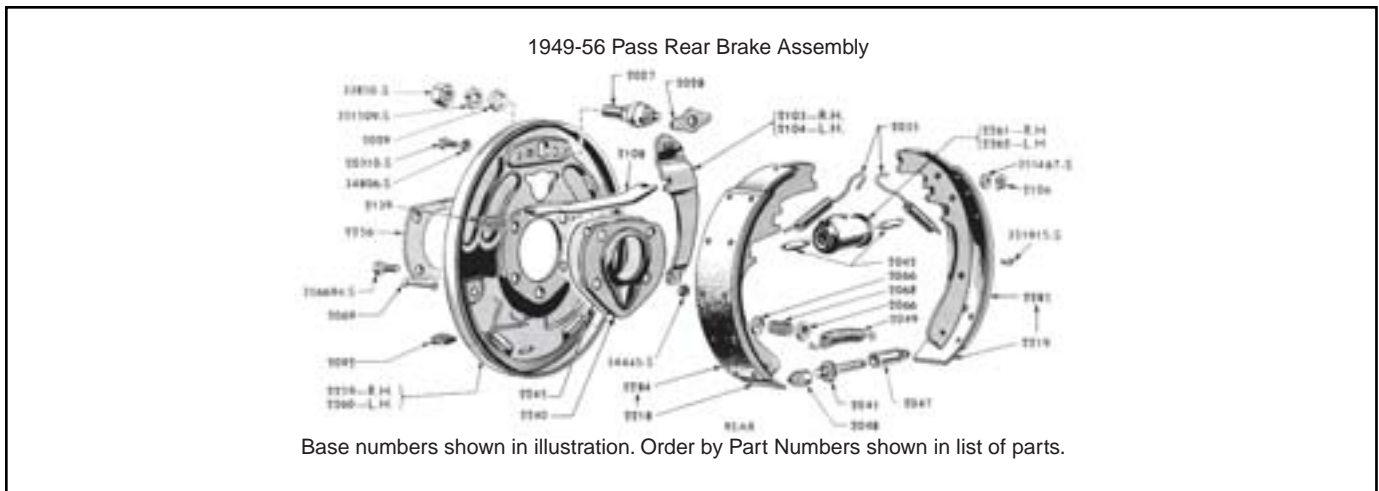

Brake Shoe Cam

Might need to ream/hone I.D. .001-.005 to fit anchor pin.



39-41	Pass	91A-2028ea.	4.50
42-48	Pass	51A-2028ea.	3.75
39-41	Merc	91A-2028ea.	4.50



42-48	Merc	51A-2028ea.	3.75
39-41	PU	91A-2028ea.	4.50
42-47	PU	51A-2028ea.	3.75

Brake Shoe Anchor Pin Washer

46-48	Pass	356473-S2, 8 req'dea.	.95
46-48	Merc	356473-S2, 8 req'dea.	.95

Brake Shoe Retaining Clip



42-48	Pass	51A-2125-Bea.	6.00
42-48	Merc	51A-2125-Bea.	6.00
42-47	PU	51A-2125-Bea.	6.00

Hand Brake Lever Pin



39-48	Pass	91A-2105, shortea.	1.60
39-48	Pass	91A-2107, longea.	1.60
39-48	Merc	91A-2105, shortea.	1.60
39-48	Merc	91A-2107, longea.	1.60
39-47	PU	91A-2105, shortea.	1.60
39-47	PU	91A-2107, longea.	1.60

Hand Brake Lever Pin Clip



39-72	Pass & PU	91A-2106ea.	.50
39-56	Merc	91A-2106ea.	.50

Park Brake Lever Return Spring

49-62	Pass & PU	C4UZ-2A601-Apr.	6.50
-------	-----------	--------------	----------	------

Backing Plate Bolts

28-34	Pass & PU	1172A, 2 req'dset.	8.00
-------	-----------	----------------	-----------	------

Brake Shoe Return Spring



35-36	Pass	48-2035ea.	3.00
39-48	Pass	91A-2035ea.	2.60
49-54	Pass	8A-2035ea.	3.00
39-48	Merc	91A-2035ea.	2.60
35-36	PU	48-2035ea.	3.00
39-47	PU	91A-2035ea.	2.60

Brake Adjusting Screw Spring

49-54	Pass	8A-2049ea.	3.00
-------	------	---------	----------	------





Brake Shoe Self Adjusting Springs & Hold Downs



49-54 Pass H-13, w/10" drum.....kit. 25.00

Brake Adjusting Hole Cover

49-73 Pass & PU 8A-2092.....ea. .95
 49-56 Merc 8A-2092.....ea. .95

MECHANICAL BRAKES

Brake Energizer Kit (Floaters)



28-34 Pass & PU B-2043, front wheels.....kit. 38.00
 35-38 Pass & PU 48-2043, four wheels.....ea. 54.95

Brake Cross Shaft Bushing

32-35 Pass & PU B-2477, N.O.S., .87" ID,
 1.12" OD x 1.25" long,
 2 required.....ea. 5.00

Front Brake Rods

Two required per vehicle.

32-34 Pass & PU 40-2495.....ea. 25.00
 35-36 Pass & PU 48-2495.....ea. 25.00

Front Brake Rod Anti-Rattlers

32-34 Pass & PU B-2502.....pr. 20.00
 35-36 Pass & PU 48-2502.....pr. 13.00

Rear Brake Rods

Two required per vehicle.

32 Pass & PU 18-2499.....ea. 22.00
 33-34 Pass & PU 40-2499.....ea. 22.00
 35-36 Pass & PU 48-2499.....ea. 22.00

Rear Brake Rod Anti-Rattlers



32-34 Pass & PU B-2503.....pr. 26.00
 35-36 Pass & PU 48-2503.....pr. 20.00

Mechanical Brake Cable

Two required per vehicle.

37-38 Pass & PU 78-2494, front.....ea. 35.00
 37-38 Pass & PU 78-2498, rear.....ea. 35.00

Brake Rod Nut Set

28-38 Pass & PU A-2469-S.....set. 1.00

Brake Rod Clevis



28-35 Pass & PU BB-2466, eyelet type.....ea. 2.25
 32-34 Pass & PU B-2464, Y-type.....ea. 6.00

Brake Cable Clevis

37-38 Pass & PU 78-2466, rear cable to
 cross shaft.....ea. 3.00

Brake Rod Clevis Pin



32-48 Pass & PU B-2460.....ea. .50

Brake Shoe Anchor Pin

37-38 Pass & PU 78-2027-B, N.O.S. 4 required.....ea. 5.00

Brake Adjusting Wedge

28-34 Pass & PU 1260.....ea. 12.00
 28-36 Pass & PU B-2041, N.O.S.ea. 5.00
 37-38 Pass & PU 78-2041, N.O.S.ea. 5.00

Brake Shoe Roller Pin

28-34 Pass & PU B-2045-B, .636" head diameter,
 1-9/64" length.....ea. 4.00

Brake Operating Wedge

35-36 Pass & PU 48-2050, N.O.S., 2.18" tall,
 1.84" wide, front or rear.....ea. 5.00

Brake Adjusting Link

35-36 Pass & PU 48-2042, N.O.S. 2.54" long,
 .49 diameter.....ea. 5.00
 36 Pass & PU 68-2042, N.O.S., 2.38" long,
 .43" diameter.....ea. 7.00
 37-38 Pass & PU 78-2042, N.O.S., 1.97" long,
 .45" diameter.....ea. 7.50

Brake Shoe Hold Down Spring Centralizing Cup

37-38 Pass & PU 78-2071, N.O.S., front or rearea. 5.00

Lower Brake Operating Lever

37-38	Pass & PU	78-2089-B, N.O.S., LH, 2 required.....ea.	15.00
-------	-----------	--	-------

EMERGENCY BRAKE HANDLE

Emergency Brake Handle w/Ratchet

30-34	Pass & PU	A-2780-C.....ea.	80.00
-------	-----------	------------------	-------

Emergency Brake Cable Pulley



52-58	Pass	OM-2804.....ea.	27.00
50-56	Merc	OM-2804.....ea.	27.00

Emergency Brake Ratchet Spring

39-42	Pass	91A-2788.....ea.	3.00
46-48	Pass	51A-2788.....ea.	3.00

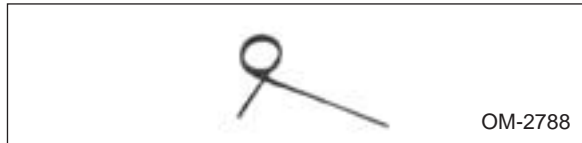

52-58	Pass	OM-2788.....ea.	4.00
39-42	Merc	91A-2788.....ea.	3.00
46-48	Merc	51A-2788.....ea.	3.00
50-56	Merc	OM-2788.....ea.	4.00
39-47	PU	91A-2788.....ea.	3.00

Emergency Brake Handle Pawl

29-34	Pass & PU	A-2786.....ea.	3.25
-------	-----------	----------------	------

Emergency Brake Handle Ratchet

30-32	Pass & PU	B-2795B.....ea.	8.00
-------	-----------	-----------------	------

Emergency Brake Handle Boot

30-36	Pass & PU	EB-7000, black.....ea.	4.00
30-36	Pass & PU	EB-7000-T, tan.....ea.	5.00

Emergency Brake Handle Pivot Bolt

32-36	Pass & PU	1251, 2 req'd.....ea.	2.00
-------	-----------	-----------------------	------

Emergency Brake Handle Floor Seal

33-34	Pass	40-700384.....ea.	6.00
35-36	Pass	48-700384.....ea.	6.00

CABLES

Front Emergency Brake Cable

37-38	Pass	78-2853.....ea.	35.00
39	Pass	01C-2853.....ea.	35.00
40	Pass	01A-2853.....ea.	35.00
41-48	Pass	11A-2853.....ea.	35.00
49-50	Pass	8A-2853-C, 75", exc. conv.....ea.	35.00
50	Wagon	8A-2853-C, 75".....ea.	35.00
52-56	Pass	B5A-2853-D, 52-1/2".....ea.	35.00

52-54	Conv	B5A-2853-D, 52-1/2".....ea.	35.00
55-56	Conv	B5A-2853-C, 58-1/2".....ea.	40.00
52-56	Wagon	B5A-2853-D, 52-1/2".....ea.	35.00
55-57	T-Bird	B5S-2853.....ea.	38.50
37-38	PU	78-2853.....ea.	35.00
39-41	PU	01C-2853.....ea.	35.00
42-47	PU	21C-2853.....ea.	35.00
48-52	PU	2C-2853.....ea.	35.00
48-52	PU	7RD-2853, F-2, F-3.....ea.	35.00
53-56	PU	TAAA-2853, w/110" wheel base.....ea.	37.50
56	PU	B6C-2853, w/118" wheel base.....ea.	60.00

Emergency Brake Cable Nut



49-64	Pass	8A-2091.....ea.	5.25
-------	------	-----------------	------

Rear Emergency Brake Cable

39-40	Pass	91A-2275-B, 122", must trim spring.....ea.	20.00
41-48	Pass	21A-2275, 107.25", must trim spring.....ea.	20.00
49-51	Pass	8A-2275-C, 155", exc. Conv. & Wgn.....ea.	35.00
52-53	Pass	8A-2275-C, 155".....ea.	35.00
52-53	Conv	8A-2275-C, 155".....ea.	35.00
52-53	Wgn	8A-2275-C, 155".....ea.	35.00
54	Pass	B5AZ-2635-A, 143".....ea.	70.00
54	Conv	8A-2275-C, 155".....ea.	35.00
55-56	Pass	B5AZ-2635-A, 143".....ea.	70.00
55-56	Hardtop 2D	B5AZ-2635-C, 129.5".....ea.	40.00
55-56	Conv	B5AZ-2635-C, 129.5".....ea.	40.00
54-56	Wgn	B5AZ-2635-B, 144.5".....ea.	40.00
54-56	Sdn Dly	B5AZ-2635-B, 144.5".....ea.	40.00
39-40	Merc	91A-2275-B, 122", must trim spring.....ea.	20.00
41-48	Merc	21A-2275, 107.25", must trim spring.....ea.	20.00
55-56	Merc	MC-2275-D.....ea.	65.00
55-56	T-Bird	B5SZ-2635.....ea.	38.50
39-41	PU	91A-2275-B, 122", must trim spring.....ea.	20.00
42-47	PU	21C-2275, 2 req'd.....ea.	35.00
48-52	PU	B1TZ-2635-A, 2 req'd, F1.....ea.	44.00
53-60	PU	COTZ-2A635-A, F-100.....ea.	39.95

Rear Brake Cable Equalizer



39-48	Pass	91A-2119.....ea.	5.50
-------	------	------------------	------

Section 5 - Brakes



C&G Early Ford Parts, Inc.

39-48	Merc	91A-2119.....ea.	5.50
39-41	PU	91A-2119.....ea.	5.50

Rear Brake Cable Equalizer Clevis

39-48	Pass	BB-2466.....ea.	2.25
39-48	Merc	BB-2466.....ea.	2.25
39-41	PU	BB-2466.....ea.	2.25

Rear Brake Cable Equalizer Clevis Pin

39-48	Pass	B-2460.....ea.	.50
39-48	Merc	B-2460.....ea.	.50
39-41	PU	B-2460.....ea.	.50

Rear Brake Cable Equalizer Rod



52-59	Pass	B7A-2628-B, 5-5/8".....ea.	11.95
-------	------	----------------------------	-------

Rear Brake Cable Anti-Rattler



41-48	Pass	11A-2091.....ea.	2.00
41-48	Merc	11A-2091.....ea.	2.00

Rear Brake Cable Guides



39-40	Pass	91A-2271.....pr.	5.00
39-40	Merc	91A-2271.....pr.	5.00
39-41	PU	91A-2271.....pr.	5.00

Rear Brake Cable Guide Brackets



39-40	Pass	91A-2272.....pr.	7.00
39-40	Merc	91A-2272.....pr.	7.00
39-41	PU	91A-2272.....pr.	7.00

Rear Brake Cable Boots

Included with rear brake cable.



39-48	Pass	91A-2597.....pr.	10.00
39-48	Merc	91A-2597.....pr.	10.00
39-47	PU	91A-2597.....pr.	10.00

Emergency Brake Lever

49-54	Pass	8A-2103-A, RH, N.O.S., except wagon and sedan delivery.....ea.	15.00
-------	------	--	-------

49-54	Pass	8A-2104-A, LH, N.O.S., except wagon and sedan delivery.....ea.	15.00
-------	------	--	-------

Rear Brake Cable Tube

Must weld to backing plate.

39-48	Pass	91A-2217.....ea.	17.00
39-48	Merc	91A-2217.....ea.	17.00
39-47	PU	91A-2217.....ea.	17.00

Brake Cable Grommet



39-40	Pass	91A-2273, thru frame.....ea.	3.00
49-50	Pass	0A-2273, firewall.....ea.	15.00
39-40	Merc	91A-2273, thru frame.....ea.	3.00
39-41	PU	91A-2273, thru frame.....ea.	3.00

Brake Cable Frame Clip



39-56	Pass	78-2814-A.....ea.	1.00
49-56	Pass	8M-2814.....ea.	2.00

Rear Brake Cable Clip

Retains rear brake cable inside backing plate.

39-48	Pass	91A-2113, 2 req'd.....ea.	2.00
39-48	Merc	91A-2113, 2 req'd.....ea.	2.00
39-47	PU	91A-2113, 2 req'd.....ea.	2.00

Emergency Brake Spring

55-57	T-Bird	MB-7523-A.....ea.	5.00
-------	--------	-------------------	------

PEDAL PADS/SPRINGS

Pedal Pad



32	Pass	B-2454, Ford script.....ea.	35.00
33-36	Pass	40-2454.....ea.	8.50
37-40	Pass	78-2454.....ea.	8.50
41-48	Pass	11A-2454.....ea.	8.50
49-51	Pass	8A-2454.....ea.	8.00



52-65	Pass	B7A-2457-A.....ea.	5.00
52-59	Pass	AB-2454-B, auto w/o power.....ea.	15.00
54-59	Pass	B9A-2454-B, auto swiftsure power brakes.....ea.	49.95

54-59	Pass	B9A-2454-BR, auto w/pwr replcmt type.....ea.	25.00
39-40	Merc	78-2454.....ea.	8.50
41-48	Merc	11A-2454.....ea.	8.50
49-51	Merc	CB-90.....pr.	22.00
51	Merc	1M-2457, w/auto.....ea.	31.50
55-59	T-Bird	AB-2454-B, auto w/o power.....ea.	15.00
55-59	T-Bird	B9A-2454-BR, auto w/pwr replcmt type.....ea.	25.00
32	PU	B-2454, Ford script.....ea.	35.00
33-36	PU	40-2454.....ea.	8.50
37-40	PU	78-2454.....ea.	8.50
41-56	PU	11A-2454.....ea.	8.50

Street Rod Style Brake Pedal Pad

33-48	Pass	HR-2454-SS, stainless.....ea.	35.00
33-56	PU	HR-2454-SS, stainless.....ea.	35.00

Brake Pedal Return Spring



35-36	Pass	48-2472.....ea.	3.75
37-38	Pass	78-2456.....ea.	4.00
39	Pass	91A-7523.....ea.	3.00
40	Pass	01A-2456.....ea.	3.00
41-48	Pass	99A-7523.....ea.	3.00
49-51	Pass	8A-2456-B.....ea.	10.00
39-48	Merc	99A-7523.....ea.	3.00
49	Merc	91A-7523.....ea.	3.00
50-51	Merc	8A-2456-B.....ea.	10.00
35-36	PU	48-2472.....ea.	3.75
37-38	PU	78-2456.....ea.	4.00
39	PU	91A-7523.....ea.	3.00
40-41	PU	01A-2456.....ea.	3.00
42-52	PU	01T-2472.....ea.	4.00
53-56	PU	TAAA-2472.....ea.	3.00

Brake Pedal Shaft



32-34	Pass	B-7506.....ea.	25.00
35-38	Pass	48-7506.....ea.	24.00
32-34	PU	B-7506.....ea.	25.00
35-38	PU	48-7506.....ea.	24.00
42-52	PU	01T-7506.....ea.	21.00
53-56	PU	TAAA-7506-A.....ea.	33.00

Brake Pedal Shaft w/Bushings



40-48	Pass	01A-7506-S.....set.	17.50
40-48	Merc	01A-7506-S.....set.	17.50
40-41	PU	01A-7506-S.....set.	17.50

Brake Pedal Bushing

Note: See section 13 for Clutch Bushings.

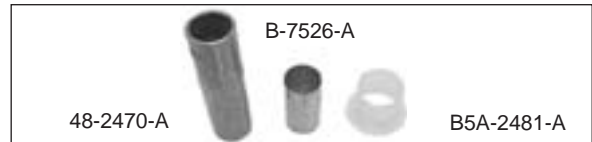

32-34	Pass	B-7526-A.....ea.	4.50
35-38	Pass	48-2470A.....ea.	40.00
39	Pass	B-7526-A.....ea.	4.50
40-48	Pass	01A-7526, 2 req'd.....ea.	3.00
49-51	Pass	8A-2470, 2 req, fits in master cylinder.....ea.	8.00
52-56	Pass	B2A-2461.....ea.	35.00
40-51	Merc	01A-7526, 2 req'd.....ea.	3.00
52-56	Merc	B2A-2461.....ea.	35.00
32-34	PU	B-7526-A.....ea.	4.50
35-38	PU	48-2470A.....ea.	40.00
39	PU	B-7526-A.....ea.	4.50
40-41	PU	01A-7526, 2 req'd.....ea.	3.00
42-47	PU	B-7508.....ea.	2.50
48-52	PU	B-7526-A.....ea.	4.50
38-47	C.O.E.	48-2470A.....ea.	40.00

Brake Pedal Return Spring Bushing

52-56	Pass	B5A-2481-A, plastic.....ea.	22.50
-------	------	-----------------------------	-------

Brake Pedal Bumpers/Stops



32-34	Pass	B-35184.....pr.	4.00
35-38	Pass	48-700386, w/screws.....pr.	3.75
37-48	Pass	91A-7527.....pr.	8.00
49-51	Pass	8A-2476-A.....pr.	5.00
39-48	Merc	91A-7527.....pr.	8.00
49-51	Merc	8M-2476.....pr.	40.50
32-39	PU	B-35184, push in type.....pr.	4.00
35-38	PU	48-700386, w/screws.....pr.	3.75
37-47	PU	91A-7527.....pr.	8.00
48-56	PU	7C-2473.....pr.	4.00



Brake Pedal Arm Bumper



52-56 Pass MA-7583-Aea. 2.00

**Section 6
Front Axle**

KING PINS

King Pin & Bushing Kit

One kit for both sides.



32-34	Pass	B-3111.....kit.	129.95
35-36	Pass	48-3111kit.	100.00
37-41	Pass	78-3111kit.	50.00
42-48	Pass	21A-3111kit.	50.00
49-53	Pass	A9A-3111kit.	50.00
39-41	Merc	78-3111kit.	50.00
42-48	Merc	21A-3111kit.	50.00
49-51	Merc	8M-3111.....kit.	75.00
52-53	Merc	A9A-3111kit.	50.00
32-34	PU	B-3111.....kit.	129.95
35-36	PU	48-3111kit.	100.00
37-41	PU	78-3111kit.	50.00
42-52	PU	21A-3111, F1, F2, F3kit.	50.00
53-56	PU	B3C-3111, F-100, F-250kit.	55.00
53-56	PU	B3Y-3111-A, F-350.....kit.	40.00

King Pin Bushing & Bearing Kit Less Pins

28-48	Pass	X-3111set.	26.50
39-48	Merc	X-3111set.	26.50
28-47	PU	X-3111set.	26.50

King Pin Bushing

28-48	Pass	11A-3110.....ea.	4.00
39-48	Merc	11A-3110.....ea.	4.00
28-52	PU	11A-3110.....ea.	4.00

King Pin Shim

32-48	Pass	78-3107, .020.....ea.	.40
39-48	Merc	78-3107, .020.....ea.	.40
32-52	PU	78-3107, .020.....ea.	.40

SHACKLE KITS/SPRING PARTS

Front Axle Bumper

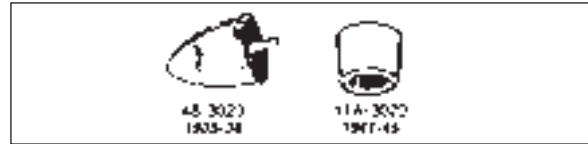

32-34	Pass	B-3020, 1 req'd.....ea.	10.00
35-38	Pass	48-3020.....ea.	8.00
35-38	Pass	48-3020-F, "Ford" script.....pr.	38.00
39-40	Pass	91A-3020.....ea.	8.00
39-40	Pass	91A-3020-F, "Ford" script.....pr.	40.00
41-42	Pass	11A-3020.....ea.	6.00
46-48	Pass	51A-3020.....ea.	8.50
39-40	Merc	91A-3020.....ea.	8.00
39-40	Merc	91A-3020-F, "Ford" script.....pr.	40.00
41-42	Merc	11A-3020.....ea.	6.00
46-48	Merc	51A-3020.....ea.	8.50
32-34	PU	B-3020, 1 req'd.....ea.	10.00
35-38	PU	48-3020.....ea.	8.00
35-38	PU	48-3020-F, "Ford" script.....pr.	38.00
39-41	PU	91A-3020.....ea.	8.00
39-40	PU	91A-3020-F, "Ford" script.....pr.	40.00
42-47	PU	21C-3020.....ea.	6.00
48-56	PU	7RC-3020.....ea.	8.00

Front Spring Shackle Kit



32-34	Pass	B-5304.....kit.	24.00
35-40	Pass	48-5304kit.	24.00
41	Pass	11A-5304kit.	24.00
42-48	Pass	21A-5304kit.	29.00
39-40	Merc	48-5304kit.	24.00
41	Merc	11A-5304kit.	24.00
42-48	Merc	21A-5304kit.	29.00
32-34	PU	B-5304.....kit.	24.00
35-41	PU	48-5304kit.	24.00
48-52	PU	7C-5300-S, F1, F2, F3kit.	60.00
53-56	PU	BAAA-5300-S, F-100 & F-250kit.	50.00

Teflon Front Spring Shackle Kit



32-34	Pass	B-5304-T.....kit.	50.00
35-40	Pass	48-5304-T.....kit.	50.00
39-40	Merc	48-5304-T.....kit.	50.00
32-34	PU	B-5304-T.....kit.	50.00
35-41	PU	48-5304-T.....kit.	50.00

Front Spring Shackle Bushing

42-56	PU	21C-5348-A, 4 req'd.....ea.	5.00
-------	----	-----------------------------	------

Front Spring Shackle Pin

32-34	Pass	40-5464.....ea.	4.25
35-41	Pass	51A-5464.....ea.	5.00
39-41	Merc	51A-5464.....ea.	5.00
32-34	PU	40-5464.....ea.	4.25
35-41	PU	51A-5464.....ea.	5.00
42-56	PU	21C-5465, 4 or 6 req'd.....ea.	6.50
48-52	PU	7RC-5465, F1, F2, F3, 2 req'd.....ea.	5.50

Front Spring Bushing



42-48	Pass	21A-5719.....ea.	2.50
42-48	Merc	21A-5719.....ea.	2.50

Front Spring Clamp

32-34	Pass & PU	A-5330-A, 2 required.....ea.	2.75
-------	-----------	------------------------------	------

Front Spring Hanger

53-56	PU	TAAA-5335, F-100, F-250, front of front spring.....ea.	25.00
-------	----	--	-------

Front Spring Hanger Rear

53-56	PU	B5C-5340-C, F-100 & F-250.....ea.	30.00
-------	----	-----------------------------------	-------

Front Spring Hanger Bushing

42-47	PU	21C-5344-A, 2 req'd.....ea.	8.00
48-52	PU	7RC-5334, 4 req'd.....ea.	5.00
53-56	PU	21C-5344-A, F-100 & F-250, 2 req'd.....ea.	8.00

Front Spring Shackle Bar



42-47	PU	21C-5468, inner.....ea.	5.00
-------	----	-------------------------	------

42-47	PU	21C-5469, outer.....ea.	5.00
48-52	PU	7RC-5469, outer.....ea.	8.00
48-56	PU	7RC-5468, inner.....ea.	8.50
53-56	PU	B5C-5469, F-100 & F-250, outer.....ea.	7.00

Front Spring Center Bolt

32-48	Pass	B-5345-F.....ea.	2.00
39-48	Merc	B-5345-F.....ea.	2.00
32-41	PU	B-5345-F.....ea.	2.00

Front Spring U-Bolt

28-34	Pass	B-5455-S, round top, includes hardware.....set.	17.50
35-48	Pass	51A-5455.....ea.	6.50
39-48	Merc	51A-5455.....ea.	6.50
28-34	PU	B-5455-S, round top, includes hardware.....set.	17.50
35-41	PU	51A-5455.....ea.	6.50
42-56	PU	B3C-5455-A, F-1 & F-100.....ea.	6.00

Front Spring U-Bolt Nuts

28-34	Pass	1146.....set.	5.00
35-48	Pass	1147.....set.	6.00
39-48	Merc	1147.....set.	6.00
28-34	PU	1146.....set.	5.00
35-41	PU	1147.....set.	6.00

Front Spring U-Bolt Plate

28-32	Pass	A-5458.....ea.	10.00
28-32	PU	A-5458.....ea.	10.00

Spring Poly Liner - Black

Using this between the leaf springs makes your vehicle ride smoother:



All	A-5310-P1, 1-3/4"x 20'.....ea.	25.00
All	A-5310-P2, 2"x 20'.....ea.	25.00
All	A-5310-P3, 2-1/4"x 20'.....ea.	25.00

Spring Shackle Castle Nuts

32-36	Pass	3120, 4 pcs.....set.	3.00
32-36	PU	3120, 4 pcs.....set.	3.00

AXLE PERCH BOLT

Spring Perch Bolt Nut

28-48	Pass	1148A.....ea.	2.00
28-41	PU	1148A.....ea.	2.00

Spring Perch Bushing & Stud

40-41	Pass & PU	51A-5464-T, teflon.....ea.	10.00
-------	-----------	----------------------------	-------



**FRONT SUSPENSION PARTS 1949-56
PASS**

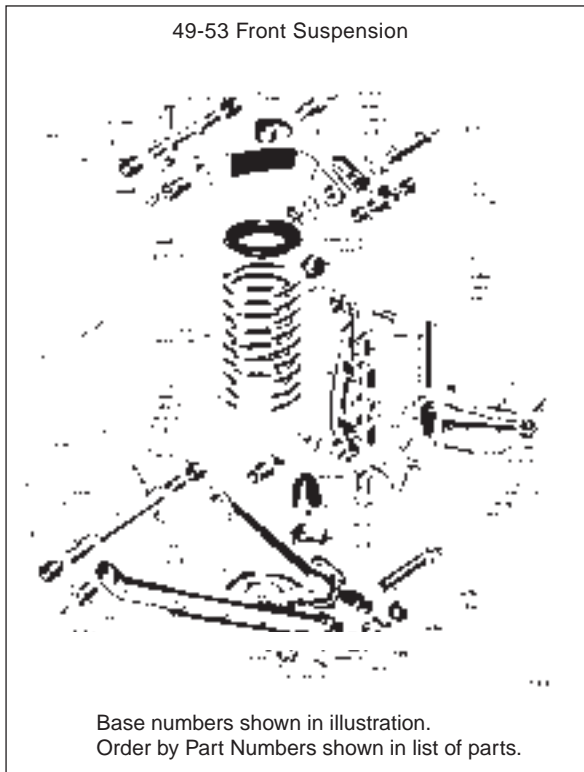

Upper Control Arm Inner Shaft Kit

One kit required per side.

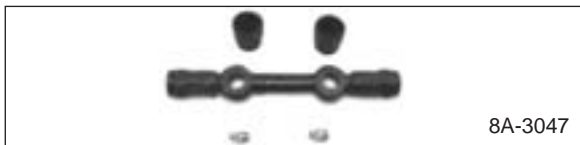

49-53	Pass	8A-3047	kit.	40.00
54-56	Pass	B4A-3047-B.....	kit.	30.00
49-51	Merc	8M-3047.....	kit.	90.00
52-53	Merc	8A-3047	kit.	40.00
55-57	T-Bird	B4A-3047-B.....	kit.	30.00

Upper Control Arm Outer Shaft kit

One kit required per side.



49-53	Pass	8A-3049	kit.	40.00
49-51	Merc	8M-3049.....	kit.	122.50
52-53	Merc	8A-3049	kit.	40.00

Control Arm Bushing Set

Includes upper & lower for both sides.



54-56	Pass	B4A-3073-KIT	set.	57.00
54-56	Merc	B4A-3073-KIT	set.	57.00
55-57	T-Bird	B4A-3073-KIT	set.	57.00

Upper Control Arm Front Bushing

Two required per vehicle.



54-56	Pass	LA-3068.....	ea.	7.00
54-56	Merc	LA-3068.....	ea.	7.00

Upper Control Arm Rear Bushing

Two required per vehicle.



54-56	Pass	B4A-3087	ea.	7.00
54-56	Merc	B4A-3087	ea.	7.00

Upper Ball Joint

54-56	Pass	B5A-3049-A	ea.	55.00
54-56	Merc	B5A-3049-A	ea.	55.00
55-57	T-Bird	B5A-3049-A	ea.	55.00

Lower Control Arm Inner Shaft Kit

One kit req'd per side.

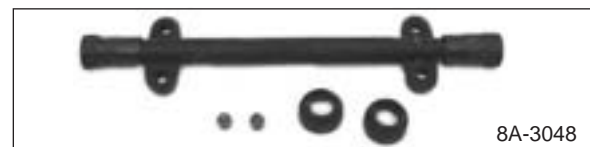

49-53	Pass	8A-3048	kit.	40.00
54-56	Pass	B6A-3048-S	kit.	30.00
49-51	Merc	8M-3048.....	kit.	82.50
52-53	Merc	8A-3048	kit.	40.00

54-54 Pass, 55-57 T-Bird Front Suspension

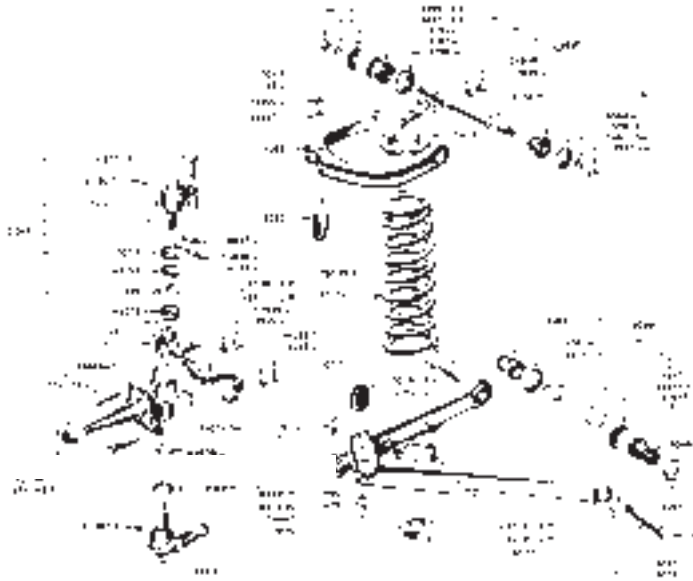

Base numbers shown in illustration. Order by Part Numbers shown in list of parts.

Lower Control Arm Outer Shaft kit

One kit req'd per side.



49-53	Pass	8A-3050kit.	40.00
49-51	Merc	8M-3050kit.	67.00
52-53	Merc	8A-3050kit.	40.00

Lower Control Arm Bushing

Four required per vehicle.



54-59	Pass	B4A-3069ea.	7.50
54-56	Merc	B4A-3069ea.	7.50

Lower Ball Joint

Two required per vehicle.

54-56	Pass	B5A-3050-Aea.	55.00
54-56	Merc	B5A-3050-Aea.	55.00
55-57	T-Bird	B5A-3050-Aea.	55.00

Suspension Seals

Four of each required per vehicle.

49-53	Pass	8M-3074,	inner lower arm.....ea.	3.00
49-53	Pass	8A-3075,	outer upper armea.	3.00
49-53	Pass	8M-3076,	inner upper armea.	3.00

49-53	Pass	8A-3088-B,	lower outer arm.....ea.	3.00
49-53	Merc	8M-3074,	inner lower arm.....ea.	3.00
49-53	Merc	8M-3076,	inner upper armea.	3.00
52-53	Merc	8A-3075,	outer upper armea.	3.00
52-53	Merc	8A-3088-B,	lower outer arm.....ea.	3.00

Ball Joint Washer Kit

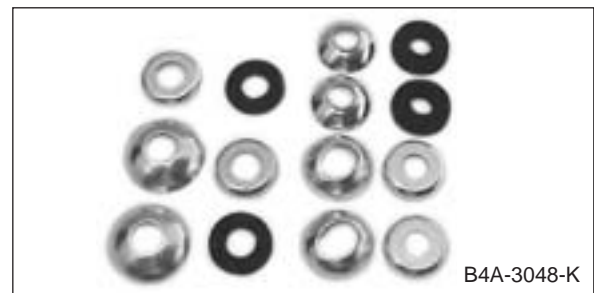

54-56	Pass	B4A-3048-Kkit.	22.95
54-56	Merc	B4A-3048-Kkit.	22.95
55-57	T-Bird	B4A-3048-Kkit.	22.95

Upper Suspension Washer Kit

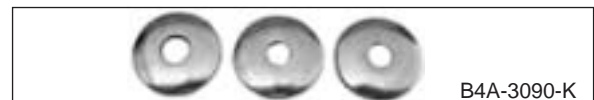

54-56	Pass	B4A-3090-Kkit.	7.00
54-56	Merc	B4A-3090-Kkit.	7.00
55-57	T-Bird	B4A-3090-Kkit.	7.00



Lower Suspension Washer Kit

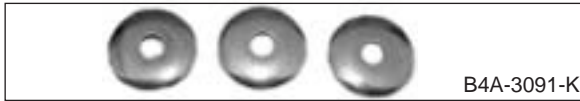

54-56	Pass	B4A-3091-K	kit.	5.50
54-56	Merc	B4A-3091-K	kit.	5.50
55-57	T-Bird	B4A-3091-K	kit.	5.50

Upper Suspension Bumper



49-53	Pass	8A-3025	ea.	3.00
54-56	Pass	B4AZ-3020	ea.	6.00

Lower Suspension Bumper



49-52	Pass	AB-3019-A	ea.	8.00
54-56	Pass	B5A-3020-A, LH.....	ea.	9.50
54-56	Pass	B5A-3019-A, RH	ea.	9.50
49-51	Merc	8M-3020-USA	pr.	25.50

Coil Spring Pad



49-56	Pass	B8A-5415	ea.	5.00
49-56	Merc	B8A-5415	ea.	5.00

SHOCKS

Shock Absorber Fluid

28-48	Pass & PU	A-18099, 16oz.	ea.	6.00
-------	-----------	---------------------	-----	------

Shock Bolt Set

One set req'd for 4 shocks.

28-36	Pass & PU	A-18015-MB.....	set.	9.50
-------	-----------	-----------------	------	------

Shock Arm Bolt

28-36	Pass & PU	1150, 4 pcs.....	set.	6.50
-------	-----------	------------------	------	------

Shock Links



28-34	Pass	B-18055, early 34, holes on opposite side	ea.	8.00
-------	------	--	-----	------



34-35	Pass	40-18055, late 34, holes on same side.....	ea.	10.00
35-40	Merc	48-18055, 3"	ea.	17.50



37-48	Merc	78-18055, 4"	ea.	17.50
41-48	Merc	99A-18055, 4 3/4"	ea.	20.00
28-34	PU	B-18055, early 34, holes on opposite side	ea.	8.00
34-35	PU	40-18055, late 34, holes on same side.....	ea.	10.00
35-40	PU	48-18055, 3"	ea.	17.50
37-41	PU	78-18055, 4"	ea.	17.50

Shock Link Nuts

35-48	Pass	R-009, 8 pcs.....	set.	11.50
35-47	PU	R-009, 8 pcs.....	set.	11.50

Shock Link Bushing



28-35	Pass & PU	B-18060.....	pr.	6.00
-------	-----------	--------------	-----	------

TUBE SHOCKS



Front Tube Shocks

47-48	Pass	7RC-18125-A	ea.	32.00
49-56	Pass	8A-18124	ea.	65.00
47-48	Merc	7RC-18125-A	ea.	32.00
49-56	Merc	8A-18124	ea.	65.00
55-57	T-Bird	8A-18124	ea.	65.00
48-55	PU	7RC-18125-A	ea.	32.00
56	PU	8A-18124	ea.	65.00

Rear Tube Shocks

47-51	Pass	7RC-18125-A	ea.	32.00
52-58	Pass	APA-18125	ea.	33.00
49-51	Wgn	8M-18125	ea.	34.00
49-51	Merc	8M-18125	ea.	34.00
52-58	Merc	APA-18125	ea.	33.00
48-55	PU	7RC-18125-A	ea.	32.00
56-60	PU	B6C-18125, F-100, F-250.....	ea.	30.00

Tube Shock Bushing

47-56	Pass & PU	51A-18197	ea.	1.50
49-56	Pass	8M-18198-1050, front shock	ea.	2.00

Front Tube Shock Kits

Designed to bolt in place of original shocks. No welding. Front axle perch bolt is included.



35-36	Pass	48-18124-KIT	kit.	212.95
37-40	Pass	78-18124-KIT, cannot use original sway bar on 1940.....	kit.	212.95
42-48	Pass	11A-18124-KIT	kit.	212.95
42-48	Merc	11A-18124-KIT	kit.	212.95
35-36	PU	48-18124-KIT	kit.	212.95
37-40	PU	78-18124-KIT, cannot use original sway bar on 1940.....	kit.	212.95

Rear Tube Shock Kits

Designed to bolt in place of original shocks. No welding. Must remove brake drums to install lower shock bracket.

35-36	Pass	48-18125-KIT	kit.	212.95
37-40	Pass	78-18125-KIT	kit.	212.95
41-48	Pass	11A-18125-KIT	kit.	212.95
41-48	Merc	11A-18125-KIT	kit.	212.95
35-36	PU	48-18125-KIT	kit.	212.95
37-41	PU	78-18125-KIT	kit.	212.95

WISHBONE

Radius Rod Bushing Ball

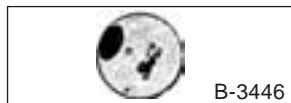

32-40	Pass	B-3446	ea.	10.00
41-48	Pass	11A-3446-A	ea.	3.50
39-40	Merc	99A-3446	ea.	4.50
41-48	Merc	11A-3446-A	ea.	3.50
32-41	PU	B-3446	ea.	10.00

Radius Rod Bushing Ball Cover

32-40	Pass	B-3440, good used.....	ea.	12.00
39-40	Merc	99A-3440, NOS.....	ea.	5.00
32-41	PU	B-3440, good used.....	ea.	12.00

SWAY BAR/TRACK BAR

Stabilizer Bar/Sway Bar Kit

For use on 1940-48 cars, and 1940-41 pick-ups when using front tube shock kit. Includes 1" sway bar, urethane bushings and end links to mount to the replacement axle bolts that are included in the front shock kit. 1942-48 cars need modification to mount on frame.

40-48	Pass	01A-3535-ST	ea.	212.95
40-41	PU	01A-3535-ST	ea.	212.95

Stabilizer Bar/Sway Bar Bushings

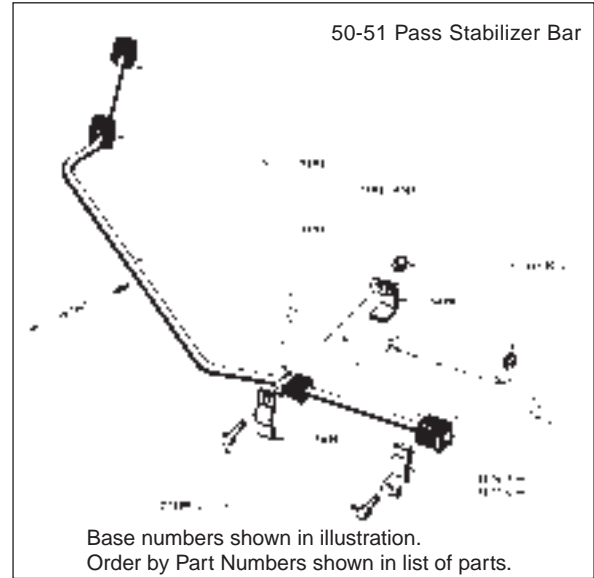

40-41	Pass	11A-3558-A	pr.	10.00
42-48	Pass	21A-5484-A	pr.	10.00
49-53	Pass	AB-5493, enlarge hole for wagon.....	ea.	6.00
54-56	Pass	B5A-5493.....	pr.	8.00
40-41	Merc	11A-3558-A	pr.	10.00



42-48	Merc	21A-5484-A	pr.	10.00
55-57	T-Bird	B5A-5493.....	pr.	8.00
40-41	PU	11A-3558-A	pr.	10.00

Stabilizer Bar Bushing Clamp

49-51	Pass	8A-5476, RH outer N.O.S.	ea.	18.00
49-51	Pass	8A-5477, LH outer N.O.S.	ea.	18.00
54-56	Pass	8M-5486, 2 required.....	ea.	11.95
49-51	Merc	8M-5486, center bracket, 2 required.....	ea.	11.95
55-57	T-Bird	8M-5486, 2 required.....	ea.	11.95

Stabilizer Bar Bushing and Clamp Kit

50-51	Pass	0A-5475-AK, except wagon.....	kit.	69.95
-------	------	-------------------------------	------	-------



Stabilizer Swivel



01A-3533-34

40-41	Pass	01A-3533/34	pr.	60.00
40-41	Merc	01A-3533/34	pr.	60.00
40-41	PU	01A-3533/34	pr.	60.00

Spring Perch Bushing & Stud

40-41	Pass	51A-5464-T, teflon	ea.	10.00
40-41	PU	51A-5464-T, teflon	ea.	10.00

Stabilizer Bar End Link



21A-18055

42-48	Pass	21A-18055, 2.39"	ea.	17.50
42-48	Merc	21A-18055, 2.39"	ea.	17.50

Stabilizer Bar End Link Kit



B4AZ-5A486-A

54-56	Pass	B4AZ-5A486-A	kit.	17.00
55-57	T-Bird	B4AZ-5A486-A	kit.	17.00

Front and Rear Track Bar Bushing

Two bushings required per end.



51A-18197

42-48	Pass	51A-18197	ea.	1.50
42-48	Merc	51A-18197	ea.	1.50

“Just a note to let you know how pleased I am with your parts and service-Your staff is very knowledgeable and you always have the right parts and they arrive quickly. I have used your items on five 1940 Fords with great results. I live in Sacramento area and there are other stores around here that sell Ford parts as well, but they lack the knowledge and never have what I need-don't even go to them anymore.”
Thanks-have a SAFE day
Tim B., California

**Section 7
Steering**

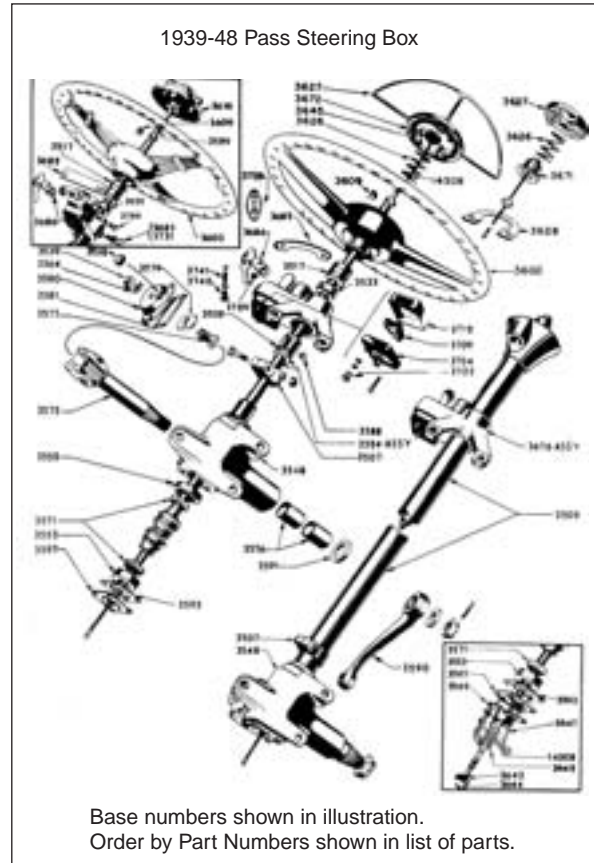

REBUILT STEERING BOX

We can rebuild your steering box. Varies in price depending on year, model, and diagnosis of your core. It is just like rebuilding an engine. You do not know everything you need until you take it all apart and inspect the pieces. Takes 2-4 weeks.

WORM & SHAFT

Worm & Shaft

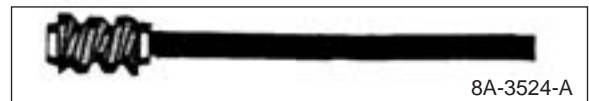

8A-3524-A

37-40	Pass	78-3524, have to enlarge shaft hole at bottom for tube	ea.	142.50
41-48	Pass	11A-3524-R	ea.	142.50
49-50	Pass	8A-3524-A	ea.	142.50
51	Pass	1A-3524-A	ea.	142.50
52-53	Pass	AB-3524-A	ea.	142.50
54	Pass	AD-3524-A	ea.	142.50
55	Pass	B5A-3524-A	ea.	142.50
56	Pass	B6A-3524-B, 2 teeth	ea.	115.00
56	Pass	B6A-3524-C, 3 teeth	ea.	142.50

37-41	PU	78-3524, have to enlarge shaft hole at bottom for tubeea.	142.50
48-52	PU	7HC-3524ea.	142.50
53-55	PU	TAAA-3524ea.	142.50
56	PU	B6C-3524-Aea.	142.50

Worm Gear

Need to press onto your shaft.



32-34	Pass	B-3524, #13ea.	70.00
32-34	Pass	40-3524-X, #15ea.	95.00
35	Pass	48-3524-X, #15ea.	65.00
36	Pass	68-3524-X, #17ea.	75.00
37-48	Pass	78-3524-Xea.	65.00
37-48	Pass	78-3524-RH, right hand driveea.	75.00
49-51	Pass	8A-3524-Xea.	65.00
52-53	Pass	AB-3524-Xea.	65.00
54-56	Pass	AD-3524-X, 2 tooth typeea.	70.00
56	Pass	B7A-3524-X, 3 tooth typeea.	65.00
39-48	Merc	78-3524-Xea.	65.00
52-53	Merc	AB-3524-Xea.	65.00
54-56	Merc	AD-3524-X, 2 tooth typeea.	70.00
32-34	PU	B-3524, #13ea.	70.00
32-34	PU	40-3524-X, #15ea.	95.00
35	PU	48-3524-X, #15ea.	65.00
36	PU	68-3524-X, #17ea.	75.00
37-52	PU	78-3524-Xea.	65.00
37-52	PU	78-3524-RH, right hand driveea.	75.00
53-60	PU	B7C-3524-Xea.	70.00

SECTOR

Sector Shaft



32-34	Pass	B-3575-A13, #13ea.	115.00
32-34	Pass	B-3575-B, #15ea.	115.00
35	Pass	48-3575, #15ea.	95.00
36	Pass	68-3575, #17ea.	125.00
37-48	Pass	7RC-3575-Rea.	265.00
39-48	Merc	7RC-3575-Rea.	265.00
32-34	PU	B-3575-A13, #13ea.	115.00
32-34	PU	B-3575-B, #15ea.	115.00
35	PU	48-3575, #15ea.	95.00
36	PU	68-3575, #17ea.	125.00
37-52	PU	7RC-3575-Rea.	265.00
53-56	PU	B6C-3575ea.	299.00

Sector Shaft Roller & Pin Kit



37-48	Pass	7RC-3575-Xkit.	70.00
49-51	Pass	8A-3575-Xkit.	70.00
52-53	Pass	AB-3575-Xkit.	70.00
54-56	Pass	AD-3575-X, 2 teethkit.	70.00
39-48	Merc	7RC-3575-Xkit.	70.00
52-53	Merc	AB-3575-Xkit.	70.00
54-55	Merc	AD-3575-X, 2 teethkit.	70.00
37-52	PU	7RC-3575-Xkit.	70.00
53-60	PU	B7C-3575-Xkit.	70.00

MISC. BOX PARTS

Upper Steering Tube Rubber Bushing

32-51	Pass	B-3517ea.	5.50
39-51	Merc	B-3517ea.	5.50
32-60	PU	B-3517ea.	5.50

Upper Steering Tube Rubber Bushing w/Steel Insert

32-48	Pass	B-3517-Nea.	6.00
39-48	Merc	B-3517-Nea.	6.00
32-52	PU	B-3517-Nea.	6.00

Upper Steering Tube Bearing Kit

This kit includes bearing, spring, and bushing sleeve and replaces rubber bushing.



32-70	Pass	B-3517-K, 3 pcskit.	17.50
39-56	Merc	B-3517-K, 3 pcskit.	17.50
32-70	PU	B-3517-K, 3 pcskit.	17.50

Upper Steering Tube Bearing For Kit

Included in B-3517-K kit.

32-56	Pass	C3DZ-3517-Aea.	6.00
39-56	Merc	C3DZ-3517-Aea.	6.00
32-56	PU	C3DZ-3517-Aea.	6.00

Upper Steering Tube Bearing Sleeve For Kit

Included in B-3517-K kit.

32-56	Pass	B1AZ-3518-Aea.	6.00
39-56	Merc	B1AZ-3518-Aea.	6.00
32-56	PU	B1AZ-3518-Aea.	6.00

Upper Steering Tube Bearing Spring For Kit

Included in B-3517-K kit.

32-56	Pass	C3DZ-3520-Aea.	6.00
39-56	Merc	C3DZ-3520-Aea.	6.00

Section 7 - Steering



C&G Early Ford Parts, Inc.

32-56 PU C3DZ-3520-A.....ea. 6.00

Upper Steering Tube Bearing Spring

51 Pass 8M-3520, with automaticea. 2.00
 49-52 Merc 8M-3520ea. 2.00

Steering Column Ignition Lock Break-off Bolt



32-48 Pass B-3731ea. 4.00
 32-47 PU B-3731ea. 4.00

Upper Worm Bearing Race



32-36 Pass 68-3553ea. 65.00
 37-48 Pass B-3552ea. 12.00
 49-56 Pass 8A-3553ea. 35.00
 39-51 Merc B-3552ea. 12.00
 52-56 Merc 8A-3553ea. 35.00
 32-36 PU 68-3553ea. 65.00
 37-56 PU B-3552ea. 12.00

Lower Worm Bearing Race

32-36 Pass B-3552ea. 12.00
 37-48 Pass 8A-3553ea. 35.00
 49-56 Pass B-3552ea. 12.00
 39-51 Merc 8A-3553ea. 35.00
 52-56 Merc B-3552ea. 12.00
 32-36 PU B-3552ea. 12.00
 37-56 PU 8A-3553ea. 35.00

Worm Bearing

Two required per vehicle.



32-35 Pass B-3571ea. 15.00
 35-60 Pass 68-3571ea. 11.00
 39-56 Merc 68-3571ea. 11.00
 35-60 PU 68-3571ea. 11.00
 38-56 Truck 81T-3571ea. 10.00

Sector Shaft Bearing/Bushing

Two required per vehicle.



32-35 Pass 78-3576-A.....ea. 3.50
 36 Pass 68-3576-A.....ea. 9.50
 37-48 Pass 78-3576-A.....ea. 3.50
 49-55 Pass 68-3576-A.....ea. 9.50

56 Pass 68-3576-A,
 2 teethea. 9.50
 56 Pass B6A-3576-A,
 3 teethea. 10.00
 39-51 Merc 78-3576-A.....ea. 3.50
 52-55 Merc 68-3576-A.....ea. 9.50
 32-35 PU 78-3576-A.....ea. 3.50
 36 PU 68-3576-A.....ea. 9.50
 37-52 PU 78-3576-A.....ea. 3.50
 53-56 PU 81T-3576-A.....ea. 5.00

Sector Shaft Adjusting Screw

37-48 Pass 78-3577ea. 3.25
 39-48 Merc 78-3577ea. 3.25
 37-52 PU 78-3577ea. 3.25
 48-60 PU B7J-3577-B.....ea. 6.00

Sector Shaft Adjusting Screw Star Lock Washer

37-48 Pass 78-3564ea. 1.25
 39-48 Merc 78-3564ea. 1.25
 37-52 PU 78-3564ea. 1.25

Sector Shaft Adjusting Screw Internal Washer

Goes between sector and sector cover inside steering box.

37-48 Pass 78-3579ea. 3.00
 39-48 Merc 78-3579ea. 3.00
 37-52 PU 78-3579ea. 3.00

Steering Box Gasket Set

Sector seal NOT included.

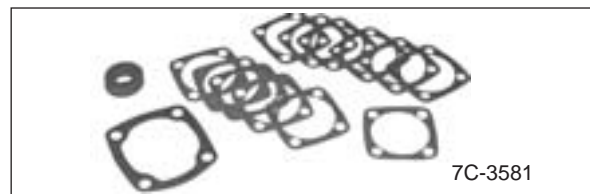

32-36 Pass B-3581-S.....set. 6.00
 37-48 Pass 78-3581-Sset. 6.00
 49-51 Pass 8A-3581set. 8.00
 52-57 Pass AB-3581set. 5.00
 39-48 Merc 78-3581-Sset. 6.00
 52-55 Merc AB-3581set. 5.00
 32-36 PU B-3581-S.....set. 6.00
 37-47 PU 78-3581-Sset. 6.00
 48-60 PU 7C-3581set. 9.00

Sector Shaft Seal



35-48 Pass 48-3591ea. 4.00
 49-55 Pass 8A-3591-A.....ea. 4.00
 56-57 Pass 8M-3591-Aea. 4.00
 39-48 Merc 48-3591ea. 4.00
 49-51 Merc 8M-3591-Aea. 4.00
 52-55 Merc 8A-3591-A.....ea. 4.00
 56 Merc 8M-3591-Aea. 4.00

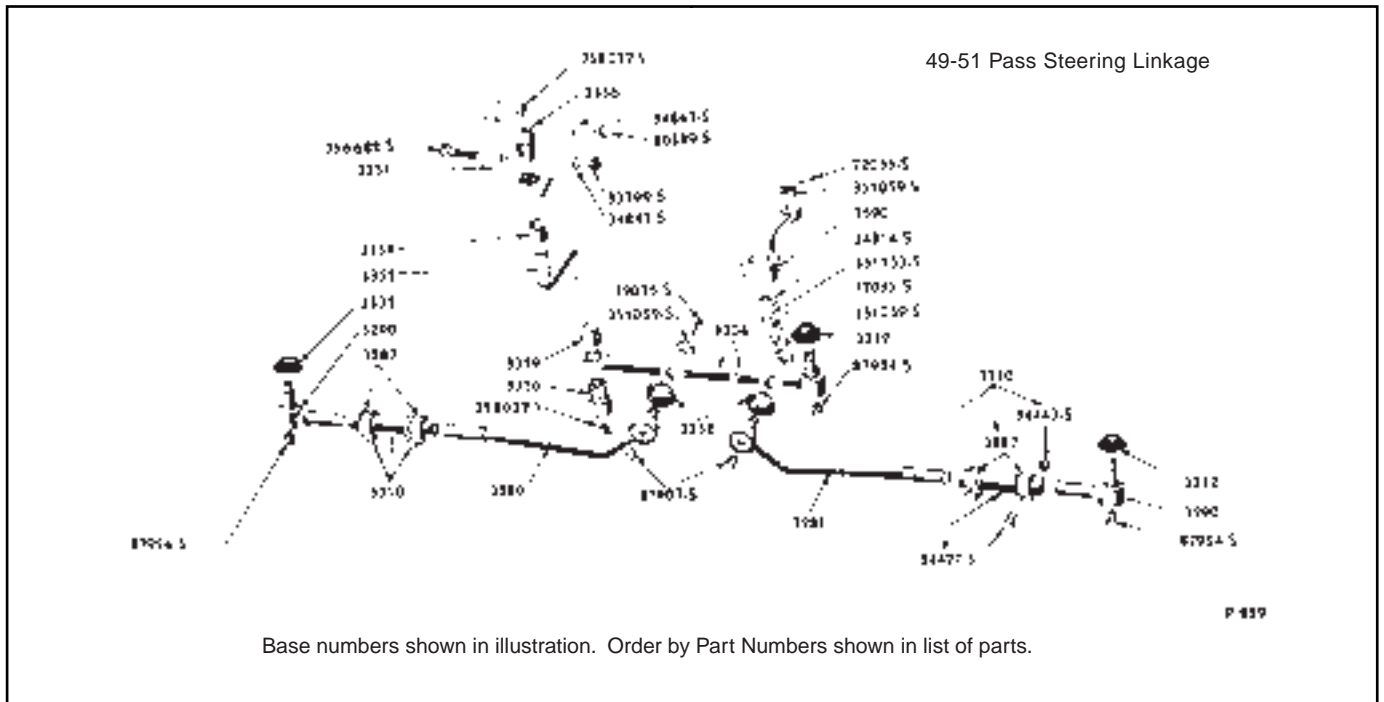

35-47	PU	48-3591ea.	4.00
48-52	PU	8A-3591-Aea.	4.00
48-60	PU	21C-3738-A, feltea.	3.00
53-60	PU	8M-3591-Aea.	4.00
38-47	Truck	81T-3591, NOT pickupea.	4.00

Pitman Arm



37-41	Pass	11A-3590, N.O.S., casting #11A-3590ea.	50.00
37-41	Merc	11A-3590, N.O.S., casting #11A-3590ea.	50.00
37-41	PU	11A-3590, N.O.S., casting #11A-3590ea.	50.00
48-52	PU	8C-3590ea.	60.00
53-56	PU	TAAA-3590, F-100&F-250ea.	75.00

TIE RODS/DRAW LINKS

Outer Tie Rod End



35-48	Pass	11A-3289, RHea.	17.00
35-48	Pass	11A-3290, LHea.	17.00
49-59	Pass	11A-3290, 2 req'dea.	17.00

39-48	Merc	11A-3289, RHea.	17.00
39-48	Merc	11A-3290, LHea.	17.00
49-59	Merc	11A-3290, 2 req'dea.	17.00
35-64	PU	11A-3289, RHea.	17.00
35-64	PU	11A-3290, LHea.	17.00

Inner Tie Rod End



49-51	Pass	8A-3280, RHea.	39.50
49-51	Pass	8A-3281, LHea.	39.50
52-53	Pass	AB-3280, 2 req'dea.	39.50
54-56	Pass	AD-3280, 2 req'dea.	35.00
49-51	Merc	8M-3280, 2 req'dea.	37.00
52-53	Merc	MA-3280, 2 req'dea.	42.00
54-56	Merc	MB-3280, 2 req'dea.	42.00

Tie Rod

Ends are NOT included.

32-34	Pass	B-3281ea.	20.50
35-36	Pass	48-3283ea.	55.00
37-41	Pass	78-3283ea.	49.00
42-48	Pass	21A-3282ea.	55.00
39-41	Merc	78-3283ea.	49.00
42-48	Merc	21A-3282ea.	55.00
32-34	PU	B-3281ea.	20.50
35-36	PU	48-3283ea.	55.00
37-41	PU	78-3283ea.	49.00
42-52	PU	21A-3282ea.	55.00
53-64	PU	TAAA-3281-A, F-100, F-250ea.	59.50

Drag Link & Center Link



35-40	Pass	11Y-3306, w/end.....set.	110.00
42-48	Pass	21A-3306, w/end.....set.	110.00
49-51	Pass	8A-3304.....ea.	65.00
52-54	Pass	AB-3305.....ea.	54.95
54-56	Pass	AD-3304-C, w/p/s.....ea.	315.00
39-40	Merc	11Y-3306, w/end.....set.	110.00
42-48	Merc	21A-3306, w/end.....set.	110.00
49-51	Merc	8M-3304.....ea.	125.00
54-55	Merc	MB-3305-B, w/p/s.....ea.	65.00
35-41	PU	11Y-3306, w/end.....set.	110.00
42-47	PU	21A-3306, w/end.....set.	110.00
48-56	PU	TAAA-3304-S.....ea.	85.00

Tie Rod & Drag Link Repair Kit



28-34	Pass	B-3305-RK, metal.....kit.	12.50
28-34	Pass	A-3305-SE, teflon.....kit.	45.00
52-60	Pass	B2AZ-3533-A, w/m/s.....kit.	40.00
55-60	T-Bird	A8TZ-3533-A.....kit.	28.00
28-34	PU	B-3305-RK, metal.....kit.	12.50
28-34	PU	A-3305-SE, teflon.....kit.	45.00
48-56	PU	A8TZ-3533-A.....kit.	28.00

Drag Link Adjusting Sleeve



35-48	Pass	11A-3310.....ea.	13.50
39-48	Merc	11A-3310.....ea.	13.50
35-47	PU	11A-3310.....ea.	13.50

Tie Rod Adjusting Sleeve

49-56	Pass	11A-3310, 2 req'd.....ea.	13.50
49-56	Merc	11A-3310, 2 req'd.....ea.	13.50

Tie Rod End Seals

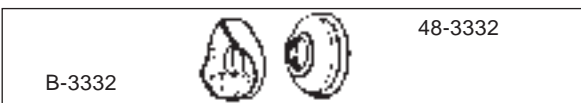

28-34	Pass	B-3332, 4 pcs.....kit.	5.00
35-56	Pass	48-3332, 4 pcs.....set.	6.00
39-56	Merc	48-3332, 4 pcs.....set.	6.00
28-34	PU	B-3332, 4 pcs.....kit.	5.00
35-56	PU	48-3332, 4 pcs.....set.	6.00

Drag Link Seals

49-51	Pass	48-3332, 4 pcs.....set.	6.00
48-56	PU	7RC-3336.....ea.	4.00

Tie Rod & Drag Link Seal Metal Cap

For use w/part #B-3332, 4 pieces.

28-34	Pass & PU	BB-3333-AS.....set.	5.00
-------	-----------	---------------------	------

Tie Rod & Drag Link Ball Stud

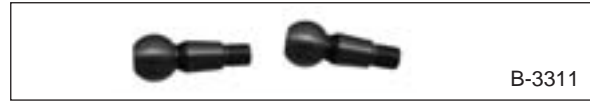

28-34	Pass	B-3311, threaded, bolt on.....ea.	6.50
28-34	PU	B-3311, threaded, bolt on.....ea.	6.50
48-56	PU	TAAA-3284, 1/2 & 3/4 Ton.....ea.	15.00

IDLER ARM

Idler Arm Support Bracket



49-59	Pass	8A-3351, manual steering.....ea.	11.00
52-53	Merc	8A-3351, manual steering.....ea.	11.00
55-59	T-Bird	8A-3351, manual steering.....ea.	11.00

Idler Arm



49-51	Pass	A9A-3352-A.....kit.	25.00
52-53	Pass	B2A-3352-A, m/s.....kit.	27.50
54-56	Pass	B5A-3352, m/s.....kit.	27.50
54-59	Pass	B4A-3352-A, power steering.....kit.	32.50
49-51	Merc	8M-3352.....kit.	40.00
52-53	Merc	B2A-3352-A, m/s.....kit.	27.50
54-56	Merc	B5A-3352, m/s.....kit.	27.50
55-57	T-Bird	B5S-3352-B, p/s.....kit.	173.00

Idler Arm Bushing

52-59	Pass	MB-3356-A, m/s.....pr.	10.00
52-59	T-Bird	MB-3356-A, m/s.....pr.	10.00

Idler Arm Seal

49-59	Pass	8A-3359, manual steering.....ea.	3.00
-------	------	----------------------------------	------

STEERING WHEEL PARTS

Steering Wheel



35-36	Std Pass	68-3600-A.....ea.	185.00
37-38	Pass	78-3600.....ea.	165.00
37-38	Pass	91A-3600, banjo.....ea.	205.00
39	Std Pass	78-3600.....ea.	165.00
39	Dlx Pass	91A-3600, banjo.....ea.	205.00
40	Std Pass	01A-3600-DLX, deluxe style with stainless trim.....ea.	260.00
40	Dlx Pass	01A-3600-DLX.....ea.	260.00
40	Dlx Pass	01A-3600-SR, 15", only fits GM steering column.....ea.	290.00
41-48	Pass	6A-3600.....ea.	160.00
35-36	PU	68-3600-A.....ea.	185.00
37-39	PU	78-3600.....ea.	165.00
40-47	PU	01A-3600-DLX, deluxe style with stainless trim.....ea.	260.00
48-52	PU	8T-3600.....ea.	200.00
53-55	PU	TAAA-3600.....ea.	200.00
56-60	PU	B6C-3600.....ea.	200.00

Steering Wheel Puller Tool



All	Pass & PU	TOOL-3600.....ea.	9.95
-----	-----------	-------------------	------

Steering Wheel Spinner

All		70109, black.....ea.	6.50
All		ACC-70110, polished aluminum.....ea.	8.00

Steering Wheel Nut

32-56	Pass & PU	A-3610, 5/8-18.....ea.	1.00
-------	-----------	------------------------	------

Steering Wheel Woodruff Key

28-48	Pass	B-3609.....ea.	2.00
29-47	PU	B-3609.....ea.	2.00

Horn Button

Note: For horn button wires, see section 25



40	Pass	01A-3627-P, plain.....ea.	7.50
40	Std Pass	01A-3627-A.....ea.	20.00
40	Dlx Pass	01A-3627-B.....ea.	20.00
40	Merc	09A-3627, plain.....ea.	20.00
40-47	PU	01A-3627-P, plain.....ea.	7.50
40-47	PU	01A-3627-C.....ea.	20.00
48-52	PU	7HC-3627-C.....ea.	18.00
53-60	PU	B6C-3627-A, w/red.....ea.	45.00
53-64	PU	BAAA-3627.....ea.	45.00
54-56	PU	B4C-3627-A, painted w/5 star design.....ea.	45.00
54-56	PU	B4C-3627-SS, SS w/5 star design.....ea.	45.00

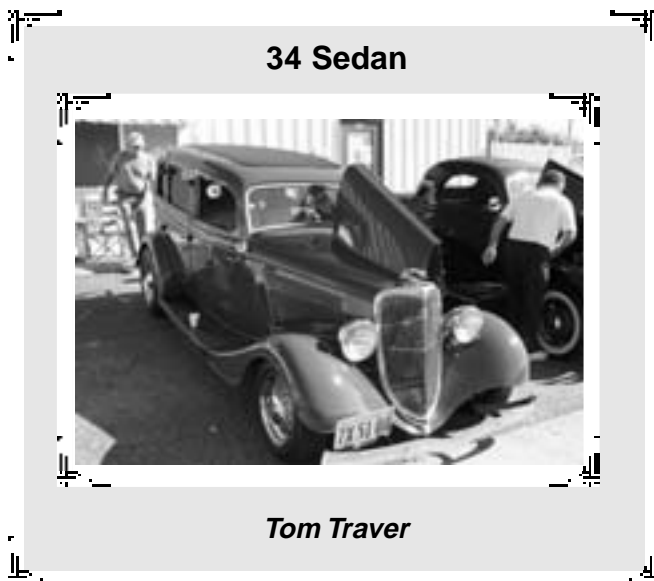



Horn Button Emblem



46	Pass	6A-3627-B, exc conv & wgn, blue background	ea.	55.00
46	Conv	51A-3627-C, beige background	ea.	50.00
46	Wagon	51A-3627-C, beige background	ea.	50.00
47-48	Pass	6A-3627, gold background	ea.	30.00
49	Pass	8A-3627	ea.	40.00
50	Pass	0A-3627	ea.	40.00
53	Pass	FAD-3627, 50th anniversary	ea.	35.00
55	Pass	B5A-3627	ea.	30.00
56	Pass	B6A-3627	ea.	30.00
56	T-Bird	B6A-3627	ea.	30.00
46-47	Merc	59A-3627-A, maroon back ground, orange center	ea.	60.00
47-48	Merc	59A-3627-B, white back ground, red center	ea.	60.00



49-50	Merc	0M-3649-A, for standard steering wheel, gold back -ground, chrome emblem	ea.	50.00
49-51	Merc	8M-3649-B, black back ground	ea.	100.00
49-51	Merc	8M-3649-R, orange center, red and white back ground	ea.	100.00
55	Merc	FDK-3623-F, red back ground "Power Steering"	ea.	75.00
56	Merc	FDT-3623-B, white back ground "Power Steering"	ea.	75.00

53	PU	BAAA-3627-50TH, 50th anniversary	ea.	45.00
----	----	--	-----	-------

Horn Button Emblem Retainer Ring

Made from stainless steel.

42-48	Pass	6A-3628	ea.	12.50
42-48	Merc	6A-3628	ea.	12.50

Horn Button Spring

40	Pass	01A-3626	ea.	2.00
41-50	Pass	21A-3626	ea.	2.00
52-62	Pass	B4AZ-13A807-A	ea.	3.75
40	Merc	01A-3626	ea.	2.00
41-50	Merc	21A-3626	ea.	2.00
40-47	PU	01A-3626	ea.	2.00
48-56	PU	A7TZ-13A807A	ea.	5.00

Horn Button Mounting Cup



48-52	PU	A7TZ-13A809-A	ea.	9.95
53-56	PU	B3TZ-13A809-A	ea.	9.95

Horn Button Retaining Spring

48-56	PU	7RC-14479	ea.	2.50
-------	----	-----------------	-----	------

Horn Button Contact Plate



48-56	PU	7RC-3631	ea.	5.00
-------	----	----------------	-----	------

Horn Button Insulator



41-48	Pass	11A-3672	ea.	3.00
49-50	Pass	0A-3672	ea.	4.00
52-56	Pass	B5A-3672-A	ea.	1.25
55-56	Pass	B5A-3672-B, for emblem	ea.	3.00
41-48	Merc	11A-3672	ea.	3.00

Horn Light Rod Repair Kit

28-39	Pass & PU	A-3630-S	kit.	6.50
-------	-----------	----------------	------	------

Light Switch Spider Spring

28-39	Pass & PU	B-3642	ea.	1.50
-------	-----------	--------------	-----	------

Light Switch Spider

28-39	Pass & PU	B-3643	ea.	4.00
-------	-----------	--------------	-----	------

Light Switch Spider Retainer

28-39	Pass & PU	B-3644	ea.	.75
-------	-----------	--------------	-----	-----

Light Switch Bail



28-36 Pass & PU B-3647-Aea. 3.00

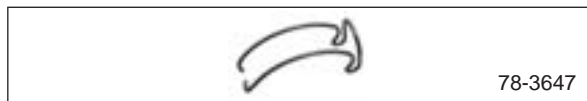

37-39 Pass & PU 78-3647ea. 4.00

STEERING COLUMN

Lower Steering Column to Floor Seal

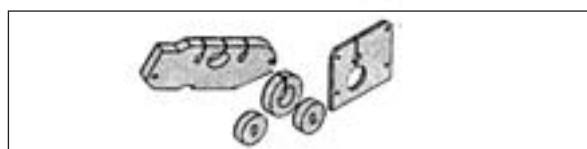

32	Pass	B-35190ea.	10.00
33-34	Pass	40-35190ea.	10.00
35-38	Pass	48-35190ea.	10.00
40	Pass	01A-35190ea.	5.00
41-48	Pass	11A-35190ea.	10.00
49-50	Pass	8A-3513ea.	6.00
51	Pass	1A-3513ea.	6.00
52-54	Pass	BA-3513-Cea.	10.00
55-56	Pass	B5A-3513ea.	10.00
41-48	Merc	19A-7001731ea.	15.00
49-51	Merc	8M-3513ea.	68.00
48-52	PU	7C-3513, column shiftea.	4.00
48-52	PU	7C-3513-A, floor shiftea.	4.00
53-56	PU	BAAA-3513, column shiftea.	6.00
53-56	PU	BAAA-3513-A, floor shiftea.	6.00

Steering Column Seal Kit

55-57 T-Bird B5S-3528-Akit. 27.00

Upper Steering Column Floor Seal

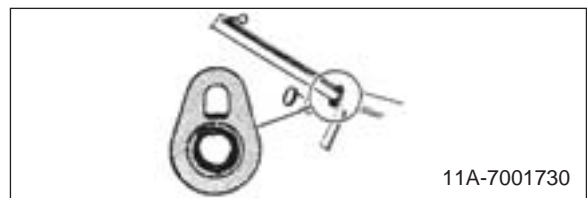

41-58	Pass	11A-7001730ea.	8.00
41-56	Merc	11A-7001730ea.	8.00
48-52	PU	7C-3515, column shift, w/clipkit.	8.00
48-52	PU	7C-3515-A, floor shift, w/clipkit.	8.00

Steering & Pedal Floor Plate

32	Pass	B-35122ea.	28.50
33-34	Pass	40-700392ea.	34.00
35-36	Pass	48-700392ea.	28.50

36	Pass	68-700392ea.	25.00
40-41	PU	01C-8112145ea.	25.00

Steering & Ignition Lock Assembly

NOS shelf worn



41 Merc 19A-3676-Bea. 150.00

Ignition Plate, Lever, and Button Kit

All polished stainless steel. Includes on-off plate with rivits, on-off lever, and the end cap button.



40 Pass 01A-3676-Kkit. 45.00

Steering Column Bracket to Dash Seal

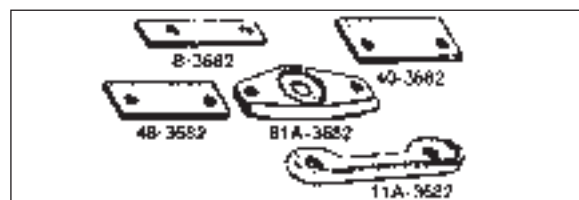

32	Pass	B-3682ea.	2.00
33-34	Pass	40-3682ea.	2.00
35-37	Pass	48-3682ea.	2.00
38-39	Pass	81A-3682ea.	5.00
40	Pass	01A-3682pr.	2.00
41-48	Pass	11A-3682ea.	5.00
55	Pass	B5A-3683-Aea.	6.00
56	Pass	B6A-3683-Aea.	6.00
42-48	Merc	11A-3682ea.	5.00
32-47	PU	48-3682ea.	2.00
48-52	PU	7C-3679-Sea.	3.00

Steering Column to Dash Bracket Pad

53-56 PU TAAA-3693ea. 3.00



POWER STEERING PARTS

Power Steering Pump Repair Kit

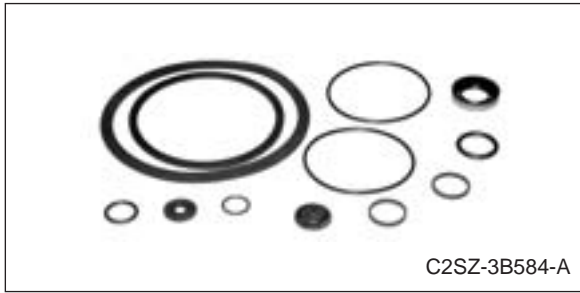

C2SZ-3B584-A

54	Pass	B4AZ-3B584-C.....kit.	40.00
57-59	Pass	C2SZ-3B584-A.....kit.	18.00
55-57	T-Bird	B4AZ-3B584-C.....kit.	40.00

Power Steering Pump Shaft Seal

53-65	Pass	B3AZ-3B592-A.....ea.	6.50
-------	------	----------------------	------

Power Steering Pump Filter

54-56	Pass	AE-33538-A, 3.09" o.d.....ea.	14.95
-------	------	-------------------------------	-------

Power Steering Pump Lid

55-56	Pass	B5A-3A582-A.....ea.	24.95
-------	------	---------------------	-------

Power Steering Pressure Hose

55-56	Pass	B7AZ-3A719-A, V8.....ea.	37.50
-------	------	--------------------------	-------

Power Steering Return Hose

54-56	Pass	B5A-3A713, 6cyl.....ea.	22.95
55-56	Pass	B5A-3A713, V8.....ea.	22.95

Power Steering Hose Bracket Insulator

53-56	Pass	B3AZ-3A609-A.....ea.	7.95
53-56	Merc	B3AZ-3A609-A.....ea.	7.95

Power Steering Control Valve to Cylinder Hose

One of each required per car.

54-56	Pass	B5A-3A714-A.....ea.	34.95
54-56	Pass	B5A-3A717-A.....ea.	34.95

Power Steering Control Valve Repair Kit



B5AZ-3A650-A

53-55	Pass	B3AZ-3A650-A, early 55.....kit.	18.95
55-56	Pass	B5AZ-3A650-A, late 55.....kit.	35.00

Power Steering Cylinder Repair Kit



B5AZ-3A764-A

53-55	Pass	B3AZ-3A764-A.....kit.	42.00
55-56	Pass	B5AZ-3A764-A.....kit.	30.00
55-56	T-Bird	B5AZ-3A764-A.....kit.	30.00

Power Steering Control Valve Socket

53-56	Pass	B5AZ-3A754-A.....ea.	29.50
53-56	T-Bird	B5AZ-3A754-A.....ea.	29.50

Power Steering Piston Rod End Bushing Kit



B3AZ-3C590-A

53-56	Pass	B3AZ-3C590-A.....kit.	20.00
55-56	T-Bird	B3AZ-3C590-A.....kit.	20.00

Power Steering Piston Rod End Bushings

53-56	Pass	B3AZ-3C590-AR.....pr.	3.50
55-56	T-Bird	B3AZ-3C590-AR.....pr.	3.50

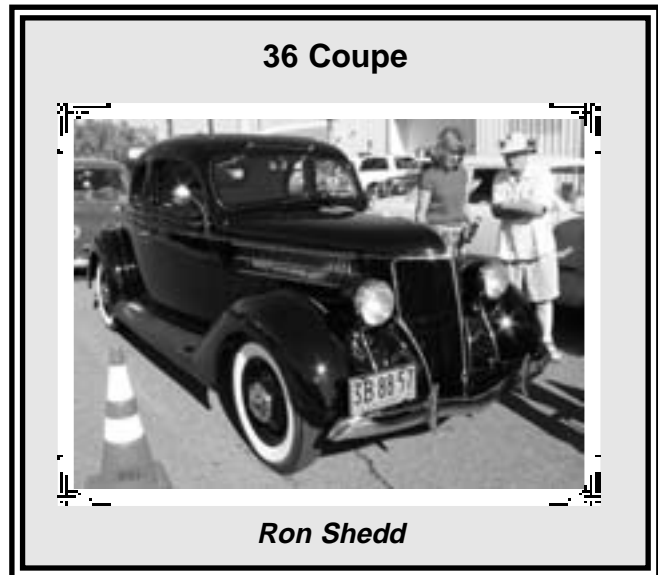

36 Coupe

Ron Shedd

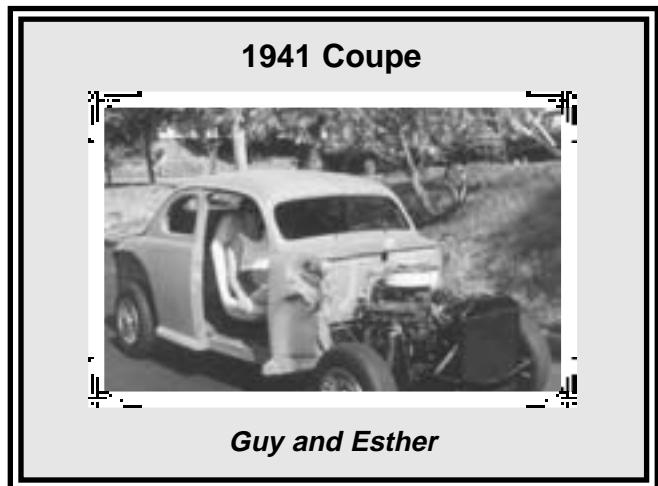

1941 Coupe

Guy and Esther

Section 8 Rear Axle

PINION/DRIVESHAFT

Ring & Pinion Set

35-48	Pass	48-4209-E, 6 spline, 3.54 ratio...ea.	485.00
39-48	Merc	48-4209-E, 6 spline, 3.54 ratio...ea.	485.00
35-41	PU	48-4209-E, 6 spline, 3.54 ratio...ea.	485.00

Pinion Front Bearing

32-34	Pass	18-4621, 2 req'd.....ea.	22.50
35-48	Pass	48-4621, 2 req'd.....ea.	44.00
49-54	Pass	8A-4621.....ea.	32.00
55-56	Pass	B5A-4621-B.....ea.	10.00
39-48	Merc	48-4621, 2 req'd.....ea.	44.00
49-51	Merc	8M-4621.....ea.	20.50
49-56	Merc Wgn	8M-4621.....ea.	20.50
52-54	Merc	8A-4621.....ea.	32.00
55-56	Merc	8M-4621.....ea.	20.50
55-56	T-Bird	8M-4621.....ea.	20.50
32-34	PU	18-4621, 2 req'd.....ea.	22.50
35-47	PU	48-4621, 2 req'd.....ea.	44.00
48-56	PU	8M-4621.....ea.	20.50

Pinion Front Bearing Race

28-34	Pass	B-4616, 4 cyl.....ea.	67.00
32-34	Pass	18-4616, 1 req'd.....ea.	100.00
35-48	Pass	48-4616.....ea.	65.00
49-54	Pass	8A-4616.....ea.	11.00
55-56	Pass	B5A-4616-B.....ea.	5.00
39-48	Merc	48-4616.....ea.	65.00
49-56	Merc	8A-4616.....ea.	11.00
55-56	T-Bird	8A-4616.....ea.	11.00
28-34	PU	B-4616, 4 cyl.....ea.	67.00
32-34	PU	18-4616, 1 req'd.....ea.	100.00
35-47	PU	48-4616.....ea.	65.00
48-56	PU	8A-4616.....ea.	11.00

Pinion Rear Bearing

32-48	Pass	18-4625-A.....ea.	55.00
49-54	Pass	8A-4630, exc. Wgn.....ea.	26.00
55-56	Pass	B5A-4630.....ea.	25.00
49-54	Wgn	8M-4630.....ea.	28.00
39-48	Merc	18-4625-A.....ea.	55.00
49-51	Merc	8M-4630.....ea.	28.00
52-54	Merc	8A-4630.....ea.	26.00
55-56	Merc	8M-4630.....ea.	28.00
55-56	T-Bird	8M-4630.....ea.	28.00
32-47	PU	18-4625-A.....ea.	55.00
48-56	PU	8M-4630.....ea.	28.00

Pinion Rear Bearing Race

49-54	Pass	8A-4628.....ea.	13.00
55-56	Pass	TBAA-4616.....ea.	12.50
49-54	Merc	8A-4628.....ea.	13.00
55-56	Merc	8L-4628.....ea.	15.00

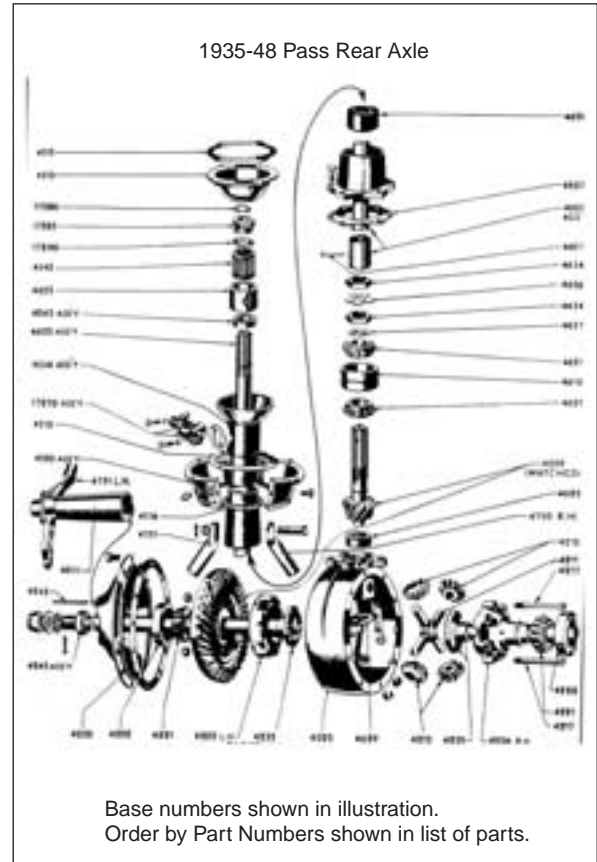

Base numbers shown in illustration.
Order by Part Numbers shown in list of parts.

55-56	T-Bird	8A-4628.....ea.	13.00
48-56	PU	8A-4628.....ea.	13.00
48-56	PU	TBAA-4616.....ea.	12.50

Pinion Shaft Gear

49-51	Merc	8M-4215.....ea.	37.50
55-56	Merc	8M-4215.....ea.	37.50
48-56	PU	8M-4215.....ea.	37.50

Pinion Shaft Gear Washer

49-56	Wgn	8M-4230.....ea.	2.50
52-56	Sdn Dly	8M-4230.....ea.	2.50
49-51	Merc	8M-4230.....ea.	2.50
55-56	Merc	8M-4230.....ea.	2.50
55-56	T-Bird	8M-4230.....ea.	2.50

Pinion Lock Nut

28-32	Pass	B-4634, 4 cyl.....pr.	5.00
28-48	Pass	18-4634, V-8.....pr.	6.00
39-48	Merc	18-4634.....pr.	6.00
28-32	PU	B-4634, 4 cyl.....pr.	5.00
28-48	PU	18-4634, V-8.....pr.	6.00



Pinion Lock Nut Washer

28-32	Pass	B-4636, 4 cylea.	1.75
32-48	Pass	01Y-4636, V-8ea.	1.75
39-48	Merc	01Y-4636ea.	1.75
28-32	PU	B-4636, 4 cylea.	1.75
32-48	PU	01Y-4636, V-8ea.	1.75

Pinion Seal

49-56	Pass	8A-4676ea.	9.00
49-56	Wgn	8M-4676ea.	10.00
49-51	Merc	8M-4676ea.	10.00
52-54	Merc	8A-4676ea.	9.00
55-56	Merc	8M-4676ea.	10.00
55-56	T-Bird	8M-4676ea.	10.00
42-47	PU	01Y-4676ea.	9.00
48-56	PU	8M-4676ea.	10.00

Joint Flange - Axle End

56	Pass	B6A-4851, w/312 V-8ea.	65.00
----	------	---------------------	----------	-------

Driveshaft Coupler



35-48	Pass	48-4684, 6x10 splineea.	72.50
37-48	Pass	68-4684, 6x6 splineea.	53.00
39-48	Merc	68-4684, 6x6 splineea.	53.00
35-41	PU	48-4684, 6x10 splineea.	72.50
35-41	PU	68-4684, 6x6 splineea.	53.00

Driveshaft Coupler Pin

For 10 spline coupler. Must be cut for 6 spline coupler.



32-48	Pass	48-4607ea.	1.25
39-48	Merc	48-4607ea.	1.25
32-41	PU	48-4607ea.	1.25

Driveshaft Front Bearing

28-48	Pass	B-4645ea.	13.50
39-48	Merc	B-4645ea.	13.50
28-41	PU	B-4645ea.	13.50

Driveshaft Front Bearing Sleeve

28-48	Pass	B-4655ea.	9.50
39-48	Merc	B-4655ea.	9.50
28-41	PU	B-4655ea.	9.50

Driveshaft Front Bearing Seal

28-48	Pass	B-4245ea.	5.00
39-48	Merc	B-4245ea.	5.00
28-47	PU	B-4245ea.	5.00

AXLE

Axle Housing Bearing

Two required per vehicle.

28-34	Pass	B-4221, 4 cylea.	42.50
32-36	Pass	18-4221ea.	53.00
37-48	Pass	68-4221ea.	34.00
39-48	Merc	68-4221ea.	34.00
28-34	PU	B-4221, 4 cylea.	42.50
32-36	PU	18-4221ea.	53.00
37-47	PU	68-4221ea.	34.00

Axle Housing Bearing Race

Two required per vehicle.

28-34	Pass	B-4222, 4 cylea.	27.50
32-36	Pass	18-4222ea.	20.00
37-48	Pass	68-4222ea.	20.00
39-48	Merc	68-4222ea.	20.00
28-34	PU	B-4222, 4 cylea.	27.50
32-36	PU	18-4222ea.	20.00
37-47	PU	68-4222ea.	20.00

Differential Bearing

49-55	Pass	8A-4221ea.	31.00
56	Pass	B6A-4221-Aea.	30.00
49-51	Merc	8M-4221ea.	30.50
52-54	Merc	8A-4221ea.	31.00
55-56	Merc	8L-4221ea.	25.00
55-56	T-Bird	8M-4221ea.	30.50
48-56	PU	8M-4221ea.	30.50

Differential Bearing Race

49-55	Pass	8A-4222ea.	16.00
56	Pass	B6A-4222-Aea.	19.00
49-51	Merc	8M-4222ea.	13.75
52-54	Merc	8A-4222ea.	16.00
55-56	Merc	8L-4222ea.	13.25
55-56	T-Bird	8M-4222ea.	13.75
48-56	PU	8M-4222ea.	13.75

Differential Side Gear

49-51	Merc	8M-4236ea.	45.00
48-56	PU	8M-4236ea.	45.00

Rear Axle Shim

28-48	Pass	A-4235ea.	1.00
39-48	Merc	A-4235ea.	1.00
28-47	PU	A-4235ea.	1.00

Rear Axle Key

28-48	Pass	B-4243ea.	1.50
39-48	Merc	B-4243ea.	1.50
28-47	PU	B-4243ea.	1.50

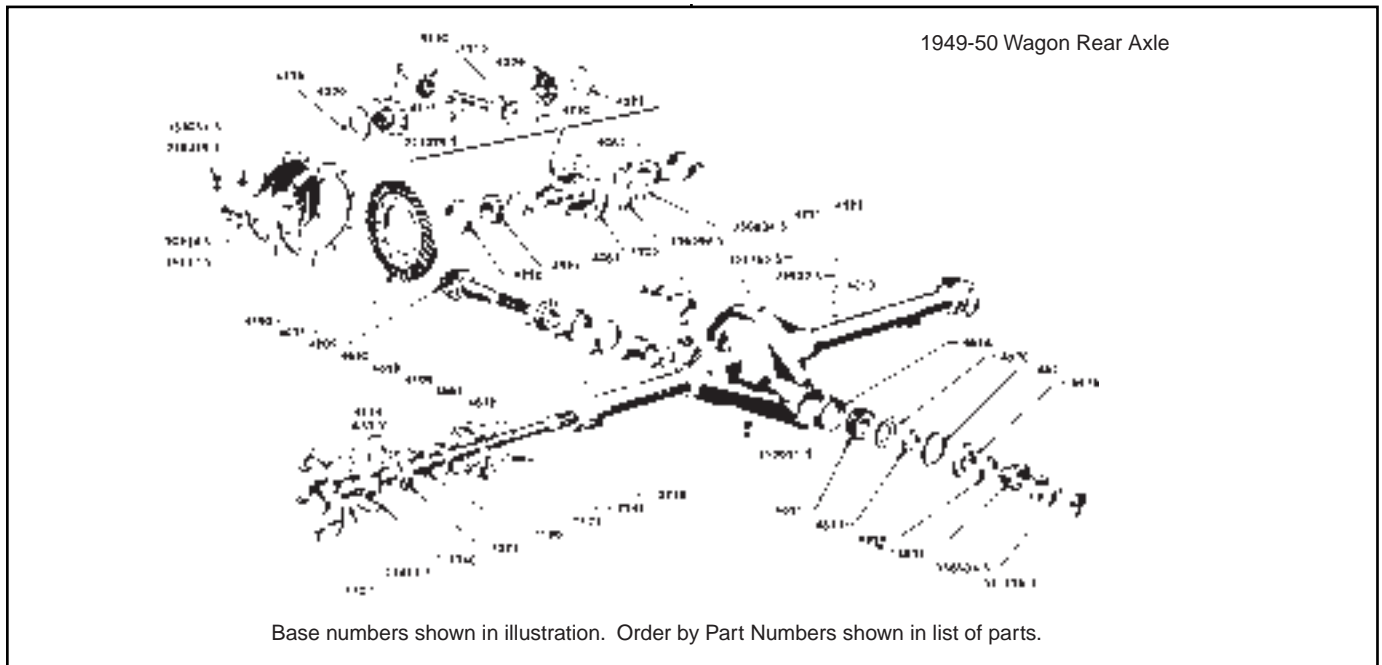

Rear Axle Repair Sleeve

We can install these repair sleeves on your housings, and have your housings straightened. Please allow two to three weeks delivery time. Housings must be cleaned. Hot tanking is preferred.

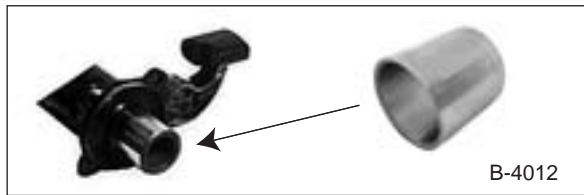

28-48	Pass	B-4012ea.	60.00
39-48	Merc	B-4012ea.	60.00
28-47	PU	B-4012ea.	60.00

Rear Hub Bearing

The 68-1225 bearing is hardened.



28-36	Pass	B-1225-A, 3.12" O.D.ea.	32.00
36-48	Pass	68-1225, 2.78" O.D.ea.	46.00
39-48	Merc	68-1225, 2.78" O.D.ea.	46.00
28-36	PU	B-1225-A, 3.12" O.D.ea.	32.00
36-47	PU	68-1225, 2.78" O.D.ea.	46.00

Rear Hub Grease Seal

28-38	Pass	B-1175ea.	4.00
38-48	Pass	78-1175ea.	4.00
39-48	Merc	78-1175ea.	4.00
28-38	PU	B-1175ea.	4.00
38-47	PU	78-1175ea.	4.00

Rear Axle Filler and Drain Plug

32-48	Pass	B-4030ea.	1.00
-------	------	--------	----------	------

39-48	Merc	B-4030ea.	1.00
32-47	PU	B-4030ea.	1.00

Rear Wheel / Axle Seal

28-48	Pass	B-4245ea.	5.00
49-56	Pass	8A-1177-Aea.	5.00
39-48	Merc	B-4245ea.	5.00
49-51	Merc	B7A-1177-A, 1-1/2" ID 2-1/2" ODea.	5.00
52-54	Merc	8A-1177-Aea.	5.00
52-54	Merc Wgn	B7A-1177-A, 1-1/2" ID 2-1/2" ODea.	5.00
55-56	Merc	B7A-1177-A, 1-1/2" ID 2-1/2" ODea.	5.00
28-47	PU	B-4245ea.	5.00
48-62	PU	B7A-1177-A, 1-1/2" ID 2-1/2" ODea.	5.00

Rear Hub Grease Seal Snap Ring



28-38	Pass	B-1180ea.	2.00
38-48	Pass	78-1180ea.	1.75
39-48	Merc	78-1180ea.	1.75
28-38	PU	B-1180ea.	2.00
38-47	PU	78-1180ea.	1.75

Rear Hub Gasket

28-48	Pass	B-1183pr.	2.00
39-48	Merc	B-1183pr.	2.00
28-47	PU	B-1183pr.	2.00

Rear Axle Nut Washer

32-48	Pass	351505-S8ea.	.50
28-47	PU	351505-S8ea.	.50



Rear Axle Nut and Cotter Pin

Set includes one nut and one pin.

28-48	Pass	1155Aset.	1.50
39-48	Merc	1155Aset.	1.50
28-48	PU	1155Aset.	1.50

Rear Axle Bearing & Retainer

49-56	Pass	8A-1225/1180set.	28.00
49-56	Wgn	8M-1225-A/1180set.	28.00
49-51	Merc	8M-1225-A/1180set.	28.00
52-54	Merc	8A-1225/1180set.	28.00
52-54	Merc Wgn	8M-1225-A/1180set.	28.00
55-58	Merc	8M-1225-A/1180set.	28.00
48-70	PU	8M-1225-A/1180set.	28.00

Rear Wheel Bearing Retainer Gasket



49-56	Pass	8A-2245ea.	3.00
49-56	Wgn	8M-2245ea.	3.00
49-52	Merc	8M-2245ea.	3.00
48-56	PU	8M-2245ea.	3.00

Backing Plate to Axle Housing Gasket



49-56	Pass	8A-2256ea.	3.00
49-56	Wgn	8M-2245-Aea.	3.00
49-52	Merc	8M-2245-Aea.	3.00
48-56	PU	8M-2245-Aea.	3.00

GASKETS

Rear Axle Gasket Set

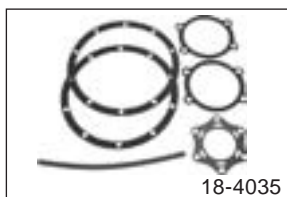

32-48	Pass	18-4035set.	10.00
39-48	Merc	18-4035set.	10.00
32-47	PU	18-4035set.	10.00

Rear Axle Gasket Set With Adjusting Shims

Includes correct shims to properly set up rear axle assembly.

32-48	Pass	18-4035JDset.	26.00
39-48	Merc	18-4035JDset.	26.00
32-47	PU	18-4035JDset.	26.00

Differential Housing Gasket

49-56	Pass	8A-4035ea.	5.00
49-50	Wgn	8M-4035ea.	7.00

51-56	Wgn	1M-4035ea.	6.00
49-50	Merc	8M-4035ea.	7.00
50-51	Merc	1M-4035ea.	6.00
51-56	Merc Wgn	1M-4035ea.	6.00
52-54	Merc	8A-4035ea.	5.00
55-56	Merc	1M-4035ea.	6.00
55-56	T-Bird	1M-4035ea.	6.00
48-50	PU	8M-4035ea.	7.00
51-56	PU	1M-4035ea.	6.00

Columbia Axle Gasket Set

3 piece gasket set for columbia.

32-48	Pass	CO-4035-JDset.	12.50
39-48	Merc	CO-4035-JDset.	12.50
32-41	PU	CO-4035-JDset.	12.50

Torque Tube to Banjo Gasket

32-48	Pass	48-4507ea.	2.00
39-48	Merc	48-4507ea.	2.00
32-47	PU	48-4507ea.	2.00

U-Joint Gasket Set

These gaskets are included in the rear end gasket sets.

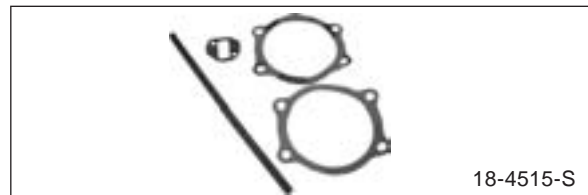

32-48	Pass	18-4515-Sset.	8.00
39-48	Merc	18-4515-Sset.	8.00
32-41	PU	18-4515-Sset.	8.00

LEAF SPRINGS

Rear Spring to Frame Pad



32-48	Pass	11A-5599ea.	3.00
39-48	Merc	11A-5599ea.	3.00
32-41	PU	11A-5599ea.	3.00

Rear Spring Pad



52-56	Pass	AB-5741-A, 4 req'dea.	10.00
55-57	T-Bird	AB-5741-A, 4 req'dea.	10.00

Rear Spring Anti-Squeak Pad

49-56	Pass	AB-5586-A, 12 or 16 req'dea.	1.50
-------	------	------------------------------	----------	------

Rear Spring Clamp & Liner



49-56 Pass C4DZ-5724-B, 6 req'dea. 4.25

Rear Spring Clamp Liner

49-59 Pass 8A-5334-Sset. 8.00
 57 T-Bird B7S-5334-Sset. 6.00

Rear Spring Center Bolt

32-48 Pass B-5345-Rea. 2.15
 39-48 Merc B-5345-Rea. 2.15
 32-41 PU B-5345-Rea. 2.15

Rear Spring U-Bolts

49-56 Pass MA-5705-Fea. 6.00
 52-54 Merc MA-5705-Fea. 6.00
 42-56 PU 21C-5701-Cea. 6.00

Rear Spring U-Bolt Nuts

28-48 Pass 1147set. 6.00
 39-48 Merc 1147set. 6.00
 28-41 PU 1147set. 6.00

Black Leaf Spring Liner

All A-5310-P1, 1 3/4"x 20'ea. 25.00
 All A-5310-P2, 2" x 20'ea. 25.00
 All A-5310-P3, 2 1/4"x 20'ea. 25.00

SPRING SHACKLES/BRACKETS

Rear Spring Shackle Kit

32-34 Pass B-5630set. 24.00
 35-40 Pass 48-5630kit. 24.00
 41 Pass 11A-5630kit. 24.00
 42-48 Pass 21A-5630kit. 29.00
 39-40 Merc 48-5630kit. 24.00
 41 Merc 11A-5630kit. 24.00
 42-48 Merc 21A-5630kit. 29.00
 32-34 PU B-5630set. 24.00
 35-41 PU 48-5630kit. 24.00
 48-56 PU 7C-5630, 1/2 tonkit. 60.00

Teflon Rear Spring Shackle Kit

32-34 Pass B-5630-Tkit. 50.00
 35-40 Pass 48-5630-Tset. 50.00
 39-40 Merc 48-5630-Tset. 50.00
 32-34 PU B-5630-Tkit. 50.00
 35-41 PU 48-5630-Tset. 50.00

Front of Rear Spring Bolt Bushing



49-54 Pass 8A-5630ea. 6.00

55-56 Pass B5A-5781-Cea. 5.00
 56-57 T-Bird B6S-5781-Aea. 4.50

Rear of Rear Spring Shackle

2 required per vehicle.



49-50 Pass 8A-5631-Aset. 30.00
 51-59 Pass APA-5631set. 11.00

Rear Spring Shackle Bushing

38-47 Truck 61-5791-A, 1 ton, 2 req'dea. 5.00
 42-56 PU 21C-5791-A, 2 req'dea. 5.00

Rear Spring Shackle Stud

32-48 Pass 51A-5713ea. 5.00
 39-48 Merc 51A-5713ea. 5.00
 32-41 PU 51A-5713ea. 5.00
 38-47 PU 59Y-5780, 3/4 & 1 tonea. 12.00
 42-56 PU 21C-5780ea. 6.00

Rear Spring Bushing

42-48 Pass 21A-5719ea. 2.50
 49-56 Pass 8A-5719ea. 1.25
 42-48 Merc 21A-5719ea. 2.50
 49-51 Merc 8M-5719ea. 1.00
 52-56 Merc 8A-5719ea. 1.25
 38-60 Truck 59Y-5781-A, 3/4 & 1 tonea. 10.00
 42-56 PU 21C-5781-Aea. 7.00

Rear of Rear Spring Shackle Hanger



38-47 Truck 59Y-5776, 3/4 & 1 tonea. 35.00
 42-52 PU 21C-5776, F-1ea. 33.00
 53-56 PU TAAA-5776-A, F-100ea. 33.00
 53-56 Truck TBAA-5776-A, F-250 & F-350ea. 35.00

Rear Spring Hanger Frame Bracket

38-47 Truck 82Y-5775, 3/4 & 1 tonea. 35.00
 42-52 PU 21C-5775, F-1ea. 35.00
 53-56 PU TAAA-5775, F-100ea. 36.50

Front of Rear Spring Bracket

40-57 Truck 01Y-5785, 1 tonea. 35.00
 42-52 PU 21C-5775, F-1ea. 35.00
 53-56 PU TAAA-5785, F-100ea. 35.00

Rear Shackle Pin Lock Pin

38-56 PU 82Y-5782ea. 1.75



BUMPERS

Rear Axle Bumper



32	Pass	B-5783	ea.	8.00
33-34	Pass	40-5783	ea.	8.50
35-38	Pass	48-5783	ea.	8.00
35-38	Pass	48-5783-F, "Ford" script.....	pr.	35.00
39-40	Pass	91A-5783	ea.	8.00
39-40	Pass	91A-5783-F, "Ford" script.....	pr.	35.00
41-48	Pass	11A-3020	ea.	6.00
49-51	Pass	8A-5783-CR, except wagon	ea.	11.95
51	Pass	1A-5783, N.O.S.	ea.	20.00
52-56	Pass	8A-5783-CR, except wagon	ea.	11.95
39-40	Merc	91A-5783-F, "Ford" script.....	pr.	35.00
41-48	Merc	11A-3020	ea.	6.00
32	PU	B-5783	ea.	8.00
33-34	PU	40-5783	ea.	8.50
35-38	PU	48-5783	ea.	8.00
35-38	PU	48-5783-F, "Ford" script.....	pr.	35.00
39-40	PU	91A-5783	ea.	8.00
39-40	PU	91A-5783-F, "Ford" script.....	pr.	35.00
48-54	PU	11A-3020	ea.	6.00

COLUMBIA

Columbia Firewall & Clutch Valve

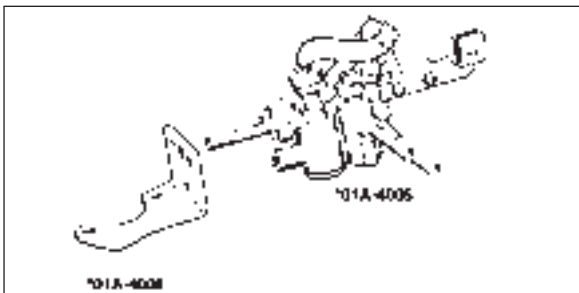

35-36	Pass	40-4002-PR.....	set.	500.00
37-41	Pass	01A-4005/6, w/bracket	ea.	400.00

Columbia Dash Control w/Rod

35-36	Pass	48-4005-PR.....	set.	90.00
-------	------	-----------------	------	-------

Columbia Carburetor Plate



35-41	Pass	01A-9589	kit.	50.00
39-41	Merc	01A-9589	kit.	50.00

Columbia Vacuum Line Bracket

35-36	Pass	48-4006-SET.....	set.	90.00
-------	------	------------------	------	-------

Columbia Vacuum Tube Clip



33-48	Pass	N-60087, 3 pcs.....	set.	13.00
39-48	Merc	N-60087, 3 pcs.....	set.	13.00
35-41	PU	N-60087, 3 pcs.....	set.	13.00

Columbia Axle Gasket Set

3 piece gasket set for columbia.

33-48	Pass	CO-4035-JD.....	set.	12.50
39-48	Merc	CO-4035-JD.....	set.	12.50
33-41	PU	CO-4035-JD.....	set.	12.50

Columbia Axle Housing Bearing & Race

35-48	Pass	48-363/8.....	set.	59.00
35-41	PU	48-363/8.....	set.	59.00

Columbia Bolt & Thrust Washer Kit



33-48	Pass	48-4059/60-S.....	kit.	33.00
33-41	PU	48-4059/60-S.....	kit.	33.00

Differential Case & Internal Gear Assembly

39 Teeth. Does not require banding.



37-48	Pass	CO-A24	ea.	500.00
39-48	Merc	CO-A24	ea.	500.00

REAR AXLE/COLUMBIA BOOKS

Columbia Axle Installation Instructions



DG-018

33-34	Pass	DG-017ea.	4.00
35-36	Pass	DG-018ea.	4.00
37	Pass	DG-019ea.	4.00
40	Pass	DG-020ea.	4.00
41-48	Pass	DG-021ea.	4.00
40	Merc	DG-020ea.	4.00
41-48	Merc	DG-021ea.	4.00

Columbia Axle Parts List

35-40	Pass	DG-022ea.	4.00
41-48	Pass	DG-023ea.	4.00
40	Merc	DG-022ea.	4.00
41-48	Merc	DG-023ea.	4.00

Columbia Axle Parts & Price List

35-36	Pass	CB-35ea.	5.00
-------	------	-------	----------	------

Columbia Pamphlet

42-48	Pass	LD-002, 4 pgsea.	4.00
42-48	Merc	LD-002, 4 pgsea.	4.00

Eaton 2 Speed Axle Book

All	Pass	EA-293/4, 36 Pgsset.	25.00
All	PU	EA-293/4, 36 Pgsset.	25.00

Columbia Control Knob



01A-4001-AB

38	Pass	81A-4001, ivoryea.	10.00
39	Pass	91A-4001, yellowea.	10.00
37	Std Pass	78-4001-A, light brownea.	10.00
37	Dlx Pass	78-4001-B, yellow brownea.	10.00
40	Std Pass	01A-4001-AB, sandea.	10.00
40	Dlx Pass	01A-4001-BB, maroonea.	10.00
40	Merc	09A-4001, dark blueea.	10.00

COVER

Differential Inspection Hole Cover Plate

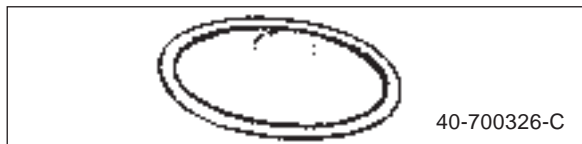

40-700326-C

33-34	Pass	40-700326-Cea.	35.00
-------	------	-------------	----------	-------

**Section 9
Exhaust**

HEADERS

Tube Headers

These do not require dip stick tube bending.



8A-9430-PR

32-34	Pass	B-9430-PR, V-8pr.	190.00
32-34	Pass	B-9430-A, V-8, w/48-52 PU boxpr.	215.00
32-34	Pass	B-9430-B, V-8, w/53-56 PU boxpr.	215.00
35-38	Pass	48-9430-PR, V-8pr.	215.00
39	Std Pass	48-9430-PR, V-8pr.	215.00
39	Dlx Pass	91A-9430-PR, V-8pr.	190.00
40	Pass	91A-9430-PR, V-8pr.	190.00
41-48	Pass	21A-9430-PR, V-8pr.	190.00
49-51	Pass	8A-9430-PR, V-8, except conv and wagonpr.	190.00
49-50	Conv	8A-9430-CNVpr.	215.00
51	Conv	1A-9430-CNVpr.	215.00
52-53	Pass	BA-9430-PR, V-8pr.	215.00
54	Pass	B4A-9430-AE, 1-3/4" tube type, V-8pr.	258.50
55-58	Pass	B4A-9430-A, 1 3/4" tube , V-8pr.	258.50
55-58	Pass	B4A-9430-B, 2" tube , V-8pr.	258.50
39-40	Merc	91A-9430-PR, V-8pr.	190.00
41-48	Merc	21A-9430-PR, V-8pr.	190.00
49-51	Merc	8M-9430-PR, V-8pr.	190.00
52-53	Merc	BA-9430-PR, V-8pr.	215.00
54-58	Merc	B4A-9430-A, 1 3/4" tube , V-8pr.	258.50
54-58	Merc	B4A-9430-B, 2" tube , V-8pr.	258.50
55-57	T-Bird	B5S-9430-PRpr.	595.00
32-34	PU	B-9430-PR, V-8pr.	190.00
35-39	PU	48-9430-PR, V-8pr.	215.00
40-41	PU	91A-9430-PR, V-8pr.	190.00
42-47	PU	21A-9430-PR, V-8pr.	190.00
48-52	PU	B-9430-PR, V-8pr.	190.00
48-52	PU	8C-9430-PR, 3 into 1, long tubepr.	275.00
53	PU	BA-9430-PR, V-8pr.	215.00
*54-64	PU	B4C-9430-PR, V-8, long tubepr.	245.00

Section 9 - Exhaust



C&G Early Ford Parts, Inc.

54-64 PU B4C-9430-STU,
V-8, stubbiepr. 245.00

Front Header Extension for Tube Headers

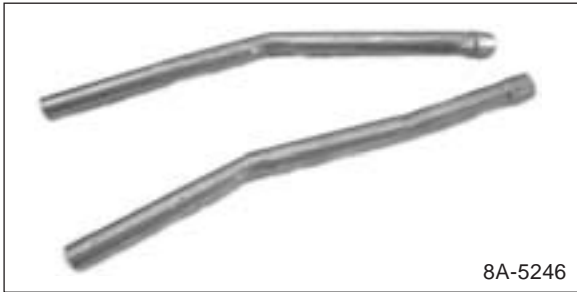

8A-5246

32-34	Pass	B-5246.....pr.	58.50
35-36	Pass	48-5246, w/o stock battery.....pr.	58.50
35-36	Pass	48-5246-WB, w/ stock battery.....pr.	58.50
37-40	Pass	78-5246pr.	58.50
41-48	Pass	11A-5246pr.	58.50
49-51	Pass	8A-5246pr.	58.50
51	Pass	1A-5246, Fordomaticpr.	58.50
52-53	Pass	BA-5246.....pr.	58.50
39-40	Merc	78-5246pr.	58.50
49-50	Merc	8M-5246.....pr.	58.50
52-53	Merc	BA-5246.....pr.	58.50
32-34	PU	B-5246.....pr.	58.50
35-36	PU	48-5246pr.	58.50
37-41	PU	78-5246pr.	58.50
48-52	PU	7C-5246.....pr.	58.50
53	PU	BAAA-5246pr.	58.50

Cast Iron Headers

Includes mounting gasket. Must bend dip stick tube to fit.



Fenton Headers

32-53 Pass & PU FENTON-HEADERS, V-8.....pr. 309.95

Front Header Extension for Fenton Headers

36-40	Pass	FENT-EXT-48pr.	100.00
41-48	Pass	FENT-EXT-11Apr.	100.00
49-51	Pass	FENT-EXT-8Apr.	100.00
52-53	Pass	FENT-EXT-BApr.	100.00
41-48	Merc	FENT-EXT-11Apr.	100.00
52-53	Merc	FENT-EXT-BApr.	100.00
36-40	PU	FENT-EXT-48pr.	100.00

Exhaust Gaskets

32-53	Pass	18-9433-EAea.	1.00
32-53	Pass	18-9433-SET, V-8, 8 pcs.....set.	5.00

41-51	Pass	1GA-9433, 6 cyl.set.	12.00
54-62	Pass	ECK-9433, 239,272,292,312 V8set.	13.50
32-53	PU	18-9433-EAea.	1.00
32-53	PU	18-9433-SET, V-8, 8 pcs.....set.	5.00
41-53	PU	1GA-9433, 6 cyl.set.	12.00
54-62	PU	ECK-9433, 239,272,292,312 V8set.	13.50

CROSSOVERS

Exhaust Crossover Pipe

Tech Tip: When installing crossover pipes, mount to exhaust manifold first. Some heating or bending may be required.			
32	Pass	18-5267, V-8ea.	45.00
33-34	Pass	40-5267, V-8ea.	35.00
35-36	Pass	48-5267ea.	35.00
37-41	Pass	78-5267, V-8ea.	35.00
42-48	Pass	51A-5267, V-8ea.	35.00
49-53	Pass	0BA-5267, V-8ea.	50.00
55-56	Pass	B5A-5267, V-8.....ea.	50.00
42-48	Merc	59A-5267ea.	28.00
32	PU	18-5267, V-8ea.	45.00
33-34	PU	40-5267, V-8ea.	35.00
35-36	PU	48-5267ea.	35.00
37-41	PU	78-5267, V-8ea.	35.00
42-53	PU	59C-5267, F1-F6, V-8.....ea.	35.00
54	PU	EBU-5267, V-8ea.	58.00
55-64	PU	B5A-5267, V-8.....ea.	50.00

FRONT PIPE

Front Exhaust Pipe

Fit V8, unless otherwise noted

33-34	Pass	40-5245ea.	65.00
35-36	Pass	48-5245ea.	65.00
37-41	Pass	78-5245ea.	65.00
42-48	Pass	21A-5246ea.	58.00
49-50	Pass	8BA-5246-A, exc. conv.ea.	53.00
49-50	Conv	8BA-5246-Bea.	55.00
49-50	Wagon	8BA-5246-Bea.	55.00
51	Pass	1BA-5246-A, exc. conv.ea.	55.00
51	Conv	1BA-5246-Bea.	50.00
51	Wagon	1BA-5246-Aea.	55.00
33-34	PU	40-5245ea.	65.00
35-36	PU	48-5245ea.	65.00
37-41	PU	78-5245ea.	65.00
42-52	PU	7RC-5246.....ea.	65.00
48-51	PU	7HC-5246-C, 6 cyl.ea.	53.00
53	PU	TAAA-5246-B, 6 cyl.ea.	40.00
54-56	PU	TAAE-5246-B.....ea.	60.00

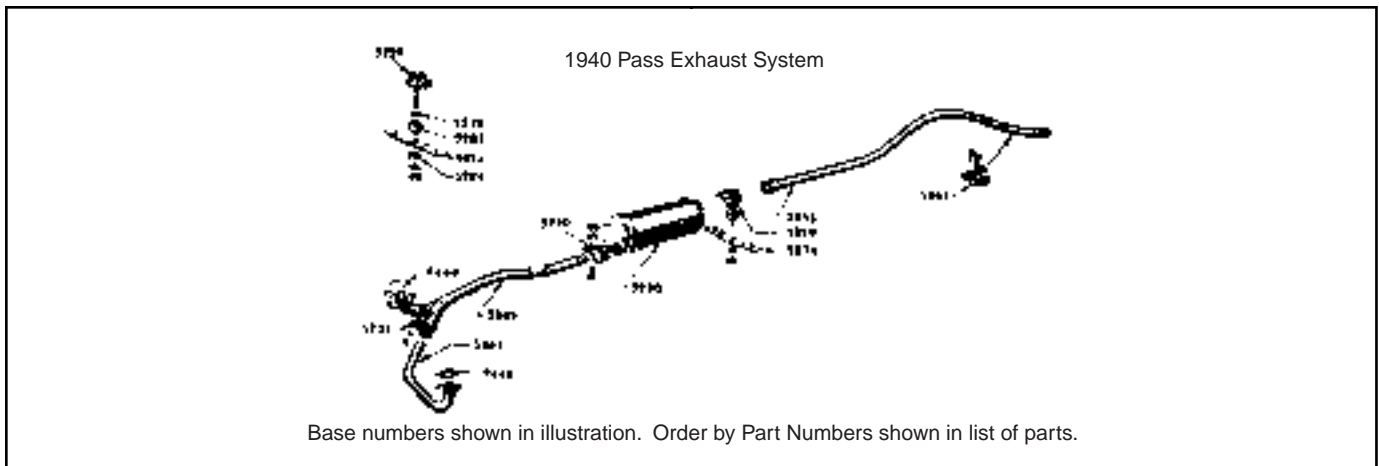

MUFFLER

Muffler

32-34	Pass	48-5230-C	ea.	60.00
35-38	Pass	48-5230-B	ea.	60.00
39-40	Pass	91A-5230	ea.	65.00
41	Pass	91A-5230, req's 6" ext.	ea.	65.00
42-48	Pass	2GA-5230	ea.	60.00
49-53	Pass	A9A-5230, V-8, "oval"	ea.	80.00
49-54	Pass	A9A-5230, 6 cyl., "oval"	ea.	80.00
54-56	Pass	B4A-5230, V-8	ea.	70.00
55-56	Pass	B4A-5230, 6 cyl.	ea.	70.00
39-41	Merc	91A-5230, req's 6" ext.	ea.	65.00
42-48	Merc	2GA-5230	ea.	60.00
49-53	Merc	A9A-5230, "oval"	ea.	80.00
32-34	PU	48-5230-C	ea.	60.00
35-38	PU	48-5230-B	ea.	60.00
39-41	PU	91A-5230	ea.	65.00
48-53	PU	7HC-5230, F1-F6	ea.	60.00
54-60	PU	TAAD-5230-C, F100-F600	ea.	50.00

TAIL PIPE

Tail Pipe

*32	Pass	B-5255, V-8, 2 pcs.	set.	70.00
*33-34	Pass	40-5255, 2 pcs.	set.	60.00
*35-38	Pass	48-5255	ea.	65.00
*39-40	Pass	91A-5255	ea.	65.00
*41	Pass	11A-5255A	ea.	50.00
*42-48	Pass	6A-5255	ea.	60.00
*49-53	Pass	1A-5255, exc. wgn & conv.	ea.	80.00
*39-40	Merc	11A-5255A	ea.	50.00
*42-48	Merc	6A-5255	ea.	60.00
*32	PU	B-5255, V-8, 2 pcs.	set.	70.00
*33-34	PU	40-5255, 2 pcs.	set.	60.00
*35-38	PU	48-5255	ea.	65.00
*39-41	PU	91A-5255	ea.	65.00
*48-52	PU	8C-5255, 1/2 ton, 6 cyl. & V-8.	ea.	65.00

54-60	PU	B5C-5255-A, 1/2 ton, 6 cyl. & V-8	ea.	15.00
-------	----	--------------------------------------	-----	-------

Left Tail Pipe for Dual Exhaust

*35-38	Pass & PU	48-5256-L	ea.	160.00
*39-40	Pass & PU	91A-5256-L	ea.	160.00

CLAMPS/HARDWARE

Exhaust Clamp & Bracket Set



35-38	Pass & PU	48-5200	set.	35.00
48-52	PU	7C-5200-S	ea.	40.00

Exhaust Crossover Pipe Clamp



32-48	Pass & PU	18-5251	ea.	5.50
39-48	Merc	18-5251	ea.	5.50

Exhaust Front Pipe to Muffler Clamp



35-48	Pass	48-5270	ea.	5.50
39-48	Merc	48-5270	ea.	5.50
35-48	PU	48-5270	ea.	5.50

Muffler to Front of Tail Pipe Clamp

39-41	Pass	91A-5259	ea.	10.00
42-48	Pass	11A-5259	ea.	10.00
52-56	Pass	BA-5251-AR	ea.	6.50
39-40	Merc	91A-5259	ea.	10.00

Section 10 - Frame



C&G Early Ford Parts, Inc.

42-48	Merc	11A-5259.....	ea.	10.00
39-41	PU	91A-5259.....	ea.	10.00

Front of Muffler Hanger

52-56	Pass	B5A-5259-E.....	ea.	18.95
-------	------	-----------------	-----	-------

Rear Muffler Hanger

49-51	Pass	8A-5259-C.....	ea.	28.00
52-56	Pass	B6A-5259-A.....	ea.	20.00

Rear Muffler Hanger Reinforcement Plate

49-59	Pass	BA-5287-R.....	ea.	4.25
-------	------	----------------	-----	------

Rear of Tail Pipe Hanger

39-48	Pass	99A-5261.....	ea.	10.00
-------	------	---------------	-----	-------



56	Frln	B6A-5261-A.....	ea.	14.00
39-48	Merc	99A-5261.....	ea.	10.00
39-48	PU	99A-5261.....	ea.	10.00

Exhaust Clamp Bushing Kit

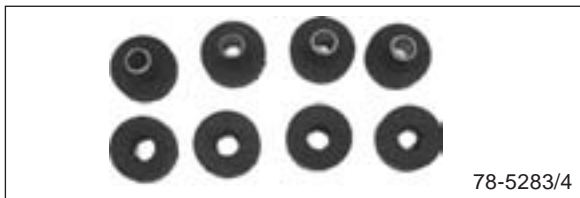

33-36	Pass & PU	40-5283/4-4.....	kit.	15.00
37-39	Pass & PU	78-5283/4.....	kit.	15.00

DEFLECTORS

Accessory Exhaust Deflector

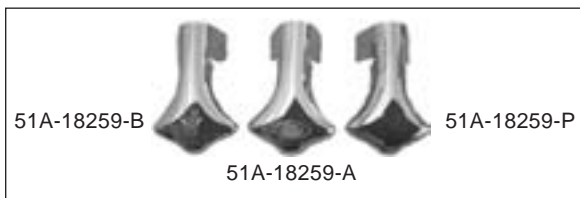

All	Pass & PU	51A-18259-A, Ford script.....	ea.	16.00
All	Pass & PU	51A-18259-B, V-8.....	ea.	16.00
All	Pass & PU	51A-18259-P, plain.....	ea.	15.00



49-55	Pass	8A-18259, fin type w/chrome top.....	ea.	49.95
-------	------	---	-----	-------

Exhaust Deflector for Rear Bumper



56	Frln	B6AZ-5202-PR, w/chrome trim.....	pr.	145.00
----	------	-------------------------------------	-----	--------

Section 10 Frame

BODY-FRAME PADS/WOOD

Body to Frame Pad Kits



35-36	Pass	48-5001.....	set.	70.00
37-40	Pass	78-5001, exc. Conv.....	set.	45.00
40	Conv	01A-5001.....	kit.	40.00
41	Pass	11A-5001, exc. Conv.....	set.	35.00
41	Conv	11A-5001-B.....	set.	35.00

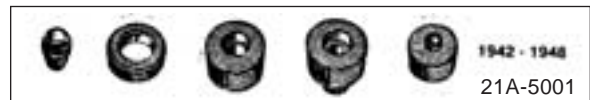

42-48	Pass	21A-5001.....	set.	40.00
49-50	Pass	8A-5001, exc. conv & wgn.....	kit.	60.00
51	Pass	1A-5001, exc. conv & wgn.....	kit.	60.00
52-54	Pass	BA-5001, exc. conv.....	kit.	125.00
55-56	Pass	B5A-5001, exc. conv.....	kit.	85.00
39-40	Merc	78-5001.....	set.	45.00
42-48	Merc	21A-5001.....	set.	40.00
49-51	Merc	8M-5001, except wagon, 13 female and 10 male pads.....	kit.	40.00



48-52	PU	7C-5400-S.....	kit.	25.00
-------	----	----------------	------	-------

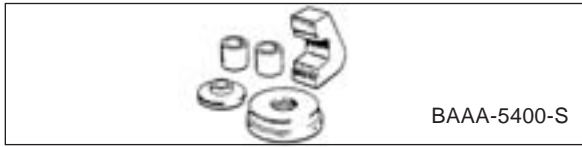

BAAA-5400-S

53-56 PU BAAA-5400-Skit. 15.00

Universal Body to Frame Pads

Perfect for a street rod or hot rod project, or for any make of car or truck. All pads are round 2" diameter with a 3/8" hole in the center. Pads have inter-locking grooves so they can be stacked. Sold in sets of 25 pieces. Also available in a 50 piece variety kit that includes 10 of each size.

All	BD-5001-A, 1/8" thickset.	25.00
All	BD-5001-B, 3/16" thickset.	25.00
All	BD-5001-C, 1/4" thickset.	25.00
All	BD-5001-D, 5/16" thickset.	30.00
All	BD-5001-E, 3/8" thickset.	30.00
All	BD-5001-K, 50 piece variety, 10 of each sizekit.	50.00

Cab to Frame Wood

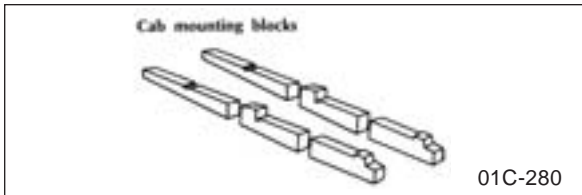

01C-280

32-34	PU	B-280set.	125.00
35-37	PU	50-280, 2 pcs.set.	200.00
38-39	PU	81C-280set.	230.00
40-41	PU	01C-280set.	125.00

Cab to Frame Arm



7C-5352

48-56 PU 7C-5352ea. 20.00

Back of Cab Hole Plug

53-56 PU 352285-S, 1 1/2", 2 requiredea. 2.00

"I really enjoy shopping with you guys. Great service and inventory, and a catalog that is second to none."
 Thanks.
 Jim B., Colorado

Body to Frame Bolt kit



78-5000-HK

35-36	Pass	48-5000-HKea.	67.50
37-40	Pass	78-5000-HK, except convkit.	26.00
37-40	Conv	R-512kit.	55.00
41-48	Pass	51A-5000-HKkit.	22.00

Cab to Frame Bolt kit

See hardware section for complete body bolt kits.

48-52	PU	7C-5404-KITkit.	20.00
53-56	PU	BAAA-5404-KITkit.	22.00
53-56	PU	6-0273, stainlesskit.	16.00

Running Board & Body to Frame Pad

41	Pass	A-PAD-11A-5001, 2 7/8" . x 3/8" thickea.	1.00
41	Pass	C-PAD-11A-5001, 1 7/8" . x 5/8" thickea.	1.00

Body to Frame Pad

54-56 Pass B4A-7000141-Aea. 2.75

Body to Frame Bolt Insulator

55-56 Pass B5A-7000154-Aea. 2.00

Body to Frame Bolt J-Nut

55-56 Pass 357000-S.....ea. 5.00

Body to Frame Bolt Washer

55-56 Pass 357001-S.....ea. 1.75

Cab Arm to Frame Pad

48-52	PU	7C-5360pr.	6.00
53-56	PU	BAAA-5360pr.	6.00

Cab Arm Bushing

48-56 PU 7C-5387, 4 pcs.set. 2.00

Front Upper Cab to Frame Pad

48-52	PU	7C-5370-Spr.	5.00
53-56	PU	BAAA-5370-Spr.	5.00

Front Lower Cab to Frame Pad

48-52	PU	7C-5371-Spr.	5.00
53-56	PU	BAAA-5371-Spr.	5.00



BODY WEBBING

Body to Frame Webbing

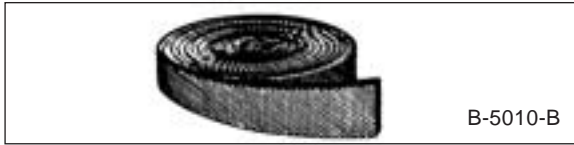

All	Pass & PU	B-5010-A, 1" x 1/16" x 25'.....ea.	40.00
All	Pass & PU	B-5010-B, 1 1/2" x 1/16" x 25'.....ea.	40.00
All	Pass & PU	B-5010-C, 2" x 1/16" x 25'.....ea.	45.00
All	Pass & PU	B-5000-A1, 1 1/2" x 1/16" x 20'.....ea.	16.00
All	Pass & PU	B-5000-B1, 1 1/2" x 1/8" x 20'.....ea.	19.00
All	Pass & PU	B-5000-B2, 2" x 1/8" x 20'.....ea.	21.00

Stick-on Body to Frame Webbing

All	Pass & PU	B-5000-AS, 1-1/2"x1/8"x20'.....ea.	28.00
All	Pass & PU	B-5000-BS, 2"x1/8"x20'.....ea.	30.00

Body Shimming Material



All	Pass & PU	B-5010-D, 1" wide x 1/4".....ea.	45.00
All	Pass & PU	B-5010-E, 2" wide x 1/4".....ea.	60.00

Body to Frame Rubber Liner

Rubber extrusion perfect for early Fords that want to use something different than webbing. Can be layered to help with shimming. Has a peel-n-stick adhesive backing.

All		BD-5010-A, 1/8" x 2" x 25'.....kit.	50.00
-----	--	-------------------------------------	-------

Felt Anti-Squeak

All	Pass & PU	B-5011-A, 1" x 3/16" x 6'.....ea.	8.00
-----	-----------	--------------------------------------	------

FRAME PARTS

Rear Frame Horn Covers

32	Pass	B-16399.....pr.	165.00
----	------	-----------------	--------

Fuel Tank to Frame Horn Cover Seal



32	Pass	B-16398.....kit.	10.00
----	------	------------------	-------

Frame Spreader Bar

Polished stainless steel with mounting hardware. 1933-34 Rear is plain steel without mounting hardware.

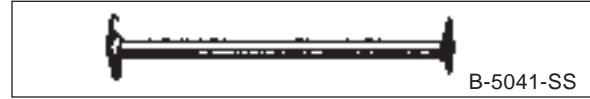

32	Pass	B-5041-SS, front, straight.....ea.	95.00
----	------	------------------------------------	-------



32	Pass	HR-1111, front, "V" shape.....ea.	140.00
33-34	Pass	HR-1115, front, "V" shape.....ea.	165.00
32	Pass	B-18575-SB, rear.....ea.	130.00
*33-34	Pass	40-5081-B, rear, cast ends.....ea.	125.00
32	PU	B-18575-SB, rear.....ea.	130.00

Front Frame Spreader Bar with LED Lights

Polished stainless steel with two 12 volt amber LED's. Perfect for turn signals. Wires exit out either side.

32	Pass	B-5041-LED.....ea.	74.50
----	------	--------------------	-------

Rear Frame Spreader Bar with LED lights

Polished stainless steel with four 12 volt LED's. Perfect for turn signals. Wires exit out either side.

32	Pass	B-18575-RLED, four red lenses.....ea.	132.50
32	Pass	B-18575-RALED, two red, and two amber lenses.....ea.	132.50

Floor Doublers/Seat Mounts

3/8" Cage Nuts Installed

38-39	Pass	81A-69, LH.....ea.	56.00
38-39	Pass	81A-70, RH.....ea.	56.00

Floor Stiffeners/Seat Mounts

3/8" Cage Nuts Installed

40	Pass	01A-92, LH, front.....ea.	50.00
40	Pass	01A-93, RH, front.....ea.	50.00
40	Pass	01A-94, LH, rear.....ea.	44.00
40	Pass	01A-95, RH, rear.....ea.	44.00

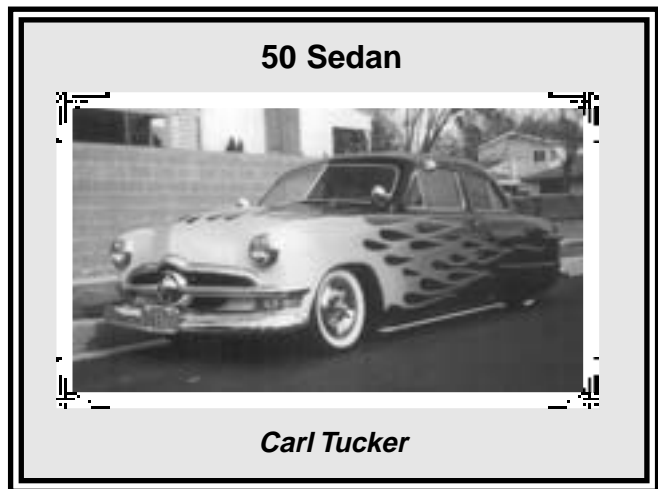

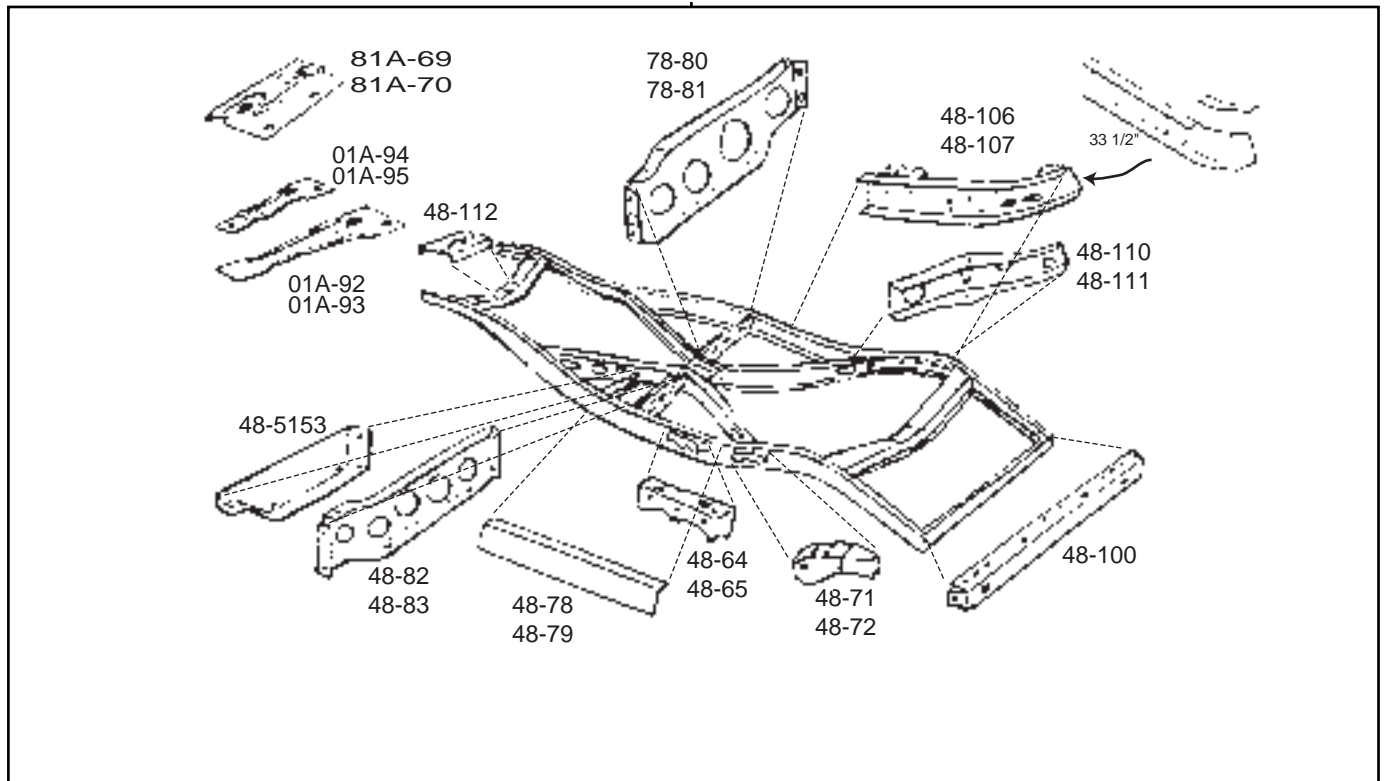

FRAME CROSSMEMBER REPAIR SECTIONS

Frame Outer Rail to X-Member

35-36	Pass	48-82, LHea.	113.00
35-36	Pass	48-83, RHea.	113.00
37-40	Pass	78-80, LHea.	114.00
37-40	Pass	78-81, RHea.	114.00
35-36	PU	48-82, LHea.	113.00
35-36	PU	48-83, RHea.	113.00
37-41	PU	78-80, LHea.	114.00
37-41	PU	78-81, RHea.	114.00

Rear X-Member to Outer Frame Repair Section

35-40	Pass	48-110, LHea.	120.00
35-40	Pass	48-111, RHea.	120.00
35-41	PU	48-110, LHea.	120.00
35-41	PU	48-111, RHea.	120.00

Rear Frame Crossmember

35-40	Pass	48-100ea.	72.00
35-41	PU	48-100ea.	72.00

OUTER FRAME REPAIR SECTIONS

Center Frame Repair Section - 36" Long

35-40	Pass	48-79, 11 gaugeea.	32.00
35-41	PU	48-79, 11 gaugeea.	32.00

Rear Frame Repair Section - 35-1/2" Long

35-40	Pass	48-106, LHea.	112.00
35-40	Pass	48-107, RHea.	112.00

35-41	PU	48-106, LHea.	112.00
35-41	PU	48-107, RHea.	112.00

Body Mounts - Outriggers

35-40	Pass	48-64, LH, frontea.	111.00
35-40	Pass	48-65, RH, frontea.	111.00
35-40	Pass	48-71, LH, rearea.	105.00
35-40	Pass	48-72, RH, rearea.	105.00

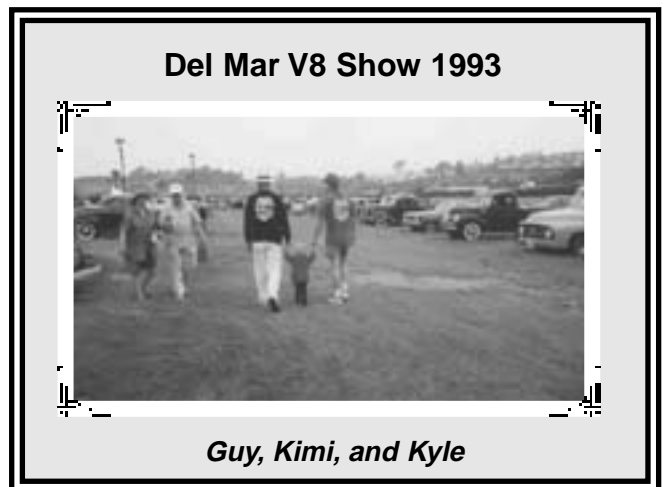

Del Mar V8 Show 1993

Guy, Kimi, and Kyle



Section 11 Engine

ENGINE PAINT

Engine Spray Paint

Cannot be shipped air or overseas.



All	Pass	D7AZ-19000-A, argent (silver)...	ea.	14.50
28-41	Pass	M-200, green	ea.	6.25
42-49	Pass	M-202, blue	ea.	5.75
49-51	Pass	8A-6000-S, bronze	ea.	23.00
52-53	Pass	BA-6000-S, orange	ea.	23.00
55-57	Pass	B5S-6000-S, red	ea.	23.00
39-41	Merc	M-200, green	ea.	6.25
42-48	Merc	M-202, blue	ea.	5.75
49-53	Merc	8M-6000-S, green.....	ea.	23.00
28-41	PU	M-200, green	ea.	6.25
42-47	PU	M-202, blue	ea.	5.75
48-52	PU	7C-6000-S, dark red	ea.	23.00

Engine Paint

Cannot be shipped air or overseas.

28-41	Pass	A-6000, green	qt.	25.00
42-49	Pass	21A-6000, blue.....	qt.	42.00
49-51	Pass	8A-6000, bronze	qt.	60.00
52-53	Pass	BA-6000, orange	qt.	42.00
54	Pass	BM-6000, cream	qt.	42.00
55-57	Pass	B5S-6000, red	qt.	50.00
39-41	Merc	A-6000, green	qt.	25.00
42-48	Merc	21A-6000, blue.....	qt.	42.00
49-53	Merc	8M-6000, green.....	qt.	60.00
55-57	T-Bird	B5S-6000, red	qt.	50.00
28-41	PU	A-6000, green	qt.	25.00
42-47	PU	21A-6000, blue.....	qt.	42.00
48-52	PU	7C-6000, dark red.....	ea.	49.50

MOUNTS/PARTS

Motor Mount Kits

2 required per vehicle.



78-6038-BDK

32-36	Pass	B-6038-BDK, V-8, mfg by Drake.....	ea.	25.00
32-36	Pass	B-6038-K, V-8	ea.	20.00
37-48	Pass	78-6038-BDK, V-8, mfg by Drake.....	ea.	25.00
37-48	Pass	78-6038-K, V-8	ea.	20.00
39-48	Merc	78-6038-BDK, mfg by Drake.....	ea.	25.00
39-48	Merc	78-6038-K.....	ea.	20.00
32-36	PU	B-6038-BDK, V-8, mfg by Drake.....	ea.	25.00
32-36	PU	B-6038-K, V-8	ea.	20.00
37-51	PU	78-6038-BDK, V-8, mfg by Drake.....	ea.	25.00
37-51	PU	78-6038-K, V-8.....	ea.	20.00

Motor Mount



8BA-6038

49-53	Pass	8BA-6038, V-8, 6 cyl.....	ea.	18.50
54-58	Pass	B7A-6038-A, 6 cyl.....	ea.	20.00



B7A-6038-B

54-56	Pass	B7A-6038-B, V-8.....	ea.	20.00
49	Merc	8M-6038-A, N.O.S. early, square block	ea.	75.00
52-53	Merc	8BA-6038	ea.	18.50
54-56	Merc	B7A-6038-B	ea.	20.00



B5S-6038-B

55-57	T-Bird	B5S-6038-B, front, rectangle.....	ea.	20.00
53-56	PU	B5S-6038-B, V-8, 6 cyl., front, rectangle.....	ea.	20.00

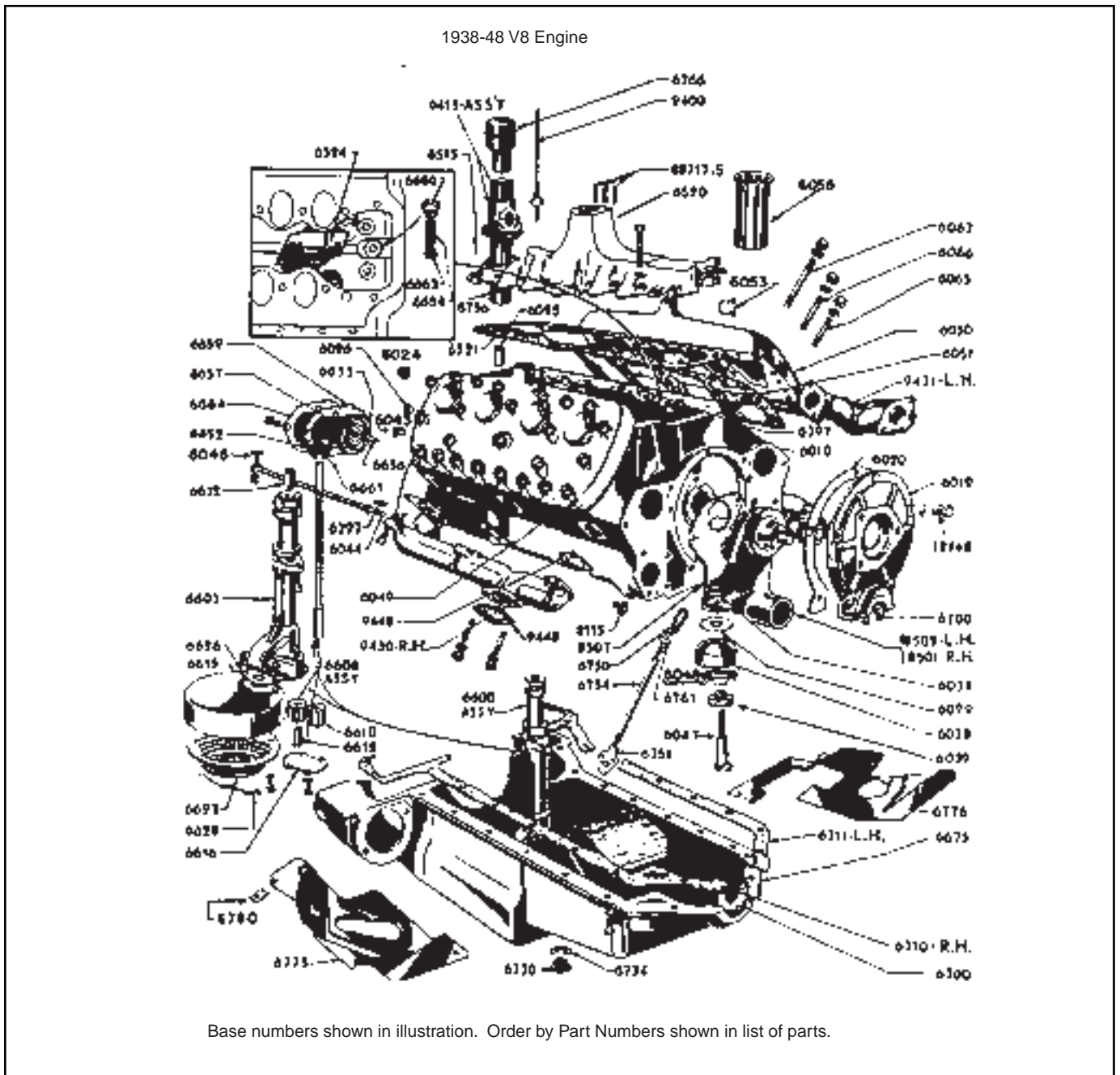

Engine Mount to Frame Adapter Spacers

For mounting a 49-53 Flathead engine into an early frame. Spacers are 1-3/4" tall. Must use 8RT-8501-L or -R water pumps and a rear sump oil pan.



48-6038-ADP

35-40	Pass	48-6038-ADPpr.	20.00
35-40	Merc	48-6038-ADPpr.	20.00

Engine Steady Rest Insulator



AD-6952-A

54-56	Pass	AD-6952-A, V-8, 6 cyl.....pr.	11.50
-------	------	-------------------------------	-------

Upper Motor Mount Insulator

32-48	Pass	B-6038-C, V-8.....ea.	5.00
39-48	Merc	B-6038-C.....ea.	5.00
49-51	Merc	8M-6038-B, late 49, round.....ea.	10.00
37-51	PU	B-6038-C, V-8.....ea.	5.00
41-47	PU	51T-6038, 6 cyl., G-engine.....ea.	5.00



52 PU 8L-6038-B, V-8, 6 cyl.ea. 10.00

Lower Motor Mount Insulator



TAAA-6039-A

32-48 Pass B-6039-A, V-8ea. 4.00
 39-48 Merc B-6039-Aea. 4.00



B9TT-6039-A

49-51 Merc B9TT-6039-Aea. 6.00
 55-57 T-Bird TAAA-6039-A, frontea. 4.00
 32-51 PU B-6039-A, V-8ea. 4.00
 41-47 PU 51T-6039, 6 cyl.,
 G-engineea. 3.00
 52 PU 8L-6039-B, V-8, 6 cyl.ea. 5.50
 53-56 PU TAAA-6039-A,
 V-8, 6 cyl., frontea. 4.00

Bell Housing Motor Mounts



TAAA-6068

53-60 PU TAAA-6068,
 V-8, 6 cyl., upperea. 13.00



COTT-6061-B

53-60 PU COTT-6061-B,
 V-8, 6 cyl., lowerea. 10.00

Upper Motor Mount Lower Washer

This is the special washer that the upper mount sits in.



78-6048

32-36 Pass B-6048, V-8ea. 2.50
 37-48 Pass 78-6048, V-8ea. 2.00
 39-48 Merc 78-6048ea. 2.00
 32-36 PU B-6048, V-8ea. 2.50
 37-51 PU 78-6048, V-8ea. 2.00

Upper Mount Upper Washer



78-6029-A

32-48 Pass 78-6029-A, V-8ea. 1.00
 39-48 Merc 78-6029-Aea. 1.00
 37-51 PU 78-6029-A, V-8ea. 1.00

Motor Mount Bolt

32-48 Pass B-6047, V-8ea. 4.00
 39-48 Merc B-6047ea. 4.00
 32-51 PU B-6047, V-8ea. 4.00

Motor Mount Bolt Nut

32-48 Pass 34031-S, V-8ea. 1.00
 39-48 Merc 34031-Sea. 1.00
 32-51 PU 34031-S, V-8ea. 1.00

GASKETS

4 Cylinder Complete Engine Gasket Sets

32-34 Pass B-6008-K, model Bset. 95.00
 32-34 PU B-6008-K, model Bset. 95.00

6 Cylinder Complete Engine Gasket Sets

*1941-47 "G" Engine has the distributor on the front of the engine.
 1947-51 "H" Engine has the distributor on the side of the engine.
 1952 Is the first year of the overhead valve engine.*

41-47 Pass 1GA-6008, G-seriesset. 225.00
 47-51 Pass 7HA-6008, H-seriesset. 150.00
 52-64 Pass B7AZ-6008, 215, 223set. 112.00
 41-47 PU 1GA-6008, G-seriesset. 225.00
 47-51 PU 7HA-6008, H-seriesset. 150.00
 52-64 PU B7AZ-6008, 215, 223set. 112.00

8 Cylinder Complete Engine Gasket Sets

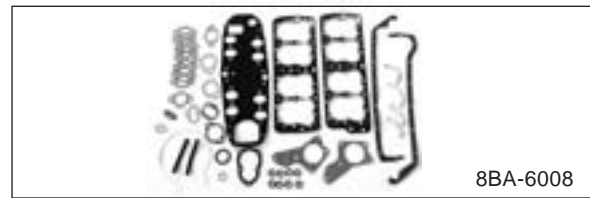

8BA-6008

32-37 Pass 18-6008, 21 stud, V-8set. 170.00
 38-42 Pass 81A-6008, 24 stud, V-8,
 3-1/16" boreset. 112.00
 39-48 Pass 99A-6008, 24 stud, V-8,
 3-3/16" boreset. 105.00
 49-53 Pass 8BA-6008, V-8set. 99.00
 54-55 Pass EBU-6008, 239set. 195.00
 55-64 Pass B7AZ-6008-F,
 272, 292, 312set. 145.00
 55-64 Pass B7AZ-6008-FEL,
 272, 292, 312, Fel-proset. 165.00
 39-42 Merc 81A-6008, 24 stud, V-8,
 3-1/16" boreset. 112.00
 39-48 Merc 99A-6008, 24 stud, V-8,
 3-3/16" boreset. 105.00
 49-53 Merc 8BA-6008, V-8set. 99.00

55-56	Merc	B7AZ-6008-F, V-8, 272, 292, 312set.	145.00
55-56	Merc	B7AZ-6008-FEL, 272, 292, 312, Fel-proset.	165.00
32-37	PU	18-6008, 21 stud, V-8.....set.	170.00
38-42	PU	81A-6008, 24 stud, V-8, 3-1/16" boreset.	112.00
39-47	PU	99A-6008, 24 stud, V-8, 3-3/16" boreset.	105.00
48-53	PU	8BA-6008, V-8set.	99.00
54-55	PU	EBU-6008, 239 V-8set.	195.00

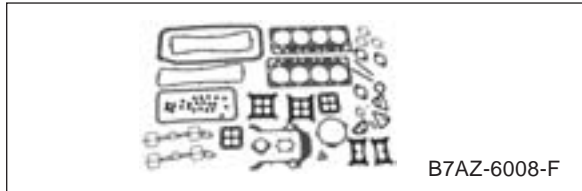

55-64	PU	B7AZ-6008-F, 272, 292, 312set.	145.00
55-64	PU	B7AZ-6008-FEL, 272, 292, 312, Fel-proset.	165.00

Head Gasket Sets

These kits include all gaskets to remove and replace cylinder heads.

52-64	Pass & PU	B9TZ-6079-ST, 215, 223, 6 cyl.set.	84.00
55-64	Pass & PU	B7AZ-6079-ST, 272, 292, 312set.	125.00

Cylinder Head Gasket

32-37	Pass	40-6051, steel, 21 stud, V-8.....ea.	34.00
32-37	Pass	40-6051-C, copper, 21 stud, V-8ea.	38.00
37-40	Pass	52-6051, 60 HP.....ea.	45.00
38-42	Pass	81A-6051, 24 stud, V-8, 3-1/16" boreea.	32.00
39-48	Pass	59A-6051, 24 stud, V-8, 3-3/16" boreea.	34.00
38-48	Pass	59A-6051-C, copper, 24 stud, V-8, 3-3/16" boreea.	41.00
38-48	Pass	59A-6051-BB, copper, big bore (up to 3 7/16" bore), 24 stud, V-8ea.	48.00
47-51	Pass	7HA-6051, 6 cyl.ea.	63.00
49-53	Pass	8BA-6051, V-8, RHea.	30.00
49-53	Pass	8BA-6083, V-8, LHea.	30.00
49-53	Pass	8BA-6051-C, V-8, RH, copper.....ea.	42.00
49-53	Pass	8BA-6083-C, V-8, LH, copperea.	42.00
49-53	Pass	8BA-6051-BB, big bore, V-8, RH, copper.....ea.	50.00
49-53	Pass	8BA-6083-BB, big bore, V-8, LH, copper.....ea.	50.00
52-64	Pass	C3AZ-6051-A, 215, 223ea.	46.50
55-64	Pass	B7AZ-6051-A, 272, 292, 312ea.	10.00
39-42	Merc	81A-6051, 24 stud, V-8, 3-1/16" boreea.	32.00
39-48	Merc	59A-6051, 24 stud, V-8, 3-3/16" boreea.	34.00

39-48	Merc	59A-6051-C, copper, 24 stud, V-8, 3-3/16" boreea.	41.00
39-48	Merc	59A-6051-BB, copper, big bore (up to 3 7/16" bore).....ea.	48.00
49-53	Merc	8BA-6051, V-8, RHea.	30.00
49-53	Merc	8BA-6083, V-8, LHea.	30.00
49-53	Merc	8BA-6051-C, V-8, RH, copper.....ea.	42.00
49-53	Merc	8BA-6083-C, V-8, LH, copper.....ea.	42.00
49-53	Merc	8BA-6051-BB, big bore, V-8, RH, copper.....ea.	50.00
49-53	Merc	8BA-6083-BB, big bore, V-8, LH, copper.....ea.	50.00
54-56	Merc	B7AZ-6051-A, 256.....ea.	10.00
32-37	PU	40-6051, steel, 21 stud, V-8.....ea.	34.00
32-37	PU	40-6051-C, copper, 21 stud, V-8ea.	38.00
37-40	PU	52-6051, 60 HP.....ea.	45.00
38-42	PU	81A-6051, 24 stud, V-8, 3-1/16" boreea.	32.00
39-47	PU	59A-6051, 24 stud, V-8, 3-3/16" boreea.	34.00
39-47	PU	59A-6051-C, copper, 24 stud, V-8, 3-3/16" boreea.	41.00
39-47	PU	59A-6051-BB, copper, big bore (up to 3 7/16" bore), 24 stud, V-8ea.	48.00
47-51	PU	7HA-6051, 6 cyl.ea.	63.00
48-53	PU	8BA-6051, V-8, RHea.	30.00
48-53	PU	8BA-6083, V-8, LHea.	30.00
48-53	PU	8BA-6051-C, V-8, RH, copper.....ea.	42.00
48-53	PU	8BA-6083-C, V-8, LH, copperea.	42.00
48-53	PU	8BA-6051-BB, big bore, V-8, RH, copper.....ea.	50.00
48-53	PU	8BA-6083-BB, big bore, V-8, LH, copper.....ea.	50.00
52-64	PU	C3AZ-6051-A, 215, 223ea.	46.50
55-64	PU	B7AZ-6051-A, 272, 292, 312ea.	10.00

Intake Manifold Gasket

Six cylinder intake gaskets include the exhaust manifold gaskets.

Eight cylinder intake gaskets include the intake gaskets only.

32-48	Pass	40-6521, V-8ea.	12.00
41-51	Pass	1GA-9433, 6 cyl.set.	12.00
49-53	Pass	8BA-6521, V-8.....ea.	12.00
52-62	Pass	EBP-9433, 6 cyl.....set.	21.50
54	Pass	EBU-9433, 239set.	10.00
55-62	Pass	B7AZ-9433, 272, 292, 312set.	7.50
39-48	Merc	40-6521ea.	12.00
49-53	Merc	8BA-6521ea.	12.00
54-56	Merc	B7AZ-9433set.	7.50
32-47	PU	40-6521, V-8ea.	12.00
41-51	PU	1GA-9433, 6 cyl.set.	12.00
48-53	PU	8BA-6521, V-8.....ea.	12.00
52-62	PU	EBP-9433, 6 cyl.....set.	21.50



54	PU	EBU-9433, 239	set.	10.00
55-62	PU	B7AZ-9433, 272, 292, 312	set.	7.50

Valley Cover Gasket

For the following engine sizes: 239, 272, 292, 312

54-64	Pass	COAE-6521-A, V8	set.	10.50
54-56	Merc	COAE-6521-A	set.	10.50
54-64	PU	COAE-6521-A, V8	set.	10.50

Valley & Valve Cover Grommet with Molded Washer



54-64	Pass	B9A-6570-A	ea.	1.75
54-56	Merc	B9A-6570-A	ea.	1.75
54-64	PU	B9A-6570-A	ea.	1.75

Valve Cover Gasket

41-47	Pass	1GA-6571, 6 cyl., G-series	set.	14.00
47-51	Pass	7HA-6521, 6 cyl., H-series	set.	6.50
52-59	Pass	B2AZ-6A506, 6 cyl.	set.	12.00
54-62	Pass	B4AZ-6A506-A, 239, 272, 292, 312	set.	20.00
54-56	Merc	B4AZ-6A506-A	set.	20.00
41-47	PU	1GA-6571, 6 cyl., G-series	set.	14.00
47-51	PU	7HA-6521, 6 cyl., H-series	set.	6.50
52-59	PU	B2AZ-6A506, 6 cyl.	set.	12.00
54-62	PU	B4AZ-6A506-A, 239, 272, 292, 312	set.	20.00

Push Rod Cover Set

Engine Side cover

52-64	Pass & PU	C1AE-6521-C, 215, 223	set.	18.00
-------	-----------	--------------------------------	------	-------

Timing Cover Gasket

32-53	Pass	18-6020, V-8	ea.	1.50
41-47	Pass	1GA-6020, 6 cyl.	ea.	22.00
39-53	Merc	18-6020	ea.	1.50
32-53	PU	18-6020, V-8	ea.	1.50

Timing Cover and Oil Pan Front Rope Seal

Fits 28-34 4 cyl., 41-51 6 cyl., & 32-53 V-8.

28-53	Pass	B-6700, 2 req'd	ea.	4.00
39-53	Merc	B-6700, 2 req'd	ea.	4.00
28-53	PU	B-6700, 2 req'd	ea.	4.00

Timing Cover and Oil Pan Seal

One piece rubber front seal. Fits 28-34 4 cyl., 41-51 6 cyl., & 32-53 V-8.



28-53	Pass	B-6700-R	ea.	19.00
39-53	Merc	B-6700-R	ea.	19.00
28-53	PU	B-6700-R	ea.	19.00

Timing Chain Cover Gasket Set

52-64	Pass	EBP-6020-SET, 6 cyl.	set.	15.00
54-62	Pass	B4AZ-6020-SET, 239, 272, 292, 312	set.	21.00
54-56	Merc	B4AZ-6020-SET	set.	21.00
54-64	PU	B4AZ-6020-SET, 239, 272, 292, 312	set.	21.00

Water Outlet Housing To Block Gasket

32-36	Pass & PU	40-8280, V-8	ea.	1.50
-------	-----------	--------------------	-----	------

Exhaust Manifold Gasket

For 6 cylinder engines see intake gaskets.

32-53	Pass	18-9433-EA, V-8	ea.	1.00
32-53	Pass	18-9433-SET, V-8, 8 pcs.	set.	5.00
54-62	Pass	ECK-9433, 239, 272, 292, 312	set.	13.50
39-53	Merc	18-9433-EA	ea.	1.00
39-53	Merc	18-9433-SET, 8 pcs.	set.	5.00
54-62	Merc	ECK-9433	set.	13.50
32-53	PU	18-9433-EA, V-8	ea.	1.00
32-53	PU	18-9433-SET, V-8, 8 pcs.	set.	5.00
54-62	PU	ECK-9433, 239, 272, 292, 312	set.	13.50

Oil Pan Gasket Set

32-34	Pass	B-6781, 4 cyl.	set.	14.00
32-34	Pass	18-6781, V-8	ea.	12.00
35-48	Pass	48-6781, V-8	set.	16.00
41-47	Pass	1GA-6781, 6 cyl.	set.	26.00
47-51	Pass	7HA-6781, 6 cyl.	set.	30.00
49-53	Pass	8BA-6781, V-8	set.	18.00
52-64	Pass	COAZ-6710-A, 6 cyl.	set.	14.00
54-64	Pass	COAZ-6710, 239, 272, 292, 312	set.	19.00
39-48	Merc	48-6781	set.	16.00
49-53	Merc	8BA-6781	set.	18.00
54-56	Merc	COAZ-6710	set.	19.00
32-34	PU	B-6781, 4 cyl.	set.	14.00
32-34	PU	18-6781, V-8	ea.	12.00
35-47	PU	48-6781, V-8	set.	16.00
47-51	PU	7HA-6781, 6 cyl.	set.	30.00
48-53	PU	8BA-6781, V-8	set.	18.00
52-64	PU	COAZ-6710-A, 6 cyl.	set.	14.00
54-64	PU	COAZ-6710, 239, 272, 292, 312	set.	19.00

Rear Main Seal Kit



39-53	Pass	91A-6347-BG, with 3-3/16" bore	set.	20.00
52-64	Pass	B2A-6701-ST, 215 & 223	kit.	27.00
55-64	Pass	B4MY-6701-ST, rope, 272, 292	kit.	11.00
55-64	Pass	B5A-6701-A, rubber, 272-292	kit.	22.00
56-57	Pass	B6A-6701-S, 312, neoprene	kit.	46.00
39-53	Merc	91A-6347-BG, with 3-3/16" bore	set.	20.00
54-56	Merc	B4MY-6701-ST, rope, except 312	kit.	11.00
39-53	PU	91A-6347-BG, with 3-3/16" bore	set.	20.00
52-64	PU	B2A-6701-ST, 215 & 223	kit.	27.00
55-64	PU	B4MY-6701-ST, rope, 272, 292	kit.	11.00
55-64	PU	B5A-6701-A, rubber, 272-292	kit.	22.00

Exhaust Manifold to Exhaust Pipe Gasket



48-66	Pass	1GA-9450, 6 cyl.	ea.	2.50
54-66	Pass	1GA-9450, V-8	ea.	2.50
54-56	Merc	1GA-9450	ea.	2.50
48-66	PU	1GA-9450, 6 cyl.	ea.	2.50
54-66	PU	1GA-9450, V-8	ea.	2.50

Engine Gasket Sealer, Adhesive or Cleaner

Shop Towels

Sold in a roll, like paper towels. Absorbs grease and oil.
ACC-2197, 11" x 10.4".....ROLL. 3.50

STUDS, NUTS, BOLTS, MISC.

Stainless Engine Bolt Kits

Head bolts or head studs are NOT included.



37-48	Pass	81A-6006, V-8	kit.	55.50
49-53	Pass	8BA-6006, V-8	kit.	60.00

54-64	Pass	B4A-6006, 239, 272, 292, 312	kit.	66.00
39-48	Merc	81A-6006	kit.	55.50
49-53	Merc	8BA-6006	kit.	60.00
54-64	Merc	B4A-6006, 239, 272, 292, 312	kit.	66.00
37-47	PU	81A-6006, V-8	kit.	55.50
48-53	PU	8BA-6006, V-8	kit.	60.00
54-64	PU	B4A-6006, 239, 272, 292, 312	kit.	66.00

Stainless Water Pump Bolt Kit

Includes enough for both sides, with lock washers.

37-48	Pass	78-8501-HK	set.	11.00
39-48	Merc	78-8501-HK	set.	11.00
37-47	PU	78-8501-HK	set.	11.00

ENGINE STUD CHART

	32-36, 21-Stud	37-38, 21-Stud	38-48, 24-Stud
40-6065	10	10	16
40-6066	10	8	4
40-6067	22	0	0
48-6067	0	24	28

Cylinder Head Studs

32-48	Pass & PU	40-6065, 2.34"	ea.	1.50
32-48	Pass & PU	40-6066, 2.90"	ea.	1.50
32-48	Pass & PU	40-6067, 3.59"	ea.	1.50
37-48	Pass & PU	48-6067, 3.09"	ea.	1.50
37-48	Pass & PU	91A-6067, 3.15"	ea.	1.75

Cylinder Head Bolts

47-51	Pass	8BA-6066, 6cyl "H", 33 req'd, 2.62"	ea.	2.00
49-53	Pass	8BA-6065, V-8, 20 req'd, 1.94"	ea.	1.75
49-53	Pass	8BA-6066, V-8, 28 req'd, 2.62"	ea.	2.00
49-53	Merc	8BA-6065, 20 req'd, 1.94"	ea.	1.75
49-53	Merc	8BA-6066, 28 req'd, 2.62"	ea.	2.00
47-51	PU	8BA-6066, 6cyl "H", 33 req'd, 2.62"	ea.	2.00
48-53	PU	8BA-6065, V-8, 20 req'd, 1.94"	ea.	1.75
48-53	PU	8BA-6066, V-8, 28 req'd, 2.62"	ea.	2.00

Cylinder Head Nuts

32-48	Pass	3123, V-8, 48 pcs.	set.	12.00
39-48	Merc	3123, 48 pcs.	set.	12.00
32-47	PU	3123, V-8, 48 pcs.	set.	12.00



Cylinder Head Nut Washers

Correct for cars with factory aluminum heads. Can also be used with aftermarket high compression aluminum heads.

32-53	Pass	3126, V-8, 48 pcs.	set.	20.00
39-53	Merc	3126, 48 pcs.	set.	20.00
32-53	PU	3126, V-8, 48 pcs.	set.	20.00

Cylinder Head Bolt/Stud Chrome Acorn Nut Covers



All	Pass	A-6040, acorn nut 5/8"	ea.	.75
32-53	Pass	3123-B, 48 pcs., V-8, 11/16"	set.	30.00
32-53	Pass	3123-B-EACH, V-8.	ea.	.75
39-53	Merc	3123-B, 48 pcs. 11/16"	set.	30.00
39-53	Merc	3123-B-EACH	ea.	.75
All	PU	A-6040, acorn nut 5/8"	ea.	.75
32-53	PU	3123-B, 48 pcs., V-8, 11/16"	set.	30.00
32-53	PU	3123-B-EACH, V-8.	ea.	.75

Intake Manifold Bolt Washers

32-48	Pass	34710, V-8.	set.	5.00
39-48	Merc	34710	set.	5.00
32-47	PU	34710, V-8.	set.	5.00

Intake Manifold Bolt Chrome Acorn Nut Covers



32-53	Pass	34711-C, set of 20	set.	12.00
39-53	Merc	34711-C, set of 20	set.	12.00
32-53	PU	34711-C, set of 20	set.	12.00

Oil Line Plug for Engine Block

37-48	Pass	18-6024	ea.	1.00
39-48	Merc	18-6024	ea.	1.00
37-47	PU	18-6024	ea.	1.00

CAMSHAFT

Camshaft

54-62	Pass	B8A-6250-C, 239, 272, 292, N.O.S.	ea.	70.00
54-64	PU	B8A-6250-C, 239, 272, 292, N.O.S.	ea.	70.00

Camshaft Bearing Set



32-53	Pass	01A-6260-S, std V-8	set.	38.00
-------	------	--------------------------	------	-------

32-53	Pass	01A-6260-O/S, V8, .010.	set.	60.00
41-47	Pass	1GA-6260-S, 6 cyl.	set.	75.00
39-53	Merc	01A-6260-S, std.	set.	38.00
39-53	Merc	01A-6260-O/S, V8, .010.	set.	60.00
32-53	PU	01A-6260-S, std V-8	set.	38.00
32-53	PU	01A-6260-O/S, V8, .010.	set.	60.00
41-47	PU	1GA-6260-S, 6 cyl.	set.	75.00

Camshaft Retainer



54-62	Pass & PU	EAA-6269-B, 239, 272, 292.	ea.	20.00
-------	-----------	---------------------------------	-----	-------

Camshaft Timing Gear



32-34	Pass	18-6256, V-8, fiber	ea.	32.00
33-40	Pass	48-6256A, V-8, fiber, press on	ea.	30.00
35-48	Pass	11A-6256, V-8, fiber, bolt on	ea.	32.00
35-48	Pass	91A-6256, V-8, alum., bolt on	ea.	55.00
41-47	Pass	1GA-6256, 6 cyl., G-engine, alum.	ea.	30.00
47-51	Pass	7HA-6256, 6 cyl., alum., bolt on	ea.	35.00
47-51	Pass	8HA-6256-A, 6 cyl., alum., press on	ea.	70.00
47-51	Pass	8HA-6256-D, 6 cyl., fiber, press on	ea.	55.00
49-53	Pass	8BA-6256, V-8, fiber	ea.	55.00



49-53	Pass	8BA-6256-A, V-8, alum.	ea.	55.00
54-64	Pass	EAA-6256, 6 cyl., V-8	ea.	32.00
39-40	Merc	48-6256A, fiber, press on	ea.	30.00
39-48	Merc	11A-6256, fiber, bolt on	ea.	32.00
39-48	Merc	91A-6256, alum., bolt on	ea.	55.00
49-53	Merc	8BA-6256, fiber.	ea.	55.00
49-53	Merc	8BA-6256-A, alum.	ea.	55.00
32-34	PU	18-6256, V-8, fiber	ea.	32.00
33-40	PU	48-6256A, V-8, fiber, press on	ea.	30.00
35-47	PU	11A-6256, V-8, fiber, bolt on	ea.	32.00
35-47	PU	91A-6256, V-8, alum., bolt on	ea.	55.00

41-47	PU	1GA-6256, 6 cyl., G-engine, alum.ea.	30.00
47-51	PU	7HA-6256, 6 cyl., alum., bolt on.....ea.	35.00
47-51	PU	8HA-6256-A, 6 cyl., alum., press on.....ea.	70.00
47-51	PU	8HA-6256-D, 6 cyl., fiber, press on.....ea.	55.00



8BA-6256-A

48-53	PU	8BA-6256, V-8, fiber.....ea.	55.00
48-53	PU	8BA-6256-A, V-8, alum.....ea.	55.00
54-64	PU	EAA-6256, 6 cyl., V-8.....ea.	32.00

Camshaft Timing Gear Bolts

35-53	Pass	350400-S.....set.	2.00
39-53	Merc	350400-S.....set.	2.00
35-53	PU	350400-S.....set.	2.00

Camshaft Timing Gear Lock Ring



91A-6258

39-53	Pass	91A-6258.....ea.	5.00
39-53	Merc	91A-6258.....ea.	5.00
39-53	PU	91A-6258.....ea.	5.00

Camshaft Timing Gear Chain

54-64	Pass	EAA-6268, 6 cyl., V-8.....ea.	25.00
54-56	Merc	EAA-6268.....ea.	25.00
54-64	PU	EAA-6268, 6 cyl., V-8.....ea.	25.00

Camshaft to Distributor Adapter



11A-6280

32-41	Pass	11A-6280, V-8.....ea.	14.00
39-41	Merc	11A-6280, V-8.....ea.	14.00
32-41	PU	11A-6280, V-8.....ea.	14.00

VALVE TRAIN

Intake/Exhaust Valves



11T-6505

32-48	Pass	11T-6505, V-8, use w/split guide.....ea.	12.50
32-50	Pass	8BA-6505, SS, V-8, use w/solid guide.....ea.	10.00
51-53	Pass	1BA-6505, V-8.....ea.	13.00
39-48	Merc	11T-6505, use w/split guide.....ea.	12.50
39-50	Merc	8BA-6505, SS use w/solid guide.....ea.	10.00
51-53	Merc	1BA-6505.....ea.	13.00
32-47	PU	11T-6505, V-8, use w/split guide.....ea.	12.50
32-50	PU	8BA-6505, SS, V-8, use w/solid guide.....ea.	10.00
51-53	PU	1BA-6505, V-8.....ea.	13.00

Intake Valves

41-47	Pass	1GA-6507, 6 cyl., "G".....ea.	5.00
54-64	Pass	COAE-6507-J, 6 cyl., 223.....ea.	15.00
55-56	Pass	COAE-6507-J, V-8, 272, 292, 312.....ea.	15.00
54-56	Merc	COAE-6507-J.....ea.	15.00
41-47	PU	1GA-6507, 6 cyl., "G".....ea.	5.00
54-64	PU	COAE-6507-J, 6 cyl., 223.....ea.	15.00
55-56	PU	COAE-6507-J, V-8, 272, 292, 312.....ea.	15.00

Exhaust Valves

41-47	Pass	1GT-6505, 6 cyl., "G".....ea.	20.50
47-51	Pass	7HA-6505, 6 cyl., "H".....ea.	9.00
52-64	Pass	B6A-6505, 6 cyl., 215, 223.....ea.	11.00
54-62	Pass	B6A-6505, V-8, 239, 272, 292, 312.....ea.	11.00
54-56	Merc	B6A-6505.....ea.	11.00
41-47	PU	1GT-6505, 6 cyl., "G".....ea.	20.50
47-51	PU	7HA-6505, 6 cyl., "H".....ea.	9.00
52-64	PU	B6A-6505, 6 cyl., 215, 223.....ea.	11.00
54-62	PU	B6A-6505, V-8, 239, 272, 292, 312.....ea.	11.00

Valve Guides



40-6510

32-48	Pass	40-6510, USA, split.....ea.	7.00
32-53	Pass	8BA-6510, solid.....ea.	4.75
41-47	Pass	1GA-6510, 6 cyl., "G".....ea.	8.00

Section 11 - Engine



C&G Early Ford Parts, Inc.

47-51	Pass	7HA-6510, 6 cyl., "H".....ea.	11.00
39-48	Merc	40-6510, USA, split.....ea.	7.00
39-53	Merc	8BA-6510, solid.....ea.	4.75
32-47	PU	40-6510, USA, split.....ea.	7.00
32-53	PU	8BA-6510, solid.....ea.	4.75
41-47	PU	1GA-6510, 6 cyl., "G".....ea.	8.00
47-51	PU	7HA-6510, 6 cyl., "H".....ea.	11.00

Valve Guide Retainer



32-53	Pass	40-6512, V-8.....ea.	.50
39-53	Merc	40-6512.....ea.	.50
32-53	PU	40-6512, V-8.....ea.	.50

Valve Guide Seals



32-53	Pass	8BA-6571, V-8, 8 pcs.set.	3.00
39-53	Merc	8BA-6571, 8 pcs.set.	3.00
32-53	PU	8BA-6571, V-8, 8 pcs.set.	3.00

Valve Stem Seals

55-61	Pass	B4AZ-6571-A, 6 cyl.....set.	18.00
55-64	Pass	B4AZ-6571-A, 272, 292, 312.....set.	18.00
54-56	Merc	B4AZ-6571-A.....set.	18.00
55-61	PU	B4AZ-6571-A, 6 cyl.....set.	18.00
55-64	PU	B4AZ-6571-A, 272, 292, 312.....set.	18.00

Flathead V-8 Valve Guide Tool



32-53	Pass	VGBAR-6510-TOOL.....ea.	30.00
39-53	Merc	VGBAR-6510-TOOL.....ea.	30.00
32-53	PU	VGBAR-6510-TOOL.....ea.	30.00

Valve Spring

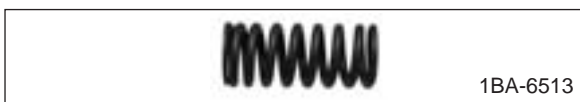

32-50	Pass	78-6513, V-8.....ea.	2.50
51-53	Pass	1BA-6513, V-8.....ea.	4.00
52-64	Pass	B6A-6513, 6 cyl., 215, 223.....ea.	.75
54-62	Pass	B6A-6513, 239, 272, 292, 312.....ea.	.75

39-50	Merc	78-6513.....ea.	2.50
51-53	Merc	1BA-6513.....ea.	4.00
54-56	Merc	B6A-6513.....ea.	.75
32-50	PU	78-6513, V-8.....ea.	2.50
51-53	PU	1BA-6513, V-8.....ea.	4.00
52-64	PU	B6A-6513, 6 cyl., 215, 223.....ea.	.75
54-62	PU	B6A-6513, 239, 272, 292, 312.....ea.	.75

Valve Spring Retainer



32-48	Pass	40-6514, V-8 use with split valve guides.....ea.	.75
-------	------	---	-----



32-50	Pass	8BA-6514, V-8 use with solid valve guides.....ea.	2.00
39-48	Merc	40-6514, use with split valve guides.....ea.	.75
39-50	Merc	8BA-6514, use with solid valve guides.....ea.	2.00
32-47	PU	40-6514, V-8 use with split valve guides.....ea.	.75
32-50	PU	8BA-6514, V-8 use with solid valve guides.....ea.	2.00

Valve Lock Key

Fits 32-53 V-8 using 8BA-6505 valves, 47-59 6 cyl., & 54-59 239, 272, 292, & 312.



32-64	Pass	7HA-6518.....pr.	.50
39-56	Merc	7HA-6518.....pr.	.50
32-64	PU	7HA-6518.....pr.	.50

"Parcel arrived yesterday & by my reckoning its taken 4 days!!! I don't get post from the other side of town that quick. Thanks again for your prompt service."
Trev, New Zealand

Non Adjustable Tappet (Lifter)



91A-6500

32-48	Pass	91A-6500, V-8	ea.	2.50
54-64	Pass	B8C-6500-A, 239, 272, 292	ea.	7.50
39-48	Merc	91A-6500, V-8	ea.	2.50
32-47	PU	91A-6500, V-8	ea.	2.50
54-64	PU	B8C-6500-A, 239, 272, 292	ea.	7.50

Adjustable Tappet (Lifter)



91A-6500-ADJ

32-53	Pass	91A-6500-ADJ, set of 16.....	set.	235.00
32-53	Pass	91A-6500-ADJ-USA, USA made	ea.	20.50
39-53	Merc	91A-6500-ADJ, set of 16.....	set.	235.00
39-53	Merc	91A-6500-ADJ-USA, USA made	ea.	20.50
32-53	PU	91A-6500-ADJ, set of 16.....	set.	235.00
32-53	PU	91A-6500-ADJ-USA, USA made	ea.	20.50

Adjustable Tappet Wrenches



91A-6500-WRN

32-53	Pass	91A-6500-WRN.....	pr.	11.00
39-53	Merc	91A-6500-WRN.....	pr.	11.00
32-53	PU	91A-6500-WRN.....	pr.	11.00

Rocker Arm

52-59	Pass & PU	B6A-6564-G, 6 cyl.	ea.	5.00
-------	-----------	-------------------------	-----	------

Rocker Arm Adjusting Screw

56-64	Pass & PU	B6A-6549-C	ea.	3.00
-------	-----------	------------------	-----	------

Rocker Arm Shaft

55-62	Pass & PU	B4AZ-6563-A, 272, 292, 312	ea.	17.50
-------	-----------	-------------------------------------	-----	-------

Valve Push Rod

52-64	Pass & PU	EAA-6565-C, 6 cyl.....	ea.	4.00
54-55	Pass & PU	EAN-6565-A, 239, 272, 292, 8-19/64"	ea.	5.00
56-64	Pass & PU	COAE-6565-D, V-8, 272, 292, 312, 8.188"	ea.	4.00

Chrome Valve Cover



COKE-6583-CH

54-62	Pass	COKE-6583-CH, 239, 272, 292, 312	pr.	55.00
54-56	Merc	COKE-6583-CH.....	pr.	55.00
54-64	PU	COKE-6583-CH, 239, 272, 292, 312	pr.	55.00

Stainless Valve Cover Acorn Nuts & Washers

Fits 239, 272, 292, 312 engine sizes.



COKE-6583-AC

54-64	Pass	COKE-6583-AC	set.	12.50
54-56	Merc	COKE-6583-AC	set.	12.50
54-64	PU	COKE-6583-AC	set.	12.50

PISTONS/RINGS

Pistons



8BA-6108-030

32-42	Pass	01T-6108-020, .020, 3-1/16", dome top	set.	200.00
32-42	Pass	01T-6108-030, .030, 3-1/16", dome top	set.	275.00
32-42	Pass	01T-6108-040, .040, 3-1/16", dome top	set.	210.00
32-42	Pass	01T-6108-060, .060, 3-1/16", dome top	set.	300.00
39-53	Pass	8BA-6108-STD, STD, 3-3/16" ...	set.	200.00
39-53	Pass	8BA-6108-030, .030, 3-3/16"	set.	295.00
39-53	Pass	8BA-6108-040, .040, 3-3/16"	set.	295.00
39-53	Pass	8BA-6108-060, .060, 3-3/16"	set.	295.00
55-62	Pass	B5A-6108-STD, Standard, 292...set.		100.00
55-62	Pass	B5A-6108-030, .030, 292	set.	100.00
55-62	Pass	B5A-6108-020, .020, 292	set.	100.00
55-62	Pass	B5A-6108-040, .040, 292	set.	100.00
55-62	Pass	B5A-6108-060, .060, 292	set.	100.00
39-48	Merc	8BA-6108-STD, STD, 3-3/16" ...set.		200.00
39-48	Merc	8BA-6108-030, .030, 3-3/16"	set.	295.00
39-48	Merc	8BA-6108-040, .040, 3-3/16"	set.	295.00
39-48	Merc	8BA-6108-060, .060, 3-3/16"	set.	295.00
32-42	PU	01T-6108-020, .020, 3-1/16", dome top	set.	200.00



32-42	PU	01T-6108-030, .030, 3-1/16", dome top.....set.	275.00
32-42	PU	01T-6108-040, .040, 3-1/16", dome top.....set.	210.00
32-42	PU	01T-6108-060, .060, 3-1/16", dome top.....set.	300.00
39-53	PU	8BA-6108-STD, STD, 3-3/16" ...set.	200.00
39-53	PU	8BA-6108-030, .030, 3-3/16".....set.	295.00
39-53	PU	8BA-6108-040, .040, 3-3/16".....set.	295.00
39-53	PU	8BA-6108-060, .060, 3-3/16".....set.	295.00
55-64	PU	B5A-6108-STD, std, 292.....set.	100.00
55-64	PU	B5A-6108-020, .020, 292.....set.	100.00
55-64	PU	B5A-6108-030, .030, 292.....set.	100.00
55-64	PU	B5A-6108-040, .040, 292.....set.	100.00
55-64	PU	B5A-6108-060, .060, 292.....set.	100.00

Piston Rings

32-42	Pass & PU	01T-6149-STD, , std, for 3-1/16" piston.....set.	90.00
32-42	Pass & PU	01T-6149-020, , 020, for 3-1/16" piston.....set.	90.00
32-42	Pass & PU	01T-6149-030, , .030, for 3-1/16" piston.....set.	90.00
32-42	Pass & PU	01T-6149-040, , .040, for 3-1/16"piston.....set.	90.00
32-42	Pass & PU	01T-6149-060, , .060, for 3-1/16" piston.....set.	90.00
39-53	Pass & PU	29A-6149-STD, , std, for 3-3/16" piston.....set.	90.00
39-53	Pass & PU	29A-6149-020, , .020, for 3-3/16" piston.....set.	90.00
39-53	Pass & PU	29A-6149-030, , .030, for 3-3/16" piston.....set.	90.00
39-53	Pass & PU	29A-6149-040, , .040, for 3-3/16" piston.....set.	90.00
39-53	Pass & PU	29A-6149-060, , .060, for 3-3/16" piston.....set.	90.00
54-55	Pass & PU	EBU-6149-STD, STD, 239.....set.	66.95
54-55	Pass & PU	EBU-6149-S020, .020, 239.....set.	66.95
54-55	Pass & PU	EBU-6149-S030, .030, 239.....set.	66.95
54-55	Pass & PU	B4A-6149-F, .040, 239.....set.	75.00
54-55	Pass & PU	EBU-6149-S060, .060, 239.....set.	66.95
55-62	Pass & PU	B5AZ-6148-STD, std, 292.....set.	40.00
55-62	Pass & PU	B5AZ-6148-020, .020, 292.....set.	40.00
55-62	Pass & PU	B5AZ-6148-030, .030, 292.....set.	40.00
55-62	Pass & PU	B5AZ-6148-040, .040, 292.....set.	40.00
55-62	Pass & PU	B5AZ-6148-060, .060, 292.....set.	40.00

Engine Block Sleeve

For sleeving an oversized or damaged block back to standard bore size.

39-48	Pass	99A-6055, V8 with 3-3/16" bore.....ea.	25.00
39-48	Merc	99A-6055, V8 with 3-3/16" bore.....ea.	25.00
39-47	PU	99A-6055, V8 with 3-3/16" bore.....ea.	25.00

CONNECTING ROD

Connecting Rod Bushing

42-53	Pass	21A-6207-A, std, V-8.....ea.	2.25
54-62	Pass	EAA-6207-A, 239, 272, 292, 312.....ea.	1.50
42-53	Merc	21A-6207-A, std.....ea.	2.25
42-53	PU	21A-6207-A, std, V-8.....ea.	2.25
54-64	PU	EAA-6207-A, 239, 272, 292, 312.....ea.	1.50

Connecting Rod Bearings

Please call for years or sizes not listed.



32-38	Pass & PU	48-6211-STD, 85 HP, std, w/lip.....set.	135.00
32-38	Pass & PU	48-6211-010, 85 HP, .010, w/lip.....set.	245.00
32-38	Pass & PU	48-6211-030, 85 HP, .030, w/lip.....set.	260.00
32-38	Pass & PU	48-6211-040, 85 HP, .040, w/lip.....set.	325.00
38-42	Pass & PU	81A-6211-STD, 85 HP, no lip, std.....set.	110.00
38-42	Pass & PU	81A-6211-010, 85 HP, no lip, .010.....set.	110.00
38-42	Pass & PU	81A-6211-020, 85 HP, no lip, .020.....set.	140.00
38-42	Pass & PU	81A-6211-030, 85 HP, no lip, .030.....set.	170.00
39-48	Pass & PU	99A-6211-010, 95 & 100 HP, .010.....set.	200.00
39-48	Pass & PU	99A-6211-020, 95 & 100 HP, .020.....set.	290.00
39-48	Pass & PU	99A-6211-030, 95 & 100 HP, .030.....set.	200.00
39-48	Pass & PU	99A-6211-040, 95 & 100 HP, .040.....Set.	345.00
49-53	Pass & PU	0BA-6211-STD, std.....set.	120.00
49-53	Pass & PU	0BA-6211-010, .010.....set.	120.00
49-53	Pass & PU	0BA-6211-020, .020.....set.	120.00
49-53	Pass & PU	0BA-6211-030, .030.....set.	120.00
49-53	Pass & PU	0BA-6211-040, .040.....ea.	120.00
55-62	Pass & PU	B5T-6211-STDB, 272, 292, 312, STD.....set.	40.00
55-62	Pass & PU	B5T-6211-010, 272, 292, 312, .010.....set.	40.00
55-62	Pass & PU	B5T-6211-020, 272, 292, 312, .020.....set.	40.00
55-62	Pass & PU	B5T-6211-030, 272, 292, 312, .030.....set.	40.00
55-62	Pass & PU	B4AE-6211-040, 272, 292, 312, .040.....set.	40.00

Connecting Rod Nut

32-48	Pass	1GA-6212, V-8.....	ea.	.75
39-48	Merc	1GA-6212	ea.	.75
32-47	PU	1GA-6212, V-8.....	ea.	.75

CRANK RELATED

Crankshaft (Main) Bearings

Please call for years or sizes not listed.



36-38	Pass	68-6330-STD, 85 HP, std, 21 stud, 2.4"	set.	120.00
36-38	Pass	68-6330-010, 85 HP, .010, 21 stud, 2.4"	set.	120.00
36-38	Pass	68-6330-020, 85 HP, .020, 21 stud, 2.4"	set.	120.00
36-38	Pass	68-6330-030, 85 HP, .030, 21 stud, 2.4"	set.	120.00
38-48	Pass	81A-6330-030, 85 & 95 HP, .030	set.	130.00
39-48	Pass	81A-6330-010, 85, 95, & 100 HP, .010	set.	95.00
39-48	Pass	81A-6330-020, 85, 95, & 100 HP, .020,	set.	130.00
39-48	Pass	81A-6330-STD, 85, 95 & 100 HP, std,	set.	125.00
41-47	Pass	1GA-6330, 6 cyl, .020	set.	130.00
47-51	Pass	7HA-6330-020, 6 cyl, .020	set.	125.00
49-53	Pass	1BA-6330-STD, std, 239, 255	set.	110.00
49-53	Pass	1BA-6330-010, .010, 239, 255	set.	100.00
49-53	Pass	1BA-6330-020, .020, 239, 255	set.	110.00
49-53	Pass	1BA-6330-030, .030 239, 255	set.	110.00
54-56	Pass	EBU-6330-STD, std, 239, 272, 292	set.	85.00
54-56	Pass	EBU-6330-S010, .010, 239, 272, 292	set.	125.00
54-56	Pass	EBV-6330-020, .020, 239, 272, 292	set.	75.00
54-56	Pass	EBV-6330-030, .030, 239, 272, 292	set.	75.00
54-56	Pass	B4AE-6330-040, .040, 239, 272, 292	set.	75.00
36-38	PU	68-6330-010, 85 HP, .010, 21 stud	set.	120.00
36-38	PU	68-6330-020, 85 HP, .020, 21 stud	set.	120.00
36-38	PU	68-6330-030, 85 HP, .030, 21 stud	set.	120.00
36-38	PU	68-6330-STD, 85 HP, std, 21 stud	set.	120.00

38-48	PU	81A-6330-030, 85 & 95 HP, .030	set.	130.00
39-48	PU	81A-6330-010, 85, 95, & 100 HP, .010,	set.	95.00
39-48	PU	81A-6330-020, 85, 95, & 100 HP, .020,	set.	130.00
39-48	PU	81A-6330-STD, 85, 95 & 100 HP, std	set.	125.00
41-47	PU	1GA-6330, 6 cyl, .020	set.	130.00
47-51	PU	7HA-6330-020, 6 cyl, .020	set.	125.00
48-53	PU	1BA-6330-STD, std, 239, 255	set.	110.00
48-53	PU	1BA-6330-010, .010, 239, 255	set.	100.00
49-53	PU	1BA-6330-020, .020, 239, 255	set.	110.00
48-53	PU	1BA-6330-030, .030 239, 255	set.	110.00
54-56	PU	EBU-6330-STD, std, 239, 272, 292	set.	85.00
54-56	PU	EBU-6330-S010, .010, 239, 272, 292	set.	125.00
54-56	PU	EBV-6330-020, .020, 239, 272, 292	set.	75.00
54-56	PU	EBV-6330-030, .030, 239, 272, 292	set.	75.00
54-56	PU	B4AE-6330-040, .040, 239, 272, 292	set.	75.00

Crankshaft Timing Gear



35-48	Pass	48-6306	ea.	25.00
49-53	Pass	8BA-6306, V-8	ea.	35.00
52-59	Pass	B8A-6306-B, 6 cyl.	ea.	10.00
54-59	Pass	B8A-6306-B, 239, 272, 292, 312	ea.	10.00
39-48	Merc	48-6306	ea.	25.00
49-53	Merc	8BA-6306	ea.	35.00
54-56	Merc	B8A-6306-B	ea.	10.00
35-47	PU	48-6306	ea.	25.00
48-53	PU	8BA-6306, V-8	ea.	35.00
52-59	PU	B8A-6306-B, 6 cyl.	ea.	10.00
54-59	PU	B8A-6306-B, 239, 272, 292, 312	ea.	10.00

Crankshaft Timing Gear Key

38-53	Pass	74153-S	ea.	3.00
39-53	Merc	74153-S	ea.	3.00
38-53	PU	74153-S	ea.	3.00



Crankshaft Gear Oil Slinger



38-53	Pass	81A-6310, V-8	ea.	2.00
39-53	Merc	81A-6310	ea.	2.00
38-53	PU	81A-6310, V-8	ea.	2.00

Crankshaft Pulley



32-38	Pass	18-6312, 85 HP, used.....	ea.	90.00
39	Dlx Pass	91A-6312, 85 HP used	ea.	125.00
40-41	Pass	91A-6312, 85 HP used	ea.	125.00
42-48	Pass	21A-6312, V-8, used	ea.	150.00
49	Pass	8BA-6312-B, w/wide belt.....	ea.	105.00
50-53	Pass	8BA-6312-C, w/thin belt	ea.	70.00
39-41	Merc	91A-6312, used.....	ea.	125.00
42-48	Merc	21A-6312, used.....	ea.	150.00
49	Merc	8BA-6312-B, w/wide belt.....	ea.	105.00
50-53	Merc	8BA-6312-C, w/thin belt	ea.	70.00
32-38	PU	18-6312, 85 HP, used.....	ea.	90.00
40-41	PU	91A-6312, 85 HP used	ea.	125.00
42-47	PU	21A-6312, V-8, used	ea.	150.00
48-53	PU	8BA-6312-B, w/wide belt.....	ea.	105.00
53	PU	8BA-6312-C, w/thin belt	ea.	70.00

Crankshaft Pulley Ratchet Nut



28-36	Pass	B-6319, 4 cyl., V-8.....	ea.	6.00
37-38	Pass	B-6319, V-8.....	ea.	6.00



38-53	Pass	81A-6319, V-8	ea.	6.00
39-53	Merc	81A-6319	ea.	6.00
28-36	PU	B-6319, 4 cyl., V-8.....	ea.	6.00
37-38	PU	B-6319, V-8.....	ea.	6.00
38-53	PU	81A-6319, V-8	ea.	6.00

Crankshaft Pulley Spacer

49-53	Pass	8BA-6362, V-8	ea.	5.00
49-53	Merc	8BA-6362	ea.	5.00
48-53	PU	8BA-6362, V-8	ea.	5.00

Rear Main Cap Oil Return Pipe

38-42	Pass	81A-6326, V-8	ea.	5.00
39-42	Merc	81A-6326	ea.	5.00
38-42	PU	81A-6326, V-8	ea.	5.00

Pot Metal Upper Rear Crank Seal



37-42	Pass & PU	78-6335, V-8	ea.	16.50
39-48	Pass & PU	91A-6335, V-8	ea.	29.00

Pot Metal Lower Rear Crank Seal



37-42	Pass	78-6336, V-8	ea.	16.50
39-48	Pass	19B-6336, V-8.....	ea.	35.00
37-42	PU	78-6336, V-8	ea.	16.50
39-47	PU	19B-6336, V-8.....	ea.	35.00

Crankshaft Rear Oil Seal Retainer



47-51	Pass	7HA-6335-A, 6 cyl., alum.	ea.	25.00
54-62	Pass	B5A-6335-A, 239, 272, 292, includes seal.....	kit.	125.00
56-57	Pass	B6A-6335-A, 312	ea.	125.00
56-57	T-Bird	B6A-6335-A, 312	ea.	125.00
47-51	PU	7HA-6335-A, 6 cyl., alum.	ea.	25.00
54-64	PU	B5A-6335-A, 239, 272, 292, includes seal.....	kit.	125.00

Rear Main Rope Seal

32-53	Pass	91A-6347, V-8.....	pr.	8.25
39-53	Merc	91A-6347	pr.	8.25
32-53	PU	91A-6347, V-8.....	pr.	8.25

Flywheel Ring Gear

28-48	Pass	B-6384, V-8.....	ea.	30.00
37-40	Pass	52-6384, 60 HP.....	ea.	20.00
49-51	Pass	8HA-6384, 6 cyl., 114 teeth	ea.	75.00
49-53	Pass	8BA-6384, V-8, 112 teeth	ea.	30.00
52-64	Pass	EAA-6384, 6 cyl. & V-8, 146 teeth	ea.	29.50

39-48	Merc	B-6384	ea.	30.00
49-53	Merc	8BA-6384	ea.	30.00
54-56	Merc	EAA-6384	ea.	29.50
28-48	PU	B-6384, V-8	ea.	30.00
37-40	PU	52-6384, 60 HP	ea.	20.00
47-51	PU	8HA-6384, 6 cyl., 114 teeth	ea.	75.00
48-53	PU	8BA-6384, V-8, 112 teeth	ea.	30.00
52-57	Truck	EAM-6384-A, 279, 317, 152 teeth	ea.	30.00
52-64	PU	EAA-6384, 6 cyl. & V-8, 146 teeth	ea.	29.50

Flywheel to Crankshaft Dowel 21/32"

32-48	Pass	B-6387, V-8	ea.	3.00
39-48	Merc	B-6387	ea.	3.00
32-48	PU	B-6387, V-8	ea.	3.00

Flywheel Crankshaft Bolts

32-48	Pass	1196, V-8	set.	4.00
39-48	Merc	1196	set.	4.00
32-47	PU	1196, V-8	set.	4.00

Transmission to Engine Dowel

32-48	Pass	18-6397, V-8	ea.	1.75
39-48	Merc	18-6397	ea.	1.75
32-47	PU	18-6397, V-8	ea.	1.75

Crankshaft Rear Dust Seal

49-53	Pass	8BA-6411, V-8	ea.	12.50
49-53	Merc	8BA-6411	ea.	12.50
53	PU	8BA-6411, V-8	ea.	12.50

OIL PUMP

New Oil Pump

If using 8BA-6621 in a 32-48 Pass, or 39-48 Merc, you must use 8RT-6615 pickup tube.



32-53	Pass	8BA-6621, V-8, short body, 80 lb	ea.	175.00
55-64	Pass	COAE-6600-D, 272, 292, 312	ea.	129.95
39-53	Merc	8BA-6621, short body, 80 lb	ea.	175.00
55-56	Merc	COAE-6600-D	ea.	129.95
32-53	PU	8BA-6621, V-8, short body, 80 lb	ea.	175.00
55-64	PU	COAE-6600-D, 272, 292, 312	ea.	129.95

Oil Pump Rebuilding Kit

32-40	Pass	18-6600-RK, V-8, 50 lb.	ea.	75.00
-------	------	------------------------------	-----	-------

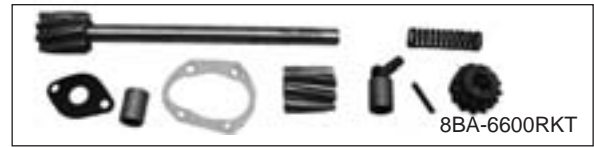

32-53	Pass	8BA-6600RKT, V-8, 80 lb.	kit.	115.00
56-62	Pass	COAE-6600RKT, 272, 292, 312	kit.	45.00
39-40	Merc	18-6600-RK, 50 lb.	ea.	75.00
39-53	Merc	8BA-6600RKT, 80 lb.	kit.	115.00
32-40	PU	18-6600-RK, V-8, 50 lb.	ea.	75.00
32-53	PU	8BA-6600RKT, V-8, 80 lb.	kit.	115.00



56-62	PU	COAE-6600RKT, 272, 292, 312	kit.	45.00
-------	----	--------------------------------------	------	-------

Oil Pump Shaft & Gear



41-47	Pass & PU	5GA-6608, early 47, 6 cyl.	ea.	41.00
-------	-----------	---------------------------------	-----	-------

Oil Pump Pickup Tube

For use with 8BA-6621 oil pump. For rear sump oil pan.



32-53	Pass	8RT-6615, V-8	ea.	22.50
39-53	Merc	8RT-6615	ea.	22.50
32-53	PU	8RT-6615, V-8	ea.	22.50

Oil Pump Pickup Tube Screen

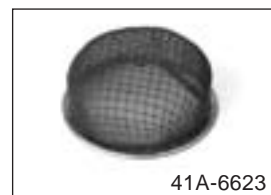

36-64	Pass	41A-6623, V-8	ea.	16.00
39-56	Merc	41A-6623	ea.	16.00
36-64	PU	41A-6623, V-8	ea.	16.00

Oil Pump Pickup Tube Screen Spring

39-53	Pass	EAD-6628, V-8	ea.	2.00
39-53	Merc	EAD-6628	ea.	2.00

Section 11 - Engine



C&G Early Ford Parts, Inc.

32-53 PU EAD-6628, V-8ea. 2.00

Oil Pump Relief Valve Spring

32-42 Pass 01A-6654, V-8, 50 lbs.....ea. 1.25
 39-42 Merc 01A-6654, 50 lbsea. 1.25
 32-42 PU 01A-6654, V-8, 50 lbs.....ea. 1.25

Large Oil Pump Idler Gear & Bushing

Mounts in the plate on the back of the engine.



32-53 Pass 18-6655, V-8ea. 20.00
 39-53 Merc 18-6655ea. 20.00
 32-53 PU 18-6655, V-8ea. 20.00

Oil Pump Idler Gear Shaft



49-53 Pass 8BA-6656-B, V-8ea. 13.50
 49-53 Merc 8BA-6656-Bea. 13.50
 48-52 PU 8BA-6656-B, V-8ea. 13.50

Oil Pump Idler Gear Bushing

32-53 Pass 18-6657, V-8ea. 2.50
 39-53 Merc 18-6657ea. 2.50
 32-53 PU 18-6657, V-8ea. 2.50

Camshaft Oil Pump Drive Gear

Mounts on the back of the cam shaft.



32-41 Pass 18-6254-A, V-8ea. 5.00
 32-53 Pass 18-6254-B, V-8ea. 18.00
 39-48 Merc 18-6254-Bea. 18.00
 32-41 PU 18-6254-A, V-8ea. 5.00
 32-53 PU 18-6254-B, V-8ea. 18.00

Camshaft Distributor Drive Gear

Mounts on the front of camshaft.

49-53 Pass 7RA-6255, V-8.....ea. 20.00
 49-53 Merc 7RA-6255ea. 20.00
 48-53 PU 7RA-6255, V-8.....ea. 20.00

Upper Oil Pump Drive Gear

32-53 Pass 18-6652, V-8ea. 7.00
 47-51 Pass 0HA-6652-A, 6 cyl.....ea. 28.00
 39-53 Merc 18-6652ea. 7.00

32-53 PU 18-6652, V-8ea. 7.00
 47-51 PU 0HA-6652-A, 6 cyl.....ea. 28.00

Oil Pump Drive Shaft

55-60 Pass & PU B9A-6A618-A,
 272, 292, 312ea. 11.50

Engine Block Oil Relief Valve Plunger



32-48 Pass 01A-6663, V-8ea. 10.00
 39-48 Merc 01A-6663ea. 10.00
 32-47 PU 01A-6663, V-8ea. 10.00

Engine Block Oil Relief Valve Plug



32-48 Pass 68-6666, V-8ea. 4.50
 39-48 Merc 68-6666ea. 4.50
 32-47 PU 68-6666, V-8ea. 4.50

Oil Sending Unit for Use With Stock Oil Gauge

35-53 Pass 41A-9278-ORea. 40.00
 39-56 Merc 41A-9278-ORea. 40.00
 35-56 PU 41A-9278-ORea. 40.00

Oil Sending Unit for Use With Light in Dash



54-64 Pass B6A-9278-Bea. 12.00
 54-56 Merc B6A-9278-Bea. 12.00
 54-66 PU B6A-9278-Bea. 12.00

Oil Sending Unit for VDO Gauge

Only works on VDO oil gauge up to 80 psi.
 360-005, 1/4-18 NPT.....ea. 41.00

OIL PAN

Oil Pan Drain Plug



32-38 Pass B-6730,
 V-8, 3/4"-24"x 5/8"ea. 3.50
 39-48 Pass 52-6730-A,
 V-8, 1 1/2"-30"x 5/8"ea. 8.00

41-47	Pass	1GA-6730, 6cyl, NOS, w/screen.....ea.	45.00
39-48	Merc	52-6730-A.....ea.	8.00
32-38	PU	B-6730, V-8, 3/4"-24"x 5/8".....ea.	3.50
39-47	PU	52-6730-A, V-8, 1 1/2"-30"x 5/8".....ea.	8.00
41-47	PU	1GA-6730, 6cyl, NOS, w/screen.....ea.	45.00

Oil Pan Drain Plug Gasket

28-34	Pass	B-6734, 4 cyl.....ea.	.75
32-38	Pass	B-6734, V-8, 3/4".....ea.	.75
38-48	Pass	01A-6746, V-8, 1 1/2".....ea.	1.50
41-47	Pass	8HA-6734, 6 cyl., 7/8".....ea.	1.50
49-56	Pass	8HA-6734, 7/8".....ea.	1.50
39-48	Merc	01A-6746.....ea.	1.50
49-56	Merc	8HA-6734.....ea.	1.50
28-34	PU	B-6734, 4 cyl.....ea.	.75
32-38	PU	B-6734, V-8, 3/4".....ea.	.75
38-47	PU	01A-6746, V-8, 1 3/4".....ea.	1.50
41-47	PU	8HA-6734, 6 cyl., 7/8".....ea.	1.50
48-56	PU	8HA-6734, 7/8".....ea.	1.50

Brass Oil Pan Drain Plug Gasket

28-34	Pass	B-6734-B, 4 cyl.....ea.	1.25
32-38	Pass	B-6734-B, V-8, 3/4".....ea.	1.25
28-34	PU	B-6734-B, 4 cyl.....ea.	1.25
32-38	PU	B-6734-B, V-8, 3/4".....ea.	1.25

Engine Oil Dipstick

28-34	Pass	B-6750, 4 cyl.....ea.	4.00
35-48	Pass	48-6750, V-8.....ea.	9.00

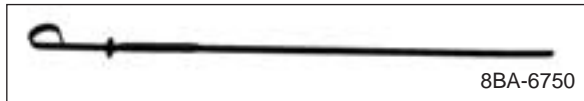

49-53	Pass	8BA-6750, V-8.....ea.	19.95
39-48	Merc	48-6750, V-8.....ea.	9.00
49-53	Merc	8BA-6750, V-8.....ea.	19.95
28-34	PU	B-6750, 4 cyl.....ea.	4.00
35-47	PU	48-6750, V-8.....ea.	9.00
48-53	PU	8BA-6750, V-8.....ea.	19.95
54-64	F100-350	B9TE-6750-B, 272,292,312.....ea.	19.95

Chrome Engine Oil Dipstick

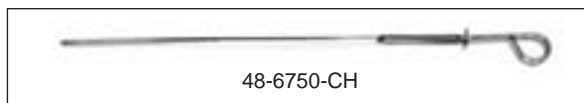

35-48	Pass	48-6750-CH, V-8.....ea.	24.95
-------	------	-------------------------	-------

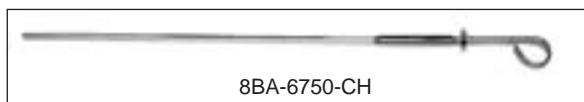

49-53	Pass	8BA-6750-CH, V-8.....ea.	24.95
39-48	Merc	48-6750-CH, V-8.....ea.	24.95
49-53	Merc	8BA-6750-CH, V-8.....ea.	24.95
35-47	PU	48-6750-CH, V-8.....ea.	24.95

48-53	PU	8BA-6750-CH, V-8.....ea.	24.95
-------	----	--------------------------	-------

Engine Oil Dipstick Tube

35-53	Pass	48-6754-B, V-8.....ea.	8.50
39-53	Merc	48-6754-B.....ea.	8.50
35-53	PU	48-6754-B, V-8.....ea.	8.50

Engine Oil Dipstick Tube Boss

Includes gasket and rivets.



35-48	Pass	48-6751, V-8.....ea.	25.00
35-48	Pass	59A-6751, w/oil return hole.....ea.	25.00
39-48	Merc	48-6751.....ea.	25.00
39-48	Merc	59A-6751, w/oil return hole.....ea.	25.00
35-48	PU	48-6751, V-8.....ea.	25.00
35-47	PU	59A-6751, w/oil return hole.....ea.	25.00

FILTER/BREATHER

Oil Filter

32-53	Pass	7HA-6731, V-8.....ea.	12.00
41-51	Pass	7HA-6731, 6 cyl.....ea.	12.00
52-57	Pass	C1TZ-6731, 6 cyl.....ea.	8.50
52-57	Pass	D9AZ-6731-A, 6 cyl., spin-on type.....ea.	6.00
54-57	Pass	C1TZ-6731, V-8, canister.....ea.	8.50
54-57	Pass	D9AZ-6731-A, V-8, spin-on type.....ea.	6.00
39-53	Merc	7HA-6731.....ea.	12.00
54-56	Merc	C1TZ-6731, canister.....ea.	8.50
54-56	Merc	D9AZ-6731-A, spin-on type.....ea.	6.00
55-57	T-Bird	D9AZ-6731-A, spin-on type.....ea.	6.00
32-53	PU	7HA-6731, V-8.....ea.	12.00
41-51	PU	7HA-6731, 6 cyl.....ea.	12.00
52-57	PU	C1TZ-6731, 6 cyl.....ea.	8.50
52-57	PU	D9AZ-6731-A, 6 cyl., spin-on type.....ea.	6.00
54-57	PU	C1TZ-6731, V-8, canister.....ea.	8.50
54-57	PU	D9AZ-6731-A, V-8, spin-on type.....ea.	6.00

Oil Filter Line Set

These are pre-bent steel lines.

41-46	Pass	11A-18666-K, V-8.....set.	38.00
47-48	Pass	59A-18666-K, V-8.....set.	38.00
41-46	Merc	11A-18666-K, V-8.....set.	38.00
47-48	Merc	59A-18666-K, V-8.....set.	38.00



Oil Breather Cap



37-48	Pass	48-6766-B.....ea.	10.00
49-53	Pass	8BA-6766, V-8, original.....ea.	14.00
57-59	Pass	B6AZ-6766-A, 272, 292, 312 original type "oil" cast in cap, black.....ea.	24.50
54-67	Pass	B6AZ-6766-B, V8, chrome with FoMoco script.....ea.	17.50
55-56	Pass	C5ZZ-6766-FR, black, push-on type with FoMoCo logo.....ea.	13.50
54-64	Pass	B6AZ-6766, V8, chrome, push-on type.....ea.	10.00
39-48	Merc	48-6766-B, round type.....ea.	10.00
49-53	Merc	8BA-6766, original.....ea.	14.00
37-47	PU	48-6766-B, round type.....ea.	10.00
48-53	PU	8BA-6766, V-8, original.....ea.	14.00
52-62	PU	COAZ-6766-A, 6 cyl.....ea.	5.00
54-67	PU	B6AZ-6766-B, V8, chrome with FoMoco script.....ea.	17.50
55-56	PU	C5ZZ-6766-FR, black, push-on type with FoMoCo logo.....ea.	13.50
54-64	PU	B6AZ-6766, V-8, chrome, replacement.....ea.	10.00

Crankcase Breather Screen

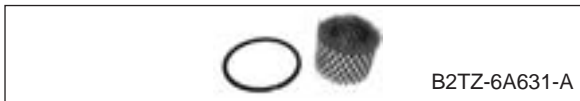

54-60	Pass & PU	B2TZ-6A631-A.....ea.	6.00
-------	-----------	----------------------	------

Oil Filter Adapter for Spin-on Oil Filter

Fits all overhead valve engines.



52-57	Pass & PU	B7A-6882.....kit.	30.00
-------	-----------	-------------------	-------

Oil Filter Adapter to Block Gasket

52-57	Pass & PU	EAA-6838-A.....ea.	1.00
-------	-----------	--------------------	------

Oil Filter Cannister Spring

52-57	Pass & PU	B2A-6889-A, 6 cyl., V-8.....ea.	5.75
-------	-----------	------------------------------------	------

**Section 12
Transmission**

MOUNTS

Transmission Mount

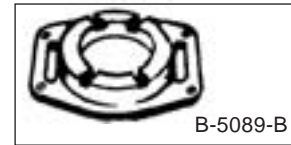

32	Pass	B-5089-B.....ea.	60.00
33-34	Pass	40-5089-B.....ea.	50.00

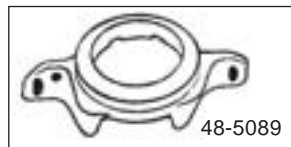

35-36	Pass	48-5089.....ea.	50.00
-------	------	-----------------	-------



37-41	Pass	78-6038-BDK, 2 req'd, mfg by Drake.....ea.	25.00
37-41	Pass	78-6038-K, 2 req'd.....ea.	20.00
42-48	Pass	21A-6068.....ea.	25.00



49-50	Pass	8A-6068.....ea.	18.00
51-56	Pass	AD-6068.....ea.	18.00
39-41	Merc	78-6038-BDK, 2 req'd, mfg by Drake.....ea.	25.00
39-41	Merc	78-6038-K, 2 required.....ea.	20.00
42-48	Merc	21A-6068.....ea.	25.00
49-50	Merc	8M-6068-B, early 50.....ea.	80.00
50-51	Merc	8M-6038-B, upper mount.....ea.	10.00



50-51	Merc	B9TT-6039-A, lower mount.....ea.	6.00
51-56	Merc	AD-6068.....ea.	18.00
55-56	T-Bird	AD-6068.....ea.	18.00
32	PU	B-5089-B.....ea.	60.00
33-34	PU	40-5089-B.....ea.	50.00
35-36	PU	48-5089.....ea.	50.00

37-41	PU	78-6038-BDK, 2 req'd, mfg by Drake.....ea.	25.00
37-41	PU	78-6038-K, 2 required.....ea.	20.00



42-52	PU	21A-6068.....ea.	25.00
-------	----	------------------	-------

GASKETS, BEARINGS & SEALS

Transmission Gasket Set

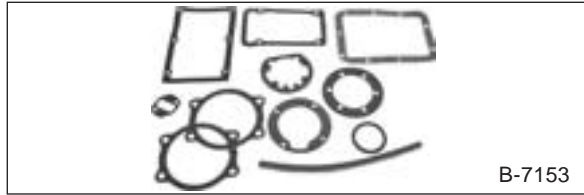

32-48	Pass	B-7153set.	10.00
-------	------	------------------	-------

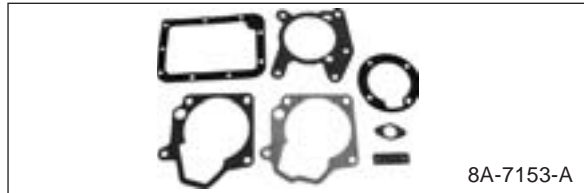

49-54	Pass	8A-7153-A, w/O.D.set.	16.00
49-59	Pass	8A-7153-B, no O.D.....set.	14.00
55-67	Pass	B5A-7153-B, w/Borg Warner Overdriveset.	20.00
56-59	Pass	B6A-7153-Bset.	20.00
39-48	Merc	B-7153set.	10.00
49-51	Merc	8M-7153-A, w/O.D.....set.	16.00
49-51	Merc	8M-7153-B, no O.D.....set.	16.00
52-56	Merc	8A-7153-A, w/O.D.set.	16.00
52-56	Merc	8A-7153-B, no O.D.....set.	14.00

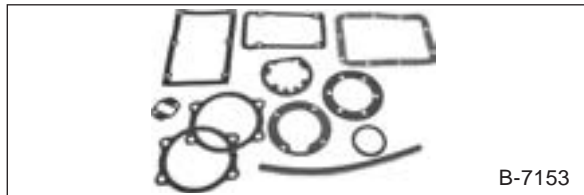

32-52	PU	B-7153, 3 speed.....set.	10.00
32-52	PU	BB-7153, 4 speedset.	20.00

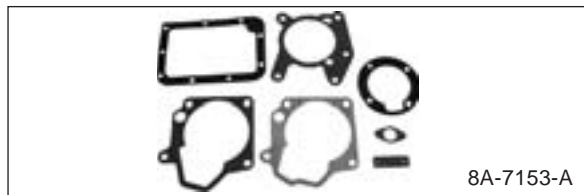

53-56	PU	8A-7153-A, w/O.D.set.	16.00
53-62	PU	8A-7153-B, no O.D.....set.	14.00

Input Seal

32-48	Pass	78-7052.....ea.	5.00
49-56	Pass	B7AZ-7A283-A, must use 1957 nose cone.....ea.	9.50
39-50	Merc	78-7052.....ea.	5.00
32-52	PU	78-7052.....ea.	5.00

Output Bushing



49-56	Pass	B3TZ-7034-D.....ea.	8.00
49-56	Merc	B3TZ-7034-D.....ea.	8.00
53-56	PU	B3TZ-7034-D.....ea.	8.00

Output Seal



49-56	Pass	21C-7052, std/O.D.ea.	5.50
49-56	Pass	21C-7052-A, w/ext., std/O.D.ea.	20.00
51-65	Pass	C2AZ-7052-A, auto & std, 2.376" O.D.ea.	15.00
56-UP	Pass	C1AP-7052-B, auto, 2.506" O.D.ea.	12.50
49-56	Merc	21C-7052, std/O.D.ea.	5.50
42-71	PU	21C-7052, std/O.D.ea.	5.50
42-71	PU	21C-7052-A, w/ext., std/O.D.ea.	20.00
53-63	PU	C2AZ-7052-A, auto & std, 2.376" O.D.ea.	15.00
56-UP	PU	C1AP-7052-B, auto, 2.506" O.D.ea.	12.50

Overdrive Solenoid Seal

49-56	Pass	26H-7693.....ea.	6.00
49-56	Merc	26H-7693.....ea.	6.00
53-56	PU	26H-7693.....ea.	6.00

Overdrive Selector Shaft Seal

49-56	Pass	A9AZ-7288-A.....ea.	7.00
49-56	Merc	A9AZ-7288-A.....ea.	7.00
49-UP	PU	A9AZ-7288-A.....ea.	7.00

Side Cover Selector Shaft Seal

40-50	Pass	01A-7288.....ea.	5.00
51-56	Pass	1A-7288.....ea.	.50
40-51	Merc	01A-7288.....ea.	5.00
40-52	PU	01A-7288.....ea.	5.00
51-64	PU	1A-7288.....ea.	.50

Input & Output Bearing

32-54	Pass	51A-7025, input.....ea.	30.00
28-48	Pass	B-7065-S, sealed output.....ea.	30.00
28-48	Pass	B-7065, output.....ea.	30.00



49-59	Pass	8A-7025/65, input/output.....ea.	20.00
39-50	Merc	51A-7025, input.....ea.	30.00
39-50	Merc	B-7065, output.....ea.	30.00
39-50	Merc	B-7065-S, sealed output.....ea.	30.00
51-56	Merc	8A-7025/65, input/output.....ea.	20.00
32-52	PU	51A-7025, input.....ea.	30.00
28-41	PU	B-7065-S, sealed output.....ea.	30.00
42-52	PU	B-7065, output.....ea.	30.00
55-63	PU	8A-7025/65, input/output.....ea.	20.00

Cluster & Input Gear Bearing

Short, 2 required.



28-50	Pass	B-7118.....ea.	8.00
39-50	Merc	B-7118.....ea.	8.00
28-50	PU	B-7118.....ea.	8.00

Cluster Gear Bearing

Long, 1 required.



28-50	Pass	B-7121.....ea.	8.00
39-50	Merc	B-7121.....ea.	8.00
28-50	PU	B-7121.....ea.	8.00

Transmission (Needle) Roller Bearings

49-62	Pass & PU	8A-7118-S, 15 pcs.....set.	9.00
49-62	Pass & PU	8A-7121-S, 50 pcs.....set.	13.00

GEARS

Zephyr Gear Set

Includes 18 tooth input, 24 tooth second gear, and 26 tooth cluster gear. These gear sets are a little noisy.



39-48	Pass	0GH-7112-KIT.....set.	725.00
39-48	Merc	0GH-7112-KIT.....set.	725.00
39-50	PU	0GH-7112-KIT.....set.	725.00

Input Gear



32-39	Pass	48-7017, 16 teeth.....ea.	125.00
38-48	Pass	022A-7017, 15 teeth, use w/29 teeth cluster.....ea.	140.00
38-48	Pass	81A-7017, 16 teeth, use w/28 teeth cluster.....ea.	225.00

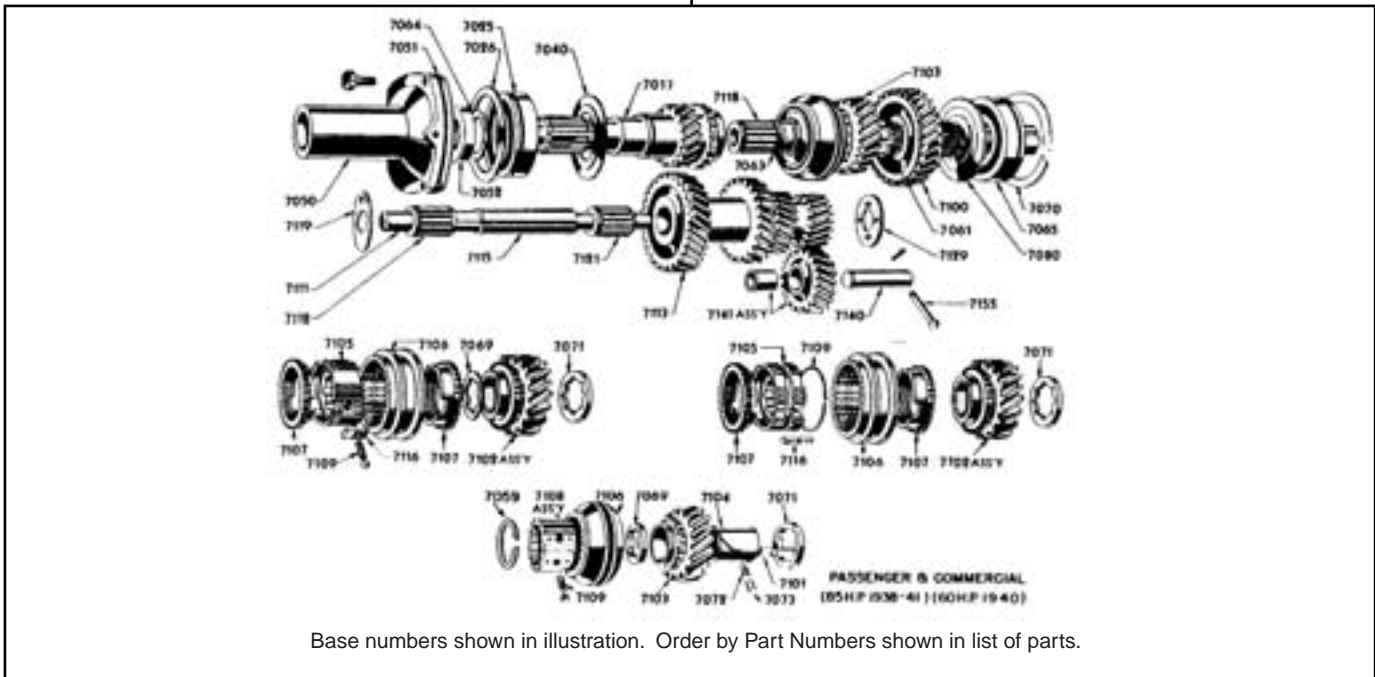

Base numbers shown in illustration. Order by Part Numbers shown in list of parts.

39-48	Pass	06H-7017, 18 teeth use w/26 teeth cluster.....ea.	225.00
49-50	Pass	8A-7017, 16 teeth.....ea.	100.00
51-54	Pass	1A-7017-A, 16 teeth.....ea.	125.00
39-50	Merc	81A-7017, 16 teeth, use w/28 teeth cluster.....ea.	225.00
39-48	Merc	022A-7017, 15 teeth, use w/29 teeth cluster.....ea.	140.00
39-48	Merc	06H-7017, 18 teeth use w/26 teeth cluster.....ea.	225.00
32-39	PU	48-7017, 16 teeth.....ea.	125.00
38-50	PU	022A-7017, 15 teeth, use w/29 teeth cluster.....ea.	140.00
38-50	PU	81A-7017, 16 teeth, use w/28 teeth cluster.....ea.	225.00
39-50	PU	06H-7017, 18 teeth use w/26 teeth cluster.....ea.	225.00

Cluster Gear



32-35	Pass	48-7113, 28 teeth.....ea.	210.00
36-48	Pass	51A-7113, 28 teeth, use w/cage bearings.....ea.	375.00
39-48	Pass	06H-7113, 26 teeth.....ea.	425.00
40-48	Pass	022A-7113-A, 29 teeth.....ea.	365.00
49-50	Pass	8A-7113-A, 28 teeth, use w/needle bearings.....ea.	325.00
51-54	Pass	B4A-7113, 27 teeth.....ea.	285.00
39-48	Merc	51A-7113, 28 teeth use w/cage bearings.....ea.	375.00
39-48	Merc	06H-7113, 26 teeth.....ea.	425.00
40-48	Merc	022A-7113-A, 29 teeth.....ea.	365.00
51-54	Merc	B4A-7113, 27 teeth.....ea.	285.00
32-35	PU	48-7113, 28 teeth.....ea.	210.00
36-50	PU	51A-7113, 28 teeth use w/cage bearings.....ea.	375.00
39-50	PU	06H-7113, 26 teeth.....ea.	425.00
40-50	PU	022A-7113-A, 29 teeth.....ea.	365.00
51-54	PU	B4A-7113, 27 teeth.....ea.	285.00

First/Reverse Slider Gear



32-35	Pass	B-7100, 29 teeth, 6 str. spline.....ea.	125.00
36-50	Pass	01A-7100, helical cut.....ea.	120.00
51-54	Pass	1A-7100, 28 teeth.....ea.	125.00
39-50	Merc	01A-7100, helical cut.....ea.	120.00
51-54	Merc	1A-7100, 28 teeth.....ea.	125.00
32-35	PU	B-7100, 29 teeth, 6 str. spline.....ea.	125.00
36-50	PU	01A-7100, helical cut.....ea.	120.00

51-55	PU	1A-7100, 28 teeth.....ea.	125.00
-------	----	---------------------------	--------

Second Gear



32-34	Pass	B-7103, 22 teeth.....ea.	90.00
39-48	Pass	06H-7102, 24 teeth.....ea.	185.00
39-50	Pass	81A-7102, 22 teeth.....ea.	150.00
51-54	Pass	C1AZ-7102, 22 teeth, use w/B4A-7113 cluster.....ea.	98.00
55-59	Pass	B7A-7102-A, NOS,23 teeth.....ea.	125.00
39-48	Merc	06H-7102, 24 teeth.....ea.	185.00
39-50	Merc	81A-7102, 22 teeth.....ea.	150.00
51-54	Merc	C1AZ-7102, 22 teeth, use w/B4A-7113 cluster.....ea.	98.00
32-34	PU	B-7103, 22 teeth.....ea.	90.00
39-50	PU	06H-7102, 24 teeth.....ea.	185.00
39-50	PU	81A-7102, 22 teeth.....ea.	150.00
51-55	PU	C1AZ-7102, 22 teeth, use w/B4A-7113 cluster.....ea.	98.00

Second Gear Bushing

32-38	Pass & PU	68-7104.....ea.	33.00
-------	-----------	-----------------	-------

Reverse Idler Gear



32-38	Pass	B-7141, straight cut.....ea.	24.00
38-50	Pass	68-7141, helical cut, 18 teeth.....ea.	85.00
51-54	Pass	1A-7141.....ea.	55.00
39-50	Merc	68-7141, helical cut, 18 teeth.....ea.	85.00
32-38	PU	B-7141, straight cut.....ea.	24.00
38-50	PU	68-7141, helical cut, 18 teeth.....ea.	85.00
51-54	PU	1A-7141.....ea.	55.00

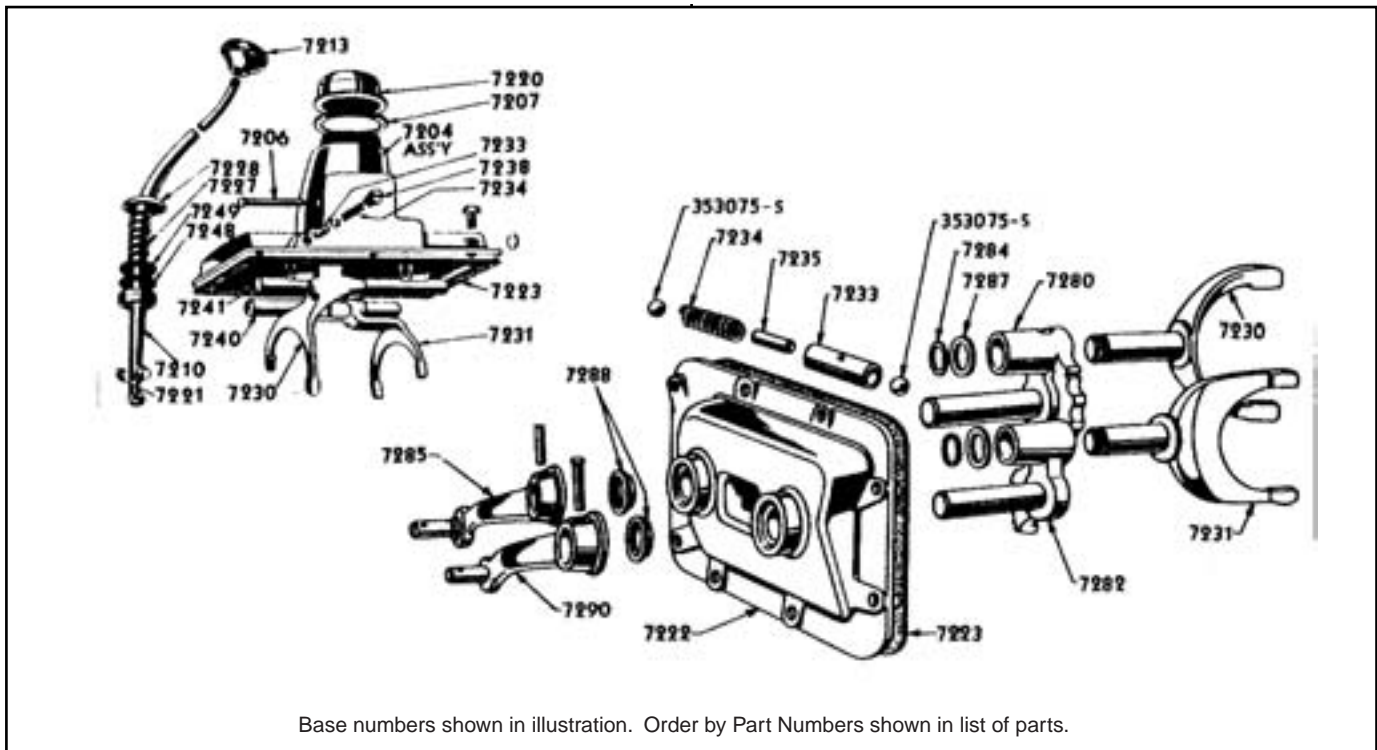

Base numbers shown in illustration. Order by Part Numbers shown in list of parts.

SHAFTS

Main Shaft



38-48	Pass	81A-7061-U, with pin hole.....ea.	175.00
39-48	Pass	51A-7061-A, no pin hole.....ea.	150.00
39-48	Pass	81A-7061.....ea.	250.00
39-48	Merc	51A-7061-A, no pin hole.....ea.	150.00
39-48	Merc	81A-7061.....ea.	250.00
39-48	Merc	81A-7061-U, with pin hole.....ea.	175.00
38-41	PU	81A-7061-U, with pin hole.....ea.	175.00
39-41	PU	51A-7061-A, no pin hole.....ea.	150.00
39-41	PU	81A-7061.....ea.	250.00

Output Shaft

36	Pass & PU	68-7061-A, 6 hel. & 6 str. splines.....ea.	85.00
36	Pass & PU	68-7061-B, 16 hel. & 6 str. splines.....ea.	95.00

Cluster Gear Shaft

32-50	Pass	B-7111, use w/caged bearings.....ea.	12.00
49-54	Pass	8A-7111.....ea.	25.00
39-50	Merc	B-7111, use w/caged bearings.....ea.	12.00
51-54	Merc	8A-7111.....ea.	25.00
32-50	PU	B-7111, use w/caged bearings.....ea.	12.00
51-55	PU	8A-7111.....ea.	25.00

Reverse Idler Gear Shaft

32-54	Pass	B-7140.....ea.	15.50
39-50	Merc	B-7140.....ea.	15.50
32-62	PU	B-7140.....ea.	15.50

Cluster & Reverse Idler Gear Shaft Pin

32-48	Pass	B-7155.....ea.	10.00
39-48	Merc	B-7155.....ea.	10.00
32-50	PU	B-7155.....ea.	10.00

SYNCHRONIZER

Synchronizer Assembly



38-39	Pass	81A-7124.....ea.	125.00
40-54	Pass	8M-7124.....ea.	115.00
55-56	Pass	8M-7124, no O.D.....ea.	115.00
55-56	Pass	C2TZ-7124-A, w/O.D.....ea.	85.00
39-54	Merc	8M-7124.....ea.	115.00
55-56	T-Bird	8M-7124, no O.D.....ea.	115.00
40-62	PU	8M-7124, 3 speed, light duty.....ea.	115.00

Synchro Hub

32-34	Pass & PU	B-7108.....ea.	115.00
-------	-----------	----------------	--------

Synchro Repair Kit

Includes inserts & rings.



40-56	Pass	51A-7116-S.....kit.	11.00
39-54	Merc	51A-7116-S.....kit.	11.00
40-56	PU	51A-7116-S.....kit.	11.00

Synchro Brass Rings

39-56	Pass	81A-7107.....ea.	8.00
39-54	Merc	81A-7107.....ea.	8.00
39-60	PU	81A-7107.....ea.	8.00

Synchro Small Parts Kit



38-48	Pass	81A-7109-S.....ea.	13.50
39-54	Merc	81A-7109-S.....ea.	13.50
38-50	PU	81A-7109-S.....ea.	13.50

SMALL PARTS

Small Parts Kit

Kit includes washers & spacers for setting up transmission.



51A-7199-KIT

36-46	Pass	68-7199-KIT.....kit.	50.00
38-48	Pass	51A-7199-KIT.....kit.	42.00
49-54	Pass	8A-7199.....kit.	32.50
55-59	Pass	B5A-7199.....kit.	32.00
39-50	Merc	51A-7199-KIT.....kit.	42.00
51-54	Merc	8A-7199.....kit.	32.50
36-46	PU	68-7199-KIT.....kit.	50.00
38-50	PU	51A-7199-KIT.....kit.	42.00
51-54	PU	8A-7199.....kit.	32.50
55-62	PU	B5A-7199.....kit.	32.00

Cluster Washer Set



AOA-7130

40-54	Pass	AOA-7130, 3 pcs.....set.	25.00
40-54	Merc	AOA-7130, 3 pcs.....set.	25.00
40-54	PU	AOA-7130, 3 pcs.....set.	25.00

Front Cluster Washer

32-54	Pass	B-7119.....ea.	5.50
39-54	Merc	B-7119.....ea.	5.50
32-54	PU	B-7119.....ea.	5.50

Rear Cluster Washer

36-53	Pass	68-7129-B, 4 lugs.....ea.	14.50
36-53	Pass	8M-7129, 2 lug.....ea.	16.00
39-54	Merc	68-7129-B, 4 lugs.....ea.	14.50
39-54	Merc	8M-7129, 2 lugs.....ea.	16.00
36-53	PU	68-7129-B, 4 lugs.....ea.	14.50
36-53	PU	8M-7129, 2 lugs.....ea.	16.00

Cluster Spacer

36-50	Pass & PU	8A-7115, use w/8A-7113.....ea.	20.00
55-59	Pass	B5A-7115-A.....ea.	3.50

Cluster Spacer Washer

49-UP	Pass & PU	351529-S, use w/8A-7113.....ea.	2.75
-------	-----------	------------------------------------	------

Second Gear Snap Ring

38-48	Pass	81A-7059.....ea.	4.00
39-48	Merc	81A-7059.....ea.	4.00
38-50	PU	81A-7059.....ea.	4.00

Second Gear Front Washer

38-48	Pass	81A-7069-A, .0630-.0655.....ea.	9.00
38-48	Pass	81A-7069-B, .0680-.0710.....ea.	9.00
39-48	Merc	81A-7069-A, .0630-.0655.....ea.	9.00
39-48	Merc	81A-7069-B, .0680-.0710.....ea.	9.00
38-50	PU	81A-7069-A, .0630-.0655.....ea.	9.00
38-50	PU	81A-7069-B, .0680-.0710.....ea.	9.00

Second Gear Rear Washer

38-48	Pass	81A-7071.....ea.	8.00
39-48	Merc	81A-7071.....ea.	8.00
38-50	PU	81A-7071.....ea.	8.00

SHIFT PARTS

Gear Shift Knobs - Floor Shift

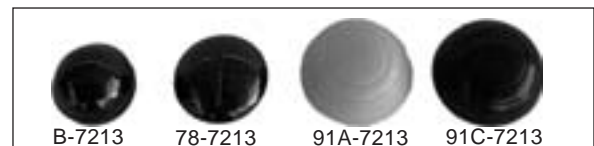

B-7213 78-7213 91A-7213 91C-7213

32-36	Pass	B-7213, black.....ea.	4.50
35-36	Pass	48-7213, brown.....ea.	4.50
37-38	Pass	78-7213, w/V-8, brown.....ea.	6.50
39	Pass	91A-7213, ivory.....ea.	15.00
39	Merc	99A-7213.....ea.	15.00
32-36	PU	B-7213, black.....ea.	4.50
37-52	PU	91C-7213, w/3 speed.....ea.	15.00



Chrome Gear Shift Knobs - Floor Shift



32-39	Pass	B-7213-C	ea.	12.00
32-39	Pass	78-7213-C, w/V-8	ea.	12.00
32-52	PU	B-7213-C, w/3 speed	ea.	12.00
32-52	PU	78-7213-C, w/3 speed	ea.	12.00

Gear Shift Boot



28-36	Pass & PU	GB-7000, black	ea.	3.50
33-39	Pass	99A-7242-T, taupe	ea.	15.00
33-39	Pass	99A-7242-B, black	ea.	15.00
32-52	PU	99A-7242-B, black	ea.	15.00

Gear Shift Knobs - Column Shift

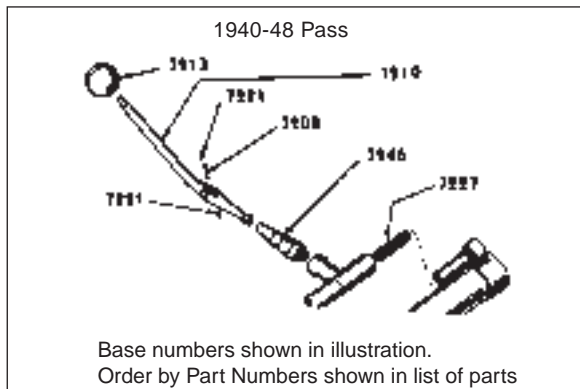

40	Std Pass	01A-7213-A	ea.	8.00
40	Dlx Pass	01A-7213-B	ea.	8.00
41	Dlx Pass	11A-7213, tan	ea.	8.00
41	Super Dlx	11A-7213, tan	ea.	8.00
42	Dlx Pass	21A-7213-A, brown	ea.	8.00
42	Super Dlx	21A-7213-B, butterscotch	ea.	8.00
46	Dlx Pass	51A-7213-A, maroon	ea.	8.00
46	Super Dlx	51A-7213-B, blue gray	ea.	8.00
46	Super Dlx	51A-7213-C, gray tan	ea.	8.00
47-48	Dlx Pass	51A-7213-C, gray tan	ea.	8.00
47-48	Super Dlx	51A-7213-C, gray tan	ea.	8.00
49-50	Pass	0A-7213, ivory	ea.	7.00
49-53	Pass	7C-7213, black	ea.	6.00
54-56	Pass	B6C-7213, black	ea.	6.00
40	Merc	09A-7213	ea.	10.00
42-47	PU	21C-7213, light tan	ea.	8.00
48-55	PU	7C-7213, black	ea.	6.00
56-60	PU	B6C-7213, black	ea.	6.00

Shift Tube

49-50	Pass	8BA-7209-F, NOS	ea.	50.00
-------	------	-----------------------	-----	-------

Gear Shift Lever Pin

40-53	Pass	01A-7221, column shift	ea.	6.00
40-53	Merc	01A-7221, column shift	ea.	6.00
40-55	PU	01A-7221, column shift	ea.	6.00
56-61	PU	357479-S	ea.	1.00

Gear Shift Lever Spring

32-39	Pass	B-7227, floor shift	ea.	1.50
39	Merc	B-7227, floor shift	ea.	1.50
32-52	PU	B-7227, floor shift	ea.	1.50

Gearshift Lever Grommet



40-56	Pass	01A-7246-B, std	ea.	5.00
51-56	Pass	1M-7246-A, auto	ea.	5.50
40-56	Merc	01A-7246-B, std	ea.	5.00
51-56	Merc	1M-7246-A, auto	ea.	5.50
40-60	PU	01A-7246-B, std	ea.	5.00
53-60	PU	1M-7246-A, auto	ea.	5.50

Gear Shift Lever Pins, Spring & Grommet Kit



40-53	Pass	01A-7221-K	kit.	25.00
-------	------	------------------	------	-------

Gearshift Lever Pin Spring

40-53	Pass	01A-7208	ea.	.50
40-53	Merc	01A-7208	ea.	.50
40-56	PU	01A-7208	ea.	.50

Column Shift Tube Wave Washer

40-56	Pass	351560-S7, N.O.S. 2 required	ea.	1.00
41-52	PU	351560-S7, N.O.S. 1 required	ea.	1.00

Gearshift Lever Grommet Kit



40-51	Pass	01A-7354-RK, set of 4	kit.	20.00
52-56	Pass	B2AZ-7343-A, std	ea.	7.00
40-51	Merc	01A-7354-RK, set of 4	kit.	20.00
40-56	PU	01A-7354-RK, set of 4	kit.	20.00

Side Cover Cam and Shaft Arm

49-50	Pass	8A-7280-B1, NOS, 2nd/3rd	ea.	50.00
51-54	Pass	1A-7280-A1, NOS, 2nd/3rd, except auto	ea.	50.00

Shift Fork



49-50	Pass	8A-7282-B, NOS, low/rev	ea.	20.00
51-54	Pass	1A-7282-A, NOS, low/rev, except auto	ea.	20.00

U-JOINT

Transmission U-Joint



32-48	Pass	B-7090	ea.	110.00
49-56	Pass	1M-7042-A, front	ea.	26.00
49-56	Pass	1M-7039, rear	ea.	52.00
39-48	Merc	B-7090	ea.	110.00
49-56	Merc	1M-7042-A, front	ea.	26.00
49-56	Merc	1M-7039, rear	ea.	52.00
55	T-Bird	1M-7042-A, front	ea.	26.00
55	T-Bird	1M-7039, rear	ea.	52.00
56-60	T-Bird	21C-7039, front/rear	ea.	18.00
32-41	PU	B-7090	ea.	110.00
42-63	PU	21C-7039, front/rear	ea.	18.00

U-Joint Repair Kit



32-48	Pass	B-7090-K	ea.	25.00
39-48	Merc	B-7090-K	ea.	25.00
32-41	PU	B-7090-K	ea.	25.00

U-Joint Bolt Washer

Special thick washer used to hold u-joint on back of transmission.

32-48	Pass	B-7095	ea.	2.00
39-48	Merc	B-7095	ea.	2.00
32-41	PU	B-7095	ea.	2.00

U-Joint Gasket Set

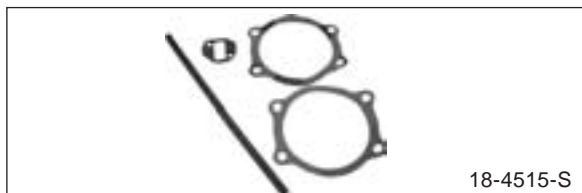

32-48	Pass	18-4515-S	set.	8.00
39-48	Merc	18-4515-S	set.	8.00
32-41	PU	18-4515-S	set.	8.00

**Section 13
Clutch**

PRESSURE PLATE/DISC

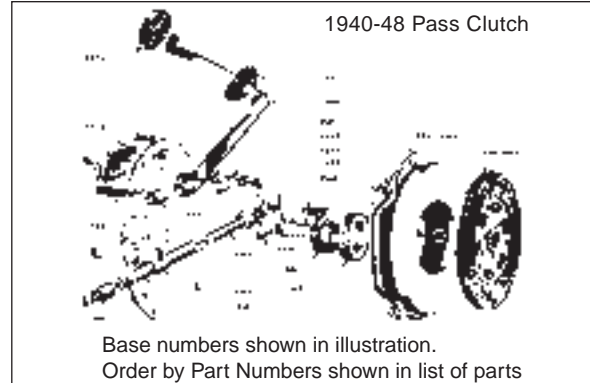

New Pressure Plate

32-48	Pass	CA-5102-NEW, 9"	ea.	129.95
32-48	Pass	CA-0779-NEW, 10"	ea.	129.95
32-48	Pass	CA-0162-NEW, 11"	ea.	135.00
49-56	Pass	CA-8594-N, 9-1/2"	ea.	130.00
39-48	Merc	CA-5102-NEW, 9"	ea.	129.95
39-48	Merc	CA-0779-NEW, 10"	ea.	129.95
39-48	Merc	CA-0162-NEW, 11"	ea.	135.00
32-47	PU	CA-5102-NEW, 9"	ea.	129.95
32-56	PU	CA-0779-NEW, 10"	ea.	129.95
32-56	PU	CA-0162-NEW, 11"	ea.	135.00

Rebuilt Pressure Plate

The core charge will apply if you do not send in your pressure plate core prior to placing your order, or if it is not identical to the one purchased.

32-34	Pass	CA-0001, 9" early style, need core to rebuild	ea.	110.00
32-48	Pass	CA-5102, 9", 6 bolt	ea.	85.00
32-48	Pass	CA-5102CORE, core charge	ea.	60.00
32-48	Pass	CA-0779, 10"	ea.	85.00
32-48	Pass	CA-0779CORE, core charge	ea.	60.00
32-48	Pass	CA-0162, 11"	ea.	119.95
32-48	Pass	CA-0162-CORE, core charge	ea.	60.00
49-56	Pass	CA-8594, 9.5"	ea.	85.00
49-56	Pass	CA-8594-CORE, core charge	ea.	60.00
39-48	Merc	CA-0779, 10"	ea.	85.00
39-48	Merc	CA-0779CORE, core charge	ea.	60.00
49-50	Merc	CA-1477, 10"	ea.	114.95
49-50	Merc	CA-1477-CORE, core charge	ea.	60.00
32-34	PU	CA-0001, 9" early style, need core to rebuild	ea.	110.00
32-47	PU	CA-5102, 9", 6 bolt	ea.	85.00
32-47	PU	CA-5102CORE, core charge	ea.	60.00
32-56	PU	CA-0779, 10"	ea.	85.00
32-56	PU	CA-0779CORE, core charge	ea.	60.00
32-56	PU	CA-0162, 11"	ea.	119.95



32-56 PU CA-0162-CORE, core charge.....ea. 60.00

New Clutch Disc

32-48 Pass & 39-50 Merc are 10 Spline x 1.37". 49-56 Pass & 51-56 Merc are 10 Spline x 1".

32-48	Pass	CD-688, 9".....ea.	55.00
32-48	Pass	CD-870, 10".....ea.	55.00
32-48	Pass	CD-607-N, 11".....ea.	55.00
49-56	Pass	CD-8824, 9.5".....ea.	55.00
49-56	Pass	CD-7550-N, 10".....ea.	65.00
39-50	Merc	CD-870, 10".....ea.	55.00
51-56	Merc	CD-7550-N, 10".....ea.	65.00
32-47	PU	CD-688, 9".....ea.	55.00
32-56	PU	CD-870, 10".....ea.	55.00
32-56	PU	CD-607-N, 11".....ea.	55.00

Clutch Alignment Tool

32-48	Pass	TOOL-CL.....ea.	13.00
49-56	Pass	TOOL-CL-49, 1" x 10 spline.....ea.	7.00
39-50	Merc	TOOL-CL.....ea.	13.00
51-56	Merc	TOOL-CL-49, 1" x 10 spline.....ea.	7.00
32-56	PU	TOOL-CL.....ea.	13.00

BEARINGS

Clutch Pilot Bearing

28-59	Pass	B-7600.....ea.	9.00
39-56	Merc	B-7600.....ea.	9.00
28-59	PU	B-7600.....ea.	9.00

Clutch Release/Throwout Bearing

28-48	Pass	78-7580.....ea.	32.00
49-59	Pass	8A-7580-A.....ea.	30.00
39-50	Merc	78-7580.....ea.	32.00
51-56	Merc	8A-7580-A.....ea.	30.00
28-64	PU	78-7580.....ea.	32.00

Clutch Release/Throwout Bearing & Hub Assembly



35-48	Pass	48-7561-SET, V8.....ea.	50.00
52-56	Pass	AD-7580-AH.....ea.	28.00
52-53	Merc	AD-7580-AH.....ea.	28.00
54-61	Merc	MB-7580-SET.....set.	30.00
35-47	PU	48-7561-SET, V8.....ea.	50.00
53-56	PU	TAAA-7580-SET.....ea.	48.50

Clutch Release/Throwout Bearing Hub

35-48	Pass	48-7561.....ea.	20.00
39-50	Merc	48-7561.....ea.	20.00
35-52	PU	48-7561.....ea.	20.00

CLUTCH SHAFT/RELATED

Clutch Release Shaft

32-39	Pass	B-7510.....ea.	23.00
40-48	Pass	01A-7510.....ea.	35.00
39	Merc	B-7510.....ea.	23.00
40-48	Merc	01A-7510.....ea.	35.00
32-39	PU	B-7510.....ea.	23.00
40-52	PU	01A-7510.....ea.	35.00

Clutch Release Shaft Bushings



28-34	Pass	B-7508.....ea.	2.50
35-48	Pass	40-7508, thin.....ea.	4.00
39	Pass	B-7508.....ea.	2.50
40-48	Pass	51A-7508, thick.....ea.	8.50
39-48	Merc	51A-7508, thick.....ea.	8.50
28-34	PU	B-7508.....ea.	2.50
35-47	PU	40-7508, thin.....ea.	4.00
39	PU	B-7508.....ea.	2.50
40-52	PU	51A-7508, thick.....ea.	8.50

Clutch Release Fork



28-48	Pass	48-7515.....ea.	20.00
49-51	Pass	A9A-7515.....ea.	16.50
39-48	Merc	48-7515.....ea.	20.00
28-52	PU	48-7515.....ea.	20.00

Clutch Release Fork Spring



35-48	Pass	48-7562.....ea.	1.75
39-50	Merc	48-7562.....ea.	1.75
35-52	PU	48-7562.....ea.	1.75

Clutch Equalizer Shaft



40	Pass	01A-7503.....ea.	50.00
41-48	Pass	51A-7503.....ea.	50.00
40-41	PU	01A-7503.....ea.	50.00
40-47	Truck	01T-7503.....ea.	45.00
42-47	PU	01T-7503.....ea.	45.00

Clutch Equalizer Bushings



40-56	Pass	01A-7517pr.	9.00
40-56	Pass	01A-7517-P, plasticpr.	5.00
40-56	Merc	01A-7517pr.	9.00
40-56	Merc	01A-7517-P, plasticpr.	5.00
40-64	PU	01A-7517pr.	9.00
40-64	PU	01A-7517-P, plasticpr.	5.00

Clutch Equalizer Spring

40-48	Pass	01A-7545ea.	1.75
40-51	Merc	01A-7545ea.	1.75
40-52	PU	01A-7545ea.	1.75

Clutch Equalizer Frame Bracket & Ball



40-48	Pass	01A-7507ea.	21.50
40-41	PU	01A-7507ea.	21.50
42-52	PU	01Y-7507ea.	21.50

Clutch Equalizer Bracket Rubber Washer

40-48	Pass	01A-7539ea.	.50
40-56	Merc	01A-7539ea.	.50
40-52	PU	01A-7539ea.	.50

Clutch Release Shaft Fork Pivot



53-72	PU	TAAA-7522-Aea.	19.50
-------	----	-------------	----------	-------

Clutch Adjusting Rod

32-48	Pass	48-7521, 4"ea.	9.00
49-50	Pass	8A-7521-BR, early 50, 11-1/4"ea.	14.95
39-48	Merc	48-7521, 4"ea.	9.00
32-47	PU	48-7521, 4"ea.	9.00
53-56	PU	TAAA-7521-Aea.	8.00

Clutch Adjusting Rod Boot

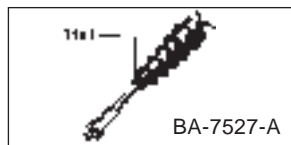

52-56	Pass	BA-7527-Aea.	15.00
55-57	T-Bird	BA-7527-Aea.	15.00

Clutch Rod Clevis

32-48	Pass	B-7532ea.	11.50
-------	------	--------	----------	-------

32-52	PU	B-7532ea.	11.50
-------	----	--------	----------	-------

Clutch Lever & Clutch Release Fork Pin

28-48	Pass	352581-Sea.	1.00
39-48	Merc	352581-Sea.	1.00
28-52	PU	352581-Sea.	1.00

Clutch Release Arm to Bellhousing Seal



49-53	Pass	8A-7996ea.	1.00
-------	------	---------	----------	------

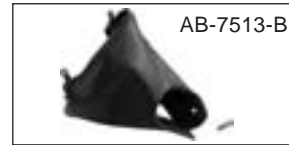

52-56	Pass	AB-7513-Bea.	23.95
55-57	T-Bird	AB-7513-Bea.	23.95

PEDAL PADS/BUSHINGS

Clutch Pedal Pad



32	Pass	B-2454, Ford scriptea.	35.00
33-36	Pass	40-2454ea.	8.50
33-48	Pass	HR-2454-SS, SSea.	35.00
37-40	Pass	78-2454ea.	8.50
41-48	Pass	11A-2454ea.	8.50
49-51	Pass	8A-2454ea.	8.00



52-65	Pass	B7A-2457-Aea.	5.00
39-40	Merc	78-2454ea.	8.50
41-48	Merc	11A-2454ea.	8.50
49-51	Merc	CB-90, coverpr.	22.00
32	PU	B-2454, Ford scriptea.	35.00
33-36	PU	40-2454ea.	8.50
33-56	PU	HR-2454-SS, SSea.	35.00
37-40	PU	78-2454ea.	8.50
41-56	PU	11A-2454ea.	8.50
48-56	Truck	7RT-2454ea.	15.00



Clutch Pedal Shaft



32-34	Pass	B-7506ea.	25.00
35-38	Pass	48-7506ea.	24.00
32-34	PU	B-7506ea.	25.00
35-38	PU	48-7506ea.	24.00
42-52	PU	01T-7506ea.	21.00
53-56	PU	TAAA-7506-Aea.	33.00

Clutch Pedal Shaft w/Bushings



40-48	Pass	01A-7506-Sset.	17.50
40-48	Merc	01A-7506-Sset.	17.50
40-41	PU	01A-7506-Sset.	17.50

Clutch Pedal Shaft Pin



32-48	Pass	B-7533ea.	1.50
39-48	Merc	B-7533ea.	1.50
32-47	PU	B-7533ea.	1.50

Clutch Pedal Bushing



32-34	Pass	B-7526-Aea.	4.50
35-38	Pass	48-7526ea.	3.00
39	Pass	91A-7526ea.	9.00
40-48	Pass	01A-7526, 2 req'dea.	3.00
40-51	Merc	01A-7526, 2 req'dea.	3.00
32-34	PU	B-7526-Aea.	4.50
35-38	PU	48-7526ea.	3.00
39	PU	91A-7526ea.	9.00
40-41	PU	01A-7526, 2 req'dea.	3.00
42-52	PU	B-7526-Aea.	4.50

Clutch Pedal Bracket to Shaft Bushing

53-56	PU	7EQ-5344-Aea.	5.00
-------	----	------------	----------	------

Clutch Pedal Return Spring

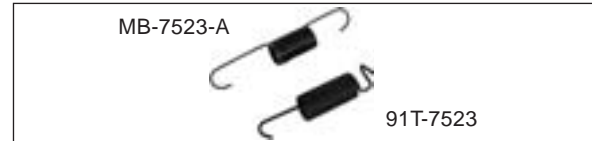

33-34	Pass	78-7523ea.	3.00
35-36	Pass	48-7523ea.	3.00
37-38	Pass	78-7523ea.	3.00
39	Pass	91A-7523ea.	3.00
40	Pass	01A-7523ea.	4.00
41-48	Pass	99A-7523ea.	3.00
49-50	Pass	8A-7523ea.	3.00
51	Pass	1A-7523-Bea.	12.00
52-54	Pass	MB-7523-Aea.	5.00
39-48	Merc	99A-7523ea.	3.00
33-34	PU	78-7523ea.	3.00
35-36	PU	48-7523ea.	3.00
37-38	PU	78-7523ea.	3.00
39	PU	91A-7523ea.	3.00
39-47	Truck	91T-7523ea.	6.00
40-41	PU	01A-7523ea.	4.00
42-47	PU	91T-7523ea.	6.00
48-52	PU	7RT-7523ea.	3.75
53-56	PU	TAAA-7523-Aea.	4.00

Clutch Pedal Seal/Bumpers



32-34	Pass	B-35184pr.	4.00
35-38	Pass	48-700386, w/screwspr.	3.75
37-48	Pass	91A-7527pr.	8.00
49-51	Pass	8A-2476-Apr.	5.00
49-51	Pass	8A-3512, goes under metal plateea.	5.00
39-48	Merc	91A-7527pr.	8.00
49-51	Merc	8M-2476pr.	40.50
32-39	PU	B-35184, push in typepr.	4.00
35-38	PU	48-700386, w/screwspr.	3.75
37-47	PU	91A-7527pr.	8.00
48-56	PU	7C-2473, arm bumperspr.	4.00

HOLE COVERS & SEALS

Steel Transmission Hole Cover



*37-38	Pass	78-7012108-NH, no hole.....ea.	50.00
*35-37	PU	50-7012108-NH, no hole.....ea.	75.00
*38-39	PU	81C-7012108-NH, no hole.....ea.	75.00
*40-47	PU	01C-7012108-NH, no hole.....ea.	85.00
*48-52	PU	7C-8112108-A, no hole.....ea.	133.00
*53-56	PU	BAAA-8112108-NH, no hole.....ea.	59.00

Transmission Hole Cover Screws

33-34	Pass	3142.....kit.	3.00
35-36	Pass	3143.....kit.	3.00
37-40	Pass	3144.....kit.	2.50

Transmission Floor Cover to Floor Pan Seal



37-40	Pass	78-7012125pr.	6.00
40-47	PU	01C-8112125ea.	15.00
48-52	PU	7C-8112125-S.....ea.	20.00

Transmission Floor Cover to Transmission Seal

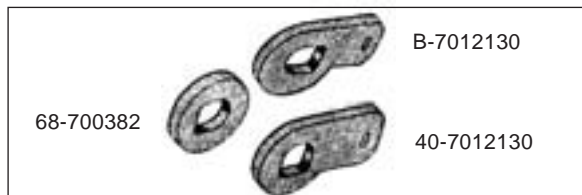

32	Pass	B-7012130ea.	10.00
33-36	Pass	40-7012130ea.	10.00
36-39	Pass	68-700382, orig. style.....ea.	15.00
37-39	Pass	78-7012130ea.	10.00
42-47	PU	51C-8112130ea.	15.00
48-52	PU	7C-8112130, floor shift transea.	10.00

Transmission Inspection Hole Grommet



49-50	Pass	8A-7012115-S.....pr.	5.50
51	Pass	1A-7012115-S.....set.	6.50

OVERDRIVE

For wiring harnesses, see Section 25

Overdrive Relay



49-51	Pass	8M-6915, good used.....ea.	160.00
51-53	Pass	1M-6915-A, good used.....ea.	220.00
56	Pass	B6A-6915, good used.....ea.	210.00
51-53	Merc	1M-6915-A, good used.....ea.	220.00
53-55	PU	8M-6915, good used.....ea.	160.00
56	PU	B6A-6915, good used.....ea.	210.00

Overdrive Solenoid



49-55	Pass	FAA-6916-A, good used.....ea.	225.00
56	Pass	B6A-6916-A, good used.....ea.	210.00
53-55	PU	FAA-6916-A, good used.....ea.	225.00
56	PU	B6A-6916-A, good used.....ea.	210.00

Overdrive Lock-out Switch/Governor

49-50	Pass	8M-6917-A, good used.....ea.	75.00
49-50	Merc	8M-6917-A, good used.....ea.	75.00

Overdrive Kick-Down Switch



49-56	Pass	8A-6918-Bea.	31.00
49-56	Merc	8A-6918-Bea.	31.00
53-56	PU	8A-6918-Bea.	31.00



Overdrive Sun Gear



49-56 Pass 56H-7670.....ea. 40.00

Overdrive Cable

Tech Tip: Never pull or push the overdrive cable (A9AZ-7A650-A) while the vehicle is moving, serious damage will result.

Dash bracket not included. Cut to fit.



49-56 Pass A9AZ-7A650-A.....ea. 50.00
 53-56 PU A9AZ-7A650-A.....ea. 50.00

Overdrive Cable Pull Knob

Chrome knob with "Overdrive".

49-56 Pass A9AZ-7A650-K.....ea. 20.00
 53-56 PU A9AZ-7A650-K.....ea. 20.00

Overdrive Cable Bracket

Holds cable to steering column.

49-52 Pass 8A-7713.....ea. 5.00

AUTOMATIC

Dipstick (Ford-O-Matic)



55-58 Pass B5AZ-7A020-A.....ea. 34.95
 55-57 T-Bird B5AZ-7A020-A.....ea. 34.95

Flexplate Ring Gear w/Fordomatic Trans.

53-62 PU 1P-7950-E, 6 cyl.....ea. 45.00
 54-64 PU B5A-7950-A, V-8.....ea. 45.00

Transmission Pan Gasket

55-59 Pass & PU B5AZ-7A191-A, w/3 spd, w/14 bolt pan.....ea. 8.50

Section 14 Cooling

WATER PUMP

New Water Pumps

Tech Tip: When replacing water pumps on 37-53 flatheads, look inside the water pump outlet pipe for the last bolt!



37-48 Pass 78-8502-B, V-8, LH, bearing type.....ea. 75.00
 37-48 Pass 78-8501-PR, V-8, bearing typepr. 130.00
 37-48 Pass 78-8501-B, V-8, RH, bearing typeea. 75.00
 46 Pass 5GA-8501, 6 cyl.....ea. 95.00
 49 Pass 8BA-8501-LB, V-8, LH, wide belt, bearing typeea. 90.00
 49 Pass 8BA-8501-RB, V-8, RH, wide belt, bearing typeea. 90.00
 49-51 Pass 0HA-8501, 6 cyl, NOS.....ea. 115.00
 50-53 Pass EAB-8501-LN, V-8, LH.....ea. 80.00
 50-53 Pass EAB-8501-RN, V-8, RH.....ea. 80.00
 52-53 Pass B2A-8501-A, 6 cyl.....ea. 90.00
 54 Pass B4A-8501-A, 239.....ea. 100.00
 54-56 Pass B6C-8501-CN, 6 cyl.....ea. 70.00



55-56 Pass B6A-8501-BN, V-8, 272, 292, 312.....ea. 85.00
 39-48 Merc 78-8501-PR, V-8, bearing typepr. 130.00
 39-48 Merc 78-8501-B, V-8, RH, bearing typeea. 75.00
 39-48 Merc 78-8502-B, V-8, LH, bearing type.....ea. 75.00
 52-53 Merc EAB-8501-LN, V-8, LH.....ea. 80.00
 52-53 Merc EAB-8501-RN, V-8, RH.....ea. 80.00
 55-57 T-Bird B6A-8501-BN, V-8, 272, 292, 312.....ea. 85.00
 37-47 PU 78-8501-PR, V-8, bearing typepr. 130.00



37-47	PU	78-8501-B, V-8, RH, bearing type	ea.	75.00
37-47	PU	78-8502-B, V-8, LH, bearing type	ea.	75.00
46	PU	5GA-8501, 6 cyl	ea.	95.00
48-52	PU	8RT-8501-L, V-8, LH	ea.	114.00
48-52	PU	8RT-8501-R, V-8, RH	ea.	114.00
53	PU	EAB-8501-LN, V-8, narrow belt, LH	ea.	80.00
53	PU	EAB-8501-RN, V-8, narrow belt, RH	ea.	80.00
54-64	PU	B6C-8501-CN, 6 cyl	ea.	70.00
55	PU	B5C-8501, V-8	ea.	130.00

Rebuilt Water Pumps

Please check with us to see if we have cores available. We might need your core to rebuild.

33-36	Pass	68-8502, V-8	ea.	190.00
42	Pass	2GA-8501, 6 cyl.	ea.	75.00
47-48	Pass	7HA-8501, 6 cyl. late 47	ea.	155.00
49	Merc	8M-8501-L, LH	ea.	190.00
49	Merc	8M-8501-R, RH	ea.	190.00
50-51	Merc	8CM-8501-L, LH	ea.	190.00
50-51	Merc	8CM-8501-R, RH	ea.	190.00
33-36	PU	68-8502, V-8	ea.	190.00
42	PU	2GA-8501, 6 cyl.	ea.	75.00
47-51	PU	7HA-8501, 6 cyl. late 47	ea.	155.00
54	PU	B4C-8501, 239	ea.	110.00
56	PU	B6C-8501-B, 272, 292, 312	ea.	145.00

Stainless Water Pump Bolts

Includes enough for both sides, with lock washers.

37-48	Pass	78-8501-HK	set.	11.00
39-48	Merc	78-8501-HK	set.	11.00
37-47	PU	78-8501-HK	set.	11.00

Water Pump Rebuilding Kit



32-34	Pass	B-8591-ST, 4 cyl. w/steel shaft	kit.	85.00
32-34	Pass	B-8591-SS, 4 cyl. w/SS shaft	kit.	87.50
32-36	Pass	68-8591, V-8	kit.	30.00
37-48	Pass	78-8591, V-8	kit.	25.00
37-48	Pass	79-8591, V-8, bearing type pump	kit.	30.00
47-51	Pass	7HA-8591, 6 cyl.	kit.	55.00

50-53	Pass	A8C-8591, V-8, bearing type	kit.	27.95
54-56	Pass	B5A-8591-C, 272, 292, 312	kit.	35.00
39-48	Merc	78-8591	kit.	25.00
39-48	Merc	79-8591, bearing type pump	kit.	30.00
50-53	Merc	A8C-8591	kit.	27.95



55-56	Merc	B5A-8591-C	kit.	35.00
32-34	PU	B-8591-ST, 4 cyl. w/steel shaft	kit.	85.00
32-34	PU	B-8591-SS, 4 cyl. w/SS shaft	kit.	87.50
32-36	PU	68-8591, V-8	kit.	30.00
37-47	PU	78-8591, V-8	kit.	25.00
37-47	PU	79-8591, V-8, bearing type pump	kit.	30.00
47-51	PU	7HA-8591, 6 cyl.	kit.	55.00
48-53	PU	A8C-8591, V-8	kit.	27.95



56-62	PU	B6C-8591-A, V-8, 272, 292 312	kit.	15.00
-------	----	-------------------------------------	------	-------

Water Pump Impeller

48-53	PU	7RA-8512-C, V8, NOS	ea.	16.50
-------	----	---------------------------	-----	-------

Water Pump Gasket

32-36	Pass	B-8507, V-8	ea.	2.00
37-53	Pass	8BA-8507, cut to fit 37-48, V-8	ea.	3.00
39-53	Merc	8BA-8507, cut to fit 39-48	ea.	3.00
32-36	PU	B-8507, V-8	ea.	2.00
37-53	PU	8BA-8507, cut to fit 37-48, V-8	ea.	3.00

Water Pump Pulley

37-48	Pass	78-8509, V-8	ea.	13.00
49	Pass	8RT-8509-A, V-8	ea.	15.00

Section 14 - Cooling



C&G Early Ford Parts, Inc.

50-53	Pass	8BA-8509-B, V-8, RH, thin type	ea.	15.00
50-53	Pass	B8AZ-8509-B, V-8, LH, thin type.....	ea.	15.00
39-48	Merc	78-8509	ea.	13.00
52-53	Merc	8BA-8509-B, RH, thin type	ea.	15.00
52-53	Merc	B8AZ-8509-B, LH, thin type	ea.	15.00
37-48	PU	78-8509, V-8	ea.	13.00
48-52	PU	8RT-8509-A, V-8.....	ea.	15.00

Water Pump Grease Fitting



28-36	Pass & PU	1188, brass.....	ea.	3.00
-------	-----------	------------------	-----	------

Water Bypass Tube

For the following engine sizes: 272, 292, 312



55-56	Pass	C2TZ-8548-B	ea.	11.00
55-56	Merc	C2TZ-8548-B	ea.	11.00
55-56	PU	C2TZ-8548-B	ea.	11.00

Water Bypass Tube Gasket

For the following engine sizes: 272, 292, 312

54-56	Pass	EAN-8563-B.....	ea.	1.00
54-56	Merc	EAN-8563-B.....	ea.	1.00
54-56	PU	EAN-8563-B.....	ea.	1.00

RADIATORS

Four Row New Radiator

Must supply the radiator hose dimensions for upper and lower hose. These are special order and can take 6 to 12 weeks to get. Shipped direct from manufacturer.



*49-51	Pass	8BA-8005-A, V8	ea.	460.00
*52-53	Pass	B2A-8005-A, V8	ea.	460.00
*52-53	Pass	B2A-8005-C, V8.....	ea.	535.00

*54-56	Pass	B6A-8005-A, V8	ea.	510.00
*49-51	Merc	1M-8005-A	ea.	685.00
*55-57	T-Bird	B5S-8005-A.....	ea.	510.00
*48-52	PU	7RT-8005-A, V8.....	ea.	515.00
*53	PU	BAAA-8005-A, V8.....	ea.	515.00
*54-56	PU	B6C-8005-A, V8.....	ea.	515.00

Radiator Core Support

*53-56	PU	B3C-16138-B.....	ea.	225.00
--------	----	------------------	-----	--------

RADIATOR CAPS

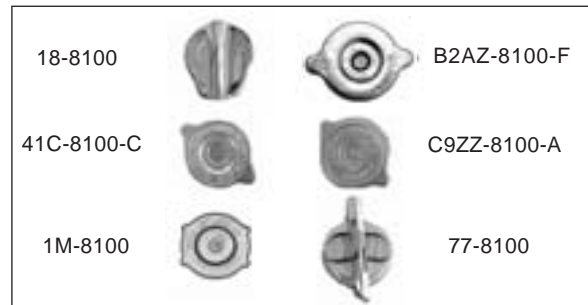

Radiator Cap

32	Pass	B-8100	ea.	40.00
33	Pass	18-8100	ea.	40.00
34	Pass	40-8100	ea.	40.00
37-48	Pass	78-8100-A, no pressure	ea.	10.00
37-48	Pass	78-8100-B, 4lb., orig type	ea.	25.00
37-48	Pass	41C-8100-C, 4 lb.pressure	ea.	8.00
37-48	Pass	41C-8100-7, 7 lb.pressure	ea.	7.00
37-48	Pass	41C-8100-RS7, 7 lb. pressure, w/reservoir system.....	ea.	10.00
37-48	Pass	41C-8100-10, 10 lb. pressure.....	ea.	7.00
37-48	Pass	41C-8100-RS10, 10 lb. pressure w/reservoir system.....	ea.	10.00
49-54	Pass	1M-8100, 1", 7 lb. pressure	ea.	7.50
49-54	Pass	B2AZ-8100-C, 3/4" 7 lb pressure w/release	ea.	10.00
49-54	Pass	B2AZ-8100-F, 3/4", 7 lb pressure.....	ea.	10.00
55-56	Pass	C9ZZ-8100-A, chrome, 14 lb.	ea.	18.95
39-48	Merc	78-8100-A, no pressure	ea.	10.00
39-48	Merc	78-8100-B, 4lb., orig type	ea.	25.00
39-48	Merc	41C-8100-C, 4 lb.pressure.....	ea.	8.00
39-48	Merc	41C-8100-7, 7 lb.pressure	ea.	7.00
39-48	Merc	41C-8100-RS7, 7 lb. pressure, w/reservoir system.....	ea.	10.00
39-48	Merc	41C-8100-10, 10 lb. pressure.....	ea.	7.00
39-48	Merc	41C-8100-RS10, 10 lb. pressure w/reservoir system.....	ea.	10.00
49-54	Merc	1M-8100, 1", 7 lb. pressure	ea.	7.50

55-57	T-Bird	C9ZZ-8100-A, chrome, 14 lb.	ea.	18.95
32	PU	B-8100	ea.	40.00
33	PU	46-8100-A.....	ea.	40.00
34-36	PU	46-8100-B.....	ea.	40.00
34-36	Truck	46-8100-B.....	ea.	40.00
37	PU	77-8100, requires 78-8100-B.....	ea.	55.00
37-47	PU	78-8100-A, no pressure	ea.	10.00
37-47	PU	78-8100-B, 4lb., orig type	ea.	25.00
37-50	PU	41C-8100-C, 4 lb.pressure.....	ea.	8.00
37-50	PU	41C-8100-7, 7 lb.pressure	ea.	7.00
37-50	PU	41C-8100-RS7, 7 lb. pressure, w/reservoir system.....	ea.	10.00
37-50	PU	41C-8100-10, 10 lb. pressure.....	ea.	7.00
37-50	PU	41C-8100-RS10, 10 lb. pressure, w/reservoir system.....	ea.	10.00
51-62	PU	B2AZ-8100-C, ¾" 7 lb pressure w/release	ea.	10.00
51-62	PU	B2AZ-8100-F, ¾", 7 lb pressure.....	ea.	10.00

Chrome Quail Radiator Cap



32	Pass	B-18385-CH	ea.	59.00
----	------	------------------	-----	-------

Greyhound Radiator Cap

Requires #B-8100-RK radiator cap repair kit



32	Pass	B-18390	ea.	99.50
33	Pass	40-18390-A.....	ea.	99.50
34	Pass	40-18390-B.....	ea.	99.50
34-36	PU	46-18390.....	ea.	99.50

Radiator Cap Repair Kit

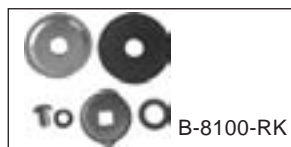

32-34	Pass	B-8100-RK.....	kit.	25.00
32-36	PU	B-8100-RK.....	kit.	25.00

HOSES

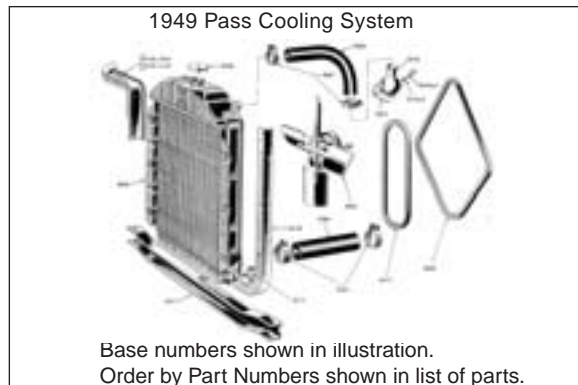

Script Radiator Hose & Clamp Kit

Includes upper & lower hoses w/clamps

32-36	Pass	18-8260-S, V-8	kit.	60.00
49-53	Pass	1BA-8285-S, V-8.....	kit.	60.00
49-53	Merc	1BA-8285-S	kit.	60.00
32-36	PU	18-8260-S, V-8	kit.	60.00

Radiator Hose & Clamp Kit

Includes upper & lower hoses w/clamps

32-34	Pass	B-8260-K, 4 cyl.	kit.	25.00
32-36	Pass	18-8260-K, V-8	kit.	35.00
32-34	PU	B-8260-K, 4 cyl.	kit.	25.00
32-36	PU	18-8260-K, V-8	kit.	35.00

T-Bird Radiator Hoses

55-57	T-Bird	B5S-8260-K, w/script	pr.	55.00
-------	--------	----------------------------	-----	-------

Upper Radiator Hose with Ford Script

For V-8's only.



37-38	Pass	78-8260	pr.	55.00
39	Std Pass	78-8260	pr.	55.00
39	Dlx Pass	91A-8260	pr.	55.00
40-41	Pass	91A-8260	pr.	55.00
42-48	Pass	21A-8260	pr.	55.00
49-53	Pass	1BA-8260.....	pr.	35.00
39-41	Merc	91A-8260	pr.	55.00
42-48	Merc	21A-8260	pr.	55.00
49-53	Merc	1BA-8260.....	pr.	35.00
40-41	PU	91A-8260	pr.	55.00



Upper Radiator Hose



32-36	Pass	18-8260, 8 cyl.....ea.	11.00
33-36	Pass	7241, w/37-48 V-8 engineea.	18.00
49-51	Pass	B7A-8260, 6 cyl.ea.	23.00
52-56	Pass	AB-8260-A, 6 cyl., moldedea.	16.00
54	Pass	B7A-8260, V-8.....ea.	23.00
55-56	Pass	B5A-8260-B, V-8, moldedea.	14.00
54-56	Merc	B7A-8260ea.	23.00
33-36	PU	7241, w/37-48 V-8 engineea.	18.00
48-52	PU	7C-8260, V-8, flexible, replacement, 2 req'd.....ea.	15.00
55	PU	60017, 6 cyl.ea.	15.00

Upper Radiator Pipe

Rubber hoses are NOT included.



48-52	PU	8RT-8290, V8, plainpr.	29.00
48-52	PU	8RT-8290-C, V8, chromepr.	75.00

Chrome Upper Radiator Hose Kit

Includes upper chrome pipes, rubber hoses and clamps for one engine.

37-38	Pass	78-8260-CHkit.	65.00
39	Std Pass	78-8260-CHkit.	65.00
39	Dlx Pass	91A-8260-CHkit.	70.00
40-41	Pass	91A-8260-CHkit.	70.00
42-48	Pass	78-8260-CHkit.	65.00
49-53	Pass	1BA-8260-CH.....kit.	65.00
39-41	Merc	91A-8260-CHkit.	70.00
42-48	Merc	78-8260-CHkit.	65.00
49-53	Merc	1BA-8260-CH.....kit.	65.00

"I wanted to write and thank you sooner, but just hadn't gotten the chance. You may remember sending a gas tank for a 56 Ford to Iowa and writing 'Happy 31st Anniversary Dad & Mom' on the outside of the box. Well, just wanted to say thank you, thank you!!! The extra special touch was very much appreciated and dad loves the gas tank!"
Sincerely,
Connie B., Iowa

37-39	PU	78-8260-CHkit.	65.00
-------	----	----------------------	-------

40-41	PU	91A-8260-CHkit.	70.00
42-47	PU	78-8260-CHkit.	65.00

Lower Radiator Hose with Ford Script

For V-8's only.



39	Dlx Pass	91A-8286-S.....pr.	40.00
40-41	Pass	91A-8286-S.....pr.	40.00
49-53	Pass	8BA-8286-B.....pr.	25.00
39-41	Merc	91A-8286-S.....pr.	40.00
49-53	Merc	8BA-8286-B.....pr.	25.00
40-41	PU	91A-8286-S.....pr.	40.00

Lower Radiator Hose

32-36	Pass	78-8286, V8.....pr.	16.00
-------	------	---------------------	-------



37-38	Pass	78-8286pr.	16.00
39	Std Pass	78-8286pr.	16.00
39	Dlx Pass	91A-8286pr.	25.00
40-41	Pass	91A-8286pr.	25.00
42-48	Pass	78-8286pr.	16.00
49-53	Pass	AB-8286-A, 6 cyl.ea.	17.50
54	Pass	B4A-8286-A, V8, cut to fitea.	12.00
54-56	Pass	B5A-8286-C, 6 cyl.ea.	16.00
55-56	Pass	B6A-8286-B, V-8.....ea.	15.00
39-41	Merc	91A-8286pr.	25.00
42-48	Merc	78-8286pr.	16.00
55-56	Merc	MC-8286-Aea.	15.00
32-36	PU	78-8286, V8.....pr.	16.00
40-41	PU	91A-8286pr.	25.00
53	PU	TAAA-8286-A, 6 cyl.....ea.	14.00
55	PU	52816, 6 cyl.ea.	15.00

Red Line Coolant Additive

This additive helps lower the coolant temperature in your vehicle. Two 12 oz. bottles recommended per vehicle.

Tech Tip: Anti-freeze is not a sufficient coolant, drain your cooling system and add two bottles of water-wetter with distilled water. Always ensure you have a good radiator cap and thermostats, your vehicle could run up to 20 degrees cooler.



All Pass & PU WATER-WETTER, 12oz.....ea. 10.95

CLAMPS

Radiator Hose Clamps



32-36	Pass	B-8287-A12, V-8, 4 upper & 4 lower req'd.....ea.	3.00
37-48	Pass	B-8287-A12, V-8, 2 upper & 4 lower req'd.....ea.	3.00
39-48	Pass	B-8261-A15, V-8, 2 upper req'd.....ea.	3.00
49-53	Pass	8BA-8287, V-8 & 6 cyl., 4 upper req'd.....ea.	1.50
49-59	Pass	B-8287-A12, 6 cyl., 2 lower req'd.....ea.	3.00
54-59	Pass	AB-8287, V-8 & 6 cyl., 2 upper req'd.....ea.	1.50
39-48	Merc	B-8287-A12, 2 upper & 4 lower req'd.....ea.	3.00
39-48	Merc	B-8261-A15, 2 upper req'd.....ea.	3.00
49-53	Merc	8BA-8287, 4 upper req'd.....ea.	1.50
54-59	Merc	AB-8287, 2 upper req'd.....ea.	1.50
32-36	PU	B-8287-A12, V-8, 4 upper & 4 lower req'd.....ea.	3.00
37-48	PU	B-8287-A12, V-8, 2 upper & 4 lower req'd.....ea.	3.00
39-48	PU	B-8261-A15, V-8, 2 upper req'd.....ea.	3.00
49-53	PU	8BA-8287, V-8 & 6 cyl., 8 upper req'd.....ea.	1.50
49-59	PU	B-8287-A12, 6 cyl., 2 lower req'd.....ea.	3.00
54-59	PU	AB-8287, V-8 & 6 cyl., 2 upper req'd.....ea.	1.50

Heater Hose Clamps for 5/8" Hose



All Pass & PU BPA-18572-A,
4 or 6 req'd.....ea. 1.00

THERMOSTAT

Thermostats

Tech Tip: Due to the flathead engines tendency to run hot, we always recommend using 160 degree thermostats (11A-8575 or 1BA-8575-A).



1BA-8575-A

37-48	Pass	11A-8575, V-8, 160 degree.....ea.	10.00
37-48	Pass	11A-8575-BHT, V-8, 180 degree.....ea.	10.00
41-47	Pass	1GA-8575, 6 cyl, 160 degree.....ea.	15.00
47-56	Pass	C2AZ-8575-A, 6 cyl., 180 degree.....ea.	6.00
47-56	Pass	C2AZ-8575-B, 6 cyl., 160 degree.....ea.	6.00
49-53	Pass	1BA-8575-A, V-8, 160 degree.....ea.	6.00
49-53	Pass	1BA-8575-B, V-8, 180 degree.....ea.	6.00
54-56	Pass	C2AZ-8575-A, V-8, 180 degree.....ea.	6.00
54-56	Pass	C2AZ-8575-B, V-8, 160 degree.....ea.	6.00
39-48	Merc	11A-8575, V-8, 160 degree.....ea.	10.00
39-48	Merc	11A-8575-BHT, V-8, 180 degree.....ea.	10.00
49-53	Merc	1BA-8575-A, V-8, 160 degree.....ea.	6.00
49-53	Merc	1BA-8575-B, V-8, 180 degree.....ea.	6.00
54-56	Merc	C2AZ-8575-A, V-8, 180 degree.....ea.	6.00
54-56	Merc	C2AZ-8575-B, V-8, 160 degree.....ea.	6.00
37-47	PU	11A-8575, V-8, 160 degree.....ea.	10.00
37-47	PU	11A-8575-BHT, V-8, 180 degree.....ea.	10.00
47-56	PU	C2AZ-8575-A, 6 cyl., 180 degree.....ea.	6.00
47-56	PU	C2AZ-8575-B, 6 cyl., 160 degree.....ea.	6.00
48-53	PU	1BA-8575-A, V-8, 160 degree.....ea.	6.00
48-53	PU	1BA-8575-B, V-8, 180 degree.....ea.	6.00
54-64	PU	C2AZ-8575-A, V-8, 180 degree.....ea.	6.00
54-56	PU	C2AZ-8575-B, V-8, 160 degree.....ea.	6.00

Thermostat (Water Outlet) Housing



1BA-8592 1BA-8592-PA EAA-8592 B5C-8592

49-53	Pass	1BA-8592, V-8, cast iron.....ea.	15.50
49-53	Pass	1BA-8592-PA, V-8, polished alum.....ea.	13.00
52-56	Pass	EAA-8592, 215 & 223.....ea.	17.00
55-56	Pass	B5A-8592-A, 272, 292, 312.....ea.	38.00
49-53	Merc	1BA-8592, cast iron.....ea.	15.50



49-53	Merc	1BA-8592-PA, polished alum.ea.	13.00
55-56	Merc	B5A-8592-Aea.	38.00
48-53	PU	1BA-8592, V-8, cast iron.....ea.	15.50
48-53	PU	1BA-8592-PA, V-8, polished alum.....ea.	13.00

Thermostat Housing Gasket

47-51	Pass	7HA-8255, 6 cyl.ea.	1.75
49-53	Pass	8BA-8255-B, V-8ea.	2.00
52-56	Pass	EAG-8255, 6 cyl.ea.	3.00
54-56	Pass	B5A-8255, V-8.....ea.	3.00
49-53	Merc	8BA-8255-Bea.	2.00
54-56	Merc	B5A-8255ea.	3.00
47-51	PU	7HA-8255, 6 cyl.ea.	1.75
48-53	PU	8BA-8255-B, V-8ea.	2.00
52-56	PU	EAG-8255, 6 cyl.ea.	3.00
54-56	PU	B5A-8255, V-8.....ea.	3.00

FAN

Electric Fan

Fans listed are for 3-core radiators.

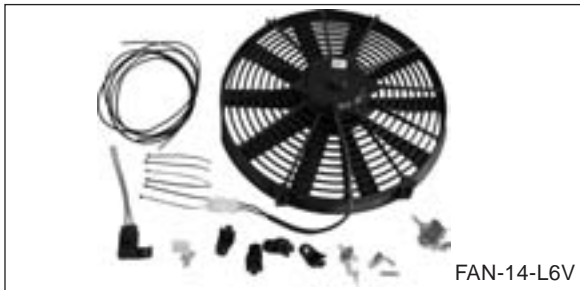

FAN-14-L6V

All	Pass & PU	FAN-14-L6V, 14", 6V, pullea.	192.50
All	Pass & PU	FAN-14-S6V, 14", 6V, pushea.	192.50
All	Pass & PU	FAN-16-L6V, 16", 6V, pullea.	192.50
All	Pass & PU	FAN-16-S6V, 16", 6V, pushea.	192.50
All	Pass & PU	FS-14A-2, 14", 12V, push w/2" motorea.	150.00
All	Pass & PU	FS-14B-2, 14", 12V, pull w/2" motorea.	150.00
All	Pass & PU	FS-14AS-3.5, 14", 12V, push w/3-1/2" motor.....ea.	233.50
All	Pass & PU	FS-14BS-3.5, 14", 12V, pull, w/3-1/2" motor.....ea.	233.50
All	Pass & PU	FS-16A-2, 16", 12V, push w/2" motorea.	150.00
All	Pass & PU	FS-16B-2, 16", 12V, pull w/2" motor.....ea.	150.00
All	Pass & PU	FS-16B-2.5, 16" 12V, push w/2-1/2" motor.....ea.	192.50
All	Pass & PU	FS-16B-2, .5, 16", 12V, pull w/2.5" motor.....ea.	150.00
All	Pass & PU	FS-16AS-3.5, 16" 12V, push w/3-1/2" motor.....ea.	233.50
All	Pass & PU	FS-16BS-3.5, 16", 12V, pull w/3-1/2" motorea.	233.50

Rebuilt Fan Hub Assembly

The core charge will apply if you do not send in your fan hub prior to placing your order, or if it is not rebuildable. Please do not send in the fan. We only need the hub assembly. Must fill with SAE 20 oil after assembly.



21A-8604

42-49	Pass	21A-8604, V-8ea.	145.00
42-49	Pass	21A-8604-CORE, core chargeea.	100.00
42-48	Merc	21A-8604ea.	145.00
42-48	Merc	21A-8604-CORE, core chargeea.	100.00
42-52	PU	21A-8604, V-8ea.	145.00
42-52	PU	21A-8604-CORE, core chargeea.	100.00

Fan Spindle Bearing



21A-8626

42-49	Pass	21A-8626, V-8ea.	20.00
42-48	Merc	21A-8626ea.	20.00
42-52	PU	21A-8626, V-8ea.	20.00

Fan Hub

42-49	Pass	21A-8603, V-8ea.	45.00
42-48	Merc	21A-8603ea.	45.00
42-52	PU	21A-8603, V-8ea.	45.00

Fan Mounting Bracket

42-49	Pass	21A-8632, V-8ea.	20.00
42-48	Merc	21A-8632ea.	20.00
42-52	PU	21A-8632, V-8ea.	20.00

Fan Hub Spacer Gasket

42-49	Pass	21A-8638, V-8ea.	2.00
42-48	Merc	21A-8638ea.	2.00
42-52	PU	21A-8638, V-8ea.	2.00

Fan Rear Hub Gasket

42-49	Pass	21A-8646, V-8ea.	1.25
42-48	Merc	21A-8646ea.	1.25
42-52	PU	21A-8646, V-8ea.	1.25

Fan & Generator Belts

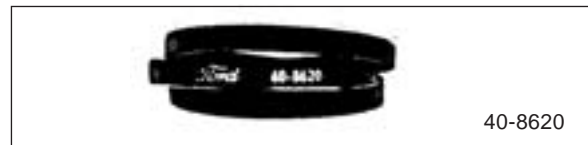

40-8620

28-34	Pass	A-8620, 4 cyl., w/scriptea.	16.00
32	Pass	18-8620, V-8, w/scriptea.	18.50
33-36	Pass	40-8620, V-8, w/scriptea.	21.00

37-41	Pass	78-8620-A, w/script, gen./fan.....ea.	20.00
37-41	Pass	78-8620-R, gen./fan.....ea.	14.00
42-48	Pass	78-8620-C, V-8, gen., w/script.....ea.	20.00
42-48	Pass	78-8620-R, gen., V-8.....ea.	14.00
42-49	Pass	21A-8577-S, V-8, w/script, fan.....ea.	18.00
42-49	Pass	21A-8577, V-8, fan.....ea.	13.00
49	Pass	7RA-8620, V-8, gen.....ea.	18.00
49-51	Pass	8BA-8577, 6 cyl.....ea.	15.00
50-53	Pass	8BA-8577, V-8, gen.....ea.	15.00
50-53	Pass	8BA-8620, V-8, thin type, fan.....ea.	15.00
52-56	Pass	7370-8620, 6 cyl., fan.....ea.	12.50
54	Pass	8435-8620, V-8, gen.....ea.	14.00
55	Pass	9447-8620, fan/gen.....ea.	19.00
56	Pass	9451-8620, V8 fan/gen.....ea.	21.50
39-41	Merc	78-8620-A, gen., w/script.....ea.	20.00
42-48	Merc	78-8620-C, gen., w/script.....ea.	20.00
42-49	Merc	21A-8577-S, w/script, fan.....ea.	18.00
49	Merc	7RA-8620, gen.....ea.	18.00
50-53	Merc	8BA-8577, gen.....ea.	15.00
50-53	Merc	8BA-8620, fan.....ea.	15.00
55-56	Merc	9451-8620, fan/gen.....ea.	21.50
28-34	PU	A-8620, 4 cyl., w/script.....ea.	16.00
32	PU	18-8620, V-8, w/script.....ea.	18.50
33-36	PU	40-8620, V-8, w/script.....ea.	21.00
37-41	PU	78-8620-A, w/script, gen./fan.....ea.	20.00
37-41	PU	78-8620-R, gen./fan.....ea.	14.00
42-47	PU	78-8620-C, V-8, gen., w/script.....ea.	20.00
42-47	PU	78-8620-R, gen., V-8.....ea.	14.00
42-53	PU	21A-8577-S, V-8, w/script, fan.....ea.	18.00
42-53	PU	21A-8577, V-8, fan.....ea.	13.00
47-51	PU	7HT-8620, 6 cyl., fan.....ea.	17.50
48-53	PU	7RA-8620, V-8, gen.....ea.	18.00
52-56	PU	7370-8620, 6 cyl., fan.....ea.	12.50
53	PU	8BA-8577, V-8, gen.....ea.	15.00
53	PU	8BA-8620, V-8, thin type, fan.....ea.	15.00
54	PU	8435-8620, V-8, gen.....ea.	14.00
54-55	PU	600-8620, V-8, fan.....ea.	15.00
55	PU	7430-8620, gen.....ea.	11.50
56	PU	9451-8620, V8 fan/gen.....ea.	21.50

RADIATOR MOUNT/PARTS

Radiator to Frame Mounting Kit

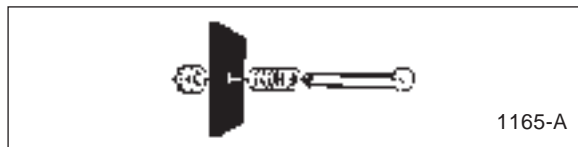

28-48	Pass	1165A.....kit.	5.00
39-48	Merc	1165A.....kit.	5.00
28-47	PU	1165A.....kit.	5.00

Stainless Radiator to Frame Mounting Kit

32-48	Pass	SS-1165A.....set.	19.00
39-48	Merc	SS-1165A.....set.	19.00
28-47	PU	SS-1165A.....set.	19.00

Radiator Support to Frame Pad & Bolt Kit

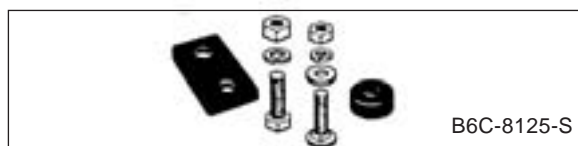

53-55	PU	BAAA-8125-S.....kit.	20.00
56	PU	B6C-8125-S.....set.	20.00

Radiator Support to Frame Pad



32-48	Pass	40-8125-S.....pr.	1.00
49-53	Pass	8A-8125.....ea.	4.00
54-56	Pass	AD-8125-B.....ea.	4.00
39-48	Merc	40-8125-S.....pr.	1.00
32-47	PU	40-8125-S.....pr.	1.00
48-52	PU	8C-8124A.....ea.	3.00

Radiator Support Rods

32-36	Pass	B-8133-S, black.....pr.	19.95
32-39	PU	B-8133-S, black.....pr.	19.95

Stainless Radiator Support Rods

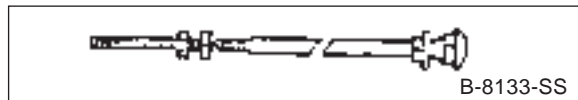

32-36	Pass	B-8133-SS, 31-1/2".....pr.	50.00
32-36	Pass	U-8133-SS, 35" for hotrods or non-Ford cars and trucks.....pr.	50.00
32-39	PU	B-8133-SS, 31-1/2".....pr.	50.00
32-39	PU	U-8133-SS, 35" for hotrods or non-Ford cars and trucks.....pr.	50.00

Stainless Radiator Support Rods w/Thread Covers

32-36	Pass	B-8133-SSC.....pr.	50.00
32-39	PU	B-8133-SSC.....pr.	50.00



Stainless Radiator Support Rods/Hood Prop Kit

Kit includes radiator support rods with covers, firewall brackets, and hood support kit, all in polished stainless.

32	Pass	B-8133-SKkit.	125.00
33-36	Pass	40-8133-SKkit.	125.00
32-34	PU	B-8133-SKkit.	125.00
35-37	PU	40-8133-SKkit.	125.00

Stainless Radiator Support Rod Firewall Brackets

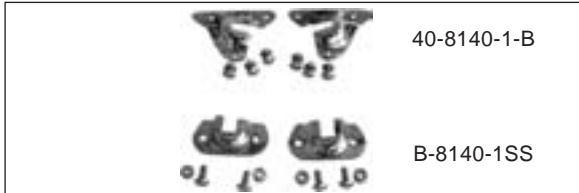

28-32	Pass	B-8140/1SSpr.	30.00
33-39	Pass	40-8140/1-Bpr.	30.00
28-34	PU	B-8140/1SSpr.	30.00
35-37	PU	40-8140/1-Bpr.	30.00

Radiator Support Rod Bushings

35-36	Pass	40-5283/4-2pr.	10.00
-------	------	-------------	----------	-------

Radiator to Inner Fender Brackets



39	Dlx Pass	91A-8046pr.	30.00
39	Dlx Pass	91A-8046-SS, stainlesspr.	40.00
40	Pass	91A-8046pr.	30.00
40	Pass	91A-8046-SS, stainlesspr.	40.00
39-40	Merc	91A-8046pr.	30.00
39-40	Merc	91A-8046-SS, stainlesspr.	40.00
40-41	PU	91A-8046pr.	30.00
40-41	PU	91A-8046-SS, stainlesspr.	40.00

Grille to Radiator Mounting Kit

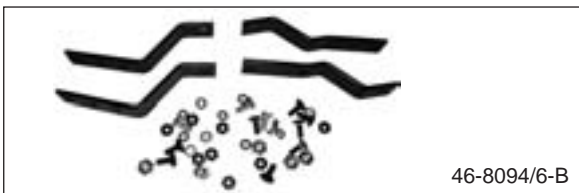

33-34	PU	46-8094/6-Bkit.	35.00
-------	----	-------------	-----------	-------

Grille to Radiator Bolt Set

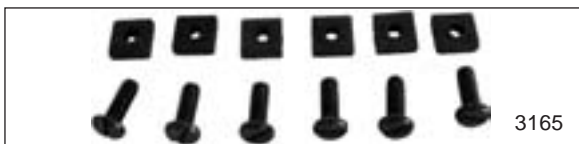

35-37	PU	3165set.	2.50
-------	----	------	-----------	------

Radiator Drain Cock



35-48	Pass	48-8115ea.	25.00
49-56	Pass	8A-8115, 1/4" threadea.	4.00
39-48	Merc	48-8115ea.	25.00
49-53	Merc	8CM-8115-A, 1/4" thread w/right angleea.	6.50
35-47	PU	48-8115ea.	25.00
48-56	PU	8A-8115, 1/4" threadea.	4.00
48-72	PU	8CM-8115-A, 1/4" thread w/right angleea.	6.50

RADIATOR PARTS/SEALS

Headlight Wire Crossover Channel



39-40	Pass	91A-8005-WBea.	40.00
39-40	Merc	91A-8005-WBea.	40.00
40	PU	91A-8005-WBea.	40.00

Radiator Splash Shield



33-34	Pass	40-16550ea.	50.00
36	Pass	68-16554ea.	70.00

Radiator Pan



39	Dlx Pass	91A-8240-Bea.	95.00
40	Pass	91A-8240-Bea.	95.00
39-40	Merc	91A-8240-Bea.	95.00
40-41	PU	91A-8240-Bea.	95.00

Radiator Splash Apron



32	Pass	B-16527ea.	37.00
----	------	---------	----------	-------

Radiator Splash Apron Screw & Nut Set

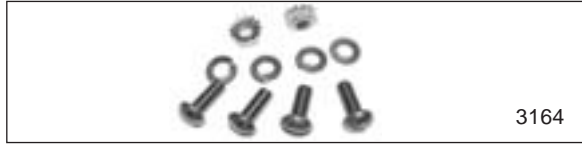

32	Pass	3164set.	2.50
32-34	PU	3164set.	2.50

Radiator Splash Apron Hardware

Bolts front bumper braces to frame. Front bolt has correct extension to mount radiator splash pan.



32	Pass	18-17766/7-Sset.	25.00
32-34	PU	18-17766/7-Sset.	25.00

Radiator Splash Apron Anti-Rattler Felt

32	Pass	B-16527-FBea.	6.00
32-34	PU	B-16527-FBea.	6.00

Upper Grille Air Deflector

Polished Stainless

39	Dlx Pass	01A-8327-Akit.	125.00
40	Std Pass	01A-8327-Akit.	125.00
40	Dlx Pass	01A-8327-Bkit.	125.00
40-41	PU	01A-8327-Akit.	125.00

Radiator Shroud Upper Panel



46-48	Pass	51A-8327, blackea.	75.00
46-48	Pass	51A-8327-C, chromeea.	100.00

Upper Radiator Shroud Seal

42-48	Pass	21A-8327-K, 1 req'dea.	6.00
42-48	Merc	21A-8327-K, 1 req'dea.	6.00
55-57	T-Bird	B5S-8147-S, top of shroud to radiatorea.	4.00
42-47	PU	21A-8327-K, 2 req'dea.	6.00

Radiator to Air Deflector Seal

49-53	Pass	8BA-8349ea.	3.00
-------	------	----------	----------	------

Radiator Air Deflector to Hood Seal

49-51	Pass	1BA-8344ea.	15.00
52-54	Pass	BA-8344ea.	9.00
55-56	Pass	B5A-8344ea.	9.00

Radiator Air Deflector to Top of Radiator Seal

49-53	Pass	8BA-8349ea.	3.00
55-56	Pass	B5A-8349ea.	4.50
53-56	PU	B3T-8349ea.	6.00

Radiator Grille Pan Rubber

48-53	PU	7C-8348-Aea.	4.00
53-56	PU	B3T-8348-Aea.	6.00

Lower Air Deflector Seal

42-48	Pass	21A-8208-Kea.	8.00
42-48	Merc	21A-8208-Kea.	8.00

Radiator Shroud to Hood Seal

48-52	PU	8C-16614ea.	5.00
-------	----	----------	----------	------

OVER FLOW

Stainless Radiator Over Flow Tank



All	Pass & PU	B-8005-WO13, 13"ea.	65.00
All	Pass & PU	HR-301-13-F, 13" with "Ford" logo capea.	80.00
All	Pass & PU	HR-301-13-V, 13" with "v8" logo capea.	80.00
All	Pass & PU	B-8005-WO15, 15"ea.	65.00
All	Pass & PU	HR-301-15-F, 15" with "Ford" logo capea.	80.00
All	Pass & PU	HR-301-15-V, 15" with "V8" logo capea.	80.00
All	Pass & PU	B-8005-WO17, 17"ea.	65.00
All	Pass & PU	B-8005-WO19, 19"ea.	65.00

Radiator Overflow Mounting Hardware

Included with overflow tank.

All	Pass & PU	B-8005-MKkit.	6.50
-----	-----------	-----------	-----------	------

Radiator Overflow Cap, Neck, & Screws

Included with overflow tank.

All	Pass & PU	B-8005-RKkit.	18.00
-----	-----------	-----------	-----------	-------

Radiator Overflow Cap

Fits the HR- part numbers only.

All	Pass & PU	HR-301-FC, "Ford" logoea.	22.00
All	Pass & PU	HR-301-VC, "V8" logoea.	22.00

TEMPERATURE SENDERS

Temperature Senders



40-55	Pass	8A-10884, 6V, single prongea.	55.00
40-53	Pass	8A-10990, 6V, double prongea.	55.00
56	Pass	B6C-10884, 12Vea.	55.00



39-55	Merc	8A-10884, 6V, single prong.....ea.	55.00
40-53	Merc	8A-10990, 6V, double prong.....ea.	55.00
56	Merc	B6C-10884, 12V.....ea.	55.00
40-55	PU	8A-10884, 6V, single prong.....ea.	55.00
40-53	PU	8A-10990, 6V, double prong.....ea.	55.00
56	PU	B6C-10884, 12V.....ea.	55.00

Temp Sender for VDO Gauge

Only fits VDO gauge that reads up to 250 degrees.

323-419, fits 1/2"-14 NPT.....ea.	13.00
-----------------------------------	-------

Cylinder Head Bushing for Temperature Sender



54-56	Pass	B4A-10911-A.....ea.	15.00
-------	------	---------------------	-------

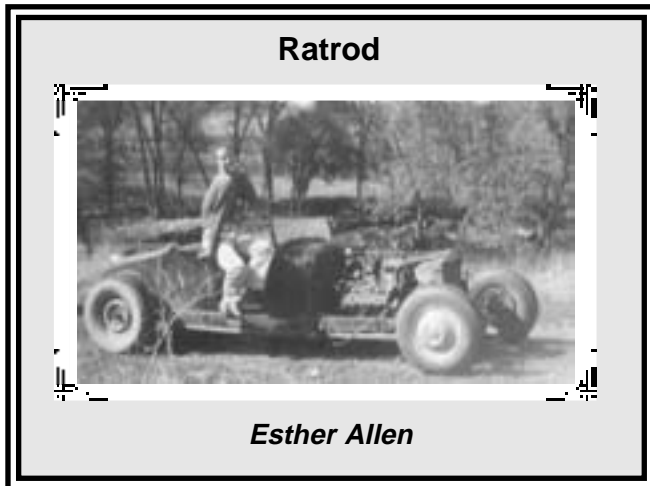

**Section 15
Grille**

GRILLE

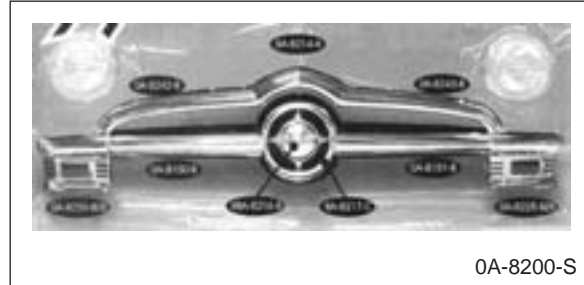

Grille Assembly

Includes upper, center, and upper center grille bars; center emblem, ring, and park light housings. Please call for availability.

*50	Pass	0A-8200-S.....ea.	Call
-----	------	-------------------	------

Upper Grille Bar

50	Pass	0A-8242-B, RH.....ea.	100.00
50	Pass	0A-8243-B, LH.....ea.	100.00

Upper Center Grille "Eyebrow"

49-50	Pass	8A-8214-A.....ea.	50.00
-------	------	-------------------	-------

Center Grille Ornament Ring

50	Pass	8A-8217-C.....ea.	100.00
----	------	-------------------	--------

Center Grille Ornament

49-50	Pass	8BA-8216-B, V-8.....ea.	100.00
-------	------	-------------------------	--------

Center Grille Bar

49	Pass	8A-8150-B, NOS, RH, has shelf wear.....ea.	75.00
49	Pass	8A-8151-B, NOS, LH, has shelf wear.....ea.	75.00
50	Pass	0A-8150-B, RH.....ea.	100.00
50	Pass	0A-8151-B, LH.....ea.	100.00

Parking Lamp Housing

Does not include parking lamp; see section 22.

50	Pass	0A-8224-BZ8, RH.....ea.	275.00
50	Pass	0A-8225-BZ8, LH.....ea.	275.00
50	Pass	0A-8224-PR, RH & LH.....pr.	500.00



51	Pass	1A-8224/5, RH & LH.....pr.	625.00
----	------	----------------------------	--------

Grille Hardware

Includes all nuts and bolts to assemble grille.

50	Pass	0A-8200-HW.....kit.	60.00
----	------	---------------------	-------

Steel Radiator Shell

Original style does not have holes for headlight or horn conduit.

- *32 Pass B-8200-OGS, original style.....ea. 305.00
- *32 Pass B-8200-HRS, no holesea. 295.00

1932 Grille Insert

Available with plain steel grille bars like original, or with polished stainless grille bars, stainless available with or with out crank hole.

- 32 Pass B-8200-1A, orig style, w/crank holeea. 395.00
- 32 Pass B-8200-1C, stainless, w/crank holeea. 350.00
- 32 Pass B-8200-1D, stainless w/o crank holeea. 340.00
- 32 Pass B-8200-1E, stainless, 4" chop, w/o crank holeea. 395.00

1932 Grille Insert Bars

To replace damaged or broken bars.

- 32 Pass B-8151-A, steel, 43 requiredea. 2.00
- 32 Pass B-8151-SS, stainless, 43 required.....ea. 3.50

Grille

The 1936-39 grilles are imported reproductions made from steel. The 1940 Passenger grilles are die cast zinc. 1934-39 Grilles do not include trim or emblems.

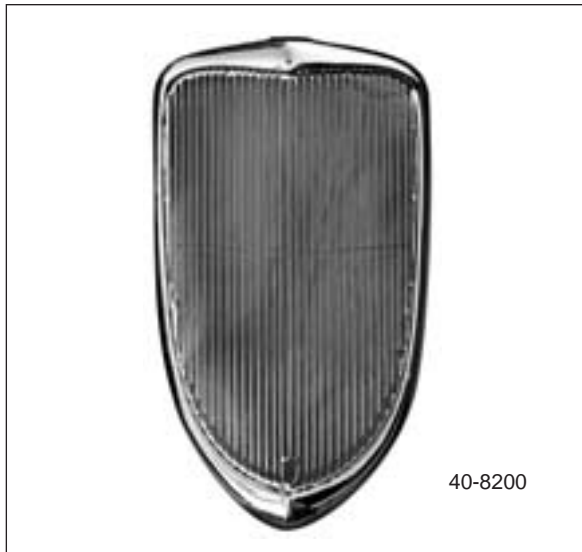

- *34 Pass 40-8200, chrome, mfg by Drakeea. 2450.00
- *34 Pass 40-8200-RAW, plain, mfg by Drakeea. 1950.00
- *35 Pass 48-8200-C, chrome, Austalian importea. 2250.00
- *36 Pass 68-8200, plainea. 425.00



- *37 Pass 78-8200, plain.....ea. 425.00
- *37 Pass 78-8200-NH, plain, w/o crank holeea. 425.00
- *39 DlX Pass 91A-8200-P, plainea. 425.00

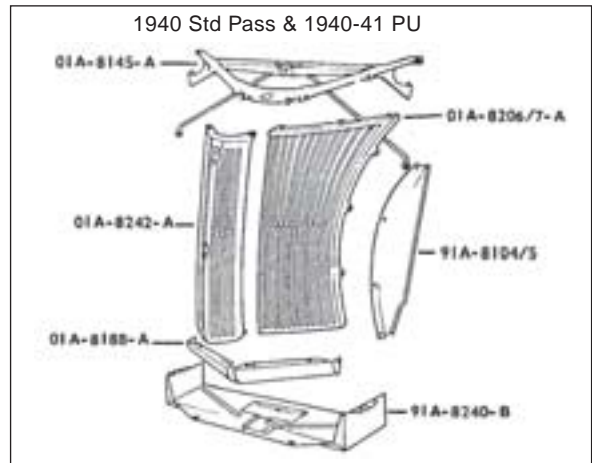

- *40 Std Pass 01A-8206-AK, plain w/chrome center, 3 pc. assembly.....set. 650.00
- *40 Std Pass 01A-8206/7-ACK, chrome, 3 pc. assembly.....set. 750.00

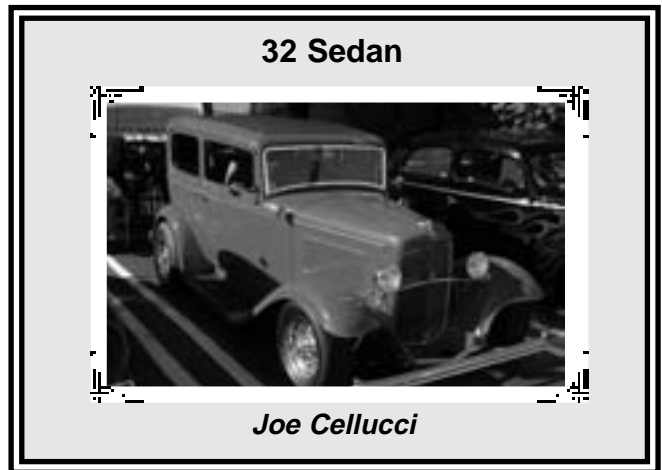

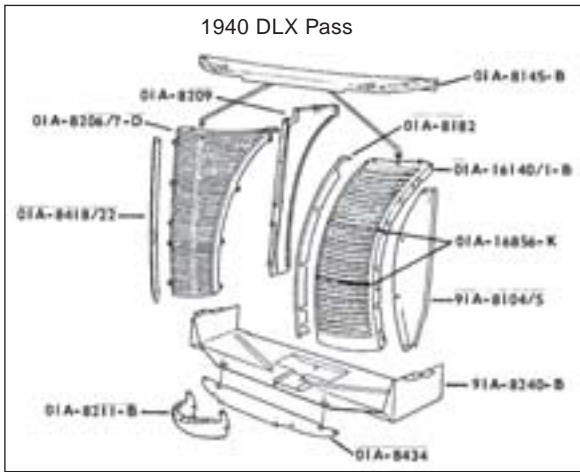

*40	Dlx Pass	01A-8206/7-D, chrome, 3 pc. assembly, mfg by Drake.....set.	695.00
*40	Dlx Pass	01A-8206/7-DC, chrome, 3 pc assembly, mfg. by Vintique.....set.	450.00
*40	Dlx Pass	01A-8206/7-DB, chrome 3 pc assembly, without crank hole, mfg by Drake.....set.	695.00
*40	Dlx Pass	01A-8206/7DB-RAW, plain 3 pc assembly, without crank hole, mfg by Drake.....set.	499.95
*40-41	PU	01A-8206-AK, plain w/chrome center, 3 pc. assembly.....set.	650.00
*40-41	PU	01A-8206/7-ACK, chrome, 3 pc. assembly.....set.	750.00
*56	PU	B6C-8200, black, no hole for V8 emblem, no hardware.....ea.	495.00
*56	PU	B6C-8200-B, chrome, no hole for V8 emblem, no hardware.....ea.	575.00

Grille Vent Panels

40	Dlx Pass	01A-16140/1-B.....pr.	425.00
----	----------	-----------------------	--------

Grille Center Hardware Kit

40	Std Pass	01A-8242-HK.....kit.	5.00
40-41	PU	01A-8242-HK.....kit.	5.00

Grille Side Hardware Kit

40	Std Pass	01A-8206-AHK.....kit.	12.00
40	Dlx Pass	01A-8206-DHK.....kit.	9.00
40-41	PU	01A-8206-AHK.....kit.	12.00

Grille to Radiator Mounting Screws

30-35	Pass & PU	1165.....set.	2.50
-------	-----------	---------------	------

Grille to Grille Vent Panel Stainless Trim

Has a stainless bead with welting. Upper tip mounts into grille vent panel.

40	Dlx Pass	01A-8182.....pr.	20.00
----	----------	------------------	-------

Grille Bars

Sold in sets of 15, available in plain steel or chrome. Clips NOT included.

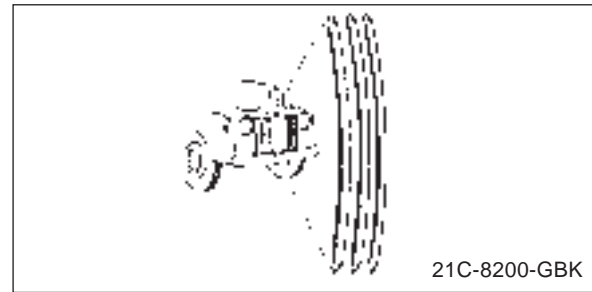

42-47	PU	21C-8200-GBK, plain.....set.	205.00
42-47	PU	21C-8200-SET, chrome.....set.	350.00

Grille Bar Clips

Clips must be ground to fit small grill bars.

42-47	PU	6A-20011.....set.	17.00
-------	----	-------------------	-------

Lower Outer Grilles

41	Pass	11A-16034/5, chrome.....pr.	500.00
41	Pass	11A-16034/5-R, plain.....pr.	200.00

Grille Center Support Vertical Bracket

56	PU	B6C-16864-A.....ea.	19.95
56	PU	B6C-16864-PSS, stainless.....ea.	29.95

GRILLE SHEETMETAL

Upper Grille Brace



40	Std Pass	01A-8145-A.....ea.	125.00
40	Dlx Pass	01A-8145-B.....ea.	125.00
40-41	PU	01A-8145-A.....ea.	125.00

Grille Center Plate

37	Pass	78-8209.....ea.	90.00
40	Dlx Pass	01A-8209.....ea.	60.00

Outer Grille Plate

39	Dlx Pass	91A-8104/5.....pr.	55.00
40	Pass	91A-8104/5.....pr.	55.00
40	Merc	91A-8104/5.....pr.	55.00
40-41	PU	91A-8104/5.....pr.	55.00

Lower Grille Chin Pan – Plain



40	Std Pass	01A-8188-A.....	ca.	100.00
40	Dlx Pass	01A-8211-B.....	ca.	60.00
40-41	PU	01A-8188-A.....	ca.	100.00

Lower Grille Chin Pan Plate



40	Dlx Pass	01A-8434.....	ca.	35.00
----	----------	---------------	-----	-------

Lower Grille to Radiator Pan



33-34	Pass	40-8240-S, street rod style.....	ca.	60.00
-------	------	-------------------------------------	-----	-------

Lower Grille Panel

48-50	PU	7C-8188.....	ca.	125.00
53	PU	B3C-8188.....	ca.	240.00
54	PU	B4C-8188.....	ca.	240.00
55-56	PU	B6C-8188-A.....	ca.	220.00

Fiberglass Front Gravel Pan

*46-48	Pass	51A-17777-FB.....	ca.	131.00
--------	------	-------------------	-----	--------

Radiator Grille Deflector - Behind Grille

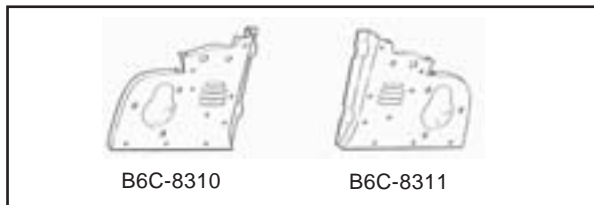

53-55	PU	BAAA-8310, RH.....	ca.	100.00
53-55	PU	BAAA-8311, LH.....	ca.	100.00
56	PU	B6C-8310, RH.....	ca.	100.00
56	PU	B6C-8311, LH.....	ca.	100.00

Upper Grille Corner Panel

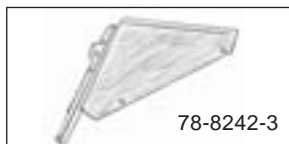

37	Pass	78-8242/3.....	pr.	50.00
----	------	----------------	-----	-------

Grill to Radiator/Hood Catch Brackets

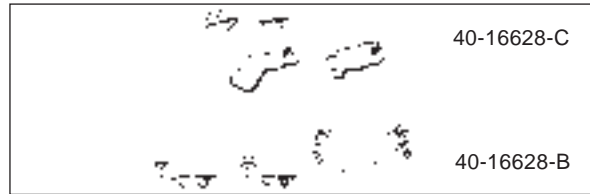

33	Pass	40-16628-B.....	set.	25.00
34	Pass	40-16628-C.....	set.	35.00

GRILLE TRIM

Stainless Grille Trim Set

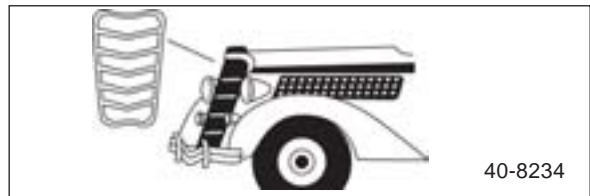

34	Pass	40-8234, w/clips.....	set.	80.00
35	Pass	48-8234, w/clips.....	set.	124.95



37	Pass	78-8200-GTS, 6 pcs.....	set.	150.00
39	Dlx Pass	91A-8332-K, 24 pcs.....	set.	350.00
37	PU	77-8157-K, 3 pcs.....	set.	350.00

Grill Bar Trim

Stainless

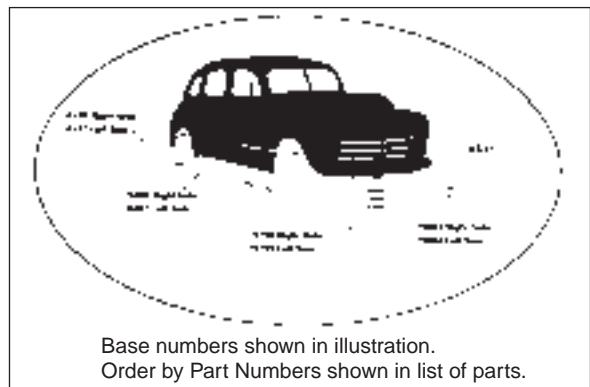

Base numbers shown in illustration.
Order by Part Numbers shown in list of parts.

46-47	Pass	51A-8332-S, early 47.....	set.	150.00
47-48	Pass	6A-8332, late 47.....	set.	150.00
48-50	PU	7C-8200-GBK, 5 pcs., w/clips.....	set.	199.95
48-50	PU	7C-8200-GBK-WOC, 5 pcs., w/clips, w/o crank hole.....	set.	199.95

Stainless Grille Trim Seam Clip

34	Pass	40-8234-C.....	ca.	6.95
----	------	----------------	-----	------



Upper Grille Bar Seam Trim

Goes in center to cover where grille trim meets.

51 Pass 1A-8221ea. 15.00

Grille Trim Clips

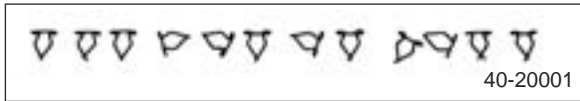

34 Pass 40-20001set. 5.00
 35 Pass 48-20001set. 9.00

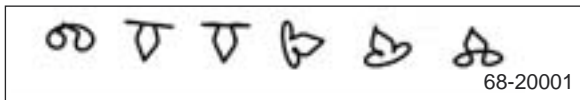

36 Pass 68-20001, grille center strip wire clips (6 clips).....set. 4.00
 36 Pass 68-20002, grille outer (16 clips).....set. 5.50

Grille Center Trim



36 Pass 68-8157, SSea. 50.00



37 Pass 78-8157, SSea. 50.00
 38 Dlx Pass 81A-8157-B, chromeea. 395.00
 39 Std Pass 91A-8157-A, chromeea. 395.00

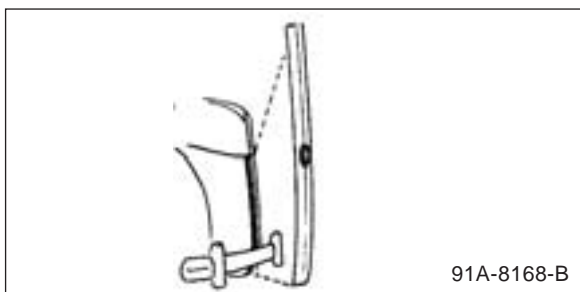

39 Dlx Pass 91A-8168-B, chromeea. 120.00

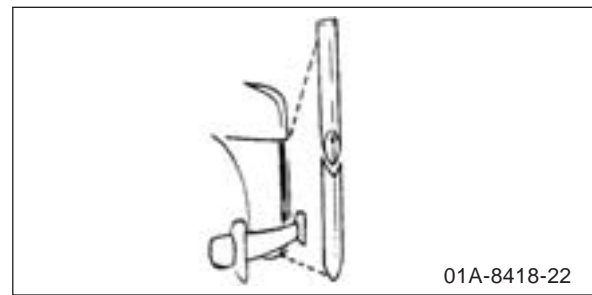

40 Dlx Pass 01A-8418/22, chromeea. 75.00
 40 Dlx Pass 01A-8418/22-SR, chrome, 1 pc...ea. 80.00
 40 Dlx Pass 01A-8418/22-BA, black, 1 pc.....ea. 37.00
 37 PU 77-8157ea. 150.00

Grille Center Hardware

36 Pass 68-20001set. 4.00
 40 Std Pass 01A-8242-HKkit. 5.00
 40 Dlx Pass 01A-8418/22-HKkit. 5.00
 40-41 PU 01A-8242-HKkit. 5.00

Outer Grill Stainless Vertical Trim

36 Pass 68-8184/5pr. 80.00
 37 Pass 78-8184/5pr. 60.00
 37 PU 77-8184/5pr. 225.00

Outer Grille Verticle Trim Hardware

36 Pass 68-20002set. 5.50

Stainless Grill Corner Trim

37 Pass 78-8268/9pr. 25.00

Stainless Top of Grille Trim

37 Pass 78-8264ea. 30.00

Stainless Grille Vent Panel Trim



40 Dlx Pass 01A-16856-Kset. 80.00

Chrome Grille Crank Hole Cover



33 Pass 40-8216-Aea. 26.00
 34 Pass 40-8216-Bea. 26.00

Stainless Grille Crank Hole Bezel



32 Pass B-8216ea. 24.95

Stainless Radiator Shell Grille Trim

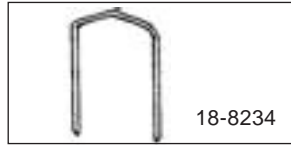

32 Pass 18-8234ea. 56.00
 32 Pass 18-8234-CH, choppedea. 49.95

GRILLE ORNAMENT

Grille Shell Ornament

Does NOT include porcelain emblem #-8212.



32 Pass B-8215ea. 50.00
 32 Pass B-8215-BN, Bull Noseea. 50.00
 34 Pass 40-8215ea. 50.00
 35 Pass 48-8215, "V-8"ea. 100.00
 36 Pass 68-8215, "V-8"ea. 100.00



36 Pass 68-8215-BN, w/o V-8, bull noseea. 100.00



34-35 PU 46-8215ea. 50.00



36 PU 67-8215, "V-8"ea. 100.00
 36 Truck 67-8215, "V-8"ea. 100.00



37 PU 77-8215, "Ford 85"ea. 80.00
 37 Truck 77-8215, "Ford 85"ea. 80.00



38 PU 81C-8213, "V-8"ea. 90.00
 38 Truck 81C-8213, "V-8"ea. 90.00

Porcelain Grille Shell Ornament Emblem

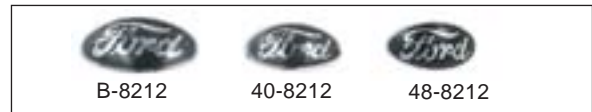

32 Pass B-8212ea. 35.00
 32 Pass B-8212-STR, use with bull nose ornamentea. 35.00
 33 Pass 18-8212ea. 35.00
 34 Pass 40-8212ea. 35.00
 35-36 Pass 48-8212ea. 35.00
 38 Pass 48-8212ea. 35.00
 32-35 PU B-8212ea. 35.00
 36 PU 48-8212ea. 35.00

Greyhound Ornament



35 Pass 68-18390ea. 99.50
 36 Pass 68-18390ea. 99.50

Grille Teeth



53 PU BAAA-8164/5-B.....set. 185.00

Grille Hash Marks



54 PU B4C-8251/2-A.....pr. 150.00

Gull Wing Grille Trim



55 PU B5C-8419/20-A.....pr. 175.00

GRILLE EMBLEM

Upper Grille Emblem Set

Includes mounting hardware.

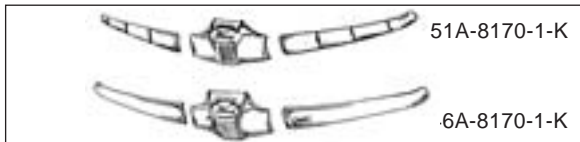

46 Pass 51A-8170/1-K.....set. 325.00
 47-48 Pass 6A-8170/1-K.....set. 325.00

Upper Grille Emblem Hardware Kit

46-48 Pass 51A-8170-HK.....kit. 20.00

Grille to Fender Clip Kit



46-48 Pass 51A-16046-K.....kit. 25.00

GRILLE SHELL LACE

Grille Shell Lacing

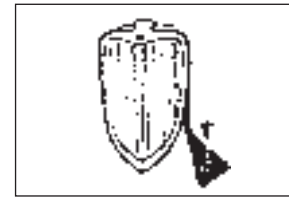

32 Pass B-8222.....kit. 11.00
 33-34 Pass 40-8222.....kit. 11.00
 35 Pass 48-8222.....kit. 11.00
 36 Pass 68-8222.....kit. 6.00
 32-34 PU B-8222.....kit. 11.00
 35-37 PU 50-16739-S.....kit. 11.00
 38-39 PU 81C-8222.....kit. 10.00

Grill to Fender Bumpers

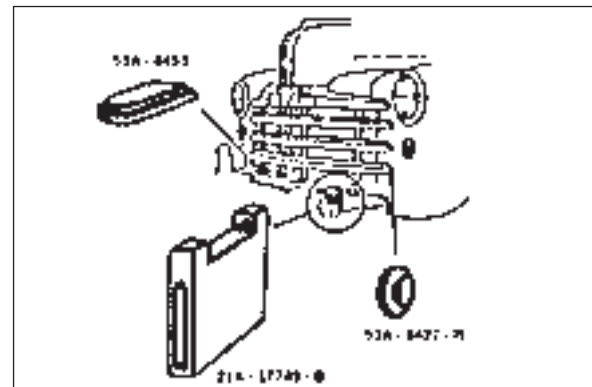

46-48 Pass 51A-8427-B, 12 pcs.....set. 5.00

Radiator Grill to Splash Pan Pads

46-48 Pass 51A-8453, 4 pcs.....set. 5.00

GUARD

Chrome Grille Guard with Hardware

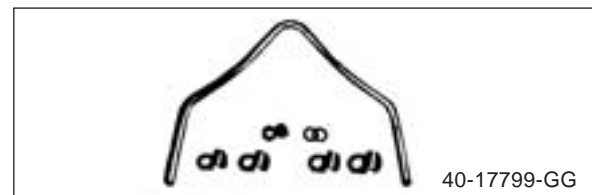

33-36 Pass 40-17799-GG.....ea. 250.00

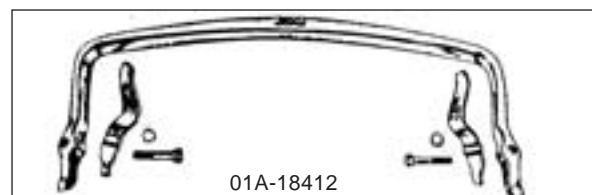

40 Pass 01A-18412.....ea. 275.00
 40 Merc 01A-18412.....ea. 275.00

33-36	PU	40-17799-GG.....ea.	250.00
40-41	PU	01A-18412.....ea.	275.00

Bug Screen

Mesh metrial to mount to front of grille to keep the bugs out.

32	Pass	B-8198.....ea.	42.00
33-34	Pass	40-8198.....ea.	42.00
35	Pass	48-8198.....ea.	42.00
36	Pass	68-8198.....ea.	42.00
37	Pass	78-8198.....ea.	42.00
40	Dlx	01A-8198-B.....ea.	42.00
32	PU	B-8198.....ea.	42.00
34	PU	46-8198.....ea.	42.00
36	PU	67-8198.....ea.	42.00

Section 16 Fuel System

GAS TANK

Reproduction Gas Tanks

These tanks are made like original. 36-54 Pass must use 01A-9275 sending unit if using original gauges. Original sending unit will not fit reproduction gas tank. Gas tank straps are NOT included on 55-56 Pass.



*32	Pass	B-9002, 10 gallon, must modify to use original sending unit.....ea.	405.00
*32	Pass	B-9002-LG, 16 gallon, must modify to use original sender.....ea.	440.00
*33-34	Pass	40-9002-OR, requires 40-9003 to use original sender.....ea.	325.00
*34	Victoria	67-9002-OR, requires 40-9003 to use original sender.....ea.	325.00
*35-36	Pass	68-9002-OR, 35 requires 40-9003 to use original sender.....ea.	325.00
*37	Pass	78-9002-OR, early, with threaded filler neck.....ea.	325.00
*38-40	Pass	81A-9002-OR, , will not fit late 37.....ea.	275.00
*41-48	Pass	11A-9002-OR, 17 gallon.....ea.	275.00
*49-51	Pass	8A-9002-OR, except wagon.....ea.	325.00
*52-54	Pass	BA-9002, except wagon.....ea.	325.00
*55	Pass	B5A-9002, except wagon.....ea.	295.00
*56	Pass	B6A-9002-A, except wagon.....ea.	335.00
*41-48	Merc	11A-9002-OR, 17 gallon.....ea.	275.00
*49-51	Merc	8M-9002-OR, except wagon.....ea.	325.00
*56	Merc	B6A-9002-A, except wagon.....ea.	335.00
*55	T-Bird	B5S-9002.....ea.	290.00

*56	T-Bird	B6S-9002-A.....ea.	290.00
*57	T-Bird	B7S-9002.....ea.	290.00
*35-37	PU	67-9002-OR, 35 requires 40-9003 to use original sender.....ea.	325.00
*38-41	PU	81A-9002-OR.....ea.	275.00
48-52	PU	7C-9002-OR.....ea.	260.00
*53-55	PU	BAAA-9002-OR.....ea.	275.00
*56	PU	B6C-9002, in cab tank.....ea.	295.00

Stainless Streetrod Gas Tank

Die stamped stainless steel. Can use reproduction, or streetrod type fuel sending unit. Includes stainless pick up tube assembly for carburetion or fuel injection.

*38-40	Pass	81A-9002-SS, 15.5 gallons.....ea.	525.00
*38-41	PU	81A-9002-SS, 15.5 gallons.....ea.	525.00

Hydrostatic Sender Adapter

Use w/reproduction gas tanks when using original hydrostatic gas gauge

33-35	Pass & PU	40-9003.....kit.	45.00
-------	-----------	------------------	-------

Gas Tank Mounting Straps

55-56	Pass	B6A-9092-A.....pr.	50.00
55-56	T-Bird	B5S-9092-A.....pr.	45.00
53-55	PU	TM-245.....pr.	45.00

Gas Tank To Frame Mounting Bolts



28-40	Pass	3171.....set.	6.75
28-40	Pass	SS-3171, stainless.....set.	12.50
39-40	Merc	3171.....set.	6.75
39-40	Merc	SS-3171, stainless.....set.	12.50
28-41	PU	3171.....set.	6.75
28-41	PU	SS-3171, stainless.....set.	12.50

Gas Tank To Frame Mounting Brackets

Includes three brackets and three mounting pads.



42-48	Pass	21A-9046-K.....kit.	40.00
-------	------	---------------------	-------

Gas Tank to Frame Pads

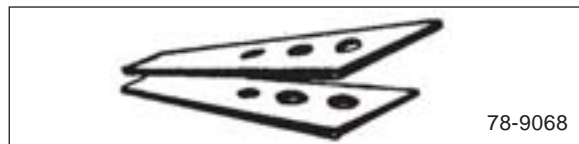

35-36	Pass	48-9068.....pr.	10.00
37-40	Pass	78-9068.....pr.	10.00
42-48	Pass	21A-9299.....pr.	15.00
39-40	Merc	78-9068.....pr.	10.00
42-48	Merc	21A-9299.....pr.	15.00
35-36	PU	48-9068.....pr.	10.00
37-41	PU	78-9068.....pr.	10.00



Gas Tank to Body Pads

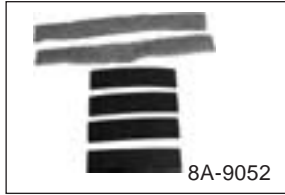

49-51 Pass 8A-9052set. 15.00

Gas Filler Pipe to Floor Seal

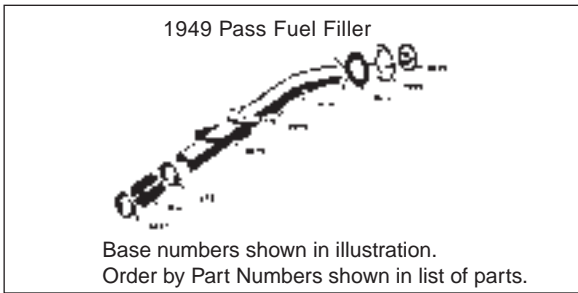

49-51 Pass 1A-9072ea. 5.00
 50-51 Wagon 7A-9072-Bea. 10.00
 50-51 Merc Wgn 7A-9072-Bea. 10.00

Gas Tank Outlet to Floor Seal



48-52 PU 7C-9136-Aea. 8.00

Gas Tank to Floor Pads



42-52 PU 21C-9299pr. 6.00

Gas Tank Vent Tube Seal

55-56 Pass B5A-9050ea. 2.25

Gas Tank Vent Pipe to Body Grommet

55-56 Pass B5A-9069-Aea. 2.25

Gas Tank Filler Pipe



35 Pass 48-9034ea. 50.00
 36 Pass 68-9034ea. 50.00
 37 Pass 78-9034-A, early, use with threaded gas tankea. 50.00
 37 Pass 78-9034-B, late, uses filler hoseea. 45.00

38-40 Pass 91A-9034-Bea. 45.00
 41-48 Pass 21A-9034-Aea. 50.00
 37 PU 77-9034-Aea. 50.00
 38-41 PU 81C-9034-Bea. 45.00

Universal Gas Tank Filler Pipe

Solid fuel resistant rubber hose with molded flex joint. 2" I.D. x 12" long. Can be cut for use in any car or truck. Will stretch to fit steel pipe 2-1/2" O.D.

All HR-9047ea. 30.00

"Ford" Script Gas Filler Neck Hose



37-40 Pass 78-9047-Sea. 10.00
 38-40 Wgn 81A-9047ea. 10.00
 41-51 Pass 21A-9047-S, except wagonea. 10.00
 41-56 Wgn 11A-9047-Bea. 10.00
 39-40 Merc 78-9047-Sea. 10.00
 41-51 Merc 21A-9047-S, except wagonea. 10.00
 37-41 PU 78-9047-Sea. 10.00
 42-55 PU 21A-9047-S, except wagonea. 10.00
 56 PU 78-9047-Sea. 10.00

Gas Filler Neck Hose

37-40 Pass 78-9047ea. 10.00
 41-51 Pass 21A-9047, except wagonea. 10.00
 39-40 Merc 78-9047ea. 10.00
 41-51 Merc 21A-9047, except wagonea. 10.00
 37-41 PU 78-9047ea. 10.00
 42-55 PU 21A-9047ea. 10.00
 56 PU 78-9047ea. 10.00

Gas Filler Neck Hose Clamp



37-40 Pass B-8287-A12ea. 3.00
 41-51 Pass 11A-8287-A16ea. 1.50
 37-41 PU B-8287-A12ea. 3.00
 42-55 PU 11A-8287-A16ea. 1.50

Gas Filler Neck to Tank Lead Seal

35-37 Pass & PU 48-9031ea. 8.00

Gas Filler Neck Grommet

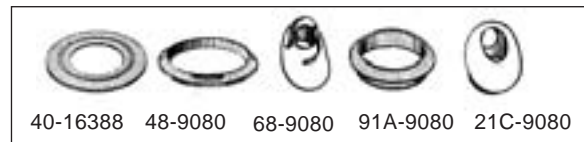

33-34 Pass 40-16388ea. 10.00
 34 Victoria 40-9080-B, lateea. 20.00
 35-36 Pass 48-9080ea. 10.00
 36 Conv Sdn 68-9080ea. 22.50

35-37	Wgn	48-9081ea.	15.00
35-37	Sdn Dly	48-9081ea.	15.00
37-38	Pass	78-9080, original styleea.	15.00
39-40	Pass	91A-9080ea.	10.00
49	Pass	8A-9080, bonded to metalea.	25.00
50-51	Pass	0A-9080ea.	8.00
49-51	Wgn	0A-9084ea.	25.00
52-56	Pass	BA-9080-Bea.	10.00
39-40	Merc	91A-9080ea.	10.00
49-50	Merc	7A-9080ea.	15.00
51	Merc	1M-9080, 2 requiredea.	40.00
49-51	Merc Wgn	0A-9084ea.	25.00
55-57	T-Bird	B7A-9080-Aea.	7.00
39-41	PU	91A-9080ea.	10.00
42-47	PU	21C-9080ea.	13.00
48-52	PU	7C-9080ea.	17.50
48-52	Panel	7C-9080-Pea.	25.00
53-55	PU	BAAA-9080-Bea.	15.00
53-56	Panel	BAAA-9080-Aea.	25.00
56	PU	B6C-9080ea.	15.00

Gas Filler Neck to Quarter Panel Gasket



49	Pass	8A-9076ea.	3.00
----	------	---------	----------	------

Gas Tank Filler Door Spring

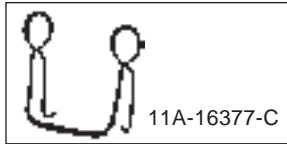

41-48	Pass	11A-16377-Cea.	6.50
50-54	Pass	0A-16377ea.	12.00

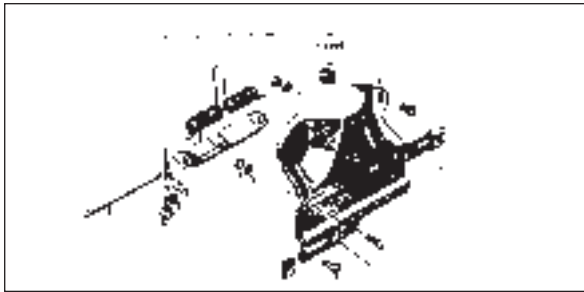

55-56	Pass	B5A-16377, exc. sdn delivery & wgnea.	12.00
41-48	Merc	11A-16377-Cea.	6.50

Gas Tank Filler Door Bumpers

41-48	Pass	11A-16378-A-BD, original stylepr.	4.00
-------	------	--------------------------------	----------	------



41-48	Pass	11A-16378-Apr.	2.25
-------	------	-------------	----------	------

50-51	Pass	0A-16378pr.	3.00
52-56	Pass	BA-13398-B, exc. wgnpr.	5.00
55-56	Wagon	0A-16378pr.	3.00
55-56	Sdn Dly	0A-16378pr.	3.00
41-48	Merc	11A-16378-A-BD, original stylepr.	4.00
41-48	Merc	11A-16378-Apr.	2.25
55-60	T-Bird	B5S-13398pr.	2.00

Fuel Tank to Frame Horn Cover Seal



32	Pass	B-16398kit.	10.00
----	------	---------	-----------	-------

GAS TANK COVER

Steel Gas Tank Cover-Smooth No Holes

Has mounting holes. The filler neck hole is marked, must be cut open to use original gas tank.



33-34	Pass	40-16396-SMea.	465.00
-------	------	-------------	----------	--------

Gas Tank Cover Screws

33-34	Pass	3170set.	1.25
-------	------	------	-----------	------

GAS CAP

Gas Cap



32-48	Pass	B-9030, SSea.	6.00
32-48	Pass	18-9030, ventedea.	30.00
32-48	Pass	18-9030-V8, w/V-8, ventedea.	30.00
41-48	Pass	11A-9030, N.O.S.ea.	10.00



49-51	Pass	8A-9030, SS, ventedea.	8.00
39-48	Merc	B-9030, SSea.	6.00
39-48	Merc	18-9030, ventedea.	30.00
39-48	Merc	18-9030-V8, w/V-8, ventedea.	30.00
41-48	Merc	11A-9030, N.O.S.ea.	10.00
49-51	Merc	C7AZ-9030, ventedea.	6.00
55-60	T-Bird	C7AZ-9030, ventedea.	6.00



32-48	PU	18-9030, vented	ea.	30.00
32-50	PU	B-9030, SS.....	ea.	6.00
32-50	PU	18-9030-V8, w/V-8, vented	ea.	30.00
51-56	PU	8A-9030, SS, vented.....	ea.	8.00

Locking Vented Gas Cap



32-48	Pass	48-18416, chrome, w/Ford script.....	ea.	35.00
32-48	Pass	01A-18416-B, chrome	ea.	35.00



49-51	Pass	01A-18416-A, chrome.....	ea.	35.00
49-51	Pass	8A-18416-SS, polished stainless	ea.	13.00
39-48	Merc	48-18416, chrome, w/Ford script.....	ea.	35.00
39-48	Merc	01A-18416-B, chrome	ea.	35.00
32-50	PU	48-18416, chrome, w/Ford script.....	ea.	35.00
32-50	PU	01A-18416-B, chrome	ea.	35.00
51-70	PU	01A-18416-A, chrome.....	ea.	35.00

SENDING UNIT

Gas Tank Sending Unit

Gasket included with all sending units. If converting your early Ford to 12 volt and keeping the stock 6 volt gauge order #B-10606-R and use a #01A-9275 sender.



36-55	Pass	01A-9275, 6V	ea.	50.00
39-55	Merc	01A-9275, 6V	ea.	50.00
36-47	PU	01A-9275, 6V	ea.	50.00
48-52	PU	7C-9275-6V	ea.	39.50
53-55	PU	BAAA-9275-6V	ea.	39.50
56	PU	B6C-9275, 12V.....	ea.	39.50

Dash Gauge Voltage Drop

All	Pass & PU	B-10606-R	ea.	20.00
-----	-----------	-----------------	-----	-------

Gas Tank Sending Unit For 12 Volt Gauge

Will only fit original gas tanks. Gauge in dash must work with 40-180 ohms.

36-56	Pass	01A-9275-12V	ea.	49.95
39-56	Merc	01A-9275-12V	ea.	49.95
36-41	PU	01A-9275-12V.....	ea.	49.95

Streetrod Gas Tank Sending Unit

Does NOT work for stock gauges.

All		B-9275-SR, stuart warner type, 29-250 ohms	ea.	37.00
All		226-001, vdo type, 10-180 ohm.....	ea.	49.50

Gas Tank Fuel Pick Up

Not a sending unit. Has fuel pickup with filter; return line to bottom of tank, and vent tube with roll over safety check valve.

32	Pass	B-9274, fits reproduction tank	ea.	42.00
----	------	--------------------------------------	-----	-------

Gas Tank Sending Unit Float

Check the size of the one on your sending unit before ordering.



36-55	Pass	68-9275, 1.383"	ea.	10.00
36-56	Pass	COAZ-9202-B, 1.185".....	ea.	5.00
39-55	Merc	68-9275, 1.383"	ea.	10.00
39-55	Merc	COAZ-9202-B, 1.185".....	ea.	5.00
36-47	PU	COAZ-9202-B, 1.185".....	ea.	5.00
36-56	PU	68-9275, 1.383"	ea.	10.00

Gas Tank Sending Unit Gasket

32-35	Pass	B-9276	ea.	2.00
36-56	Pass	68-9276.....	ea.	2.50
36-56	Pass	68-9276-N, neoprene	ea.	3.00
39-56	Merc	68-9276.....	ea.	2.50
39-56	Merc	68-9276-N, neoprene	ea.	3.00
32-35	PU	B-9276	ea.	2.00
36-56	PU	68-9276.....	ea.	2.50
36-56	PU	68-9276-N, neoprene	ea.	3.00

Gas Tank Sending Unit Hardware

36-56	Pass	99A-9275-HW	set.	3.50
39-56	Merc	99A-9275-HW	set.	3.50
36-56	PU	99A-9275-HW	set.	3.50

Gas Tank Sending Unit Adapter

For use with original tanks when using VDO, Stewart Warner, or aftermarket sending unit.



36-56	Pass	US-54.....	ea.	37.50
39-56	Merc	US-54.....	ea.	37.50
36-56	PU	US-54.....	ea.	37.50

FUEL PUMP

Fuel Pump

All pumps are new, unless otherwise noted.



34-48	Pass	11A-9350, V8, no glass, original for 34-42ea.	62.00
34-48	Pass	59A-9350, V8, w/glass, original for 46-48ea.	59.00
41-47	Pass	1GA-9350, 6 cyl., rebuilt.....ea.	75.00
47-50	Pass	592-9350, 6 cyl.....ea.	62.50
49-50	Pass	578-9350, V-8, single-action.....ea.	63.00
49-50	Pass	586-9350, V-8, double actionea.	116.00
51	Pass	1HA-9350-A, 6 cyl., single-action, N.O.S.....ea.	60.00
51	Pass	1HA-9350-H, 6 cyl., double action, N.O.S.....ea.	90.00
51-53	Pass	9785-9350, V-8ea.	66.00
51-53	Pass	29597-9350, V8 double actionea.	128.00
52-54	Pass	9787-9350, 6 cyl.....ea.	66.50
54	Pass	4070-9350, 239, V-8, single actionea.	68.00
54	Pass	B4A-9350-E, 239, V-8, double action.....ea.	135.00



55-58	Pass	4206-9350, double action, V8.....ea.	116.50
55-61	Pass	4208-9350, 6 cyl.....ea.	64.00
55-61	Pass	4708-9350, 6 cyl., double actionea.	110.00



55-67	Pass	6523-9350, V-8, single actionea.	48.50
39-48	Merc	11A-9350, no glass, original for 39-42ea.	62.00

39-48	Merc	59A-9350, w/glass, original for 46-48ea.	59.00
49-50	Merc	578-9350, single-actionea.	63.00
49-50	Merc	586-9350, double actionea.	116.00
51-53	Merc	9785-9350ea.	66.00
51-53	Merc	29597-9350, double actionea.	128.00
54	Merc	4070-9350, single actionea.	68.00
54	Merc	B4A-9350-E, double actionea.	135.00
55-58	Merc	4206-9350, double actionea.	116.50
55-57	T-Bird	4406-9350, double actionea.	103.00



34-47	PU	11A-9350, V8, no glass, original for 34-42ea.	62.00
34-47	PU	59A-9350, V8, w/glass, original for 46-47ea.	59.00
41-47	PU	1GA-9350, 6 cyl., rebuilt.....ea.	75.00
48-50	PU	592-9350, 6 cyl.....ea.	62.50
48-50	PU	578-9350, V-8, single action.....ea.	63.00
48-50	PU	586-9350, V-8, double actionea.	116.00
51-53	PU	9785-9350, V-8ea.	66.00
51-53	PU	29597-9350, double actionea.	128.00
52-54	PU	9787-9350, 6 cyl.....ea.	66.50
54	PU	4070-9350, 239, V-8, single actionea.	68.00
55-64	PU	4208-9350, 6 cyl.....ea.	64.00
55-67	PU	6523-9350, V-8, single-action.....ea.	48.50

Electric Fuel Pump

Includes filter.

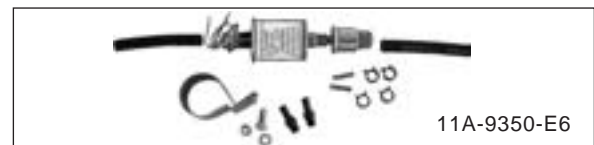

All	Pass & PU	11A-9350-E6, 6Vea.	65.00
All	Pass & PU	11A-9350-E12, 12Vea.	62.00

Electric Fuel Pump Filter

Replacement for filter included with #11A-9350-E6 and 11A-9350-E12.

All		11A-9350-EFea.	9.00
-----	--	----------------------	------

“You guys got the order because you have both items and the best prices.”
 Regards,
 Dave F., California



Fuel Pump Rebuilding Kit



32	Pass	18-9349-E, V-8, early.....kit.	73.00
32	Pass	18-9349-L, V-8, late.....kit.	58.00
32-34	Pass	B-9349-A, 4 cyl.kit.	72.00
34-48	Pass	11A-9349kit.	20.00
49-53	Pass	B1A-9349-B, 6cyl., V-8, single/double action.....kit.	45.00
39-48	Merc	11A-9349kit.	20.00
49-53	Merc	B1A-9349-B, single/double action.....kit.	45.00
32	PU	18-9349-E, V-8, early.....kit.	73.00
32	PU	18-9349-L, V-8, late.....kit.	58.00
32-34	PU	B-9349-A, 4 cyl.kit.	72.00
34-47	PU	11A-9349kit.	20.00
48-54	PU	B1A-9349-B, 6cyl., V-8, single/double action.....kit.	45.00

Fuel Pump Diaphragm



36-52	Pass	68-9396.....ea.	6.50
39-48	Merc	68-9396.....ea.	6.50
36-52	PU	68-9396.....ea.	6.50

Fuel Pump Rocker Arm Return Spring

33-48	Pass	40-9380, V-8ea.	1.00
39-48	Merc	40-9380ea.	1.00
33-48	PU	40-9380, V-8ea.	1.00

Fuel Pump to Stand Gasket



32-48	Pass	40-9417, V-8ea.	1.00
49-59	Pass	7RA-9417, V-8.....ea.	.50
39-48	Merc	40-9417ea.	1.00
49-56	Merc	7RA-9417ea.	.50
32-48	PU	40-9417, V-8ea.	1.00
49-59	PU	7RA-9417, V-8.....ea.	.50

Fuel Pump Stand

49-53	Pass	8BA-9416, V-8.....ea.	22.00
49-53	Merc	8BA-9416ea.	22.00
48-53	PU	8BA-9416, V-8.....ea.	22.00

Fuel Pump Stand to Intake Gasket



32-53	Pass	40-9374, V-8.....ea.	1.00
39-53	Merc	40-9374.....ea.	1.00
32-53	PU	40-9374, V-8.....ea.	1.00

Fuel Pump Push Rod

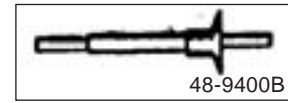

35-39	Pass	48-9400B, V-8, 7.87", for factory aluminum intake.....ea.	11.00
35-48	Pass	48-9400A, V-8, 8.87", cast iron intake.....ea.	10.00
49-53	Pass	EAB-9400, V-8ea.	15.00
39-48	Merc	48-9400A, 8.87", cast iron intake.....ea.	10.00
49-53	Merc	EAB-9400.....ea.	15.00
35-39	PU	48-9400B, V-8, 7.87", for factory aluminum intake.....ea.	11.00
35-47	PU	48-9400A, V-8, 8.87", cast iron intake.....ea.	10.00
48-53	PU	EAB-9400, V-8ea.	15.00

Fuel Pump Push Rod Bushing

For use in the engine block.

32-48	Pass	18-6025-A, V-8ea.	5.00
49-53	Pass	8BA-6025, V-8.....ea.	5.50
49-53	Merc	8BA-6025ea.	5.50
32-48	PU	18-6025-A, V-8ea.	5.00
48-53	PU	8BA-6025, V-8.....ea.	5.50

Fuel Pump Glass Bowl

28-48	Pass	A-9162ea.	4.00
39-48	Merc	A-9162ea.	4.00
28-47	PU	A-9162ea.	4.00

Fuel Pump Glass Bowl Gasket

28-53	Pass	A-9173ea.	2.50
39-53	Merc	A-9173ea.	2.50
28-53	PU	A-9173ea.	2.50

Fuel Pump Glass Bowl Screen

28-53	Pass	A-9176.....ea.	3.00
39-53	Merc	A-9176.....ea.	3.00
28-53	PU	A-9176.....ea.	3.00

Fuel Pump Glass Bowl Filter

Gasket is not included.



All	Pass	33039, for thick glass bowl.....ea.	7.50
-----	------	-------------------------------------	------

32-48	Pass	3034, V-8, for thin glass bowl	ea.	6.50
All	PU	33039, for thick glass bowl	ea.	7.50
32-47	PU	3034, V-8, for thin glass bowl	ea.	6.50

FUEL LINE

Gas Tank to Firewall Fuel Line

Copper coated steel like original with fittings.



32-48	Pass	18-9282	kit.	18.00
39-48	Merc	18-9282	kit.	18.00
32-56	PU	18-9282	kit.	18.00

Gas Tank to Firewall Line w/Air Line

Copper coated steel like original with fittings. Special order allow 2 to 3 weeks for delivery. Please specify 4 or 8 cylinder engine.

32	Pass	18-9289-A	ea.	270.00
33-34	Pass	18-9289-B	ea.	270.00
35	Pass	18-9289-C	ea.	270.00

Gas Gauge Head Rebuild Kit

32	Pass & PU	B-9280-F	kit.	79.00
----	-----------	----------------	------	-------

Gas Gauge Glass Tube Repair Kit

32	Pass & PU	B-9281	kit.	21.00
----	-----------	--------------	------	-------

Gas Gauge Air Line Kit

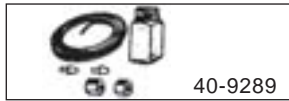

32-35	Pass & PU	40-9289	kit.	28.50
-------	-----------	---------------	------	-------

Gas Gauge Airline Fluid

32-35	Pass & PU	M-9280	ea.	4.00
-------	-----------	--------------	-----	------

Fuel Line Nut and Ferrule



32-48	Pass	B-9242/3	set.	5.00
39-48	Merc	B-9242/3	set.	5.00
32-56	PU	B-9242/3	set.	5.00

Firewall Fuel Line Clamp



32-48	Pass	18-9296	ea.	12.00
39-48	Merc	18-9296	ea.	12.00
32-47	PU	18-9296	ea.	12.00

Fuel Line to Fuel Pump Flex Hose



32-48	Pass	18-9288	ea.	7.00
49-50	Pass	7HC-9288-A	ea.	8.00
51-59	Pass	1A-9288-A	ea.	8.00
39-48	Merc	18-9288	ea.	7.00
49-51	Merc	7HC-9288-A	ea.	8.00
52-56	Merc	1A-9288-A	ea.	8.00
55-58	T-Bird	1A-9288-A	ea.	8.00
32-47	PU	18-9288	ea.	7.00
48-50	PU	7HC-9288-A	ea.	8.00
51-53	PU	1A-9288-A, V-8	ea.	8.00
51-56	PU	1A-9288-A, 6 cyl.	ea.	8.00
54	PU	B3TZ-9288-A, V-8	ea.	8.50
55-56	PU	B5C-9288-A, V-8	ea.	8.50

Fuel Line Pump To Carburetor

32-53	Pass	91A-9369, V-8	ea.	5.50
39-48	Merc	91A-9369	ea.	5.50
32-53	PU	91A-9369, V-8	ea.	5.50

Fuel Line Pump To Carburetor Pre-Bent

For V-8 only. Includes Fittings.

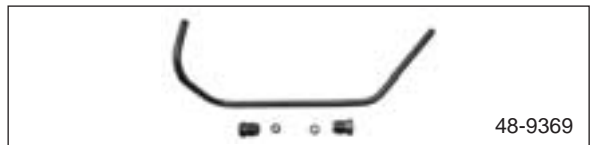

34-35	Pass	40-9369, early 35	ea.	15.00
35-36	Pass	48-9369, late 35	ea.	15.00
37-38	Pass	78-9369, w/97 carb	ea.	15.00
38-39	Pass	81A-9369, w/94 carb	ea.	15.00
40-46	Pass	01A-9369	ea.	15.00
47-48	Pass	59A-9369, w/glass fuel pump	ea.	15.00
49-50	Pass	8BA-9369	ea.	15.00
51-53	Pass	1A-9369	ea.	15.00
39	Merc	81A-9369	ea.	15.00
40-46	Merc	01A-9369	ea.	15.00
47-48	Merc	59A-9369, w/glass fuel pump	ea.	15.00
34-35	PU	40-9369, early 35	ea.	15.00
35-36	PU	48-9369, late 35	ea.	15.00
37-38	PU	78-9369, w/97 carb	ea.	15.00
38-39	PU	81A-9369, w/94 carb	ea.	15.00
40-46	PU	01A-9369	ea.	15.00
47	PU	59A-9369, w/glass fuel pump	ea.	15.00
48-50	PU	8BA-9369	ea.	15.00
51-53	PU	1A-9369	ea.	15.00

Fuel Tank to Steel Line Flex Hose

56-60	F100-250	B6TZ-9288-A	ea.	12.00
-------	----------	-------------------	-----	-------



CARBURETOR

New Replacement Carburetor

All new casting of the 97 style carburetor. All hardware and the linkage is stainless steel. Includes grose jet. Has extended throttle shaft. Must use old throttle linkage off your original carburetor. Has aluminum base, must be painted to look original.



35-38 Pass & PU 67-9510-NEWea. 359.95

Remanufactured Carburetor

Our carburetors are completely remanufactured and include cadmium plated hardware, new throttle shaft, grose jet installed, main body replated, flow tested, and all surfaces are trued. We can have your carburetor remanufactured, or you may special order matching carburetors for multiple carburetion. Please call for any additional information required. The core charge will apply if you do not send in your carburetor core prior to placing your order, and if it is not identical to the one purchased.



36-38	Pass	67-9510-A, 97.....ea.	345.00
36-38	Pass	67-9510-ACORE, core charge.....ea.	250.00
39-41	Pass	91A-9510-A, 91-99ea.	309.95
39-41	Pass	91A-9510-ACORE, core charge..ea.	100.00
42-46	Pass	21A-9510-A, 21-29ea.	309.95
42-46	Pass	21A-9510-ACORE, core charge..ea.	100.00
47-48	Pass	59A-9510-A, 59.....ea.	309.95
47-48	Pass	59A-9510-ACORE, core charge..ea.	100.00
49-51	Pass	8BA-9510-A, 8BA.....ea.	309.95
49-51	Pass	8BA-9510A-CORE, core charge .ea.	100.00
52-53	Pass	EAB-9510-A, V-8ea.	309.95
52-53	Pass	EAB-9510-ACORE, core charge.ea.	100.00
39-41	Merc	91A-9510-A, 91-99ea.	309.95
39-41	Merc	91A-9510-ACORE, core charge..ea.	100.00
42-46	Merc	21A-9510-A, 21-29ea.	309.95
42-46	Merc	21A-9510-ACORE, core charge..ea.	100.00
47-48	Merc	59A-9510-A, 59.....ea.	309.95
47-48	Merc	59A-9510-ACORE, core charge..ea.	100.00
36-38	PU	67-9510-A, 97.....ea.	345.00
36-39	PU	67-9510-ACORE, core charge.....ea.	250.00
39-41	PU	91A-9510-A, 91-99ea.	309.95
39-41	PU	91A-9510-ACORE, core charge..ea.	100.00
42-46	PU	21A-9510-A, 21-29ea.	309.95

42-46	PU	21A-9510-ACORE, core charge..ea.	100.00
47	PU	59A-9510-A, 59.....ea.	309.95
47	PU	59A-9510-ACORE, core charge..ea.	100.00
48-52	PU	7RT-9510-A, V-8.....ea.	309.95
48-52	PU	7RT-9510-ACORE, core charge ..ea.	100.00

Carburetor Rebuilding Kits

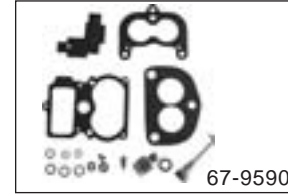

32-34	Pass	B-9590, 4 cyl.....kit.	33.50
33-38	Pass	67-9590, V-8, 97.....kit.	21.00
38-56	Pass	59A-9590, V-8, 94.....kit.	30.00
41-51	Pass	7HA-9590-A, 6 cyl.kit.	18.50
52-57	Pass	B2A-9590, 6 cyl.....kit.	30.00
54-56	Pass	B4AZ-9590-A, V-8, 2 Bbl.....kit.	27.50
55	Pass	B5A-9590, 4 Bbl.....kit.	51.50
56-57	Pass	B6A-9590, 4 Bbl.....kit.	44.00
39-48	Merc	59A-9590, 94kit.	30.00
49-51	Merc	8CM-9590kit.	65.00
52-53	Merc	MCK-9590kit.	65.00
55	T-Bird	B5A-9590, 4 Bbl.....kit.	51.50
56-57	T-Bird	B6A-9590, 4 Bbl.....kit.	44.00
32-34	PU	B-9590, 4 cyl.....kit.	33.50
33-38	PU	67-9590, V-8, 97.....kit.	21.00
38-56	PU	59A-9590, V-8, 94.....kit.	30.00
41-51	PU	7HA-9590-A, 6 cyl.kit.	18.50
52-57	PU	B2A-9590, 6 cyl.....kit.	30.00
54-56	PU	B4AZ-9590-A, V-8, 2 Bbl.....kit.	27.50

Carburetor Gasket Set

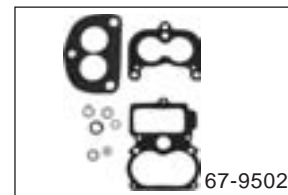

33-37	Pass	67-9502, 97set.	5.00
38-53	Pass	21A-9502, 94set.	5.00
39-48	Merc	21A-9502, 94set.	5.00
33-37	PU	67-9502, 97set.	5.00
38-53	PU	21A-9502, 94set.	5.00

Accelerator Pump

38-56	Pass	78-9631, for "94" carb.....ea.	9.50
39-48	Merc	78-9631, for "94" carb.....ea.	9.50
38-56	PU	78-9631, for "94" carb.....ea.	9.50

Carburetor Float

33-38	Pass	40-9550, "97".....ea.	14.00
38-53	Pass	78-9550, V-8 "94"ea.	15.00
39-48	Merc	78-9550, "94".....ea.	15.00

33-38	PU	40-9550, "97"	ea.	14.00
38-53	PU	78-9550, V-8 "94"	ea.	15.00

Carburetor Float Pin

33-38	Pass & PU	40-9558, "97" carb.....	ea.	9.50
-------	-----------	-------------------------	-----	------

Secondary Diaphragm



55-56	Pass	EBY-9503A, 4 Bbl.....	ea.	28.95
55-56	T-Bird	EBY-9503A, 4 Bbl.....	ea.	28.95
55-56	PU	EBY-9503A, 4 Bbl.....	ea.	28.95

Carburetor to Manifold Gasket

33-38	Pass	18-9447, 97.....	ea.	1.50
38-53	Pass	40-9447-B, 94.....	ea.	1.50
47-51	Pass	7HA-9447, 6 cyl.....	ea.	3.00
39-48	Merc	40-9447-B, 94.....	ea.	1.50
33-38	PU	18-9447, 97.....	ea.	1.50
38-53	PU	40-9447-B, 94.....	ea.	1.50
47-51	PU	7HA-9447, 6 cyl.....	ea.	3.00

Carburetor Grose Jet



33-38	Pass	STM-97, 97.....	ea.	20.00
38-55	Pass	HY-32, 94.....	ea.	20.00
39-48	Merc	HY-32, 94.....	ea.	20.00
33-38	PU	STM-97, 97.....	ea.	20.00
38-55	PU	HY-32, 94.....	ea.	20.00

Carburetor Jet Wrench



33-37	Pass	97-JETWRENCH	ea.	8.50
38-55	Pass	94-JETWRENCH	ea.	8.50
39-48	Merc	94-JETWRENCH	ea.	8.50
33-37	PU	97-JETWRENCH	ea.	8.50
38-55	PU	94-JETWRENCH	ea.	8.50

Carburetor Idle Adjuster Needle Spring

33-48	Pass	40-9578, V8, 2 req'd.....	ea.	1.00
39-48	Merc	40-9578, V8, 2 req'd.....	ea.	1.00
33-48	PU	40-9578, V8, 2 req'd.....	ea.	1.00

Carburetor Rubber Ball Kit

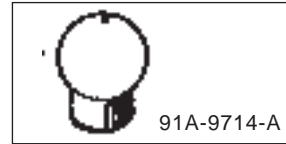

39-48	Pass	91A-9714A, V-8, 4 pcs.	kit.	4.00
39-48	Merc	91A-9714A, 4 pcs.	kit.	4.00
39-47	PU	91A-9714A, V-8, 4 pcs.	kit.	4.00

Choke Lever Assembly

Mounts on carburetor for choke cable to attach to.

49-53	Pass	EAB-9805-A, V8.....	ea.	10.00
48-53	PU	EAB-9805-A, V8.....	ea.	10.00

CHOKE/THROTTLE

Choke & Throttle Rods

32-38	Pass	B-9700, bend to fit.....	pr.	16.00
39	Pass	91A-9700, rod type	pr.	50.00
40	Pass	01A-9700	pr.	50.00
32-39	PU	B-9700, bend to fit.....	pr.	16.00

Choke & Throttle Cable/Rod Set

Set includes dash to carburetor with knobs, and grommets. These will fit Mercury, but the knobs are not the correct shape or color.



46	Dlx Pass	51A-9700-CTA, , w/brown knob, V-8	set.	150.00
46	Super Dlx	51A-9700-CTB, , w/blue gray knob, V-8.....	set.	150.00
46	Super Dlx	51A-9700-CTC, , w/gray tan knob, V-8	set.	150.00
47-48	Dlx Pass	6A-9700-CT, , w/tan knob, V-8.....	set.	150.00
47-48	Super Dlx	6A-9700-CT, w/tan knob, V-8.....	set.	150.00

Choke & Throttle Cable

49-51	Pass	8A-9700-C, V8, no knob	ea.	14.00
48-52	PU	7C-9700-U, V8, no knob	ea.	10.00

Throttle Cable

53-56	PU	BAAA-9700-TA, w/black knob	ea.	40.00
-------	----	----------------------------------	-----	-------



Choke & Throttle Rod Rubber Joint



39-48	Pass	91A-9702	pr.	10.00
39-48	Merc	91A-9702	pr.	10.00

Choke & Throttle Rod Connector Sleeve

32-36	Pass & PU	B-9702	ea.	2.00
-------	-----------	--------------	-----	------

AIR CLEANER

Chrome Louvered Air Cleaner & Clamp

Fits 97 or 94 carb. Includes filter.



34-56	Pass & PU	HR-9600-L4.....	ea.	11.00
-------	-----------	-----------------	-----	-------

Louvered Air Cleaner Filter

34-56	Pass & PU	HR-9600-E.....	ea.	4.50
-------	-----------	----------------	-----	------

Air Cleaner Filter Element

Made of copper mesh for dry type air cleaner.

33-36	Pass	18-9601	ea.	8.00
37-41	Pass	78-9601	ea.	13.00
39-41	Merc	78-9601	ea.	13.00
33-36	PU	18-9601	ea.	8.00
37-41	PU	78-9601	ea.	13.00

Air Cleaner Insert for Dry Type Air Cleaner



33-36	Pass	18-9601-KIT	kit.	12.00
37-41	Pass	78-9601-AK, w/round holes.....	kit.	29.00
37-41	Pass	78-9601-BK, w/square holes	kit.	29.00
39-41	Merc	78-9601-BK, w/square holes	kit.	29.00
33-36	PU	18-9601-KIT	kit.	12.00
37-41	PU	78-9601-AK, w/round holes.....	kit.	29.00
37-41	PU	78-9601-BK, w/square holes	kit.	29.00

GAS PEDAL/RELATED

Gas Pedal Linkage Rod

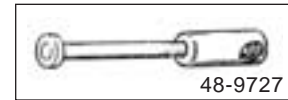

35-48	Pass	48-9727	ea.	9.00
55-56	Pass	B5A-9727-A	ea.	10.00
39-48	Merc	48-9727	ea.	9.00
48-52	PU	7HC-9738-C	ea.	10.00

Gas Pedal Linkage Rod Spring

48-52	PU	7HC-9760-C	ea.	2.00
-------	----	------------------	-----	------

Gas Linkage Rod

Between carburetor and gas pedal linkage on firewall.



33-38	Pass	40-9747, V-8	ea.	5.00
39-48	Pass	99A-9747-B, 10.44"	ea.	6.50
39-48	Merc	99A-9747-B, 10.44"	ea.	6.50
33-38	PU	40-9747, V-8	ea.	5.00
39-47	PU	99A-9747-B, 10.44"	ea.	6.50

Gas Pedal Return Spring



35-48	Pass	48-9737	ea.	6.00
55	Pass	B5A-9737-A, V-8, auto.....	ea.	6.00
55	Pass	B5A-9737-B, V-8, std & O.D.....	ea.	6.00
56	Pass	B6A-9737-C, V-8, 4 Bbl., std & O.D.....	ea.	6.00
39-48	Merc	48-9737	ea.	6.00
35-47	PU	48-9737	ea.	6.00

Kick Down Linkage Return Spring

55-56	Pass	B5A-9736A, V-8, 2 Bbl.....	ea.	6.00
56	Pass	B6A-9736-A, V-8, 4 Bbl., auto.....	ea.	5.00
56-57	T-Bird	B6A-9736-A, V-8, 4 Bbl., auto.....	ea.	5.00

Gas Pedal Rod To Firewall Seal

Only the #7C-8112177 is a bellows type. The other seals are flat with a hole in the center for the rod to pass through.



35-40	Pass	48-700350	ea.	2.00
-------	------	-----------------	-----	------

49-51	Pass	8A-7012177-S	ea.	3.00
52-56	Pass	BA-9738-S	ea.	2.00
39-40	Merc	48-700350	ea.	2.00
48-52	PU	7C-8112177	ea.	25.00

Foot Rest Post



28-34	Pass	A-9765	ea.	6.00
28-47	PU	A-9765	ea.	6.00

Foot Rest Post Base



28-34	Pass & PU	B-9770	ea.	5.00
-------	-----------	--------------	-----	------

Gas Pedal



35-40	Pass	48-9735	ea.	15.00
41-48	Pass	21A-9735	ea.	15.00
49-50	Pass	8A-9735	ea.	15.00
51	Pass	1A-9735	ea.	15.00
52-54	Pass	B4A-9735-A	ea.	11.00
55-56	Pass	B5A-9735-A	ea.	11.00
39-40	Merc	48-9735	ea.	15.00
41-48	Merc	21A-9735	ea.	15.00
50-51	Merc	8A-9735	ea.	15.00
52-54	Merc	B4A-9735-A	ea.	11.00
55-56	Merc	B5A-9735-A	ea.	11.00
48-56	PU	TAAA-9735	ea.	15.00

Gas Pedal Accessory Cover



49-54	Pass	8A-9738-S	ea.	16.50
-------	------	-----------------	-----	-------

**Section 17
Generator**

See section 14 for generator belts.

GENERATOR

Rebuilt Generator

Please send in your core for rebuilding. Can be built either 6 or 12 volt. Be sure to double box the core and pack well, cores are hard to come by.



34-38	Pass	5800, V-8 need your core.....	ea.	160.00
34-38	Pass	5800-12V, convert yours to 12 Volt, use 12 volt neg ground cutout	ea.	160.00
38-39	Pass	5812, need your core	ea.	160.00
40	Pass	5800-40, need your core	ea.	160.00
41	Pass	5800-41, need your core	ea.	160.00
42-47	Pass	5806, 6 cyl.,need your core	ea.	160.00
42-48	Pass	5805, V-8, need your core.....	ea.	160.00
49-53	Pass	5820, need your core	ea.	160.00
54-55	Pass	5833, V-8, need your core.....	ea.	160.00
54-55	Pass	5833-6CYL, 6 cyl.,need your core	ea.	160.00
56-64	Pass	5838, need your core	ea.	160.00
40	Merc	5800-40, need your core	ea.	160.00
41	Merc	5800-41, need your core	ea.	160.00
42-48	Merc	5805, need your core	ea.	160.00
49-53	Merc	5820, need your core	ea.	160.00
54-55	Merc	5833, need your core	ea.	160.00
56	Merc	5838, need your core	ea.	160.00
34-38	PU	5800, need your core	ea.	160.00
34-38	PU	5800-12V, convert yours to 12 Volt, use 12 volt neg ground cutout	ea.	160.00
38-39	PU	5812, need your core	ea.	160.00
40	PU	5800-40, need your core.....	ea.	160.00
41	PU	5800-41, need your core	ea.	160.00
42-47	PU	5806, , 6 cyl, need your core	ea.	160.00
42-47	PU	5805, V-8, need your core	ea.	160.00
48-53	PU	5820, need your core	ea.	160.00
54-55	PU	5833, need your core	ea.	160.00
54-55	PU	5833-6CYL, 6 cyl., need your core	ea.	160.00
56-64	PU	5838, need your core	ea.	160.00



Generator Armature



40-48	Pass	01A-10005, use clip on end of shaft	ea.	70.00
56-64	Pass	C1TZ-10005-A	ea.	25.00
40-48	Merc	01A-10005, use clip on end of shaft	ea.	70.00
40-47	PU	01A-10005, use clip on end of shaft	ea.	70.00
56-64	PU	C1TZ-10005-A	ea.	25.00

Generator Brush

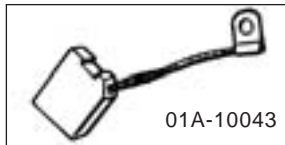

28-39	Pass	40-10043, set of 3	set.	3.00
40-59	Pass	01A-10043, set of 2	set.	3.50
40-56	Merc	01A-10043, set of 2	set.	3.50
28-39	PU	40-10043, set of 3	set.	3.00
40-59	PU	01A-10043, set of 2	set.	3.50

Generator Brush Spring



39-57	Pass	91A-10057, 2 req'd	ea.	3.50
39-56	Merc	91A-10057, 2 req'd	ea.	3.50
39-57	PU	91A-10057, 2 req'd	ea.	3.50

Generator Front End Plate

37-39	Pass	79-10139	ea.	20.00
56-64	Pass	B6A-10139-B	ea.	7.50
37-39	PU	79-10139	ea.	20.00
56-64	PU	B6A-10139-B	ea.	7.50

Generator Front Bearing



32-36	Pass	18-10094, w/race	ea.	35.00
37-39	Pass	79-10094	ea.	10.00
40-59	Pass	8BA-10094	ea.	9.00
40-56	Merc	8BA-10094	ea.	9.00
32-36	PU	18-10094, w/race	ea.	35.00
37-39	PU	79-10094	ea.	10.00
40-64	PU	8BA-10094	ea.	9.00

Generator Rear End Plate

32-39	Pass & PU	40-10129	ea.	20.00
-------	-----------	----------------	-----	-------

56-64	Pass & PU	C3AZ-10050-A	ea.	15.00
-------	-----------	--------------------	-----	-------

Generator Rear End Plate Bushing



37-55	Pass	78-10128	ea.	1.50
39-55	Merc	78-10128	ea.	1.50
37-55	PU	78-10128	ea.	1.50

Generator Rear Bearing

56-64	Pass	B6A-10095-B	ea.	14.00
56	Merc	B6A-10095-B	ea.	14.00
56-64	PU	B6A-10095-B	ea.	14.00

Generator Case Bolt

49-56	Pass	C3AZ-10120-A, 6-9/16" long 1/4-20 thread	ea.	4.00
49-56	Merc	C3AZ-10120-A, 6-9/16" long 1/4-20 thread	ea.	4.00
49-56	PU	C3AZ-10120-A, 6-9/16" long 1/4-20 thread	ea.	4.00

Generator Field Coil

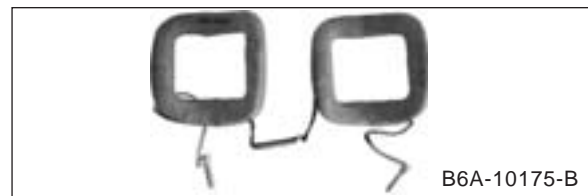

32-39	Pass	18-10175, 3-brush	set.	70.00
38-55	Pass	B6A-10175-B, 12V, 2-brush conversion	set.	62.00
38-55	Pass	01A-10175, 6V	set.	38.00
56-64	Pass	B6AZ-10175-D	ea.	20.00
39-55	Merc	B6A-10175-B, 12V, 2-brush conversion	set.	62.00
40-55	Merc	01A-10175, 6V	set.	38.00
32-39	PU	18-10175, 3-brush	set.	70.00
38-55	PU	B6A-10175-B, 12V, 2-brush conversion	set.	62.00
38-55	PU	01A-10175, 6V	set.	38.00
56-64	PU	B6AZ-10175-D	ea.	20.00

Generator Field Coil to Cutout Wire

9.75" long, goes through grommet #40-10104-A

33-39	Pass	40-10100A	ea.	3.20
33-39	PU	40-10100A	ea.	3.20

Generator Wire Grommet

32-39	Pass	40-10104-A	ea.	3.00
32-39	PU	40-10104-A	ea.	3.00

Generator Oiler Cap



30-53	Pass	B-10141	ea.	2.50
-------	------	---------------	-----	------

39-53	Merc	B-10141	ea.	2.50
30-53	PU	B-10141	ea.	2.50

Stainless Generator Cover

39-48	Pass	GENCOVER39-48, 2 hole	ea.	31.95
49-53	Pass	GENCOVER49-53, 2 pcs	ea.	31.95
39-48	Merc	GENCOVER39-48, 2 hole	ea.	31.95
49-53	Merc	GENCOVER49-53, 2 pcs	ea.	31.95
39-47	PU	GENCOVER39-48, 2 hole	ea.	31.95
48-53	PU	GENCOVER49-53, 2 pcs	ea.	31.95

CUTOUT

Generator Voltage Regulator

This is identical to original cutout, has Ford script, but is actually a electronic voltage regulator. The vehicle must be positive ground for 6V, and negative ground for 12V, and use three brush generator.



10505R-V8

32-39	Pass & PU	10505R-V8, V-8, 6V	ea.	82.00
32-39	Pass & PU	S10505R-V8N12, V-8, 12V	ea.	95.00

Generator Cutout Diode Conversion Kit

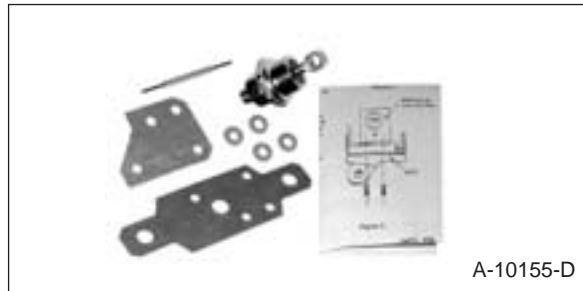

A-10155-D

28-39	Pass & PU	A-10155-D	kit.	13.00
-------	-----------	-----------------	------	-------

VOLTAGE REGULATOR

Voltage Regulator



51A-10505

C3TZ-10505-B

39-55	Pass	51A-10505, 6V	ea.	50.00
56-64	Pass	C3TZ-10505-B, 12V	ea.	54.00
39-55	Merc	51A-10505, 6V	ea.	50.00
56	Merc	C3TZ-10505-B, 12V	ea.	54.00
39-55	PU	51A-10505, 6V	ea.	50.00
56-64	PU	C3TZ-10505-B, 12V	ea.	54.00

Voltage Regulator Grommets



91A-10610-S3P

39-48	Pass	91A-10610-S3P	set.	4.50
39-48	Merc	91A-10610-S3P	set.	4.50
40-47	PU	91A-10610-S3P	set.	4.50

ALTERNATOR

6V Alternator w/Bracket Kit

Includes correct pulley for stated application. Can use original fan with 32-39Pass kit. Kits are for V-8 only except 60 HP. Please state if engine is stock or has been replaced with a newer flathead V8.

32-38	Pass	18-10300-K6	kit.	295.00
39	Std Pass	18-10300-K6	kit.	295.00
39	Dlx Pass	91A-10300-K6	kit.	235.00
40-41	Pass	91A-10300-K6	kit.	235.00
42-48	Pass	21A-10300-K6	kit.	235.00
49	Pass	8A-10300-K6	kit.	235.00
50-53	Pass	0A-10300-K6	kit.	260.00
54-55	Pass	B4A-10300-K6	kit.	295.00
32-39	PU	18-10300-K6	kit.	295.00
40-41	PU	91A-10300-K6	kit.	235.00
42-47	PU	21A-10300-K6	kit.	235.00
48-53	PU	8A-10300-K6	kit.	235.00
54-55	PU	B4A-10300-K6	kit.	295.00

12V Alternator w/Bracket Kit

Includes correct pulley for stated application. Can use original fan with 32-39Pass kit. Kits are for V-8 only except 60 HP. Please state if engine is stock or has been replaced with a newer flathead V8.

32-38	Pass	18-10300-12V	kit.	295.00
39	Std Pass	18-10300-12V	kit.	295.00
39	Dlx Pass	91A-10300-K12	kit.	235.00
40-41	Pass	91A-10300-K12	kit.	235.00
42-48	Pass	21A-10300-K12	kit.	235.00
49	Pass	8A-10300-K12	kit.	235.00
50-53	Pass	0A-10300-K12	kit.	260.00
54-55	Pass	B4A-10300-K12	kit.	295.00
56-62	Pass	B6A-10300-K12, fits 292, 312	kit.	295.00
32-39	PU	18-10300-12V	kit.	295.00
40-41	PU	91A-10300-K12	kit.	235.00
42-47	PU	21A-10300-K12	kit.	235.00
48-53	PU	8A-10300-K12	kit.	235.00
54-55	PU	B4A-10300-K12	kit.	295.00
56	PU	B6A-10300-K12	kit.	295.00



V-8 Alternator Bracket Plain Steel

These fit GM style alternators. For 49 Pass/Mercury, and 1948-52 PU, the alternator and the spacer must be ground 1/2" to set the alternator back to line up with the water pump pulleys.



33-41	Pass	B-10313-A	ea.	61.50
42-48	Pass	B-10313-C	ea.	70.00
49-53	Pass	B-10313-B, must modify the alternator on 49 wide belt.....	ea.	61.50
39-41	Merc	B-10313-A	ea.	61.50
42-48	Merc	B-10313-C	ea.	70.00
49-53	Merc	B-10313-B, must modify the alternator on 49 wide belt.....	ea.	61.50
33-41	PU	B-10313-A	ea.	61.50
42-47	PU	B-10313-C	ea.	70.00
48-53	PU	B-10313-B, must modify the alternator on wide belt.....	ea.	61.50

V-8 Alternator Bracket Chrome

These fit GM style alternators.

33-41	Pass	B-10313-AC, chrome	ea.	120.00
39-41	Merc	B-10313-AC, chrome	ea.	120.00
33-41	PU	B-10313-AC, chrome	ea.	120.00

Alternator Pulley

These fit GM style alternators.

32-38	Pass	B-10130-F, wide belt, to use with original fan.....	ea.	68.50
39	Std Pass	B-10130-F, wide belt, to use with original fan.....	ea.	68.50



32-49	Pass	A-10130-ALT, for wide belt, no provision for a fan	ea.	27.00
50-53	Pass	A-10130-N, for narrow belt 3/8"	ea.	35.00
39-49	Merc	A-10130-ALT, for wide belt, no provision for a fan	ea.	27.00
50-53	Merc	A-10130-N, for narrow belt 3/8"	ea.	35.00
32-39	PU	B-10130-F, wide belt, to use with original fan.....	ea.	68.50
32-53	PU	A-10130-ALT, for wide belt, no provision for a fan	ea.	27.00

Section 18 Battery

BATTERY

In an effort to save you money on shipping, we have the batteries shipped direct from our manufacturer to your door. If you would like to purchase a battery at our shop, an additional shipping charge will be added to the prices listed. C.C.A. = cold cranking amps.

Optima Battery Inside Script Battery Case

We are the source for these 6V Optima batteries sealed inside Ford licensed case. These spiralcell batteries do not require acid, so you don't have to worry about acid spills. Optima batteries have 800 C.C.A. and last up to two times longer than other batteries. Includes 4 year limited warranty with 1 year replacement on Optima Battery.

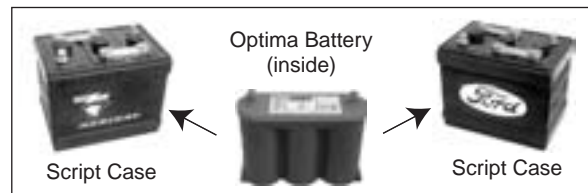

*33-34	Pass	OPT-2LF-SP, optima battery sticks out the bottom of case 1" ..	ea.	299.95
*35-38	Pass	OPT-2LF, optima battery sticks out the bottom of case 1" ..	ea.	299.95
*39	Std Pass	OPT-2LF, optima battery sticks out the bottom of case 1" ..	ea.	299.95
*39	Dlx Pass	OPT-2LF-SP, optima battery sticks out the bottom of case 1" ..	ea.	299.95
*40-51	Pass	OPT-2HF	ea.	299.95
*52-53	Pass	OPT-2HF-SP	ea.	299.95
*39	Merc	OPT-2LF-SP, optima battery sticks out the bottom of case 1" ..	ea.	299.95
*40-48	Merc	OPT-2HF	ea.	299.95
*49-53	Merc	OPT-2HM	ea.	299.95
*40-42	Zephyr	OPT-2HZ.....	ea.	299.95
*40-51	Linc	OPT-2HL.....	ea.	299.95
*33-34	PU	OPT-2LF-SP, optima battery sticks out the bottom of case 1" ..	ea.	299.95
*35-39	PU	OPT-2LF, optima battery sticks out the bottom of case 1" ..	ea.	299.95
*40-53	PU	OPT-2HF	ea.	299.95

Ford Script 12V Battery

Ford licensed. Sealed power unit technology. 4 year limited warranty.

*40-53	Pass & PU	2HF-12V, 700 CCA	ea.	299.95
*49-53	Merc	2HM-12V, 700 CCA	ea.	299.95

Original Style Script Battery

These script batteries are Ford licensed. They are shipped dry, so you need to add acid, which you can purchase from your local auto parts dealer. Limited Warranty = 1 year exchange

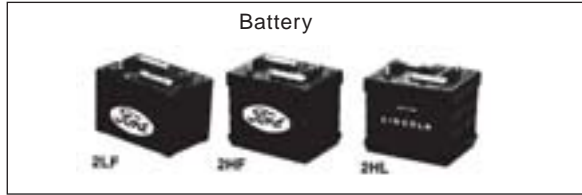

*33-36	Pass	2LF, 570 C.C.A.....ea.	Call
*37-39	Pass	2LF-SP, 570 C.C.A.....ea.	Call
*40-51	Pass	2HF, 570 C.C.A.....ea.	Call
*52-53	Pass	2HF-SP, 570 C.C.A.....ea.	Call
*54-55	Pass	2N, 600 C.C.A.....ea.	235.00
*56-60	Pass	29N, 400 C.C.A.....ea.	235.00
*56-64	Pass	29N-MF, no acid, maintenance free.....ea.	299.95
*56-60	Pass	32N, 420 C.C.A.....ea.	260.00
*49-53	Merc	2HM.....ea.	Call
*54-55	Merc	2NM.....ea.	Call
*56-64	Merc	29NM.....ea.	235.00
*56-64	Merc	32NM.....ea.	260.00
*40-53	Linc	2HL.....ea.	Call
*55	T-Bird	2N, 600 C.C.A.....ea.	235.00
*56-57	T-Bird	29N, 400 C.C.A.....ea.	235.00
*56-57	T-Bird	32N, 420 C.C.A.....ea.	260.00
*33-36	PU	2LF, 570 C.C.A.....ea.	Call
*37-39	PU	2LF-SP, 570 C.C.A.....ea.	Call
*40-53	PU	2HF, 570 C.C.A.....ea.	Call

Optima Battery

These are spiralc cell batteries that do not require acid. These batteries have 800 cold cranking amps, and last up to two times longer than regular batteries.



*All	Pass & PU	OPT-6V, 6V, 10"x 3-1/2"x7-3/8".....ea.	179.95
All	Pass & PU	OPT-6VCORE.....ea.	15.00
*All	Pass & PU	OPT-12VDBL, 12V, dual post, 10"x7"x6-3/4".....ea.	199.95
All	Pass & PU	OPT-12VCORE.....ea.	15.00

BOX/TRAY

Battery Support



32	Pass	B-5151.....ea.	37.00
----	------	----------------	-------

33-34	Pass	40-5151.....ea.	33.00
32-34	Big Truck	B-5151.....ea.	37.00
33-34	PU	40-5151.....ea.	33.00

Battery Frame Bracket



35-36	Pass & PU	48-5153.....ea.	22.00
-------	-----------	-----------------	-------

Firewall Battery Box

Weld in place on firewall.

37-38	Pass	78-700740.....ea.	125.00
-------	------	-------------------	--------



39	Std Pass	78-700740.....ea.	125.00
37-39	PU	78-700740.....ea.	125.00

Battery Tray



40	Pass	01A-10732.....ea.	50.00
----	------	-------------------	-------

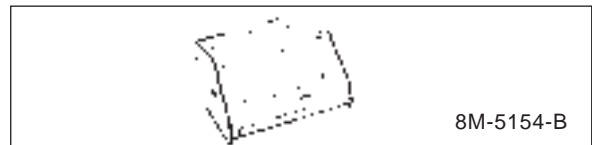

49-51	Pass	8M-5154-B.....ea.	60.00
52-53	Pass	BA-5154-B.....ea.	75.00
55	Pass	B5A-10764-A.....ea.	40.00
56	Pass	B6A-10732-A.....ea.	75.00
49-51	Merc	8M-5154-B.....ea.	60.00
40-41	PU	01A-10732.....ea.	50.00
48-52	PU	7RC-10732-C.....ea.	85.00
53	PU	B3C-10732-OR, original type.....ea.	70.00
53-55	PU	B4C-10732-D, use w/group 24.....ea.	70.00
54-55	PU	B4C-10732-OR, original type.....ea.	70.00
56	PU	B6C-10732-OR, original type.....ea.	70.00



B6C-10732-D

56 PU B6C-10732-D, use w/group 24...kit. 70.00

Battery Tray Kit

Includes tray, hold down, bolt, nuts, and washers.



11A-10732-K

41-48 Pass 11A-10732-Kkit. 125.00
 41-48 Merc 11A-10732-Kkit. 125.00

Battery Tray Bracket



B5A-10765-A

55 Pass B5A-10765-Aea. 45.00

Battery Hold Down Clamp



B-5163-S

30-32 Pass & PU B-5163-Sset. 4.00

Battery Hold Down Bracket on Firewall



91A-5171

40 Pass 01A-5171ea. 6.00
 39 DlX Pass 91A-5171ea. 17.00

40-41 PU 01A-5171ea. 6.00

Battery Hold Down Pad



01A-5158

40 Pass 01A-5158ea. 2.00
 40-41 PU 01A-5158ea. 2.00

Battery Hold Down



40-5165-A

32 Pass A-5165ea. 10.00
 33-38 Pass 40-5165-Aea. 15.00
 39 Std Pass 40-5165-Aea. 15.00
 41-53 Pass 40-5165-Aea. 15.00
 54-55 Pass B5A-10718-ARea. 12.95
 56-57 Pass B6AZ-10718-B, group 32N, 3 holesea. 30.00
 56-58 Pass B7A-10718-A, group 29N, 2 holesea. 22.95
 41-53 Merc 40-5165-Aea. 15.00
 56-60 T-Bird B7A-10718-A, group 29N, 2 holesea. 22.95
 32 PU A-5165ea. 10.00
 33-39 PU 40-5165-Aea. 15.00
 42-53 PU 40-5165-Aea. 15.00
 54-55 PU B5A-10718-ARea. 12.95
 56-58 PU B7A-10718-A, group 29N, 2 holesea. 22.95

Battery Hold Down Bolt Kit

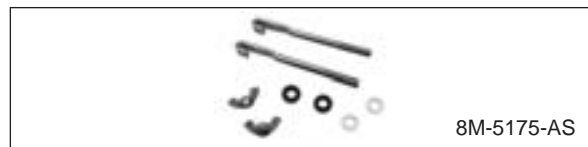

8M-5175-AS

49-53 Pass 8M-5175-AS, 5-1/4"kit. 10.00
 49-53 Pass 8M-5175-B, 3-3/4"kit. 10.00
 49-53 Merc 8M-5175-AS, 5-1/4"kit. 10.00
 49-53 Merc 8M-5175-B, 3-3/4"kit. 10.00

Battery Hold Down Bolt

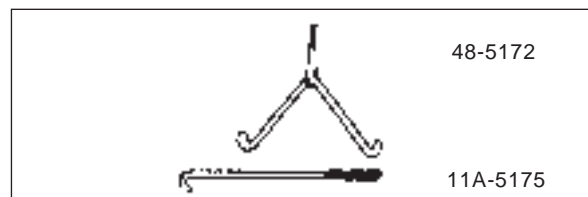

48-5172

11A-5175

35-36 Pass 48-5172, 2 req'dea. 13.50
 41-48 Pass 11A-5175ea. 4.00
 54-56 Pass B5A-10756-B, 9-3/4"ea. 3.95
 41-48 Merc 11A-5175ea. 4.00
 55-57 T-Bird B5A-10756-B, 9-3/4"ea. 3.95
 35-36 PU 48-5172, 2 req'dea. 13.50

42-52 PU 11A-5175.....ea. 4.00

Battery Hold Down Nut and Washer Kit

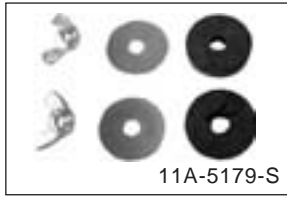

41-48 Pass 11A-5179-S.....set. 4.00
 54-56 Pass B6A-5179-S.....set. 5.00
 41-48 Merc 11A-5179-S.....set. 4.00
 55-57 T-Bird B6A-5179-S.....set. 5.00
 42-52 PU 11A-5179-S.....set. 4.00

HOLE COVER/SEALS

Battery Hole Cover

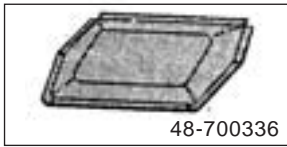

32 Pass A-35150-B.....ea. 6.75
 35-36 Pass 48-700336.....ea. 60.00
 53-55 PU BAAA-8101644.....ea. 40.00
 56 PU B6C-8101644.....ea. 35.00

Battery Hole Cover Seal

53-55 PU BAAA-8101645-B.....ea. 12.00
 56 PU B6C-8101645-B.....ea. 12.00

Rubber Battery Splash Seal

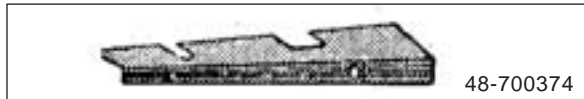

35-36 Pass 48-700374.....ea. 5.00
 53-56 PU B3C-5162-A.....ea. 3.00

CABLES

Battery to Ground Cable-Replacement



32-34 Pass 40-14301-NS.....ea. 12.00
 35 Pass 48-14301-NS.....ea. 12.00
 36 Pass 40-14301-NS.....ea. 12.00
 37-38 Pass 78-14301-NS.....ea. 12.00
 39 Std Pass 78-14301-NS.....ea. 12.00
 39 Dlx Pass 91A-14301-NS.....ea. 13.00
 40-48 Pass 91A-14301-NS, V-8.....ea. 13.00

49-51 Pass 8A-14301-NS.....ea. 13.00
 39-48 Merc 91A-14301-NS.....ea. 13.00
 32-34 PU 40-14301-NS.....ea. 12.00
 35 PU 48-14301-NS.....ea. 12.00
 36 PU 40-14301-NS.....ea. 12.00
 37-39 PU 78-14301-NS.....ea. 12.00
 40-47 PU 91A-14301-NS, V-8.....ea. 13.00

Ford Script Battery to Floor Switch Cable

32-34 Pass 18-14195.....ea. 25.00
 35-36 Pass 48-14300.....ea. 25.00
 32-34 PU 18-14195.....ea. 25.00
 35-36 PU 48-14300.....ea. 25.00

Battery to Floor Switch Cable-Replacement

32-34 Pass 18-14195-NS.....ea. 15.00
 35-36 Pass 48-14300-NS.....ea. 17.00
 35-36 Pass 48-14300-B, w/bracket.....ea. 30.00
 32-34 PU 18-14195-NS.....ea. 15.00
 35-36 PU 48-14300-NS.....ea. 17.00
 35-36 PU 48-14300-B, w/bracket.....ea. 30.00

Ford Script Battery to Floor Switch Cable

35-36 Pass 48-14300.....ea. 25.00
 35-36 PU 48-14300.....ea. 25.00

Battery to Starter Solenoid Cable-Replacement

37-38 Pass 78-14300-NS.....ea. 15.00
 39 Std Pass 78-14300-NS.....ea. 15.00
 39 Dlx Pass 91A-14300-NS.....ea. 17.00
 40-48 Pass 91A-14300-NS.....ea. 17.00
 49-51 Pass 8A-14300-NS.....ea. 20.00
 39-48 Merc 91A-14300-NS.....ea. 17.00
 37-39 PU 78-14300-NS.....ea. 15.00
 40-47 PU 91A-14300-NS.....ea. 17.00
 48-52 PU 8A-14300-NS.....ea. 20.00

Ford Script Battery to Starter Solenoid Cable



37-38 Pass 78-14300.....ea. 25.00
 39 Std Pass 78-14300.....ea. 25.00
 39 Dlx Pass 91A-14300.....ea. 25.00
 40-48 Pass 91A-14300.....ea. 25.00
 39-48 Merc 91A-14300.....ea. 25.00
 35-36 PU 48-14300-B, w/bracket.....ea. 30.00
 35-36 PU 48-14300.....ea. 25.00
 37-39 PU 78-14300.....ea. 25.00
 40-47 PU 91A-14300.....ea. 25.00

Floor Starter Switch to Starter Cable

32-34 Pass & PU B-14431, 4 cyl.....ea. 13.00
 32-36 Pass & PU 18-14431, V-8.....ea. 15.00



Starter Solenoid to Starter Cable

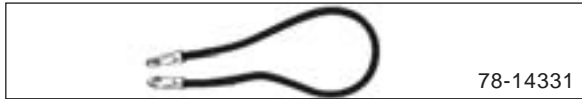

37-48	Pass	78-14431, V-8	ea.	16.00
49-51	Pass	8A-14431	ea.	18.00
39-48	Merc	78-14431	ea.	16.00
37-47	PU	78-14431, V-8	ea.	16.00

Engine Ground Strap

37-48	Pass	91A-14303, 8-1/4"	ea.	13.00
39-48	Merc	91A-14303, 8-1/4"	ea.	13.00
55-56	T-Bird	B5S-14303	ea.	11.00
57	T-Bird	B7S-14303	ea.	11.00
37-47	PU	91A-14303, 8-1/4"	ea.	13.00

Ford Script Battery Cable Sets

55	Pass	B5A-14300-AC, w/AC	set.	55.00
55	Pass	B5A-14300-B, w/o AC	set.	55.00
56	Pass	B6A-14300-AC, w/AC	set.	55.00
56	Pass	B6A-14300-B, w/o AC	set.	55.00
55	T-Bird	B5S-14300-K	set.	55.00
56	T-Bird	B6S-14300-K	set.	55.00
57	T-Bird	B7S-14300-K	set.	55.00

Starter Cable Bracket with Grommet



32-34	Pass & PU	18-14548/50	pr.	18.00
-------	-----------	-------------------	-----	-------



35-36	Pass	48-14550	ea.	11.00
32-34	PU	18-14548/50	pr.	18.00
48-56	PU	48-14550	ea.	11.00

Starter Cable Bracket Grommet

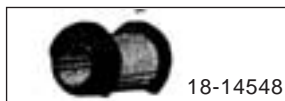

32-34	Pass & PU	18-14548	ea.	3.25
-------	-----------	----------------	-----	------

Rubber Starter Cable Holder



35-36	Pass & PU	48-14433	ea.	5.00
-------	-----------	----------------	-----	------

Battery Cable Frame Grommet



32-34	Pass & PU	B-14434	ea.	3.00
-------	-----------	---------------	-----	------

Battery Disconnect



All	Pass & PU	A-14300-C, mounts on post	ea.	13.00
All	Pass & PU	A-14300-D, permanent mount	ea.	30.00

Battery Post Protectors

32-56	All	51A-10682	pr.	2.50
-------	-----	-----------------	-----	------

**Section 19
Starter**

STARTER

New 6 Volt Starter with Drive

Brand new 6 volt starter with new style drive. No core required. Must use 51A-11150 bracket.



32-53	Pass	3103-STN, V8, will not fit 51-53 with automatic	ea.	169.95
39-53	Merc	3103-STN, V8, will not fit 51-53 with automatic	ea.	169.95
32-53	PU	3103-STN, will not fit 53 with automatic	ea.	169.95

New 12 Volt Starter with Drive

Brand new 12 volt starter with new style drive. No core required. Must use 51A-11150 bracket.

32-53	Pass	3103-STN12, V8, will not fit 51-53 with automatic	ea.	169.95
39-53	Merc	3103-STN12, V8, will not fit 51-53 with automatic	ea.	169.95
32-53	PU	3103-STN12, V8, will not fit 53 with automatic	ea.	169.95

Rebuilt Starters

The drive is not included. The core charge will apply if you do not send in your starter prior to placing your order, or if it is not identical to the one purchased.

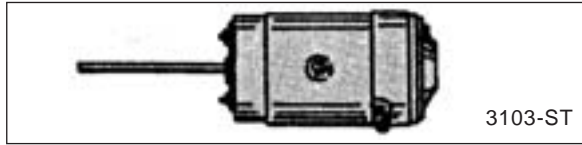

32-53	Pass	3103-ST, std,V-8	ea.	145.00
32-53	Pass	3103-STCORE, std, V8 core charge.....	ea.	150.00
49-51	Pass	3103-ST, , 6 cyl. need your core	ea.	145.00
51-53	Pass	3108-ST, auto, V-8, need your core	ea.	145.00
52-53	Pass	3108-ST, 6 cyl. need your core	ea.	145.00
54-55	Pass	3110-ST, , 6 cyl., V-8, need your core.....	ea.	145.00
56	Pass	3115-ST, 6 cyl., V-8, need your core.....	ea.	145.00
39-53	Merc	3103-ST, std,V-8	ea.	145.00
39-53	Merc	3103-STCORE, std, V8 core charge.....	ea.	150.00
51-53	Merc	3108-ST, auto, V-8, need your core	ea.	145.00
54-55	Merc	3110-ST, V-8, need your core	ea.	145.00
56	Merc	3115-ST, V-8, need your core	ea.	145.00
32-53	PU	3103-ST, std,V-8	ea.	145.00
32-53	PU	3103-STCORE, std, V8 core charge.....	ea.	150.00
48-51	PU	3103-ST, , 6 cyl. need your core	ea.	145.00
52-53	PU	3108-ST, , 6 cyl. need your core	ea.	145.00
53	PU	3108-ST, auto, 6 cyl., V-8, need your core..	ea.	145.00
54-55	PU	3110-ST, 6 cyl., V-8, need your core	ea.	145.00
56	PU	3115-ST, 6 cyl., V-8, need your core	ea.	145.00

STARTER PARTS

Starter Armature

32-53	Pass & PU	18-11005, standard trans	ea.	75.00
-------	-----------	--------------------------------	-----	-------

Starter Field Coils

32-48	Pass	18-11083/85	pr.	48.00
32-48	Merc	18-11083/85	pr.	48.00
32-47	PU	18-11083/85	pr.	48.00

Starter to Oil Pan Bracket



39-53	Pass	51A-11150, V-8	ea.	5.00
39-53	Merc	51A-11150	ea.	5.00

39-53	PU	51A-11150, V-8	ea.	5.00
-------	----	----------------------	-----	------

Starter Rear End Plate Bushing

28-53	Pass	B-11135	ea.	2.00
54-59	Pass	1CM-11135-A	ea.	2.50
39-53	Merc	B-11135	ea.	2.00
54-59	Merc	1CM-11135-A	ea.	2.50
28-53	PU	B-11135	ea.	2.00

Starter Front Plate Bushing



32-59	Pass	18-11052.....	ea.	1.25
39-56	Merc	18-11052.....	ea.	1.25
32-59	PU	18-11052.....	ea.	1.25

Starter Case Bolt

49-56	Pass	C3AZ-10120-A, 6-9/16" long 1/4-20 thread	ea.	4.00
49-56	Merc	C3AZ-10120-A, 6-9/16" long 1/4-20 thread	ea.	4.00
49-56	PU	C3AZ-10120-A, 6-9/16" long 1/4-20 thread	ea.	4.00

Starter Brushes

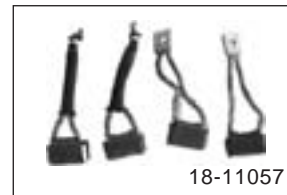

32-62	Pass	18-11057	set.	8.00
39-56	Merc	18-11057	set.	8.00
32-62	PU	18-11057	set.	8.00

Starter Brush Spring

32-53	Pass	B-11059	ea.	1.00
39-53	Merc	B-11059	ea.	1.00
32-53	PU	B-11059	ea.	1.00

Starter Terminal Post Kit



32-56	Pass	18-11102-O, w/oval hole.....	kit.	7.00
32-56	Pass	18-11102-R, w/round hole.....	kit.	7.00
39-56	Merc	18-11102-O, w/oval hole.....	kit.	7.00
39-56	Merc	18-11102-R, w/round hole.....	kit.	7.00
32-56	PU	18-11102-O, w/oval hole.....	kit.	7.00
32-56	PU	18-11102-R, w/round hole.....	kit.	7.00



Starter Rear End Plate w/Bushing

32-53	Pass	18-11130.....ea.	19.50
54-62	Pass	C2AZ-11130-A.....ea.	16.00
39-53	Merc	18-11130.....ea.	19.50
32-53	PU	18-11130.....ea.	19.50
54-64	PU	C2AZ-11130-A.....ea.	16.00

Y-Block V-8 Starter to Flywheel Housing Seal



54-59	Pass	B4A-6436.....ea.	10.00
54-56	Merc	B4A-6436.....ea.	10.00
54-59	PU	B4A-6436.....ea.	10.00

Starter Motor Cover Band

52-64	Pass	B1TZ-11126-A.....ea.	5.00
-------	------	----------------------	------

Stainless Starter Cover

Covers the whole starter. Gives the look of a chrome starter.

32-53	Pass	STARTCVR.....ea.	30.95
39-53	Merc	STARTCVR.....ea.	30.95
32-53	PU	STARTCVR.....ea.	30.95

DRIVE

Starter Drive

Reproduction of the original type.

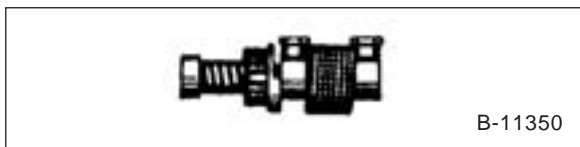

32-48	Pass	B-11350, w/10 teeth gear, 6 cyl., V-8.....ea.	40.00
49-51	Pass	B-11350, w/10 teeth gear, 6 cyl.....ea.	40.00
49-53	Pass	B-11350, w/10 teeth gear, V-8, std.....ea.	40.00
51-53	Pass	1CM-11350, V-8, auto.....ea.	42.00
52-53	Pass	1CM-11350, 6 cyl.....ea.	42.00
54-56	Pass	1CM-11350, 6 cyl., V-8.....ea.	42.00
39-53	Merc	B-11350, w/10 teeth gear, w/std.....ea.	40.00
51-53	Merc	1CM-11350, auto.....ea.	42.00
54-56	Merc	1CM-11350.....ea.	42.00
32-47	PU	B-11350, w/10 teeth gear, 6 cyl., V-8.....ea.	40.00
48-51	PU	B-11350, w/10 teeth gear, 6 cyl.....ea.	40.00
48-53	PU	B-11350, w/10 teeth, V-8, std.....ea.	40.00
52-53	PU	1CM-11350, 6 cyl.....ea.	42.00
53	PU	1CM-11350, 6 cyl., V-8, auto.....ea.	42.00

54-56	PU	1CM-11350, 6 cyl., V-8.....ea.	42.00
-------	----	--------------------------------	-------

Starter Drive Modern Type

New Style of starter drive. Fits original or reproduction starter.

32-53	Pass	B-11350-M, V8, except 51-53 with automatic.....ea.	40.00
39-53	Merc	B-11350-M, V8, except 51-53 with automatic.....ea.	40.00
32-53	PU	B-11350-M, V8, except 53 with automatic.....ea.	40.00

Starter Drive Spring

32-53	Pass	B-11375.....ea.	8.75
39-53	Merc	B-11375.....ea.	8.75
32-53	PU	B-11375.....ea.	8.75

Starter Drive Screw



32-53	Pass	B-11377, (.863).....ea.	.75
32-53	Pass	B-11382, (.688).....ea.	.75
39-53	Merc	B-11377, (.863).....ea.	.75
39-53	Merc	B-11382, (.688).....ea.	.75
32-53	PU	B-11377, (.863).....ea.	.75
32-53	PU	B-11382, (.688).....ea.	.75

Starter Drive Screw Lock Washer



28-53	Pass	B-11379.....ea.	.50
39-53	Merc	B-11379.....ea.	.50
28-53	PU	B-11379.....ea.	.50

SOLENOID

Starter Solenoid



37-50	Pass	01A-11450-F, steel, w/Ford script, w/button.....ea.	25.00
49-50	Pass	21A-11450-M, steel, w/FoMoCo logo, no button.....ea.	25.00

37-50	Pass	21A-11450, , bakelite, w/buttonea.	16.00
37-51	Wagon	21A-11450-M, steel, w/FoMoCo logo, no buttonea.	25.00
51-55	Pass	24041, steel, no buttonea.	32.00
56-72	Pass	B6A-11450, 12Vea.	13.00
39-51	Merc	01A-11450-F, steel, w/Ford script, w/buttonea.	25.00
49-51	Merc	21A-11450-M, steel, w/FoMoCo logo, no buttonea.	25.00
39-51	Merc	21A-11450, , bakelite, w/buttonea.	16.00
52-55	Merc	24041, steel, no buttonea.	32.00
56-72	Merc	B6A-11450, 12Vea.	13.00
37-51	PU	01A-11450-F, steel, w/Ford script, w/buttonea.	25.00
48-51	PU	21A-11450-M, steel, w/FoMoCo logo, no buttonea.	25.00
37-51	PU	21A-11450, , bakelite, w/buttonea.	16.00
52-55	PU	24041, steel, no buttonea.	32.00
56-72	PU	B6A-11450, 12Vea.	13.00

41	Pass	11A-11500, tanea.	10.00
42	Dlx Pass	21A-11500-A, maroonea.	10.00
42	Super Dlx	21A-11500-B, butterscotch.....ea.	10.00
46	Dlx Pass	51A-11500-A, chocolate.....ea.	10.00
46	Super Dlx	51A-11500-C, gray tanea.	10.00
46	Super Dlx	51A-11500-B, blue grayea.	10.00
47-48	Dlx Pass	51A-11500-C, gray tanea.	10.00
47-48	Super Dlx	51A-11500-C, gray tanea.	10.00
39	Merc	99A-11500, pink.....ea.	10.00
40	Merc	09A-11500, dk. blue.....ea.	10.00
40	PU	01A-11500-A, tan.....ea.	10.00
52-55	PU	2C-11500, black.....ea.	12.00

STARTER BUTTON

Starter Floor Switch

Part #40-11450 are old stock and are shelf worn.



32-34	Pass	40-11450.....ea.	32.00
35-36	Pass	48-11450.....ea.	25.00
32-34	PU	40-11450.....ea.	32.00
32-36	Truck	40-11450.....ea.	32.00
35-36	PU	48-11450.....ea.	25.00

Starter Floor Switch Rod



32-34	Pass & PU	18-11470.....ea.	2.25
-------	-----------	------------------	------

Original Style Starter Button



32	Pass	B-11500, 4 cyl., mahogany.....ea.	7.00
37	Std Pass	78-11500-A, lt. brownea.	10.00
37	Dlx Pass	78-11500-B, yellow brownea.	10.00
38	Pass	81A-11500, ivory.....ea.	10.00
39	Pass	91A-11500, lt. yellowea.	10.00
40	Std Pass	01A-11500-A, tan.....ea.	10.00
40	Dlx Pass	01A-11500-B, maroon.....ea.	10.00

Chrome Starter Button

At this time only a plain face is available. Please call on availability with "Start" on the face like original.



37-50	Pass	6A-11500.....ea.	9.50
37-51	Wagon	6A-11500.....ea.	9.50
39-50	Merc	6A-11500.....ea.	9.50
37-51	PU	6A-11500.....ea.	9.50

Universal Starter Button w/2 Poles

Hole in dash must be enlarged.



37-50	Pass	U-11500.....ea.	18.00
39-50	Merc	U-11500.....ea.	18.00
37-51	PU	U-11500.....ea.	18.00



1946 Lincoln Convertible

Guy Allen Sr.



Section 20 Ignition

DISTRIBUTOR PARTS

Rebuilt Distributors

The core charge will apply if you do not send in your distributor prior to placing your order, or if it is not identical to the one purchased. We can rebuild your distributor, or exchange it for one already rebuilt. We completely disassemble, bead blast, replace bushings and other parts as needed. All distributors are strobed and ready to run.



32-36	Pass	40-12127, V-8, w/3 bolt coil.....ea.	175.00
32-36	Pass	40-12127-CORE, core charge.....ea.	100.00
36	Pass	68-12127, late 36, w/2 bolt coil, must send in core.....ea.	205.00
37-41	Pass	78-12127, V-8	205.00
37-41	Pass	78-12127-CORE, core charge.....ea.	100.00
41-47	Pass	1GA-12127, early 47, 6cyl must rebuild your core.....ea.	160.00
42	Pass	21A-12127, V-8, w/clips.....ea.	160.00
42	Pass	21A-12127CORE, core charge.....ea.	125.00

46-48	Pass	59A-12127, V-8, w/bail	160.00
46-48	Pass	59A-12127CORE, core charge.....ea.	100.00
47-51	Pass	7HA-12127, 6 cyl. sold outright.....ea.	100.00
49-53	Pass	8BA-12127, V-8, w/cast iron timing cvr.....ea.	160.00
49-53	Pass	8BA-12127-CORE, core charge.....ea.	100.00
49-53	Pass	0BA-12127, V-8, w/aluminum timing cvr	160.00
49-53	Pass	0BA-12127-CORE, core charge.....ea.	100.00
52-54	Pass	FAA-12127-C, 6 cyl, sold outright.....ea.	125.00
39-41	Merc	78-12127, V-8	205.00
39-41	Merc	78-12127-CORE, core charge.....ea.	100.00
42	Merc	21A-12127, V-8, w/clips.....ea.	160.00
42	Merc	21A-12127CORE, core charge.....ea.	125.00
46-48	Merc	59A-12127, V-8, w/bail	160.00
46-48	Merc	59A-12127CORE, core charge.....ea.	100.00
49-53	Merc	8BA-12127, V-8, w/cast iron timing cvr.....ea.	160.00
49-53	Merc	8BA-12127-CORE, core charge.....ea.	100.00
49-53	Merc	0BA-12127, V-8, w/aluminum timing cvr	160.00
49-53	Merc	0BA-12127-CORE, , core charge.....ea.	100.00
32-36	PU	40-12127, V-8, w/3 bolt coil.....ea.	175.00
32-36	PU	40-12127-CORE, core charge.....ea.	100.00
37-41	PU	78-12127, V-8	205.00
37-41	PU	78-12127-CORE, core charge.....ea.	100.00
41-47	PU	1GA-12127, early 47, 6cyl must rebuild your core.....ea.	160.00
42	PU	21A-12127, V-8, w/clips.....ea.	160.00
42	PU	21A-12127CORE, core charge.....ea.	125.00
46-47	PU	59A-12127, V-8, w/bail	160.00
46-47	PU	59A-12127CORE, core charge.....ea.	100.00
47-51	PU	7HA-12127, 6 cyl. sold outright.....ea.	100.00
48-53	PU	8BA-12127, V-8, w/cast iron timing cvr.....ea.	160.00
48-53	PU	8BA-12127-CORE, core charge.....ea.	100.00
48-53	PU	0BA-12127, V-8, w/aluminum timing cover.....ea.	160.00
48-53	PU	0BA-12127-CORE, , core charge.....ea.	100.00
52-54	PU	FAA-12127-C, 6 cyl, sold outright.....ea.	125.00

Distributor Gasket Set

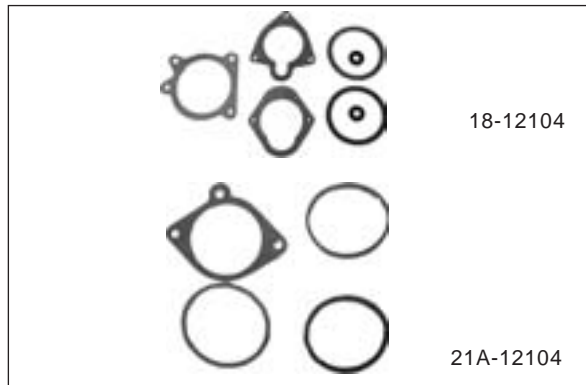

32-41	Pass	18-12104, V-8set.	6.00
42-48	Pass	21A-12104, V-8set.	8.00
32-41	Merc	18-12104, V-8set.	6.00
42-48	Merc	21A-12104, V-8set.	8.00
32-41	PU	18-12104, V-8set.	6.00
42-47	PU	21A-12104, V-8set.	8.00

Distributor Bushing



32-41	Pass	40-12120, frontea.	6.00
42-48	Pass	1GA-12120, frontea.	4.00
32-48	Pass	18-12132, rearea.	2.75
39-41	Merc	40-12120, frontea.	6.00
42-48	Merc	1GA-12120, frontea.	4.00
39-48	Merc	18-12132, rearea.	2.75
32-41	PU	40-12120, frontea.	6.00
42-47	PU	1GA-12120, frontea.	4.00
32-47	PU	18-12132, rearea.	2.75

Distributor Shaft Gear

49-53	Pass	7RA-12390-C, V8ea.	24.50
54-59	Pass	FAE-12390-A, V8, 14 teethea.	15.00
49-53	Merc	7RA-12390-C, V8ea.	24.50
54-59	Merc	FAE-12390-A, V8, 14 teethea.	15.00
48-53	PU	7RA-12390-C, V8ea.	24.50
54-59	PU	FAE-12390-A, V8, 14 teethea.	15.00

Distributor Cam & Weight Assembly

37-48	Pass	11A-12176ea.	15.00
39-48	Merc	11A-12176ea.	15.00
37-47	PU	11A-12176ea.	15.00

Distributor Vacuum Brake Plunger

Spring is NOT available.



32-48	Pass	18-12220ea.	10.00
39-48	Merc	18-12220ea.	10.00

32-47	PU	18-12220ea.	10.00
-------	----	----------	----------	-------

Distributor Vacuum Line

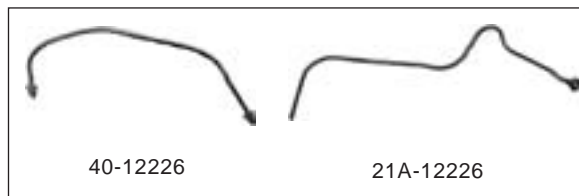

33-40	Pass	40-12226, V-8ea.	6.75
41-48	Pass	21A-12226, V-8ea.	10.50
39-40	Merc	40-12226, V-8ea.	6.75
41-48	Merc	21A-12226, V-8ea.	10.50
33-40	PU	40-12226, V-8ea.	6.75
41-47	PU	21A-12226, V-8ea.	10.50

Distributor Vacuum Line Fitting



32-53	Pass	490-251ea.	1.50
39-53	Merc	490-251ea.	1.50
32-53	PU	490-251ea.	1.50

Distributor Rubber Grommet and Rivet



42-48	Pass	1GA-12135-Skit.	3.00
42-48	Merc	1GA-12135-Skit.	3.00
42-47	PU	1GA-12135-Skit.	3.00

Distributor Inspection Hole Plug



32-36	Pass	18-12138pr.	6.00
32-36	PU	18-12138pr.	6.00



Distributor Terminal Wire



7RA-12216

49-60	Pass	7RA-12216, V-8.....ea.	3.00
49-64	Pass	7RA-12216, 6 cyl.ea.	3.00
49-56	Merc	7RA-12216ea.	3.00
48-60	PU	7RA-12216, V-8.....ea.	3.00
48-64	PU	7RA-12216, 6 cyl.ea.	3.00

Distributor Point Plate Ground Wire

49-56	Pass	7RA-12264, V-8.....ea.	3.50
49-64	Pass	7RA-12264, 6 cyl.ea.	3.50
49-64	Merc	7RA-12264ea.	3.50
48-56	PU	7RA-12264, V-8.....ea.	3.50
48-64	PU	7RA-12264, 6 cyl.ea.	3.50

Distributor Vacuum Advance



7RA-12370-B

47-70	Pass	7RA-12370-B, 6 cyl.ea.	25.00
49-53	Pass	7RA-12370-B, V-8.....ea.	25.00
54-56	Pass	FAB-12370-A, V-8, NOS.....ea.	60.00
49-53	Merc	7RA-12370-Bea.	25.00
47-70	PU	7RA-12370-B, 6 cyl.ea.	25.00
48-53	PU	7RA-12370-B, V-8.....ea.	25.00
54-56	PU	FAB-12370-A, V-8, NOS.....ea.	60.00

Distributor Mounting Bolt

These are NOS, covered in cosmoline. Sold each.

32-48	Pass	48-12148, V-8ea.	1.00
39-48	Merc	48-12148.....ea.	1.00
32-47	PU	48-12148, V-8ea.	1.00

12 Volt Electronic Ignition Kit

Price includes a new coil, and new electronic ignition module ready for you to install into your distributor.



EI-49-53-12V

49-53	Pass	EI-49-53-12V, V-8.....ea.	150.00
54-56	Pass	EI-54-56-12V, V-8.....ea.	160.00
49-53	Merc	EI-49-53-12V, V-8.....ea.	150.00
54-56	Merc	EI-54-56-12V, V-8.....ea.	160.00
48-53	PU	EI-49-53-12V, V-8.....ea.	150.00
54-56	PU	EI-54-56-12V, V-8.....ea.	160.00

6 Volt Electronic Ignition Kit

Price includes a new coil, and new electronic ignition module ready for you to install into your distributor.

54-55	Pass	EI-54-55-6V, V8.....ea.	145.00
54-55	PU	EI-54-55-6V, V8.....ea.	145.00

TUNE-UP KIT

Points, Rotor, Condenser Kit

49-64	Pass	7RA-12171-SET, 6 cyl.set.	12.00
49-53	Pass	7RA-12171-SET, V-8.....set.	12.00
54-56	Pass	FAB-12171-SET, V-8.....set.	12.00
49-53	Merc	7RA-12171-SETset.	12.00
54-56	Merc	FAB-12171-SET, V-8.....set.	12.00
48-64	PU	7RA-12171-SET, 6 cyl.set.	12.00
48-53	PU	7RA-12171-SET, V-8.....set.	12.00
54-56	PU	FAB-12171-SET, V-8.....set.	12.00

POINTS

Point Gap	
32-36 Pass V-8	.012-.014
37-48 Pass V-8	.014-.016
41-46 Pass 6 cyl	.014-.016
47-51 Pass 6 cyl	.024-.026
49-53 Pass V-8	.014-.016
52-56 Pass 6 cyl	.024-.026
54-56 Pass V-8	.014-.016
32-36 PU V-8	.012-.014
37-47 PU V-8	.014-.016
41-46 PU 6 cyl	.014-.016
47-51 PU 6 cyl	.024-.026
48-53 PU V-8	.014-.016
52-56 PU 6 cyl	.024-.026
54-56 PU V-8	.014-.016

Points

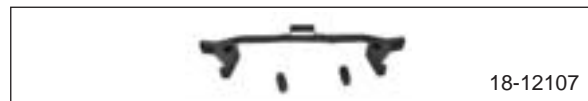

18-12107



68-12107

28-31	Pass	A-12199set.	10.50
32-34	Pass	B-12199, 4 cyl.set.	23.50
32-36	Pass	18-12107, V-8set.	18.00
37-48	Pass	68-12107, V-8set.	30.00
41-48	Pass	1GA-12107, 6 cyl.set.	17.00
49-53	Pass	7RA-12171, V-8.....set.	4.00

49-64	Pass	7RA-12171, 6 cyl.set.	4.00
54-56	Pass	FAB-12171, V-8set.	4.50
39-48	Merc	68-12107set.	30.00
49-53	Merc	7RA-12171set.	4.00
54-56	Merc	FAB-12171set.	4.50
28-31	PU	A-12199set.	10.50
32-34	PU	B-12199, 4 cyl.set.	23.50
32-36	PU	18-12107, V-8set.	18.00
37-47	PU	68-12107, V-8set.	30.00
41-47	PU	1GA-12107, 6 cyl.set.	17.00
48-53	PU	7RA-12171, V-8set.	4.00
48-64	PU	7RA-12171, 6 cyl.set.	4.00
54-56	PU	FAB-12171, V-8set.	4.50

CONDENSER

Condenser



28-31	Pass	A-12300ea.	14.00
32-33	Pass	B-12300, 4 cyl.ea.	12.00
32-36	Pass	18-12300, V-8, w/3 bolt coilea.	10.00
37-41	Pass	78-12300ea.	10.50
37-41	Pass	81A-12300, use w/81A coilea.	7.00
42-48	Pass	1GA-12300ea.	10.00
49-56	Pass	7RA-12300, V-8, 6 cyl.ea.	4.50
39-41	Merc	78-12300ea.	10.50
37-41	Merc	81A-12300, use w/81A coilea.	7.00
42-48	Merc	1GA-12300ea.	10.00
49-56	Merc	7RA-12300ea.	4.50
28-31	PU	A-12300ea.	14.00
32-33	PU	B-12300, 4 cyl.ea.	12.00
32-36	PU	18-12300, V-8, w/3 bolt coilea.	10.00
37-41	PU	78-12300ea.	10.50
37-41	PU	81A-12300, use w/81A coilea.	7.00
42-47	PU	1GA-12300ea.	10.00

Condenser Boot

42-48	Pass	1GA-12312ea.	3.00
42-48	Merc	1GA-12312ea.	3.00
42-47	PU	1GA-12312ea.	3.00

ROTOR

Rotor



28-34	Pass	B-12200, 4 cyl.ea.	4.00
32-36	Pass	18-12200, V-8ea.	35.00
37-41	Pass	78-12200, V-8ea.	25.00

41-47	Pass	1GA-12200, 6 cyl., w/G-series engineea.	4.00
42-48	Pass	21A-12200, V-8 for use w/crab distributor capea.	9.00
46-56	Pass	59A-12200, V-8ea.	3.00
47-70	Pass	59A-12200, 6 cyl.ea.	3.00
39-41	Merc	78-12200ea.	25.00
42-48	Merc	21A-12200, for use w/crab distributor capea.	9.00
46-56	Merc	59A-12200ea.	3.00
28-34	PU	B-12200, 4 cyl.ea.	4.00
32-36	PU	18-12200, V-8ea.	35.00
37-41	PU	78-12200ea.	25.00
41-47	PU	1GA-12200, 6 cyl., w/G-series engineea.	4.00
42-47	PU	21A-12200, V-8 for use w/crab distributor capea.	9.00
46-56	PU	59A-12200, V-8ea.	3.00
47-70	PU	59A-12200, 6 cyl.ea.	3.00

Distributor Shaft to Rotor Clip



49-64	Pass	OBA-12213ea.	5.00
49-56	Merc	OBA-12213ea.	5.00
49-64	PU	OBA-12213ea.	5.00

CAP & WIRE SET

Distributor Cap & Plug Wire Set

Includes modern cap & plug wires

28-34	Pass & PU	A-12105-M, 4 cyl.set.	32.00
-------	-----------	----------------------------	-------

CAPS

Outer Distributor Cap



32-41	Pass	18-12105, V-8, blackea.	14.50
32-41	Pass	01A-12106, V-8, brownea.	14.50
46-48	Pass	59A-12105, V-8ea.	20.00
39-41	Merc	18-12105, blackea.	14.50
39-41	Merc	01A-12106, brownea.	14.50
46-48	Merc	59A-12105ea.	20.00
32-41	PU	18-12105, V-8, blackea.	14.50
32-41	PU	01A-12106, V-8, brownea.	14.50
46-47	PU	59A-12105, V-8ea.	20.00



Inner Distributor Cap



32-36	Pass	18-12116, V-8ea.	24.50
37-41	Pass	68-12116, V-8ea.	20.00
46-48	Pass	59A-12106, V-8ea.	30.00
39-41	Merc	68-12116ea.	20.00
46-48	Merc	59A-12106ea.	30.00
32-36	PU	18-12116, V-8ea.	24.50
37-41	PU	68-12116, V-8ea.	20.00
46-47	PU	59A-12106, V-8ea.	30.00

One Piece Style Distributor Cap



28-34	Pass	B-12115, 4 cyl.ea.	4.50
41-48	Pass	1GA-12106, 6 cyl., crab typeea.	39.00
42-48	Pass	21A-12106, V-8, crab typeea.	22.00
47-70	Pass	7HA-12106, 6 cyl.ea.	9.00
49-56	Pass	FAB-12106-C, V-8ea.	10.00
42-48	Merc	21A-12106, crab typeea.	22.00
49-56	Merc	FAB-12106-Cea.	10.00
28-34	PU	B-12115, 4 cyl.ea.	4.50
41-48	PU	1GA-12106, 6 cyl., crab typeea.	39.00
42-47	PU	21A-12106, V-8, crab typeea.	22.00
47-70	PU	7HA-12106, 6 cyl.ea.	9.00
48-56	PU	FAB-12106-C, V-8ea.	10.00

Distributor Body

28-34	Pass & PU	B-12105, 4 cyl.ea.	19.00
-------	-----------	-----------------	----------	-------

Distributor Cap Clips

For use with 21A-12106 cap, pins not included.

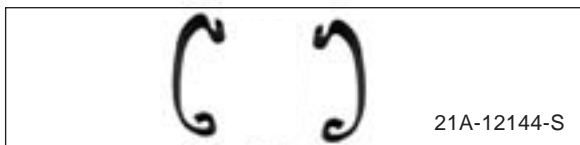

42-48	Pass	21A-12144-Spr.	4.50
42-48	Merc	21A-12144-Spr.	4.50
42-47	PU	21A-12144-Spr.	4.50

Distributor Cap Bail

46-48	Pass	59A-12144, V8ea.	3.00
46-48	Merc	59A-12144, V8ea.	3.00
46-47	PU	59A-12144, V8ea.	3.00

Inner to Outer Distributor Cap Clips

46-48	Pass	59A-12109, V-8pr.	6.00
-------	------	----------------	----------	------

46-48	Merc	59A-12109, V-8pr.	6.00
46-47	PU	59A-12109, V-8pr.	6.00

Distributor Cap Clips without Pins

47-56	Pass	7RA-12144, 6 cyl.pr.	8.00
49-56	Pass	7RA-12144, V-8pr.	8.00
49-56	Merc	7RA-12144pr.	8.00
47-56	PU	7RA-12144, 6 cyl.pr.	8.00
48-56	PU	7RA-12144, V-8pr.	8.00

PLUG WIRES

Spark Plug Wire Sets

These have a copper core.



32-36	Pass	18-12259-A, V-8, w/original brass ringset.	42.72
32-36	Pass	18-12259-B, V-8, modern styleset.	42.72
37-41	Pass	78-12259, V-8set.	44.42
42-44	Pass	21A-12259, V-8, for crab dist. capset.	51.74
46-47	Pass	5GA-12259, 6 cyl., G-seriesset.	37.80
46-48	Pass	59A-12259, V-8set.	49.66
47-51	Pass	7HA-12259, 6 cyl., H-seriesset.	42.76
49-50	Pass	8BA-12259, V-8set.	47.82
49-51	Pass	B1A-12259-A, 6 cyl.set.	55.28
49-53	Pass	1A-12259W, V-8, molded endsset.	70.12
49-53	Pass	1A-12259, V-8, molded ends, w/"Fomoco"set.	83.00
52-53	Pass	B2A-12259-A, 6 cyl.set.	50.42
54-60	Pass	B4A-12259-B, 6 cyl.set.	52.30
54-62	Pass	B5A-12259, Y-block, w/scriptset.	89.00
39-41	Merc	78-12259, V-8set.	44.42
42-44	Merc	21A-12259, for crab dist. capset.	51.74
46-48	Merc	59A-12259set.	49.66
49-50	Merc	8BA-12259set.	47.82
49-53	Merc	1A-12259W, molded endsset.	70.12
49-53	Merc	1A-12259, molded ends, w/"Fomoco"set.	83.00
54-62	Merc	B5A-12259, Y-block, w/scriptset.	89.00
32-36	PU	18-12259-A, V-8, w/original brass ringset.	42.72
32-36	PU	18-12259-B, V-8, modern styleset.	42.72
37-41	PU	78-12259, V-8set.	44.42
42-44	PU	21A-12259, V-8, for crab dist. capset.	51.74
45-47	PU	59A-12259, V-8set.	49.66

46-47	PU	5GA-12259, 6 cyl., G-series.....set.	37.80
47-51	PU	7HA-12259, 6 cyl., H-series.....set.	42.76
48-53	PU	8BA-12259, V-8.....set.	47.82
48-53	PU	1A-12259, V-8, molded ends, w/"Fomoco".....set.	83.00
48-53	PU	1A-12259W, V-8, molded ends.....set.	70.12
52-53	Truck	B2Q-12259, w/317 V8.....set.	83.74
54-60	PU	B4A-12259-B, 6 cyl.....set.	52.30
54-64	PU	B5A-12259, Y-block, w/script.....set.	89.00
54-64	PU	D1AZ-12259-A, Y-block.....set.	76.54

Spark Plug Wire Loom to Distributor Cap Seal

32-41	Pass	18-12113, V-8.....pr.	8.00
46-47	Pass	5GA-12113, 6 cyl "G" series.....ea.	10.00
46-48	Pass	59A-12113-S, V-8.....pr.	15.00
39-41	Merc	18-12113.....pr.	8.00
46-48	Merc	59A-12113-S.....pr.	15.00
32-41	PU	18-12113, V-8.....pr.	8.00
46-47	PU	5GA-12113, 6 cyl "G" series.....ea.	10.00
46-47	PU	59A-12113-S, V-8.....pr.	15.00

Spark Plug to Distributor Cap Connectors

32-34	Pass & PU	B-12275-S, 4 cyl.....set.	3.00
-------	-----------	---------------------------	------

Chrome Spark Plug Wire Looms

*Mounts on top of intake manifold. Plug wires are not included.
Must use universal spark plug wires from local auto parts store.
Available for V8 engines only.*

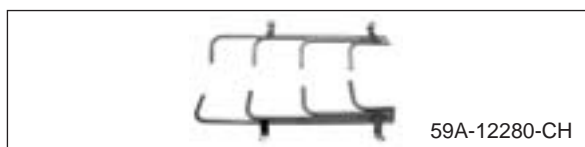

42-48	Pass	59A-12280-CH.....set.	75.00
49-53	Pass	8BA-12280-CH.....set.	75.00
42-48	Merc	59A-12280-CH.....set.	75.00
42-47	PU	59A-12280-CH.....set.	75.00
49-53	PU	8BA-12280-CH.....set.	75.00

“You all have been so helpful in getting my 51 restored and back on the road after more than 35 years. Thanks for all the help!”
Dave M., New Mexico

Y-Block V-8 Spark Plug Wire Brackets & Grommets

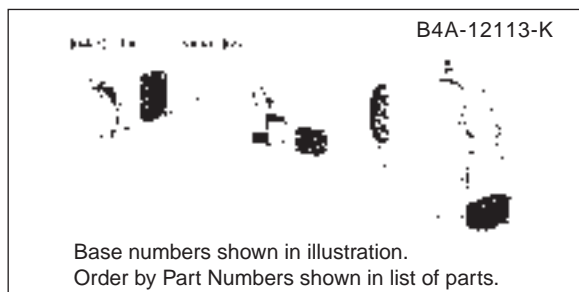

Base numbers shown in illustration.
Order by Part Numbers shown in list of parts.

54-62	Pass	B4A-12113-K.....kit.	25.50
54-56	Merc	B4A-12113-K.....kit.	25.50
54-64	PU	B4A-12113-K.....kit.	25.50

Y-Block V-8 Spark Plug Wire Bracket Grommet Set



54-62	Pass	FAA-12297-K.....kit.	14.00
54-56	Merc	FAA-12297-K.....kit.	14.00
54-64	PU	FAA-12297-K.....kit.	14.00

Y-Block V-8 Spark Plug Wire Bracket Grommet

54-62	Pass	FAA-12297-A.....ea.	3.00
54-56	Merc	FAA-12297-A.....ea.	3.00
54-64	PU	FAA-12297-A.....ea.	3.00

Spark Plug Wire Separator – 8 Prong

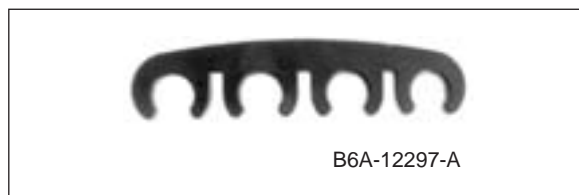

54-UP	Pass	B6A-12297-A.....ea.	2.00
54-56	Merc	B6A-12297-A.....ea.	2.00
54-UP	PU	B6A-12297-A.....ea.	2.00



SPARK PLUGS

Spark Plug Gap

32-48 Pass	V-8	.025
41-46 Pass	6 cyl	.025
47-51 Pass	6 cyl	.029-.032
49-53 Pass	V-8	.029-.032
52-56 Pass	6 cyl	.032-.036
54-56 Pass	V-8	.032-.036
32-47 PU	V-8	.025
41-46 PU	6 cyl	.025
47-51 PU	6 cyl	.029-.032
48-53 PU	V-8	.029-.032
52-56 PU	6 cyl	.032-.036
54-56 PU	V-8	.032-.03

Spark Plug



28-34	Pass	18-12405, 4 cyl.....ea.	5.00
32	Pass	18-12405, V-8.....ea.	5.00
33-37	Pass	40-12405, V-8.....ea.	3.00
38-54	Pass	7RA-12405, 6 cyl & V-8.....ea.	2.75
55-64	Pass	B5C-12405-A, 6 cyl. & V-8.....ea.	3.00
39-54	Merc	7RA-12405.....ea.	2.75
55-56	Merc	B5C-12405-A.....ea.	3.00
28-34	PU	18-12405, 4 cyl.....ea.	5.00
32	PU	18-12405, V-8.....ea.	5.00
33-37	PU	40-12405.....ea.	3.00
38-54	PU	7RA-12405, 6 cyl & V-8.....ea.	2.75
55-64	PU	B5C-12405-A, 6 cyl. & V-8.....ea.	3.00

COILS

Rebuilt Coil

We can have your original Ford script coil rebuilt. Allow 3 to 6 weeks. Foreign made and reproduction coils can not be rebuilt. Coil brush and spring are not included with rebuilt coils. Must send YOUR core to be rebuilt. One year warranty from date of purchase.



32-36	Pass	18-12024, V-8.....ea.	120.00
36	Pass	68-12024, late, flat top, mounts with two screws.....ea.	120.00
37-41	Pass	78-12024-R, V-8.....ea.	120.00
32-36	PU	18-12024, V-8.....ea.	120.00
37-41	PU	78-12024-R, V-8.....ea.	120.00

New Coil

Coil #B-12000 does not require a resistor. If using on a 1933-48 car or 1933-47 pu, disconnect the ignition resistor.



28-34	Pass	B-12000, 4 cyl.....ea.	28.00
-------	------	------------------------	-------



37-41	Pass	78-12024-A, black w/Ford script.....ea.	82.50
37-41	Pass	78-12024-12V, black w/Ford script, 12 volt.....ea.	100.00
42-48	Pass	1GA-12024-AR, Ford script, 6V.....ea.	70.00
42-48	Pass	1GA-12024-12V, Ford script, 12 volt.....ea.	70.00
49-55	Pass	B-12000.....ea.	28.00
49-55	Pass	8BA-12029, w/mustard top.....ea.	24.00
56-70	Pass	B6A-12029, 12V.....ea.	20.00
56-70	Pass	B6A-12029-B, 12V, w/correct yellow top.....ea.	40.00
39-41	Merc	78-12024-A, black w/Ford script.....ea.	82.50
39-41	Merc	78-12024-12V, black w/Ford script, 12 volt.....ea.	100.00
42-48	Merc	1GA-12024-AR, Ford script, 6V.....ea.	70.00
42-48	Merc	1GA-12024-12V, Ford script, 12 volt.....ea.	70.00
49-55	Merc	B-12000.....ea.	28.00
49-55	Merc	8BA-12029, w/mustard top.....ea.	24.00
56-70	Merc	B6A-12029-B, 12V, w/correct yellow top.....ea.	40.00
56-70	Merc	B6A-12029, 12V.....ea.	20.00

28-34	PU	B-12000, 4 cyl	ea.	28.00
37-41	PU	78-12024-A, black, w/Ford script.....	ea.	82.50
37-41	PU	78-12024-12V, black w/Ford script, 12 volt.....	ea.	100.00
42-47	PU	1GA-12024-AR, Ford script, 6V.....	ea.	70.00
42-47	PU	1GA-12024-12V, Ford script, 12 volt	ea.	70.00
48-55	PU	B-12000	ea.	28.00
48-55	PU	8BA-12029, w/mustard top	ea.	24.00
56-70	PU	B6A-12029-B, 12V, w/correct yellow top.....	ea.	40.00
56-70	PU	B6A-12029, 12V	ea.	20.00

Brass Coil Nut

Correct slotted nut.

37-48	Pass	350830-S.....	ea.	1.00
37-47	PU	350830-S.....	ea.	1.00

Coil Brush & Spring

32-36	Pass	18-12010-S	ea.	3.00
37-41	Pass	68-12010-S	set.	3.75
39-41	Merc	68-12010-S	set.	3.75
32-36	PU	18-12010-S	ea.	3.00
37-41	PU	68-12010-S	set.	3.75

Coil Adapter

For use with modern coil. Includes condenser.



32-36	Pass	18-12036-S, V-8.....	ea.	37.50
37-41	Pass	78-12036-S, V-8.....	ea.	38.00
39-41	Merc	78-12036-S	ea.	38.00
32-36	PU	18-12036-S, V-8.....	ea.	37.50
37-41	PU	78-12036-S, V-8.....	ea.	38.00

Coil to Distributor Gasket

37-41	Pass	78-12140	ea.	1.00
37-41	PU	78-12140	ea.	1.00

Coil Mounting Bracket



All	Pass & PU	B-12000-CB, universal, for round coil.....	ea.	5.50
-----	-----------	---	-----	------

RESISTORS

Fuse Block & Resistor



32	Pass & PU	B-14525	ea.	8.50
----	-----------	---------------	-----	------



33-38	Pass	40-12250, original style, requires 20 amp fuse	ea.	20.00
39	Std Pass	40-12250, original style, requires 20 amp fuse	ea.	20.00
33-39	PU	40-12250, original style, requires 20 amp fuse	ea.	20.00

Headlight Circuit Breaker & Ignition Resistor

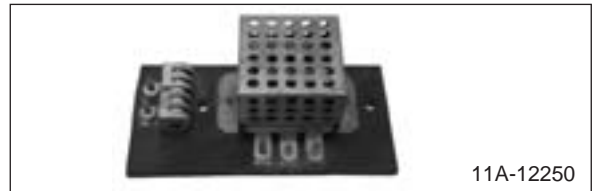

40	Pass	01A-12250, replacement type	ea.	25.00
41-47	Pass	11A-12250, early 47	ea.	25.00
40	Merc	01A-12250, replacement type	ea.	25.00
41-47	Merc	11A-12250, early 47	ea.	25.00
40	PU	01A-12250, replacement type	ea.	25.00
41-47	PU	11A-12250	ea.	25.00

Ignition Resistor

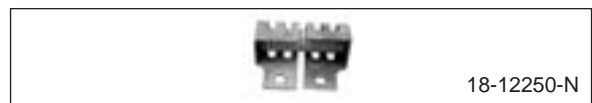

32-48	Pass	18-12250	ea.	7.00
32-48	Pass	18-12250-N, N.O.S., ceramic.....	ea.	25.00
56-57	Pass	B7A-12250, 12V	ea.	12.50
32-48	Merc	18-12250	ea.	7.00
32-48	Merc	18-12250-N, N.O.S., ceramic.....	ea.	25.00
32-47	PU	18-12250	ea.	7.00
32-47	PU	18-12250-N, N.O.S., ceramic.....	ea.	25.00
56-57	PU	B7A-12250, 12V	ea.	12.50



Section 21 Switches

HEADLIGHT

Headlight Switch

See section 40 for knobs and bezels



28-39	Pass	B-11655-S, mounts on bottom of steering box.....ea.	20.00
40	Pass	01A-11652, w/wires & mtg nut.....ea.	37.00

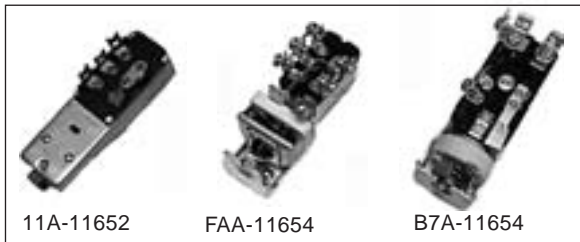

41-49	Pass	11A-11652.....ea.	40.00
50-54	Pass	FAA-11654.....ea.	48.50
55	Pass	B5T-11654.....ea.	125.00
56-57	Pass	B7A-11654.....ea.	51.00
41-49	Merc	11A-11652.....ea.	40.00
50-54	Merc	FAA-11654.....ea.	48.50
55-56	Merc	B5T-11654.....ea.	125.00
55	T-Bird	B5T-11654.....ea.	125.00
28-39	PU	B-11655-S, mounts on bottom of steering box.....ea.	20.00
40	PU	01A-11652, w/wires & mtg nut.....ea.	37.00
41-50	PU	11A-11652.....ea.	40.00
51-54	PU	FAA-11654.....ea.	48.50
55	PU	B5T-11654.....ea.	125.00
56-57	PU	B7A-11654.....ea.	51.00

HEADLIGHT DIMMER

Headlight Dimmer Switch

Floor mounted



38-48	Pass	11A-13532.....ea.	13.50
49-56	Pass	8A-13532.....ea.	21.00
39-48	Merc	11A-13532.....ea.	13.50

49-56	Merc	8A-13532.....ea.	21.00
38-47	PU	11A-13532.....ea.	13.50
48-56	PU	8A-13532.....ea.	21.00

CIRCUIT BREAKER

Power Window Circuit Breaker

52-53	Pass	FAA-12258-B, N.O.S.....ea.	40.00
54	Pass	FAA-12258-B, N.O.S.....ea.	40.00

HOOD & TRUNK

Accessory Hood & Trunk Light Switch

This replaces original mercury switch. For use with your original light housing.

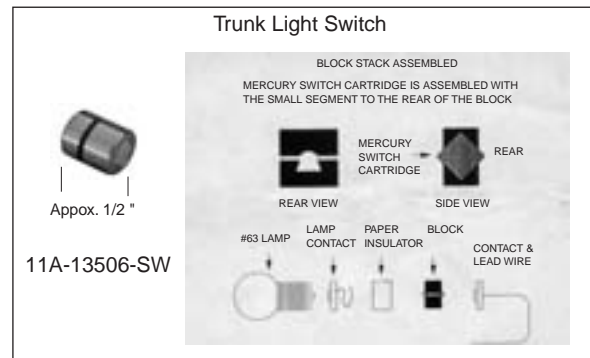

41-48	Pass	11A-13506-SW.....ea.	40.00
-------	------	----------------------	-------

IGNITION

Ignition On/Off Switch Plate



32	Pass	B-11556.....ea.	8.00
33-34	Pass	40-11556.....ea.	8.00
35-36	Pass	48-11556.....ea.	8.00
37	Pass	78-11556.....ea.	8.00
38-39	Pass	81A-11556.....ea.	8.00
40-47	Pass	78-11556.....ea.	8.00
41-47	Merc	78-11556.....ea.	8.00
32	PU	B-11556.....ea.	8.00
33-34	PU	40-11556.....ea.	8.00
35-37	PU	48-11556.....ea.	8.00
38-47	PU	81A-11556.....ea.	8.00

Ignition Switch On/Off Knob

39	Merc	99A-3690, pinkish.....ea.	10.00
----	------	---------------------------	-------

Ignition Switch Lever

33-34	Pass	40-3735, chrome.....ea.	19.95
33-34	PU	40-3735, chrome.....ea.	19.95

Ignition Switch Cylinder & Keys

Includes 68-3729 pin.



35-47	Pass	48-3686, early 47kit.	18.00
39-47	Merc	48-3686, early 47kit.	18.00
35-47	PU	48-3686kit.	18.00

Ignition Switch with Cable

28-31	Pass & PU	A-11575-Fea.	15.00
-------	-----------	-----------	----------	-------

Ignition Switch Spacer

53-60	PU	B7C-11597-Aea.	10.00
-------	----	-------------	----------	-------

Ignition Switch Bezel



47-50	Pass	0A-11580-N, late 47ea.	15.00
51-55	Pass	B9S-11580-Aea.	17.50
49	Merc	0A-11580-Nea.	15.00
50-51	Merc	0L-11580ea.	15.00
48-50	PU	0A-11580-Nea.	15.00
51-52	PU	0L-11580ea.	15.00
53-56	PU	BAAA-10852-IGea.	8.00

Ignition Lock Cylinder Retaining Pin

32-34	Pass	B-3729, NOSea.	3.00
32-34	PU	B-3729, NOSea.	3.00

Ignition Switch Plate Case

38-40	Pass	81A-3712, good usedea.	10.00
38-47	PU	81A-3712, good usedea.	10.00

Ignition Switch Body & Brush



38-40	Pass	81A-3704/9-Kset.	20.00
38-47	PU	81A-3704/9-Kset.	20.00

Ignition Switch Body



32-37	Pass	B-3704ea.	10.52
38-40	Pass	81A-3704ea.	16.92
41-48	Pass	09A-3704ea.	15.96
41-48	Merc	09A-3704ea.	15.96
32-37	PU	B-3704ea.	10.52

38-47	PU	81A-3704ea.	16.92
-------	----	----------	----------	-------

Ignition Switch

Switch only. Ignition cylinder sold separately.



47-50	Pass	6A-11572-B, good usedea.	100.00
52-56	Pass	B5A-11572ea.	24.50
52-56	Merc	B5A-11572ea.	24.50
48-50	PU	6A-11572-B, good usedea.	100.00
53-55	PU	B5A-11572, must use B9A-11582 and B7C-11597-Aea.	24.50
56-60	PU	B5A-11572ea.	24.50

Replacement Type Ignition Switch

Good for the daily driver. CANNOT use original ignition cylinder or bezel.

47-48	Pass	LH-9578, replacementea.	20.50
50-51	Merc	0L-11572, replacementea.	30.00
48-50	PU	LH-9578, replacementea.	20.50
51-52	PU	0L-11572, replacementea.	30.00

Ignition Switch Cylinder & Keys



47-51	Pass	1A-11582-A, good usedea.	75.00
52-59	Pass	B9A-11582ea.	10.00
47-51	Merc	1A-11582-A, good usedea.	75.00
52-59	Merc	B9A-11582ea.	10.00
48-52	PU	1A-11582-A, good usedea.	75.00
53-55	PU	B9A-11582, if using B5A-11572 switchea.	10.00
56-60	PU	B9A-11582ea.	10.00

TURN SIGNAL

Turn Signal Switch



56-58	Pass	B6A-13341-Aea.	60.00
56-60	PU	B6A-13341-Aea.	60.00

Universal Turn Signal Switch

All	Pass & PU	B-13341, blackea.	56.00
-----	-----------	----------------	----------	-------

Section 21 - Switches



C&G Early Ford Parts, Inc.

All	Pass & PU	B-13341-C, chrome	ea.	90.00
All	Pass & PU	B-13341-U, 12 volt, chrome with green on on handle	ea.	17.00

Universal Turn Signal Switch Kit

This kit includes switch, flasher socket, flasher, parking light splice wire, wire connectors, bullet ends, and easy to read diagram. This kit does not include Parking Light socket wires.



B-13341-KIT

All	Pass & PU	B-13341-K6, 6V, black	kit.	125.00
All	Pass & PU	B-13341-K12, 12V, black	kit.	125.00
All	Pass & PU	B-13341-CK6, 6V, chrome	kit.	155.00
All	Pass & PU	B-13341-CK12, 12V, chrome	kit.	155.00

Universal Turn Signal Flasher Socket

All	Pass & PU	LH-3032, for 3-prong flasher	ea.	5.00
-----	-----------	---------------------------------------	-----	------

Turn Signal Flasher



B6A-13350-B

All	Pass & PU	8L-13350-B, 6V, 3-prong #535	ea.	11.00
All	Pass & PU	B6A-13350-B, 12V, 3-prong	ea.	6.50

Turn Signal Flasher for LED

Must use when installing LED lights or bulbs.

All		90650-LED, 12 volt, 2 prong	ea.	10.00
All		90651-LED, 12 volt, 3 prong	ea.	10.00

Turn Signal Cancelling Cam

Mounts to underside of steering wheel.



FAB-13318

8A-13318

49-50	Pass	8A-13318	ea.	17.50
51-58	Pass	FAB-13318	ea.	15.00
53-56	PU	FAA-13318-A	ea.	10.00

Turn Signal Cancelling Cam Spring

55-58	Pass	1M-13316-A	ea.	1.75
51-53	Merc	1M-13316-A	ea.	1.75

Turn Signal Lever

55	T-Bird	B5S-13305-A	ea.	16.00
----	--------	-------------------	-----	-------

DASH LIGHT

Dash Light Switch

Can not use with original knob.



40-13740

33-38	Pass	40-13740	ea.	11.00
39	Std Pass	40-13740	ea.	11.00
33-51	PU	40-13740	ea.	11.00

Dash Light Dimmer Switch w/Colored Knob



21A-13740-B

40	Std Pass	01A-13740-A, sand	ea.	25.00
40	Dlx Pass	01A-13740-B, maroon	ea.	25.00
42	Dlx Pass	21A-13740-A, maroon	ea.	25.00
42	Super Dlx	21A-13740-B, butterscotch	ea.	25.00
46	Dlx Pass	51A-13740-A, chocolate	ea.	25.00
46	Super Dlx	51A-13740-B, blue gray	ea.	25.00
46	Super Dlx	51A-13740-C, gray tan	ea.	25.00
47-48	Dlx Pass	51A-13740-C, gray tan	ea.	25.00
47-48	Super Dlx	51A-13740-C, gray tan	ea.	25.00
42-48	Merc	29A-13740, black	ea.	30.00
40	PU	01A-13740-A, sand	ea.	25.00
41-47	PU	29A-13740, black	ea.	30.00

DOME LIGHT

Dome Light Switch on Post



A-13752

28-48	Pass	A-13752	ea.	9.50
39-48	Merc	A-13752	ea.	9.50

Dome Light Switch Plate



68-13770

28-48	Pass	68-13770	ea.	4.00
39-48	Merc	68-13770	ea.	4.00

Dome Light Switch For Light Above Rear Window



53-56 PU BAAA-13769.....ea. 13.50

Door Jamb Dome Light Switch



50-56 Pass 8M-13713ea. 8.00
 52-56 Merc 8M-13713ea. 8.00
 51-56 PU 8M-13713ea. 8.00

WIPER

Wiper Motor Switch

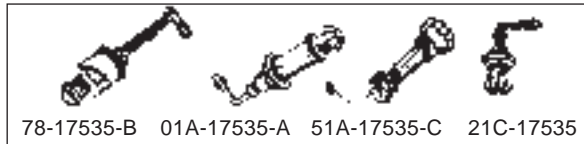

37 Conv/Wgn 78-17535-B, lt. brown.....ea. 40.00
 38 Conv/Wgn 81A-17535, ivory.....ea. 40.00
 39 Conv/Wgn 91A-17535, lt. yellowea. 40.00
 40 Std Pass 01A-17535-A, sandea. 35.00
 40 Dlx Pass 01A-17535-B, maroon.....ea. 35.00
 46 Super Dlx 51A-17535-B, blue grayea. 20.00
 46 Super Dlx 51A-17535-C, gray tanea. 20.00
 47-48 Dlx Pass 51A-17535-C, gray tanea. 20.00
 47-48 Super Dlx 51A-17535-C, gray tanea. 20.00
 40-41 PU 01C-17535, tanea. 35.00
 42-47 PU 21C-17535, black.....ea. 35.00

Electric Wiper Motor Switch

51-52 PU 8C-17470ea. 20.00
 53-56 PU B6C-17470-Aea. 45.00

Wiper Switch Shaft Extension

For use w/replacement electric wiper motors.



49-50 Pass B5A-17470-EXTea. 22.00
 52-56 Pass B5A-17470-EXTea. 22.00
 55-60 T-Bird B5A-17470-EXTea. 22.00

HEATER

Heater Motor Switch

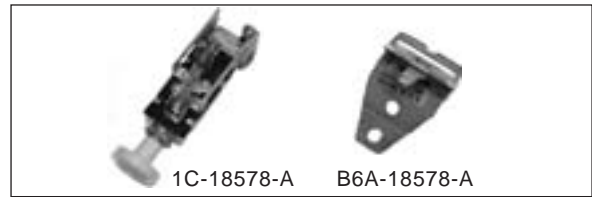

51 Pass 1A-18578-A.....ea. 27.00
 52-53 Pass FAA-18578-Aea. 21.00
 54 Pass FDA-18578-A.....ea. 17.50
 56 Pass B6A-18578-Aea. 18.00
 51-55 PU 1C-18578-Aea. 70.00
 56 PU 1A-18578-A.....ea. 27.00

POWER WINDOW

Power Window Switch

55-56 Pass B6A-14529-Aea. 44.95

POWER SEAT

Power Seat Switch

54-55 Pass B5AZ-14A701-Bea. 44.95

HORN RELAY

Horn Relay



39-55 Pass 7RA-13853, 6V, correct for 47-55.....ea. 20.50
 56 Pass B6A-13853, 12Vea. 22.50
 39-55 Merc 7RA-13853, 6V, correct for 47-55.....ea. 20.50
 56 Merc B6A-13853, 12Vea. 22.50
 48-55 PU 7RA-13853, 6Vea. 20.50
 56 PU B6A-13853, 12Vea. 22.50

BRAKE LIGHT

Brake Light Switch



35-38 Pass 48-13480.....ea. 14.00



39-56	Pass	01A-13480.....ea.	8.50
39-56	Merc	01A-13480.....ea.	8.50
35-38	PU	48-13480.....ea.	14.00
39-56	PU	01A-13480.....ea.	8.50

BACK-UP LIGHT

Back-Up Light Switch

For standard shift transmissions only.



46-56	Pass	51A-15520-A.....ea.	12.00
51	Merc	1H-15520-A.....ea.	9.00

Back Up Light Switch Bracket

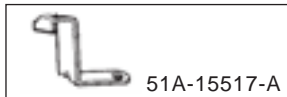

46-54	Pass	51A-15517-A.....ea.	10.00
55-56	Pass	B5A-15517-A.....ea.	17.50

UNIVERSAL

Toggle Switch

Needs bracket or must make hole in dash.



All	Pass & PU	5582.....ea.	6.00
-----	-----------	--------------	------



1940 Coupe, Clyde Bangiola

**Section 22
Lights**

HEADLIGHTS

Headlights with Ford Script

These are very nice reproduction of the original. Lights are polished stainless with Ford script. All lights include Ford script on lens like original.



32	Pass	B-1300016V, 1 bulb, 6V.....pr.	305.00
32	Pass	B-13000116V, 2 bulb, 6V.....pr.	305.00
32	Pass	B-13000-Q, 12V halogen.....pr.	325.00
32	Pass	B-13000-QSTS, 12V halogen, w/turn signals.....pr.	335.00
33-34	Pass	40-13000-I6V, 1-bulb, 6V.....pr.	305.00
33-34	Pass	40-13000-II6V, 2-bulb, 6V.....pr.	305.00
33-34	Pass	40-13000-Q, 12V halogen.....pr.	325.00
33-34	Pass	40-13000-QSTS, 12V halogen, w/turn signals.....pr.	335.00
32	PU	BB-13000-QS, 12V halogen, black.....pr.	305.00
32	PU	BB-13000-QSTS, 12V halogen, black, w/turn signals.....pr.	325.00
33-34	PU	46-13000-1S, 1 bulb, 6V, black.....pr.	285.00
33-34	PU	46-13000-2S, 2 bulb, 6V, black.....pr.	285.00
33-34	PU	46-13000-QS, 12V halogen, black.....pr.	285.00
33-34	PU	46-13000-QSTS, 12 volt halogen, black housing with turn signal.....pr.	310.00

Halogen Headlights without Ford Script

These are very nice reproduction that look like original lights without Ford script on the bucket or the lens. Lights are polished stainless.

32	Pass	B-13000-QPTS, 12 volt with turn signals.....pr.	340.00
----	------	--	--------

Dietz Headlights

These are NOT reproduction original Ford lights. These are replacement style or hot rod style headlights. All lights come with 12V halogen bulb.



28-36	Pass	D-13000-SBC, chrome	pr.	69.00
28-36	Pass	D-13000-SBP, plain.....	pr.	69.00
28-39	PU	D-13000-SBC, chrome	pr.	69.00
28-39	PU	D-13000-SBP, plain.....	pr.	69.00

King Bee Headlights

These are NOT reproduction original Ford lights. These are replacement style or hot rod style headlights. All lights come with 12V halogen bulb.



28-36	Pass	KB-13000-QPTS, primed housing, with turn signals.....	pr.	160.00
28-36	Pass	KB-13000-QC, chrome.....	pr.	90.00
28-36	Pass	KB-13000-QCTS, chrome, with turn signals.....	pr.	160.00
28-36	Pass	KB-13000-QSS, stainless	pr.	160.00
28-36	Pass	KB-13000-QSSTS, stainless, with turn signal	pr.	185.00
28-39	PU	KB-13000-QPTS, primed housing, with turn signals.....	pr.	160.00
28-39	PU	KB-13000-QC, chrome.....	pr.	90.00
28-39	PU	KB-13000-QCTS, chrome, with turn signals.....	pr.	160.00
28-39	PU	KB-13000-QSS, stainless	pr.	160.00
28-39	PU	KB-13000-QSSTS, stainless, with turn signal	pr.	185.00

BAR

Stainless Dropped Headlight Bar

32	Pass	B-13114	ea.	195.00
----	------	---------------	-----	--------

Headlight Bar Bolts



32	Pass	3106, black.....	ea.	3.00
32	Pass	3106-SS, stainless.....	ea.	5.50
32-34	PU	3106, black.....	ea.	3.00
32-34	PU	3106-SS, stainless.....	ea.	5.50

Headlight Bar to Fender Pad

32	Pass	B-13130.....	pr.	7.00
32-34	PU	B-13130.....	pr.	7.00

Headlight Bar Emblem



32	Pass & PU	18-13122, V-8	ea.	25.00
----	-----------	---------------------	-----	-------

STANDS

Headlight Stands

Chopped style; Cannot use horns, headlights sit too low and hit horn brackets.



33-34	Pass	CHP-13125B, black	pr.	50.00
33-34	Pass	40-13125/6-SS, stainless.....	pr.	60.00
33-34	Pass	CHP-13125-C, chrome	pr.	55.00

Headlight Mounts

Fits between headlight bucket and fender.

36	Pass	68-13125-A	pr.	30.00
36	Pass	68-13125-A	pr.	30.00

Headlight Stand Bolts



33-34	Pass	40-13119-BK, black, w/hole.....	ea.	5.00
33-34	Pass	40-13119-NHBK, black, no hole	ea.	5.00
33-34	Pass	40-13119-NHSS, , stainless, no hole	ea.	8.50



33-34	Pass	40-13119-SS, , stainless, w/hole.....	ea.	9.00
35-37	PU	40-13119-BK, black, w/hole.....	ea.	5.00
35-37	PU	40-13119-NHBK, black, no hole	ea.	5.00
35-37	PU	40-13119-NHSS, , stainless, no hole	ea.	8.50



35-37 PU 40-13119-SS, stainless, w/hole.....ea. 9.00

Headlight Stand to Fender Pad

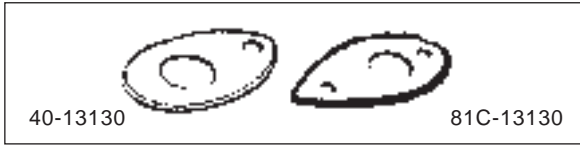

33-34 Pass 40-13130pr. 7.00
 35 Pass 48-13130pr. 7.00
 36 Pass 68-13130pr. 10.00
 35-37 PU 40-13130pr. 7.00
 38-39 PU 81C-13130.....pr. 8.00

CONDUIT

Headlight Conduit

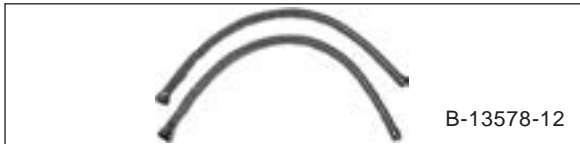

32 Pass B-13578-12, stainless, 12".....set. 11.00
 32-34 PU B-13578-12, stainless, 12".....set. 11.00

Headlight Conduit Grille Shell Grommets



32 Pass B-14567-C.....pr. 3.00
 32-34 PU B-14567-C.....pr. 3.00

Headlight Conduit Wire Connector



28-32 Pass & PU B-14584Aea. 2.38

HARDWARE

Headlight Mounting Nut and Lock Washer

28-32 Pass 1124set. 1.25

Headlight Shell Mounting Screws

32-34 Pass & PU 1130, 12 pcs.....set. 4.00

HEADLIGHT BUCKETS

Headlight Bucket Assembly

These assemblies do NOT include reflector, bulbs, sockets or wiring.



37-38 Pass 78-13026.....ea. 112.50
 39 Std Pass 78-13026.....ea. 112.50
 39 DlX Pass 91A-13026.....ea. 112.50
 40 Pass 01A-13026.....ea. 112.50
 49-50 Pass 1C-13008-A.....ea. 75.00
 51 Pass 1A-13008-A.....ea. 75.00
 54 Pass FAD-13008-A.....ea. 75.00
 39 Merc 91A-13026.....ea. 112.50
 40 Merc 01A-13026.....ea. 112.50
 49-50 Merc 1C-13008-A.....ea. 75.00
 51 Merc 1A-13008-A.....ea. 75.00
 40-41 PU 01A-13026.....ea. 112.50
 48-55 PU 1C-13008-A.....ea. 75.00

Headlight Bucket W/Halogen Sealed Beam

Complete headlight buckets with 12 volt halogen sealed beam bulbs, wiring pigtail, mounting hardware, and turn signals sockets and bulbs. Headlight lens and trim ring are not included. Clear headlight lens are recommended.

37-38 Pass 78-13026-QPRpr. 305.00
 39 Std Pass 78-13026-QPRpr. 305.00
 39 DlX Pass 91A-13026-QPRpr. 305.00

Halogen Sealed Beam Conversion Kit

One kit does both headlight buckets.

37-38 Pass 78-13030-QK12kit. 160.00
 39 Std Pass 78-13030-QK12kit. 160.00

HEADLIGHT BUCKET HARDWARE / GASKETS

Headlight Bucket and Lens Mounting Hardware Kit

Kit does one headlight.

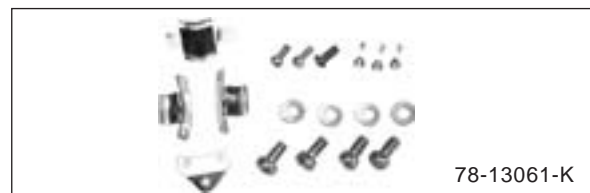

37-38 Pass 78-13061-K.....kit. 25.00
 39 Std Pass 78-13061-K.....kit. 25.00

39	Dlx Pass	91A-13061-Kkit.	25.00
39	Merc	91A-13061-Kkit.	25.00

Headlight Bucket Screws

One set required per headlight bucket.

37-40	Pass	01A-13026-HKset.	5.00
49-50	Pass	8A-13050-Sset.	4.50
51	Pass	1A-13050-Sset.	4.50
52	Pass	BA-13050-Sset.	4.50
53	Pass	BF-13050-Sset.	4.50
54	Pass	B4A-13050-Sset.	4.50
55	Pass	B5A-13050-Sset.	4.50
56	Pass	B6A-13050-Sset.	4.50
40-41	PU	01A-13026-HKset.	5.00

Headlight Conduit Repair Kit

Kit does one headlight.



37-48	Pass	78-14597-RKkit.	20.00
39-48	Merc	78-14597-RKkit.	20.00
40-47	PU	78-14597-RKkit.	20.00

Headlight Bucket Wire Grommet

46-56	Pass & PU	51A-13077ea.	2.00
-------	-----------	-----------	----------	------

Air Deflector Headlight Wire Grommet

48-52	PU	8C-13078-Cea.	4.00
-------	----	------------	----------	------

Headlight Bucket to Fender Gaskets

37-38	Pass	78-13044ea.	8.00
39	Std Pass	78-13044ea.	8.00
39	Dlx Pass	91A-13044ea.	3.75
40	Pass	01A-13044ea.	3.95
41-56	Pass	11A-13044ea.	4.00
39	Merc	91A-13044ea.	3.75
40	Merc	01A-13044ea.	3.95
41-56	Merc	11A-13044ea.	4.00
40-41	PU	01A-13044ea.	3.95
42-56	PU	11A-13044ea.	4.00

HEADLIGHT LENS

Glass Headlight Lens w/Ford Script

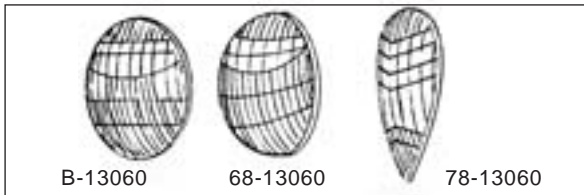

32	Pass	B-13060ea.	22.00
33-34	Pass	40-13060ea.	22.00
35	Pass	48-13060ea.	22.00
36	Pass	68-13060ea.	22.00
37	Pass	78-13060ea.	22.00

38	Pass	81A-13060ea.	35.00
37-38	Pass	78-13060-CL, clear, for halogen headlightsea.	32.00
39	Std Pass	81A-13060ea.	35.00
39	Std Pass	78-13060-CL, clear, for halogen headlightsea.	32.00
39	Dlx Pass	91A-13060ea.	35.00
39	Dlx Pass	91A-13060-CL, clear for halogen headlightsea.	32.00
39	Merc	91A-13060ea.	35.00
32	PU	B-13060ea.	22.00
33-34	PU	40-13060ea.	22.00
35-39	PU	48-13060ea.	22.00

Headlight Lens Gaskets-Cork



32-36	Pass	B-13066pr.	5.00
37-39	Pass	78-13066pr.	6.00
39	Merc	78-13066pr.	6.00
32-39	PU	B-13066pr.	5.00

Headlight Lens Gaskets - Rubber

37-39	Pass	78-13066-ARpr.	10.00
39	Merc	78-13066-ARpr.	10.00

Headlight Lens Gasket Retaining Bail

37-39	Pass	78-13067pr.	15.00
39	Merc	78-13067pr.	15.00

Headlight Lens Retainer Clips

One set required per vehicle.

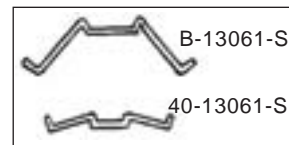

28-32	Pass	B-13061-Sset.	4.00
33-34	Pass	40-13061-Sset.	4.00
35-36	Pass	48-13061set.	4.00
28-32	PU	B-13061-Sset.	4.00
33-34	PU	40-13061-Sset.	4.00
35-39	PU	48-13061set.	4.00

HEADLIGHT REFLECTOR

Headlight Reflectors



32	Pass	B-13027-A, 1 bulbea.	45.00
----	------	-------------------	----------	-------



32	Pass	B-13028-A, 2 bulb.....ea.	45.00
33-34	Pass	40-13027-A, 1 bulb.....ea.	45.00
33-34	Pass	40-13028, 2 bulb.....ea.	45.00
35-36	Pass	48-13028.....ea.	32.00
37-39	Pass	78-13028.....ea.	32.00
39	Merc	78-13028.....ea.	32.00
32	PU	B-13027-A, 1 bulb.....ea.	45.00
32	PU	B-13028-A, 2 bulb.....ea.	45.00
33-34	PU	40-13027-A, 1 bulb.....ea.	45.00
33-34	PU	40-13028, 2 bulb.....ea.	45.00
35-39	PU	48-13028.....ea.	32.00

Headlight Reflector Retainer

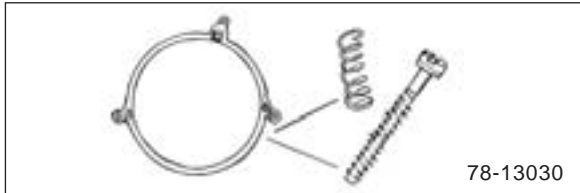

37-38	Pass	78-13030, 2 required.....kit.	40.00
39	Std Pass	78-13030, 2 required.....kit.	40.00
39	Dlx Pass	91A-13030, 2 required.....kit.	40.00
39	Merc	91A-13030, 2 required.....kit.	40.00

Headlight Reflector Clips



35-36	Pass	48-13017.....set.	10.00
35-39	PU	48-13017.....set.	10.00

HALOGEN KITS

Halogen Conversion Kit

For converting existing reflectors to halogen. Kit includes bulbs, sockets, and wiring for two headlights. For 6V applications, generator must produce 35 Amps.



32-39	Pass & PU	B-13026-QH, 12V.....kit.	35.00
32-39	Pass & PU	B-13026-QH6, 6V.....kit.	45.00

Halogen Reflector Kits

Kit includes reflectors, bulbs, wiring, & gaskets for two headlights. For 6V kit, except #48-13027-QK-6, you must order 6V bulbs, #B-13007-Q6, separately. Reflector retainer sold separately.



32	Pass	B-13027-QK12.....kit.	135.00
----	------	-----------------------	--------

33-34	Pass	40-13027-QK12.....kit.	135.00
35-36	Pass	48-13027-QK12.....kit.	135.00
37-39	Pass	78-13027-QK12.....kit.	135.00
39	Merc	78-13027-QK12.....kit.	135.00
32	PU	B-13027-QK12.....kit.	135.00
33-34	PU	40-13027-QK12.....kit.	135.00
35-39	PU	48-13027-QK12.....kit.	135.00

Halogen Reflector Kits w/Turn Signals

Kit includes reflectors, 12V bulbs, wiring, & gaskets for two headlights. For 6V kit, you must order 6V bulbs, #B-13007-Q6, separately.

32	Pass	B-13027-QK12TS.....kit.	145.00
33-34	Pass	40-13027-QK12TS.....kit.	145.00
35-36	Pass	48-13027-QK12TS.....kit.	145.00
37-39	Pass	78-13027-QK12TS.....kit.	145.00
39	Merc	78-13027-QK12TS.....kit.	145.00
32	PU	B-13027-QK12TS.....kit.	145.00
33-34	PU	40-13027-QK12TS.....kit.	145.00
35-39	PU	48-13027-QK12TS.....kit.	145.00

HEADLIGHT RIM / DOOR

Headlight Shell Inner Rim

32	Pass	B-13001-IR.....ea.	12.50
33-34	Pass	40-13001-IR.....ea.	12.50
32	PU	B-13001-IR.....ea.	12.50

Headlight Inner Ring Clip



32	Pass & PU	B-13001-C.....ea.	4.00
33-34	Pass & PU	40-13001-C.....ea.	4.00

Headlight Shell Outer Rim – Stainless

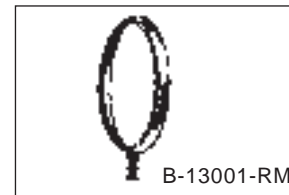

32	Pass & PU	B-13001-RM.....ea.	32.00
33-34	Pass & PU	40-13001-RM.....ea.	32.00
35	Pass	48-13045.....pr.	80.00
36	Pass	68-13045.....pr.	102.00
35-39	PU	48-13045.....pr.	80.00

Headlight Outer Rim Repair Kit

One kit required per headlight rim.



32	Pass	A-13044-BSS.....kit.	5.00
----	------	----------------------	------

35-36	Pass	A-13044-BSS.....kit.	5.00
30-39	PU	A-13044-BSS.....kit.	5.00

Headlight Rim / Door



37-38	Dlx Pass	78-13045, polished stainless.....ea.	32.00
37-39	Std Pass	78-13045, polished stainless.....ea.	32.00
39	Dlx Pass	91A-13045, polished stainless.....ea.	32.00
40	Std Pass	01A-13045-A, pot metal.....pr.	150.00
40	Dlx Pass	01A-13045-SET, chrome, include park light lens and gasket.....set.	170.00

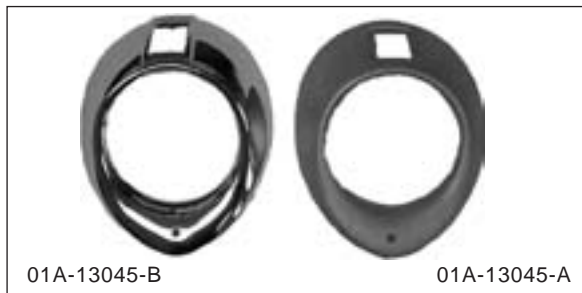

40	Dlx Pass	01A-13045-B, chromepr.	155.00
40	Pass	01A-13045-AN, smooth, pot metal, no hole for parklightpr.	125.00
41	Pass	11A-13045-BD, polished stainless, 2-rib style.....pr.	65.00
42	Pass	21A-13045, polished stainless, 3-rib style.....pr.	65.00
46	Pass	51A-13045, polished stainless, 1-rib style.....pr.	65.00
47-48	Pass	6A-13045-BD, polished stainless, smoothpr.	65.00
49-50	Pass	B5CZ-13064-AREP, stainless.....ea.	25.00
51	Pass	1A-13045-C, chrome.....ea.	50.00
39	Merc	91A-13045, polished stainless.....ea.	32.00
40	Merc	01A-13045-SET, chrome, include park light lens and gasket.....set.	170.00
40	Merc	01A-13045-B, chromepr.	155.00



49-50	Merc	B5CZ-13064-AREP, stainless.....ea.	25.00
51	Merc	1A-13045-C, chrome.....ea.	50.00
40-41	PU	01A-13045-A, pot metal.....pr.	150.00
40-41	PU	01A-13045-SET, chrome, include park light lens and gasket.....set.	170.00
40-41	PU	01A-13045-B, chromepr.	155.00
40-41	PU	01A-13045-AN, smooth, pot metal, no hole for parklightpr.	125.00
48-55	PU	B5CZ-13064-AREP, stainless.....ea.	25.00

Replacement Style Headlight Rim / Door

Chrome plated import type.

41-47	Pass	11A-13045, w/ridges.....ea.	19.00
47-48	Pass	6A-13045, smooth.....ea.	20.00
42-47	PU	11A-13045, w/ridges.....ea.	19.00

King Bee Headlight Rim

Fits King Bee headlights only.

KB-13001-RM, chrome.....ea.	22.00
KB-13001-RMSS, stainless.....ea.	35.00

Stainless Outer Headlight Trim Ring

56	PU	B6CZ-13064-A.....ea.	30.00
----	----	----------------------	-------

Headlight Trim



55	Pass	B5A-13063-K.....pr.	225.00
----	------	---------------------	--------

Headlight Door Top Molding

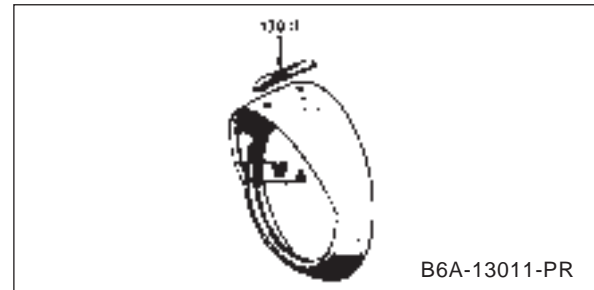

56	Frln	B6A-13011-PR.....pr.	32.50
----	------	----------------------	-------

HEADLIGHT RIM / DOOR HARDWARE

Headlight Door Screws

37-40	Pass	01A-13026-S.....pr.	3.00
39-40	Merc	01A-13026-S.....pr.	3.00
40-41	PU	01A-13026-S.....pr.	3.00

Headlight Door Screw Repair Kit



40	Pass	01A-13026-R.....kit.	8.00
40	Merc	01A-13026-R.....kit.	8.00
40-41	PU	01A-13026-R.....kit.	8.00

Headlight Trim Ring Screws

49-50	Pass	8A-13048-S.....set.	1.25
51	Pass	1A-13048-S.....set.	1.25



52	Pass	BA-13048-S.....set.	1.25
53	Pass	BF-13048-S.....set.	1.25
54	Pass	B4A-13048-S, black.....set.	1.25
55	Pass	B5A-13048-S, black.....set.	1.25
56	Pass	B6A-13048-S, black.....set.	1.25
51-56	PU	52388-SSHL.....pr.	1.00

**HEADLIGHT RETAINING RING /
HARDWARE**

Headlight Bulb Retaining Ring



40-56	Pass	01A-13018, plain.....ea.	12.50
40-56	Pass	01A-13018-SS, stainless.....ea.	20.00
40-56	Merc	01A-13018, plain.....ea.	12.50
40-56	Merc	01A-13018-SS, stainless.....ea.	20.00
40-66	PU	01A-13018, plain.....ea.	12.50
40-66	PU	01A-13018-SS, stainless.....ea.	20.00

Headlight Bulb Retainer Screws

40-56	Pass	01A-13018-HK, sealed beam.....kit.	5.00
40-56	Merc	01A-13018-HK, sealed beam.....kit.	5.00
40-56	PU	01A-13018-HK, sealed beam.....kit.	5.00

Headlight Bulb Retainer Adjusting Screws



37-40	Pass	01A-13032-HK.....kit.	20.00
39-40	Merc	01A-13032-HK.....kit.	20.00
40-41	PU	01A-13032-HK.....kit.	20.00

Headlight Bucket Adjusting Spring

Two required per headlight bucket.



41-56	Pass	11A-13031.....ea.	2.00
41-56	Merc	11A-13031.....ea.	2.00
42-56	PU	11A-13031.....ea.	2.00

HEADLIGHT BULBS

Headlight Bulbs



28-34	Pass & PU	B-13007-D, 6V.....ea.	2.00
28-34	Pass & PU	B-13007-E, 12V.....ea.	2.00

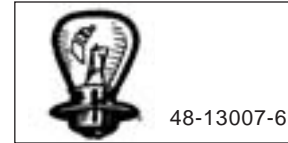

35-39	Pass & PU	48-13007-6, 6V.....ea.	3.00
35-39	Pass & PU	48-13007-12, 12V.....ea.	3.00
40-57	Pass & PU	01A-13007, 12V, sealed beam, 7".....ea.	8.00
40-55	Pass & PU	B5AF-13007, 6V, sealed bulb.....ea.	12.00

Halogen Headlight Bulb for Halogen Kits

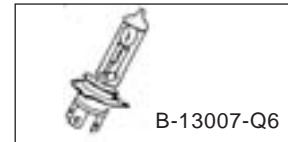

32-39	Pass & PU	B-13007-Q6, 6V.....ea.	16.00
32-39	Pass & PU	B-13007-Q12, 12V.....ea.	9.00

Halogen Headlamp Bulb

Fits directly into the rim with stock clips. Bulb is sealed and weatherproof. This clear bulb is 9" in diameter.

32-34	Pass	B-13007-CL9, 12 volt.....ea.	130.00
32-34	PU	B-13007-CL9, 12 volt.....ea.	130.00

Sealed Beam Halogen Headlight Bulb

Bulb does not have alignment tabs.

40-56	Pass & PU	F-13007-Q12, 12V, 7".....ea.	26.00
40-56	Pass & PU	01A-13007-H12, 12V, 7".....ea.	35.00

Chrome Headlight Bulb Visor



All	Pass & PU	A-13004-A, 7.5".....ea.	5.95
All	Pass & PU	A-13004-B, 5.75".....ea.	5.95

PARKING LIGHTS

Parking Light Assemblies



41	Pass	11A-13200.....ea.	40.00
----	------	-------------------	-------

47-48	Pass	6A-13200-T, with turn signal.....pr.	100.00
47-48	Pass	6A-13200-AMB, with amber lens.....ea.	34.95
50	Pass	0A-13200-A, RH, without turn signal.....ea.	75.00
50	Pass	0A-13200-B, RH, with turn signal.....ea.	75.00
50	Pass	0A-13201-A, LH, without turn signal.....ea.	75.00
50	Pass	0A-13201-B, LH, with turn signal.....ea.	75.00



51	Pass	1A-13200.....ea.	35.95
42-47	PU	6A-13200-T, with turn signal.....pr.	100.00
42-47	PU	6A-13200-AMB, with amber lens.....ea.	34.95
48-50	PU	7HC-13200, stainless trim.....ea.	32.50



51-52	PU	1C-13200-A, painted trim.....ea.	35.00
51-52	PU	1C-13200-SS, stainless trim.....ea.	40.00
53-54	PU	FAD-13200-A, painted trim.....ea.	37.50
53-54	PU	FAD-13200-SS, stainless trim.....ea.	42.50
55	PU	B5C-13200-A, painted trim.....ea.	35.00
55	PU	B5C-13200-SS, stainless trim.....ea.	48.00
56	PU	B6C-13200-A, painted trim.....ea.	35.00
56	PU	B6C-13200-SS, stainless trim.....ea.	48.00

Parking Lamp Housing

Parking light NOT included.



50	Pass	0A-8224-BZ8, RH.....ea.	275.00
50	Pass	0A-8225-BZ8, LH.....ea.	275.00
50	Pass	0A-8224-PR, RH & LH.....pr.	500.00
51	Pass	1A-8224/5, RH & LH.....pr.	625.00

Parking Light Body



49	Pass	8A-13215, RH.....ea.	27.50
49	Pass	8A-13216, LH.....ea.	27.50
50	Pass	0A-13215, RH.....ea.	20.00
50	Pass	0A-13216, LH.....ea.	20.00

Parking Light Turn Signal Kit

Kit includes 12V amber bulbs and sockets for two parking lights. 6V bulbs are not available for this application.

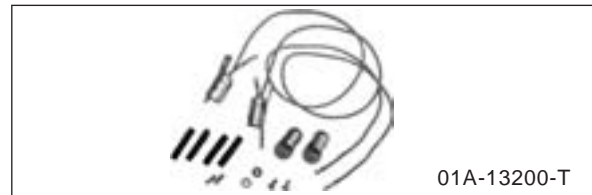

40	Pass	01A-13200-T, 12V.....kit.	40.00
40	Merc	01A-13200-T, 12V.....kit.	40.00
40-41	PU	01A-13200-T, 12V.....kit.	40.00

PARKING LIGHT LENS

Parking Light Lens

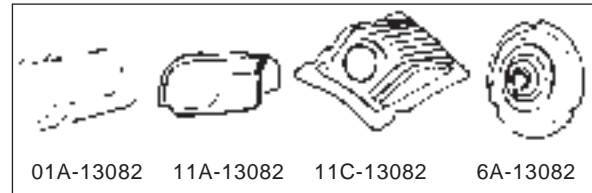

40	Pass	01A-13082.....ea.	15.00
41	Pass	11A-13082.....ea.	10.00
42-46	Pass	21A-13208, N.O.S.....ea.	10.00
47-48	Pass	6A-13082.....ea.	15.00
49	Pass	8A-13208, RH.....ea.	10.00
49	Pass	8A-13209, LH.....ea.	10.00
50	Pass	0A-13208.....ea.	5.00
51	Pass	1A-13208.....ea.	5.00
52	Pass	FAA-13208-B.....ea.	16.00
53	Pass	FAF-13208-A.....ea.	5.00
54	Pass	FAG-13208.....ea.	10.00
55	Pass	B5A-13208-B.....ea.	25.00
56	Pass	B6A-13208.....ea.	14.00
40	Merc	01A-13082.....ea.	15.00
49	Merc	7RA-13208.....ea.	15.00
50	Merc	0M-13208.....ea.	12.00
51	Merc	1M-13208, RH.....ea.	40.00
51	Merc	1M-13209, LH.....ea.	40.00
52-53	Merc	FAB-13208.....ea.	15.00
55-56	Merc	FDK-13208-A.....ea.	40.00
55-56	T-Bird	FAG-13208.....ea.	10.00
40	PU	01A-13082.....ea.	15.00



41	PU	11C-13082ea.	15.00
42-47	PU	6A-13082ea.	15.00
48-50	PU	7RC-13208, clearea.	6.50
48-50	PU	7RC-13208-AMB, amberea.	8.00
51-52	PU	1C-13208, clearea.	10.00
51-52	PU	1C-13208-AMB, amberea.	10.00
53-54	PU	FAE-13208-A, clearea.	10.00
53-54	PU	FAE-13208-AMB, amberea.	12.00
55-56	PU	B5C-13208-B, clearea.	10.00
55-56	PU	B5C-13208-AMB, amberea.	12.00

LED Park Light Lens

Perfect for those running a 12 volt system. Bright LEDs on a solid state circuit board that is epoxy coated. Remove old lens and bulb and replace with new LED lens. Must use a LED flasher for turn signals.

40	Pass	01A-13082-LED, amberea.	25.00
40-41	PU	01A-13082-LED, amberea.	25.00

PARKING LIGHT LENS GASKET & PADS

Parking Light Lens Gasket

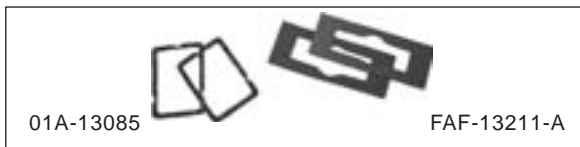

40	Pass	01A-13085pr.	5.00
41	Pass	11A-13211pr.	4.00
42-46	Pass	21A-13211pr.	4.00
47-48	Pass	21T-13211pr.	4.00
49	Pass	8A-13211pr.	4.00
50	Pass	0A-13211pr.	4.00
51	Pass	1A-13211pr.	6.00
52	Pass	FAA-13211-Apr.	4.00
53	Pass	FAF-13211-Apr.	4.00
54	Pass	FAG-13211-Apr.	5.00
55	Pass	B5A-13211-Apr.	6.00
56	Pass	B6A-13211-Apr.	6.00
40	Merc	01A-13085pr.	5.00
49	Merc	7RA-13211pr.	5.00
50	Merc	0M-13211pr.	6.00
51	Merc	1M-13211pr.	5.00
52-53	Merc	FAB-13211pr.	4.00
54	Merc	FAJ-13211-Apr.	5.00
55-56	Merc	FDK-13211-Bea.	6.00
55-56	T-Bird	FAG-13211-Apr.	5.00
57-60	T-Bird	B7S-13211-Apr.	4.50
40-41	PU	01A-13085pr.	5.00
42-47	PU	21T-13211pr.	4.00
48-50	PU	7HC-13211pr.	4.00
51-52	PU	1C-13211pr.	6.00
53-54	PU	FAE-13211-Apr.	5.00
55-56	PU	B5C-13211pr.	5.00

Parking Light Pad



41	Pass	11A-13217pr.	20.00
42-46	Pass	51A-13200-RPpr.	20.00
47-48	Pass	21T-13217, corkpr.	4.00
47-48	Pass	6A-13200-RP, rubberpr.	10.00
49	Pass	8A-13217-Bpr.	10.00
41	Merc	19A-13217pr.	36.00
42-48	Merc	29A-13217pr.	20.00
52-53	Merc	FAB-13217pr.	4.00
55-56	T-Bird	B5S-13217-Cpr.	10.00
57-60	T-Bird	B7S-13217-Apr.	4.50
42-47	PU	21T-13217, corkpr.	4.00
42-47	PU	6A-13200-RP, rubberpr.	10.00

Parking Light to Fender Seal

50	Pass	0A-13244pr.	4.00
51	Pass	1A-13244pr.	4.00
50	Merc	0M-13244pr.	6.00

Parking Light Wire Boot



42-50	Pass	6A-13225pr.	17.50
42-48	Merc	6A-13225pr.	17.50
49-50	Merc	7RA-13225pr.	36.00
42-47	PU	6A-13225pr.	17.50

PARKING LIGHT TRIM

Parking Light Lens Bezel

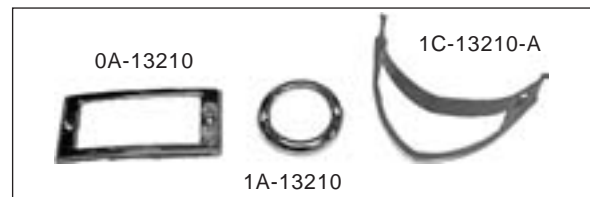

40	Std Pass	01A-13084, chromepr.	60.00
49	Pass	8A-13237, LH, N.O.S.ea.	40.00
50	Pass	0A-13210, chromeea.	20.00
51	Pass	1A-13210, chromeea.	18.00
53	Pass	FAD-13210-A, RHea.	27.50
53	Pass	FAD-13212-A, LHea.	27.50
40-41	PU	01A-13084, chromepr.	60.00
51-52	PU	1C-13210-A, paintedea.	12.50
51-52	PU	1C-13210-SS, stainlessea.	18.00
53-54	PU	FAC-13210-A, paintedea.	12.50
53-54	PU	FAC-13210-SS, stainlessea.	18.00
55-56	PU	B5C-13210-A, paintedea.	12.50

55-56 PU B5C-13210-SS, stainlessea. 22.00

Parking Light Lens Retainer



54 Pass B4AZ-13210-A.....ea. 15.00

Parking Light Extension Tip



56 Pass B6A-8224-5, chromepr. 125.00

PARKING LIGHT HARDWARE

Parking Light Lens Clips

Three required per lens.

40 Pass 2102ea. .20
 40 Merc 2102ea. .20
 40-41 PU 2102ea. .20

Parking Light Lens Screws

One set required per vehicle.

49 Pass 8A-13238-S.....set. 4.00
 50 Pass 0A-13238-S.....set. 3.00
 51 Pass 1A-13238-S.....set. 3.00
 52 Pass BA-13238-Sset. 4.00
 53 Pass BF-13238-S.....set. 3.00
 54 Pass B4A-13238-S.....set. 4.00
 55 Pass B5A-13238-S.....set. 5.00
 56 Pass B6A-13238-S.....set. 3.00
 57 T-Bird B6A-13238-S.....set. 3.00
 53-56 PU 357456-S, 2 pr req'd.....pr. 1.00

COWL LIGHT

Cowl Light Assembly

Concourse cowl lights include stainless housings and rims, die cast chrome arms, glass lenses, reflectors, 12V bulbs, wiring, and nuts. 6V bulbs can be purchased separately.

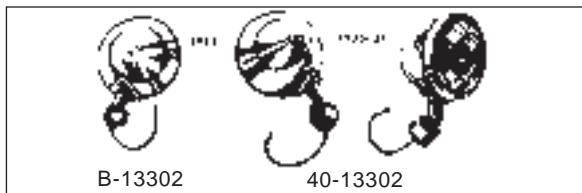

32 Pass B-13302.....pr. 115.00
 33-34 Pass 40-13302pr. 115.00

Cowl Light Assembly with Turn Signals

Cowl lights include stainless housings and rims, die cast chrome arms, glass lenses, reflectors, 12V bulbs, wiring, and nuts. 6V bulbs are not available for this application.



32 Pass B-13302-TS.....pr. 115.00
 33-34 Pass 40-13302-TSpr. 115.00

Cowl Light Turn Signal Conversion Kit

This kit includes reflectors, sockets, gaskets, 12V bulbs, and wire pigtails. 6V bulbs are not available for this application.

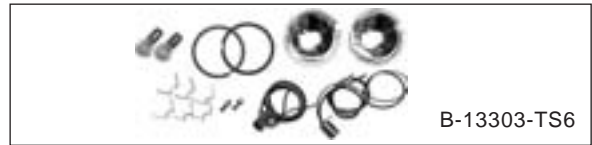

32 Pass B-13303-TS.....kit. 39.00
 33-34 Pass 40-13303-TS12kit. 39.00

Cowl Light Arm

32 Pass B-13322, chrome.....pr. 56.00
 33-34 Pass 40-13322, chromepr. 56.00

Cowl Light Lens

32 Pass B-13308ea. 6.50
 33-34 Pass 40-13308.....ea. 5.50

Cowl Light Lens Gasket

32 Pass B-13309.....pr. 2.00
 33-34 Pass 40-13309pr. 2.00

Cowl Light Lens Clips

30-34 Pass A-13316-S, 6 pcs.set. 2.00

Cowl Light Reflector

32 Pass B-13315ea. 9.00
 33-34 Pass 40-13315ea. 10.00

Cowl Light to Body Pad

32 Pass B-13324-A, exc. 3 window cpepr. 4.00
 32 Cpe 3W B-13324-B.....pr. 5.50
 33-34 Pass 40-13324pr. 4.00

Cowl Light Mounting Screws

30-32 Pass 1127set. 2.00



TAIL LIGHT

Tail Light Assembly

The 32-48 Pass tail lights include 12V bulbs. The 6V bulbs are sold separately. The 32-34 Pass & 33-34 Sdn Dly tail lights are all stainless. The 32-48 Wagon, 35-36 Pass, and 35-48 Sdn Dly are black with stainless trim. Stainless Tail Light Note: Part #40-13402-DR & #40-13403-DL will fit 1932-1936 passenger and 1932-1948 Wagon.



32	Pass	18-13402-DR, RH	ea.	30.00
32	Pass	18-13403-DL, LH.....	ea.	30.00
33-34	Pass	40-13402-DR, RH	ea.	30.00
33-34	Pass	40-13403-DL, LH.....	ea.	30.00
35-36	Pass	48-13402-DR, RH	ea.	30.00
35-36	Pass	48-13403-DL, LH.....	ea.	30.00
37	Pass	78-13402-R, RH	ea.	45.00

37	Pass	78-13403-L, LH.....	ea.	45.00
38-39	Pass	81A-13405-D.....	ea.	30.00
38-39	Pass	81A-13405-DLED, with LED bulb.....	ea.	45.00
40	Pass	01A-13405-D.....	ea.	30.00
41	Pass	11A-13404-DR, RH	ea.	68.00
41	Pass	11A-13405-DL, LH.....	ea.	68.00
42-48	Pass	21A-13405-D.....	ea.	30.00
49-50	Pass	8A-13404-A, except wagon.....	ea.	75.00
49-50	Pass	8A-13404-BD, with blue-dot lens, except wagon	ea.	80.00



51	Pass	1A-13404-A, RH, except wagon	ea.	100.00
51	Pass	1A-13405-A, LH, except wagon	ea.	100.00
33-34	Sdn Dly	40-13402-DR, RH	ea.	30.00
33-34	Sdn Dly	40-13403-DL, LH.....	ea.	30.00
35-48	Sdn Dly	48-13402-DR, RH	ea.	30.00
35-48	Sdn Dly	48-13403-DL, LH.....	ea.	30.00
32-42	Wgn	B-13402-DR, RH.....	ea.	30.00
32-42	Wgn	B-13403-DL, LH	ea.	30.00
46-48	Wgn	48-13402-DR, RH	ea.	30.00
46-48	Wgn	48-13403-DL, LH.....	ea.	30.00
32-42	PU	B-13402-DR, RH.....	ea.	30.00
32-42	PU	B-13403-DL, LH	ea.	30.00



32-52	PU	40-13402-DR, RH	ea.	30.00
32-52	PU	40-13403-DL, LH.....	ea.	30.00
46-52	PU	48-13402-DR, RH	ea.	30.00
46-52	PU	48-13403-DL, LH.....	ea.	30.00



53-54	PU	C3TZ-13404-F, RH, round	ea.	30.00
53-54	PU	C3TZ-13405-H, LH, round	ea.	30.00



53-56	PU	B6C-13404-B, RH, black, shield type.....ea.	20.00
53-56	PU	B6C-13405-B, LH, black, shield type.....ea.	21.00
53-56	PU	B5C-13404-SS, RH, stainless, shield type.....ea.	30.00
53-56	PU	B5C-13405-SS, LH, stainless, shield type.....ea.	30.00
48-56	Panel	11A-13404-DR, RH.....ea.	68.00
48-56	Panel	11A-13405-DL, LH.....ea.	68.00

Tail Light Assembly with 6 Volt LED Lens

Nice lights for a stock driver car. Must use a LED flasher when using turn signals.

38-39	Pass	81A-13450-LED6.....ea.	29.00
-------	------	------------------------	-------

Tail Light Assembly with 12 Volt LED Lens

Perfect for those running a 12 volt system. Bright LEDs on a solid state circuit board that is epoxy coated. Left side includes license plate lens. Must use a LED flasher when using turn signals.

32	Pass	18-13402-LED, RH, polished stainless.....ea.	42.00
32	Pass	18-13403-LED, LH, polished stainless.....ea.	50.00
33-34	Pass	40-13402-LED, RH, polished stainless.....ea.	42.00
33-34	Pass	40-13403-LED, LH, polished stainless.....ea.	50.00
35-36	Pass	48-13402-LED, RH.....ea.	39.00
35-36	Pass	48-13403-LED, LH.....ea.	47.00
37	Pass	78-13402-LED, RH.....ea.	49.50
37	Pass	78-13403-LED, LH.....ea.	57.50
33-34	Sdn Dly	40-13402-LED, RH, polished stainless.....ea.	42.00
33-34	Sdn Dly	40-13403-LED, LH, polished stainless.....ea.	50.00
35-48	Sdn Dly	48-13402-LED, RH.....ea.	39.00
46-48	Wgn	48-13402-LED, RH.....ea.	39.00
46-48	Wgn	48-13403-LED, LH.....ea.	47.00
46-52	PU	48-13402-LED, RH.....ea.	39.00
46-52	PU	48-13403-LED, LH.....ea.	47.00

"Hot Rod" Tail Lights

Chrome plated bezel w/glass lens, rubber pad, & 12V bulb. 4-1/2" Diameter x 1-3/4" high.



All	Pass & PU	HR-13405, red lens.....pr.	125.00
All	Pass & PU	HR-13405-LED, with LED bulb.....ea.	48.00

All	Pass & PU	HR-13405-BD, w/blue dot.....pr.	125.00
-----	-----------	---------------------------------	--------

"Baby" Hot Rod Tail Lights

Stainless bezel w/glass lens, rubber pad, & 12V bulb. 3-3/4"Diameter x 1" high



All	Pass & PU	6A-13200-T/L.....pr.	100.00
-----	-----------	----------------------	--------

Brushed Aluminum Third Brake Light Assembly

All	Pass & PU	BA-13613.....ea.	48.00
-----	-----------	------------------	-------

TAIL LIGHT LENS

Tail Light Lens

The 32-50 Pass are a glass lens, and the 51-56 Pass are a plastic lens.

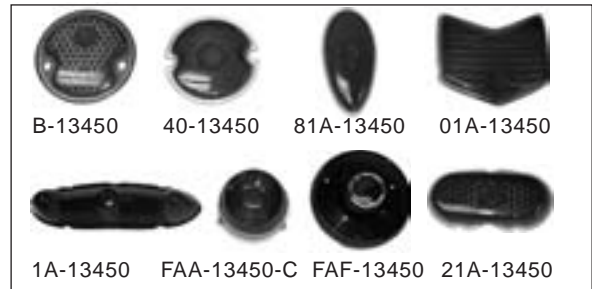

32	Pass	B-13450.....ea.	8.00
33-36	Pass	40-13450.....ea.	10.00
37	Pass	78-13450.....ea.	8.00
38-39	Pass	81A-13450.....ea.	8.00
40	Pass	01A-13450.....ea.	10.00
41	Pass	11A-13450.....ea.	8.00
42-48	Pass	21A-13450.....ea.	8.00
49-50	Pass	8A-13450.....ea.	11.00
51	Pass	1A-13450.....ea.	13.00
52	Pass	FAA-13450-C.....ea.	10.00
53	Pass	FAF-13450, with chrome sleeve, and Ford script.....ea.	19.50
53-54	Pass	FDA-13450, with Ford script.....ea.	10.00
55	Pass	B5A-13450-AF, with Ford script.....ea.	15.00
55	Pass	B5A-13450-A.....ea.	12.00
56	Pass	B6A-13450-AF, with Ford script.....ea.	25.00
56	Pass	B6A-13450-A.....ea.	22.00
32-42	Wgn	B-13450.....ea.	8.00
46-51	Wgn	40-13450.....ea.	10.00
49-50	Merc	8M-13450, RH.....ea.	25.00
49-50	Merc	8M-13451-A, LH.....ea.	25.00
54	Merc	FDC-13450.....ea.	14.00

Section 22 - Lights



C&G Early Ford Parts, Inc.

32-42	PU	B-13450	ea.	8.00
46-52	PU	40-13450.....	ea.	10.00
53-54	PU	B3C-13450-P, round	ea.	5.00
53-54	PU	B3C-13450-FS, round, with chrome Ford script.....	ea.	10.00
53-56	PU	B5C-13450, shield type.....	ea.	6.00
53-56	PU	B5C-13450-BL, shield type, w/Ford block letters.....	ea.	16.00



53-56	PU	B5C-13450-FS, shield type, w/chrome Ford script.....	ea.	16.00
48-56	Panel	11A-13450.....	ea.	8.00

LED Tail Light Lens

Perfect for those running a 12 volt system. Bright LEDs on a solid state circuit board that is epoxy coated. Remove old lens and bulb and replace with new LED lens. Left side lens includes license plate lens. #B-13450-L & -R are for two socket tail lights. Other years are for un-even pin taillight sockets. Must use a LED flasher for turn signals.

32	Pass	B-13450-L-LED, LH	ea.	34.00
32	Pass	B-13450-R-LED, RH.....	ea.	25.00
37	Pass	78-13450-L-LED, LH, except wagon.....	ea.	38.00
37	Pass	78-13450-R-LED, RH, except wagon.....	ea.	24.00
42-48	Pass	21A-13450-LED, RH or LH, except wagon	ea.	26.00
49-50	Pass	8A-13450-LED, except wagon	ea.	26.00
32-42	Wgn	B-13450-L-LED, LH	ea.	34.00
32-42	Wgn	B-13450-R-LED, RH.....	ea.	25.00
32-42	PU	B-13450-L-LED, LH	ea.	34.00
32-42	PU	B-13450-R-LED, RH.....	ea.	25.00

Blue Dot Tail Light Lens

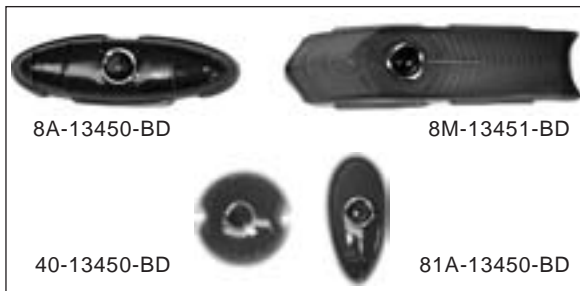

32	Pass	B-13450-BD	ea.	14.00
33-36	Pass	40-13450-BD	ea.	14.00
37	Pass	78-13450-BD	ea.	14.00
38-39	Pass	81A-13450-BD	ea.	14.00
40	Pass	01A-13450-BD	ea.	14.00
41	Pass	11A-13450-BD	ea.	14.00
42-48	Pass	21A-13450-BD	ea.	14.00
49-50	Pass	8A-13450-BD	ea.	17.00
32-42	Wgn	B-13450-BD	ea.	14.00
46-51	Wgn	40-13450-BD	ea.	14.00
49-50	Merc	8M-13450-BD, RH.....	ea.	35.00

49-50	Merc	8M-13451-BD, LH	ea.	35.00
32-42	PU	B-13450-BD	ea.	14.00
46-52	PU	40-13450-BD	ea.	14.00
53-54	PU	B3C-13450-PBD, round	ea.	16.00
53-54	PU	B3C-13450-SBD, with chrome Ford script.....	ea.	25.00
53-56	PU	B5C-13450-BD, shield type	ea.	15.00
53-56	PU	B5C-13450-FBD, shield type, w/Ford block.....	ea.	22.00



53-56	PU	B5C-13450-SBD, shield type, w/chrome Ford script.....	ea.	20.00
48-56	Panel	11A-13450-BD	ea.	14.00

Blue Dot for Tail Light Lens



All	Pass & PU	BD-13400, glass.....	pr.	10.00
-----	-----------	----------------------	-----	-------

"Ford" Script Emblem

Large size for shield tail lights.

55-56	PU	91A-16606-L	ea.	5.00
-------	----	-------------------	-----	------

TAIL LIGHT GASKETS & PADS

Tail Light Lens Gasket



32	Pass	B-13461.....	pr.	2.00
33-36	Pass	40-13460/1, 2 required.....	pr.	6.00
37	Pass	78-13461	pr.	2.25
38-39	Pass	81A-13461	pr.	4.00
40	Pass	01A-13461	pr.	4.00
41	Pass	11A-13461	pr.	4.00
41	Pass	11A-13461-A, housing to bracket.....	pr.	4.00
42-48	Pass	21A-13461	pr.	4.00
49-50	Pass	8A-13461	pr.	5.00
51	Pass	1A-13461	pr.	5.00
52	Pass	FAA-13461-C.....	pr.	5.00
53-54	Pass	FAE-13461-A	pr.	5.00
55	Pass	B5A-13461-A.....	pr.	5.00
56	Pass	B6A-13461-A.....	pr.	5.00
32-42	Wgn	B-13461	pr.	2.00
46-51	Wgn	40-13460/1	pr.	6.00
49-50	Merc	8M-13461	pr.	7.00
51	Merc	1M-13461	pr.	8.00

52-53	Merc	FAB-13461-A.....pr.	6.00
54	Merc	FAF-13461-A.....pr.	6.00
55	Merc	FDK-13461-A.....pr.	8.00
56	Merc	FDT-13461-A.....pr.	6.00
55	T-Bird	B5A-13461-A.....pr.	5.00
56	T-Bird	B6A-13461-A.....pr.	5.00
32-42	PU	B-13461.....pr.	2.00
46-52	PU	40-13460/1.....pr.	6.00
55-UP	PU	B5C-13461, shield.....pr.	6.00
48-56	Panel	11A-13461.....pr.	4.00

Tail Light Pad

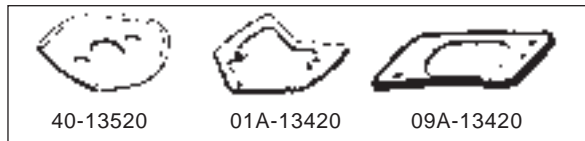

33-34	Pass	40-13520.....pr.	8.00
35	Pass	48-13520.....pr.	8.00
36	Pass	68-13520-A, exc. conv sedan.....pr.	8.00
36	Conv Sdn	68-13520-B.....pr.	17.50
37	Pass	78-13520, with bead.....pr.	8.00
37	Pass	78-13520-NB, no bead.....pr.	5.00
38-39	Pass	81A-13420, with bead.....pr.	8.00
38-39	Pass	81A-13420-NB, no bead.....pr.	4.00
40	Pass	01A-13420.....pr.	6.00
41	Pass	11A-13420.....pr.	8.00
42-48	Pass	21A-13420/1.....pr.	10.00
42-48	Pass	21A-13520, use w/o tail light bracket.....pr.	6.50

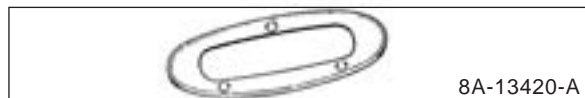

49-50	Pass	8A-13420-A.....pr.	6.00
51	Pass	1A-13420-B.....pr.	4.00
52-54	Pass	FAA-13420.....pr.	10.00
55-56	Pass	B6A-13420.....pr.	15.00
40	Merc	09A-13420/1.....pr.	24.00
41	Merc	19A-13420/1.....pr.	20.00
42-48	Merc	29A-13420/1.....pr.	20.00
49-50	Merc	8M-13420.....pr.	20.00
51	Merc	1M-13420.....pr.	37.00
52-53	Merc	FAB-13420-A.....pr.	60.00
54	Merc	FDC-13420-A.....pr.	63.00
56	Merc	BN-13420.....pr.	58.00
55-56	T-Bird	B6A-13420.....pr.	15.00
48-56	Panel	11A-13420.....pr.	8.00

Tail Light Housing to Body Gasket



51	Pass	1A-13453.....pr.	8.00
----	------	------------------	------

49-50	Merc	8M-13453.....pr.	10.50
54	Merc	FAA-13453-A.....pr.	6.00

Tail Light Housing to Body Bumpers

51	Pass	1A-13415.....set.	4.00
----	------	-------------------	------

Tail Light Housing to Bumper Seal

52-53	Merc	FAA-17836-A.....ea.	50.00
-------	------	---------------------	-------

TAIL LIGHT TRIM / BODY / BEZELS

Tail Light Lens Bezel

32	Pass	B-13448, stainless.....ea.	4.50
33-36	Pass	40-13448-SS, stainless, except wagon.....ea.	7.00
38-39	Pass	81A-13448-SS, stainless, except wagon.....ea.	6.00
40	Pass	01A-13448, stainless, except wagon.....ea.	10.00
42-48	Pass	21A-13448, stainless, except wagon.....ea.	11.50



49-50	Pass	8A-13448, chrome, except wagon.....ea.	20.00
51	Pass	1A-13448-A, chrome, except wagon.....ea.	25.00



52	Pass	FAA-13448-A, chrome.....ea.	40.00
32-42	Wagon	B-13448, stainless.....ea.	4.50
46-51	Wagon	40-13448-SS, stainless.....ea.	7.00
32-42	PU	B-13448, stainless.....ea.	4.50
46-52	PU	40-13448-SS, stainless.....ea.	7.00

Tail Light Lens Chrome Sleeve



53	Pass	FAA-13489.....ea.	12.50
55	Pass	B5A-13489-A.....ea.	13.50

Chrome Tail Light Lens Bezel



56	Pass	B6A-13489-A.....ea.	16.00
----	------	---------------------	-------

Tail Light Housing Body & Bezel



51	Pass	1A-13434-A, RH, except wagon, includes wiring	ea.	50.00
51	Pass	1A-13435-A, LH, except wagon, includes wiring	ea.	50.00
53	Pass	B3AZ-13434-A, , wiring is NOT included.....	ea.	60.00
54	Pass	B4AZ-13434-A, , wiring is NOT included.....	ea.	64.00
55	Pass	B5AZ-13434-A, includes wiring.....	ea.	43.00
56	Pass	B6AZ-13434-A, includes wiring.....	ea.	40.00
55	T-Bird	B5AZ-13434-A, includes wiring.....	ea.	43.00
56	T-Bird	B6AZ-13434-A, includes wiring.....	ea.	40.00

Tail Light Body

Wiring is NOT included.



49-50	Pass	8A-13434-A.....	ea.	24.00
-------	------	-----------------	-----	-------

Tail light Housing

Stamped steel, includes mounting plates.

42-48	Pass	21A-13470-HR, without holes for trim.....	ea.	175.00
-------	------	---	-----	--------



42-48	Pass	21A-13470-K, with holes for trim.....	pr.	175.00
-------	------	---------------------------------------	-----	--------

Tail Light Housing Trim

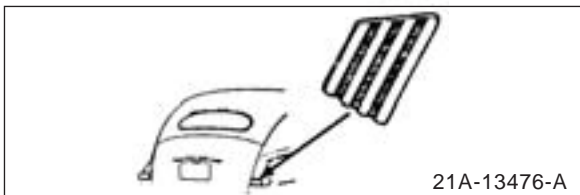

42-48	Pass	21A-13476-A	pr.	23.50
42-48	Pass	21A-13476-AS-BD, mfg by Drake.....	pr.	35.00

TAIL LIGHT BRACKETS

Tail Light Bracket



32	Pass	B-13470, RH, black.....	ea.	40.00
32	Pass	B-13471, LH, black.....	ea.	40.00
32	Pass	B-13470-C, RH, chrome.....	ea.	45.00
32	Pass	B-13471-C, LH, chrome.....	ea.	45.00
32	Pass	B-13470-SS, RH, stainless.....	ea.	80.00
32	Pass	B-13471-SS, LH, stainless.....	ea.	80.00
33-34	Pass	40-13470, RH, black, w/hole for rumble step plate.....	ea.	35.00
33-34	Pass	40-13471, LH and RH, black, no hole for step plate.....	ea.	35.00
33-34	Pass	40-13470-C, RH, chrome, w/hole for rumble step plate.....	ea.	45.00
33-34	Pass	40-13471-C, LHand RH, chrome, no hole.....	ea.	45.00
33-34	Pass	40-13471-CHP, 4" long, black, fits RH or LH.....	ea.	45.00
36	Pass	68-13470-A, black, RH, exc. conv sedan, no rumble step.....	ea.	110.00
37	Pass	78-13470, RH, black, exc. conv.....	ea.	40.00
37	Pass	78-13471, LH, black exc. conv.....	ea.	40.00

Pick-Up Tail Light Bracket

Brackets fit right or left unless stated.



30-37	PU	B-13470-B, black, mounts under bed.....	ea.	8.00
-------	----	---	-----	------



35-36	PU	50-13470, mounts to stake pocket.....	ea.	18.00
37	PU	77-13470, mounts to stake pocket.....	ea.	20.00
38-47	PU	91C-13471, black w/o bumper.....	ea.	12.00
38-47	PU	91C-13471-SS, stainless w/o bumper.....	ea.	16.00
38-52	PU	81Y-13470-SS, RH, stainless w/bumper.....	ea.	16.00
38-52	PU	81Y-13471-SS, LH stainless w/bumper.....	ea.	16.00
38-52	PU	81Y-13470, RH, black w/bumper.....	ea.	8.50
38-52	PU	81Y-13471, LH, black w/bumper.....	ea.	8.50

53-64	PU	BAAA-13470-SS, stainless	ea.	12.50
53-64	PU	BAAA-13470-C, chrome.....	ea.	9.00
53-64	PU	BAAA-13470-P, black	ea.	7.00

Tail Light Stand Brace

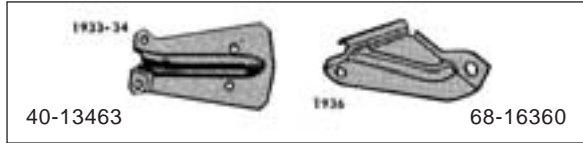

33-34	Pass	40-13463, RH or LH	ea.	30.00
35	Pass	48-16360, RH	ea.	30.00
35	Pass	48-16361, LH	ea.	30.00
36	Pass	68-16360, RH	ea.	30.00
36	Pass	68-16361, LH	ea.	30.00
37	Pass	78-16360, includes supports and hardware for RH and LH.....	kit.	30.00

Tail Light Wire Shield

These are 1-3/4" tall. Check the distance on your truck between the fender and the back of the tail light bracket for clearance.



28-48	Wgn	B-13467-BK, black.....	ea.	6.00
28-48	Wgn	B-13467-SS, stainless.....	ea.	9.00
28-56	PU	B-13467-BK, black.....	ea.	6.00
28-56	PU	B-13467-SS, stainless.....	ea.	9.00

Stainless Tail Light Conduit

32-56	PU	B-13578-18, 18".....	pr.	11.00
-------	----	----------------------	-----	-------

TAIL LIGHT HARDWARE

Tail Light Screw Kit

28-32	Pass & PU	1128	set.	1.50
33-36	Pass & PU	3105	set.	1.75

Tail Light & License Plate Bracket Mounting Kit

48-56	PU	6-0220, stainless.....	kit.	14.00
-------	----	------------------------	------	-------

Tail Light Lens Snap Ring

29-32	Pass	1131	ea.	1.00
-------	------	------------	-----	------

Tail Light Bezel Screws

51	Pass	1A-13449-S.....	set.	5.00
----	------	-----------------	------	------

Tail Light Lens Reflectors



51	Pass	1A-13437-PR	pr.	15.00
----	------	-------------------	-----	-------

Tail Light Reflector



49-50	Merc	8M-13437, round	pr.	22.50
51-53	Merc	1M-13437, round	pr.	15.00

Tail Light Lens Screws

One set does two tail lights.

52	Pass	BA-13449-S.....	set.	4.00
53	Pass	BF-13449-S.....	set.	4.00
54	Pass	B4A-13449-S.....	set.	Call
55	Pass	B5A-13449-S.....	set.	4.00
56	Pass	B6A-13449-S.....	set.	4.00

DOME LIGHT

See section 21 for dome light switch

Dome Light Assembly



28-36	Pass	A-13771, w/o switch	ea.	45.00
28-36	Pass	A-13771-WS, w/switch	ea.	52.00



37-40	Cpe/Sdn	01A-13779-SS	ea.	30.00
28-48	Wgn	A-13771, w/o switch	ea.	45.00
28-48	Wgn	A-13771-WS, w/switch	ea.	52.00

Dome Light Housing & Lens

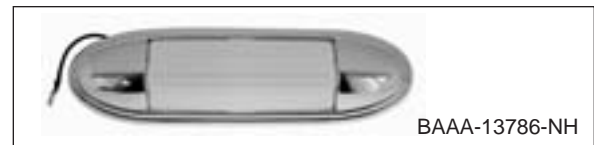

49-51	Wagon	BAAA-13786-NH, chrome.....	ea.	40.00
49-51	Merc	BAAA-13786-NH, chrome.....	ea.	40.00
49-51	Merc Wgn	BAAA-13786-NH, chrome.....	ea.	40.00
53-56	PU	BAAA-13786-P, painted.....	ea.	40.00
53-56	PU	BAAA-13786-C, chrome.....	ea.	50.00



DOME LIGHT LENS

Dome Light Lens

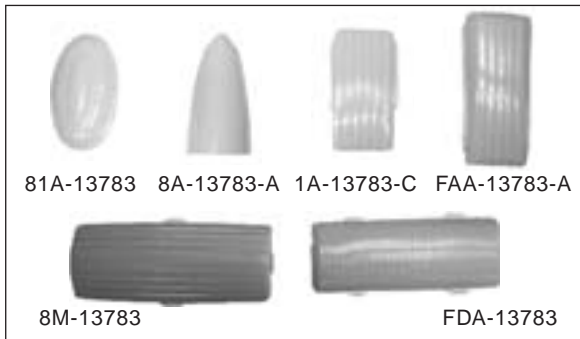

28-36	Pass	A-13771-G, glass.....ea.	10.00
28-48	Wagon	A-13771-G, glass, flat typeea.	10.00
38-40	Cpe/Sdn	81A-13783ea.	6.00
49-50	Cpe/Sdn	8A-13783-A.....ea.	5.00
49-51	Wgn	8M-13783ea.	8.00
51	Cpe/Sdn	1A-13783-C, , except 2 Dr Hrdtop.....ea.	7.50
51	Hardtop 2D	1A-13783-PRpr.	25.00
52-53	Cpe/Sdn	FAA-13783-A, except 2 Dr Hrdtop.....ea.	6.00
54-56	Pass	FDA-13783ea.	7.00
49-51	Merc	8M-13783, rectangle.....ea.	8.00
49-51	Merc Wgn	8M-13783ea.	8.00
51	Merc	1M-13783, oblongea.	20.00
52-54	Merc 2D HdtpFAC-13783-A, 2 req'd 15.00	ea.
52-55	Merc Sdn	FAB-13783-Aea.	15.00
52-55	Merc Wgn	FAB-13783-Aea.	15.00
53-56	PU	8M-13783ea.	8.00

Dome Light Lens Gasket

51-52	PU	1C-13876ea.	2.00
-------	----	-------------------	------

BACK UP LIGHT

See section 21 for back up light switch

Accessory Back Up Light Kit

Includes 2 lamps, switch, mounting bracket, and wiring harness.
Fordomatic transmissions use all parts in kit except switch & bracket.



49-51	Pass	8A-18275-A, exc. wagon.....kit.	125.00
-------	------	---------------------------------	--------

Back Up Light Installation Kit With Housings

Kit includes housings, lenses, gaskets, pads, sockets, & wiring.

55	Pass	B5A-18275-Akit.	150.00
56	Pass	B5A-18275-A, exc. fairlane.....kit.	150.00
55	T-Bird	B5A-18275-Akit.	150.00

Back Up Light Installation Kit Without Housings

Kit includes lenses, gaskets, sockets, and wiring.

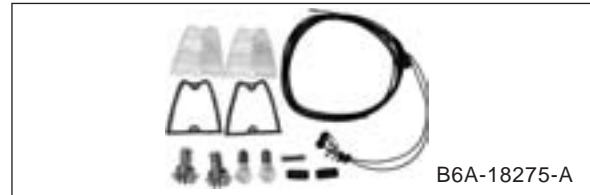

56	Frln	B6A-18275-Akit.	99.95
56	T-Bird	B6A-18275-Akit.	99.95

Back Up Light Housing



55	Pass	B5A-15515ea.	30.50
56	Pass	B5A-15515, exc. fairlaneea.	30.50
55	T-Bird	B5A-15515ea.	30.50

Back Up Light Housing Reflector

56	Frln	B6A-13437-Aea.	5.00
56	T-Bird	B6A-13437-Aea.	5.00

BACK UP LIGHT LENS / GASKETS / PADS

Back Up Light Lens

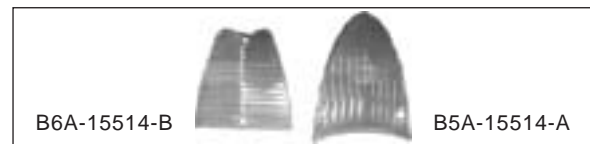

49-51	Pass	8A-15514-A, exc. wagon.....ea.	15.00
55	Pass	B5A-15514-Aea.	10.00
56	Pass	B5A-15514-A, exc. fairlaneea.	10.00
56	Frln	B6A-15514-Bea.	11.00
55	T-Bird	B5A-15514-Aea.	10.00
56	T-Bird	B6A-15514-Bea.	11.00

“Just to let you know that I really appreciate your help and kindness!!!! You are THE BEST!!!!”

Thanks Again,
Edward A., Switzerland

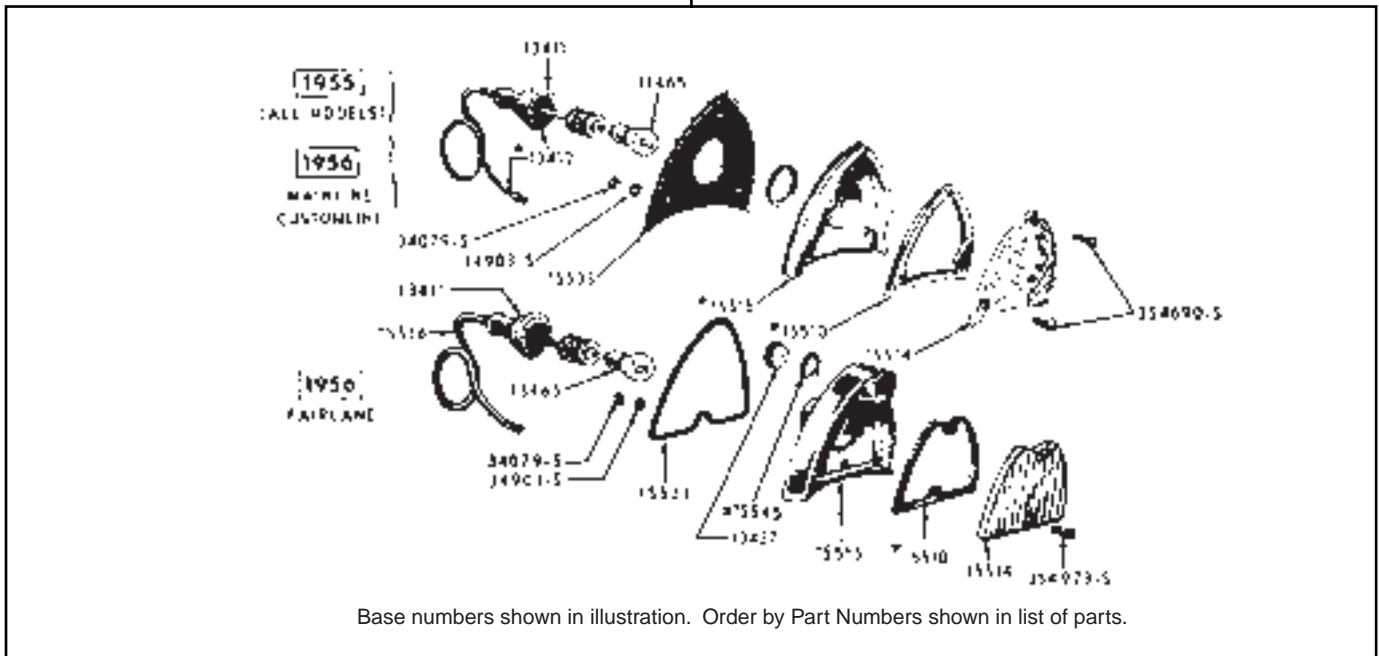

Base numbers shown in illustration. Order by Part Numbers shown in list of parts.

Back Up Light Lens Bezel

49-51	Pass	8A-15513ea.	30.00
-------	------	----------	----------	-------

Back Up Light Lens Gasket

49-51	Pass	8A-15510, exc. wagonpr.	3.00
52-54	Pass	FAA-15510pr.	3.00
55	Pass	B5A-15510pr.	4.00
56	Pass	B5A-15510, exc. fairlanepr.	4.00
56	Frln	B6A-15510pr.	4.00
52-53	Merc	FAA-13460-Apr.	6.00
55	T-Bird	B5A-15510pr.	4.00
56	T-Bird	B6A-15510pr.	4.00

Back Up Light Pad

49-51	Pass	8A-15533, exc. wagonpr.	5.00
52-54	Pass	FAB-15533-Apr.	7.00
55	Pass	B5A-15533-Apr.	7.00
56	Pass	B5A-15533-A, exc. fairlanepr.	7.00
56	Frln	B6A-15533-Apr.	5.00
55	T-Bird	B5A-15533-Apr.	7.00
56	T-Bird	B6A-15533-Apr.	5.00

BLOCK OFF PLATE

Back Up Light Block Off Plate



55	Pass	B5A-15514-Cea.	21.95
56	Pass	B5A-15514-C, exc. fairlaneea.	21.95
55	T-Bird	B5A-15514-Cea.	21.95

Back Up Light Block Off Plate Cover Gasket

55	Pass	B5A-15510-Bpr.	9.00
56	Pass	B5A-15510-B, exc. fairlanepr.	9.00
55	T-Bird	B5A-15510-Bpr.	9.00

BULBS

Light Bulb Pliers

Perfect for removing those stubborn or rusted light bulbs. Fits various sizes.

All		TL-102ea.	14.50
-----	--	--------	----------	-------

Halogen Tail Light Bulb

No special sockets or brackets are required for installation. The bulb installs like a regular tail light bulb.

All	Pass & PU	B-13465-Q12, 12V, replacement for #1003ea.	11.00
All	Pass & PU	B-13465-Q6, 6V, replacement for #1129ea.	13.00
All	Pass & PU	B-13466-Q12, 12V, replacement for #67ea.	11.00
All	Pass & PU	B-13466-Q6, 6V, replacement for #63ea.	13.00
All	Pass & PU	11A-13465-Q6, 6V, 55/5 watt, replacement for #1154ea.	15.00
All	Pass & PU	40-13465-H6, 6V, 55/5 watt, replacement for #1158ea.	17.00
All	Pass & PU	11A-13465-Q12, 12V, 50/15 watt, replacement for #1157ea.	10.00
All	Pass & PU	40-13465-1176, 12V, replacement for #1176ea.	14.00
33-48	Pass & PU	40-13465-Q6, 6Vea.	6.00

Halogen Taillight Conversion Kit

Special socket and bulb to convert to halogen.

32	Pass	B-13426-QH12, 12 voltkit.	29.50
32-42	Wagon	B-13426-QH12, 12 voltkit.	29.50

Section 22 - Lights



C&G Early Ford Parts, Inc.

32-42	PU	B-13426-QH12, 12 volt.....kit.	29.50
46-52	PU	01C-13426/7-QH-6, 6 volt.....kit.	29.50

LED Bulbs

Replace regular light bulbs with bright LED bulbs. No special socket or wiring required.

All		1157-9, amber color.....ea.	16.00
All		1157-9R, red color.....ea.	16.00
All		LED-101, , 1" diameter, 11 LED array.....pr.	20.00
All		LED-100, , 1-3/4" diameter, 25 LED array...pr.	25.00

12 Volt Exterior Bulbs

We carry a wide variety of light bulbs in 6 and 12 volt. 1932-55 cars and pickups were originally 6 volt, 1956 to present are 12 volt. If you do not find a listing for your application look at your old bulb for the number.

32	Pass	67-12V, Tail Light.....ea.	1.50
32	Pass	1003-12V, Tail Light.....ea.	1.50
32-36	Pass	67-12V, Park Light.....ea.	1.50
33-37	Pass	1176-12V, Tail Light (inline studs).....ea.	2.00
33-48	Pass	1157-12V, Tail Light (offset studs).....ea.	1.50
33-48	Pass	1157-NA-12V, Amber, Tail Light (offset studs).....ea.	2.50
37-40	Pass	1895-12V, Park Light.....ea.	1.50
38-56	Pass	67-12V, License Plate.....ea.	1.50
42-51	Pass	1003-12V, Tail Light.....ea.	1.50
47-48	Pass	67-12V, Park Light.....ea.	1.50
49-56	Pass	1157-12V, TailLight (offset studs).....ea.	1.50
49-56	Pass	1157-NA-12V, Amber, Parking Light w/turn signals (offset studs).....ea.	2.50
49-56	Pass	1157-12V, Parking Light w/turn signals (offset studs).....ea.	1.50
49-56	Pass	1157-NA-12V, Amber, TailLight (offset studs).....ea.	2.50
55	Pass	1003-12V, B/U Light.....ea.	1.50
32-42	Wgn	67-12V, Tail Light.....ea.	1.50
32-42	Wgn	1003-12V, Tail Light.....ea.	1.50
32-39	PU	67-12V, Park Light.....ea.	1.50
32-42	PU	1003-12V, Tail Light.....ea.	1.50
32-42	PU	67-12V, Tail Light.....ea.	1.50
40-41	PU	1895-12V, Park Light.....ea.	1.50
42-47	PU	67-12V, Park Light.....ea.	1.50
47-48	PU	1157-12V, Tail Light (offset studs).....ea.	1.50
47-48	PU	1157-NA-12V, Amber Tail Light (offset studs).....ea.	2.50

6 Volt Exterior Bulbs

All	Pass & PU	82-6V, Double Contact, (inline studs) Same Size as #63-6V.....ea.	2.25
32	Pass	63-6V, Tail Light.....ea.	1.75
32	Pass	1129-6V, Tail Light.....ea.	1.50
32-36	Pass	63-6V, Park Light.....ea.	1.75
33-37	Pass	1158-6V, Tail Light (inline studs).....ea.	3.00

33-48	Pass	1154-6V, Tail Light (offset studs).....ea.	2.00
37-40	Pass	55-6V, Park Light.....ea.	1.50
38-56	Pass	63-6V, License Plate.....ea.	1.75
42-51	Pass	1129-6V, Tail Light.....ea.	1.50
47-48	Pass	63-6V, Park Light.....ea.	1.75
49-56	Pass	1154-6V, Parking Light w/turn signals (offset studs).....ea.	2.00
49-56	Pass	1154-6V, TailLight (offset studs).....ea.	2.00
55	Pass	1129-6V, B/U Light.....ea.	1.50
32-42	Wgn	63-6V, Tail Light.....ea.	1.75
32-42	Wgn	1129-6V, Tail Light.....ea.	1.50
32-39	PU	63-6V, Park Light.....ea.	1.75
32-42	PU	1129-6V, Tail Light.....ea.	1.50
32-42	PU	63-6V, Tail Light.....ea.	1.75
42-47	PU	63-6V, Park Light.....ea.	1.75
47-48	PU	1154-6V, Tail Light (offset studs).....ea.	2.00

12 Volt Interior Bulbs

We carry a wide variety of light bulbs in 6 and 12 volt. 1932-55 cars and pickups were originally 6 volt, 1956 to present are 12 volt. If you do not find a listing for your application look at your old bulb for the number.

32-39	Pass	67-12V, Instrument Light.....ea.	1.50
32-53	Pass	67-12V, Dome Light.....ea.	1.50
38-51	Pass	53-12V, High Beam Indicator.....ea.	1.50
38-56	Pass	1895-12V, Clock Light.....ea.	1.50
40	Pass	53-12V, Instrument Panel.....ea.	1.50
40-48	Pass	67-12V, Luggage.....ea.	1.50
41	Pass	53-12V, Ignition Light.....ea.	1.50
41-48	Pass	1895-12V, Instrument Panel.....ea.	1.50
46-56	Pass	1895-12V, Radio.....ea.	1.50
49-51	Pass	53-12V, Cigar Lighter.....ea.	1.50
49-51	Pass	53-12V, Heater Control Panel.....ea.	1.50
49-55	Pass	53-12V, Turn Signal Indicator.....ea.	1.50
49-56	Pass	1895-12V, Glove Box Light.....ea.	1.50
49-56	Pass	1895-12V, Ignition Switch.....ea.	1.50
49-56	Pass	1895-12V, Speedometer Dial.....ea.	1.50
49-56	Pass	1895-12V, Instrument Panel.....ea.	1.50
49-56	Pass	1895-12V, Wiper Control.....ea.	1.50
50-56	Pass	67-12V, Courtesy Light.....ea.	1.50
52-56	Pass	1895-12V, Heater Control Panel.....ea.	1.50
52-56	Pass	1895-12V, High Beam Indicator.....ea.	1.50
53-56	Pass	1895-12V, Park Brake Warning.....ea.	1.50
54-56	Pass	1895-12V, Generator & Oil Warning.....ea.	1.50
54-56	Pass	67-12V, Map Light.....ea.	1.50
55-56	Pass	1895-12V, A/C Control Panel.....ea.	1.50

55-56	Pass	1895-12V, Cigar Lighter.....ea.	1.50
55-56	Pass	1895-12V, Transmission Selector.....ea.	1.50
56	Pass	1003-12V, Dome Light.....ea.	1.50
56	Pass	1895-12V, Turn Signal Indicator.....ea.	1.50
32-39	PU	67-12V, Instrument Light.....ea.	1.50
38-47	PU	53-12V, High Beam Indicator.....ea.	1.50
40-47	PU	53-12V, Instrument Panel.....ea.	1.50

6 Volt Interior Bulbs

32-39	Pass	63-6V, Instrument Light.....ea.	1.75
32-53	Pass	63-6V, Dome Light.....ea.	1.75
33-34	Pass & PU	81-6V, Instrument Light.....ea.	1.65
38-51	Pass	51-6V, High Beam Indicator.....ea.	1.50
38-56	Pass	55-6V, Clock Light.....ea.	1.50
40	Pass	51-6V, Instrument Panel.....ea.	1.50
40-48	Pass	63-6V, Luggage.....ea.	1.75
41	Pass	51-6V, Ignition Light.....ea.	1.50
41-48	Pass	55-6V, Instrument Panel.....ea.	1.50
46-56	Pass	55-6V, Radio.....ea.	1.50
49-51	Pass	51-6V, Cigar Lighter.....ea.	1.50
49-51	Pass	51-6V, Heater Control Panel.....ea.	1.50
49-55	Pass	51-6V, Turn Signal Indicator.....ea.	1.50
49-56	Pass	55-6V, Glove Box Light.....ea.	1.50
49-56	Pass	55-6V, Ignition Switch.....ea.	1.50
49-56	Pass	55-6V, Speedometer Dial.....ea.	1.50
49-56	Pass	55-6V, Instrument Panel.....ea.	1.50
49-56	Pass	55-6V, Wiper Control.....ea.	1.50
50-56	Pass	63-6V, Courtesy Light.....ea.	1.75
52-56	Pass	55-6V, Heater Control Panel.....ea.	1.50
52-56	Pass	55-6V, High Beam Indicator.....ea.	1.50
53-56	Pass	55-6V, Park Brake Warning.....ea.	1.50
54-56	Pass	55-6V, Generator & Oil Warning.....ea.	1.50
54-56	Pass	63-6V, Map Light.....ea.	1.75
55-56	Pass	55-6V, A/C Control Panel.....ea.	1.50
55-56	Pass	55-6V, Cigar Lighter.....ea.	1.50
55-56	Pass	55-6V, Transmission Selector.....ea.	1.50
56	Pass	55-6V, Turn Signal Indicator.....ea.	1.50
56	Pass	1129-6V, Dome Light.....ea.	1.50
32-39	PU	63-6V, Instrument Light.....ea.	1.75
33-34	PU	81-6V, Instrument Light.....ea.	1.65
33-34	PU	81-6V, Instrument Light.....ea.	1.65
38-47	PU	51-6V, High Beam Indicator.....ea.	1.50
40-41	PU	55-6V, Park Light.....ea.	1.50
40-47	PU	51-6V, Instrument Panel.....ea.	1.50

**Section 23
License Plate**

LICENSE PLATE BRACKETS

Front License Plate Bracket



32	Pass	B-5034-B, black.....ea.	32.00
32	Pass	B-5034-SS, stainless.....ea.	35.00
33-36	Pass	40-5034-B, black.....ea.	30.00
33-36	Pass	40-5034-SS, stainless.....ea.	35.00
37-38	Pass	78-5034-B, black.....ea.	30.00
37-38	Pass	78-5034-SS, stainless.....ea.	35.00
39	Std Pass	78-5034-B, black.....ea.	30.00
39	Std Pass	78-5034-SS, stainless.....ea.	35.00
39	Dlx Pass	91A-5034-B, black.....ea.	30.00
39	Dlx Pass	91A-5034-SS, stainless.....ea.	35.00
40	Pass	91A-5034-B, black.....ea.	30.00
40	Pass	91A-5034-SS, stainless.....ea.	35.00
39-40	Merc	91A-5034-B, black.....ea.	30.00
39-40	Merc	91A-5034-SS, stainless.....ea.	35.00
32	PU	B-5034-B, black.....ea.	32.00
32	PU	B-5034-SS, stainless.....ea.	35.00
33-36	PU	40-5034-B, black.....ea.	30.00
33-36	PU	40-5034-SS, stainless.....ea.	35.00
37-39	PU	78-5034-B, black.....ea.	30.00
37-39	PU	78-5034-SS, stainless.....ea.	35.00
40-41	PU	91A-5034-B, black.....ea.	30.00
40-41	PU	91A-5034-SS, stainless.....ea.	35.00

Rear License Plate Bracket

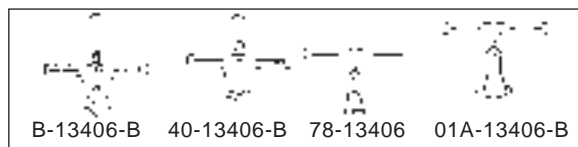

32	Pass	B-13406-B, black.....ea.	30.00
32	Pass	B-13406-SS, stainless.....ea.	35.00
33-36	Pass	40-13406-B, black.....ea.	30.00
33-36	Pass	40-13406-SS, stainless.....ea.	35.00
37	Pass	78-13406, black.....ea.	22.00
38-48	Pass	01A-13406-B, black.....ea.	30.00
38-48	Pass	01A-13406-SS, stainless.....ea.	25.00
28-48	Wgn	A-13406-B, black.....ea.	15.00
28-48	Wgn	A-13406-SS, stainless.....ea.	20.00
39-48	Merc	01A-13406-B, black.....ea.	30.00
39-48	Merc	01A-13406-SS, stainless.....ea.	25.00
28-56	PU	A-13406-B, black.....ea.	15.00
28-56	PU	A-13406-SS, stainless.....ea.	20.00



License Plate Bracket to Trunk Pad

38-48	Pass	81A-13446.....ea.	2.00
39-48	Merc	81A-13446.....ea.	2.00

LICENSE PLATE LIGHT

License Plate Lamp Assembly



49-50	Pass	8A-13550-A, except wagon.....ea.	30.00
51	Pass	1A-13550-A, except wagon.....ea.	30.00
52-54	Pass	FAA-13550-A, except wagon.....ea.	30.00
55-56	Pass	B5A-13550-A, except wagon.....ea.	30.00
55-56	Merc	B5A-13550-A, except wagon.....ea.	30.00

License Plate Light Body and Socket



52-56	Pass	FAA-13560-A, housing & socket only.....ea.	15.00
52-56	Merc	FAA-13560-A, housing & socket only.....ea.	15.00

Universal License Plate Light & Bracket Assembly

Polished Stainless Steel.



HR-13550, 12V.....kit.	50.00
HR-13550, 12V.....kit.	50.00

License Plate Light Lens



32	Pass	B-13445.....ea.	3.75
33-36	Pass	40-13445.....ea.	5.00
40-48	Pass	99A-13564.....ea.	7.00

49-51	Pass	7RA-13564.....ea.	10.00
52-58	Pass	C1TB-13564-A.....ea.	10.00
32-42	Wgn	B-13445.....ea.	3.75
46-51	Wgn	40-13445.....ea.	5.00
39-48	Merc	99A-13564.....ea.	7.00
32-42	PU	B-13445.....ea.	3.75
46-52	PU	40-13445.....ea.	5.00
55-UP	PU	B5C-13564-B, shield type.....ea.	4.00

License Plate Light Lens Bezel

49-51	Pass	7RA-13566.....ea.	15.00
-------	------	-------------------	-------

License Plate Light Lens Retainer

55-56	Pass	B5A-13423-A.....ea.	8.00
-------	------	---------------------	------

License Plate Light Lens Gasket

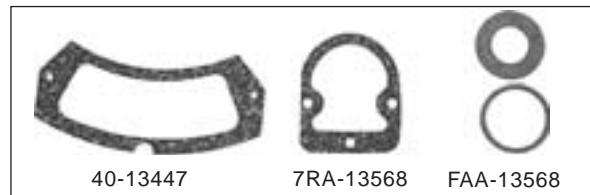

32	Pass	B-13447.....ea.	1.25
33-36	Pass	40-13447.....ea.	2.00
37	Pass	78-13447.....ea.	2.00
38-39	Pass	81A-13568.....ea.	1.50
40	Pass	01A-13568/9.....set.	2.00
41-48	Pass	11A-13568/9.....set.	2.00
49-51	Pass	7RA-13568.....ea.	2.00
52-56	Pass	FAA-13568.....set.	2.00
32-42	Wgn	B-13447.....ea.	1.25
46-51	Wgn	40-13447.....ea.	2.00
39-40	Merc	01A-13568/9.....set.	2.00
41-48	Merc	11A-13568/9.....set.	2.00
49-51	Merc	7RA-13568.....ea.	2.00
32-42	PU	B-13447.....ea.	1.25
46-52	PU	40-13447.....ea.	2.00
55-UP	PU	B5C-13447.....ea.	2.50
48-56	Panel	7RA-13568.....ea.	2.00

License Plate Light Screws

52-56	Pass	31061-S, exc. wgn.....kit.	3.00
-------	------	----------------------------	------

License Plate Bracket to Trunk Lid Pads

49-51	Pass	8A-5039-S.....pr.	2.00
-------	------	-------------------	------

License Plate to Trunk Lid Bumper

49-51	Pass	8A-8167-A.....ea.	2.00
-------	------	-------------------	------

License Plate Wire to Trunk Grommet

51	Pass	1A-13413.....ea.	1.00
----	------	------------------	------

License Plate Light to Tailgate Pad



55-56 Wagon B5A-13572-Bea. 15.00

LICENSE PLATE FRAMES

License Plate Frame 'Early V8'

Year & "Early V-8 Ford" on 1932-1948. Year and "Ford" on 1949-1954



32	Pass & PU	B-13409-S.....ea.	8.50
33	Pass & PU	18-13409-Sea.	8.50
34	Pass & PU	40-13409-Sea.	8.50
35	Pass & PU	48-13409-Sea.	8.50
36	Pass & PU	68-13409-Sea.	8.50
37	Pass & PU	78-13409-Sea.	8.50
38	Pass & PU	81A-13409-Sea.	8.50
39	Pass & PU	91A-13409-Sea.	8.50
40	Pass & PU	01A-13409-Sea.	8.50
41	Pass & PU	11A-13409-Sea.	8.50
42	Pass & PU	21A-13409-Sea.	8.50
46	Pass & PU	51A-13409-AS.....ea.	8.50
47	Pass & PU	51A-13409-BS.....ea.	8.50
48	Pass & PU	51A-13409-CS.....ea.	8.50



49	Pass & PU	8BA-13409-AFea.	8.50
50	Pass & PU	8BA-13409-BFea.	8.50
51	Pass & PU	8BA-13409-CFea.	8.50
52	Pass & PU	8BA-13409-52Fea.	8.50
53	Pass & PU	8BA-13409-53Fea.	8.50
54	Pass & PU	8BA-13409-54Fea.	8.50

License Plate Frame 'Classic'

Year and "Classic"



49	Pass	8BA-13409-Aea.	12.00
50	Pass	8BA-13409-Bea.	12.00
51	Pass	8BA-13409-Cea.	12.00

52	Pass	8BA-13409-52ea.	12.00
53	Pass	8BA-13409-53ea.	12.00
54	Pass	F-13409-54ea.	12.00
55	Pass	F-13409-55ea.	12.00
56	Pass	F-13409-56ea.	12.00

License Plate Frame "Pickup"

Year & "Pickup"



32	PU	B-13409-BS.....ea.	12.00
33	PU	18-13409-BS.....ea.	12.00
34	PU	46-13409ea.	12.00
35	PU	50-13409-BS.....ea.	12.00
36	PU	67-13409-BS.....ea.	12.00
37	PU	77-13409-BS.....ea.	12.00
38	PU	81C-13409-BSea.	12.00
39	PU	91C-13409-BSea.	12.00
40	PU	01C-13409-BSea.	12.00
41	PU	11C-13409-BSea.	12.00
42	PU	21C-13409-BSea.	12.00
46	PU	51C-13409-BSea.	12.00
47	PU	51C-13409-CSea.	12.00
48	PU	7C-13409-Aea.	15.00
49	PU	7C-13409-Bea.	15.00
50	PU	7C-13409-Cea.	15.00
51	PU	7C-13409-Dea.	15.00
52	PU	7C-13409-Eea.	15.00
53	PU	BAAA-13409.....ea.	15.00
54	PU	B4C-13409.....ea.	15.00



55	PU	B5C-13409.....ea.	15.00
56	PU	B6C-13409.....ea.	15.00

Universal Stainless License Plate Frame

Fits modern plates. Includes mounting hardware.

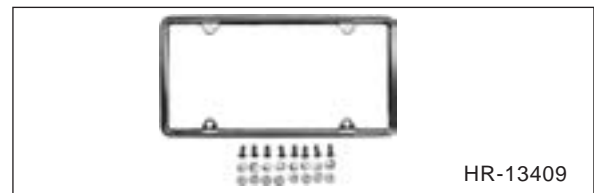

All	Pass & PU	HR-13409.....pr.	40.00
-----	-----------	------------------	-------



Early California Style License Plate Frame

Dimensions are 14 in.X 6 in., holes are 7 3/4 in. X 5 1/8 in. center to center.



- 28-39 Pass & PU B-13409-C, w/square corners.....ea. 16.00
- 40-55 Pass & PU 11A-13409-C, w/rounded cornersea. 16.00

Glass Dot License Plate Bolts

These are limited to what we have on hand.



- All Pass & PU BD-13409-A, amberpr. 12.50
- All Pass & PU BD-13409, dark blue.....pr. 12.50
- All Pass & PU BD-13409-G, green.....pr. 12.50
- All Pass & PU BD-13409-I, iridescentpr. 12.50
- All Pass & PU BD-13409-LB, light bluepr. 12.50
- All Pass & PU BD-13409-R, red.....pr. 12.50
- All Pass & PU BD-13409-P, purplepr. 12.50
- All Pass & PU BD-13409-W, whitepr. 12.50

Chrome Bullet Licence Plate Bolts

- All ACC-10889, set of 4set. 5.00

Lighted Bullet Style Licence Plate Bolts

Chrome base with plastic bullet tip. 12 volt only.

- All ACC-10868, amberpr. 6.50
- All ACC-10869, bluepr. 6.50
- All ACC-10870, greenpr. 6.50
- All ACC-10871, purple.....pr. 6.50

License Plate to Bracket Bolts

Includes special nuts, bolts must be replaced with longer ones.

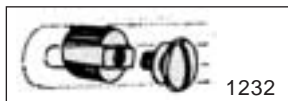

- 32-56 Pass & PU 1232, stainless.....set. 5.00

**Section 24
Horn**

HORNS/PARTS

Horn Assembly

Must be used with horn relay.



- 33-34 Pass 40-13802-AL, LH, 6Vea. 149.95
- 33-34 Pass 40-13802-AR, RH, 6Vea. 149.95
- 33-34 Pass 40-13802-BL, LH, 12Vea. 149.95
- 33-34 Pass 40-13802-BR, RH, 12V.....ea. 149.95
- 35 Pass 48-13802-AL, LH, 6Vea. 149.95
- 35 Pass 48-13802-AR, RH, 6Vea. 149.95
- 35 Pass 48-13802-BL, LH, 12Vea. 149.95
- 35 Pass 48-13802-BR, RH, 12V.....ea. 149.95
- 35-37 PU 48-13802-AL, LH, 6Vea. 149.95
- 35-37 PU 48-13802-AR, RH, 6Vea. 149.95
- 35-37 PU 48-13802-BL, LH, 12Vea. 149.95
- 35-37 PU 48-13802-BR, RH, 12V.....ea. 149.95

Ooogha Horn

12 Volt universal mount. Requires horn relay.

- All Pass & PU U-13803-12Vea. 40.00

Horn Relay



- 39-55 Pass 7RA-13853, 6V, correct for 47-55.....ea. 20.50
- 56 Pass B6A-13853, 12Vea. 22.50
- 39-55 Merc 7RA-13853, 6V, correct for 47-55.....ea. 20.50
- 56 Merc B6A-13853, 12Vea. 22.50
- 48-55 PU 7RA-13853, 6Vea. 20.50
- 56 PU B6A-13853, 12Vea. 22.50

12 Volt Universal Horn



All	Pass & PU	F4AZ-13832-A, high pitch.....ea.	22.00
All	Pass & PU	F4AZ-13833-A, low pitch.....ea.	22.00

Horn Turn Signal Conversion Kit

Kit mounts a small light behind horn screen and includes bulbs and sockets.

33-35	Pass & PU	40-13200-Tkit.	30.00
-------	-----------	----------------------	-------

Horn Bell Covers



33-35	Pass	40-13809-LH, LH.....ea.	16.00
33-35	Pass	40-13809-RH, RH.....ea.	16.00
35-37	PU	40-13809-LH, LH.....ea.	16.00
35-37	PU	40-13809-RH, RH.....ea.	16.00

Chrome Horn Projector



35	Pass	48-13810.....ea.	70.00
35-37	PU	48-13810.....ea.	70.00

Stainless Horn Projector Screen

33-34	Pass	40-13840.....ea.	3.95
35	Pass	48-13840.....ea.	3.95
33-37	PU	48-13840.....ea.	3.95

Horn Grille Turn Signal Kit

Mounts inside fender behind horn grille. Includes 12 volt amber lenses with rubber boot. Must have good tabs on horn grilles to mount. Horn grilles and pads sold seperately.

36	Pass	68-16156-BTea.	80.00
----	------	----------------------	-------

Chrome Horn Grille Cover



36	Pass	68-16156-A.....ea.	25.00
----	------	--------------------	-------

Horn Grille to Fender Pad



36	Pass	68-16156pr.	10.00
----	------	-------------------	-------

Horn Mounting Bracket

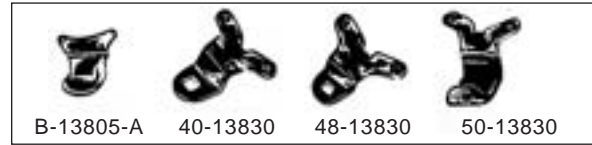

32	Pass	B-13805-A, OOGA type.....ea.	16.00
33-34	Pass	40-13830, RH.....ea.	35.00
33-34	Pass	40-13831, LH.....ea.	35.00
35	Pass	48-13830, RH.....ea.	35.00
35	Pass	48-13831, LH.....ea.	35.00
36	Pass	68-13830, RH.....ea.	35.00
36	Pass	68-13831, LH.....ea.	35.00
32	PU	B-13805-A, OOGA type.....ea.	16.00
35-36	PU	50-13830, RH.....ea.	35.00
35-36	PU	50-13831, LH.....ea.	35.00

Horn Mounting Bracket Repair Kit

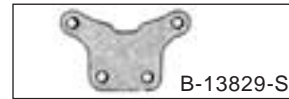

32-40	Pass & PU	B-13829-Skit.	12.95
-------	-----------	---------------------	-------

Horn Bolt Kit

One kit required per horn.

28-32	Pass	1134-B.....kit.	2.00
28-34	PU	1134-B.....kit.	2.00

Trumpet Horn Grommets



39-47	Pass	91A-13912pr.	6.00
39-47	Merc	91A-13912pr.	6.00

“Just wanted you folks to know, your guy Kyle Allen sure was nice and helpful when I called to order parts. Very refreshing to be treated so kindly. I'll be calling again. Nice web site, too!”

Regards,
Yvonne P



Section 25 Wiring

All of the wiring is USA made like original with correct color codes and gauge of wiring. The male bullet end are tin plated brass. All wiring is braided cloth over modern wiring unless otherwise noted. Most wires come with an easy to read diagram.

HEADLIGHT BUCKET

Headlight Reflector Wires

32	Pass	B-13076, import, two bulb sockets.....ea.	18.00
33-34	Pass	46-13076-NS, without sockets.....ea.	11.76
35-36	Pass	48-13076-NS, without sockets.....ea.	12.36
35-36	Pass	48-13076-OR, with sockets.....ea.	21.00
37-39	Pass	78-13076, original sockets.....ea.	16.00
37-39	Pass	91A-13076, w/parking lamp socket, w/o headlight socket.....ea.	18.22
39	Merc	78-13076, original sockets.....ea.	16.00
39	Merc	91A-13076, w/parking lamp socket, w/o headlight socket.....ea.	18.22
32	PU	B-13076, import, two bulb sockets.....ea.	18.00
33-34	PU	46-13076-NS, without sockets.....ea.	11.76
35-39	PU	48-13076-NS, without sockets.....ea.	12.36
35-39	PU	48-13076-OR, with sockets.....ea.	21.00

Headlight Bucket Wires



40	Pass	01A-13076.....ea.	22.96
41-48	Pass	11A-13076.....ea.	18.16
49	Pass	51C-13076B.....ea.	18.54
50-51	Pass	0A-13076.....ea.	19.40
52-54	Pass	2C-13076-A.....ea.	19.30
55-56	Pass	B5A-13076A, pvc, w/grommet.....ea.	26.36
55-56	Pass	B5A-13076A/M, pvc, molded ends w/grmt.....ea.	29.84
40	Merc	01A-13076.....ea.	22.96
41	Merc	11A-13076.....ea.	18.16
42-48	Merc	29A-13076-L, 40" long.....ea.	34.08
49-50	Merc	51A-13076B, w/grommet.....ea.	31.24
51	Merc	1M-13076A, w/grommet.....ea.	31.24
52-53	Merc	FAA-13076-A.....ea.	18.02
54	Merc	FDL-13076A.....ea.	34.18

55	Merc	B5A-13076A, pvc, w/grommet.....ea.	26.36
55	Merc	B5A-13076A/M, pvc, molded ends w/grmt.....ea.	29.84
56	Merc	FDU-13076A, pvc molded ends, w/grmt.....ea.	35.92
55	T-Bird	B5S-13076A, w/grommet.....ea.	35.30
56	T-Bird	B5S-13076A/M, pvc, molded ends, w/grmt.....ea.	35.92
57	T-Bird	B7S-13076A, RH, pvc, w/grommet.....ea.	31.90
57	T-Bird	B7S-13077A, LH, pvc, w/grommet.....ea.	28.10
40-41	PU	01A-13076.....ea.	22.96
40-41	Truck	01T-13076.....ea.	30.64
40-47	C.O.E.	01T-13076.....ea.	30.64
42-47	PU	11A-13076.....ea.	18.16
48-50	PU	51C-13076B.....ea.	18.54
51-52	PU	0A-13076.....ea.	19.40
53-54	PU	2C-13076-A.....ea.	19.30
55-56	PU	B5T-13076A.....ea.	19.42
55-56	PU	B5T-13076A/P, pvc.....ea.	19.42
55-56	PU	B5T-13076A/M, pvc, molded ends.....ea.	26.88

PARKING LIGHT

Parking Light Socket & Wiring



42-50	Pass	8A-13235-R, replacement.....ea.	6.50
42-50	Pass	21A-13235-R, w/signal.....ea.	5.00
49-50	Pass	0A-13234A, RH or LH, original type without signal.....ea.	20.00
49-50	Pass	0A-13234-B, RH or LH, original type with signal.....ea.	20.00
51	Pass	1A-13204A/L, LH, w/signal.....ea.	23.22
51	Pass	1A-13204A/R, RH, w/signal.....ea.	23.22



52	Pass	FAA-13206B/L, LH.....ea.	26.16
52	Pass	FAA-13206B/R, RH.....ea.	26.16
53	Pass	FAC-13203A/L, LH.....ea.	22.12
53	Pass	FAC-13203A/R, RH.....ea.	22.12
54	Pass	FAF-13206B/L, LH.....ea.	26.04
54	Pass	FAF-13206B/R, RH.....ea.	26.04
55	Pass	B5A-13206A/L, LH.....ea.	28.52
55	Pass	B5A-13206A/R, RH.....ea.	28.52
56	Pass	B6A-13206A/L, LH.....ea.	32.42

56	Pass	B6A-13206A/R, RH.....ea.	32.42
50	Merc	0M-13234B/L, LH.....ea.	24.56
50	Merc	0M-13234B/R, RH.....ea.	24.56
51	Merc	1M-13234A/L, LH.....ea.	25.68
51	Merc	1M-13234A/R, RH.....ea.	25.68
54	Merc	FAF-13234A/L, LH.....ea.	18.14
54	Merc	FAF-13234A/R, RH.....ea.	18.14
55	Merc	FDT-13234A/L, LH.....ea.	17.56
55	Merc	FDT-13234A/R, RH.....ea.	17.56
56	Merc	FDU-13234B/L, LH.....ea.	20.94
56	Merc	FDU-13234B/R, RH.....ea.	20.94
55	T-Bird	B5S-13206A/L, LH, pvc, w/signal.....ea.	38.42
55	T-Bird	B5S-13206A/R, RH, pvc, w/signal.....ea.	38.42
56	T-Bird	B6S-13206A/L, LH.....ea.	33.18
56	T-Bird	B6S-13206A/R, RH.....ea.	33.18
42-47	PU	8A-13235-R, replacement.....ea.	6.50
55-56	PU	B5C-13206A/L, LH, w/signal.....ea.	29.10
55-56	PU	B5C-13206A/R, RH, w/signal.....ea.	29.10

Parking Light Socket Wiring

41-48	Pass	21A-13234, w/o signal, 25".....ea.	7.92
49-50	Pass	0A-13234B/L, LH, w/signal, no socket.....ea.	18.76
49-50	Pass	0A-13234B/R, RH, w/signal, no socket.....ea.	18.76
49-50	Pass	8A-13234A, w/o signal.....ea.	5.02
46-48	Merc	59A-13234, w/o signal, 16".....ea.	7.82
52-53	Merc	FAA-13234B/R, RH.....ea.	18.10
52-53	Merc	FAA-13234B/L, LH.....ea.	18.10
42-47	PU	21A-13234, w/o signal, 25".....ea.	7.92
48-50	PU	7RC-13234, w/o signal, 8".....ea.	9.90
51-52	PU	1C-13234A, w/o signal, 30".....ea.	12.92

HEADLIGHT HARNESS/ X-OVER

Headlight Wiring Harness

Complete headlight wiring. On 1932-39 models, the bakelite headlight switch contact is included. 1932-36 models include the Tail Light wiring also.

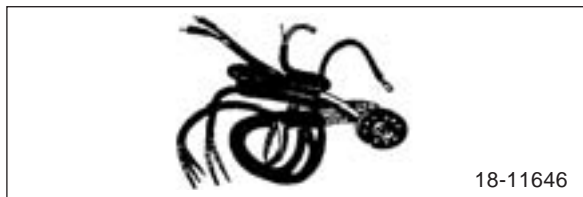

32	Pass	18-11646, w/cowl lamp.....ea.	99.64
32	Pass	18-11647, no cowl lamp.....ea.	90.94
33-34	Pass	40-11646, w/cowl lamp.....ea.	87.42
33-34	Pass	40-11647, no cowl lamp.....ea.	92.36
35	Pass	48-11647A, with hydrostatic fuel gauge.....ea.	98.48
35-36	Pass	48-11647, with electric fuel gauge.....ea.	98.48
37	Pass	78-11653.....ea.	64.54

38	Pass	81A-11647.....ea.	105.60
39	Std Pass	91A-11653A.....ea.	95.94
39	Dlx Pass	91A-11653B.....ea.	93.26
40	Pass	01A-11653A.....ea.	84.18
41	Pass	11A-11653.....ea.	90.86
42	Pass	51A-11653A, 6 cyl.....ea.	85.02
42-47	Pass	51A-11653A, V-8.....ea.	85.02
46	Pass	1GA-11653, 6 cyl.....ea.	87.44
46-47	Pass	5GA-11653B, 6 cyl.....ea.	86.76
47-48	Pass	51A-11653B, Late 47.....ea.	39.12
39	Merc	91A-11653B.....ea.	93.26
40	Merc	01A-11653A.....ea.	84.18
41	Merc	11A-11653.....ea.	90.86
42-48	Merc	29A-11653.....ea.	108.42
46-48	Merc	59A-11653B.....ea.	54.12
46-48	Merc	59A-11653B-TS, turn signals.....ea.	54.12
32	PU	18-11646, w/cowl lamp.....ea.	99.64
32	PU	18-11647, no cowl lamp.....ea.	90.94
33-34	PU	40-11646, w/cowl lamp.....ea.	87.42
33-34	PU	40-11647, no cowl lamp.....ea.	92.36
33-34	Big Truck	BB-11647B.....ea.	125.24
35	PU	48-11647A, with hydrostatic fuel gauge.....ea.	98.48
35-36	PU	48-11647, with electric fuel gauge.....ea.	98.48
35-36	Big Truck	51-11647A.....ea.	70.58
37	PU	77-11653B.....ea.	63.50
37	Big Truck	79-11653BA.....ea.	71.20
38	PU	81C-11647.....ea.	97.08
38	Big Truck	81T-11647.....ea.	133.32
39	PU	91C-11653.....ea.	91.08
39	Big Truck	91T-11653, exc. COE.....ea.	97.28
40-47	PU	01C-11653.....ea.	72.90
40-47	Big Truck	01T-11653, V8.....ea.	76.08
41-47	PU	5GC-11653, 6 cyl., exc. coe.....ea.	97.16

Headlight Crossover Wiring Harness



49	Pass	8A-11653, w/o signal.....ea.	52.60
50	Pass	0A-14445, w/horn, no signal.....ea.	30.00
51	Pass	1A-14445-A, no signal, no horn.....ea.	33.68
51	Pass	1A-14445B, w/ signal, no horn.....ea.	40.30
52	Pass	FAA-14445B, w/signal, no horn.....ea.	25.44
53	Pass	FAA-14445F, w/signal & horn.....ea.	42.72
54	Pass	FDA-14445B, w/signal & horn.....ea.	43.68



55	Pass	B5A-14445B, w/signal & horn.....ea.	49.92
55	Pass	B5A-14445-A, w/signal & long horn wires.....ea.	50.54
56	Pass	B6A-14445A, w/signal & horn.....ea.	54.74
49	Merc	8M-11653A, w/o signal.....ea.	45.42
49-50	Merc	0M-11653, w/signal.....ea.	35.76
51	Merc	1M-14445ea.	52.80
52-53	Merc	FAA-11653Aea.	24.30
54	Merc	FDC-14445A, w/signal & horn.....ea.	32.76
55	Merc	FDK-14445-A.....ea.	46.98
56	Merc	FDT-14445A, pvcea.	50.66
55	T-Bird	B5S-14445D, w/signal, pvc.....ea.	57.38
56	T-Bird	B6S-14445/MU, w/ signal, pvc.....ea.	67.96
57	T-Bird	B7S-14445A, w/ring terminalea.	29.40
57	T-Bird	B7S-14445B, w/push on terminal.....ea.	33.80
48-50	PU	7HC-11653ea.	21.22
51-52	PU	1C-11653Aea.	21.74
53-55	PU	B4C-11653A, w/ signal & horn.....ea.	29.30
53-55	PU	B4C-11653AB, w/o signal & horn.....ea.	20.70
55	PU	B4C-11653AB/P, pvc, w/o signal & horn.....ea.	22.74
55	PU	B4C-11653AC, no signal w/horn.....ea.	29.12
55	PU	B4C-11653A/P, pvc w/ signal & horn.....ea.	32.28
55	PU	B4C-11653A/PM, w/signal & horn.....ea.	32.88
55	PU	B4C-11653AC/P, no signal, w/horn, pvcea.	28.40
56	PU	B6C-11653A, w/signal.....ea.	28.40
56	PU	B6C-11653A/M, w/signal, molded endsea.	51.94

Headlight Dimmer Switch Wires

49-50	Pass	8A-14441ea.	16.20
-------	------	-------------------	-------

HORN MOTOR/RELAY

Horn Motor Wire

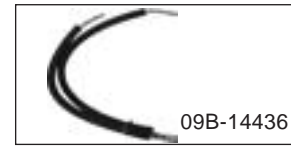

33-34	Pass	46-14436ea.	11.10
35	Pass	50-14436ea.	12.60
36-38	Pass	68-14436Aea.	7.24
39-47	Pass	09B-14436.....pr.	5.52
33-34	PU	46-14436ea.	11.10
35-37	PU	50-14436ea.	12.60
38-50	PU	68-14436Aea.	7.24

Left Horn to Headlight Harness Wire

50	Pass	0A-14440ea.	3.28
----	------	-------------------	------

Horn to Horn Wire

51	Pass	1A-14440ea.	4.46
51-52	PU	1C-14672Aea.	14.76
56	PU	B6C-14436.....ea.	7.74
56	PU	B6C-14436/M, molded ends.....ea.	8.40

Horn Relay to Headlight Harness Wire

41-47	Pass	11A-13842D, V-8.....ea.	8.40
46-47	Pass	11A-13842D, 6 cyl.ea.	8.40

Horn Relay to Horn Wire

52-54	Pass	FAA-14440/MUea.	13.86
52-53	Merc	FAC-14440Bea.	18.82
54	Merc	FDC-14440Aea.	16.40
51-52	PU	1C-14440Aea.	11.36
53-54	PU	FAF-14440A, V-8.....ea.	14.80
55	PU	B5C-14440/MU, V-8.....ea.	14.20
55	PU	B5C-14440/P, V-8, pvc.....ea.	13.84

Highway Horn Wire Kit

48-50	PU	8C-18700B.....ea.	27.60
-------	----	-------------------	-------

Starter Relay to Junction Block Wire



53-54	PU	FAA-14439Aea.	35.94
-------	----	---------------------	-------

HORN BUTTON

Horn Rod Repair Kit

28-39	Pass	A-3630-S.....kit.	6.50
28-39	PU	A-3630-S.....kit.	6.50

Horn Button Wire



40	Pass	01A-3671	ea.	3.64
40	Pass	01A-3671BW/RP, w/contact.....	ea.	30.00
41-48	Pass	11A-14308	ea.	5.52
49-50	Pass	8A-14308	ea.	5.66
51-54	Pass	1A-14308/WP, w/spring contact	ea.	9.66
55	Pass	B5A-14308A, w/spring contact	ea.	10.70
56	Pass	B6A-14308A, w/spring contact	ea.	12.34
41-48	Merc	11A-14308	ea.	5.52
55	T-Bird	B5S-14308	ea.	20.00
56-57	T-Bird	B6S-14308A	ea.	22.12
40-47	PU	01A-3671	ea.	3.64
40-47	PU	01A-3671BW/RP, w/contact.....	ea.	30.00
48-55	PU	FAB-14308-A	ea.	11.52
56	PU	B6C-14308B.....	ea.	13.48

SMALL ENGINE WIRES

Engine Compartment Light Wire

46-48	Pass	51A-15709	ea.	3.24
-------	------	-----------------	-----	------

Ignition Coil to Distributor Wire

32-34	Pass	B-14302, 4 cyl.	ea.	11.12
33-34	Pass	46-14302, 4 cyl.	ea.	12.92
41-47	Pass	2GA-14302, 6 cyl. "G"	ea.	5.50
42-48	Pass	21A-14302, V-8	ea.	6.22
47-51	Pass	7HA-14302, 6 cyl. "H"	ea.	3.26
49-53	Pass	7RA-14302, V-8.....	ea.	3.92
52-53	Pass	7RC-14302-B, 6 cyl.....	ea.	4.52
54	Pass	FDA-14302, V-8	ea.	3.10
55-56	Pass	FDL-14302A, V-8.....	ea.	3.58
42-48	Merc	21A-14302, V-8	ea.	6.22
49-53	Merc	7RA-14302, V-8.....	ea.	3.92
54	Merc	FDA-14302, V-8	ea.	3.10
55	T-Bird	FDL-14302A, V-8.....	ea.	3.58
56-57	T-Bird	FDV-14302A, V-8	ea.	5.40
32-34	PU	B-14302, 4 cyl.	ea.	11.12
33-34	PU	46-14302, 4 cyl.	ea.	12.92
41-47	PU	2GA-14302, 6 cyl. "G"	ea.	5.50
42-47	PU	21A-14302, V-8	ea.	6.22
47-51	PU	7HA-14302, 6 cyl. "H"	ea.	3.26
49-52	PU	7RA-14302, V-8.....	ea.	3.92
52-53	PU	7RC-14302-B, 6 cyl.....	ea.	4.52
53	PU	FDE-14302, V-8.....	ea.	4.16
54	PU	FDA-14302, V-8	ea.	3.10
55	PU	8EQ-14302, V-8.....	ea.	2.60

Ignition Coil to Dash Harness Wire

38	Pass	81A-14419, use with cutout	ea.	39.02
38	PU	81A-14419, use with cutout	ea.	39.02

Ignition Coil to Ignition Resistor Wire

56-57	Pass	FDR-14495A	ea.	4.30
56-57	T-Bird	FDR-14495A	ea.	4.30

Engine to Firewall Ground Wire

49-51	Pass	8A-14303	ea.	7.92
55-64	Pass	FDA-14303-A.....	ea.	5.32
55-56	T-Bird	14303AR.....	ea.	3.58
53-55	PU	FAD-14303A	ea.	4.16

Oil Sending Unit to Cowl Harness Wire

41-47	Pass	11A-14322, V-8, early 47	ea.	5.80
41-47	Pass	1GA-14322, 6 cyl. "G"	ea.	16.76
56	Pass	FEF-14322A	ea.	6.94
41-48	Merc	11A-14322, V-8	ea.	5.80
54-55	Merc	FDL-14322A	ea.	6.38
46-47	PU	11A-14322, V-8	ea.	5.80
48-50	PU	8RC-14322.....	ea.	4.72
53-55	PU	FAK-14380	ea.	2.64
55	PU	B5C-14322/MU, V-8.....	ea.	6.02
56	PU	FDV-14322A.....	ea.	7.24
55	Big Truck	FDK-14322A	ea.	3.20

Temperature Sender Crossover Wire

41-48	Pass	51A-14432, V-8, 15".....	ea.	5.32
46	Pass	1GA-14432/MU, 6 cyl.....	ea.	2.78
49-53	Pass	7RA-14432, V-8, 12"	ea.	5.42
51	Pass	0A-14432B	ea.	3.16
41-48	Merc	51A-14432, V-8, 15".....	ea.	5.32
49-53	Merc	7RA-14432, V-8, 12"	ea.	5.42
41-47	PU	51A-14432, V-8, 15".....	ea.	5.32
48-53	PU	7RA-14432, V-8, 12"	ea.	5.42

GENERATOR TO VOLT REGULATOR

Generator to Voltage Regulator Wire



41-47	Pass	11A-14305A, V-8, early 47	ea.	32.62
41-48	Pass	1GA-14305, 6 cyl.	ea.	46.46
54	Pass	FDB-14305A, V-8.....	ea.	21.60
55	Pass	B5A-14305E, 6 cyl.....	ea.	15.66
55	Pass	B5A-14305F, V-8, pvc.....	ea.	23.50
56	Pass	B6A-14305C, 6 cyl.....	ea.	15.86
56	Pass	B6A-14305C/M, 6 cyl., molded end	ea.	18.54
56	Pass	B6A-14305D, V-8	ea.	27.52
41-47	Merc	11A-14305A, V-8, early 47	ea.	32.62
54	Merc	FDC-14305A, V-8.....	ea.	50.00



55	Merc	FDK-14305A, pvc	ea.	25.88
56	Merc	B6A-14305B, pvc	ea.	36.32
57	T-Bird	B7S-14305A	ea.	24.62
53-54	PU	FAJ-14305A, 6 cyl.....	ea.	13.92
54	PU	FDE-14305A, V-8.....	ea.	16.14
54-55	PU	FDM-14305A, V-8, pvc.....	ea.	14.98

COWL LIGHT

Cowl Light Pigtail

30-34	Pass	B-13412-CL.....	ea.	2.04
-------	------	-----------------	-----	------

Cowl Light Crossover Wire

29-34	Pass	B-14426	ea.	13.92
-------	------	---------------	-----	-------

COWL TO ENGINE

Under Dash to Engine Wires (Cowl Harness)

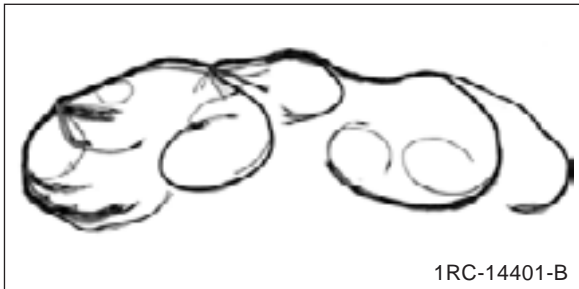

32	Pass	B-14401, 4 cyl.	ea.	61.12
32	Pass	18-14401, V-8	ea.	67.74
33-34	Pass	46-14401A, 4cyl, 2 terminal amp gauge.....	ea.	96.06
33-34	Pass	46-14401B, 4 cyl. amp gauge with loop	ea.	85.98
33-34	Pass	40-14401A, V-8, 2 terminal amp gauge.....	ea.	72.34
33-34	Pass	40-14401B, V-8, amp gauge with loop	ea.	71.20
35-36	Pass	68-14401	ea.	95.06
37	Pass	78-14401A	ea.	107.56
38	Pass	81A-14401B, with cutout, needs 81A-14419 coil wire	ea.	79.76
38	Pass	81A-14401C, with voltage regulator.....	ea.	169.90
39	Std Pass	91A-14401, with cutout.....	ea.	140.42
39	Std Pass	91A-14401C, with 3 brush generator, and amp gauge with loop.....	ea.	137.60
39	Dlx Pass	91A-14401D, with 2 brush generator, and volt gauge	ea.	137.62
40	Pass	01A-14401B	ea.	154.68
41	Pass	11A-14401	ea.	166.70
42-47	Pass	21A-14401, early 47, "on-off" switch, horns on inner fender panel.....	ea.	173.54
47-48	Pass	51A-14401A, late 47, V-8, horns in front of radiator, with out "on-off" lever.....	ea.	259.92
49	Pass	8BA-14401A, V-8	ea.	292.66
49	Pass	8HA-14401B/MU, 6 cyl.	ea.	271.20

50	Pass	0BA-14401A, V-8	ea.	280.34
50	Pass	0HA-14401A, 6 cyl.	ea.	265.20
51	Pass	1BA-14401A, V-8, without turn signals	ea.	360.24
51	Pass	1BA-14401E, V-8, with turn signals	ea.	370.60
51	Pass	1HA-14401E, 6 cyl., with turn signals	ea.	300.34
51	Wagon	1BA-14401F, V-8, with turn signals	ea.	419.04
52	Pass	FAA-14401D, V-8	ea.	316.68
52	Pass	FAB-14401D, 6 cyl.	ea.	312.26
53	Pass	FAG-14401H, V-8	ea.	309.42
53	Pass	FAH-14401H, 6 cyl.	ea.	312.86
54	Pass	FDB-14401, V-8	ea.	290.48
54	Pass	FDA-14401, 6 cyl.	ea.	305.54
55	Pass	B5A-14401H, V-8, molded ends.....	ea.	448.06
55	Pass	B5A-14401D, 6 cyl., molded ends.....	ea.	438.34
56	Pass	B6A-14401F, V-8, molded ends.....	ea.	589.84
56	Pass	B6A-14401C, 6 cyl., 60 amp generator, molded ends.....	ea.	596.40
56	Pass	B6A-14401E, 6 cyl., 40 amp generator, molded ends.....	ea.	574.16
39	Merc	99A-14401	ea.	205.44
40	Merc	09A-14401B, 1 dash light.....	ea.	217.78
40	Merc	09A-14401C, 2 dash lights.....	ea.	226.62
41	Merc	11A-14401	ea.	166.70
42-47	Merc	59A-14401A, early 47 use with 11A-14305A	ea.	226.04
47-48	Merc	59A-14401B, late 47, use with 59A-11653B.....	ea.	387.28
49	Merc	8M-14401B.....	ea.	444.32
50	Merc	0M-14401A	ea.	445.62
50	Merc Conv	0M-14401-B, with power seat & windows	ea.	552.60
51	Merc	1M-14401A, exc.conv	ea.	458.40
51	Merc Conv	1M-14401-B, with power seat & windows	ea.	565.66
52-53	Merc	FAW-14401A	ea.	495.50
54	Merc	FDC-14401A	ea.	452.70
55	Merc	FDK-14401C, pvc, molded ends.....	ea.	515.68
56	Merc	FDT-14401C, pvc, molded ends.....	ea.	526.30
55	T-Bird	B5S-14401A, , pvc, w/gen & oil lights.....	ea.	496.78
56	T-Bird	B6S-14401A, w/gen & oil lights, molded ends	ea.	576.84
57	T-Bird	B7S-14401A, w/gen & oil lights	ea.	672.70
32	PU	B-14401, 4 cyl.	ea.	61.12
32	PU	18-14401, V-8	ea.	67.74
33-34	PU	46-14401A, 4cyl, 2 terminal amp gauge	ea.	96.06
33-34	PU	46-14401B, 4 cyl. amp gauge with loop	ea.	85.98
33-34	PU	40-14401A, V-8, 2 terminal amp gauge	ea.	72.34

33-34	PU	40-14401B, V-8, amp gauge with loopea.	71.20
35-36	PU	68-14401ea.	95.06
37	PU	78-14401Aea.	107.56
38	PU	81A-14401B, with cutout, needs 81A-14419 coil wireea.	79.76
39	PU	91C-14401A, w/3 brush generator, with amp gaugeea.	150.82
39	PU	91C-14401B, w/2 brush generator & volt gaugeea.	113.84
39	PU	91C-14401C, w/2 brush generator & amp gaugeea.	169.90
40	PU	01C-14401Bea.	156.82
41-42	PU	1NC-14401-C, 4 cyl.ea.	211.74
41-44	PU	11C-14401B, V-8ea.	168.78
41-47	PU	1GC-14401, 6 cyl., G-seriesea.	236.36
44-47	PU	51C-14401A, 8 cyl.ea.	178.68
48-50	PU	8RC-14401D, V-8, ignition switch to right of light switchea.	263.84
48-50	PU	8HC-14401A, 6 cyl., ignition switch to left of light switchea.	252.08
48-50	PU	8HC-14401C, 6 cyl., ignition switch to right of light switchea.	236.00
51	PU	1HC-14401A, 6 cyl.ea.	305.60
51	PU	1RC-14401A, V-8, ignition switch to right of light switchea.	262.16
51	PU	1RC-14401B, V-8, ignition switch to left of light switchea.	264.30
52	PU	2RC-14401A, V-8ea.	264.84
52	PU	2QC-14401A, 6 cyl.ea.	268.16
53	PU	FAK-14401A, V-8, with out turn signalsea.	251.14
53	PU	FAL-14401A, 6 cyl., with out turn signalsea.	238.08
54	PU	FDE-14401AB, V-8 with gen & oil lightsea.	246.20
54	PU	FDE-14401AA, 6 cyl., with gen & oil lightsea.	282.52
54	PU	FDE-14401-AWS, 6 cyl., with turn signals, gen & oil lightsea.	407.92
54	Big Truck	B4T-14401-A, V8, with gauges, pvc wireea.	242.18
55	PU	B5C-14401F, V-8, molded endsea.	333.66
55	PU	B5C-14401E, 6 cyl., pvcea.	369.06
55	Truck	B5D-14401B, V-8, F250-F600, pvcea.	283.48
55	Big Truck	B5T-14401L, F700-Up, pvcea.	338.72
56	PU	B6C-14401D, V-8ea.	237.36
56	PU	B6C-14401D/M, V-8, molded endsea.	383.88
56	PU	B6C-14401G, 6 cyl., w/gen & oil lights, molded endsea.	401.04
56	PU	B6C-14401H, 6 cyl., w/gen & oil lights., no turn signals, molded endsea.	378.20
56	Big Truck	B6Q-14401D, V-8, full gaugesea.	405.84

SMALL DASH WIRES

Instrument Cluster Wires



49-50	Pass	8A-9272Bea.	6.30
52-53	Pass	FAB-9272Aea.	6.58
52-53	Merc	FAB-9272Cea.	25.34
54	Merc	FDC-9272Bea.	25.16

Headlight Switch Wires



40	Pass	01A-11652Kea.	12.44
41-47	Pass	11A-11652K, early 47ea.	16.20
41-47	Merc	11A-11652K, early 47ea.	16.20
40	PU	01C-11652ea.	17.36
41-47	PU	11A-11652Kea.	16.20

High Beam Socket and Wire



38-40	Pass	81A-13580ea.	30.00
39-40	Merc	81A-13580ea.	30.00
38-47	PU	81A-13580ea.	30.00

High Beam Socket Wire

38-40	Pass	81A-13580-Aea.	3.20
39-40	Merc	81A-13580-Aea.	3.20
38-47	PU	81A-13580-Aea.	3.20

Dash Light Socket Wires

33-34	Pass	40-13710ea.	6.98
35-39	Pass	48-13710ea.	13.06
56	Pass	B6A-14444ea.	5.25
39	Merc	99A-13710ea.	18.52
33-34	PU	40-13710ea.	6.98
35-39	PU	48-13710ea.	13.06

Accessory Hand Brake Harness

49-51	Pass	8M-185159Aea.	19.12
49-51	Merc	8M-185159Aea.	19.12

Clock & Lighter Dash Light Socket Wire

53	PU	FAK-13710ea.	15.40
----	----	--------------------	-------

Map Light Socket Wire

52-53	Merc	0A-13752ea.	14.38
55	T-Bird	B5S-13754A/LBea.	11.36
56-57	T-Bird	B6S-13754A/LBea.	12.90



Cigar Lighter to Circuit Breaker Wire

49-51	Pass	8A-15053	ea.	2.80
52-54	Pass	FAA-14429A	ea.	2.94
55-56	Pass	8A-15053	ea.	2.80
52-54	Merc	FAA-14429A	ea.	2.94
54	Merc	FDC-14347A	ea.	3.96
51-52	PU	1C-14347A	ea.	11.26
53-54	PU	FAB-14347A.....	ea.	3.70
55	PU	B5C-14347A.....	ea.	5.04

Instrument Panel Ground Jumper Wire

55-56	T-Bird	B5S-14590A, pvc	ea.	13.06
-------	--------	-----------------------	-----	-------

Clock Wire & Socket Assembly

37	Pass	78-15026	ea.	19.42
39-40	Pass	01A-15026	ea.	12.40
41	Pass	11A-15026, 1 socket, 1 fuse.....	ea.	50.04
42-48	Pass	21A-15026B, , 2 wires & 1 light socket	ea.	15.18
46-48	Pass	59A-15026B, 3 wire, 2 light sockets & 1 fuse holder ..	ea.	53.94
46-48	Pass	59A-15026A, 2 wire, 1 light socket, 1 fuse.....	ea.	44.48
49-50	Pass	8A-15026CS/MU, 2 light sockets	ea.	16.98
49-53	Pass	FAA-15026A, with stem clock 1 light socket	ea.	9.90
39	Merc	99A-15026	ea.	16.20
40	Merc	09A-15026	ea.	15.54
46-48	Merc	59A-15026A, 2 wire, 1 light socket, 1 fuse.....	ea.	44.48
46-48	Merc	59A-15026B, 3 wire, 2 light sockets & 1 fuse holder ..	ea.	53.94

Electric Clock Feed Wire



49-51	Pass	8A-15026E, with fuse holder	ea.	32.02
49-51	Pass	8A-15026-EWO, , without fuse holder.....	ea.	4.32
52-53	Pass	FAA-15026C, with fuse holder ...	ea.	26.20
54	Pass	FDA-15026B, with fuse holder ...	ea.	44.18
55	Pass	FDH-15026A, with fuse holder...ea.		38.52
56	Pass	B6A-15026A, with fuse holder ...ea.		22.40
49	Merc	FAD-15026A, with fuse holder ...ea.		38.34
50-51	Merc	8L-15026, with fuse holder	ea.	32.00
52-53	Merc	FAD-15026A, with fuse holder ...ea.		38.34
56-57	T-Bird	B6A-15026A, with fuse holder ...ea.		22.40

Radio Feed Wire



49-50	Pass	8A-18805W	ea.	6.94
-------	------	-----------------	-----	------

51	Pass	1A-18805W/MU	ea.	6.78
52-54	Pass	FAA-18805W	ea.	6.84
55-56	Pass	FDH-18805FH	ea.	20.80
51	Merc	1M-18805W	ea.	6.94
52-54	Merc	FAB-18805W	ea.	7.18
55-57	T-Bird	FEA-18805-FH	ea.	22.02
55-56	PU	B6C-18805W	ea.	8.54

Radio Dial Light Feed Wire

55	T-Bird	FEA-18805-DL	ea.	3.24
56-57	T-Bird	FEF-18805-DL	ea.	5.12

Glove Box Light Wire

54-55	Pass	FDA-18254	ea.	24.50
56	Pass	FDR-18254	ea.	23.60
46-48	Merc	59A-13712	ea.	17.18
56	Merc	FDT-14413A/LS	ea.	4.04

HEATER/AIR CONDITIONER

Heater Switch to Ignition Switch Wire

49-50	Pass	8M-14309A	ea.	4.10
49-50	Pass	0M-14309A, w/fuse holder	ea.	26.32
51	Pass	1A-14309C	ea.	37.00
51	Pass	1A-14309C/P, pvc	ea.	36.38
52-53	Pass	FAB-14309A, w/fuse holder.....	ea.	25.68
54	Pass	FDA-14309B	ea.	60.30
56	Pass	FDR-14338B	ea.	18.98
51-52	Panel	1C-14309B, 9"	ea.	3.00
51-52	Panel	1C-14309A, 30"	ea.	3.92
49-51	Merc	0M-14309A, w/fuse holder	ea.	26.32
52-53	Merc	FAB-14309B	ea.	25.16
54	Merc	FDA-14309B	ea.	60.30
56-57	T-Bird	B6S-14309B, w/fuse holder	ea.	22.56
48-50	PU	8C-14309B.....	ea.	25.02
51-52	PU	1C-14309A, 30"	ea.	3.92
51-52	PU	1C-14309B, 9"	ea.	3.00
55	PU	B5C-14309/MU	ea.	41.20

Heater Switch to Heater Motor Wire

39-40	Pass	91A-18457	ea.	23.64
41	Pass	11A-18457	ea.	23.64
42-46	Pass	21A-18457, early 46	ea.	21.74
46-48	Pass	51A-18457, late 46	ea.	24.60
49	Pass	8A-14309/MU, single-speed	ea.	6.86
49-54	Pass	B4AZ-18A627/MU	ea.	13.60
52-53	Pass	FAA-14309A	ea.	14.50
55	Pass	B5AZ-18A627/MU	ea.	13.36
56	Pass	FDR-14309A	ea.	20.16
39-40	Merc	91A-18457	ea.	23.64
41	Merc	11A-18457	ea.	23.64
42-46	Merc	21A-18457, early 46	ea.	21.74
46-48	Merc	51A-18457, late 46	ea.	24.60
50-51	Merc	0M-14309-D	ea.	16.52
55	Merc	FDK-14309B, pvc	ea.	13.96

55	T-Bird	FEA-14309A	ea.	13.32
55	T-Bird	FEA-14309A/P, pvc	ea.	13.66
56-57	T-Bird	FEA-14309A/M, pvc, molded ends	ea.	19.42
48-50	PU	8C-14309C	ea.	5.62
55	PU	B5C-18A627/MU	ea.	8.96
56	PU	B6C-14309-A	ea.	14.18

Heater Switch to Fuse Panel Wire

56	Merc	B6MY-188371A	ea.	22.78
----	------	--------------------	-----	-------

Heater Blower Motor Wire

55	T-Bird	FEA-18527W, early	ea.	11.06
55	T-Bird	B5S-18527W, late	ea.	10.76
56-57	T-Bird	FEF-18527W	ea.	14.82
48-50	PU	8C-18527B/RP	ea.	4.82

Heater Control Light Wire

51	Pass	1A-18541	ea.	10.58
55	Pass	B5A-18541A	ea.	12.76
51	Merc	1A-18541	ea.	10.58
51-52	PU	1C-18541	ea.	24.70

Heater Control Light Wire w/Socket

56	Merc	FDT-18541A	ea.	13.96
----	------	------------------	-----	-------

Air Conditioner Wire

56	Pass	FDR-19945A	ea.	99.26
----	------	------------------	-----	-------

WIPER

Wiper Switch to Circuit Breaker Wire

51-52	PU	8C-14326	ea.	3.16
-------	----	----------------	-----	------

Wiper Switch to Ignition Switch Wire

53	PU	FAA-14326B, pvc	ea.	3.70
55	PU	FDM-14326A, pvc	ea.	4.24

Wiper Switch to Wiper Motor Wire

51-52	PU	1C-17A490/MU	ea.	13.60
-------	----	--------------------	-----	-------

Windshield Washer Feed Wire w/Fuse

55	Merc	FDK-14297-A	ea.	42.12
----	------	-------------------	-----	-------

TURN SIGNAL

Turn Signal Switch Wires

Must solder wires to original switch.

51	Pass	1A-14486A	ea.	24.76
52-54	Pass	FAC-14486B	ea.	25.72
55	Pass	FDH-14486A	ea.	26.20
56	Pass	FDR-14486A	ea.	33.76
47-48	Merc	6M-14486	ea.	22.04
49-50	Merc	0L-14486	ea.	22.36
51-53	Merc	1M-14486A	ea.	23.98
55	T-Bird	B5S-14486A	ea.	25.44
56-57	T-Bird	B6S-14486A	ea.	37.34
53	PU	FDV-14486A, pvc	ea.	19.40

Turn Signal Wires for Original Add on Switch

These wires include flasher socket, in-line fuse, and dash indicator sockets.



42-50	Pass	0A-14492	ea.	51.30
48-50	PU	8C-14486A, 24"	ea.	77.58
48-50	PU	8C-14486B, 15"	ea.	78.66
51-52	PU	1C-14492A	ea.	47.46
51-52	Panel	1C-14492B	ea.	81.32

Turn Signal Flasher Wire

51	Pass	1A-14404A	ea.	36.58
53-54	Pass	FAB-14404A	ea.	51.80
56	Pass	FDR-14404A	ea.	58.76
42-48	Merc	59A-14404	ea.	38.36
50-51	Merc	0M-13348LB	ea.	15.16
53-54	PU	B4C-14404A	ea.	58.16
55	PU	B4C-14404A/P	ea.	58.12
56	PU	FDV-14404-B	ea.	60.18

Dash to Left Rear Turn Signal Wire

42-50	Pass	BA-14435A	ea.	29.84
56	Pass	FDR-14435A	ea.	36.88

Front Turn Signal Wire

42-54	Pass	0A-14499	ea.	29.78
48-52	PU	8C-14435A	ea.	27.64
53-54	PU	FAA-14435-A	ea.	35.14

Turn Signal Wire for Fender Mount Lights

48-52	PU	8C-18444/F, front	ea.	12.94
48-52	PU	8C-18444/R, rear	ea.	12.84

Front to Rear Turn Signal Wiring

For original Ford add-on switch. Connects to turn signal harness and goes to park lights and tail lights.

48-52	Panel	8C-14435B	ea.	76.40
-------	-------	-----------------	-----	-------

Turn Signal Extension Wire

42-48	Merc	6M-14557	ea.	27.82
51	Wagon	1A-14456A	ea.	3.06

Brake Light Switch to Turn Signal Switch Wire

42-48	Pass	6M-14684	ea.	22.44
42-48	Merc	6M-14684	ea.	22.44

OVERDRIVE

Columbia Overdrive Harness

41-48	Pass	11A-14382	ea.	34.88
41-48	Merc	11A-14382	ea.	34.88

Overdrive Wiring Harness

49-50	Pass	8M-14382, exc. conv	ea.	37.80
-------	------	---------------------------	-----	-------



51	Pass	1A-14382A, except wagon.....ea.	36.68
51	Wagon	1A-14382/MU.....ea.	45.94
52-53	Pass	FAA-14382A, 41".....ea.	28.02
52-54	Pass	FAC-14382A, 53".....ea.	31.36
55	Pass	B5A-14382-A, V-8.....ea.	30.76
56	Pass	B7A-14382A.....ea.	23.00
56	Pass	B7A-14382A/M, molded ends.....ea.	36.88
49-50	Merc	8M-14382, exc. conv.....ea.	37.80
51	Merc	1M-14382A.....ea.	38.50
52-53	Merc	FAA-14382A, 41".....ea.	28.02
55	T-Bird	B5S-14382A.....ea.	33.76
56-57	T-Bird	B6S-14382-A.....ea.	41.54
52-54	PU	FAC-14382A, 53".....ea.	31.36
56	PU	B6C-14382A.....ea.	29.52
56	PU	B6C-14382A/M, molded ends.....ea.	40.32

Overdrive Relay to Ignition Coil Wire

49-51	Pass	8M-14381.....ea.	4.52
52-54	Pass	FAA-14381A.....ea.	4.46
56	Pass	FDT-14381A, V-8.....ea.	6.40
56	Pass	FDR-14381A, 6 cyl.....ea.	7.06
49-51	Merc	8M-14381.....ea.	4.52

Ignition Switch to Overdrive Relay Wire

49-51	Pass	8M-14396.....ea.	4.78
52-54	Pass	FAA-14396A, V-8.....ea.	4.44
56	Pass	FDR-14396A.....ea.	5.84
49-51	Merc	8M-14396.....ea.	4.78
53	PU	FAC-14396A.....ea.	5.40

Overdrive Lockout Switch Wire

49-50	Pass	8M-6917W.....ea.	6.30
49-50	Merc	8M-6917W.....ea.	6.30

AUTO TRANSMISSION

Neutral Safety Switch Wire

51	Pass	1A-14476.....ea.	8.60
52-53	Pass	FAA-14476A.....ea.	7.44
56	Pass	FDR-14476A, pvc.....ea.	12.90
52-53	Merc	FAA-14476A.....ea.	7.44
54	Merc	1A-14476.....ea.	8.60
55	T-Bird	B5S-14476A, pvc.....ea.	22.14
56-57	T-Bird	FEF-14476A, pvc.....ea.	35.12
53	PU	FAC-14476A.....ea.	23.82
54	PU	FDE-14476A.....ea.	20.52
55	PU	FDE-14476A/P, pvc.....ea.	20.20

Gear Shift Indicator Light Wire

51	Pass	8L-14402.....ea.	12.96
51-54	Merc	8L-14402.....ea.	12.96

POWER WINDOW

Starter Solenoid to Window Solenoid Wire

52-54	Merc	FDC-14364A.....ea.	10.36
-------	------	--------------------	-------

Electric Window Motor Wire

54	Pass	FAA-14553/LM.....ea.	12.44
52-54	Merc	FAA-14553/LM.....ea.	12.44

Window Circuit Breaker to Ignition Switch

55	Pass	FDH-14626A.....ea.	5.40
----	------	--------------------	------

Electric Window Wire

54	Pass	FAB-14630B, front, RH.....ea.	78.76
54	Pass	FAB-14631B, LH.....ea.	76.76
55	Pass	B5A-14630-B, RH.....ea.	84.70
55	Pass	B5A-14631C, LH.....ea.	119.84
56	Pass	B6A-14630B, RH.....ea.	99.64
56	Pass	B6A-14631B, LH.....ea.	157.30
52-54	Merc	FAB-14630B, front, RH.....ea.	78.76
52-54	Merc	FAB-14631B, LH.....ea.	76.76
52-54	Merc 4D	FAB-14632B, RH, rear.....ea.	103.26
52-54	Merc 4D	FAB-14633B, LH, rear.....ea.	72.68
56	Merc	B6A-14630-C, RH.....ea.	104.72
56	Merc	B6A-14631-C, LH.....ea.	161.68
55	T-Bird	B5S-14630A, RH.....ea.	74.76
55	T-Bird	B5S-14631A, LH.....ea.	105.58
56	T-Bird	B6S-14630B, RH.....ea.	106.98
56	T-Bird	B6S-14631B, LH.....ea.	162.02
57	T-Bird	B7S-14630A, RH.....ea.	99.58
57	T-Bird	B7S-14631A, LH, w/manual seat.....ea.	85.84
57	T-Bird	B7S-14631B, LH, w/electric seat.....ea.	120.52

Electric Window Switch Wire

54	Pass	FAA-14639B, front.....ea.	14.70
54	Pass	FAB-14641A, rear.....ea.	13.44
56	Hardtop 2D	B6A-14529C/LS, RH, rear.....ea.	21.42
56	Hardtop 2D	B6A-14717A/LS, LH, rear.....ea.	21.42
56	Sdn 2D	B6A-14529C/LS, RH, rear.....ea.	21.42
56	Sdn 2D	B6A-14717A/LS, LH, rear.....ea.	21.42
56	Sdn 4D	B6A-14287A, LH, rear.....ea.	88.24
56	Conv	B6A-14529C/LS, RH, rear.....ea.	21.42
56	Conv	B6A-14717A/LS, LH, rear.....ea.	21.42
52-53	Merc	FAA-14639B, front.....ea.	14.70
52-53	Merc 4D	FAB-14641A, rear.....ea.	13.44
55	Merc	FDH-14631-D, LH front.....ea.	92.64

Electric Window Regulator Wire

46-48	Sportsman	51A-14339, rear.....ea.	139.08
56	Pass	B6A-14644A, RH, rear.....ea.	57.10
56	Pass	B6A-14702E, LH, rear.....ea.	52.92
55	Hardtop 2D	B5A-14644H, RH, rear.....ea.	68.94
55	Hardtop 2D	B5A-14702H, LH, rear.....ea.	64.70
49	Merc Conv	8L-14339-A, rear.....ea.	99.26

49-51	Merc	8M-14339-A, 165"	ea.	105.56
55	Merc	FEK-14644A, RH rear	ea.	73.64
55	Merc	FEK-14702A, LH rear	ea.	69.38
56	Merc	B7A-14632-A, RH, rear	ea.	102.12
56	Merc	B7A-14633-A, LH, rear	ea.	97.08

Front Electric Window Switch Wire

46-48	Sportsman	51A-13708	ea.	123.60
49	Merc Conv	8M-13708, with power seat and windows	ea.	113.86

Rear Electric Window Switch Wire

54	Hardtop 2D	FAA-14645B	ea.	20.22
52-53	Merc Cpe	FAA-14645B	ea.	20.22
52-53	Merc Conv	FAA-14645B	ea.	20.22

Window Motor Relay to Regulator Wire

56	Pass	B6A-14679A	ea.	21.28
52-53	Merc	FDA-14678A	ea.	15.18
56	T-Bird	B6S-14679A	ea.	33.78
57	T-Bird	B7S-14679A	ea.	35.88

Window Relay to Motor Wire

55	T-Bird	FEV-14663A, RH	ea.	15.32
----	--------	----------------------	-----	-------

Window Regulator Relay Wire

55	Pass	B5A-14705A	ea.	72.20
56	Pass	B6A-14705B, exc.2dr sedan,wgn, Sdn Dly	ea.	96.30
56	Merc	B7AZ-14A027-A	ea.	90.86

Window Regulator to Solenoid Wire

46-48	Sportsman	51A-14508-L, left front	ea.	7.78
46-48	Sportsman	51A-14508-R, right front	ea.	7.78

POWER SEAT

Electric Seat Motor Wire

55	T-Bird	B5S-14593A, horizontal reg	ea.	22.32
55	T-Bird	B5S-14593B, vertical reg	ea.	13.00
56-57	T-Bird	B6S-14593-A, horizontal reg	ea.	30.56
56-57	T-Bird	B6S-14593B, vertical reg	ea.	23.42

Electric Seat Motor Jumper Wire

53-54	Merc	FAA-14593A, 4-way seat, red	ea.	2.78
53-54	Merc	FAA-14593B, 4-way seat, yellow	ea.	2.78

Seat Circuit Breaker to Ignition Switch Wire

56	Merc	FDV-14626A	ea.	8.34
55	T-Bird	FEA-14626A	ea.	3.96

Seat Circuit Breaker to Circuit Breaker Wire

55	T-Bird	FEA-14628A	ea.	12.72
----	--------	------------------	-----	-------

Electric Seat Switch Wire

54	Pass	FAD-14642A	ea.	49.82
----	------	------------------	-----	-------

55	Pass	FDH-14642-A	ea.	58.54
56	Pass	B6A-14642-A	ea.	66.88
52-54	Merc	FAB-14642B	ea.	21.80
53-54	Merc	FAD-14642A	ea.	49.82
55	Merc	FDK-14642-A	ea.	64.96
56	Merc	FDT-14642-A	ea.	136.82

Electric Seat Regulator Relay Wire

54	Pass	FDA-14643A	ea.	22.42
55	Pass	B5A-14643-B	ea.	28.14
56	Pass	B6A-14643-A	ea.	27.20
52-54	Merc	FAB-14643B	ea.	13.80
56	Merc	B7A-14643A	ea.	30.22
55	T-Bird	B5S-14643A	ea.	54.60
56	T-Bird	B6S-14643A	ea.	82.84
57	T-Bird	B7S-14643A	ea.	67.38

Electric Seat Regulator Solenoid Wire

50-51	Merc	1M-14537-A	ea.	6.26
-------	------	------------------	-----	------

Electric Seat Relay Jumper Wire

52-54	Merc	FAD-14643A	ea.	3.62
-------	------	------------------	-----	------

Seat Circuit Breaker to Starter Solenoid Wire

55	Pass	FDH-14682A	ea.	14.26
55	T-Bird	FEA-14682A	ea.	7.58
56-57	T-Bird	FEF-14682A	ea.	9.24

Electric Seat Regulator Switch Wire

50-51	Merc	0M-14530	ea.	14.76
55	T-Bird	B5S-14689A	ea.	48.92
56	T-Bird	B6S-14689-A	ea.	59.54

Electric Seat Motor/Regulator Wire

55	Pass	B5A-14593-B, 2 req'd	ea.	17.78
55	Merc	FDR-14626-A, 2 req'd	ea.	7.26

DOME/COURTESY LIGHT

Dome Light Socket Wire



49-54	Pass	FAC-13796A	ea.	3.64
49-51	Wagon	8M-13777	ea.	5.66
54	Pass	FDA-13786A, w/socket	ea.	10.46
55	Pass	FAC-13796A/P	ea.	3.30
55-56	Pass	FDH-13796A	ea.	9.66
49-50	Merc	7EH-13796/LS, except wagon	ea.	9.14
49-51	Merc Wgn	8M-13777	ea.	5.66
52-53	Merc 2D Hdtp	FAB-14389A	ea.	4.76
55	T-Bird	FAC-13796A/P	ea.	3.30
53-55	PU	FAC-13796A	ea.	3.64

Dome Light Wire

54	Pass	FDA-14334B	ea.	22.04
55	Pass	B4A-14334C	ea.	18.30

Section 25 - Wiring



C&G Early Ford Parts, Inc.

56	Pass	B6A-14328-Aea.	29.30
56	Pass	B6A-14334A, except wagonea.	27.18
56	Wagon	FDR-14334Cea.	11.70
54	Merc	FDC-14328Aea.	65.98
55	Merc	FDK-14328Aea.	57.74
55	Montclair	FDK-14328-Bea.	75.20
56	Merc	FDT-14328Eea.	95.78

Dome Light to Dome Light Crossover Wire

50-51	Pass	0A-14335ea.	7.44
-------	------	----------	----------	------

Dome Light Switch to Cowl Wire

48-50	PU	8C-14318ea.	6.74
-------	----	----------	----------	------

Dome Light Switch to Fuse Block Wire

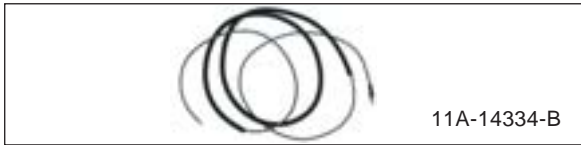

37-40	Pass	91A-14334Bea.	6.22
51	Hardtop 2D	1A-14318ea.	2.82
51	Conv	1A-14318ea.	2.82
53	Hardtop 2D	FAB-14318ea.	2.82
53	Conv	FAB-14318ea.	2.82
41-48	Merc	11A-14334B, exc. wagonea.	10.94

Dome Light Switch to Dome Light Wire

37-40	Pass	78-14335Bea.	10.46
41-48	Pass	11A-14335B, exc. wagonea.	7.24
41-48	Wagon	11A-14334Cea.	35.18
49	Pass	8A-13796A, except wagonea.	5.58
52-53	Pass	8A-13796A, except wagon, sedan delivery, & hardtopea.	5.58
41-48	Merc	11A-14335B, exc. wagonea.	7.24
41-48	Merc Wgn	11A-14334Cea.	35.18

Dome Light to Tail Light Harness Wire

51	Hardtop 2D	1A-13796, 2 req'dea.	5.06
52-53	Sdn Dly	FAA-14334Aea.	4.62
52-53	Merc 2D HdtpFAB-14334G	ea.	11.22
52-53	Merc 4D Sdn	FAB-14334Hea.	10.92
52-53	Merc 4D Sdn	FAB-14334Mea.	80.50
54	Merc	FDC-14334ea.	15.92
54-55	Merc 2D HdtpFDK-14334B	ea.	11.22

Door Jamb Switch to Tail Light Wire

50-51	Wagon	0A-14328Cea.	11.18
-------	-------	-----------	----------	-------

Door Jamb Switch to Courtesy Light Switch Wire

50-51	Pass	0A-14328A, exc. wgn, conv, hrtpea.	31.52
50	Conv	0A-14328B, with socketea.	52.14
51	Hardtop 2D	1A-14328W/O/S, w/o socketea.	34.88
51	Hardtop 2D	1A-14328W/S, w/socketea.	38.98
51	Conv	1A-14328W/O/S, w/o socketea.	34.88

51	Conv	1A-14328W/S, w/socketea.	38.98
52-53	Pass	FAA-14328Cea.	33.52
53	Hardtop 2D	FAB-14328B, w/socketea.	54.70
53	Conv	FAB-14328B, w/socketea.	54.70
54	Pass	FDA-14328A, except hardtop and convea.	42.58
54	Hardtop 2D	FDA-14328-Bea.	67.16
54	Conv	FDA-14328-Bea.	67.16
55	Conv	B5A-14328Aea.	26.68
55	Hardtop 2D	B5A-14328-Bea.	63.50
55	Conv	B5A-14328-Bea.	63.50
56	Conv	FDR-14328Bea.	67.18
56	Merc	FDT-14328Bea.	68.56

Door Jamb Switch Wire

51-52	PU	1C-14328Aea.	27.52
53-55	PU	B5C-14328A/MU, LHea.	9.90
53-55	PU	FAC-14328, RHea.	24.62
55	PU	B5C-14328A/P/M, LH, PVCea.	7.82
55	PU	FAC-14328/P, RH, PVCea.	12.92

Door Jamb Switch Wire to Dome Lamp Wire

51-52	PU	1C-14318Aea.	31.52
53-55	PU	B5C-14318ea.	28.20
55	PU	B5C-14318A/P, PVCea.	16.38
56	PU	B6C-14318ea.	44.52
56	PU	B6C-14318/M, w/molded endsea.	50.78

TAIL LIGHT SOCKET

Tail Light Socket & Wire



33-48	Pass	01C-13410ea.	8.46
46-48	Sportsman	51A-13410ea.	13.72
46-48	Wagon	01C-13410ea.	8.46
51	Pass	1A-13410ea.	5.66
49-51	Wagon	8A-13410Bea.	39.28
54	Pass	1A-13410ea.	5.66
42-48	Merc	29A-13410-LSea.	16.52
46-48	Merc Wgn	01C-13410ea.	8.46
49-51	Merc Wgn	8A-13410Bea.	39.28
57	T-Bird	FDR-13410Bea.	22.62
46-52	PU	01C-13410ea.	8.46
53-54	PU	FAD-13410Aea.	28.52
55	PU	FDM-13410-Aea.	28.20
56	PU	FDM-13410-Bea.	32.28

Tail Light Socket Wire

28-32	Pass	A-13410, 2-Socketea.	8.84
32-42	Wagon	A-13410, 2-Socketea.	8.84
49-50	Pass	FE8H-13410/LSea.	11.86

52-53	Pass	8M-13410A	ea.	8.24
55	Pass	FDH-13410A	ea.	13.98
56	Pass	FDR-13410A	ea.	13.98
41-42	Merc Wgn	A-13410, 2-Socket.....	ea.	8.84
49-51	Merc	8M-13410A, exc.Wgn.....	ea.	8.24
54-55	Merc	FDK-13410A/LS	ea.	9.24
56	Merc	FDU-13410A/LS	ea.	12.46
55	T-Bird	FDH-13410A	ea.	13.98
56	T-Bird	FDR-13410A	ea.	13.98
28-42	PU	A-13410, 2-Socket.....	ea.	8.84

TAIL LIGHT HARNESS

Tail Light Harness

This is also referred to as the body harness. 1932-40 Pass require a tail light crossover harness when using two tail lights. The 1941-56 Pass tail light harnesses include the crossover.

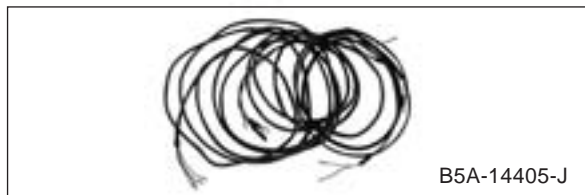

35-38	Pass	81A-14405	ea.	57.08
35-38	Pass	81A-14405FP, w/electric fuel pump.....	ea.	64.80
39-40	Pass	91A-14405, except sedan delivery	ea.	58.90
41-48	Pass	51A-14405A, except wagon and sedan delivery	ea.	76.92
42-48	Pass	59A-14405, with turn signal.....	ea.	145.06
41-48	Wagon	51A-14405B	ea.	113.94
49-50	Pass	0A-14405, except wagon and convertible	ea.	79.14
49-50	Conv	0BA-14405B.....	ea.	148.22
50	Wagon	8M-14405E, with one tail light ...	ea.	97.16
51	Pass	1A-14405A, except hardtop, convertible and wagon.....	ea.	101.70
51	Hardtop 2D	1A-14405D	ea.	146.76
51	Conv	1A-14405-B	ea.	168.80
51	Wagon	1A-14405H, with signals.....	ea.	170.50
52-53	Sdn 2D	FAB-14405A.....	ea.	171.20
52-53	Sdn 4D	FAB-14405B.....	ea.	148.02
52-54	Hardtop 2D	FAB-14405E	ea.	168.44
52-53	Conv	FAB-14405S	ea.	159.98
52-53	Sdn Dly	FAB-14405R	ea.	168.54
52-54	Wagon	FAB-14405-P	ea.	160.40
54	Sdn	FDA-14405G	ea.	141.26
54	Hardtop 2D	FDA-14405-J, with power windows.....	ea.	251.74
54	Conv	FAB-14405-AB, w/o power windows.....	ea.	211.78
54	Conv	FDA-14405-L, w/power windows	ea.	307.90
55	Pass	B5A-14405J.....	ea.	112.08
55	Pass	B5A-14405/BU, with backup lights	ea.	125.28

56	Pass	B6A-14405D, with backup lights, molded ends.....	ea.	141.88
56	Wagon	B6A-14405B, with backup lights	ea.	151.18
39-40	Merc	99A-14405	ea.	115.44
41-48	Merc	51A-14405A, except wagon, without turn signals	ea.	76.92
42-48	Merc	59A-14405, with turn signal.....	ea.	145.06
49	Merc Sdn	8M-14405-B	ea.	151.68
49	Merc Conv	8M-14405-C, with power seat & windows	ea.	206.20
49	Merc Wgn	8M-14405E, with one tail light ...	ea.	97.16
49	Merc Wgn	8M-14405G, with signals	ea.	143.70
50	Merc	0M-14405A, 6 pass coupe.....	ea.	138.06
50	Merc	0M-14405-B, sports sedan.....	ea.	154.38
50-51	Merc Conv	0M-14405-C, with power seats & windows.....	ea.	223.60
51	Merc	1M-14405B, sports sedan.....	ea.	155.66
52-53	Merc Cpe	FCV-14405A.....	ea.	196.94
52-53	Merc Cpe	FCV-14405B, with power windows	ea.	330.24
52-53	Merc 4D Sdn	FAC-14405B	ea.	160.66
52-53	Merc Conv	FAC-14405N, with power windows.....	ea.	336.14
54	Merc	FDC-14405S, with backup lights	ea.	211.26
54	Merc 2D HdtpFDA-14405Z 198.82	ea.	
54	Merc 2D HdtpFDC-14405-AA, with power windows	ea.	275.92
54	Merc Conv	FDC-14405G, with power windows	ea.	375.76
55	Merc 2D HdtpFDK-14405-L 197.24	ea.	
55	Merc Conv	FDK-14405-L	ea.	197.24
55	Merc Wgn	FDK-14405N	ea.	200.14
56	Merc 2D Sdn	FDT-14405-F	ea.	200.86
56	Merc 2D HdtpFDT-14405-F 200.86	ea.	
56	Merc 4D Sdn	FDT-14405-G.....	ea.	233.44
56	Merc 4D HdtpFDT-14405-G 233.44	ea.	
56	Merc Conv	FDT-14405-F	ea.	200.86
55	T-Bird	B5S-14405B, pvc.....	ea.	85.42
56	T-Bird	FEF-14405G, pvc	ea.	128.80
56	T-Bird	FEF-14405H, with backup lights	ea.	148.60
57	T-Bird	B7S-14405C, with automatic, pvc	ea.	135.32
57	T-Bird	B7S-14405D, with standard trans, pvc.....	ea.	145.78
33-34	Big Truck	79-14405	ea.	86.02
35-38	PU	81A-14405	ea.	57.08
35-38	PU	81A-14405FP, with electric fuel pump.....	ea.	64.80
39-40	PU	91A-14405	ea.	58.90
39-40	Big Truck	91T-14405, exc. coe.....	ea.	112.40
41	PU	11C-14405A	ea.	75.34
41-47	Big Truck	11T-14405, exc. coe.....	ea.	113.54
42-47	PU	21C-14405A	ea.	54.46
48-52	PU	8C-14405, F1	ea.	55.16
48-52	Truck	7RD-14405, F2, 3/4 ton.....	ea.	63.10



48-52	Truck	7RT-14405, F4-F6, 134" wheelbase.....ea.	83.82
48-52	Truck	7R4T-14405, F4-F7, 158" wheelbase.....ea.	87.42
53-55	PU	B5C-14405, with turn signal.....ea.	63.20
53-55	PU	B5C-14405/P, with turn signals, pvc.....ea.	53.60
56	PU	B6C-14405, w/signals.....ea.	45.14
56	PU	B6C-14405/M, with signals, molded ends.....ea.	69.68
56	Panel	B6C-14405B.....ea.	84.78

Stop Light Switch Wire

49-51	Pass	8A-14475.....ea.	14.98
55-56	Pass	B5A-14475A, w/power brakes.....ea.	12.50
49-51	Merc	8M-14475.....ea.	9.14

TAIL LIGHT X-OVER/EXTENSION

Tail Light Harness Extension Wire

53-55	PU	FAB-14423A, 6 cyl., 45".....ea.	8.42
55	PU	FAB-14423A/P, 6 cyl., pvc, 16".....ea.	7.44

Tail Light Crossover Wire

32-40	Pass	B-14424.....ea.	18.74
36	Conv Sdn	68-14424, w/trunk.....ea.	37.74
32-48	PU	B-14424.....ea.	18.74
48-52	PU	7RC-14424.....ea.	18.62
48-52	Panel	8C-14424.....ea.	44.98
53-55	PU	B5C-14424/CG, , with turn signals.....ea.	21.58
53-55	Panel	B5C-14424B.....ea.	27.76
56	PU	B6C-14424/CG, , with turn signals.....ea.	21.12
56	Panel	B6C-14424B.....ea.	32.20

LICENSE LIGHT/FUEL TANK

License Plate Light Wire

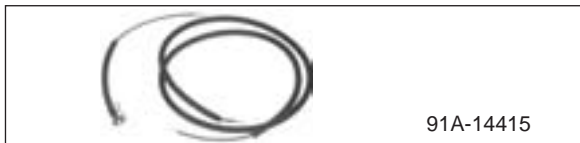

38-40	Pass	91A-14415.....ea.	11.24
41-48	Pass	11A-14415, 59".....ea.	14.12
41-48	Cpe	11A-14415-C, 53".....ea.	10.04
41-48	Sdn	11A-14415-B, 53".....ea.	10.04
41-48	Conv	11A-14415-C, 53".....ea.	10.04
46-48	Sportsman	91A-14415.....ea.	11.24
49	Pass	8A-14415.....ea.	5.32
50-51	Pass	0A-14415, exc. wgn.....ea.	5.40
52-54	Sdn Dly	FAA-14415B.....ea.	9.56
52-54	Wagon	FAB-14415B.....ea.	9.50
39-40	Merc	91A-14415.....ea.	11.24
41-48	Merc	11A-14415, 59".....ea.	14.12

50-51	Merc	0M-14415A.....ea.	12.34
52-53	Merc	FAB-14415A.....ea.	10.78
54-55	Merc	FAA-14415A.....ea.	10.56
56	T-Bird	B6S-14415-A.....ea.	10.00
48-52	Panel	8C-14415.....ea.	4.30
56	Panel	B6C-14415B.....ea.	10.48

License Plate Light Socket Wire

38-48	Pass	81A-13412.....ea.	3.26
49-50	Pass	7RA-13412.....ea.	11.24
52-54	Pass	FAA-13560A, exc. wgn.....ea.	12.02
52-54	Wagon	FAB-13560A.....ea.	20.80
52-54	Sdn Dly	FAB-13560A.....ea.	20.80
56	Sdn Dly	FDH-13412A.....ea.	25.40
39-48	Merc	81A-13412.....ea.	3.26
52-54	Merc	FAA-13560A, exc. wgn.....ea.	12.02
52-54	Merc Wgn	FAB-13560A.....ea.	20.80
56	Wagon	FDH-13412A.....ea.	25.40
55	T-Bird	B5S-13560A.....ea.	8.84
56	T-Bird	B6S-13560A/LB.....ea.	13.80
48-52	Panel	7RA-13412.....ea.	11.24

License Plate Light Extension Wire

50-51	Merc	0M-13549, 65".....ea.	11.96
-------	------	-----------------------	-------

Accessory Trunk Light Wire

For inside the trunk.

40-41	Pass	01A-13506.....ea.	8.90
42-48	Pass	11A-13506.....ea.	8.90
46-47	Sportsman	51A-13506.....ea.	5.18
51	Pass	1A-18256ALS.....ea.	18.02
51-55	Merc	1M-13506, exc. wgn.....ea.	18.24
56	Merc	FDT-13506A/LS, except wagon.....ea.	7.52

Trunk Light Extension Wire

46-48	Cpe	51A-14414-A, 61".....ea.	11.32
46-48	Conv	51A-14414-A, 61".....ea.	11.32
46-48	Sportsman	51A-14414-B, 67".....ea.	11.76

Fuel Tank Sending Unit Wire

49-50	Pass	8A-14406.....ea.	13.32
49-51	Wagon	7RA-14406.....ea.	12.14
51	Pass	1A-14406/MU.....ea.	4.84
52-53	Pass	FAB-14406B.....ea.	3.56
54	Pass	FDA-14406B.....ea.	3.76
52-53	Merc	FAB-14406B.....ea.	3.56
54	Merc	FDC-14406A.....ea.	4.62
39-47	Truck	81W-14406.....ea.	6.72
42-47	PU	81W-14406.....ea.	6.72
48-51	PU	7RC-14406A, 110".....ea.	9.54
48-52	PU	7RC-14406D, 51".....ea.	4.84
48-52	Panel	7RC-14406D, 51".....ea.	4.84
48-52	Panel	7RC-14406E, 88".....ea.	14.98
56	PU	FDV-14406-A, 110".....ea.	11.92

Fuel Tank Ground Wire

48-52	Panel	7R4T-14176.....ea.	3.10
56	PU	FDV-14176A.....ea.	2.66

BACK UP LIGHT

Back Up Light Wire with Socket



49-51	Pass	8A-18274, RH	ea.	18.70
49-51	Pass	8A-18275, LH.....	ea.	29.58
55-56	Pass	B5A-15536-R	ea.	6.50
55-56	T-Bird	B5A-15536-R	ea.	6.50

Back Up Light Switch to Light Wire

42-48	Pass	51A-15506	ea.	9.24
52-54	Pass	FAB-15506A, w/std.....	ea.	19.76
52-54	Pass	FAB-15506B, w/auto	ea.	19.76
51	Merc	1H-15506A	ea.	15.98

Back Up Light Socket Wire

42-48	Pass	51A-15527	ea.	9.00
52-54	Pass	FAB-15536A/LS	ea.	2.78
55	Pass	FEA-15536A/LS, pvc.....	ea.	4.16
56	Pass	FDR-15536A/LS	ea.	4.62
52-53	Merc	0H-15536	ea.	4.44
54	Merc	8A-13413/LS	ea.	3.30
55	Merc	FDK-15536A/LS	ea.	4.76
56	Merc	FDT-15536A/LS	ea.	5.36
55	T-Bird	FEA-15536A/LS, pvc.....	ea.	4.16
56	T-Bird	FDR-15536A/LS	ea.	4.62

Back Up Light Wire

56	Pass	FDR-15506A	ea.	27.22
55	Merc	FDK-15506A	ea.	36.90
56	Merc	FDT-15506D, pvc	ea.	13.50
55	T-Bird	B5S-15506A, pvc	ea.	18.12
55	T-Bird	FDR-15525A, pvc	ea.	7.66

Back Up Light Crossover Wire

50-51	Merc	0H-15527A	ea.	9.02
-------	------	-----------------	-----	------

Back Up Light Feed Wire

42-48	Pass	51A-15525	ea.	6.00
52-54	Pass	FAB-15525A, w/std.....	ea.	6.04
52-54	Pass	FAB-15525B, w/auto	ea.	6.04
51	Merc	1H-15525A	ea.	7.22

FOG LIGHT

Fog Light Harness

42-48	Pass	51A-18207B	ea.	34.38
49-50	Pass	FAD-18207	ea.	32.74
42-48	Merc	51A-18207B	ea.	34.38
52-54	Merc	FAB-18207A.....	ea.	47.74
48-50	PU	8C-18207A	ea.	38.96

CONVERTIBLE TOP

Conv Top Control Circuit Breaker to Solenoid Wire

51	Conv	1A-14351	ea.	8.70
52-53	Conv	FAB-14351A.....	ea.	9.86
54	Conv	FDA-14351A	ea.	8.50

Conv Top Control Switch to Circuit Breaker Wire

46-49	Conv	51A-14332A	ea.	16.62
51	Conv	1A-14348	ea.	12.80
48	Merc Conv	6M-14332	ea.	15.16

Conv Top Control Switch to Solenoid Wire

50	Conv	8M-14332B.....	ea.	7.02
49-51	Merc Conv	8M-14332B.....	ea.	7.02

Conv Top Relay to Circuit Breaker Wire

52-53	Conv	FAA-14362A	ea.	26.60
54	Pass	FDA-14362A	ea.	27.94

Conv Top Control Wire

41	Conv	11A-14339	ea.	147.80
46-48	Sportsman	11A-14339.....	ea.	147.80

Conv Top Control Regulator to Solenoid

46-48	Sportsman	51A-14332B	ea.	13.18
-------	-----------	------------------	-----	-------

Conv Top Control, Power Seat & Window Wire

56	Conv	FDR-14351A	ea.	9.14
56	Merc Conv	FDR-14351A	ea.	9.14

Top Control Switch to Top Motor Wire

55	Conv	B5A-14362-B	ea.	86.56
56	Conv	B6A-14362A	ea.	103.66
55	Merc Conv	FDK-14362B	ea.	85.72

Top Control Solenoid to Starter Solenoid Wire

46-48	Conv	51A-14506B	ea.	17.76
49-50	Conv	8A-14506	ea.	11.14
46-48	Merc Conv	51A-14506B	ea.	17.76
49-51	Merc Conv	8M-14506	ea.	30.68

WIRING HARDWARE

Firewall Wire Loom Grommet



35-48	Pass	48-700731	ea.	5.00
49-50	Pass	8A-14603-B	ea.	4.00
51-59	Pass	1A-14603-B	ea.	4.00
39-48	Merc	48-700731	ea.	5.00
49-50	Merc	8A-14603-B	ea.	4.00
35-47	PU	48-700731	ea.	5.00
48-59	PU	1A-14603-B	ea.	4.00



Firewall Wire Loom Grommet Retainer



8A-14608

49-59	Pass	8A-14608ea.	10.00
49-59	Merc	8A-14608ea.	10.00
48-56	PU	8A-14608ea.	10.00

Male Bullet End

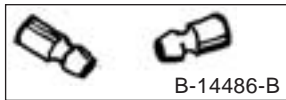

B-14486-B

All	Pass & PU	B-14486-B, brass, solder-on-typeea.	.40
All	Pass & PU	B-14486-S, solder-on-type, set of 10set.	3.25
38-47	Pass	81A-14486, solder on, for large horn wireea.	1.25
38-47	PU	81A-14486, solder on, for large horn wireea.	1.25

Socket Wire Contact End

All	Pass & PU	B-14486-SEea.	.20
-----	-----------	------------	----------	-----

Female Wire Connector

32-56	Pass	B-14487ea.	.60
38-47	Pass	81A-14487, early 47 large, for horn wireea.	2.54
39-56	Merc	B-14487ea.	.60
39-47	Merc	81A-14487, early 47 large, for horn wireea.	2.54
32-56	PU	B-14487ea.	.60
38-47	PU	81A-14487, large, for horn wireea.	2.54
All	Pass	B7A-14487-A, 4-way doubleea.	2.04
All	PU	B7A-14487-A, 4-way doubleea.	2.04

Wiring Connecting Blocks



FDT-14448-A

FDT-14448-B

FDT-14448-C

49-59	Pass	FDT-14448-A, 4 hole, under hoodea.	19.00
49-59	Pass	FDT-14448-B, 8 hole, under hoodea.	32.00
49-59	Pass	FDT-14448-C, 8 hole, under dashea.	25.00

Front Fender Inner Apron Hole Grommet

Where the headlight bucket wire comes through the inner fender panel.

39-40	Pass	91A-17545ea.	2.00
40-41	PU	91A-17545ea.	2.00

Fender Apron Wire Loom Grommet

49-59	Pass	8A-14651-Rea.	4.50
-------	------	------------	----------	------

Wire Harness Grommet

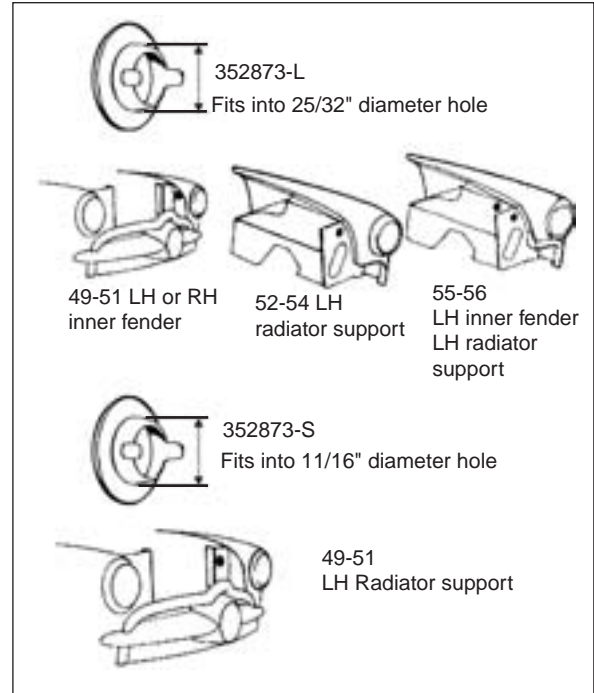

352873-L

Fits into 25/32" diameter hole

49-51 LH or RH inner fender

52-54 LH radiator support

55-56 LH inner fender LH radiator support

352873-S

Fits into 11/16" diameter hole

49-51 LH Radiator support

49-57	Pass	352873-S, 11/16"ea.	4.00
49-64	Pass	352873-L, 25/32"ea.	4.00
53-66	PU	352873-L, 25/32"ea.	4.00

Wire Frame Clips



B-14585-S

28-48	Pass	B-14585-S, short, pack of 10set.	3.00
-------	------	------------------------------	-----------	------



B-14585-L

28-48	Pass	B-14585-L, long, pack of 10set.	3.00
49-51	Pass	8M-14197ea.	3.00
28-56	PU	B-14585-S, short, pack of 10set.	3.00
28-56	PU	B-14585-L, long, pack of 10set.	3.00

Cloth Covered 14 Gauge Wire

All	Pass & PU	14-BLACK-WIREft.	.60
All	Pass & PU	14-GRN-WIREft.	.75
All	Pass & PU	14-RED-WIREft.	.75
All	Pass & PU	14-YEL-WIREft.	.75

Fabric Loom

All	Pass & PU	683, 3/16".....ft.	.60
All	Pass & PU	684, 1/4".....ft.	.60
All	Pass & PU	685, 5/16".....ft.	.60
All	Pass & PU	686, 1/2".....ft.	.75

Dielectric Grease

Used when plugging the male and female bullet ends together to keep out corrosion.

All	ACC-1659	EA.	3.00
-----	----------------	-----	------

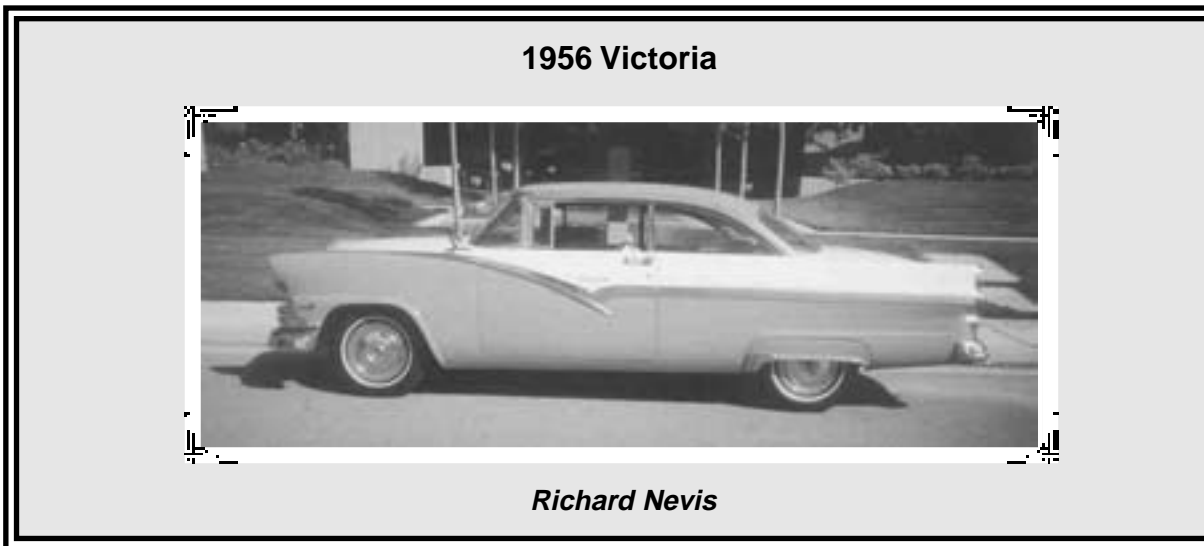
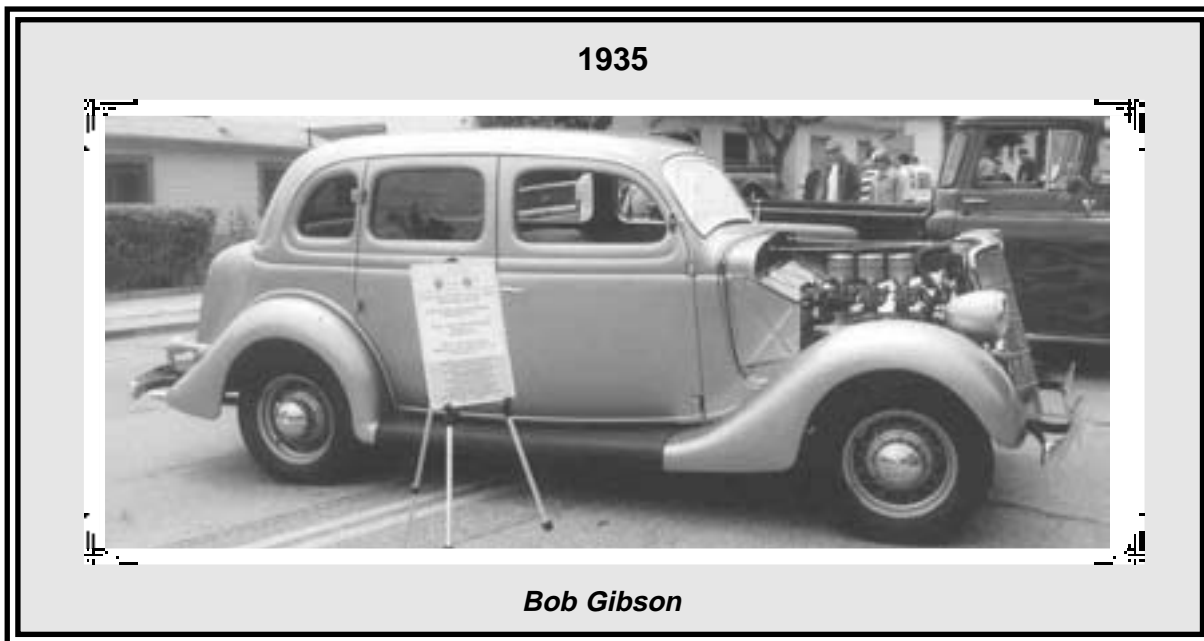



Section 26 Emblems

UNIVERSAL STICK-ON EMBLEM

"V-8" Emblem



40-8217-ST, 1-1/2"Wx2-5/8"H ...ea. 18.00

GRILLE

Porcelain Grille Shell Ornament Emblem



32	Pass	B-8212	ea.	35.00
33	Pass	18-8212	ea.	35.00
34	Pass	40-8212	ea.	35.00
35-36	Pass	48-8212	ea.	35.00
38	Pass	48-8212	ea.	35.00
32-35	PU	B-8212	ea.	35.00
36	PU	48-8212	ea.	35.00

Grille Emblem



33	Pass	40-8217-A, "V-8"	ea.	20.00
----	------	------------------------	-----	-------



34	Pass	40-8221-B, "V-8"	ea.	40.00
37	Pass	78-8213-A, "85"	ea.	50.00
33-35	PU	40-8217-A, "V-8"	ea.	20.00



7C-8315-S

48-50	PU	7C-8315-S, "F.O.R.D."	set.	50.00
52	PU	7C-8315-S, "F.O.R.D."	set.	50.00

Radiator Grille Emblem

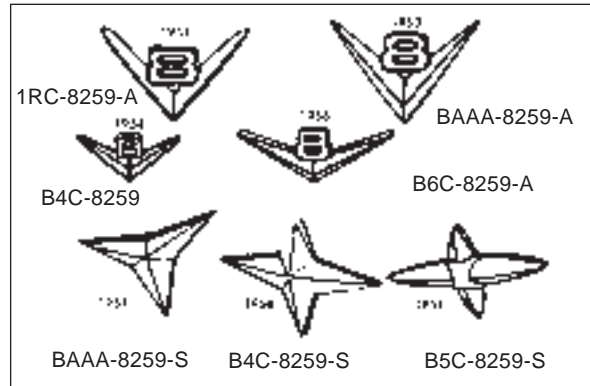

51	PU	1RC-8259-A, "V-8"	ea.	45.00
53	PU	BAAA-8259-S, 6 cyl., star	ea.	52.50
53	PU	BAAA-8259-A, "V-8"	ea.	60.00
54	PU	B4C-8259-S, 6 cyl., star	ea.	52.50
54	PU	B4C-8259, "V-8"	ea.	60.00
55	PU	B5C-8259-S, 6 cyl., star	ea.	52.50
55	PU	B5C-8259, "V-8"	ea.	60.00
56	PU	B6C-8259-A, "V-8"	ea.	60.00

HOOD FRONT

Front Hood Emblem



91A-16606

39	Dlx Pass	91A-16606, "Ford"	ea.	10.00
39	Dlx Pass	91A-16607, "Deluxe"	ea.	10.00
40	Std Pass	01A-16604/5-B, "V-8"	pr.	60.00



41	Pass	11A-8218-B	ea.	50.00
----	------	------------------	-----	-------



- | | | | |
|----|------|---|--------|
| 41 | Pass | 11A-16606-A, "V-8".....ea. | 45.00 |
| 42 | Pass | 2GA-16607-A,
6 cyl., "Ford 6", N.O.S.....ea. | 100.00 |



- | | | | |
|----|------|--|--------|
| 42 | Pass | 21A-16607-A,
V-8, "Ford 8", N.O.S.....ea. | 100.00 |
|----|------|--|--------|



- | | | | |
|-------|------|---|-------|
| 47-48 | Pass | 6HA-16606-A, N.O.S.,
"Deluxe 6"ea. | 35.00 |
|-------|------|---|-------|



- | | | | |
|-------|------|---|-------|
| 47-48 | Pass | 8RA-16606-B,
"Super Deluxe 8"ea. | 60.00 |
| 49 | Pass | 8A-16606-S,
"F.O.R.D."set. | 52.50 |

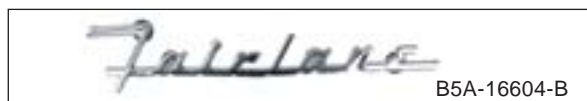

- | | | | |
|-------|------|-------------------------------------|-------|
| 55-56 | Pass | B5A-16604-B,
"Fairlane"ea. | 40.00 |
|-------|------|-------------------------------------|-------|

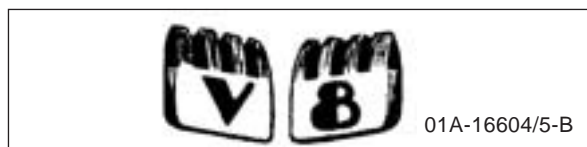

- | | | | |
|----|----|-------------------------------|-------|
| 40 | PU | 01A-16604/5-B, "V-8"pr. | 60.00 |
| 52 | PU | 2C-16608-A, V-8ea. | 50.00 |



- | | | | |
|-------|----|--|-------|
| 53-56 | PU | BAAA-16637-Aea. | 55.00 |
| 53-56 | PU | BF-7042528-B,
"Overdrive"ea. | 21.00 |
| 53-56 | PU | BF-7042528-A,
"Fordomatic"ea. | 25.00 |

Hood Ornament Emblem



- | | | | |
|----|------|------------------------|-------|
| 46 | Pass | 51A-16607, "8".....ea. | 40.00 |
|----|------|------------------------|-------|

Hood Emblem Plastic Insert



- | | | | |
|-------|------|---------------------------------------|-------|
| 50-51 | Pass | 0A-16637-Bea. | 40.00 |
| 52-56 | Pass | BA-16637-A,
exc. fairlaneea. | 40.00 |
| 55-56 | Frln | B5A-16637-Bea. | 40.00 |
| 51 | Merc | OM-7242530ea. | 70.00 |



- | | | | |
|-------|------|---------------------|-------|
| 52-53 | Merc | BC-16637-Aea. | 75.00 |
| 54-55 | Merc | BR-16637-Aea. | 75.00 |

Hood Emblem Chrome Retainer/Bezel



- | | | | |
|-------|------|-----------------------|-------|
| 50-51 | Pass | 0A-16644-USAea. | 40.00 |
| 52-54 | Pass | BA-16644-USAea. | 40.00 |

Section 26 - Emblems



C&G Early Ford Parts, Inc.

55-56	Pass	B5A-16644-D, exc. fairlane	ea.	45.00
55-56	Frln	B5A-16644-C	ea.	45.00

Hood Emblem Pad

50-56	Pass	0A-16675	ea.	1.00
55-56	Frln	B5A-16675	ea.	.50
53-56	PU	BAAA-16638	ea.	3.00

HOOD SIDE/FENDER

Hood Side Emblems

38	Dlx Pass	81A-16605/6, "V-8"	pr.	50.00
----	----------	--------------------------	-----	-------



40	Std Pass	91A-16606, "Ford"	ea.	10.00
40	Dlx Pass	01A-16606/7-B, "Ford Deluxe", w/red edges 4 pcs.	set.	60.00
40	Dlx Pass	01A-16606B, "Ford" w/red edges	ea.	12.00
40	Dlx Pass	01A-16606-A, "Ford"	ea.	10.00
40	Dlx Pass	01A-16607-A, "Deluxe"	ea.	11.00



34	PU	46-16606, "Ford", oval	ea.	40.00
----	----	------------------------------	-----	-------



34	PU	46-16608, "V-8"	ea.	17.50
----	----	-----------------------	-----	-------



35-36	PU	50-16606, "Ford V8"	ea.	55.00
-------	----	---------------------------	-----	-------



37	PU	77-16606, "85"	ea.	80.00
----	----	----------------------	-----	-------



38-39	PU	81C-16606, "85"	pr.	80.00
-------	----	-----------------------	-----	-------

40	PU	91A-16606, "Ford"	ea.	10.00
----	----	-------------------------	-----	-------



41	PU	11C-16606, "Ford"	ea.	25.00
----	----	-------------------------	-----	-------

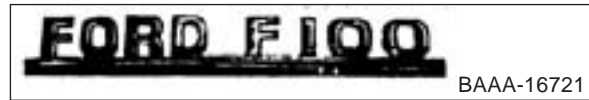

53-54	PU	BAAA-16721, "F100"	pr.	50.00
-------	----	--------------------------	-----	-------



53-54	PU	BAAA-16732/3-AK, "F-100 w/Boomerang"	kit.	175.00
-------	----	---	------	--------



55	PU	B5C-16721, "F100"	pr.	80.00
----	----	-------------------------	-----	-------

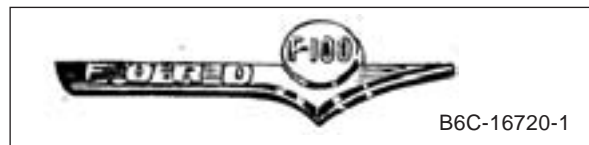

56	PU	B6C-16720/1, "F100"	pr.	120.00
----	----	---------------------------	-----	--------

Fender Emblems



41-42	Pass	11A-16079, "Super Deluxe"	ea.	40.00
-------	------	------------------------------------	-----	-------



46-47	Pass	51A-16079, "Super Deluxe"	ea.	40.00
-------	------	------------------------------------	-----	-------

50-51	Pass	DOA-16079, "Crestliner"	ea.	50.00
-------	------	----------------------------------	-----	-------



51-53	Pass	1BA-16237-A, "V-8"	pr.	40.00
-------	------	--------------------------	-----	-------

54-56	Pass	BM-16237-A, "V-8".....pr.	30.00
55	Pass	B5A-16237-A, "I-6" NOS.....pr.	70.00



56	Pass	B6A-16228/9-A, "Thunderbird V-8".....pr.	60.00
52-53	Merc	1M-7221020, plastic emblem w/polished metal bezel.....ea.	100.00
55-56	Montclair	BV-16098-A, "Montclair".....ea.	75.00
54-55	Merc	BR-16228-A, bezel not included.....ea.	75.00



55	T-Bird	BM-16237-A, "V-8".....pr.	30.00
55-56	T-Bird	B5S-4025622, "Thunderbird".....ea.	30.00

Fender Louver Ornament

55-57	T-Bird	B5A-16228-A, RH.....ea.	30.00
55-57	T-Bird	B5A-16229-A, LH.....ea.	30.00

Cab Side Emblem



48-50	PU	8C-16605, "F-1" chrome.....ea.	25.00
-------	----	--------------------------------	-------

DOOR

Door Emblem

51	Merc	1M-7221020, plastic emblem w/polished metal bezel.....ea.	100.00
----	------	--	--------

Door Emblem Scripts

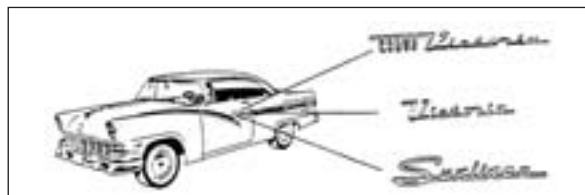

51-54	Wagon	1A-7920978-PR, 2 pr required "Country Squire".....pr.	150.00
55	Pass	B5A-16098-B, "Customline".....ea.	26.00
55-56	Pass	B5A-16098-F, "Victoria".....ea.	40.00
55-56	Pass	B5A-16098-G, "Sunliner".....ea.	40.00
55-56	Pass	B5A-6425622-B, "Crown Victoria".....ea.	44.00

55-56	PU	B5C-8125622-A, "Custom Cab".....pr.	26.00
-------	----	--	-------

QUARTER

Quarter Panel Emblem Script



54	Pass	BM-7625622-B, "Crestline".....ea.	Call
55-56	Pass	B5A-7325622-A, , "Town Sedan".....ea.	26.00
52-56	Merc	BC-7325622-CPR, "Monterey" ..pr.	90.00

Quarter Post Emblem Plastic



51-54	Pass	1A-7004539.....ea.	35.00
-------	------	--------------------	-------

Quarter Post Emblem Plastic Bezel



51-54	Pass	1A-7004540-A.....ea.	30.00
-------	------	----------------------	-------

Plastic Crest Emblem Body Medallion



54	Crestline	BM-7325662-B, conv & fordor.....ea.	24.50
55	Frln	BM-7325662-B, front door.....ea.	24.50
55-56	Frln	BM-7325662-B, back seat.....ea.	24.50
55-56	Cntry Squire	BM-7325662-B, front fender.....ea.	24.50
56	Parklane	BM-7325662-B, front door.....ea.	24.50
56	Parklane	BM-7325662-B, back seat.....ea.	24.50
55	T-Bird	BM-7325662-B, hood & gas lid.....ea.	24.50
55-56	T-Bird	BM-7325662-B, for hardtop.....ea.	24.50
56-57	T-Bird	BM-7325662-B, front fender.....ea.	24.50



Bezel for above Body Medallion

Fits all above except 55 T-Bird gas lid door

54-57	Pass	B6A-7925666-C, chrome w/gold top.....ea.	22.00
54-57	T-Bird	B6A-7925666-C, chrome w/gold top.....ea.	22.00

TRUNK

Trunk Emblem



39	Dlx Pass	91A-16606.....ea.	10.00
40	Std Pass	01A-7043370-A.....ea.	45.00
40	Dlx Pass	01A-7043370-B.....ea.	45.00

Trunk Ornament



47-48	Pass	6A-7042514, stainless with blue lettering and hardware.....ea.	100.00
47-48	Pass	HR-7042514, stainless with third brake lite and hardware.....ea.	145.00

Trunk Emblem Plastic



50-56	Pass	0A-7042514-B, except fairlane ...ea.	40.00
55	Frln	B5A-7042514-A.....ea.	40.00
56	Frln	B6A-7042514-A.....ea.	75.00



49	Merc	8M-7042530.....ea.	110.00
50	Merc	OM-7242530.....ea.	70.00



51	Merc	1M-7242530-B.....ea.	70.00
52	Merc	8M-7042530.....ea.	110.00



53-54	Merc	BG-7042530-A.....ea.	142.00
55	Merc	BV-7042530-A.....ea.	60.00

Trunk Emblem Bezel



50-51	Pass	1A-7043500.....ea.	40.00
53-54	Pass	B5A-7043522-A.....ea.	40.00
55	Frln	B5A-7042522-A.....ea.	45.00
56	Frln	B6A-7043500-C.....ea.	95.00

Trunk Emblem Pad

40	Pass	01A-7043370-RP.....ea.	6.00
50-56	Pass	0A-16675.....ea.	1.00
55	Frln	B5A-16675.....ea.	.50
56	Frln	B6A-7004541-S.....ea.	2.00

Trunk Emblem Script

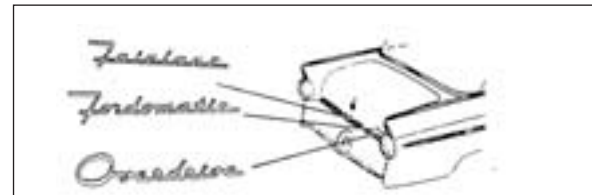

53-55	Pass	BF-7042528-B, "Overdrive".....ea.	21.00
53-55	Pass	BF-7042528-A, "Fordomatic".....ea.	25.00
55	Frln	B5A-7042528-B, "Fairlane".....ea.	32.00

**Section 27
Fender**

FENDER

Steel Front Fender

Must be shipped truck freight.



*33-34	Pass	40-16005-PR, PAIR.....pr.	1995.00
--------	------	---------------------------	---------

*33-34	Pass	40-16005-B, RHea.	1050.00
*33-34	Pass	40-16006-B, LHea.	1050.00
*53-56	PU	BAAA-16005-A, RHea.	500.00
*53-56	PU	BAAA-16006-A, LHea.	500.00

Steel Rear Fender

Must be shipped truck freight.



*33-34	Roadster	40-16160-PR, PAIRpr.	1650.00
*33-34	Cabriolet	40-16160-PR, PAIRpr.	1650.00
*33-34	Cpe	40-16160-PR, PAIRpr.	1650.00
*33-34	Roadster	40-16160-B, RHea.	850.00
*33-34	Roadster	40-16161-B, LHea.	850.00
*33-34	Cabriolet	40-16160-B, RHea.	850.00
*33-34	Cabriolet	40-16161-B, LHea.	850.00
*33-34	Cpe	40-16160-B, RHea.	850.00
*33-34	Cpe	40-16161-B, LHea.	850.00
*53-72	PU	BAAA-16312-A, F100, RHea.	350.00
*53-72	PU	BAAA-16313-A, F100, LHea.	350.00

REPAIR PANEL

Front Fender Lower Headlight Repair Panel

55-56	Pass	B6A-16018, RHea.	53.00
55-56	Pass	B6A-16019, LHea.	53.00

Lower Rear Front Fender Tip Patch Panel

55-56	Pass	B6A-16D058, RHea.	48.00
55-56	Pass	B6A-16D059, LHea.	48.00

Front of Rear Fender Repair Panel

35-40	Pass	48-16314, RHea.	100.00
35-40	Pass	48-16315, LHea.	100.00

Lower Front Fender Rear Repair Section



49-51	Pass	8A-16000-R, RHea.	75.00
49-51	Pass	8A-16000-L, LHea.	75.00



48-52	PU	7C-16009, RHea.	105.00
48-52	PU	7C-16010, LHea.	105.00

Lower Front Fender Inner Brace

49-51	Pass	8A-16001, LHea.	59.00
49-51	Pass	8A-16000, RHea.	59.00

Fiberglass Lower Front Fender Extension

48-50	PU	7C-16432-FB, rightea.	120.00
48-50	PU	7C-16433-FB, leftea.	120.00

APRONS

Front Fender Inner Aprons

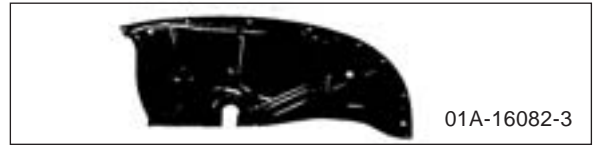

*39	Dlx Pass	01A-16082/3pr.	375.00
*39	Dlx Pass	01A-16082/3-M, For use w/Mustang II front endpr.	375.00
*40	Pass	01A-16082/3pr.	375.00
*40	Pass	01A-16082/3-M, For use w/Mustang II front endpr.	375.00
*40-41	PU	01A-16082/3pr.	375.00
*40-41	PU	01A-16082/3-M, For use w/Mustang II front endpr.	375.00
*53-56	PU	BAAD-16054-A, RHea.	225.00
*53-56	PU	BAAD-16055-A, LHea.	225.00

BRACES

Front Fender Braces

These are the large braces at the front of the fender.



32	Pass	B-16025ea.	36.00
----	------	---------	----------	-------



33-34	Pass	40-16025set.	100.00
36	Pass	68-16022/3pr.	225.00

Front Fender Brace Support

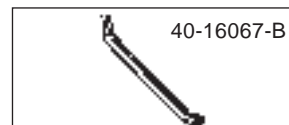

33-34	Pass	40-16067-Bea.	9.00
35-39	Std Pass	48-16067, RHea.	20.00
35-39	Std Pass	48-16068, LHea.	20.00
39	Dlx Pass	91A-16067pr.	25.00
37-39	PU	48-16067, RHea.	20.00
37-39	PU	48-16068, LHea.	20.00



Front Fender Reinforcement Brace

53-56	PU	BAAA-16600-L, LH.....	ea.	26.00
53-56	PU	BAAA-16600-R, RH.....	ea.	26.00

Rear of Front Fender Brace



33-34	Pass	40-16094-A.....	ea.	25.00
35-36	Pass	68-16094.....	ea.	25.00
37-38	Pass	78-16094.....	ea.	25.00
39	Std Pass	78-16094.....	ea.	25.00
35-37	PU	50-16094.....	ea.	25.00
38-39	PU	81C-16094.....	ea.	35.50
53-56	PU	BAAA-16010-A, RH.....	ea.	14.95
53-56	PU	BAAA-16011-A, LH.....	ea.	14.95
53-56	PU	BAAA-16010-PSS, RH, SS.....	ea.	19.95
53-56	PU	BAAA-16011-PSS, LH, SS.....	ea.	19.95

Rear of Fender to Cab Brace



40-41	PU	01C-16094.....	pr.	30.00
-------	----	----------------	-----	-------

Front Fender Brace Panel



39	Dlx Pass	91A-16088/9.....	pr.	75.00
40	Pass	91A-16088/9.....	pr.	75.00
41	Pass	11A-16094-A.....	pr.	75.00



42-48	Pass	21A-16094.....	pr.	75.00
40-41	PU	91A-16088/9.....	pr.	75.00

Front Fender Spacer Clamp

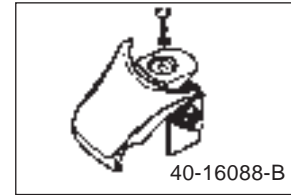

33-34	Pass	40-16088-B, black.....	ea.	35.00
33-34	Pass	40-16088-C, chrome.....	ea.	25.00
33-34	Pass	40-16088-SS, SS.....	ea.	45.00

Front Fender Support Tie

37	Pass	78-8232-B.....	ea.	30.00
----	------	----------------	-----	-------

Fender Apron to Radiator Bracket

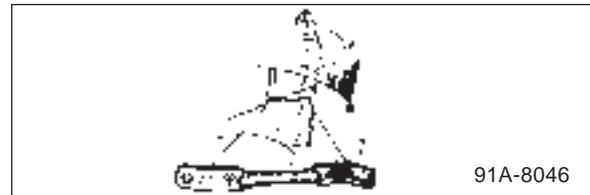

39	Dlx Pass	91A-8046.....	pr.	30.00
39	Dlx Pass	91A-8046-SS, stainless.....	pr.	40.00
40	Pass	91A-8046.....	pr.	30.00
40	Pass	91A-8046-SS, stainless.....	pr.	40.00
39-40	Merc	91A-8046.....	pr.	30.00
39-40	Merc	91A-8046-SS, stainless.....	pr.	40.00
40-41	PU	91A-8046.....	pr.	30.00
40-41	PU	91A-8046-SS, stainless.....	pr.	40.00

Rear Fender Brace



35-36	Pass	48-16341.....	ea.	25.00
37-40	Pass	78-16341.....	ea.	25.00
35-36	PU	50-16341.....	ea.	25.00
35-37	Panel	50-16341.....	ea.	25.00
37	PU	67-16341.....	ea.	Call
38-41	PU	81C-16341.....	ea.	25.00
42-47	PU	21C-16340-C.....	ea.	Call
48-50	PU	7C-16340-PR.....	pr.	42.00
51-52	PU	1C-16340-PR.....	pr.	40.00



53-56	PU	BAAA-16340-A, F-100-F350.....	ea.	10.00
-------	----	----------------------------------	-----	-------

Rear Fender Brace Panel

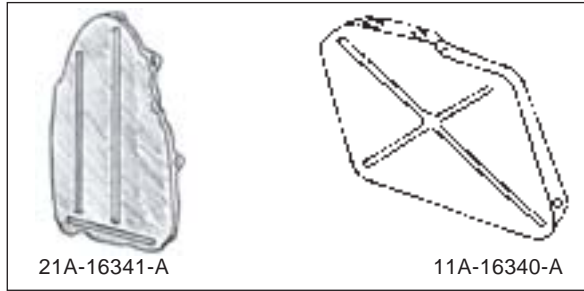

41-48	Pass	11A-16340-A, RHea.	40.00
42-48	Pass	21A-16341-A, LHea.	60.00

PADS/SEALS

Fender, Grill, & Apron Welting & Webbing Kit

Includes Fender Welting for front fenders to grill and cowl, and rear fenders to body. Also includes front fender to inner apron anti-squeak. Pre-cut notches and holes.

39	Dlx Pass	91A-5010-Bkit.	55.00
40	Pass	91A-5010-Bkit.	55.00
40-41	PU	91A-5010-Bkit.	55.00

Vinyl Fender Welting - 25 Foot Roll

3/16" Bead

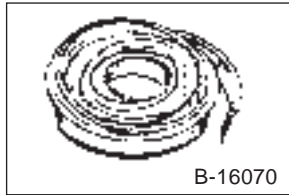

All	Pass & PU	B-16070, blackea.	12.50
All	Pass & PU	B-16070-BLM, medium blueea.	30.00
All	Pass & PU	B-16070-BRD, dark brownea.	30.00
All	Pass & PU	B-16070-CR, caramelea.	30.00
All	Pass & PU	B-16070-GRD, dark greenea.	30.00
All	Pass & PU	B-16070-GY, greyea.	30.00
All	Pass & PU	B-16070-MR, maroonea.	30.00
All	Pass & PU	B-16070-OR, bright orangeea.	30.00
All	Pass & PU	B-16070-RD, redea.	30.00
All	Pass & PU	B-16070-RR, bright redea.	30.00
All	Pass & PU	B-16070-WH, whiteea.	30.00
All	Pass & PU	B-16070-YL, bright yellowea.	30.00

Fender Welting



All	Pass & PU	40-16070-A, 25' x 1/4" bead, vinylea.	14.00
All	Pass & PU	48-16070-RR, 10' x 1/4" bead, rubberea.	13.50
*All	Pass & PU	48-16070-SS, SS bead, 8'ea.	23.00

Fender to Cowl Seal



42-47	PU	21C-16068pr.	15.00
48-52	PU	7C-16068pr.	15.00
53-56	PU	BAAA-16126pr.	13.50

Fender to Cowl Pad

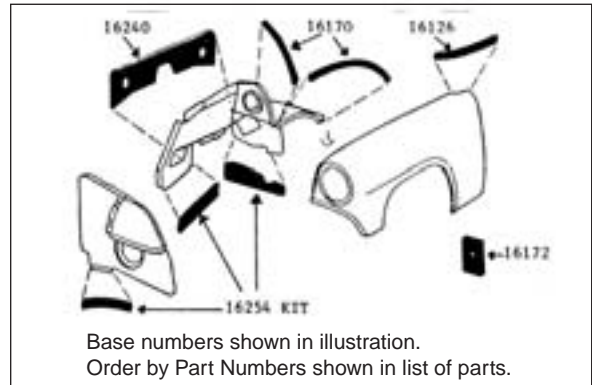

52-56	Pass	BA-16126-Apr.	3.00
55-58	Pass	B5A-16172pr.	2.00
50-51	Merc	0M-16110pr.	20.00

Top Outside Corner of Cowl to Hood Seal

49-51	Merc	8M-7002074-PRpr.	10.00
-------	------	---------------	----------	-------

Anti-Squeak

49-51	Pass	8M-16070-A, 15'ea.	20.00
52-54	Pass	BA-16170-A, 140"ea.	15.00
55-60	Pass	B5A-16170-A, 72"ea.	8.00
48-52	PU	M-17772-C, 15'ea.	30.00

Fender Apron Bumpers



39-40	Pass	01A-16188, 4 pcs.....	set.	4.00
42-48	Pass	21A-16188, 6 pcs.....	set.	5.00
39-40	Merc	01A-16188, 4 pcs.....	set.	4.00
42-48	Merc	21A-16188, 6 pcs.....	set.	5.00
40-41	PU	01A-16188, 4 pcs.....	set.	4.00
48-52	PU	7C-16754-B.....	pr.	4.00

Splash Apron to Suspension Seals

54	Pass	BM-16240	pr.	13.50
55-56	Pass	B5A-16240.....	pr.	25.00
55-57	T-Bird	BM-16240	pr.	13.50

Splash Apron Front Seal

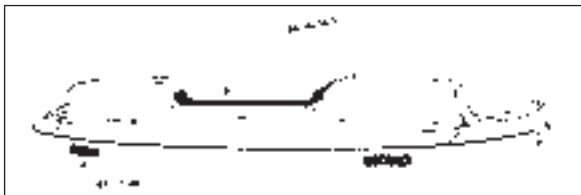

49-51	Pass	8A-16254-S	ea.	5.00
52-53	Pass	BA-16254.....	set.	18.00
54	Pass	BM-16254	pr.	18.00
55-56	Pass	B5A-16254.....	pr.	18.00
55-57	T-Bird	B5S-16254	pr.	6.00

Splash Apron Rear Seal

56-57	T-Bird	B5S-16110	pr.	8.00
-------	--------	-----------------	-----	------

Fender Brace Support Seal

48-52	PU	7RC-16153-A.....	pr.	6.00
-------	----	------------------	-----	------

Fender Skirt Flange to Radiator Grille Gasket



48-50	PU	7C-16086	ea.	4.00
-------	----	----------------	-----	------

Front Fender Plate Opening Flange Gasket

51-52	PU	1C-16208.....	pr.	8.00
-------	----	---------------	-----	------

Rear Fender Brace Panel Seal

42-48	Pass	21A-8104-R.....	ea.	10.00
-------	------	-----------------	-----	-------

TRIM

Front Fender & Grille Trim

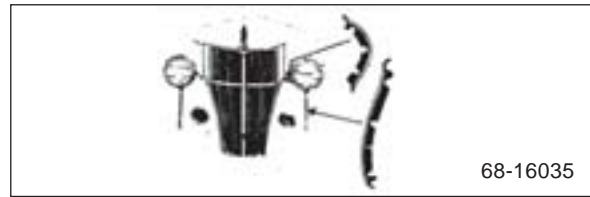

36	Pass	68-16035, SS, w/welting, 4 pcs.	pr.	40.00
----	------	---	-----	-------

Polished Stainless Front Fender Gravel Shield

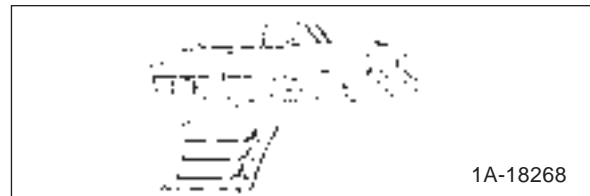

49-51	Pass	1A-18268, has 3 studs on back, needs 1 #19378 clip	pr.	129.95
49-51	Merc	0L-16210-PR, w/hardware.....	pr.	175.00

SKIRTS

Fender Skirt Assembly

Includes seal



35-40	Pass	91A-7027964-PR, fiberglass.....	pr.	175.00
49-51	Pass	8A-7027964-PR, steel.....	pr.	130.00
52-54	Pass	BA-7027964-ST, steel.....	pr.	130.00
55-56	Pass	B5A-7027964-PR, steel.....	pr.	130.00
52-54	Merc	BA-7027964-ST, steel.....	pr.	130.00
55-57	T-Bird	B7S-4027964, fiberglass.....	pr.	125.00

Fender Skirt Mounting Bracket Kit



55-56	Pass	B5A-7327980-BK.....	kit.	20.00
-------	------	---------------------	------	-------

Fender Skirt Rubber Seal

40-51	Pass	01A-18990	pr.	10.00
52-54	Pass	BA-7327986, original type	pr.	20.00
55-56	Pass	B5A-7327986, original type	pr.	11.00

52-54	Merc	BC-7327986-PR.....pr.	22.00
55-57	T-Bird	B7S-4027986-PR.....pr.	16.00

39-40	Merc	20367-S2.....set.	11.00
40-41	PU	20367-S2.....set.	11.00

STONE GUARDS

Rear Fender Stone Guards

Rubber covered steel. Wagon stone guards are in limited supply.



42-48	Pass	51A-16349/50-A, except wagon.....pr.	125.00
42-48	Wagon	51A-16349-50-B.....pr.	325.00
42-48	Merc	51A-16349/50-A, except wagon.....pr.	125.00
42-48	Merc Wgn	51A-16349-50-B.....pr.	325.00

Stainless Rear Fender Stone Guards

Polished stainless with mounting hardware.

42-48	Pass	51A-16349/50-SS, , except wagon.....pr.	175.00
-------	------	---	--------

HARDWARE

Front Fender to Fender Brace Bolts

32	Pass	B-16026, 1 set req'd black.....set.	1.50
32	Pass	B-16026-SS, 1 set req'd stainless.....set.	3.00
33-34	Pass	B-16026, 2 sets req'd black.....set.	1.50
33-34	Pass	B-16026-SS, 2 sets req'd stainless.....set.	3.00
32-34	PU	B-16026, 1 set req'd black.....set.	1.50
32-34	PU	B-16026-SS, 1 set req'd stainless.....set.	3.00

Top of Front Fender Nut and Bolt Kit

30-32	Pass	1164, SS, 8 pcs.kit.	2.75
-------	------	---------------------------	------

Fender Bolt

These have no markings on the head and are 5/16"-24 x 7/8".

35-48	Pass	48-16007.....ea.	.25
35-47	PU	48-16007.....ea.	.25

Front Fender to Apron Bolts

Sold in set of 8 bolts.



39	Dlx Pass	20367-S2.....set.	11.00
40	Pass	20367-S2.....set.	11.00

Fender Washer Kit

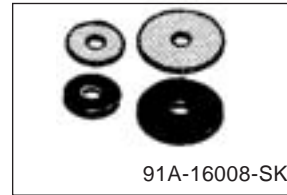

35-36	Pass	48-16008-SK, 28 pcs.kit.	10.00
39-40	Pass	91A-16008-SK, 60 pcs.kit.	16.00
39-40	Merc	91A-16008-SK, 60 pcs.kit.	16.00
39-40	PU	91A-16008-SK, 60 pcs.kit.	16.00

Fender Washer

All	Pass & PU	48-16008-R, rubber, 1-1/4" diameter.....ea.	.50
All	Pass & PU	48-16008-S, steel, 1-1/4" diameter.....ea.	.50
All	Pass & PU	48-16009-R, rubber, 1-1/2" diameter.....ea.	.50
All	Pass & PU	48-16009-S, steel, 1-1/2" diameter.....ea.	.50

Front Fender Apron Wire Hole Grommet

Where the headlight bucket wire comes through the inner fender panel.

39-40	Pass	91A-17545.....ea.	2.00
40-41	PU	91A-17545.....ea.	2.00

Fender Grommet



37	Pass	B9A-6570-A.....ea.	1.75
----	------	--------------------	------

Rear Fender to Body Clips

39-40	Pass	01A-16009-K, 18 pieces.....kit.	40.00
39-40	Merc	01A-16009-K, 18 pieces.....kit.	40.00

Rear Fender Brace Hardware Kit

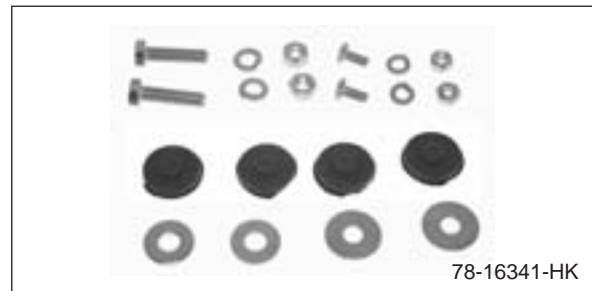

37-40	Pass	78-16341-HK.....kit.	8.00
37-41	PU	78-16341-HK.....kit.	8.00



Rear Fender to Bed Stud, Nut, & Washer Kit

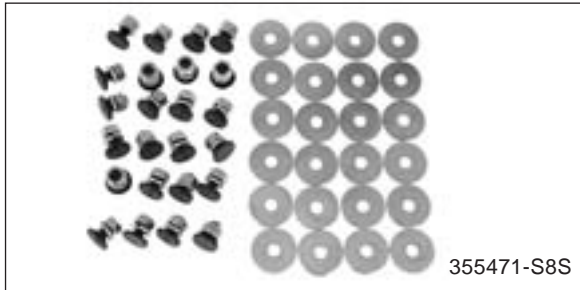

48-72 PU 355471-S8S, 24 pcs.set. 21.00

Rear Fender Bolt

48-72 PU 355471-S8, fastens rear fender to bed sideea. 1.25

Section 28 Hood

HOOD

1937 Steel Hood

Includes holes for original hood ornament/handle. Has correct underside supports with threaded hood hinge mounting shoulders. Shipped via truck, freight collect, plus crating fee.

*37 Pass 78-100ea. 600.00

1937 Hot Rod Steel Hood

Has correct underside supports with threaded hood hinge mounting shoulders. No holes for hood ornament/handle. Has hood support brackets on both sides of hood. Shipped via truck, freight collect plus crating fee.

*37 Pass 78-101ea. 600.00

1953-56 Steel Hood

No holes for emblems. Shipped via truck, freight collect plus crating fee.

*53-56 PU BAAA-16612ea. 925.00

HINGES/SUPPORTS

Stainless Hood Hinge Center Strip

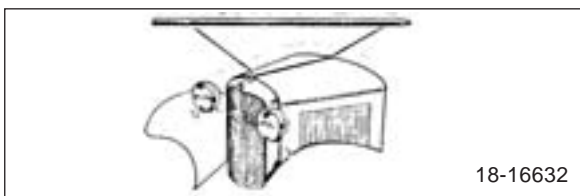

32 Pass 18-16632, 32"ea. 40.00
 33-36 Pass 40-16632, 33"ea. 40.00
 32-36 Pass U-16632, universal 48"ea. 25.00
 33-34 PU 46-16736ea. 100.00

35-36 PU 67-16736ea. 100.00

Hood Brackets for Center Strip



32-35 Pass B-8220-S, front, stainlessea. 20.00
 32-35 Pass B-8220, front, chromeea. 11.00



36 Pass 68-8226, front, cadmiumea. 10.00
 32 Pass B-8221, rear, chromeea. 16.00
 32 Pass B-8221-S, rear, stainlessea. 25.00
 33-36 Pass B-8220-S, rear, stainlessea. 20.00
 33-36 Pass B-8220, rear, chromeea. 11.00
 32 PU B-8220-S, front, stainlessea. 20.00
 32 PU B-8220, front, chromeea. 11.00
 32 PU B-8221-S, rear, stainlessea. 25.00



32 PU B-8221, rear, chromeea. 16.00



33-34 PU 46-8221, rear, stainlessea. 20.00
 33-34 PU 46-8220, front, stainlessea. 20.00



35-37 PU 46-8220-A, front or rear, chromeea. 20.00

Hood Hinge Brackets



37	Pass	78-16796/7, black.....pr.	60.00
37	Pass	78-16796/7-SST, stainless.....pr.	85.00
38-40	Pass	91A-16796/7, black.....pr.	60.00
38-40	Pass	91A-16796/7-SST, stainless.....pr.	90.00
41-48	Pass	21A-16796/7, late 41, black.....pr.	50.00
41-48	Pass	21A-16796/7-SS, late 41, stainless.....pr.	85.00
39-40	Merc	01C-16796, black.....pr.	50.00
39-40	Merc	01C-16796/7-SST, stainless.....pr.	50.00
41-48	Merc	21A-16796/7, late 41, black.....pr.	50.00
41-48	Merc	21A-16796/7-SS, late 41, stainless.....pr.	85.00
40-47	PU	01C-16796, black.....pr.	50.00
40-47	PU	01C-16796/7-SST, stainless.....pr.	50.00
53-55	PU	BAAA-16796, RH plain steel.....ea.	69.95
53-55	PU	BAAA-16797, LH plain steel.....ea.	69.95
56	PU	B6C-16796, RH plain steel.....ea.	69.95
56	PU	B6C-16797, LH plain steel.....ea.	69.95

Hood Hinge Pads



37-40	Pass	78-16746/7.....pr.	15.00
52-54	Pass	BA-16878-A.....pr.	6.50

Hood Hinge to Hood Shoulder Bolts

Used on 1939-48 cars and 1940-47 pickups that DO NOT have a shoulder on the hood. If there is a shoulder order #350345-3. All 1949-54 cars and 1953-56 pickups require shoulder bolts.

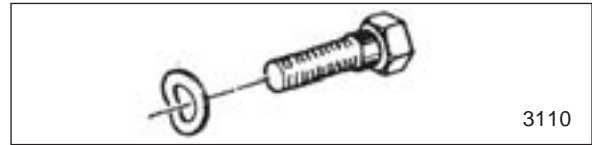

39-48	Pass	3110, 1/4"-28 w/3/8" shoulderea.	2.00
49-54	Pass	3110A, 5/16"-24, 7/16" shoulderea.	2.25
39-48	Merc	3110, 1/4"-28 w/3/8" shoulderea.	2.00
49-54	Merc	3110A, 5/16"-24, 7/16" shoulderea.	2.25
40-47	PU	3110, 1/4"-28 w/3/8" shoulderea.	2.00
53-55	PU	3110A, 5/16"-24, 7/16" shoulderea.	2.25
56	PU	3110B, 5/16"-24, 5/8" shoulderea.	2.25

Hood Hinge to Hood Bolt Kit

Used on cars and pickups that have a shoulder on the hood.

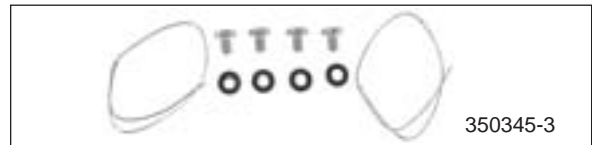

37-40	Pass	350345-3.....set.	8.50
39-40	Merc	350345-3.....set.	8.50
37-41	PU	350345-3.....set.	8.50

Hood Hinge Spring



49	Pass	8A-16789.....ea.	10.00
50	Pass	0A-16789.....ea.	12.00

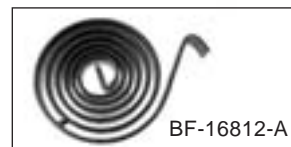

52-54	Pass	BF-16812-A.....ea.	15.00
54-56	PU	BF-16812-A.....ea.	15.00

Stainless Hood Hinge Rod

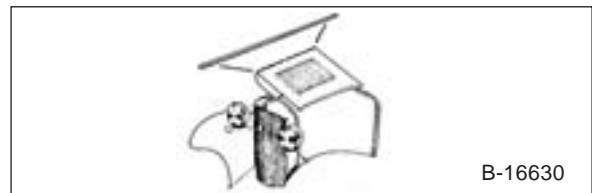

32-36	Pass	B-16630.....ea.	15.00
33-37	PU	B-16630.....ea.	15.00

Hood Arm & Spring Supports



39	Std Pass	91A-16782/3pr.	55.00
39	Std Pass	91A-16782/3-SS, stainlesspr.	95.00
39	Dlx Pass	91A-16802/3pr.	55.00
39	Dlx Pass	91A-16802/3-SS, stainlesspr.	95.00
40	Pass	91A-16802/3pr.	55.00
40	Pass	91A-16802/3-SS, stainlesspr.	95.00
41-48	Pass	91A-16782/3pr.	55.00
41-48	Pass	91A-16782/3-SS, stainlesspr.	95.00
39-47	PU	91A-16782/3pr.	55.00
39-47	PU	91A-16782/3-SS, stainlesspr.	95.00

Hood Arm Support Spring

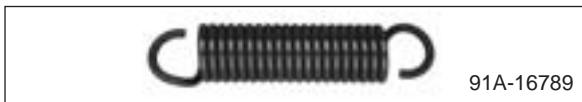

39-48	Pass	91A-16789ea.	6.00
39-48	Pass	91A-16789-SS, stainlessea.	11.00
39-48	Merc	91A-16789ea.	6.00
39-48	Merc	91A-16789-SS, stainlessea.	11.00
39-47	PU	91A-16789ea.	6.00
39-47	PU	91A-16789-SS, stainlessea.	11.00

Hood Arm Support to Hood Bracket



39-40	Pass	91A-16794/5-Cpr.	35.00
-------	------	---------------	----------	-------

Hood Arm Support Shoulder Screws



39-48	Pass	20308-S2pr.	4.50
39-48	Merc	20308-S2pr.	4.50
40-47	PU	20308-S2pr.	4.50

Stainless Hood Prop Kit



28-36	Pass & PU	A-16613-SSkit.	50.00
-------	-----------	------------	-----------	-------

LIGHT SWITCH

Accessory Hood Light Switch

This replaces the original mercury switch. For use with your original light housing.

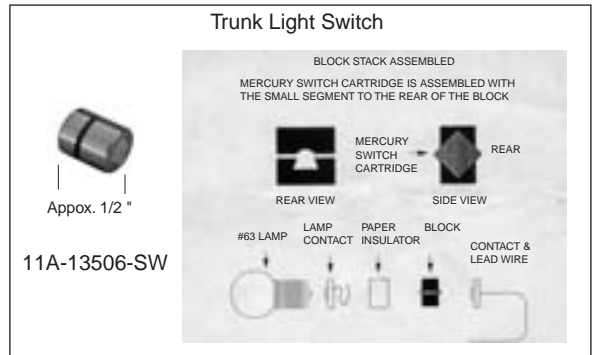

41-48	Pass	11A-13506-SWea.	40.00
-------	------	--------------	----------	-------

LATCHES

Hood Latch

Four required.

32	Pass	B-16750-B, blackea.	11.00
32	Pass	B-16750-SSVI, stainlessea.	20.00
32-34	PU	B-16750-B, blackea.	11.00
32-34	PU	B-16750-SSVI, stainlessea.	20.00



53-56	PU	B5C-16700ea.	35.00
-------	----	-----------	----------	-------

Hood Latch Set

Sold in set of 4.

32	Pass	B-16750, black w/stainless topset.	90.00
32	Pass	B-16750-SS, stainlessset.	125.00
32-34	PU	B-16750, black w/stainless topset.	90.00
32-34	PU	B-16750-SS, stainlessset.	125.00

Hood Latch Pad

32	Pass	B-16750-Rset.	15.00
32-34	PU	B-16750-Rset.	15.00

Hood Latch Screw & Nut Set

32	Pass & PU	3162set.	3.25
----	-----------	------	-----------	------

Hood Front Locking Panel

*53-56 PU B5C-16717-Aea. 225.00

Hood Side Panel Clip

Set includes 4 panel clips, 12 threaded rivets with nuts and 4 bumpers.

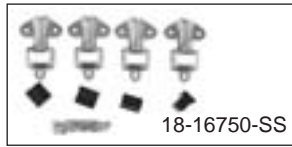

32	Pass	18-16750set.	40.00
32	Pass	18-16750-SS, stainlessset.	50.00
32-34	PU	18-16750set.	40.00
32-34	PU	18-16750-SS, stainlessset.	50.00

Hood Latch Spring Brackets

34	Pass	40-16658-K, set of 4set.	60.00
35-36	Pass	48-16658-K, set of 4set.	60.00
35-36	PU	48-16658-K, set of 4set.	60.00

Hood Latch Springs

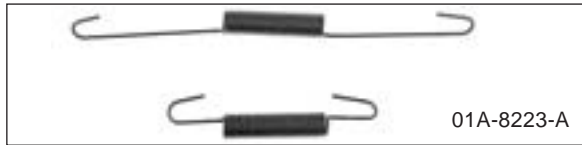

39	Dlx Pass	91A-8223set.	15.00
40	Std Pass	01A-8223-Aset.	15.00
40	Dlx Pass	01A-8223-Bset.	15.00
39-40	Merc	91A-8223set.	15.00
40-41	PU	01A-8223-Aset.	15.00
53-56	PU	BAAA-16921-Aea.	1.00

Black Hood Handles

28-32	Pass	B-16609kit.	25.00
28-34	PU	B-16609kit.	25.00

Stainless Hood Handles

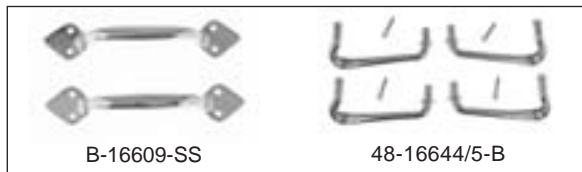

28-32	Pass	B-16609-SSpr.	35.00
33	Pass	40-16636-A, chromepr.	110.00
34-36	Pass	48-16644/5-Bset.	140.00
28-34	PU	B-16609-SSpr.	35.00
35-37	PU	48-16644/5-Bset.	140.00

Hood Handle & Latch Rivet Kit

28-32	Pass	1160-Rkit.	6.00
28-34	PU	1160-Rkit.	6.00

Hood Cross Brace Hardware Kit

40	Pass & PU	01A-16774-BHKkit.	9.00
----	-----------	---------------	-----------	------

Hood Release Linkage & Support Brace Kit

Includes brackets, linkage, and hood latch springs. A handy diagram is included.

39	Dlx Pass	91A-16674-Kkit.	60.00
40	Std Pass	01A-16674-AKkit.	60.00
40	Dlx Pass	01A-16674-BKkit.	60.00
40-41	PU	01A-16674-AK, V8 enginekit.	60.00

Hood Catch Lever Hardware Kit



39	Dlx Pass	01A-16674-HKkit.	10.00
40	Pass	01A-16674-HKkit.	10.00
40	PU	01A-16674-HKkit.	10.00

Hood Safety Catch



39	Dlx Pass	91A-16892-Aea.	15.00
40	Std Pass	01A-16892-Aea.	45.00
40	Std Pass	01A-16892-A-S, stainlessea.	50.00
40	Dlx Pass	01A-16892-Bea.	45.00
40	Dlx Pass	01A-16892-B-S, stainlessea.	50.00
40-41	PU	01A-16892-Aea.	45.00
40-41	PU	01A-16892-A-S, stainlessea.	50.00
53-56	PU	BAAA-16892, chromate platedea.	20.00



53-56	PU	BAAA-16892-SS, polished stainlessea.	30.00
-------	----	-----------------------------------	----------	-------

Hood Safety Catch Spring



41-42	Pass	11A-16897ea.	10.00
46-50	Pass	51A-16897ea.	8.00
51	Pass	8M-16897-Bea.	7.50
41-42	Merc	11A-16897ea.	10.00
46-48	Merc	51A-16897ea.	8.00
49-51	Merc	8M-16897-Bea.	7.50
42-47	PU	51A-16897ea.	8.00



Hood Release Cable



41-48	Pass	6A-16916, no knob.....ea.	20.00
49-51	Pass	8A-16916-C, w/chrome knob.....ea.	30.00
41-48	Merc	6A-16916, no knob.....ea.	20.00
49-51	Merc	8A-16916-C, w/chrome knob.....ea.	30.00

Universal Hood Release Cable



All	Pass	11A-16916R, 81".....ea.	13.00
-----	------	-------------------------	-------

Hood Release Cable Knob

42	Dlx Pass	21A-16918-A, maroon.....ea.	8.00
42	Super Dlx	21A-16918-B, butterscotch.....ea.	8.00
46	Dlx Pass	51A-16918-A, brown.....ea.	8.00
46	Super Dlx	51A-16918-B, blue gray.....ea.	8.00
46	Super Dlx	51A-16918-C, gray tan.....ea.	8.00
47-48	Pass	6A-16918, gray tan.....ea.	8.00
49-51	Pass	8A-16916-K, chrome.....ea.	20.00
49-51	Merc	8A-16916-K, chrome.....ea.	20.00

Hood Release Cable End



All	Pass	11A-16916-END, brass sleeve w/set screw.....ea.	1.00
-----	------	---	------

Hood Side to Fender Mounting Kit

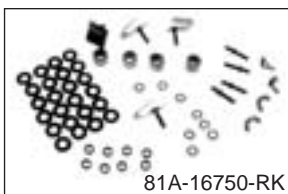

38	Pass	81A-16750-RK.....kit.	40.00
39	Std Pass	81A-16750-RK.....kit.	40.00

HOOD HANDLE/ORNAMENT

Chrome Hood Ornament



38	Dlx Pass	81A-16852, requires emblem 48-8212.....ea.	175.00
----	----------	--	--------



39	Dlx Pass	91A-8218-B.....ea.	150.00
40	Std Pass	01A-8218-A.....ea.	150.00
40	Dlx Pass	01A-8218-B.....ea.	150.00



47-48	Pass	6A-16851, requires 6A-16607 blue plastic.....ea.	225.00
-------	------	--	--------



50	Pass	0A-16850-USA.....ea.	125.00
40	PU	01C-8218.....ea.	150.00

Chrome Hood Ornament With Handle

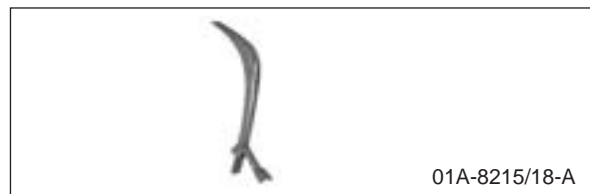

40	Std Pass	01A-8215/18-A.....ea.	165.00
40	Dlx Pass	01A-8215/18-B.....set.	165.00

Hood Ornament Emblem



38	Std Pass	81A-8259-A, "85".....ea.	40.00
----	----------	--------------------------	-------



46 Pass 51A-16607, "8".....ea. 40.00

Plastic Hood Ornament Insert



47-48 Pass 6A-16607ea. 25.00



49 Pass 8A-16852ea. 6.50
 50 Pass 0A-16852ea. 6.50
 51 Pass 1A-16852ea. 6.50

Hood Release Handle

37 Pass 78-8215ea. 80.00

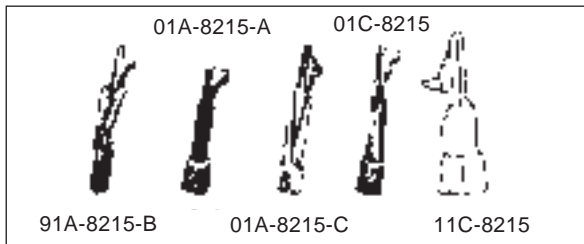

39 Dlx Pass 91A-8215-Bea. 45.00
 40 Std Pass 01A-8215-Aea. 45.00
 40 Dlx Pass 01A-8215-Cea. 45.00
 40 PU 01C-8215ea. 45.00
 41 PU 11C-8215ea. 45.00

Hood Release Handle and Base

37 Pass 78-8218-Kkit. 160.00



39 Std Pass 91A-8218-AKkit. 350.00

Hood Release Handle Pin

39-40 Pass 91A-2466ea. 5.50
 40-41 PU 91A-2466ea. 5.50

Hood Release Handle Base



37 Pass 78-8218ea. 36.00

Hood Release Handle Base Pad

37 Pass 78-8227ea. 2.00
 38 Std Pass 81A-8227-Aea. 2.00
 38 Dlx Pass 81A-8227-Bea. 2.00

Hood Ornament Hardware Kit



39-40 Pass 91A-8219kit. 15.00
 40-41 PU 91A-8219kit. 15.00

SEALS/BUMPERS

Hood Bumper Kit

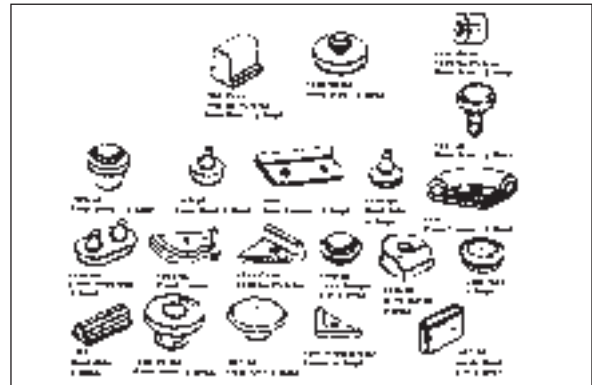

32 Pass B-16761kit. 11.00
 33-34 Pass 40-16761kit. 20.00
 35 Pass 48-16761kit. 11.00
 36 Pass 68-16761kit. 11.00
 37 Pass 78-16761kit. 11.00
 38 Pass 81A-16761kit. 11.00
 39 Std Pass 81A-16761kit. 11.00
 39 Dlx Pass 91A-16761kit. 11.00
 40 Pass 91A-16761kit. 11.00
 41-48 Pass 11A-16761kit. 11.00
 49 Pass 8A-16761kit. 7.50
 50-51 Pass 0A-16761kit. 10.00

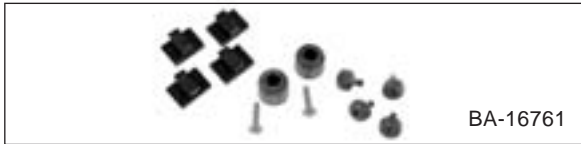

52-54	Pass	BA-16761kit.	15.00
55-56	Pass	B5A-16761kit.	16.50
40	Merc	91A-16761kit.	11.00
41-48	Merc	11A-16761kit.	11.00
49-51	Merc	8M-16761kit.	8.00
56	T-Bird	B6S-16758-Bkit.	6.25
32-34	PU	B-16761kit.	11.00
35-37	PU	48-16761kit.	11.00
38	PU	81A-16761kit.	11.00
39	PU	81A-16761kit.	11.00
40-41	PU	01C-16761kit.	11.00
42-47	PU	21C-16761kit.	10.00
48-52	PU	7C-16761kit.	8.00
53-56	PU	BAAA-16761kit.	11.00

Hood Adjusting Bumpers



55-56	Pass	B5A-16769pr.	7.00
-------	------	-----------	----------	------

Hood Corners

28-32	Pass & PU	A-16622-LS, leatherset.	4.00
28-32	Pass & PU	A-16622-RS, rubberset.	4.00

Hood Side Center Rest Brackets

Made of polished stainless steel. Keeps the lower center of the hood from bowing in. Mounts on top of frame. Hood bumper is NOT included.



32	Pass	B-16761-SSpr.	25.00
32-34	PU	B-16761-SSpr.	25.00

Front Hood Bumper & Catch Bracket



36	Pass	68-16628-Kpr.	30.00
36	Pass	68-16628-KS, stainlesspr.	40.00

Rear Hood Bumper & Bracket



36	Pass	68-16759-Kpr.	20.00
36	Pass	68-16759-KS, stainlesspr.	30.00

Hood to Air Deflector Seal

48-52	PU	7C-16614, 36 1/2"ea.	5.00
-------	----	-------------------	----------	------

Hood to Radiator Seal

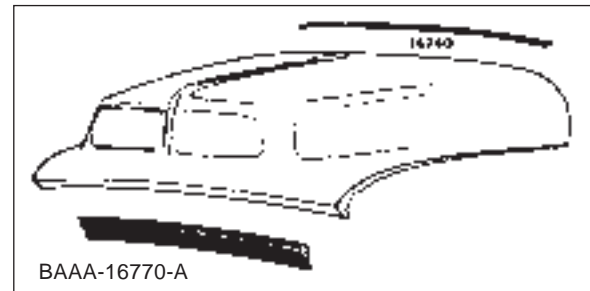

53-56	PU	BAAA-16770-Aea.	7.00
-------	----	--------------	----------	------

Hood to Top of Firewall (Cowl Lace)

Includes mounting hardware.

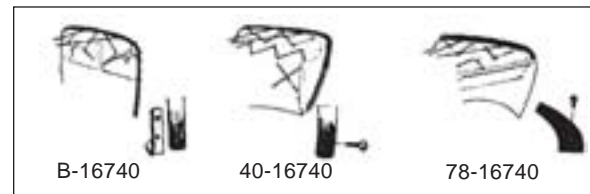

32	Pass	B-16740kit.	13.00
33-34	Pass	40-16740kit.	13.00
35	Pass	48-16740kit.	12.00
36	Pass	68-16740kit.	10.00
37-40	Pass	78-16740kit.	10.00
41-48	Pass	11A-16740kit.	10.00
49-51	Pass	8A-16740-Bkit.	7.00
52-54	Pass	BA-16740-Bkit.	8.50
55-56	Pass	B5A-16740ea.	7.00
39-40	Merc	99A-16740kit.	15.00
41-48	Merc	11A-16740kit.	10.00
49-51	Merc	8M-16740kit.	8.00
55-56	Merc	BN-16740kit.	15.00
32-34	PU	B-16740kit.	13.00
35-37	PU	48-16740kit.	12.00
38-41	PU	78-16740kit.	10.00
42-56	PU	21C-16740kit.	15.00

Section 29 Running Board

RUNNING BOARD

Running Boards with Vulcanized Rubber

Top quality reproduction ready to mount to your car with all mounting holes drilled. Mounting hardware is NOT included.

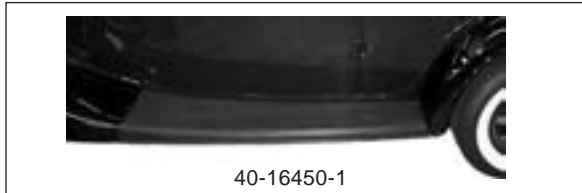

*32	Pass	B-16450/1-RB&CVR.....pr.	650.00
*33-34	Pass	40-16450/1pr.	995.00
*35-36	Pass	48-16450/1-BDpr.	995.00
37-38	Pass	78-16450/1-BDpr.	995.00
39	Std Pass	78-16450/1-BDpr.	995.00
*39	Dlx	91A-16450/1-BDpr.	995.00
*40	Pass	91A-16450/1-BDpr.	995.00
*32	PU	B-16450/1-RB&CVR.....pr.	650.00

Steel Running Boards

*35-36	Pass	48-16450-BR.....pr.	285.00
*39	Dlx Pass	01A-16450/1, Mfg by Drake.....pr.	495.00
*40	Pass	01A-16450/1, Mfg by Drake.....pr.	495.00
*42-48	Pass	21A-16450-NC.....pr.	225.00
*42-48	Merc	21A-16450-NC.....pr.	225.00
35-37	PU	50-16450/1-W, with spare tire well in RH running board.....pr.	850.00
35-37	PU	50-16450/1, without spare tire well in RH running board.....pr.	850.00
38-39	PU	81C-16450-PR.....pr.	500.00
*40-41	PU	01C-16450/1, 1/2 ton.....pr.	625.00
*48-52	PU	7C-16450-PR, F-1.....pr.	560.00
*53-56	PU	BAAA-16450-B, F100, RH.....ea.	300.00
*53-56	PU	BAAA-16451-B, F100, LH.....ea.	300.00

Smooth Steel Running Boards

Perfect for a street rod for that smooth look without rubber covers

*32	Pass	B-16450-SM.....pr.	220.00
*33-34	Pass	40-16450-SMpr.	345.00
*35-36	Pass	48-16450-SMpr.	285.00
*37-38	Pass	78-16450-SMpr.	350.00
*39	Std Pass	78-16450-SMpr.	350.00
*42-48	Pass	21A-16450-SMpr.	248.00
*42-48	Merc	21A-16450-SMpr.	248.00
*48-52	PU	7C-16450-SM, F-1.....pr.	560.00

Running Board Covers

Glue sold separately

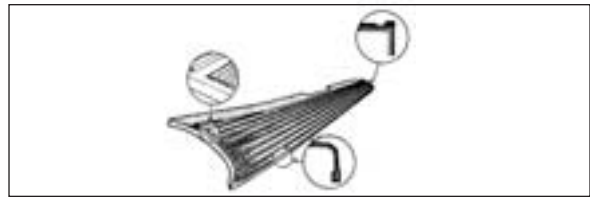

32	Pass	B-16450-PRpr.	220.00
33-34	Pass	40-16450-PRpr.	220.00
35-36	Pass	48-16450/1pr.	235.00
37-38	Pass	78-16450/1pr.	235.00
39	Std Pass	78-16450/1pr.	235.00
39	Dlx Pass	91A-16450/1pr.	250.00
40	Pass	91A-16450/1pr.	250.00
41	Pass	11A-16450-PRpr.	220.00
42-48	Pass	21A-16450/1pr.	235.00
39-40	Merc	RB-3301pr.	520.00
41	Merc	11A-16450-PRpr.	220.00
42-48	Merc	21A-16450/1pr.	235.00
32	PU	B-16450-PRpr.	220.00

Running Board Glue

Cannot be shipped air or overseas.

All	G-16450, 1 pint.....ea.	16.50
-----	-------------------------	-------

BOLTS AND GROMMETS

Running Board Bolt Kit

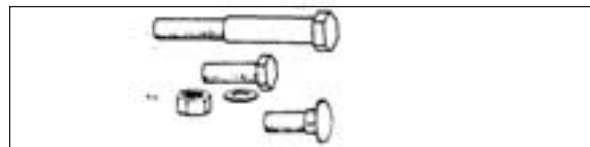

32	Pass	3205, black.....kit.	15.00
33-34	Pass	3210, black.....kit.	16.00
37-40	Pass	7C-16455-S, blackkit.	10.00
37-40	Pass	7C-16455-SS, stainlesskit.	23.00
32	PU	3205, black.....kit.	15.00
37-41	PU	7C-16455-S, blackkit.	10.00
37-41	PU	7C-16455-SS, stainlesskit.	23.00
48-52	PU	7C-16455-S, blackkit.	10.00
48-52	PU	7C-16455-SS, stainlesskit.	23.00
53-56	PU	BAAA-16455-S, black.....kit.	10.00
53-56	PU	BAAA-16455-SS, stainless.....kit.	33.00

Running Board Bolt

35-48	Pass	78-16453, blackea.	.75
37-41	PU	78-16453, blackea.	.75
48-52	PU	78-16453, blackea.	.75



Running Board to Fender Spacer & Bolt

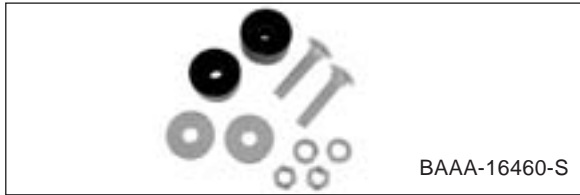

BAAA-16460-S

53-56 PU BAAA-16460-S, included in black bolt kit.....set. 3.50

Running Board to Frame Grommet Kit

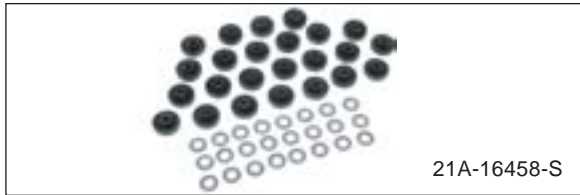

21A-16458-S

42-48 Pass 21A-16458-S.....kit. 20.00
 42-48 Merc 21A-16458-S.....kit. 20.00

Running Board to Frame Welting Kit

Pre-cut welting to mount the running board to the frame.

37-40 Pass 91A-5010-Ckit. 30.00

BRACES

Running Board Braces



40-16485-S

32 Pass B-16485-S, 4 pcs.set. 35.00
 33-34 Pass 40-16485-S, 4 pcs.set. 30.00

SEAL

Running Board to Cab Seal

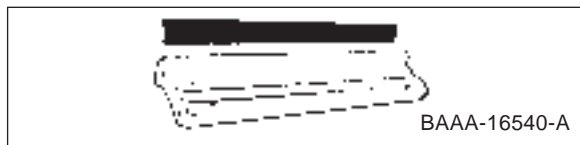

BAAA-16540-A

53-55 PU BAAA-16540-Apr. 20.00
 56 PU B6C-16540pr. 15.00
 53-56 Panel BAAA-16540-Cpr. 25.00

Running Board to Rear Fender Seal

48-52 Panel 7C-8227838/39-Aea. 52.50

STEP PLATES

Running Board Step Plate with Ford Logo



All Pass & PU A-16400-BSpr. 63.00

Running Board Step Plate with F-100 Crest



BAAA-16400

48-56 PU BAAA-16400pr. 55.00

Running Board Step Plate Mounting Kit

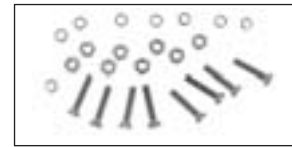

All Pass & PU A-16400-MBKkit. 3.00

**Section 30
Wiper**

WIPER MOTORS

Rebuilt Wiper Motor

Are you keeping your old Ford stock? Is your stock vacuum wiper motor giving you problems? We can help. We can have your original vacuum wiper motor rebuilt. Please allow two-four weeks for rebuilding.



32-62 Pass & PU RE-17508ea. 145.00

Vacuum Wiper Motor Repair Kit

32-40 Pass A-17510-S, old stockkit. 30.00
 32-47 PU A-17510-S, old stockkit. 30.00

Electric Wiper Motor 6 Volt

Our 6V 2-speed wiper motors come complete with switch and everything you need to install them where your vacuum wiper was originally.



40	Pass	01A-17508-HD6ea.	175.00
41-42	Pass	11A-17508-HD6, cannot use stock radioea.	175.00
46-48	Pass	51A-17508-HD6ea.	175.00
48-50	PU	7C-17508-HD6ea.	175.00
51-52	PU	1C-17508-HD6ea.	175.00

Electric Wiper Motor 12 Volt

Our 12V 2-speed wiper motors come complete with switch and everything you need to install them where your vacuum wiper was originally. For 1949-50 Pass and 1952-56 Pass use #B5A-17470-EXT to use original wiper knob and to mount new switch in the dash.



37-39	Pass	78-17508-12V, conv., cabriolet, wagonea.	219.95
39	Pass	91A-17508-12V, coupe, sedanea.	219.95
40	Pass	01A-17508-12Vea.	195.00
41-42	Pass	11A-17508-HD12, cannot use stock radioea.	195.00
46-48	Pass	21A-17508-12Vea.	195.00
49-50	Pass	8A-17508-12Vea.	219.95
49-50	Wagon	8A-17508-W12Vea.	219.95
51	Pass	1A-17508-12Vea.	219.95
51	Wagon	1A-17508-W12Vea.	219.95
52-54	Pass	B2A-17508-12Vea.	219.95
55-56	Pass	B6A-17508-NPea.	219.95
39-40	Merc	99A-17508-12Vea.	219.95
41-42	Merc	11A-17508-HD12ea.	195.00
46-48	Merc	21A-17508-12Vea.	195.00
49	Merc	8M-17508-12Vea.	219.95
50	Merc	0M-17508-12Vea.	219.95
51	Merc	1M-17508-12Vea.	219.95
52-54	Merc	B2A-17508-12Vea.	219.95
55-56	Merc	B6A-17508-NPea.	219.95

40-48	Lincoln	2GH-17508-12Vea.	219.95
49	Lincoln	8H-17508-12Vea.	219.95
50-51	Lincoln	1H-17508-12Vea.	219.95
55-57	T-Bird	B5S-17508-12Vea.	219.95
48-50	PU	7C-17508-HD12, mfg by Vintiqueea.	175.00
48-50	PU	7C-17508-NP, mfg by Newportea.	219.95
51-52	PU	1C-17508-HD12, replaces vacuumea.	175.00
51-52	PU	1C-17508-ENP, replaces electricea.	245.00
53-55	PU	BAAA-17508ea.	150.00
56-60	PU	B6C-17508-Aea.	150.00
56-60	PU	B6C-17508-NP, made by Newportea.	219.95

"Newport" Tandem Wiper Kit

Complete 12 volt wiper system. Includes 2 speed wiper motor with switch, wiper transmissions, linkage arms, mounting bracket, and plain steel wiper arms and blades. Uses the stock wiper holes, which you enlarge to 5/8". Instructions included.

37	Cpe/Sdn	78-17508-CSea.	399.00
38	Cpe/Sdn	81A-17508-CSea.	399.00
32-34	PU	46-17508-Tea.	399.00



40-47	PU	01C-17508-NPea.	425.00
-------	----	--------------	----------	--------

"Drake" Electric Tandem Wiper Kit

Excellent for the driver or streetrod. Kit is complete with 12 volt 2 speed electric wiper motor and switch, stainless wiper arms and blades, mounting bracket, 1940 pass wiper towers, and instructions. NOTE; you will have to make holes in the cowl and fill the original wiper hole.

40-47	PU	01C-17508-Kea.	399.00
-------	----	-------------	----------	--------

Universal Electric Wiper Motor

Modifications are required for use in a coupe, sedan, or pick up.



32-36	Pass & PU	A-17508-E6, 6Vea.	45.00
32-36	Pass & PU	A-17508-E12, 12Vea.	42.00



Stainless Universal Electric Wiper Motor

Modifications are required for use in a coupe, sedan, or pick up. Includes universal wiper arm and blade.

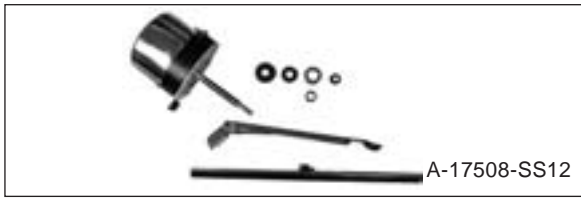

32-36	Pass & PU	A-17508-SS6V, 6V	ea.	50.00
32-36	Pass & PU	A-17508-SS12, 12V	ea.	50.00

Quick-Mount Wiper Motor Kit

No tools required to mount this unit to windshield frame. Fits rectangular profile frames. Includes Polished Stainless wiper arm and blade, wiring and hardware.

32-36	Roadster	SR-17508-SWK	kit.	145.00
-------	----------	--------------------	------	--------

Universal "Mighty Wiper" Wiper Motor

Replace your vacuum motor with this small compact motor available in 6 or 12 volt. Available in shaft lengths: 1", 1.5", 2", 2.5", and 3". To determine the shaft length, measure the thickness through the body and allow up to 1/2" additional length for mounting. Arm & blade length available is 10-1/4" or 12-1/4", from mounting to tip of blade. Please specify length of shaft & arm when ordering. Kit includes motor, bezel, wiper arm & blade, and instructions. Does NOT include on/off switch.



32-47	PU	HR-17508-6V	ea.	184.95
32-47	PU	HR-17508-12V	ea.	174.95

SWITCHES

Vacuum Wiper Motor Switch

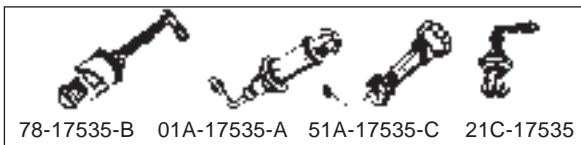

37	Conv	78-17535-B, light brown	ea.	40.00
37	Wagon	78-17535-B, light brown	ea.	40.00
38	Conv	81A-17535, ivory.....	ea.	40.00
38	Wagon	81A-17535, ivory.....	ea.	40.00
39	Conv	91A-17535, yellow	ea.	40.00
39	Wagon	91A-17535, yellow	ea.	40.00
40	Std Pass	01A-17535-A, sand	ea.	35.00
40	Dlx Pass	01A-17535-B, maroon.....	ea.	35.00

46	Super Dlx	51A-17535-B, blue gray	ea.	20.00
46	Super Dlx	51A-17535-C, gray tan	ea.	20.00
49-50	Pass	8A-17470-A, NOS, except wagon.....	ea.	50.00
47-48	Pass	51A-17535-C, gray tan	ea.	20.00
40-41	PU	01C-17535, tan	ea.	35.00
42-47	PU	21C-17535, black.....	ea.	35.00

Wiper Control Rod & Grommet



37-39	Conv	78-17537	ea.	4.00
37-39	Wagon	78-17537	ea.	4.00
40	Pass	01A-17537	ea.	4.00

Wiper Control Rod Grommet

Mounts in on-off switch and in wiper motor.

37-48	Pass	78-17577	ea.	1.00
39-48	Merc	78-17577	ea.	1.00
40-47	PU	78-17577	ea.	1.00

Electric Wiper Motor Switch

51-52	PU	8C-17470	ea.	20.00
53-56	PU	B6C-17470-A	ea.	45.00

Universal 12 Volt 2 Speed Wiper Switch

Includes black knob.

all	Pass & PU	SW-17508-HD	ea.	25.00
-----	-----------	-------------------	-----	-------

Wiper Switch Shaft Extension

For use with replacement electric wiper motors.



49-50	Pass	B5A-17470-EXT	ea.	22.00
52-56	Pass	B5A-17470-EXT	ea.	22.00
55-60	T-Bird	B5A-17470-EXT	ea.	22.00

TOWERS/PIVOTS

Windshield Wiper Tower Assembly

Complete assembly with drive arms, linkage to wiper motor with grommets, pivot bezels and nuts. Measures 18.5" between tower centers. Fits 1/2" hole in cowl. Will fit 1941-42 and early 46 with modification to the cowl. Will work with original vacuum or replacement electric motor.

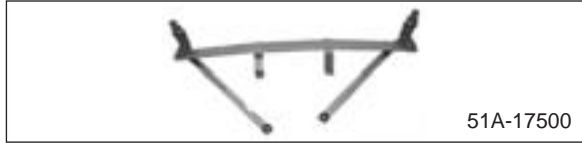

46-48	Pass	51A-17500, early 46ea.	150.00
46-48	Merc	51A-17500, early 46ea.	150.00

Wiper Tower Assembly

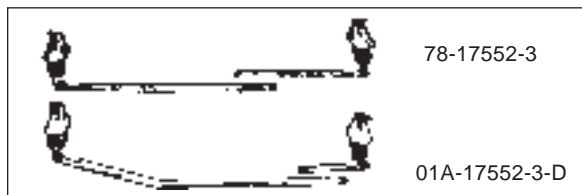

37-39	Conv	78-17552/3set.	150.00
37-39	Wagon	78-17552/3set.	150.00
40	Conv	01A-17552/3-Cset.	150.00
40	Cpe	01A-17552/3-Dset.	150.00
40	Sdn	01A-17552/3-Dset.	150.00
40	Wagon	01A-17552/3-Cset.	150.00
41	Sdn Dly	01A-17552/3-Dset.	150.00

Wiper Pivot Shaft Assembly



51-52	PU	7C-17566-A, RHea.	30.00
51-52	PU	7C-17567-A, LHea.	30.00
53-55	PU	BAAA-17566ea.	30.00
56	PU	B6C-17566ea.	30.00

Wiper Pivot Repair Kit

Includes 2 splined caps to replace worn or missing ones. Includes set screw to mount to the old pivot.



49-56	Pass	8A-17566-RKkit.	20.00
49-56	Merc	8A-17566-RKkit.	20.00
48-56	PU	8A-17566-RKkit.	20.00

PIVOT BEZELS/NUTS

Wiper Shaft Roof Grommet

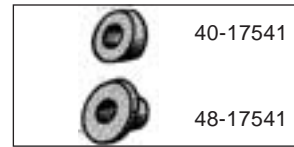

33-34	Pass	40-17541, exc. conv & wgnea.	3.00
35-36	Pass	48-17541, exc. conv & wgnea.	3.00

Wiper Tower Pads



37-40	Conv	78-17556pr.	4.50
37-40	Wagon	78-17556pr.	4.50
40	Pass	01A-17556, exc. conv & wgnpr.	4.50
41	Sdn Dly	01A-17556pr.	4.50

Wiper Pivot Shaft Bezel



37-39	Pass	78-17515ea.	8.00
41-48	Pass	11A-17515, small 3/8"pr.	15.00
47-48	Pass	7C-17515, large, 5/8"ea.	12.00
49-51	Pass	8A-17515, exc. wgnpr.	25.00



49-51	Wagon	8A-17515-B, includes nuts and padspr.	60.00
52-54	Pass	BA-17515pr.	25.00
55-56	Pass	B5A-17515pr.	25.00
41-48	Merc	11A-17515, small 3/8"pr.	15.00
47-48	Merc	7C-17515, large, 5/8"ea.	12.00
55-56	T-Bird	B5A-17515pr.	25.00
40-47	PU	01C-17515ea.	3.00
48-52	PU	7C-17515, largeea.	12.00
53-60	PU	BAAA-17515-Aea.	7.50

Wiper Pivot Shaft Bezel Nut



47-48	Pass	356094-S, hex for 5/8"ea.	5.00
-------	------	------------------------	----------	------



49-56	Pass	356094-S, hex.....ea.	5.00
47-48	Merc	356094-S, hex for 5/8".....ea.	5.00
49-56	Merc	356094-S.....ea.	5.00
48-60	PU	356094-S, hex.....ea.	5.00
56	PU	356095-S, round.....ea.	5.50

Wiper Pivot Shaft Bezel Pad



37-39	Pass	11A-17541.....pr.	3.00
41-48	Pass	11A-17541, small.....pr.	3.00
47-48	Pass	7C-17541, large.....pr.	3.00
49-51	Pass	8A-17541-A, exc. wgn.....pr.	3.00
49-51	Wagon	8A-17541-B.....pr.	3.00
52-58	Pass	BA-17541.....pr.	3.00
41-48	Merc	11A-17541, small.....pr.	3.00
47-48	Merc	7C-17541, large.....pr.	3.00
49-51	Merc	0M-17541.....pr.	11.00
49-51	Merc	8M-17541-B, rubber, w/squirters.....pr.	12.00
37-47	PU	11A-17541.....pr.	3.00
48-52	PU	7C-17541.....pr.	3.00
53-60	PU	BAAA-17541.....pr.	3.00

WIPER ARMS

Original Style Stainless Wiper Arm

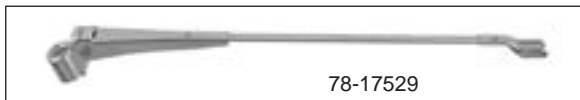

32-36	Pass	B-17529, mfg by Drake.....ea.	25.00
32-36	Pass	B-17529-SS, mfg by Vintique.....ea.	11.00
37-39	Pass	78-17529, mfg by Drake, exc. conv & wgn.....ea.	25.00
37-39	Pass	78-17529-SS, mfg by Vintique exc. conv & wgn.....ea.	16.00
37-39	Conv	01A-17526, mfg by Drake.....ea.	25.00
37-39	Conv	01A-17529-SS, mfg by Vintique.....ea.	16.00
37-39	Wgn	01A-17526, mfg by Drake.....ea.	25.00
37-39	Wgn	01A-17529-SS, mfg by Vintique.....ea.	16.00
40	Pass	01A-17526, mfg by Drake.....ea.	25.00
40	Pass	01A-17529-SS, mfg by Vintique.....ea.	16.00
41-48	Pass	11A-17526, RH, mfg by Drake...ea.	25.00
41-48	Pass	11A-17526-SS, RH, mfg by Vintique.....ea.	16.00
41-48	Pass	11A-17527, LH, mfg by Drake...ea.	25.00
41-48	Pass	11A-17527-SS, LH, mfg by Vintique.....ea.	16.00
41-48	Merc	11A-17527, LH, mfg by Drake...ea.	25.00
41-48	Merc	11A-17527-SS, LH, mfg by Vintique.....ea.	16.00
41-48	Merc	11A-17526, RH, mfg by Drake...ea.	25.00

41-48	Merc	11A-17526-SS, RH, mfg by Vintique.....ea.	16.00
32-36	PU	B-17529, mfg by Drake.....ea.	25.00
32-36	PU	B-17529-SS, mfg by Vintique.....ea.	11.00
37-39	PU	78-17529, mfg by Drake.....ea.	25.00
37-39	PU	78-17529-SS, mfg by Vintique.....ea.	16.00
40-47	PU	01C-17527, LH, mfg by Drake...ea.	25.00
40-47	PU	01C-17527-SS, LH, mfg by Vintique.....ea.	16.00
40-47	PU	01C-17526, RH, mfg by Drake...ea.	25.00
40-47	PU	01C-17526-SS, RH, mfg by Vintique.....ea.	16.00

Replacement Wrist Type Stainless Wiper Arm

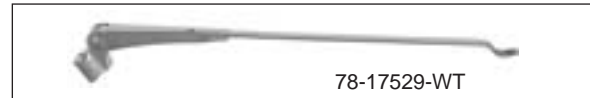

37-39	Pass	78-17529-WT, exc. conv & wgn.....ea.	16.00
37-39	Conv	01A-17529-WT.....ea.	16.00
37-39	Wgn	01A-17529-WT.....ea.	16.00
40	Pass	01A-17529-WT.....ea.	16.00
41-48	Pass	11A-17526-WT, RH.....ea.	16.00
41-48	Pass	11A-17527-WT, LH.....ea.	16.00
49-51	Pass	8A-17526, RH.....ea.	17.00
49-51	Pass	8A-17527, LH.....ea.	17.00
52-56	Pass	B6C-17526-A, RH.....ea.	16.00
52-56	Pass	BD-17527-A, LH.....ea.	16.00
41-48	Merc	11A-17526-WT, RH.....ea.	16.00
41-48	Merc	11A-17527-WT, LH.....ea.	16.00
37-39	PU	78-17529-WT.....ea.	16.00
40-47	PU	01C-17526-WT, RH.....ea.	16.00
40-47	PU	01C-17527-WT, LH.....ea.	16.00
48-52	PU	1C-17526.....ea.	16.00
53-55	PU	BD-17527-A.....ea.	16.00
56-60	PU	BD-17527-A, LH.....ea.	16.00
56-60	PU	B6C-17526-A, RH.....ea.	16.00

Wiper Arm Nuts



37-40	Pass	78-17481.....pr.	6.00
37-47	PU	78-17481.....pr.	6.00

Universal Chrome Hand Wiper with Blade



32	Pass & PU	A-17655-AR.....ea.	25.00
----	-----------	--------------------	-------

Tandem Wiper Arm Kit

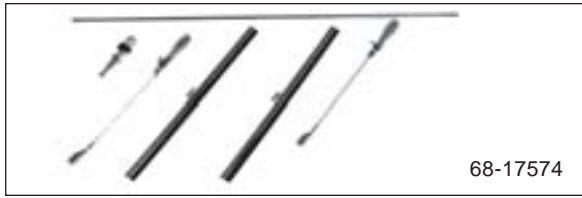

68-17574

32-36 Pass & PU 68-17574set. 29.00

BLADES

Original Style Stainless Wiper Blade



21A-17528

28-40	Pass	78-17528-B, 8.25"ea.	10.00
41-48	Pass	21A-17528, 9"ea.	10.00
32-48	Pass	C-17528, 10" universalea.	4.50
39-40	Merc	78-17528-B, 8.25"ea.	10.00
41-48	Merc	21A-17528, 9"ea.	10.00
28-47	PU	78-17528-B, 8.25"ea.	10.00
32-47	PU	C-17528, 10" universalea.	4.50

Wrist Style Stainless Wiper Blade

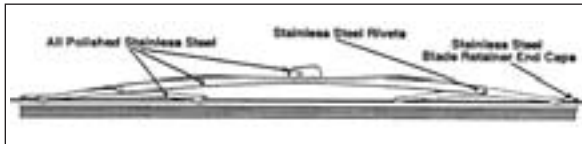

32-40	Pass	SR-17528, 6" universalea.	16.00
37-40	Pass	78-17528, 8-1/4"ea.	16.00
41-48	Pass	A8C-17528-A, 10"ea.	16.00
49-56	Pass	8A-17528, 11"ea.	16.00
55-58	Pass	B8AB-17528-A, 12"ea.	16.00
41-48	Merc	A8C-17528-A, 10"ea.	16.00
32-47	PU	SR-17528, 6" universalea.	16.00
37-47	PU	78-17528, 8-1/4"ea.	16.00
48-52	PU	A8C-17528-A, 10"ea.	16.00
53-60	PU	B8AB-17528-A, 12"ea.	16.00

WIPER KITS

"Hot Rod" Wiper Arms and Blades

Sold in a set of 4 (2-arms, 2-blades)

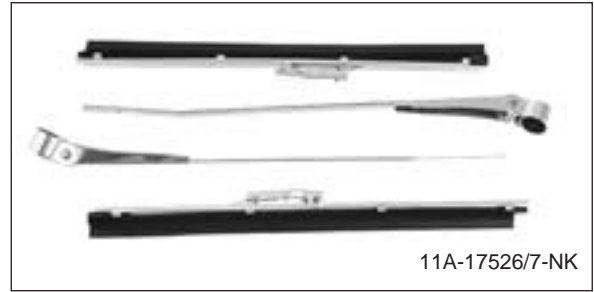

11A-17526/7-NK

37-39	Cpe	78-17526/7-NKkit.	69.00
37-39	Sdn	78-17526/7-NKkit.	69.00
37-40	Conv	01A-17526/7-NKkit.	69.00
37-40	Wagon	01A-17526/7-NKkit.	69.00
40	Cpe	01A-17526/7-NKkit.	69.00
40	Sdn	01A-17526/7-NKkit.	69.00
41-48	Pass	11A-17526/7-NKkit.	69.00
37-39	PU	78-17526/7-NKkit.	69.00
40-47	PU	01C-17526/7-NKkit.	69.00

"Hot Rod" Wiper Blade Refill

37-40	Pass	78-17528-RF, 8-1/4"ea.	5.00
41-48	Pass	21A-17528-RF, 9"ea.	5.00
37-47	PU	78-17528-RF, 8-1/4"ea.	5.00

MISC.

Vacuum Wiper Hose

28-36	Pass & PU	A-17543, 3/16"ft.	.75
37-60	Pass & PU	99A-17543, 1/4"ft.	.75

Metal Wiper Grommet



B-17511

32-36	Roadster	B-17511ea.	5.75
32-36	Phaeton	B-17511ea.	5.75
35-36	Wagon	B-17511ea.	5.75
32-34	PU	B-17511ea.	5.75

Vacuum Wiper Tube to Intake Manifold Brass Nut



91A-17542-A

33-40	Pass & PU	91A-17542-Akit.	2.50
-------	-----------	-------------	-----------	------

Wiper Arm to Wiper Motor Grommet



51A-17562

46-54	Pass	51A-17562ea.	2.00
46-54	Merc	51A-17562ea.	2.00



48-55 PU 51A-17562.....ea. 2.00

Wiper Arm to Wiper Motor Clip & Spring



37-48 Pass 78-17450.....ea. 2.50
 49-51 Pass 8A-17450.....ea. 2.50

Universal Wiper Arm Clip



All Pass & PU OGH-17531.....ea. 1.00

WINDSHIELD WASHER

Windshield Washer Reservoir Bag



54-59 Pass BM-17618.....ea. 27.50
 55-57 T-Bird BM-17618.....ea. 27.50

Windshield Washer Reservoir Bag Bracket

54-59 Pass BM-17651.....ea. 14.00

Windshield Washer Reservoir Bag Cap

54-59 Pass BM-17632-A.....ea. 5.00
 55-57 T-Bird BM-17632-A.....ea. 5.00

Windshield Washer Reservoir Bag Toptee



54-59 Pass BF-17615.....ea. 27.50

Windshield Washer Nozzle



52-56 Pass BA-17666-A.....ea. 15.00
 55-57 T-Bird B5S-17666-A.....ea. 15.00

**Section 31
Speedometer**

CABLE

Tech Tip: *Speedometer cables are shipped dry. They will need to be lubed with (B5A-19581-A) SPEEDO lube prior to installation.*

Speedometer Cable & Housing

Speedo cables require B5A-19581-A, lube. 1949-56 Pass and 1953-56 PU require 1 #72115 o-ring seal. Drive gear is not included.

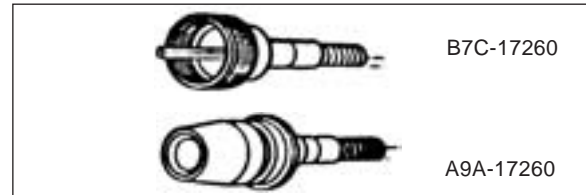

32-48 Pass B-17260-R.....ea. 15.00
 49-56 Pass A9A-17260, 3 speed with or without overdrive.....ea. 17.50
 51 Pass B1A-17260, with fordomatic.....ea. 25.00
 52-56 Pass A9A-17260, with automatic.....ea. 17.50
 39-48 Merc B-17260-R.....ea. 15.00
 49-56 Merc A9A-17260, 3 speed with or without overdrive.....ea. 17.50
 32-47 PU B-17260-R.....ea. 15.00
 48-52 PU B7C-17260, 3-speed.....ea. 20.00
 48-56 PU B7C-17260, 4-speed.....ea. 20.00
 53-56 PU A9A-17260, except 4 speed.....ea. 17.50

Speedometer Cable "O" Ring

49-56 Pass & PU 72115.....ea. 1.75

Speedometer Inner Cable

32-64 Pass & PU B9AZ-17262-A, 120".....ea. 12.00

Speedometer Cable Bracket



39-40 Pass 99A-17263, , mounts to frame.....ea. 10.00
 52-53 Pass 8A-7713, with auto, holds cable to steering column.....ea. 5.00
 39-40 Merc 99A-17263, , mounts to frame.....ea. 10.00
 39-41 PU 99A-17263, , mounts to frame.....ea. 10.00

Speedometer Cable Lube

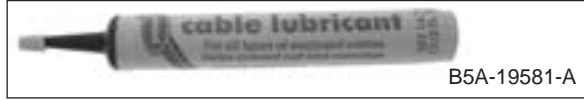

B5A-19581-A

All	Pass	B5A-19581-A	ea.	5.00
All	PU	B5A-19581-A	ea.	5.00

DRIVE GEAR

Speedometer Drive Replacement Gear

Must use old housing. Use 19 teeth gear with 3.78 gears, and use 18 teeth gear with 3.54 gears. Will not work in #21 housing.

28-48	Pass	AA-17271-D, 19 teeth	ea.	14.00
28-48	Pass	AA-17271-E, 18 teeth	ea.	14.00
39-48	Merc	AA-17271-D, 19 teeth	ea.	14.00
39-48	Merc	AA-17271-E, 18 teeth	ea.	14.00
28-41	PU	AA-17271-D, 19 teeth	ea.	14.00
28-41	PU	AA-17271-E, 18 teeth	ea.	14.00

Speedometer Drive Gear on Driveshaft

32-48	Pass	B-17285, NOS	ea.	30.00
39-48	Merc	B-17285, NOS	ea.	30.00
32-41	PU	B-17285, NOS	ea.	30.00

Speedometer Gear Snap Ring



B-17286

28-48	Pass	B-17286	ea.	1.25
39-48	Merc	B-17286	ea.	1.25
28-41	PU	B-17286	ea.	1.25

Speedometer Gear Thrust Washer

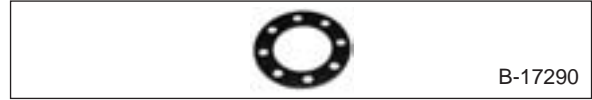

B-17290

28-48	Pass	B-17290	ea.	3.00
39-48	Merc	B-17290	ea.	3.00
28-41	PU	B-17290	ea.	3.00

Speedometer Drive Gear to Torque Tube Gasket



B-17275

28-48	Pass	B-17275	ea.	.50
39-48	Merc	B-17275	ea.	.50
28-41	PU	B-17275	ea.	.50

Speedometer Cable Drive Gear

49-56	Pass	B5A-17322-C, 19 teeth	ea.	10.00
-------	------	-----------------------------	-----	-------



B5A-17322-A

49-56	Pass	B5A-17322-A, 20 teeth	ea.	10.00
49-56	Pass	B5A-17322-B, 21 teeth	ea.	10.00
49-56	Pass	B5A-17322-D, 22 teeth	ea.	10.00
53-56	PU	B5A-17322-C, 19 teeth	ea.	10.00
53-56	PU	B5A-17322-A, 20 teeth	ea.	10.00
53-56	PU	B5A-17322-B, 21 teeth	ea.	10.00
53-56	PU	B5A-17322-D, 22 teeth	ea.	10.00

1949 Mercury



Arnold Patz



Section 32 Mirrors

INSIDE MIRROR & BRACKET

Rear View Mirror & Bracket Original Style

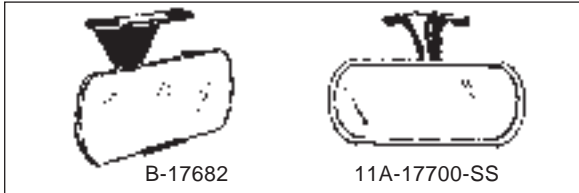

32	Roadster	B-17681-SS, stainless.....ea.	40.00
32	Phaeton	B-17681-SS, stainless.....ea.	40.00
32-34	Cabriolet	B-17690, stainless.....ea.	50.00
32-34	Conv Sdn	B-17690, stainless.....ea.	50.00
32-36	Cpe	B-17682, brown.....ea.	50.00
32-36	Cpe	B-17682-SS, stainless.....ea.	42.00
32-36	Sdn	B-17682, brown.....ea.	50.00
32-36	Sdn	B-17682-SS, stainless.....ea.	42.00
33-36	Roadster	40-17681-SS, stainless.....ea.	39.00
33-36	Phaeton	40-17681-SS, stainless.....ea.	39.00
35-36	Cabriolet	48-17690-SS, stainless.....ea.	45.00
35-36	Conv Sdn	48-17690-SS, stainless.....ea.	45.00
37-39	Conv	78-17690, brown.....ea.	55.00
37-39	Conv	78-17681-SS, stainless.....ea.	55.00
37-39	Cpe	78-17682, brown.....ea.	44.00
37-39	Cpe	78-17682-SS, stainless.....ea.	55.00
37-39	Sdn	78-17682, brown.....ea.	44.00
37-39	Sdn	78-17682-SS, stainless.....ea.	55.00
37-39	Wagon	78-17690, brown.....ea.	55.00
37-39	Wagon	78-17681-SS, stainless.....ea.	55.00
40	Cpe	01A-17682, brown.....ea.	44.00
40	Cpe	01A-17682-SS, stainless.....ea.	60.00
40	Sdn	01A-17682, brown.....ea.	44.00
40	Sdn	01A-17682-SS, stainless.....ea.	60.00
41-48	Pass	11A-17700-SS, stainless.....ea.	35.00
52-54	Pass	BAAA-17000, stainless.....ea.	55.00
55-56	Pass	B6A-17000, stainless.....ea.	55.00
41-48	Merc	11A-17700-SS, stainless.....ea.	35.00
32-36	PU	B-17682, brown.....ea.	50.00
32-36	PU	B-17682-SS, stainless.....ea.	42.00
40-52	PU	11A-17700-SS, stainless.....ea.	35.00



53-55	PU	BAAA-17000, stainless.....ea.	55.00
56	PU	B6A-17000, stainless.....ea.	55.00

Rear View Mirror & Bracket w/Oval Head

Not original for 1932-35, or 1941-48.

32	Roadster	B-17681-SR, stainless.....ea.	45.00
32	Phaeton	B-17681-SR, stainless.....ea.	45.00
32-34	Cabriolet	B-17690-SR, stainless.....ea.	65.00
32-34	Conv Sdn	B-17690-SR, stainless.....ea.	65.00
32-36	Cpe	B-17682-SR, stainless.....ea.	45.00
32-36	Sdn	B-17682-SR, stainless.....ea.	45.00
33-36	Roadster	40-17681-SR, stainless.....ea.	47.00
33-36	Phaeton	40-17681-SR, stainless.....ea.	47.00
35-36	Cabriolet	48-17690-SR, stainless.....ea.	60.00
35-36	Conv Sdn	48-17690-SR, stainless.....ea.	60.00



41-48	Pass	11A-17700-SR, stainless.....ea.	47.00
32-36	PU	B-17682-SR, stainless.....ea.	45.00
40-52	PU	11A-17700-SR, stainless.....ea.	47.00

INSIDE MIRROR

Inside Mirror Glass



32-36	Pass & PU	B-17681-MG, beveled.....ea.	9.00
32-36	Pass & PU	B-17681-SG, stainless back with stainless bead around edge of mirror.....ea.	20.00

Stainless Oval Inside Mirror Head



37-41	Pass	68-17682-MHSS.....ea.	30.00
39-41	Merc	68-17682-MHSS.....ea.	30.00
37-47	PU	68-17682-MHSS.....ea.	30.00

Inside Mirror Head and Arm

Bracket is NOT included.

53-56	Pass	B5A-17700-R.....ea.	34.95
-------	------	---------------------	-------

Accessory Sun Visor Mirror

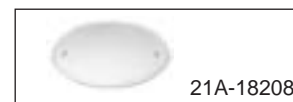

35-37	Pass & PU	48-17676.....ea.	55.00
42-49	Pass & PU	21A-18208.....ea.	55.00

INSIDE MIRROR BRACKET

Inside Mirror Bracket

For oval head mirror only



35-36	Cabriolet	68-17690, stainlessea.	25.00
35-36	Conv Sdn	68-17690, stainlessea.	25.00
35-36	Cpe	68-17690-C, chromeea.	25.00
35-36	Sdn	68-17690-C, chromeea.	25.00
37-39	Conv	78-17690-B, bronzeea.	23.00
37-39	Conv Sdn	78-17690-B, bronzeea.	23.00
37-39	Cpe	78-17690-P, brownea.	25.00
37-39	Sdn	78-17690-P, brownea.	25.00
37-39	Wgn	78-17690-B, bronzeea.	23.00

Inside Mirror Bracket Screws

52-56	Pass	52353-SS, 3 pcs.set.	1.20
48-56	PU	52353-SS, 3 pcs.set.	1.20

OUTSIDE MIRROR

Windshield Post Mirror



32	Roadster	18-17700-Pea.	42.00
32	Phaeton	18-17700-Pea.	42.00

Hinge Pin Mirror

All mirrors include door hinge pin.

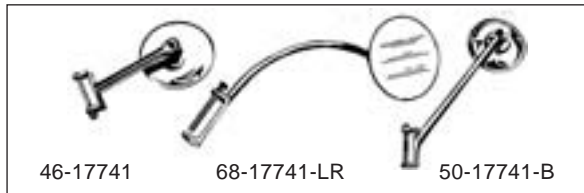

32	Cpe 5W	B-17741ea.	42.00
32	Sdn	B-17741ea.	42.00
35-40	Pass	68-17741-LR, curved arm, one set screwea.	35.00
35-40	Pass	48-18403, curved arm, conours correct, must drill and tap door hinge for set screwea.	60.00
32-34	PU	46-17741ea.	45.00
35-47	PU	50-17741-B, black armea.	55.00
35-47	PU	50-17741-C, chrome armea.	55.00



48-52	PU	8C-18402-A, RH, correct original type, all blackea.	75.00
48-52	PU	8C-18403-A, LH, correct original type, all blackea.	75.00
48-52	PU	48-18403, curved arm, NOT correct, door hinge needs modificationea.	60.00

Cowl Mount Mirror

Pad is included

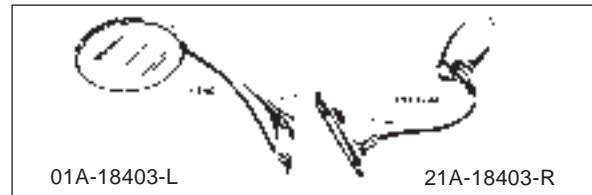

40	Pass	01A-18402-R, RHea.	65.00
40	Pass	01A-18403-L, LHea.	65.00
42-48	Pass	21A-18402-R, RHea.	65.00
42-48	Pass	21A-18403-L, LHea.	65.00
42-48	Merc	21A-18402-R, RHea.	65.00
42-48	Merc	21A-18403-L, LHea.	65.00

Cowl Mirror Pad

Not required if buying cowl mirror.

40	Pass	01A-18402-RP, RHea.	10.00
40	Pass	01A-18403-RP, LHea.	10.00
42-48	Pass	21A-18402-RP, RHea.	10.00
42-48	Pass	21A-18403-RP, LHea.	10.00

Door/Fender Mount Mirror w/Fomoco Logo

Triple chrome base w/polished stainless head. Logo is cast into base of mirror. Paper mounting pad included.

55-59	Pass	B5A-18402, 1 holeea.	75.00
55-59	Pass	B5A-18402-A, 2 holeea.	75.00
55-59	T-Bird	B5A-18402, 1 holeea.	75.00
55-59	T-Bird	B5A-18402-A, 2 holeea.	75.00

“Thank you to all at C&G for paying such prompt and efficient attention to my order for parts. The cartons cleared customs yesterday and were delivered today. And, thank you for the T-shirt - it looks really great.”
Kind Regards,
Terry M, Auckland



Door/Fender Mount Mirror

Mounting pad and screws are NOT included.



49-51	Pass	8A-18402.....ea.	45.00
52-56	Pass	B5A-17692-1, 1-hole.....ea.	49.95
52-56	Pass	B5A-17696-2, 2-hole.....ea.	45.00
55-59	Pass	B6A-17696, hooded rectangular.....ea.	139.95
55-57	T-Bird	B5A-17692-1, 1-hole.....ea.	49.95
55-57	T-Bird	B5A-17696-2, 2-hole.....ea.	45.00
53-66	PU	BAAA-17696-S, w/6 hole mounting bracket.....ea.	55.00

Outside Mirror Pad

49-51	Pass	8A-18402-P.....ea.	5.00
52-56	Pass	MP-996-E, rubber, use w/B5A mirrors.....ea.	8.00
52-56	Pass	17696-CR, paper, use w/B5A mirrors.....ea.	2.00

Outside Mirror Head

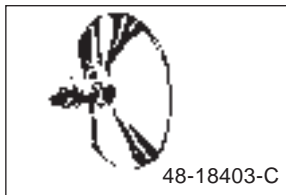

35-40	Pass	48-18403-C, 4", stainless.....ea.	30.00
35-47	PU	48-18403-C, 4", stainless.....ea.	30.00
35-52	PU	D1C-17723, 5" black, must grind mirror arm to work.....ea.	14.00
53-66	PU	BAAA-17696-MH, stainless.....ea.	22.00

Door Mount Mirror Arm

Fits original Ford mirrors only.

53-66	PU	B6C-17727-A.....ea.	18.00
-------	----	---------------------	-------

Door Mirror Arm Grommet

53-66	PU	BAAA-17699-S.....ea.	3.00
-------	----	----------------------	------

Door Mirror Hole Plug

53-66	PU	352488-S.....ea.	3.00
-------	----	------------------	------

Stainless Windwing Mirror



32-36	Pass	B-17700-WWC.....ea.	30.00
-------	------	---------------------	-------

UNIVERSAL OUTSIDE MIRROR

Edge of Door Peep Mirror



32-56	Pass & PU	HR-18414-L, curved arm, 3".....ea.	25.00
32-56	Pass & PU	A-17741-UL, straight arm, 4" head.....ea.	25.00
32-56	Pass & PU	B-18414-L, curved arm, 4" head.....ea.	25.00

Universal Aluminum Post Mirror



All	Pass & PU	BA-17700-L.....ea.	42.00
-----	-----------	--------------------	-------

Swan Neck Style Mirror

This is the type used on 1949-51 wagons. Mounts in the corner of the front door by removing the original blind nut. Must remove studs included with mirrors and replace with new bolts from a hardware store.



All	Pass & PU	HR-18414-PR, round head.....pr.	100.00
All	Pass & PU	HR-18402/3, oval head.....pr.	100.00

Section 33 Bumpers

BUMPERS

Tech Tip: When installing bumpers and braces on 33-40 cars and pickups, sandwich the frame with the inner and outer brackets, leave the outer brackets loose, line up the inner brackets first with holes in bumper, install bumper bolt nuts loose, tighten brackets, tighten bumper bolts.

Chrome Bumpers

Show quality chrome plated heavy gauge steel. Bumpers fit front and rear unless otherwise noted. Brackets are not included.

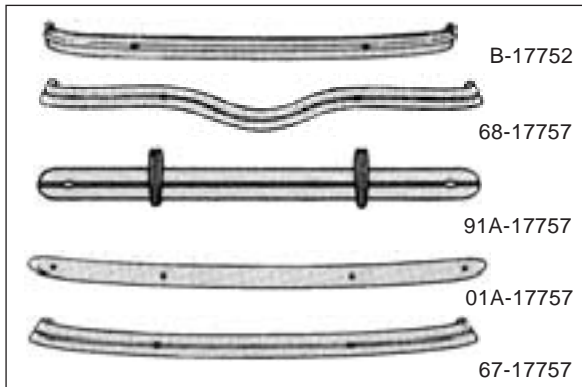

*32	Pass	B-17752ea.	335.00
*33	Pass	40-17757-Bea.	335.00
*34	Pass	40-17757ea.	335.00
*35	Pass	48-17757ea.	335.00
*36	Pass	68-17757ea.	335.00
*37	Pass	78-17757-F, frontea.	335.00
*37	Pass	78-17757-R, rearea.	335.00
*38	Pass	81A-17757ea.	335.00
*39	Std Pass	81A-17757ea.	335.00
*39	Dlx Pass	91A-17757ea.	335.00
*40	Pass	01A-17757ea.	335.00
*40	Pass	01A-17757-F, "Ford" scriptea.	350.00
*40	Pass	01A-17757-FL, rear, with "Ford" script 3rd brake lightea.	375.00
*42-46	Pass	21A-17757-CS, frontea.	Call
*42-46	Pass	51A-17781-C, rear, "Ford" script, except wagonea.	Call

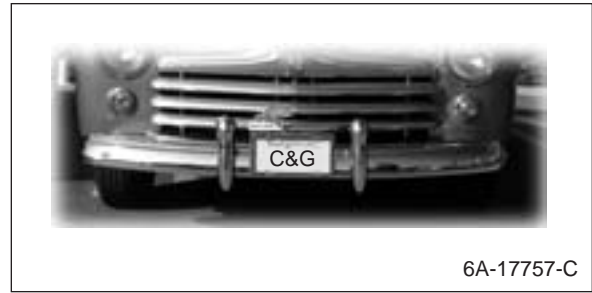

*47-48	Pass	6A-17757-C, frontea.	Call
*47-48	Pass	6A-17781-C, rear, except wagonea.	Call
*32	PU	B-17752ea.	335.00
*33	PU	46-17757-Bea.	335.00
*34	PU	46-17757ea.	335.00
*35	PU	50-17757ea.	335.00
*36	PU	67-17757ea.	335.00
*37	PU	78-17757-F, frontea.	335.00
*38-39	PU	81A-17757, frontea.	335.00
*37-39	PU	78-17757-F, rearea.	335.00
*40-41	PU	01A-17757, frontea.	335.00
*40-41	PU	01C-17757, rearea.	335.00
*48-52	PU	7C-17750-C, frontea.	225.00
*53-56	PU	TAAA-17750, frontea.	225.00
*48-72	PU	BBAA-17750, rearea.	225.00

Stainless Steel Bumpers

Bumpers fit front and rear unless otherwise noted. Brackets not included.

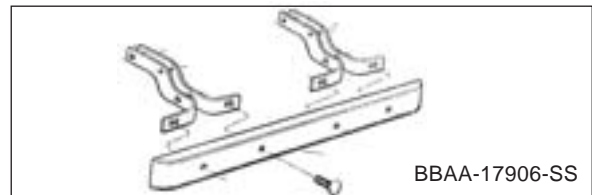

*33	Pass	40-17757-BSSea.	435.00
*34	Pass	40-17757-SSea.	435.00
*35	Pass	48-17757-SSea.	435.00
*36	Pass	68-17757-SSea.	435.00
*37	Pass	78-17757-FSS, frontea.	435.00
*37	Pass	78-17757-RSS, rearea.	435.00
*38	Pass	81A-17757-SSea.	435.00
*39	Std Pass	81A-17757-SSea.	435.00
*37	PU	78-17757-FSS, frontea.	435.00
*37-39	PU	78-17757-FSS, rearea.	435.00
*38-39	PU	81A-17757-SS, frontea.	435.00
*42-47	PU	21C-17757-SS, frontea.	385.00
*48-52	PU	7C-17750-SS, frontea.	335.00
*53-56	PU	TAAA-17750-SS, frontea.	325.00
*42-47	PU	BBAA-17906-SS, rear, w/bolts, must use 48-56 PU bracketsea.	325.00
*48-56	PU	BBAA-17906-SS, rear, w/boltsea.	325.00



Stainless Steel Bumpers Without Mounting Holes

Bumpers fit front and rear unless otherwise noted. Brackets not included.

*39	Dlx Pass	91A-17757-NHSS	ea.	385.00
*40	Pass	01A-17757-NHSS	ea.	385.00
*40-41	PU	01A-17757-NHSS, front only	ea.	385.00
*40-41	PU	01C-17757-NHSS, rear only	ea.	385.00
*42-47	PU	21C-17757-NHSS, front.....	ea.	385.00

Street Rod Style Chrome Bumper

Smooth type with studs welded on back side of bumper

*42-48	Pass	6A-17757-SC19, front.....	ea.	Call
*42-46	Pass	6A-17757-SC19, rear	ea.	Call
*47-48	Pass	6A-17757-SC32, rear	ea.	Call

Street Rod Style Bumper Plain Steel

Smooth type with studs welded on back side of bumper

*42-48	Pass	6A-17757-SR19, front.....	ea.	Call
*42-46	Pass	6A-17757-SR19, rear	ea.	Call
*47-48	Pass	6A-17757-SR32, rear	ea.	Call

Plain Steel Bumpers

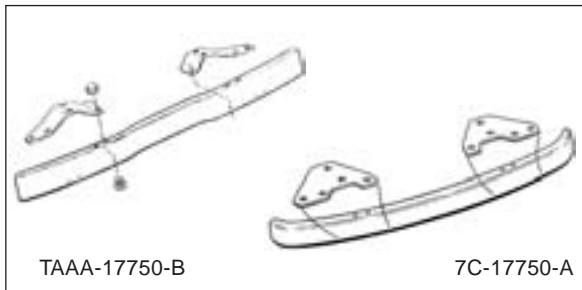

*42-46	Pass	21A-17757-R, front	ea.	Call
*47-48	Pass	6A-17757-R, front	ea.	Call
*47-48	Pass	6A-17781-R, rear, except wagon	ea.	Call
*48-52	PU	7C-17750-A, front	ea.	150.00
*53-56	PU	TAAA-17750-B, front	ea.	125.00
*48-56	PU	BBAA-17906-A, rear	ea.	125.00

BRACKETS/GROMMETS

Front Bumper Brackets

32	Pass	B-17754/5	set.	60.00
33	Pass	40-17766/7-B.....	set.	117.50
34	Pass	40-17766/7-C.....	set.	117.50
35	Pass	48-17766/7.....	set.	117.50
36	Pass	68-17766/7.....	set.	117.50
37	Pass	78-17766/7.....	set.	117.50
38-39	Pass	81A-17766/7.....	set.	117.50
39	Dlx Pass	91A-17766/7-B.....	set.	117.50
40	Std	01A-17766-AK, "Drake"	kit.	115.00
40	Dlx	01A-17766-BK, "Drake"	kit.	115.00
32	PU	B-17754/5	set.	60.00
33	PU	40-17766/7-B.....	set.	117.50
34	PU	40-17766/7-C.....	set.	117.50
35	PU	48-17766/7.....	set.	117.50
36	PU	68-17766/7.....	set.	117.50

37	PU	78-17766/7.....	set.	117.50
40-41	PU	01A-17766-AK, "Drake"	kit.	115.00
53-56	PU	TAAA-17766-B, black.....	set.	69.00
53-56	PU	TAAA-17766-C, chrome	set.	99.00

Polished Stainless Steel Front Bumper Brackets

32	Pass	B-17754-S-SS	set.	185.00
33	Pass	40-17766-7-BSS	set.	295.00
34	Pass	40-17766-7-CSS	set.	295.00
35	Pass	48-17766-7-SS.....	set.	295.00
36	Pass	68-17766-7-SS.....	set.	295.00
37	Pass	78-17766-7-SS.....	set.	295.00
40	Pass	01A-17766-7-SS.....	set.	295.00
32	PU	B-17754-S-SS.....	set.	185.00
33	PU	40-17766-7-BSS	set.	295.00
34	PU	40-17766-7-CSS	set.	295.00
35	PU	48-17766-7-SS.....	set.	295.00
36	PU	68-17766-7-SS.....	set.	295.00
37	PU	78-17766-7-SS.....	set.	295.00
40-41	PU	01A-17766-7-SS.....	set.	295.00

Polished Stainless "Short" Front Bumper Braces

Brings the bumper close to the front fenders.

32	Pass	B-17754-SS-SN.....	ea.	185.00
32	PU	B-17754-SS-SN.....	ea.	185.00

Front Bumper Arm Grommets

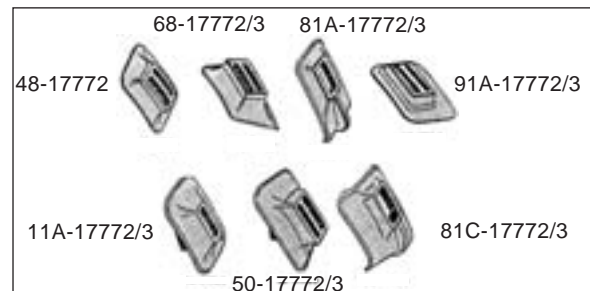

35	Pass	48-17772	pr.	12.00
36-37	Pass	68-17772/3	pr.	15.00
38	Std Pass	68-17772/3	pr.	15.00
38	Dlx Pass	81A-17772/3	pr.	15.00
39	Std Pass	81A-17772/3	pr.	15.00
39	Dlx Pass	91A-17772/3	pr.	15.00
40	Pass	91A-17772/3	pr.	15.00
41	Pass	11A-17772/3	pr.	20.00
35-37	PU	50-17772/3	pr.	15.00
38-39	PU	81C-17772/3.....	pr.	15.00
40-41	PU	91A-17772/3	pr.	15.00

Front Bumper Bracket Bolts

Bolts front bumper braces to frame. Front bolt has correct extension to mount radiator splash pan.

32	Pass	18-17766/7-S	set.	25.00
32-34	PU	18-17766/7-S	set.	25.00

Rear Bumper Brackets

32	Pass	B-17821/2, 2 pcs.....	set.	60.00
33	Pass	40-17787, except wagon.....	set.	60.00
34	Pass	40-17787-C, except wagon.....	set.	60.00

34	Victoria	40-17787-V.....set.	130.00
35	Pass	48-17787, except wagon.....set.	60.00
36	Pass	68-17787, except wagon.....set.	60.00
37	Pass	78-17787, except wagon.....set.	117.50
38-39	Std Pass	81A-17787, except wagon.....set.	117.50
39	Dlx Pass	91A-17787-B, except wagon.....set.	117.50
40	Pass	01A-17787, except wagon.....set.	117.50
36	PU	67-17787.....set.	117.50
37	PU	77-17787.....set.	117.50
38-41	PU	81C-17787.....set.	117.50
48-72	PU	B5C-17787/8-SET, black.....set.	125.00
48-72	PU	B5C-17787/8-CH, chrome.....set.	175.00

Polished Stainless Steel Rear Bumper Brackets

32	Pass	B-17821-2-SS, except wagon.....set.	185.00
37	Pass	78-17787-SS, except wagon.....set.	295.00
40	Pass	01A-17787-SS, except wagon.....set.	295.00

Steel "Shorty" Rear Bumper Braces

Shortened to bring bumper about 3" closer to body.

32	Pass	B-17821-CHP, chrome.....pr.	175.00
33	Pass	40-17787-ASH, bare steel.....pr.	95.00
34	Pass	40-17787-CSH, bare steel.....pr.	95.00
35-36	Pass	68-17787-SH, bare steel.....pr.	95.00

Polished Stainless "Shorty" Rear Bumper Braces

Shortened to bring bumper about 3" closer to body.

33	Pass	40-17766-SS.....pr.	185.00
34	Pass	40-17787-CSS.....pr.	185.00
35-36	Pass	68-17787-SS.....pr.	185.00

Rear Bumper Arm Grommets



34	Victoria	40-17792.....pr.	30.00
37	Pass	78-17792/3.....pr.	15.00
38-40	Cpe	78-17792/3.....pr.	15.00
38-40	Conv	78-17792/3.....pr.	15.00
38-40	Sdn	81A-17792/3.....pr.	15.00
40-41	Sdn Dly	01A-17792.....pr.	32.00
41	Pass	11A-17792/3C.....pr.	20.00
40	Merc	BG-100.....pr.	38.50

Rear Bumper Brace to Gas Tank Cover Pad



33-34	Pass	18-17792, 2 req.....ea.	8.00
-------	------	-------------------------	------

GUARDS

Bumper Guard

All bumper guards fit front or rear unless otherwise noted.

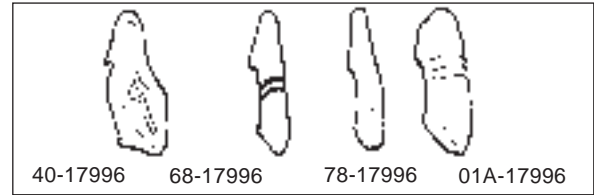

33-34	Pass	40-17996.....ea.	40.00
35	Pass	48-17996.....ea.	50.00
36	Pass	68-17996.....ea.	50.00
37	Pass	78-17996.....ea.	50.00
39	Dlx Pass	91A-17996.....ea.	50.00
40	Pass	01A-17996.....ea.	50.00
33-34	PU	40-17996.....ea.	40.00
35	PU	48-17996.....ea.	50.00
36	PU	68-17996.....ea.	50.00
37	PU	78-17996.....ea.	50.00
38-39	PU	78-17996, rear.....ea.	50.00
40	PU	01A-17996.....ea.	50.00

Bumper Wing Tips



40	Pass & PU	01A-18383, 4 pcs.....set4.	200.00
----	-----------	----------------------------	--------

BUMPER BOLTS

Bumper Bolt

Kit #40-17908-K will only fit original bumpers. For reproduction bumpers use #48-17758.

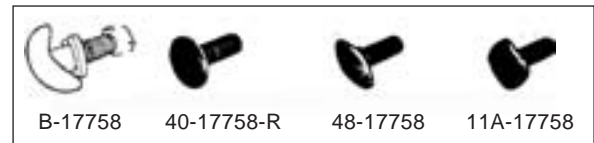

32	Pass	B-17758, SS cap.....ea.	20.00
33-40	Pass	48-17758, oval head, SS cap.....ea.	7.00
33-40	Pass	40-17908-K, large type, fits 1/2" square hole, 1-7/16" oval head.....kit.	60.00
41-48	Pass	11A-17758, 1-1/4" long.....ea.	15.00
49-70	Pass	B9A-17758, SS cap.....ea.	3.00
41-51	Wagon	11A-17758, rear bumper, 1-1/4" long.....ea.	15.00
39-40	Merc	48-17758, oval head, SS cap.....ea.	7.00
41-51	Merc	11A-17758, 1-1/4" long.....ea.	15.00
41-51	Merc Wgn	11A-17758, rear bumper, 1-1/4" long.....ea.	15.00

Section 33 - Bumpers



C&G Early Ford Parts, Inc.

52-70	Merc	B9A-17758, SS cap.....ea.	3.00
32	PU	B-17758, SS cap.....ea.	20.00
33-40	PU	48-17758, oval head, SS cap.....ea.	7.00
34-40	PU	40-17908-K, large type, fits 1/2" square hole, 1-7/16" oval head.....kit.	60.00
41-47	PU	11A-17758, 1-1/4" long.....ea.	15.00
48-56	PU	BB-17758, rear bumper, SS cap.....ea.	5.00

Bumper End Mounting Bolt

Goes on end of bumper to outer bumper bracket.

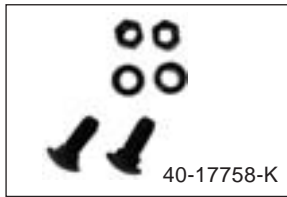

33-36	Pass & PU	40-17758-K, black.....kit.	12.00
33-36	Pass & PU	40-17758-KSS, polished stainless.....ea.	11.00

Bumper Guard Bolt

33-34	Pass	40-17758-R, round head.....ea.	7.50
42-46	Pass	21A-17908, angled head.....ea.	15.00
33-34	PU	40-17758-R, round head.....ea.	7.50

Stainless Bumper End Plug



32	Pass & PU	B-17760.....ea.	15.00
----	-----------	-----------------	-------

STONE DEFLECTOR

Rear Bumper Stone Deflector

Mounts between the bumper and bumper brackets.

39	Pass	91A-17816-OR.....ea.	175.00
40	Pass	01A-17816-OR.....ea.	175.00
40	Pass	01A-17816-SR, smooth.....ea.	175.00
41	Pass	11A-17816-OR.....ea.	175.00
41	Pass	11A-17816-SR, smooth.....ea.	175.00
41	Merc	19A-17816-OR.....ea.	175.00

Rear Body Stone Deflector



46-48	Pass	6A-17808, exc. wgn,3 pcs.....set.	250.00
46-48	Merc	6A-17808, exc. wgn,3 pcs.....set.	250.00

Rear Body Stone Deflector Kit



46-48	Wagon	6A-17808-B.....kit.	400.00
46-48	Merc Wgn	6A-17808-B.....kit.	400.00

Front Bumper Arm to Splash Pan Anti-Rattlers

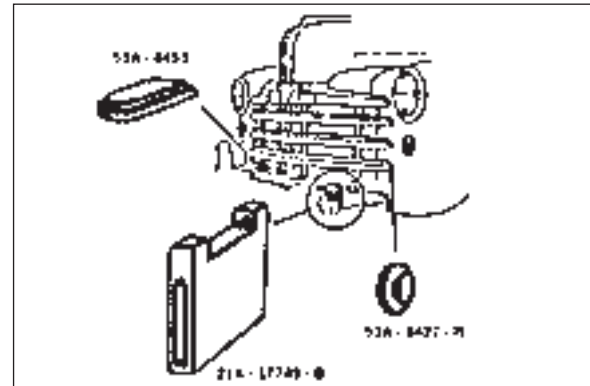

42-48	Pass	21A-17749-B.....set.	15.00
42-48	Merc	21A-17749-B.....set.	15.00

Front Stone Deflector Anti-Rattlers

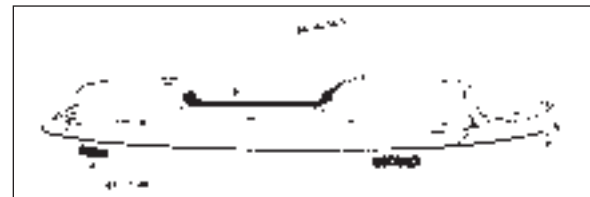

49	Pass	8A-17749.....kit.	4.00
50	Pass	0A-17749.....kit.	5.00
51-55	Pass	1A-17749.....kit.	5.00
56	Pass	B6A-17749.....kit.	3.50

Front Stone Deflector to Radiator Seal

55-56	Pass	B5A-17740, 19 3/4".....ea.	4.50
-------	------	----------------------------	------

Rear Bumper to Stone Deflector Seal



42-48	Pass	6A-17832-A.....ea.	15.00
49	Pass	8A-17832-A.....ea.	17.50
50-51	Pass	0A-17832.....ea.	10.00
52-54	Pass	BA-17832-B.....ea.	18.00
55-56	Pass	B5A-17832.....ea.	7.00
42-48	Merc	6A-17832-A.....ea.	15.00
49-51	Merc	1M-17832-A.....ea.	37.00

Section 34 Radio

RADIO

New Radio

All new tooling. All new chrome knobs, chrome buttons, dials and face. Available in 12 volt only. Features AM/FM, 180 watts, RCA inputs for MP3, IPOD, and XM options. Very compact, only 2-1/2" deep.

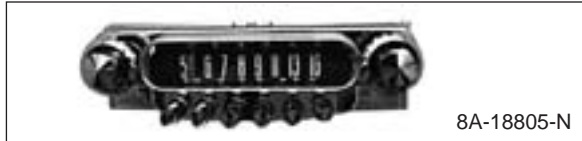

49-50	Pass	8A-18805-N.....ea.	649.95
49-50	Wagon	8A-18805-N.....ea.	649.95
51-52	PU	8A-18805-N.....ea.	649.95

12 Volt Radios

We are a dealer for custom auto sound. Please give us a call and we can order one in for you.

56	Pass	USA-1.....ea.	209.95
56	Pass	USA-2.....ea.	169.00
56	Pass	USA-5.....ea.	289.00
56	Pass	USA-6.....ea.	249.95

SPEAKER

Radio Speaker Grille

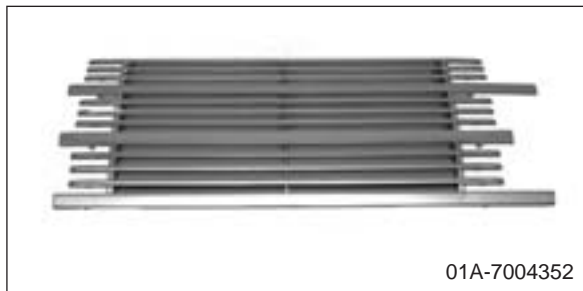

40	Pass	01A-7004352.....ea.	75.00
----	------	---------------------	-------

Radio Speaker Boot

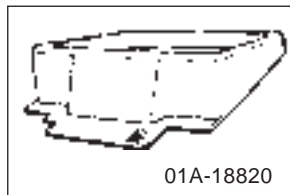

39	Pass	91A-18820.....ea.	40.00
40	Pass	01A-18820.....ea.	40.00
40	Merc	01A-18820.....ea.	40.00

Radio Speaker Cloth



33-36	Pass	40-18806.....ea.	15.00
-------	------	------------------	-------

CONVERTER

Positive Ground Power Converter

This converter is for 6V positive ground vehicles to use a 12V negative ground stereo or a CB



32-55	Pass & PU	POWER-CNVTR-HP, 6 AMP, high output.....ea.	99.95
-------	-----------	---	-------

Negative Ground Power Converter

This converter is for 6V negative ground vehicles to use a 12V negative ground stereo or a CB

All		VB-MAX.....ea.	99.95
-----	--	----------------	-------

RADIO INSTRUCTIONS

Are you putting a radio in your old Ford? These were supplied to Ford mechanics to install radios in Ford cars when they were new. These manuals also show operating instructions.

Radio Instruction Manual



33-34	Pass	RB-33.....ea.	6.00
35-36	Pass	RB-36.....ea.	9.00
37	Pass	RB-37.....ea.	6.00
38	Pass	RB-38.....ea.	6.00
39	Pass	RB-39.....ea.	6.00
40	Pass	RB-40.....ea.	6.00
41	Pass	RB-41.....ea.	4.00
42	Pass	RB-42.....ea.	6.00
46	Pass	RB-46.....ea.	6.00
47-48	Pass	RB-47.....ea.	4.00
49	Dlx Pass	DF73.....ea.	4.00
50	Custom	DF74.....ea.	4.00

Section 34 - Radio



C&G Early Ford Parts, Inc.

50	Dlx Pass	DF220ea.	4.00
51	Custom	DF139ea.	4.00
51	Dlx Pass	DF75ea.	4.00
52	Pass	DF222ea.	4.00
53	Pass	DF223ea.	4.00
54	Pass	DF122ea.	4.00
49	Merc	DL73ea.	4.00
50	Merc	DL9ea.	4.00
51	Merc	DL72ea.	4.00
52	Merc	DL365ea.	4.00
53	Merc	DL353ea.	4.00
55	Merc	DL11ea.	4.00
56	Merc	DL4ea.	4.00
53-55	F100	TR-5309ea.	6.00

35	Pass	48-18803-B, ivorypr.	10.00
36	Pass	68-18803-A, dark brownpr.	10.00
36	Pass	68-18803-B, tenite graypr.	10.00
36	Pass	68-18803-C, gray marblepr.	10.00
37	Std Pass	78-18803-A, lt. brownpr.	10.00
37	Dlx Pass	78-18803-B, yellow brownpr.	10.00
38	Pass	81A-18803, ivorypr.	10.00
40	Pass	01A-18803-P, philcoset.	25.00
40	Pass	01A-18803-Z, zenithset.	25.00
41	Pass	11A-18803, tanpr.	15.00
40	Merc	01A-18803-P, philcoset.	25.00
40	Merc	01A-18803-Z, zenithset.	25.00
41	Merc	11A-18803, tanpr.	15.00

KNOBBS/DIALS

Radio Knob & Dial Kit



40	Pass	01A-18803-45-P, philcoset.	55.00
40	Pass	01A-18803-45-Z, zenithset.	55.00
40	Merc	01A-18803-45-P, philcoset.	55.00
40	Merc	01A-18803-45-Z, zenithset.	55.00

Radio Cover, Knobs & Selector Kit

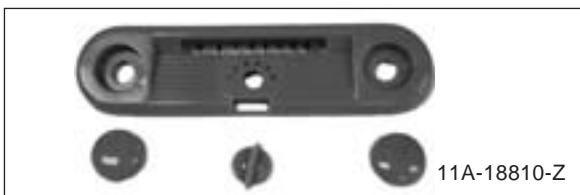

41	Pass	11A-18810-P, philco, 4 pcs.set.	65.00
41	Pass	11A-18810-Z, zenith, 4 pcs.set.	65.00
41	Merc	11A-18810-P, philco, 4 pcs.set.	65.00
41	Merc	11A-18810-Z, zenith, 4 pcs.set.	65.00

Radio Knobs



33-34	Pass	40-18803, ash traypr.	15.00
33-34	Pass	40-18803-G, grisbypr.	20.00
33-34	Pass	40-18803-Z, zenithpr.	20.00
35	Pass	48-18803-A, maroonpr.	10.00

Radio Push Buttons

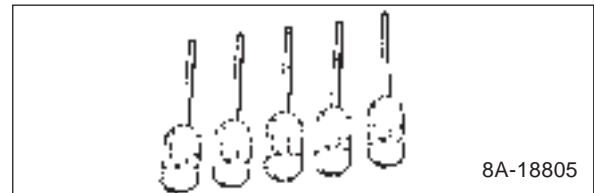

49-50	Pass	8A-18805set.	30.00
-------	------	----------	-----------	-------

Radio Dials



40	Pass	01A-18805-P, philcopr.	25.00
40	Pass	01A-18805-Z, zenithpr.	25.00
40	Merc	01A-18805-P, philcopr.	25.00
40	Merc	01A-18805-Z, zenithpr.	25.00

Radio Station Change Button

40	Pass	01A-18804-P, philcoea.	10.00
40	Pass	01A-18804-Z, zenithea.	10.00
40	Merc	01A-18804-P, philcoea.	10.00
40	Merc	01A-18804-Z, zenithea.	10.00

Radio Station Selector



41	Pass	11A-18804-P, philcoea.	6.00
41	Pass	11A-18804-Z, zenithea.	6.00
41	Merc	11A-18804-P, philcoea.	6.00
41	Merc	11A-18804-Z, zenithea.	6.00

Radio Dial Decals

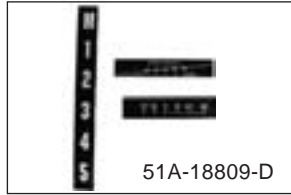

46-48	Pass	51A-18809-D, 3 pcs.....set.	18.00
46-48	Merc	51A-18809-D, 3 pcs.....set.	18.00

Radio Dial Glass

37	Pass	78-18801.....ea.	6.00
----	------	------------------	------

FACE PLATES

Radio Dial Face Plate



33-34	Pass	40-18802, ash tray radio.....ea.	14.00
33-34	Pass	40-18802-G, grisby.....ea.	14.00
33-34	Pass	40-18802-Z, zenith.....ea.	14.00
35-36	Pass	48-18802, gray.....ea.	10.00
36	Pass	68-18802, brown.....ea.	10.00

Radio Dial Bezel



38	Pass	81A-18802.....ea.	25.00
----	------	-------------------	-------

Radio Cover

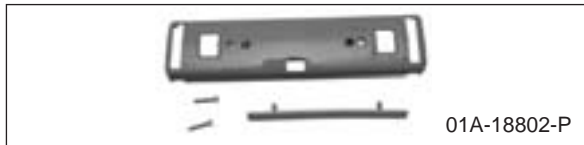

40	Pass	01A-18802-P, philco.....ea.	25.00
40	Pass	01A-18802-Z, zenith.....ea.	25.00
40	Pass	01A-9272-RC, chrome.....ea.	22.00
41	Pass	11A-18802-P, philco.....ea.	50.00
41	Pass	11A-18802-Z, zenith.....ea.	50.00
40	Merc	01A-18802-P, philco.....ea.	25.00
40	Merc	01A-18802-Z, zenith.....ea.	25.00
40	Merc	01A-9272-RC, chrome.....ea.	22.00
41	Merc	11A-18802-P, philco.....ea.	50.00
41	Merc	11A-18802-Z, zenith.....ea.	50.00

Six Button Radio Face

49-50	Pass	8A-18809-S.....set.	18.00
-------	------	---------------------	-------

Radio Hole Cover

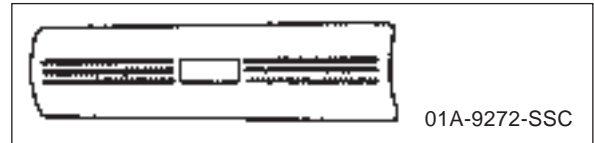

40	Pass	01A-9272-SSC, SS.....ea.	16.00
40	Merc	01A-9272-SSC, SS.....ea.	16.00

MOUNTING HARDWARE

Radio Mounting Hooks

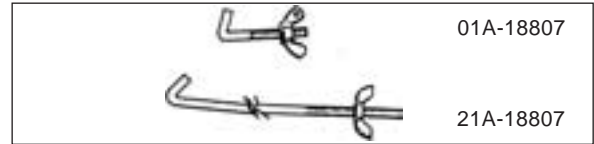

40-41	Pass	01A-18807.....pr.	7.50
42-48	Pass	21A-18807.....pr.	7.50
40-41	Merc	01A-18807.....pr.	7.50
42-48	Merc	21A-18807.....pr.	7.50

Radio to Dash Nut



40-41	Pass	01A-18808.....ea.	10.00
40-41	Merc	01A-18808.....ea.	10.00

Radio Mounting Washers

37-39	Pass	78-18869.....set.	25.00
-------	------	-------------------	-------

FOOT CONTROL SWITCH

Radio Foot Control Switch with Wire



41-48	Pass	11A-18934-A.....ea.	32.00
41-48	Merc	11A-18934-A.....ea.	32.00



ANTENNAS

Complete Radio Antenna Assembly

For use with original radios only on 1933-48 cars.

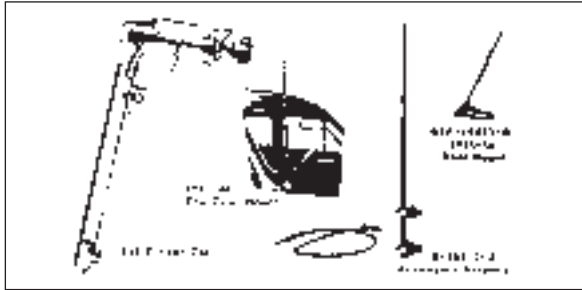

33-36	Pass	40-18812-B, roof mount.....ea.	20.50
33-36	Pass	40-18812C, spare tire mountkit.	71.60
37	Std Pass	78-18813-AA, , exc. conv & wgn.....ea.	92.50
37	Dlx Pass	78-18813-AB, , exc. conv & wgn.....ea.	92.50
37	Conv	78-18813-B.....ea.	92.50
37	Wagon	78-18813-B.....ea.	92.50
38	Pass	81A-18813-A, , exc. conv & wgn.....ea.	92.50
38	Conv	81A-18813-B.....ea.	92.50
38	Wagon	81A-18813-B.....ea.	92.50
39	Pass	91A-18813-A, , exc. conv & wgn.....ea.	92.50
39	Conv	91A-18813-B.....ea.	92.50
39	Wagon	91A-18813-B.....ea.	92.50
40	Std Pass	01A-18813-A.....ea.	75.00
40	Dlx Pass	01A-18813-B, , exc. conv & wgn.....ea.	75.00
40	Conv	01A-18813-C.....ea.	92.50
40	Wagon	01A-18813-C.....ea.	92.50
41	Pass	11A-18813, , exc. conv & wgn.....ea.	75.00
41	Conv	11A-18813-A.....ea.	92.50
41	Wagon	11A-18813-A.....ea.	92.50
42-48	Pass	21A-18813, exc. conv & wgn, roof mount requires part #21A-18817-S wireea.	75.00
42-48	Conv	21A-18813-A, , center roof mountea.	92.50
42-48	Wagon	21A-18813-A, , center roof mountea.	92.50
47-48	Pass	6A-18813, cowl mount.....ea.	70.00
49-51	Pass	8A-18813, cowl mount.....ea.	72.50
52-56	Pass	B5A-18813-C, , front fender mount.....ea.	60.00
55-56	Pass	B5A-18813-B, rear mount.....ea.	90.00
39	Merc	99A-18813, exc. conv.....ea.	100.00
39	Merc Conv	99A-18813-A.....ea.	100.00
40	Merc	09A-18813, exc. conv.....ea.	75.00
40	Merc Conv	09A-18813-A.....ea.	100.00
41	Merc	11A-18813, exc. conv & wgn.....ea.	75.00
41	Merc Conv	11A-18813-A.....ea.	92.50
41	Merc Wgn	11A-18813-A.....ea.	92.50

42-48	Merc	21A-18813, exc. conv & wgn, roof mount requires part # 21A-18817-S wire.....ea.	75.00
42-48	Merc Conv	21A-18813-A, center roof mountea.	92.50
42-48	Merc Wgn	6A-18813, cowl mount.....ea.	70.00
49-51	Merc	BAAA-18813-Aea.	70.00
52-54	Merc	B5A-18813-C, , front fender mount.....ea.	60.00
48-52	PU	6A-18813, cowl mount.....ea.	70.00
53-55	PU	BAAA-18813-Aea.	70.00

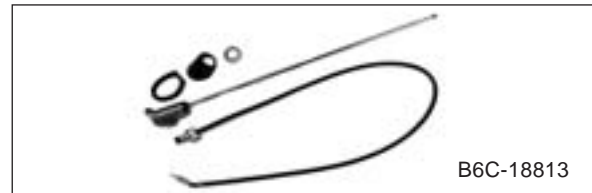

56	PU	B6C-18813.....ea.	70.00
----	----	-------------------	-------

Universal Antenna

Mounts to side of cowl with two studs, except where noted. For use with aftermarket radio.

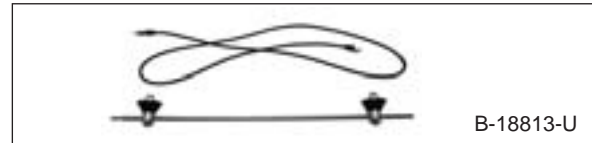

32-48	Pass	B-18813-U.....ea.	25.00
32-48	Pass	B-18813-RB, with plastic red ball on topea.	39.95
32-48	Pass	B-18813-1, single post mountea.	25.00
32-52	PU	B-18813-Uea.	25.00
32-52	PU	B-18813-RB, with plastic red ball on topea.	39.95
32-52	PU	B-18813-1, single post mountea.	25.00

Antenna Mast

47-59	Pass	6A-18815-Sea.	20.00
47-54	Merc	6A-18815-Sea.	20.00
47-56	PU	6A-18815-Sea.	20.00

Antenna Lead Wire



42-48	Pass	21A-18817-S, roof mount antenna.....ea.	37.50
47-51	Pass	6A-18817-S, cowl mount antenna.....ea.	10.00
42-48	Merc	21A-18817-S, roof mount antenna.....ea.	37.50
47-51	Merc	6A-18817-S, cowl mount antenna.....ea.	10.00

Antenna Turn Knob



37	Std Pass	78-18815-A.....ea.	10.00
37	Dlx Pass	78-18815-B.....ea.	10.00
38	Pass	81A-18815.....ea.	10.00
39	Pass	91A-18815.....ea.	10.00
40	Conv	01A-18815-B.....ea.	10.00
41	Conv	11A-18815.....ea.	10.00
39	Merc	99A-18815.....ea.	10.00
40	Merc	09A-18815.....ea.	10.00
41	Merc Conv	11A-18815.....ea.	10.00
41	Merc Wgn	11A-18815.....ea.	10.00
40	Wagon	01A-18815-B.....ea.	10.00
41	Wagon	11A-18815.....ea.	10.00

Antenna Slide Nut



40	Std Pass	01A-18816-A.....ea.	7.00
40	Dlx Pass	01A-18816-B.....ea.	7.00
41	Pass	11A-18816.....ea.	7.00
42-48	Pass	21A-18816.....ea.	7.00
40	Merc	09A-18816.....ea.	7.00
41	Merc	11A-18816.....ea.	7.00
42-48	Merc	21A-18816.....ea.	7.00

Antenna Hold Down Nut

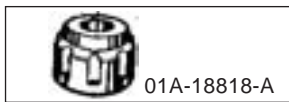

40	Std Pass	01A-18818-A.....ea.	6.00
40	Dlx Pass	01A-18818-B.....ea.	6.00
41	Pass	11A-18818.....ea.	6.00
40	Merc	09A-18818.....ea.	6.00
41	Merc	11A-18818.....ea.	6.00

Antenna Windshield Stop



37-39	Pass	78-18820-A, exc. conv & wgn.....ea.	10.00
37-39	Conv	78-18820-B.....ea.	10.00
37-39	Wagon	78-18820-B.....ea.	10.00
40	Conv	01A-18821.....ea.	10.00
40	Merc	01A-18821.....ea.	10.00

Antenna Base Pad

47-51	Pass	6A-18818-S, cowl mount.....ea.	5.00
52-56	Pass	BA-18818, front fender mount.....ea.	5.00
55-56	Pass	B5A-18818, rear fender mount.....ea.	7.00
55-57	T-Bird	BA-18818, front fender mount.....ea.	5.00

Front Fender Antenna Plastic Spacer



52-56	Pass	BA-18919-A.....ea.	10.00
-------	------	--------------------	-------

Front Fender Antenna Wire Grommet

Mounts on inner cowl section for lead wire.

55-56	Pass	B5A-18912-A.....ea.	3.00
-------	------	---------------------	------

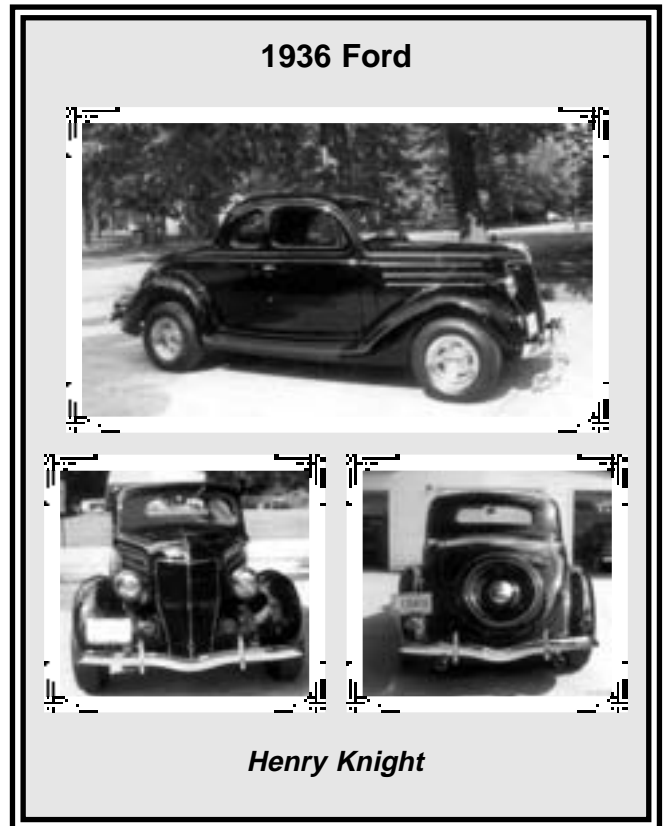



Section 35 Heater

HEATER

Universal Heater Assembly with Switch

Has three mounting studs, and two water connections. Box measures 7" wide, 7-1/4" deep, 6-3/4" tall. Uses 5/8" heater hose.

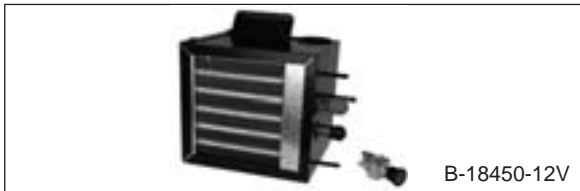

- All Pass & PU B-18450-6V, 6Vea. 240.00
- All Pass & PU B-18450-12V, 12Vea. 190.00

HEATER MOTOR

Universal Heater Motor

Two wire motor, 2-7/8" diameter, 2-3/4" long body, 1/4" diameter shaft. Can be wired to spin clock wise or counter-clock wise.



- 46-55 Pass 21A-18527, 6Vea. 80.00
- 48-55 PU 21A-18527, 6Vea. 80.00

Reproduction Heater Motor

2 Speed, 3 wire with 1/4" shaft, turns counter clock wise.

- 49-56 Pass B6C-18527-A, 12 voltea. 185.00

HEATER CONTROLS

Heater Switch Knob



- 35 Std Pass 48-18500-A, maroonea. 7.00
- 35 DlX Pass 48-18500-B, ivoryea. 7.00
- 36 Std Pass 68-18500-A, early, dark brownea. 7.00
- 36 DlX Pass 68-18500-B, early, light grayea. 7.00
- 36 Pass 68-18500-C, late, gray marbleea. 7.00
- 37 Std Pass 78-18500-A, light brownea. 7.00
- 37 DlX Pass 78-18500-B, yellow brownea. 7.00
- 38 Pass 81A-18500, ivoryea. 7.00

- 39 Pass 91A-18500, yellowea. 7.00

Lower Heater Control Lever

- 54-56 Pass B6A-18574-B, includes 2 rivets ..ea. 18.95

Heater Defroster Knob



- 37 Std Pass 78-18501-A, dark brownea. 7.00
- 37 DlX Pass 78-18501-B, light grayea. 7.00
- 38 Pass 81A-18501, ivoryea. 7.00
- 39 Pass 91A-18562-W, whiteea. 6.00
- 39 Pass 91A-18562-Y, yellowea. 6.00
- 40 Pass 91A-18562, sandea. 7.00
- 41 Pass 11A-18562, light tanea. 7.00
- 42 DlX Pass 21A-18562-A, maroonea. 7.00
- 42 Super DlX 21A-18562-B, butterscotchea. 7.00
- 46 DlX Pass 51A-18562-A, brownea. 7.00
- 46 Super DlX 51A-18562-B, blue grayea. 7.00
- 46 Super DlX 51A-18562-C, gray tanea. 7.00
- 47-48 Pass 6A-18562, gray tnea. 7.00
- 40 PU 91A-18562, sandea. 7.00
- 41 PU 11A-18562, light tanea. 7.00

Hot Air Heater & Defroster Knobs



- 39-46 Pass & PU 91A-18502/3pr. 15.00

Heater Door Knobs



- 39 Pass 91A-18560-W, whitepr. 10.00
- 39 Pass 91A-18560-Y, yellowpr. 10.00
- 40 Pass 01A-18560, lt. greenpr. 10.00
- 41-48 Pass 11A-18560, blackset. 15.00
- 41-48 Pass 11A-18560-T, tanset. 15.00
- 52-57 Pass FAB-19203-A, ivoryea. 7.50
- 39 Merc 91A-18560-W, whitepr. 10.00
- 55-57 T-Bird FAB-19203-A, ivoryea. 7.50
- 40 PU 01A-18560, lt. greenpr. 10.00

41-47	PU	11A-18560, black	set.	15.00
41-47	PU	11A-18560-T, tan.....	set.	15.00

Heater & Defroster Cable & Knob Kit

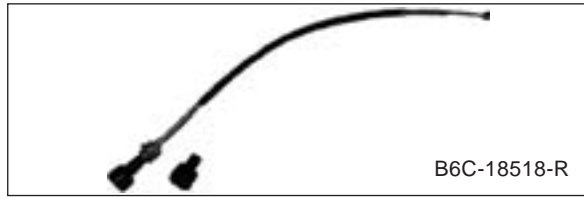

53-55	PU	BAAA-18518-F, fresh air	kit.	65.00
53-55	PU	BAAA-18518-R, recirculating	kit.	30.00
56	PU	B6C-18518-F, fresh air	kit.	65.00
56	PU	B6C-18518-R, recirculating	kit.	30.00

Stainless Heater Control Bracket



53-56	PU	BAAA-18597-FH, fresh air.....	ea.	35.00
-------	----	----------------------------------	-----	-------



53-56	PU	BAAA-18597-RH, recirculating.....	ea.	35.00
-------	----	--------------------------------------	-----	-------

HEATER CORE

Heater Core

52-56	Pass	FAA-18476-A	ea.	109.95
55-57	T-Bird	FAA-18476-A	ea.	109.95

CONTROL VALVE

Rebuilt Heater Control Valve

We can have your original control valve rebuilt. Please allow three-six weeks for rebuilding. Mounts on firewall inside car.



49	Pass	8A-18502	ea.	140.00
49	Pass	8A-18502-CORE, core charge.....	ea.	100.00
50	Pass	0A-18502, early 50	ea.	140.00
50	Pass	0A-18502-CORE, early 50 core charge.....	ea.	100.00
50-51	Pass	1A-18502, late 50	ea.	140.00
50-51	Pass	1A-18502-CORE, late 50 core charge.....	ea.	100.00
52-56	Pass	B5A-18502-A	ea.	140.00
52-56	Pass	B5A-18502-ACORE, core charge.....	ea.	100.00
49	Merc	8A-18502	ea.	140.00
49	Merc	8A-18502-CORE, core charge.....	ea.	100.00

Heater Control Valve

Mounts on intake manifold. Have been retooled for 2009.



52-56	Pass	B5A-18495-A	ea.	80.00
52-56	Merc	B5A-18495-A	ea.	80.00
55-57	T-Bird	B5A-18495-A	ea.	80.00

Firewall Heater Control Valve Without Bracket

Valve only. Must mount to your old bracket.

53-56	PU	FAC-18495-AR, N.O.S.	ea.	100.00
-------	----	---------------------------	-----	--------



HEATER SEALS/SEAL KITS

Heater Seal, Duct, & Gasket Kit

This kit includes all heater gaskets, seals, air duct seals, & air valve damper rubber.

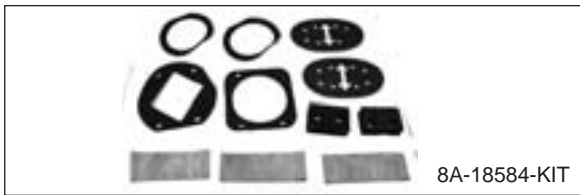

49-51	Pass	8A-18584-KIT	kit.	41.00
52-54	Pass	BA-18584-KIT	kit.	103.00
55-56	Pass	B5A-18584-KIT	kit.	85.00

Square Heater Connecting Duct

52-56	Pass	B6A-18489-A	ea.	15.00
55-57	T-Bird	B6A-18489-A	ea.	15.00

Square Heater Connecting Duct Clamp



52-56	Pass	FAA-8725-A	ea.	4.00
55-57	T-Bird	FAA-8725-A	ea.	4.00

Heater Blower Housing to Air Duct Valve Hose Seal

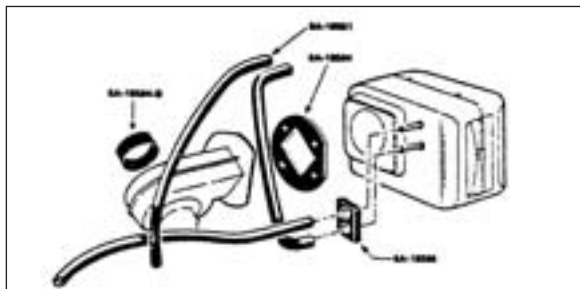

49-51	Pass	8A-18584-B	ea.	4.00
52-56	Pass	B5A-18584-A, round.....	ea.	15.00
55-57	T-Bird	B5A-18584-A, round.....	ea.	15.00

Heater Motor Housing to Firewall Seal

49-51	Pass	8A-18594	ea.	5.00
-------	------	----------------	-----	------

Heater to Firewall Gasket

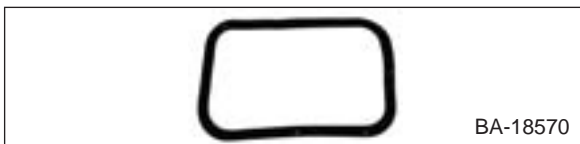

52-56	Pass	BA-18570	ea.	5.00
-------	------	----------------	-----	------

Heater Core Housing to Firewall Seal

49-51	Pass	8A-18594-C	ea.	5.00
-------	------	------------------	-----	------

Heater Core Housing to Dash Gasket

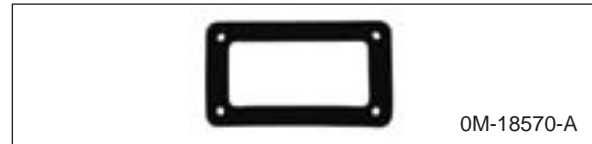

50-51	Merc	0M-18570-A	ea.	11.00
-------	------	------------------	-----	-------

Fresh Air Valve to Dash Gasket



49-51	Merc	8M-18570-A	ea.	4.00
-------	------	------------------	-----	------

Heater Housing to Heater Core Gasket

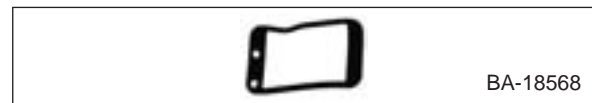

52-56	Pass	BA-18568	ea.	4.00
-------	------	----------------	-----	------

Heater Motor to Housing Gasket



52-59	Pass	FAD-18583	ea.	7.00
-------	------	-----------------	-----	------

Heater Duct Inlet to Heater Core Gasket

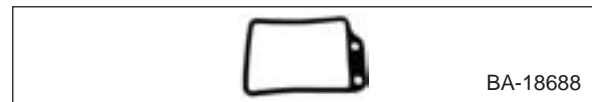

52-54	Pass	BA-18688	ea.	4.00
-------	------	----------------	-----	------

Heater Core Tube & Temperature Tube Seal



49-51	Pass	8A-18596	pr.	4.00
-------	------	----------------	-----	------

Recirculating Heater Seal Kit

3 piece kit; 2-heater core seals and 1-heater motor to firewall seal.



53-56	PU	BAAA-18565-S	kit.	15.00
-------	----	--------------------	------	-------

Air Valve Flapper Assembly

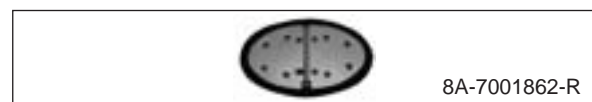

49-56	Pass	8A-7001862-R	ea.	19.95
-------	------	--------------------	-----	-------

Air Valve Damper Rubber Seal and Hardware

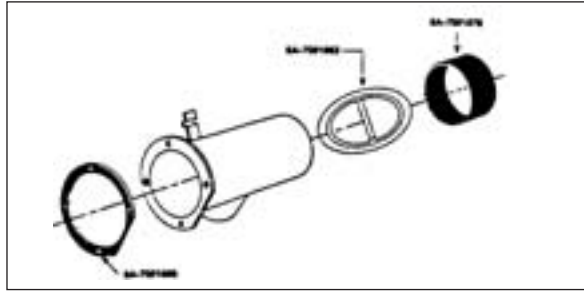

49-56 Pass 8A-7001862-S.....set. 15.00

Rubber Ventilator Air Duct Connector



49-51 Pass 8A-7001878pr. 8.00
 52-54 Pass BA-7001878-Cea. 17.00
 49-51 Merc 8M-7001878.....pr. 15.00

Air Ventilator Rear Duct Sprong Seal



50-51 Merc 8M-7001928.....pr. 5.00

Fresh Air Duct Ventilator Screen

49-50 Pass 8A-8716pr. 20.00
 51 Pass 1A-7001909pr. 15.00
 49 Merc 8M-8716.....pr. 20.00
 50-51 Merc 0M-7201900.....pr. 15.00

Fresh Air Duct Connector Clamp



50-51 Merc 0M-8725-A, 4"ea. 4.00

Ventilator Air Valve Gasket



49-51 Pass 8A-7001880pr. 4.00
 52-56 Pass BA-7001880-A.....pr. 8.00

Fresh Air Hot Water Heater Blower Housing Gasket



50-51 Merc 0M-18570-Bea. 29.00

Ventilator Duct Cable Firewall Grommet

55-56 Pass B5A-7002042-S, 2 req'd.....ea. 4.00

Heater Tube to Firewall Seal

48-56 PU 8C-18595, 2 req'dea. 2.00

HEATER HARDWARE

Heater Screw Kit

40 Pass 01A-15149-HK, latekit. 5.00

Heater Shut-Off Valve

Threads into cylinder head on right side of engine.



39-48 Pass 91A-15142, V-8ea. 20.00
 39-48 Merc 91A-15142, V-8ea. 20.00
 39-47 PU 91A-15142, V-8ea. 20.00

Lower Radiator Hose Nipple for Heater Hose

Have to make a hole in lower radiator hose.



39-48 Pass 91A-15160ea. 15.00
 39-48 Merc 91A-15160ea. 15.00
 39-47 PU 91A-15160ea. 15.00

Threaded Hose Fitting

49-59 All 8A-18599, 3/8" thread straightea. 9.00
 49-59 All 8A-18599-WS, w/restrictor 3/8" Thread, straightea. 9.00

Heater Hose

All Pass & PU APA-18472-A, 5/8"ft. 1.25

Heater Temp Valve to Heater Core Hose



49-51 Pass 8A-18551ea. 10.00

Universal Heater Hose Kit

Includes hose, valve, coupling and fittings.



All Pass & PU B-18451-KITea. 41.50



Heater Hose & Clamp Kit

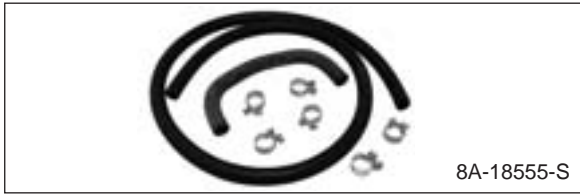

49-51 Pass 8A-18555-Sea. 20.00

Heater Hose Clamp



All Pass & PU BPA-18572-A, 5/8" hoseea. 1.00

Heater Hose Brackets

Holds heater hose to spark plug wire looms.



39-41 Pass & PU 91A-15151/2, V8kit. 47.00

DEFROSTER

ABS Heater Plenum

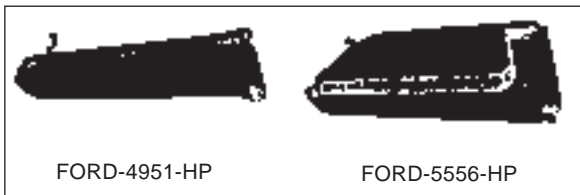

49-51 Pass FORD-4951-HPea. 90.00
 52-54 Pass FORD-5254-HPea. 90.00
 55-56 Pass FORD-5556-HPea. 90.00
 52-54 Merc FORD-5254-HPea. 90.00
 55-56 Merc FORD-5556-HPea. 90.00
 55-57 T-Bird TBIRD-5557-HPea. 90.00

Heater Defroster Hose



All Pass & PU 91A-18554,
 1-3/4" ID X 6'ea. 45.00
 All Pass & PU B5A-18556-C,
 2-1/2" ID X 6'ea. 36.00
 All Pass & PU FAB-18556-D,
 2" ID X 6'ea. 38.00

Cloth Heater Defroster Hose

Ending of Part Number Represents Hose Diameter of 1-1/2"-4".
 Comes in 3' lengths.

All Pass & PU FAA-18584-1-1/2, "ea. 19.95
 All Pass & PU FAA-18584-1-3/4, "ea. 19.95
 All Pass & PU FAA-18584-2, "ea. 19.95
 All Pass & PU FAA-18584-2-1/4, "ea. 21.95
 All Pass & PU FAA-18584-2-1/2, "ea. 19.95
 All Pass & PU FAA-18584-2-3/4, "ea. 24.95
 All Pass & PU FAA-18584-3, "ea. 24.95
 All Pass & PU FAA-18584-3-1/2, "ea. 25.95
 All Pass & PU FAA-18584-3-1/4, "ea. 24.95
 All Pass & PU FAA-18584-3-3/4, "ea. 26.95
 All Pass & PU FAA-18584-4, "ea. 35.95

Heater Defroster Hose with Nozzles



40 Pass 01A-18491set. 50.00
 40 PU 01A-18491set. 50.00

Heater Defroster Hose Nozzle Seals

55-57 T-Bird B5S-18490-PRpr. 7.00
 48-52 PU 1C-18547-Apr. 15.00

AIR CONDITIONER PARTS

A/C Air Intake Hose

55-56 Pass B5A-19344-Aea. 30.00

A/C Evaporator Drain Hose through Floor

55-56 Pass B5A-19727-Sea. 12.00

A/C Evaporation Bottom Drain Hose

55-56 Pass B5A-19728-Sea. 12.00

A/C Evaporator Drain Hose Grommet

55-56 Pass 354754-Sea. 4.00

A/C Blower Housing to Dash Outlet Rubber Hose

55-56 Pass B5A-19776-Sea. 32.50

A/C Compressor Gasket Set

55-56 Pass B5A-19671-Aset. 25.00

**Section 36
Cowl Vent**

GASKET

Cowl Vent Gasket

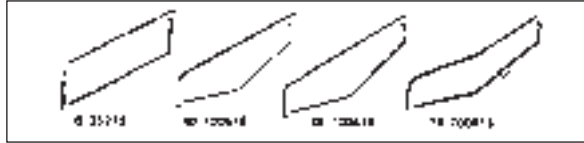

32	Pass	B-35275ea.	15.00
33-34	Pass	40-700616ea.	16.00
35-36	Pass	48-700616ea.	20.00
37-38	Pass	78-700616ea.	20.00
39-42	Pass	91A-7002330ea.	20.00
46-48	Pass	51A-7002330ea.	20.00
39-42	Merc	91A-7002330ea.	20.00
46-48	Merc	51A-7002330ea.	20.00
32-34	PU	B-35275ea.	15.00
35-36	PU	40-700616ea.	16.00
37-38	PU	78-700616ea.	20.00
39-42	PU	91A-7002330ea.	20.00
46-48	PU	51A-7002330ea.	20.00
48-52	PU	7C-8102330ea.	10.00
53-56	PU	BAAA-8102330-Aea.	10.00

SCREENS

Cowl Vent Screen



35-36	Pass	48-700590ea.	26.00
39-40	Pass	91A-700590ea.	43.00
39-40	Merc	91A-700590ea.	43.00
40-47	PU	91A-700590ea.	43.00

HINGE/RATCHET/SPRING

Cowl Vent Hinge



32	Pass	B-35260ea.	32.00
33-34	Pass	40-35260ea.	32.00
32-34	PU	B-35260ea.	32.00

Cowl Vent Ratchet and Spring Kit

Kit includes ratchet and spring.

32	Pass	B-35276-Kkit.	15.00
33-34	Pass	40-700620-Kkit.	17.00
35-36	Pass	48-700620-Kkit.	15.00
32-34	PU	B-35276-Kkit.	15.00
35-36	PU	40-700620-Kkit.	17.00

Cowl Vent Ratchet



32	Pass	B-35276ea.	10.50
33-34	Pass	40-35276ea.	10.50
35-36	Pass	48-700620ea.	15.00
32-34	PU	B-35276ea.	10.50
35-37	PU	40-35276ea.	10.50

Cowl Vent Spring



32	Pass	B-35269ea.	5.00
33-37	Pass	40-35269ea.	5.00
32-34	PU	B-35269ea.	5.00
35-37	PU	40-35269ea.	5.00

HANDLE/KNOB

Cowl Vent Handle



32	Pass	B-700612ea.	22.00
33-36	Pass	40-700612ea.	20.00
32-34	PU	B-700612ea.	22.00
35-36	PU	50-810612ea.	20.00

Cowl Vent Knob



37	Std Pass	78-7002145-A, light brownea.	8.00
37	Dlx Pass	78-7002145-B, yellow brownea.	8.00
38	Pass	81A-7002145, ivoryea.	8.00
39	Pass	91A-7002145, yellowea.	8.00
40	Std Pass	01A-7002145-A, sandea.	8.00
40	Dlx Pass	01A-7002145-B, maroonea.	8.00
41	Pass	11A-7213, tan, round shaftea.	8.00
41	Pass	11A-7002145, tan, flat shaftea.	8.00
42-48	Pass	21A-7002145-B, blackea.	8.00



42	Dlx Pass	21A-7213-A, maroon	ea.	8.00
42	Super Dlx	21A-7213-B, butterscotch	ea.	8.00
46	Dlx Pass	51A-7213-A, brown.....	ea.	8.00
46	Super Dlx	51A-7213-B, blue gray	ea.	8.00
46	Super Dlx	51A-7213-C, gray tan.....	ea.	8.00
47-48	Pass	51A-7213-C, gray tan.....	ea.	8.00
39	Merc	99A-7002145, pinkish	ea.	10.00
40	Merc	09A-7002145, dark blue.....	ea.	10.00
41	Merc	11A-7002145, flat shaft.....	ea.	8.00
40	PU	01A-7002145-A, sand	ea.	8.00
41-47	PU	11C-8102145, black.....	ea.	8.00
53-56	PU	BAAA-8102145, with rivets	ea.	5.50

*55-56	Pass	FORD-5556-C	ea.	207.00
*39	Merc	MERC-3900-C.....	ea.	207.00
*40	Merc	MERC-4000-C.....	ea.	207.00
*41	Merc	FORD-41-C-DLX.....	ea.	207.00
*42-48	Merc	FORD-4248-C	ea.	167.00
*49-51	Merc	MERC-4951-R, , has rubber lip on bottom	ea.	207.00
*52-54	Merc	FORD-5254-C	ea.	207.00
*55-56	Merc	MERC-5556-C.....	ea.	207.00
*37	Linc Zeph	LINC-3700-Z.....	ea.	222.00
*38-39	Linc Zeph	LINC-3839-Z.....	ea.	195.00
*40-41	Linc Cont	LINC-4041-C.....	ea.	195.00
*42-48	Linc Cont	LINC-4248-C.....	ea.	195.00
*42-48	Linc Zeph	LINC-4248-Z.....	ea.	222.00
*49-51	Linc Cosmo	LINC-4951-C.....	ea.	182.00
*52-55	Lincoln	LINC-5255-C.....	ea.	195.00
*56-57	Lincoln	LINC-5657-C.....	ea.	195.00
*32	PU	FORD-32-C4, 4 cyl	ea.	207.00
*32	PU	FORD-32-C8, V-8.....	ea.	207.00
*33-34	PU	FORD-3334-T	ea.	207.00
*33-34	Truck	FORD-3334-BT, 1-1/2 ton	ea.	207.00
*35-36	PU	FORD-3536-T	ea.	207.00
*37-39	PU	FORD-37-39-T	ea.	207.00
*40-47	PU	FORD-4047-T	ea.	154.00
*48-52	PU	FORD-4852-T	ea.	154.00
*48-52	Truck	FORD-4852-F3, F-3	ea.	154.00
*48-50	C.O.E.	FORD-4850-T	ea.	154.00
*53-55	PU	FORD-5355-T	ea.	154.00
*56	PU	FORD-5600-T.....	ea.	154.00

**Section 37
Firewall**

INSULATOR

Also see Interior section for more insulation kits.

ABS Plastic Firewall Insulator

These insulators are made out of tough ABS plastic with the original design pattern. The insulation is made as original with holes drilled for easy installation. Oversize shipping required.



FORD-35-36-C

*32	Pass	FORD-32-C4, 4 cyl	ea.	207.00
*32	Pass	FORD-32-C8, V-8.....	ea.	207.00
*33-34	Pass	FORD-3334-C	ea.	207.00
*35-36	Pass	FORD-3536-C	ea.	207.00
*37	Pass	FORD-3700-C	ea.	207.00
*38	Pass	FORD-3839-C60, w/60 HP	ea.	207.00
*38	Pass	FORD-3839-C85, w/85 HP	ea.	207.00
*39	Std Pass	FORD-3839-C60, w/60 HP	ea.	207.00
*39	Std Pass	FORD-3839-C85, w/85 HP	ea.	207.00
*39	Dlx Pass	FORD-39DLX-C	ea.	207.00
*40	Pass	FORD-4000-C	ea.	207.00
*41	Std Pass	FORD-41-C-STD	ea.	167.00
*41	Dlx Pass	FORD-41-C-DLX.....	ea.	207.00
*42-48	Pass	FORD-4248-C	ea.	167.00
*49-51	Pass	FORD-4951RND-C, Round Hump	ea.	207.00
*49-51	Pass	FORD-4951SQ-C, Square Hump.....	ea.	207.00
*52-54	Pass	FORD-5254-C	ea.	207.00

Original Style Firewall Insulator

Made from fiberboard or cardboard like original. Mounting hardware is NOT included.

*49-50	Pass	8A-7001670-A.....	ea.	150.00
*55-56	Pass	B5A-7001670-A	ea.	130.00

Firewall Insulator Button

These are NOT concourse correct.



RFP-152-P

35-56	Pass & PU	48-7001670-CLIP, metal.....	ea.	3.00
35-56	Pass & PU	RFP-152-P, plastic	ea.	1.00

SEALS/GROMMETS

Cowl to Firewall Seal

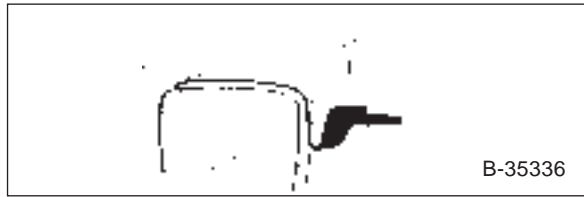

32 Pass B-35336ea. 15.00

Firewall Grommet Kit



32 Pass B-700731, 11 pcs.kit. 16.00



33-34 Pass 40-700731, 5 pcs.kit. 8.50
 32 PU B-700731, 11 pcs.kit. 16.00

Firewall Wire Loom Grommet



35-48 Pass 48-700731ea. 5.00
 49-50 Pass 8A-14603-Bea. 4.00
 51-59 Pass 1A-14603-Bea. 4.00
 39-48 Merc 48-700731ea. 5.00
 49-51 Merc 8A-14603-Bea. 4.00
 52-59 Merc 1A-14603-Bea. 4.00
 35-47 PU 48-700731ea. 5.00
 48-59 PU 1A-14603-Bea. 4.00

Firewall Wire Loom Grommet Retainer



49-59 Pass 8A-14608ea. 10.00
 49-59 Merc 8A-14608ea. 10.00
 48-56 PU 8A-14608ea. 10.00

Firewall Speedo Cable, Choke & Throttle Grommet

51-52 PU 7C-17265ea. 4.00

Firewall Choke & Throttle Grommet

32-48 Pass B-14605ea. 2.00
 49-51 Pass B-14607ea. 1.00
 39-48 Merc B-14605ea. 2.00
 32-50 PU B-14605ea. 2.00
 53-56 PU B-14605ea. 2.00

Firewall Speedo Cable/Emergency Cable Grommet



40 Pass 01A-17265ea. 6.00
 41-48 Pass 11A-17265ea. 6.00
 40 Merc 01A-17265ea. 6.00
 41-48 Merc 11A-17265ea. 6.00

Firewall Speedometer Cable & Wiper Hose Grommet

42-47 PU 21C-17265ea. 5.00

Firewall Speedometer Cable Grommet

33-39 Pass 48-17265ea. 3.00
 49-51 Pass 8A-17265-Sea. 3.00

Firewall Wiper Hose Grommet

40 Pass 01A-17545-B, exc. convea. 2.00
 40 Conv 01A-17545-Aea. 2.00
 41-48 Pass 01A-17545-Bea. 2.00
 49-51 Pass 8A-17545-Sea. 3.00
 40 Merc 01A-17545-Bea. 2.00
 41-48 Merc 01A-17545-Bea. 2.00
 53-56 PU BAAA-17545ea. 3.00

Firewall Wiper Hose & Temperature Gauge Grommet

39 Pass 91A-17545ea. 2.00

Firewall Hood Pull Cable Grommet

41-48 Pass B-14605ea. 2.00
 49-51 Pass 8A-14605-Aea. 2.00
 41-48 Merc B-14605ea. 2.00

Firewall Electric Wiper Motor Wire Grommet

56 PU 8A-14605-Aea. 2.00

Firewall Heater Motor Wire Grommet

49-51 Pass 8A-14605-Bea. 1.00

Firewall Overdrive Pull Cable Grommet



51-56 Pass 1A-7001694ea. 4.00

Firewall Overdrive Relay Wire Grommet

51 Pass 1A-14567ea. 3.00



Air Vent Cable Grommet

49-51 Pass B-14605-Apr. 2.00

DATA/BODY PLATES

Firewall Patent Data Plate



32-34	Pass	B-18650-Aea.	5.00
35-36	Pass	B-18650-Bea.	5.00
37-39	Pass	B-18650-Cea.	5.00
40-48	Pass	B-18650-Dea.	5.00
49-50	Pass	8A-14001ea.	6.00
39-48	Merc	B-18650-Eea.	5.50
49-51	Merc	8M-14001ea.	8.00
32-34	PU	B-18650-Aea.	5.00
35-36	PU	B-18650-Bea.	5.00
37-39	PU	B-18650-Cea.	5.00
40-47	PU	B-18650-Dea.	5.00
48-52	PU	7C-14001ea.	6.00

Firewall Body Number Plate

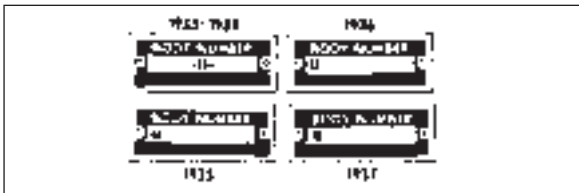

33-34	Pass	40-14002ea.	4.50
35	Pass	48-14002ea.	4.50
36	Pass	68-14002ea.	4.50
37	Pass	78-14002ea.	4.50

“Today I got my parts delivered; I'm surprised that it shipped so fast. I just want to thank you and the company for very good service. I'm most thankful because I could not get hold of these parts here in Sweden.”
Very Thankful Customer,
Pierre, Sweden

**Section 38
Glass**

GLASS

Please call for prices and availability of glass for your vehicle if it is not listed below. Please allow 2-3 weeks for delivery of all glass. Glass is drop shipped from manufacturer. Shipping charges apply to glass that is picked up at store.

Glass Kit

Includes doors, quarters, and rear window. Pickup kits include doors and back window. Windshield is NOT included. Please specify clear or green tint.

32-36	Cpe 3W	789-3WCPE-KITea.	240.00
32-39	Cpe 5W	789-5WCPE-KITea.	295.00
32-39	Sdn 2D	789-2DRSDN-KITea.	335.00
32-39	Sdn 4D	789-4DRSDN-KITea.	385.00
40-48	Cpe	789-6-8WCPE-KITea.	335.00
32-47	PU	789-3WPU-KITea.	240.00
48-56	PU	789-5WPU-KITea.	295.00

Windshield Glass

Please specify clear or green tint, body style, and original or reproduction windshield frame. Please call for prices and availability on curved glass.

32-36	Pass	789-1PC-W/Sea.	145.00
37-51	Pass	789-2PC-W/Spr.	180.00
32-36	PU	789-1PC-W/Sea.	145.00
37-47	PU	789-2PC-W/Spr.	180.00
48-52	PU	789-1PC-W/Sea.	145.00

Vent Glass

Please specify clear or green tint, and body style.

40-56	Pass	789-VNTGLASSea.	35.00
48-56	PU	789-VNTGLASSea.	35.00

Door Glass

Please specify front or rear door glass, clear or green tint, and body style.

32-56	Pass	789-DRGLASSea.	85.00
32-56	PU	789-DRGLASSea.	85.00

2 Door Sedan or Hardtop Quarter Window Glass

Please specify clear or green tint, and body style.

32-56	Sdn 2D	789-QTRGLASSea.	85.00
51-56	Hardtop 2D	789-QTRGLASSea.	85.00

4 Door Sedan Rear Door or Quarter Window Glass

The window in or behind the rear door. Please specify clear or green tint, and body style.

33-56	Sdn 4D	789-QTR-4DR-GLASSea.	35.00
-------	--------	-------------------	----------	-------

Rear Window Glass

Please specify clear or green tint, and body style. Wrap around rear window bubbled & tempered like original. These are drop shipped directly from our manufacturer.

32-40	Pass	789-BACKGLASS-Aea.	95.00
-------	------	-----------------	----------	-------

41-48	Pass	11A-7042016-A2, , except wagon and convea.	285.00
41-48	Merc	11A-7042016-A2, , except wagon and convea.	285.00
32-56	PU	789-BACKGLASS-A, flat glass..ea.	95.00
*56	PU	B6C-8142006-CL, clear, with wrap around rear window....ea.	215.00
*56	PU	B6C-8142006-TN, tinted with wrap around rear window....ea.	315.00

Section 39 Windshield

FRAME

Windshield Frame

Our windshield frames are American made steel and are available either plain or chromed. All 1932-36 Models include a new windshield seal, except Cabriolet, Convertible Sedan and Wagon.

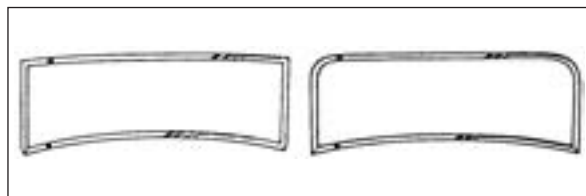

*32	Roadster	B-37105-P, plainea.	420.00
*32	Roadster	B-37105-S, chrome.....ea.	715.00
*32	Phaeton	B-37105-P, plainea.	420.00
*32	Phaeton	B-37105-S, chrome.....ea.	715.00
*32	Cpe 3W	B-45400-P, plainea.	420.00
*32	Cpe 3W	B-45400, chromeea.	715.00
*32	Cpe 5W	B-45405-P, plainea.	420.00
*32	Cpe 5W	B-45405, chromeea.	715.00
*32	Sdn	B-45405-P, plainea.	420.00
*32	Sdn	B-45405, chromeea.	715.00
*32	Cabriolet	B-761200-P, plainea.	420.00
*32	Cabriolet	B-761200-S, chrome.....ea.	715.00
*33-34	Roadster	40-37105-P, plainea.	420.00
*33-34	Roadster	40-37105-S, chromeea.	715.00
*33-34	Phaeton	40-37105-P, plainea.	420.00
*33-34	Phaeton	40-37105-S, chromeea.	715.00
*33-34	Cabriolet	40-761200-P, plain.....ea.	420.00
*33-34	Cabriolet	40-761200-S, chromeea.	715.00
*33-34	Cpe	40-701200-P, plain.....ea.	420.00
*33-34	Cpe	40-701200, chrome.....ea.	715.00
*33-34	Sdn	40-701200, chrome.....ea.	715.00
*33-34	Sdn	40-701200-P, plain.....ea.	420.00
*35-36	Roadster	68-37105-P, plainea.	420.00
*35-36	Roadster	68-37105-S, chromeea.	715.00
*35-36	Phaeton	68-37105-P, plainea.	420.00
*35-36	Phaeton	68-37105-S, chromeea.	715.00
*35-36	Cabriolet	48-761200-P, , Plain steelea.	420.00

*35-36	Cabriolet	48-761200-S, Chromeea.	715.00
*35-36	Conv Sdn	48-761200-P, , Plain steelea.	420.00
*35-36	Conv Sdn	48-761200-S, Chromeea.	715.00
*35-36	Cpe	48-701210-P, plain.....ea.	420.00
*35-36	Cpe	48-701210, chrome.....ea.	715.00
*35-36	Sdn	48-701210-P, plain.....ea.	420.00
*35-36	Sdn	48-701210, chrome.....ea.	715.00
*35-36	Wagon	48-761200-P, Plain steelea.	420.00
*35-36	Wagon	48-761200-S, Chromeea.	715.00
*32-34	PU	46-811200-P, plain, with top hinge.....ea.	420.00
*35-36	PU	50-701210-C, chrome.....ea.	715.00
*35-36	PU	50-701210-P, plain.....ea.	420.00

SWING ARMS/CORNERS

Chrome Windshield Frame Swing Arms

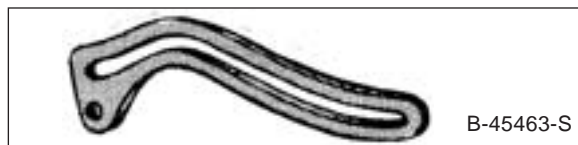

32	Cpe	B-45463-Spr.	22.00
32	Sdn	B-45463-Spr.	22.00
32-34	PU	A-45463-S.....pr.	10.00

Windshield Swing Arm Tube Nuts & Screws



28-32	Pass	1137.....kit.	2.00
28-34	PU	1137.....kit.	2.00

Windshield Frame Swing Arm Knobs



28-32	Pass	1136.....pr.	11.00
28-34	PU	1136.....pr.	11.00

Windshield Frame Swing Arm Knob Washers

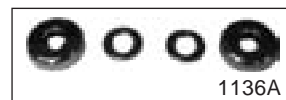

28-32	Pass	1136A.....pr.	4.00
28-34	PU	1136A.....pr.	4.00

Closed Car Windshield Frame Tube Nuts

32	Pass	1102, 10 pcs.....set.	4.50
----	------	-----------------------	------



Windshield Frame Screws



32-34	Pass & PU	3108set.	3.00
35-39	Pass & PU	3108Aset.	3.50

Windshield Frame Corners

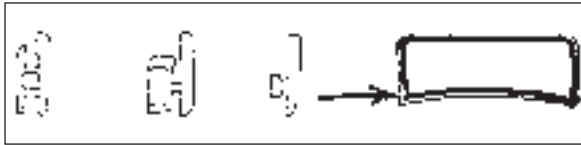

32	Cpe 3W	B-701276-Bpr.	11.00
32	Cpe 5W	B-701276-Apr.	11.00
32	Sdn	B-701276-Apr.	11.00
33-34	Cpe	40-701276-Apr.	11.00
33-34	Sdn	40-701276-Apr.	11.00
35-36	Conv Sdn	48-701276-Apr.	15.00
35-36	Cabriolet	48-701276-Apr.	15.00
35-36	Wagon	48-701276-Apr.	15.00

Windshield Frame Seam Clips

35-36	Cpe	48-701244-Apr.	15.00
35-36	Sdn	48-701244-Apr.	15.00
35-36	PU	48-701244-Apr.	15.00

REGULATOR

Windshield Regulator



33-34	Pass	40-701325ea.	80.00
-------	------	-----------	----------	-------

Windshield Regulator Repair Kit

Includes arms and rivets. USA made. Limited supply.

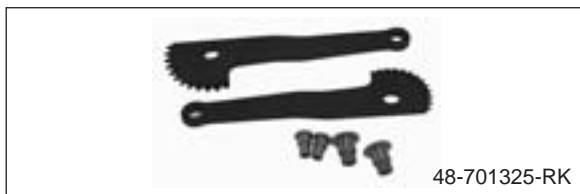

35-36	Pass	48-701325-RKkit.	160.00
35-36	PU	48-701325-RKkit.	160.00

Remanufactured Windshield Regulator

You must send in your regulator to get remanufactured. Your core is disassembled and reassembled using our repair kit. Kits are in limited supply.

35-36	Pass & PU	48-701325-REea.	225.00
-------	-----------	--------------	----------	--------

Windshield Regulator Handle

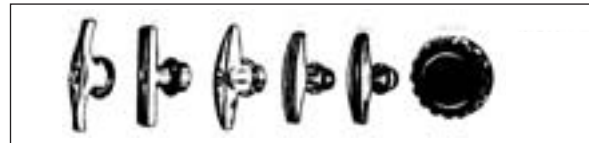

33-34	Cpe	40-701348ea.	11.00
33-34	Sdn	40-701348ea.	11.00
35	Pass	48-701347ea.	11.00
36	Pass	68-701347-Aea.	9.50
37	Pass	78-701348ea.	11.00
38	Pass	81A-701348ea.	11.00
39	Pass	91A-7003120-B, with brown rubber coverea.	50.00
35-36	PU	48-701347ea.	11.00
37	PU	78-701348ea.	11.00
38	PU	81A-701348ea.	11.00
39	PU	91A-7003120-B, with brown rubber coverea.	50.00

STANTIONS/WING NUTS/PULLS

Windshield Frame Upper Stanchion

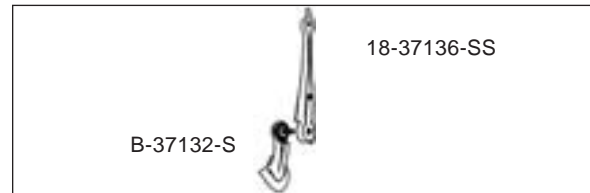

32	Roadster	18-37136-SSpr.	125.00
32	Roadster	18-37136-CHP, chopped 2"pr.	140.00
32	Phaeton	18-37136-SSpr.	125.00
32	Phaeton	18-37136-CHP, chopped 2"pr.	140.00

Windshield Stanchions

Cast brass, ready for plate or paint.

33-34	Roadster	40-37136pr.	275.00
33-34	Roadster	40-37136-CHP, chopped 2"pr.	275.00
33-34	Phaeton	40-37136pr.	275.00
33-34	Phaeton	40-37136-CHP, chopped 2"pr.	275.00

Windshield Frame Cone

32-36	Roadster	18-37154ea.	6.00
32-36	Phaeton	18-37154ea.	6.00

Windshield Pivot Stud & Cone Nut



32-36	Roadster	3109, 2 Req.ea.	2.50
32-36	Phaeton	3109, 2 Req.ea.	2.50

Windshield Frame Wing Nuts

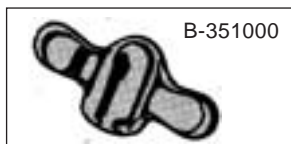

32-36	Roadster	B-351000.....pr.	14.00
32-36	Phaeton	B-351000.....pr.	14.00

Windshield Frame Lower Stanchion

32	Roadster	B-37132-S.....pr.	80.00
32	Phaeton	B-37132-S.....pr.	80.00

Windshield Frame Lower Stanchion Pads



32	Roadster	B-37132, original.....pr.	12.00
32	Phaeton	B-37132, original.....pr.	12.00
32	Roadster	B-37132-PAD, reproduction.....pr.	6.50
32	Phaeton	B-37132-PAD, reproduction.....pr.	6.50
33-34	Roadster	40-711216/7.....pr.	12.00
33-34	Phaeton	40-711216/7.....pr.	12.00
35-36	Roadster	48-711216/7.....pr.	10.00
35-36	Phaeton	48-711216/7.....pr.	10.00

Windshield Frame Finger Pulls

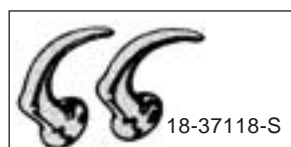

32-36	Roadster	18-37118-S.....pr.	25.00
32-36	Phaeton	18-37118-S.....pr.	25.00

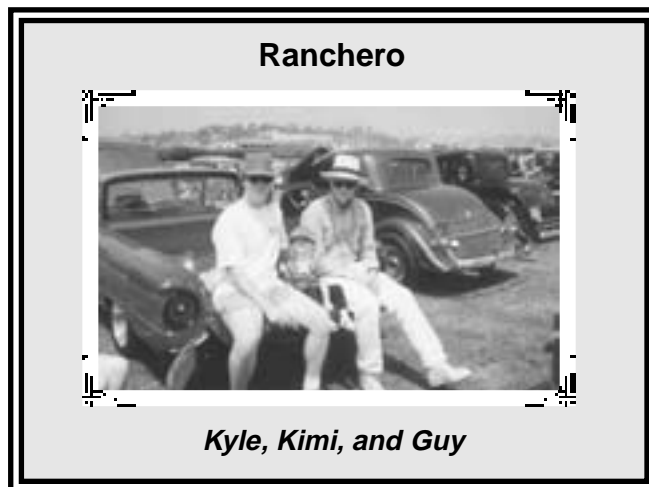

Ranchero

Kyle, Kimi, and Guy

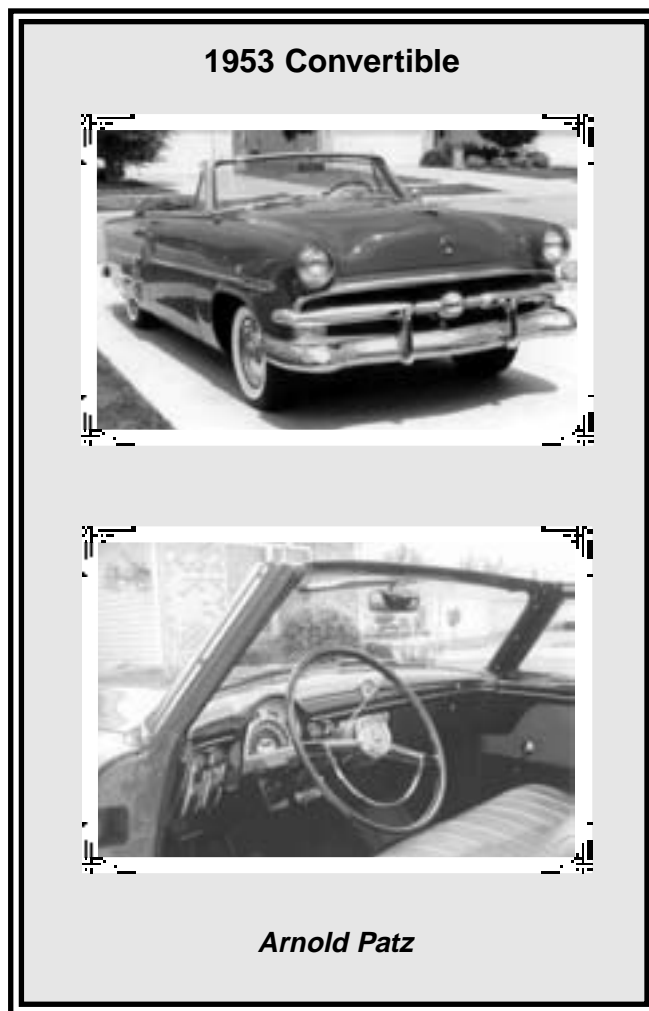

1953 Convertible

Arnold Patz



BODY STYLES

49	Ford	Tudor Sedanbody	#70A
49	Ford	Custom Tudor Sedanbody	#70B
49	Ford	Club Coupebody	#72A
49	Ford	Custom Club Coupe.....body	#72B
49	Ford	Business Coupe.....body	#72C
49	Ford	4 Door Sedan.....body	#73A
49	Ford	Custom 4Dr Sedanbody	#73B
49	Ford	Custom Conv. Coupe.....body	#76B
49	Ford	Custom Station Wagon.....body	#79
50	Ford	Custom Dlx 2Dr Sdn.....body	#70B
50	Ford	Custom Dlx Club Cpe.....body	#72B
50	Ford	Custom Dlx 4Dr Sdn.....body	#73B
50	Ford	Custom Dlx Conv. Cpe.....body	#76B
50	Ford	Custom Dlx Wgnbody	#79
50-51	Ford	Dlx Tudor Sedan.....body	#70A
50-51	Ford	Dlx Business Cpe.....body	#72C
50-51	Ford	Dlx 4Door Sedan.....body	#73A
50-51	Ford	Cstm Wgn Cntry Squire.....body	#79
51	Ford	Victoria.....body	#60
51	Ford	Custom 2Dr Sedanbody	#70B
51	Ford	Custom Club Cpe.....body	#72B
51	Ford	Custom 4Dr Sedanbody	#73B
51	Ford	Custom Conv. Cpe.....body	#76B
52-54	Ford	Crestline Victoria.....body	#60B
52-54	Ford	Customline Club Cpe.....body	#72B
52-54	Ford	Mainline Business Cpebody	#72C
52-54	Ford	Crestline Conv. Cpe.....body	#76B
52-55	Ford	Cstmline Station Wgn Country Sedan.....body	#79B
52-55	Ford	Crestline Station Wgn Country Squire.....body	#79C
52-56	Ford	Mainline 4Dr Sedanbody	#73A
52-56	Ford	Mainline Ranch Wagon.....body	#59A
52-56	Ford	Mainline Tudor Sedanbody	#70A
52-56	Ford	Customline 2Dr Sedanbody	#70B
52-56	Ford	Customline 4Dr Sedanbody	#73B
52-58	Ford	Sedan Deliverybody	#78A
54	Ford	Crestline Skyliner.....body	#60F
54	Ford	Crestline 4Dr Sedanbody	#73C
54-56	Ford	Customline Ranch Wgnbody	#59B
55	Ford	Fairlane Victoriabody	#60B
55	Ford	Customline Station Wgn Country Sdn (6 Pass)body	#79B
55-56	Ford	Fairlane Crown Victoria Solid Topbody	#64A
55-56	Ford	Fairlane Crown Vic Transparent Top.....body	#64B
55-56	Ford	Fairlane Club Sedanbody	#70C
55-56	Ford	Mainline Business 2Dr.....body	#70D
55-56	Ford	Fairlane Town Sedanbody	#73C
55-56	Ford	Fairlane Conv. Coupebody	#76B
55-56	Ford	Fairlane Station Wagon Country Sdn (8 Pass)body	#79B
55-56	Ford	Fairlane Station Wagon Country Squire (8 Pass)body	#79C
55-57	Ford	Thunderbird Convbody	#40
56	Ford	Fairlane 4Dr Victoria.....body	#57A

56	Ford	Fairlane Ranch Wagonbody	#59C
56	Ford	Fairlane Victoriabody	#64C
56	Ford	Customline Victoriabody	#64D
56	Ford	Customline Station Wagon Country Sedan (6 Pass).....body	#79D

SEALS

Windshield Seal

With or without trim is specified for a vehicle with or without groove for trim. The windshield trim is not included.

32	Roadster	B-37199ea.	25.00
32	Phaeton	B-37199ea.	25.00
32-34	Cabriolet	B-761290ea.	40.00
32	B-400	B-761290ea.	40.00
32	Cpe 3W	B-7203110ea.	30.00

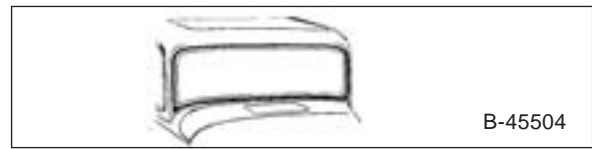

32	Cpe 5W	B-45504ea.	20.00
32	Cpe 5W	B-45504-BD, new design, with molded corners.....ea.	51.50
32	Sdn	B-45504ea.	20.00
32	Sdn	B-45504-BD, new design, with molded corners.....ea.	51.50
33-36	Roadster	40-711190.....ea.	30.00
33-36	Phaeton	40-711190.....ea.	30.00
33-34	Cabriolet	40-761290.....ea.	95.00
33-34	Cpe	40-701290.....ea.	20.00
33-34	Cpe	40-701290-BD, new design, with molded corners.....ea.	50.00
33-34	Sdn	40-701290.....ea.	20.00
33-34	Sdn	40-701290-BD, new design, with molded corners.....ea.	50.00
33-34	Wagon	B-761290ea.	40.00
35-36	Roadster	48-7103110, fits original frame ..ea.	30.00
35-36	Phaeton	48-7103110, fits original frame ..ea.	30.00
35-36	Cabriolet	48-761290.....ea.	100.00
35-36	Conv Sdn	48-761290.....ea.	100.00
35-36	Cpe	48-701290.....ea.	20.00
35-36	Cpe	48-701290-BD, new design, with molded corners.....ea.	50.00
35-36	Sdn	48-701290.....ea.	20.00
35-36	Sdn	48-701290-BD, new design, with molded corners.....ea.	50.00
35-36	Wagon	48-761290.....ea.	100.00
37-39	Cpe	78-701290-A.....ea.	20.00
37-39	Cpe	78-701290-BD, new design, with molded corners.....ea.	50.00
37-39	Sdn	78-701290-A.....ea.	20.00
37-39	Sdn	78-701290-BD, new design, with molded corners.....ea.	50.00
37-40	Conv	78-741290.....ea.	90.00
37-40	Wagon	78-741290, for Deluxe.....ea.	90.00



40	Cpe	01A-7003110pr.	75.00
40	Sdn	01A-7003110pr.	75.00
41-48	Pass	21A-7003110-A, except conv, w/o chrome trimea.	75.00
41-48	Pass	21A-7003110-B, except conv, with chrome trimea.	75.00
41-48	Conv	21A-7603110ea.	75.00
41-48	Wagon	21A-7003110-B, , with chrome trimea.	75.00

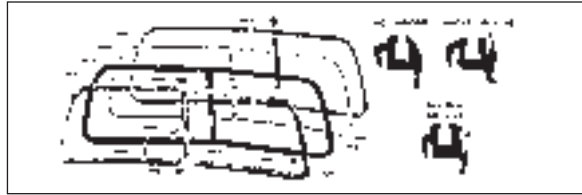

49-51	Pass	8A-7003110-D, except wagon, hardtop and conv, without chrome trimea.	80.00
49-50	Pass	8A-7003110-E, except wagon and conv, with single groove chrome trimea.	80.00
49-50	Conv	8A-7603110-B, , single groove chrome trimea.	80.00
49-50	Wagon	8A-7903110-A, , early 50, with chrome trimea.	120.00
50-51	Pass	0A-7003110, except wagon, hardtop and conv, with double groove chrome trimea.	85.00
50-51	Conv	0A-7603110, , double groove chrome trimea.	85.00
51	Hardtop 2D	0A-7603110, , double groove chrome trimea.	85.00
50-51	Wagon	0A-7903110-C, , late 50, no chrome trimea.	120.00
52-54	Pass	BA-7003110-E, body#59A,70A, 72C,73A,78, without chrome trimea.	70.00
52-54	Pass	BA-7003110-F, body#70B, 72B, 73B,79B,79C, with chrome trimea.	70.00
52-54	Pass	BA-7603110-D, , body# 60B, 76Bea.	70.00
54	Pass	BA-7603110-D, body# 60Fea.	70.00
54	Pass	BA-7003110-F, body# 73C, 59B, with chrome trimea.	70.00
55	Pass	B5A-7003110-G, body# 59A, 64A,64B,70A,70D,78 with chrome trimea.	60.00
55	Pass	B5A-7003110-H, body#60ea.	60.00
55-56	Pass	B5A-7003110-H, body #59B, 70B,70C,73B,73C,79 with chrome trimea.	60.00
55-56	Pass	B5A-7003110-J, body# 59A, 70A,70D,73A,78, with out chrome trimea.	60.00
55-56	Conv	B5A-7603110-Bea.	60.00
56	Pass	B5A-7003110-G, body# 64, 78 with chrome trimea.	60.00

56	Pass	B5A-7003110-H, body #57, 59A,70A,70D,73A,78, with chrome trimea.	60.00
39-40	Merc	99A-7003110, all body stylesea.	80.00
41-48	Merc	21A-7003110-B, except convea.	75.00
41-48	Merc Conv	21A-7603110ea.	75.00
41-48	Merc Wgn	21A-7003110-Bea.	75.00
49-51	Merc	8M-7003110, except wagonea.	90.00
49-51	Merc Wgn	8M-7903110-Aea.	175.00
52-54	Merc	BA-7003110-F, body#70B, 73B,73C,79B,79D, with chrome trimea.	70.00
52-54	Merc	BA-7603110-D, , body# 60B, 60E, 76Bea.	70.00
54	Merc	BA-7603110-D, body# 60Fea.	70.00
55	Merc	B5A-7003110-G, body #64A, 64B with chrome trimea.	60.00
55	Merc	B5A-7003110-H, except convea.	60.00
55-56	Merc Conv	B5A-7603110-Bea.	60.00
56	Merc	B5A-7003110-G, except conv, with chrome trimea.	60.00
55-57	T-Bird	B5S-4003110-Aea.	70.00
32-34	PU	46-701290ea.	15.00
35-36	PU	51-7003110ea.	25.00
37-39	PU	78-701290-Aea.	20.00
37-39	PU	78-701290-BD, new design, with molded cornersea.	50.00
40-47	PU	01A-7003110pr.	75.00
48-52	PU	7C-8103116-A, , with out chrome trimea.	40.00
51-52	PU	1C-8103110, , with chrome trimea.	40.00
53-55	PU	BAAA-8103110-Aea.	40.00
56	PU	B6C-8103110-A, , with out chrome trimea.	40.00
56	PU	B6C-8103110-B, , with chrome trimea.	40.00

Windshield Hinge Seal

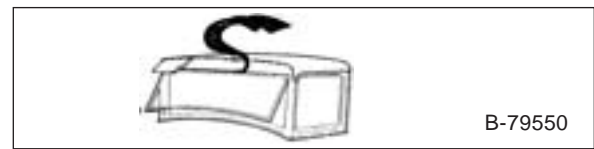

32-34	Wgn	B-79550ea.	10.00
32-34	PU	B-79550ea.	10.00

TRIM

Windshield Trim

Polished stainless. Includes right & left hand trim with joint clips and screws. These are in limited supply.

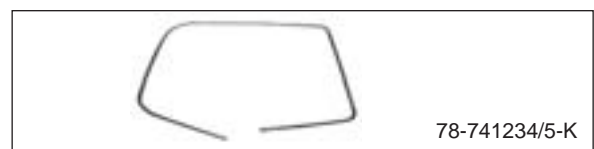

37-40	Conv	78-741234/5-Kpr.	395.00
37-40	Wagon	78-741234/5-Kpr.	395.00



Windshield Trim Seal Clips

56 PU B6C-8103117, 4 requiredea. 9.00

DIVISION BAR

Exterior Windshield Division Bar

Polished stainless.



01A-7003078

40	Pass	01A-7003078, exc. conv & wgn.....ea.	40.00
41-48	Pass	11A-7003078-B.....ea.	50.00
49-51	Wagon	8A-7903078.....ea.	105.50
41-48	Merc	11A-7003078-B.....ea.	50.00
40-47	PU	01A-7003078.....ea.	40.00

Interior Windshield Division Bar

40	Pass	01A-7003079, except conv and wagonea.	15.00
49-51	Wagon	0A-7903076-AP.....ea.	111.50

Windshield Division Bar Screws

40-41	Pass	10-32X1-Sea.	.35
41-48	Pass	10-32X1ea.	.35
41-48	Merc	10-32X1ea.	.35
40-47	PU	10-32X1-Sea.	.35

GARNISH MOLDING

Windshield Garnish Molding

40	Pass	01A-7003248/9, except conv and wagon.....pr.	150.00
40-47	PU	01A-7003248/9pr.	150.00

Upper Windshield Molding Clip



40-47	PU	01C-8103092ea.	20.00
-------	----	----------------------	-------

Lower Windshield Garnish Molding Clip

37	Cpe	78-701392.....ea.	15.00
37	Sdn	78-701392.....ea.	15.00
38-39	Cpe	81A-701392.....ea.	15.00
38-39	Sdn	81A-701392.....ea.	15.00
40-47	PU	01C-8103092ea.	20.00

Section 40 Dash

DASH

Smooth Steel Dash

18 gauge smooth steel dash without holes for street rods

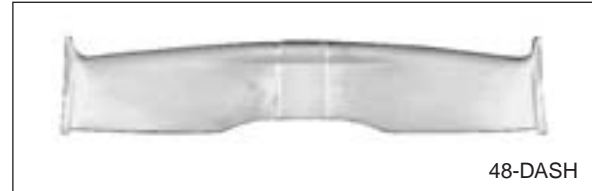

48-DASH

35-36	Cpe	48-DASH.....ea.	317.00
35-36	Sdn	48-DASH.....ea.	317.00

1932 Steel Dash Panel

Fits 5W Coupe, 2 & 4Dr Sedan, and Sedan Delivery

32	Pass	B-300, early, w/recessed top belt rail & gauge cluster openingea.	400.00
32	Pass	B-301, late, w/raised top belt rail & gauge cluster openingea.	400.00
32	Pass	B-302, late, w/raised top belt rail, no gauge cluster openingea.	400.00

1940 Steel Dash Panel

Glove box door sold separately; see section 42. A/C vents use 2" round ducting.



01A-303

40	Pass	01A-302, w/glove box opening onlyea.	495.00
40	Pass	01A-303, w/glove box, speaker, & gauge cluster openingsea.	495.00
40	Pass	01A-304-B, w/glove box, speaker, gauge cluster & black a/c vents.....ea.	575.00
40	Pass	01A-304-C, w/glove box, speaker, gauge cluster & chrome a/c vents.....ea.	575.00

1940 Steel Dash Panel A/C Vents

40	Pass	01A-350/1-B, blackea.	80.00
40	Pass	01A-350/1-C, chrome.....ea.	80.00

Dash Pad

Special order. Please allow 2-3 weeks for delivery.

56	Pass	B6A-7004290-BL, blackea.	600.00
----	------	--------------------------------	--------

GAUGES

Restored Gauge Cluster Assembly

These are restored for use with 6 volts. If you are converting to 12 volt we can have your cluster converted or you can use voltage drop part #B-10606-R, for the fuel, oil, and temperature gauges. The core charge will apply if you do not send in your rebuildable gauge cluster prior to placing your order; if it is not identical to the one purchased, or your core is not salvagable.



40	Std Pass	01A-7004320-A.....ea.	550.00
40	Std Pass	01A-7004320-ACR, core charge.....ea.	250.00
40	Dlx Pass	01A-7004320-B.....ea.	550.00
40	Dlx Pass	01A-7004320-BCR, core charge.....ea.	250.00
40	PU	01A-7004320-A.....ea.	550.00
40	PU	01A-7004320-ACR, core charge.....ea.	250.00



41-47	PU	11C-CLUSTER.....ea.	550.00
41-47	PU	11C-CLUSTER-CORE, core charge.....ea.	250.00
48-50	PU	8C-17255-RB.....ea.	550.00
48-50	PU	8C-17255-RBCORE.....ea.	200.00

Speedometer



51-52	PU	1C-17255-A.....ea.	150.00
-------	----	--------------------	--------

Mechanical Temperature Gauge

Must modify the housing on 1935-36 cars and pick-ups for reproduction gauge to fit. The face on the new gauge is a 1/16" too wide.



35-36	Pass	68-10883, see note above.....ea.	140.00
37-39	Pass	91A-10883.....ea.	160.00
35-36	PU	68-10883, see note above.....ea.	140.00
37-39	PU	91A-10883.....ea.	160.00

Temperature Gauge Conduit Clip



35-39	Pass & PU	48-10882.....ea.	1.00
-------	-----------	------------------	------

N.O.S. Temperature Gauge

Might have some shelf wear. Limited supply.

41	Pass	11A-10883-A, with red needle....ea.	50.00
41	Pass	11A-10883-B, white needle.....ea.	50.00
42	Pass	21A-10883.....ea.	50.00
46	Pass	51A-10883-A, , black with green/white.....ea.	50.00
46	Pass	51A-10883-B, black with red.....ea.	50.00
47-48	Pass	6A-10883.....ea.	75.00
39	Merc	99A-10883.....ea.	50.00
40	Merc	09A-10883.....ea.	65.00
40	Merc	09B-10883.....ea.	50.00
41	Merc	19A-10883.....ea.	50.00
42	Merc	29A-10883.....ea.	50.00

N.O.S. Fuel Gauge

Might have some shelf wear. Limited supply.

35	Pass	48-9280-A, for standard gauges..ea.	50.00
36	Pass	68-9280, for standard gauges.....ea.	75.00
36	Pass	68-9280-C, brown dial.....ea.	61.00
35	Dlx Pass	48-9280-B.....ea.	50.00
40	Dlx Pass	01A-9280-B.....ea.	50.00
42	Pass	21A-9280.....ea.	50.00
46	Pass	51A-9280-A.....ea.	50.00
46	Pass	51A-9280-B, , black face with red.....ea.	50.00
39	Merc	99A-9280.....ea.	50.00
40	Merc	09A-9280.....ea.	50.00
41	Merc	19A-9280.....ea.	50.00
42	Merc	29A-9280.....ea.	50.00
46	Merc	59A-9280.....ea.	50.00
35	PU	48-9280-A, for standard gauges..ea.	50.00
35	PU	48-9280-B, for deluxe gauges.....ea.	50.00
36	PU	68-9280, for standard gauges.....ea.	75.00
36	PU	68-9280-C, brown dial.....ea.	61.00
41-47	PU	11C-9280.....ea.	50.00

N.O.S. Battery Gauge

Might have some shelf wear. Limited supply.

35	Pass	48-10850-A, standard.....ea.	50.00
36	Pass	68-10850.....ea.	60.00
39	Pass	91A-10844-A, , studs on back of gauge.....ea.	50.00
39	Pass	91A-10850, , with loop on back of gauge.....ea.	50.00
40	Dlx	01A-10844-B.....ea.	85.00
46	Pass	51A-10850-A, black with white..ea.	50.00
46	Pass	51A-10850-B, black with red.....ea.	50.00
39	Merc	99A-10844-A.....ea.	50.00
42	Merc	29A-10850.....ea.	50.00
46	Merc	59A-10850.....ea.	50.00
36	PU	68-10850.....ea.	60.00



N.O.S. Oil Gauge

Might have some shelf wear. Limited supply.

36	Pass	68-9273, for standard gauges	ea.	50.00
39	Dlx Pass	91A-9273-B	ea.	50.00
41	Pass	11A-9273-A, red needle	ea.	50.00
41	Pass	11A-9273-B, white needle.....	ea.	50.00
42	Pass	21A-9273	ea.	50.00
46	Pass	51A-9273-A, black with white	ea.	50.00
46	Pass	51A-9273-B, black with red	ea.	50.00
49-50	Pass	8A-9273-B, red needle	ea.	50.00
51	Pass	1A-9273-A, except wagon.....	ea.	50.00
39	Merc	99A-9273	ea.	50.00
40	Merc	09A-9273	ea.	50.00
41	Merc	19A-9273	ea.	50.00
42	Merc	29A-9273	ea.	50.00
46	Merc	59A-9273	ea.	50.00
50-51	Merc	0M-9273	ea.	50.00
36	PU	68-9273, for standard gauges	ea.	50.00
41-47	PU	11C-9273	ea.	50.00
44-47	PU	41C-9273	ea.	50.00

GAUGE FACES

Speedometer Gauge Face

Fits original 90 MPH Stewart-Warner speedometer.



32	Pass	B-17255	ea.	20.00
33-34	PU	B-17255	ea.	20.00

Speedometer Face Decal

32	Pass	18-17255-80, 80 mph	ea.	25.00
32	Pass	18-17255-90, 90 mph	ea.	25.00
46	Pass	51A-17255-RD, black w/red lines.....	ea.	25.00
32-34	PU	18-17255-80, 80 mph	ea.	25.00
32-34	PU	18-17255-90, 90 mph	ea.	25.00

Speedometer Dial Glass



46	Pass	51A-17254-RD, w/red numbers	ea.	60.00
----	------	--------------------------------------	-----	-------

Speedometer Plastic Lens

Clear lens with gold painted center.

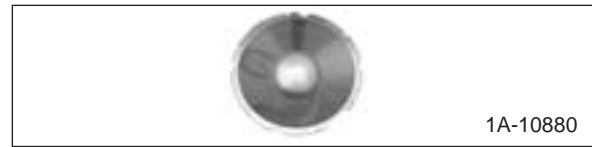

51	Pass	1A-10880, except wagon.....	ea.	45.00
----	------	-----------------------------	-----	-------

Small Gauge & Clock Decal

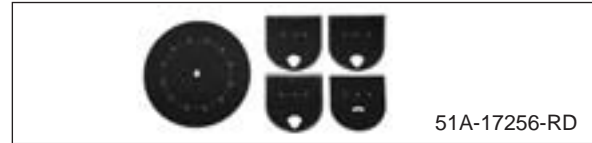

46	Pass	51A-17256-RD	set.	50.00
----	------	--------------------	------	-------

Speedometer & Gauge Lens

55	Pass	B5A-17265-A	ea.	34.50
----	------	-------------------	-----	-------

Gauge Face Kit

Not original colors. Faces have a black background with white numbers. The kit includes speedometer, battery, fuel, oil, & temperature faces.



40	Dlx Pass	01A-17255-BH	set.	60.00
----	----------	--------------------	------	-------

Gauge Face Decal Kit

33-34	Std Pass	40-17255-SET.....	set.	35.00
40	Std Pass	01A-17255-AD	set.	65.00
40	Dlx Pass	01A-17255-BD	set.	65.00

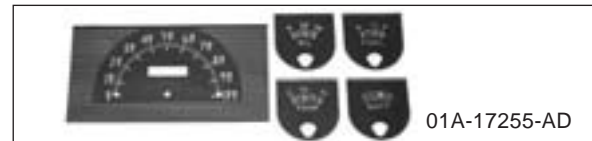

40	PU	01A-17255-AD	set.	65.00
----	----	--------------------	------	-------



41-47	PU	21C-17255-D	set.	15.00
-------	----	-------------------	------	-------



48-50	PU	8C-17255.....	kit.	50.00
-------	----	---------------	------	-------

VOLTAGE DROP

Dash Gauge Voltage Drop

Tech Tip: When using original 6 volt positive ground gauges in a 12 volt negative ground converted car, always use 6 volt positive ground voltage drops (B-10606-R) on each gauge. Gas tank sending units (01A-9275) can remain 6 volt on 12 volt cars.

Allows the use of stock gauges and sending units when converting to 12 volt. Use for fuel, oil, and temp gauge. MUST use one per gauge.



All Pass & PU B-10606-Rea. 20.00

INSTRUMENT PANEL

Instrument Panel

Has engine turned face like original.



32 Pass 18-11804ea. 95.00

Instrument Bezel for Stock Gauges



40 Dlx Pass 01A-7004401, sand w/dark grooves, w/gasket and clipskit. 60.00
 40 Dlx Pass 01A-9271-C, chromeea. 37.00



56 PU B6C-17300-C, chromeea. 60.00

Smooth Aluminum Dash Insert for VDO Gauges

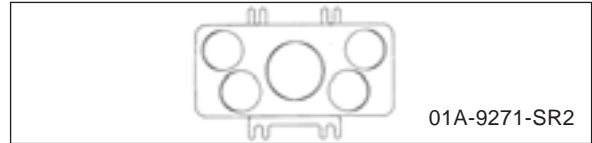

40 Pass 01A-9271-SR1, w/signal holesea. 120.00
 40 Pass 01A-9271-SR2, w/o signal holesea. 120.00
 40-47 PU 01A-9271-SR1, w/signal holesea. 120.00
 40-47 PU 01A-9271-SR2, w/o signal holesea. 120.00

Stepped Aluminum Dash Insert for VDO Gauges

40 Pass 01A-9271-SR3, w/signal holesea. 120.00
 40 Pass 01A-9271-SR4, w/o signal holesea. 120.00
 40-47 PU 01A-9271-SR3, w/signal holesea. 120.00
 40-47 PU 01A-9271-SR4, w/o signal holesea. 120.00

Aluminum Dash Insert for VDO Gauges



53-55 PU B3C-10876, use w/3-3/8" speedoea. 129.00



56 PU B6C-10876, use w/3-3/8" speedoea. 135.00

DASH PANELS

Plastic Dash Panels

41 Pass 11A-7004401-SA, tan, w/o clockpr. 100.00

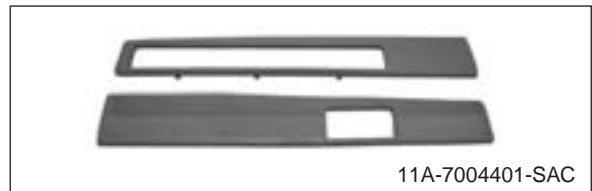

41 Pass 11A-7004401-SAC, tan, for clockset. 100.00
 42 Pass 21A-7004401-SA, maroonset. 140.00
 42 Pass 21A-7004401-SB, butterscotchset. 140.00

46 Pass 51A-7004401-SA, chocolate.....set. 140.00

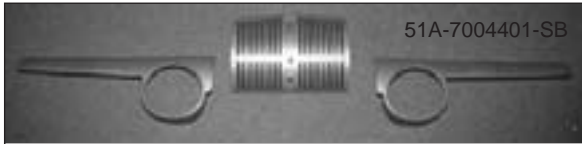

46 Pass 51A-7004401-SB, blue grayset. 140.00
 46 Conv 51A-7004401-SC, gray tanset. 140.00
 46 Wagon 51A-7004401-SC, gray tanset. 140.00
 47-48 Pass 6A-7004401-SC, gray tanset. 140.00

Metal Dash Panels

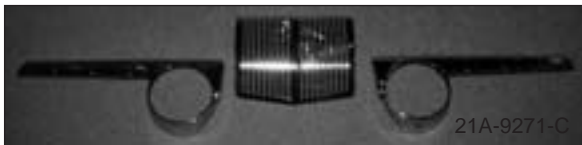

42-48 Pass 21A-9271-C, chrome.....set. 185.00



42-48 Merc M-9271-A, plain aluminum, w/Ford center.....set. 300.00

Plastic Dash Radio Hole Cover



48-50 PU 7C-8104371, tan.....ea. 15.00
 48-50 PU 7C-8104371-CC, chrome.....ea. 30.00

Plastic Dash Speaker Hole Cover

48-50 PU 7C-8104352, tan.....ea. 20.00
 48-50 PU 7C-8104352-CC, chrome.....ea. 30.00

Speedometer Plastic Dome



55 Pass B5A-17319-Cea. 29.95
 55-56 T-Bird B5A-17319-Cea. 29.95

DASH TRIM

Dash Trim Set

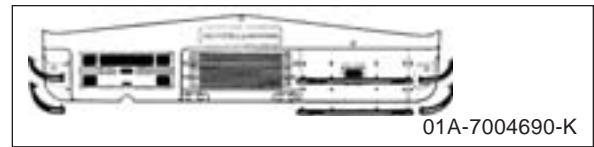

40 Dlx Pass 01A-7004690-K.....set. 75.00

Radio Speaker Grille

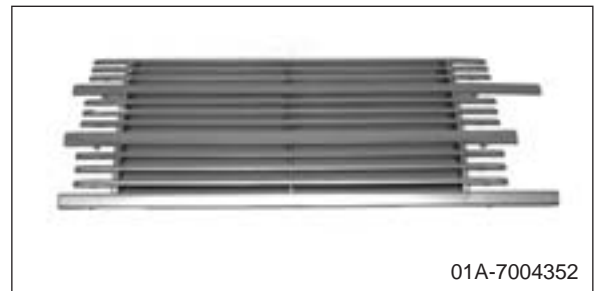

40 Pass 01A-7004352ea. 75.00

Dash Center Trim



41 Pass 11A-7004402, 3-1/2" long.....ea. 27.50

Speaker Grille Trim



42-48 Pass 21A-7004402ea. 50.00

Dash End Trim

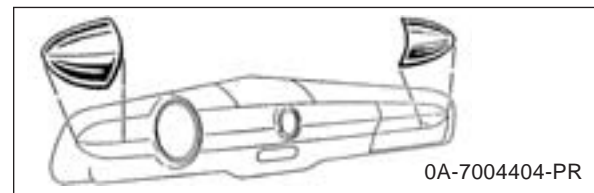

50 Pass 0A-7004404-PRpr. 60.00

Dash & Door Trim

53-55 PU BAAA-8120960-S, stainless, w/clips.....set. 60.00

Dash Trim Clips

39 Dlx Pass 91A-20020-Bset. 4.00

40 Pass 350785-SA, 16 pcs.set. 3.20

Garnish Molding Screws

53-55 PU 52388-SSGMset. 1.50

EMBLEM

Dash Emblem Plastic



51 Pass 1A-7004539ea. 35.00

Dash Emblem Plastic Bezel



51 Pass 1A-7004540-Aea. 30.00

DASH BEZELS

Ignition Dash Bezel



47-50 Pass 0A-11580-N, late 47ea. 15.00
 51-55 Pass B9S-11580-Aea. 17.50
 49 Merc 0A-11580-Nea. 15.00
 50-51 Merc 0L-11580ea. 15.00
 48-50 PU 0A-11580-Nea. 15.00
 51-52 PU 0L-11580ea. 15.00
 53-56 PU BAAA-10852-IGea. 8.00

Headlight Switch Dash Bezel



53-56 PU BAAA-10852-Lea. 8.00

Choke Cable Dash Bezel

53-56 PU BAAA-10852-Cea. 8.00

Throttle Cable Dash Bezel

53-56 PU BAAA-10852-Tea. 8.00

Wiper Switch Dash Bezel

53-56 PU BAAA-10852-Wea. 8.00

Outer Dash Bezel

Stainless ring that goes around the plastic bezels.

52 Pass B4A-10853-AR, air control, 2 requiredea. 12.95
 52 Pass B4A-10853-AR, interior lightsea. 12.95
 52 Pass B4A-10853-AR, wiperea. 12.95
 52 Pass B4A-10853-AR, chokeea. 12.95
 52 Pass B4A-10853-AR, lightsea. 12.95
 52 Pass B4A-10853-AR, ignitionea. 12.95
 54 Pass B4A-10853-AR, ignitionea. 12.95

Headlight Switch Bezel Nut



41-48 Pass 11A-11662-NORS, shelf wearea. 15.00
 55 Pass B5A-11650-Aea. 16.50
 55-56 T-Bird B5A-11650-Aea. 16.50
 41-50 PU 11A-11662-NORS, shelf wearea. 15.00



53-54 PU FAB-11662-Aea. 6.00
 55-56 PU C2TZ-11650-Aea. 7.00

Wiper Switch Bezel Nut

51-56 Pass 1A-13753-Aea. 14.95
 51-52 PU 7C-17512-Bea. 5.50
 53-60 PU B7C-17512-Aea. 8.50

Heater Switch Bezel Nut

51-56 Pass 1A-13753-Aea. 14.95

Dash Bezel Nut Tool



All Pass & PU TOOL-10852ea. 10.00

DASH RUBBER/GROMMETS

Choke & Throttle Dash Grommets

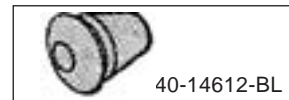

32-37 Pass 40-14612-BL, blackpr. 2.00
 32-37 Pass 40-14612-BR, brownpr. 2.00
 32-37 Pass 40-14612-GY, graypr. 2.00
 38-40 Pass 81A-9719, rubberpr. 5.00

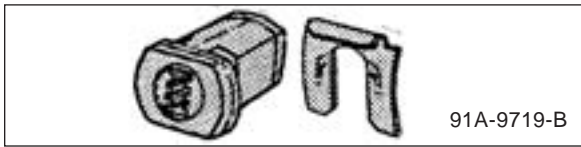

91A-9719-B

39-40	Pass	91A-9719B, rubber w/metal	pr.	45.00
39-40	Merc	91A-9719B, rubber w/metal	pr.	45.00
32-39	PU	40-14612-BL, black	pr.	2.00
32-39	PU	40-14612-BR, brown.....	pr.	2.00
32-39	PU	40-14612-GY, gray.....	pr.	2.00
40-47	PU	81A-9719, rubber.....	pr.	5.00
40-47	PU	91A-9719B, rubber w/metal	pr.	45.00

Choke & Throttle Dash Grommet Clips



91A-9718-B

39-48	Pass	91A-9718-B	pr.	15.00
39-48	Merc	91A-9718-B	pr.	15.00
40-47	PU	91A-9718-B	pr.	15.00

Dash Bezel Seals



FAA-10868-B

52	Pass	FAA-10868-B, 5 pcs	set5.	15.00
54	Pass	FAA-10868-B, 5 pcs	set5.	15.00
55-59	T-Bird	FAA-10868-B, 5 pcs	set5.	15.00

Instrument Cluster Lens Seal Kit



B6A-17248-S

56	Pass	B6A-17248-S	kit.	5.50
57	T-Bird	B6A-17248-S	kit.	5.50

Speedometer to Dash Seal

56	PU	B6C-17310-S	ea.	6.00
----	----	-------------------	-----	------

Garnish Molding to Dash Seal

52-55	Pass	BA-7003127-A, 82".....	ea.	8.50
56	Pass	B6A-7003127-A	ea.	6.50

DASH KNOB KITS

Dash Knob Kits



B-9270

32	Pass	B-9270, 4 cyl., mahogany	kit.	25.00
----	------	-----------------------------------	------	-------

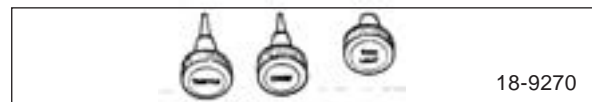

18-9270

32	Pass	18-9270, V-8, mahogany	kit.	20.00
----	------	---------------------------------	------	-------

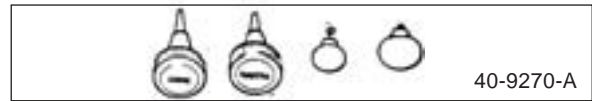

40-9270-A

33	Pass	40-9270-A, mahogany	kit.	24.00
----	------	---------------------------	------	-------



40-9270-B

34	Pass	40-9270-B, brn marble.....	kit.	24.00
----	------	----------------------------	------	-------

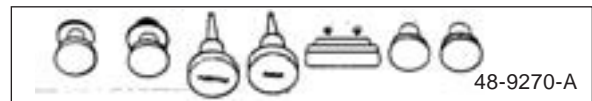

48-9270-A

35	Std Pass	48-9270-A, maroon.....	kit.	40.00
----	----------	------------------------	------	-------

35	Dlx Pass	48-9270-B, ivory.....	kit.	40.00
----	----------	-----------------------	------	-------

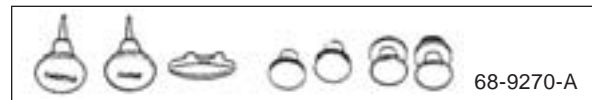

68-9270-A

36	Std Pass	68-9270-A, early, dark brown.....	kit.	40.00
----	----------	--------------------------------------	------	-------

36	Dlx Pass	68-9270-B, early, light gray	kit.	40.00
----	----------	---------------------------------------	------	-------

36	Pass	68-9270-C, late, gray marble	kit.	40.00
----	------	---------------------------------------	------	-------



78-9270-A

37	Std Pass	78-9270-A, lt. brown.....	kit.	40.00
----	----------	---------------------------	------	-------

37	Dlx Pass	78-9270-B, yellow brown.....	kit.	40.00
----	----------	---------------------------------	------	-------



81A-9270

38	Pass	81A-9270, ivory.....	kit.	32.50
----	------	----------------------	------	-------

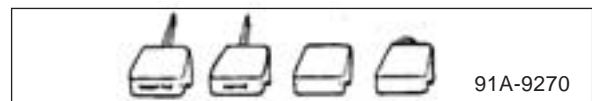

91A-9270

39	Pass	91A-9270, yellow.....	kit.	30.00
----	------	-----------------------	------	-------

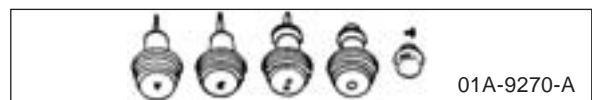

01A-9270-A

40	Std Pass	01A-9270-A, sand.....	kit.	35.00
----	----------	-----------------------	------	-------

40	Dlx Pass	01A-9270-B, maroon.....	kit.	35.00
----	----------	-------------------------	------	-------



41 Pass 11A-9270, light tan.....kit. 46.00

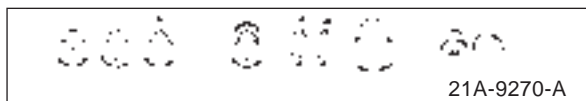

42 Dlx Pass 21A-9270-A, maroon.....kit. 60.00
 42 Super Dlx 21A-9270-B, butterscotch.....kit. 60.00
 46 Dlx Pass 51A-9270-A, brown.....kit. 60.00
 46 Super Dlx 51A-9270-B, blue gray.....kit. 60.00
 46 Super Dlx 51A-9270-C, gray tan.....kit. 60.00

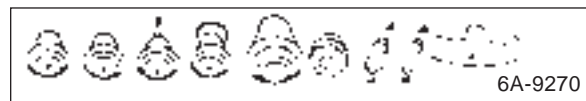

47-48 Pass 6A-9270, gray tan.....kit. 60.00
 50 Pass 0A-9270-BS, ivory exc. conv & crestliner.....kit. 45.00
 50 Crestliner 0A-9270-DS, black.....kit. 47.50
 50 Conv 0A-9270-CS, ivory, w/black gear shift knob.....kit. 45.00



39 Merc 99A-9270, pinkish.....kit. 55.00

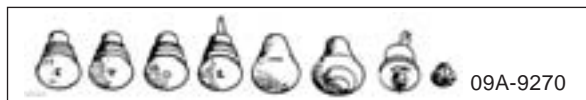

40 Merc 09A-9270, dark blue.....kit. 70.00
 56 PU B6C-9270-K, black.....kit. 20.00

HEADLIGHT KNOBS

Headlight Switch Knob with Shaft



40 Std Pass 01A-11661-A, sand.....ea. 8.00
 40 Dlx Pass 01A-11661-B, maroon.....ea. 8.00
 41 Pass 11A-11661, tan.....ea. 8.00
 42 Dlx Pass 21A-11661-A, maroon.....ea. 8.00
 42 Super Dlx 21A-11661-B, butterscotch.....ea. 8.00
 46 Dlx Pass 51A-11661-A, brown.....ea. 8.00
 46 Super Dlx 51A-11661-B, blue-gray.....ea. 8.00
 46 Super Dlx 51A-11661-C, gray-tan.....ea. 8.00
 47-48 Pass 6A-11661, gray tan.....ea. 8.00
 50 Pass 0A-11661-B, ivory.....ea. 9.00
 50 Pass 0A-11661-C, black.....ea. 9.50
 40 Merc 09A-11661.....ea. 10.00

40 PU 01A-11661-A.....ea. 8.00
 41-47 PU 11C-11661.....ea. 8.00
 48-50 PU 7C-11661.....ea. 8.50
 51-52 PU 1C-11661-A.....ea. 8.50
 53-55 PU BAAA-11661.....ea. 8.50
 56 PU B6C-11661.....ea. 8.50

TURN SIGNAL KNOBS

Turn Signal Switch Lever Knob



49-53 Pass 1A-13305, black.....ea. 6.00
 50 Pass 0A-13305-B, ivory.....ea. 6.00
 54-56 Pass B4A-13305, black.....ea. 6.00
 50-53 Merc 1M-13305-A.....ea. 25.00
 55-57 T-Bird B4A-13305, black.....ea. 6.00
 48-56 PU 1A-13305, black.....ea. 6.00

DASH LIGHT/DIMMER

Dash Board Jewel

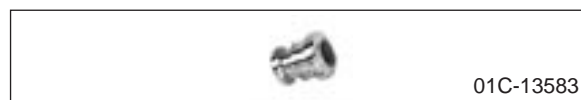

38-40 Pass 91A-13583.....ea. 10.00
 40-41 Sdn Dly 91A-13583.....ea. 10.00
 38-39 PU 91A-13583.....ea. 10.00
 40-52 PU 01C-13583.....ea. 10.00

High Beam Socket and Wire



38-40 Pass 81A-13580.....ea. 30.00
 39-40 Merc 81A-13580.....ea. 30.00
 38-47 PU 81A-13580.....ea. 30.00

Dash Light Switch

Can not use with original knob.



33-38 Pass 40-13740.....ea. 11.00
 39 Std Pass 40-13740.....ea. 11.00
 33-51 PU 40-13740.....ea. 11.00



Dash Light Dimmer Switch



40	Std Pass	01A-13740-A, sand	ea.	25.00
40	Dlx Pass	01A-13740-B, maroon.....	ea.	25.00
42	Dlx Pass	21A-13740-A, maroon	ea.	25.00
42	Super Dlx	21A-13740-B, butterscotch	ea.	25.00
46	Dlx Pass	51A-13740-A, brown.....	ea.	25.00
46	Super Dlx	51A-13740-B, blue-gray.....	ea.	25.00
46	Super Dlx	51A-13740-C, gray-tan.....	ea.	25.00
47-48	Pass	51A-13740-C, gray-tan.....	ea.	25.00
42-48	Merc	29A-13740, black	ea.	30.00
41-47	PU	29A-13740, black	ea.	30.00

Dash Light Switch Knob

32	Pass	18-13741, mahogany	ea.	7.00
35	Std Pass	48-13741-A, maroon	ea.	7.00
35	Dlx Pass	48-13741-B, ivory.....	ea.	7.00
36	Std Pass	68-13741-A, early, dark brown....	ea.	7.00
36	Dlx Pass	68-13741-B, early, light gray.....	ea.	7.00
36	Pass	68-13741-C, late, gray marble.....	ea.	7.00
37	Std Pass	78-13741-A, light brown	ea.	7.00
37	Dlx Pass	78-13741-B, yellow brown	ea.	7.00
39	Merc	99A-13740, pinkish	ea.	10.00
41	Pass	11A-13741, tan.....	ea.	7.00

Interior Lamp Knob

50	Pass	0A-13755-B, ivory.....	ea.	5.50
50	Pass	0A-13755-C, black	ea.	6.00

CHOKER/THROTTLE KNOBS

Choke Cable/Rod Knob

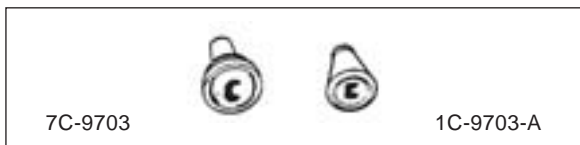

32	Pass	B-9703, 4 cyl. mahogany.....	ea.	7.00
32-33	Pass	18-9703, V-8, mahogany.....	ea.	7.00
34	Pass	40-9703, brown marble.....	ea.	7.00
35	Std Pass	48-9703-A, maroon	ea.	7.00
35	Dlx Pass	48-9703-B, ivory.....	ea.	7.00
36	Std Pass	68-9703-A, early, dark brown....	ea.	7.00
36	Dlx Pass	68-9703-B, early, light gray.....	ea.	7.00
36	Pass	68-9703-C, late, gray marble.....	ea.	7.00
37	Std Pass	78-9703-A, light brown	ea.	7.00
37	Dlx Pass	78-9703-B, yellow brown	ea.	7.00
38	Pass	81A-9703, ivory.....	ea.	10.00
39	Pass	91A-9703, yellow	ea.	9.00
40	Std Pass	01A-9703-A, sand	ea.	8.00
40	Dlx Pass	01A-9703-B, maroon.....	ea.	8.00
41	Pass	11A-9703, tan.....	ea.	7.00

42	Dlx Pass	21A-9703-A, maroon	ea.	7.00
42	Super Dlx	21A-9703-B, butterscotch	ea.	7.00
46	Dlx Pass	51A-9703-A, brown.....	ea.	7.00
46	Super Dlx	51A-9703-B, blue gray	ea.	7.00
46	Super Dlx	51A-9703-C, gray tan	ea.	7.00
47-48	Pass	6A-9703, gray tan.....	ea.	7.00
50	Pass	0A-9700-B, ivory.....	ea.	5.50
50	Pass	0A-9700-C, black	ea.	6.00
39	Merc	99A-9703, pinkish	ea.	10.00
40	Merc	09A-9703, blue	ea.	10.00
32	PU	B-9703, 4 cyl. mahogany.....	ea.	7.00
32-34	PU	18-9703, V-8 mahogany.....	ea.	7.00
35-39	PU	68-9703-A, dark brown	ea.	7.00
41-47	PU	11C-9703	ea.	8.00
48-50	PU	7C-9703	ea.	5.50
51-52	PU	1C-9703-A.....	ea.	5.50
53-56	PU	BAAA-9700.....	ea.	5.00

Throttle Cable/Rod Knob



32-33	Pass	18-9778, mahogany	ea.	7.00
34	Pass	40-9778, brown marble.....	ea.	7.00
35	Std Pass	48-9778-A, maroon	ea.	7.00
35	Dlx Pass	48-9778-B, ivory.....	ea.	7.00
36	Std Pass	68-9778-A, early, dark brown....	ea.	7.00
36	Dlx Pass	68-9778-B, early, light gray.....	ea.	7.00
36	Pass	68-9778-C, late, gray marble.....	ea.	7.00
37	Std Pass	78-9778-A, light brown	ea.	7.00
37	Dlx Pass	78-9778-B, yellow brown	ea.	7.00
38	Pass	81A-9778, ivory.....	ea.	10.00
39	Pass	91A-9778, yellow	ea.	9.00
40	Std Pass	01A-9778-A, sand	ea.	8.00
40	Dlx Pass	01A-9778-B, maroon.....	ea.	8.00
41	Pass	11A-9778, tan.....	ea.	7.00
42	Dlx Pass	21A-9778-A, maroon	ea.	7.00
42	Super Dlx	21A-9778-B, butterscotch	ea.	7.00
46	Dlx Pass	51A-9778-A, brown.....	ea.	7.00
46	Super Dlx	51A-9778-B, blue gray	ea.	7.00
46	Super Dlx	51A-9778-C, gray tan.....	ea.	7.00
47-48	Pass	6A-9778, gray tan.....	ea.	7.00
39	Merc	99A-9778, pinkish	ea.	10.00
40	Merc	09A-9778, dark blue.....	ea.	10.00
32-34	PU	18-9778, mahogany	ea.	7.00
35-39	PU	68-9778-A, dark brown	ea.	7.00
40	PU	01A-9778-A, sand	ea.	8.00
41-47	PU	11C-9778	ea.	8.00
48-50	PU	7C-9778	ea.	5.50
51-52	PU	1C-9778-A.....	ea.	5.50
53-56	PU	BAAA-9700.....	ea.	5.00

HOOD PULL KNOB

Hood Pull Cable Knob



11A-16917

41	Pass	11A-16917, tan.....ea.	7.00
42	Dlx Pass	21A-16918-A, maroon.....ea.	8.00
42	Super Dlx	21A-16918-B, butterscotch.....ea.	8.00
46	Dlx Pass	51A-16918-A, brown.....ea.	8.00
46	Super Dlx	51A-16918-B, blue gray.....ea.	8.00
46	Super Dlx	51A-16918-C, gray tan.....ea.	8.00



6A-16918

47-48	Pass	6A-16918, gray tan.....ea.	8.00
-------	------	----------------------------	------

AIR VENT

Air Vent Cable Knob

50	Pass	0A-18547-B, ivory.....ea.	5.50
50	Pass	0A-18547-C, black.....ea.	6.00

Fresh Air Control Lever Knob

50-51	Merc	1A-13305, 2 req'd.....ea.	6.00
-------	------	---------------------------	------

HEATER KNOB

Heater Motor, Air, Defrost, & Temperature



BAAA-9700

48-50	PU	7C-9700.....ea.	5.50
51-52	PU	1C-9700.....ea.	5.50
53-56	PU	BAAA-9700.....ea.	5.00

WIPER KNOB

Wiper Switch Knob

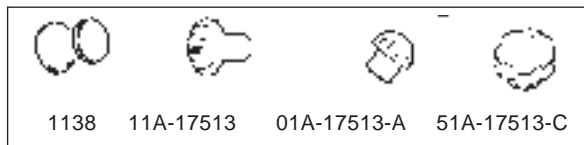

1138 11A-17513 01A-17513-A 51A-17513-C

28-36	Pass	1138, chrome.....ea.	3.00
37	Std Pass	78-17513-A, light brown.....ea.	6.00
37	Dlx Pass	78-17513-B, yellow brown.....ea.	6.00
37	Wagon	78-17513-A, light brown.....ea.	6.00
38	Conv	81A-17513-B, ivory.....ea.	6.00
38	Pass	81A-17513-A, ivory, exc. conv & wgn.....ea.	6.00
38	Wagon	81A-17513-B, ivory.....ea.	6.00
39	Conv	91A-17513-B, yellow.....ea.	6.00

39	Pass	91A-17513-A, yellow, exc. conv & wgn.....ea.	6.00
39	Wagon	91A-17513-B, yellow.....ea.	6.00
40	Std Pass	01A-17513-A, sand.....ea.	6.00
40	Dlx Pass	01A-17513-B, maroon.....ea.	6.00
41	Pass	11A-17513, tan.....ea.	7.00
42	Dlx Pass	21A-17513-A, maroon.....ea.	8.00
42	Super Dlx	21A-17513-B, butterscotch.....ea.	8.00
46	Dlx Pass	51A-17513-A, brown.....ea.	8.00
46	Super Dlx	51A-17513-B, blue gray.....ea.	8.00
46	Super Dlx	51A-17513-C, gray tan.....ea.	8.00
47-48	Pass	51A-17513-C, gray tan.....ea.	8.00
50	Pass	0A-17513-B, ivory.....ea.	5.50
50	Pass	0A-17513-C, black.....ea.	6.00
39	Merc	99A-17513, pinkish.....ea.	6.00
40	Merc	09A-17513, dark blue.....ea.	7.00
28-36	PU	1138, chrome.....ea.	3.00
40-41	PU	01A-17513-A, sand.....ea.	6.00
42-47	PU	21C-17513.....ea.	6.00
48-52	PU	1C-17513-A.....ea.	5.50
53-56	PU	BAAA-17513.....ea.	5.50

COWL VENT KNOB

Cowl Vent Knobs

37	Std Pass	78-7002145-A, light brown.....ea.	8.00
37	Dlx Pass	78-7002145-B, yellow brown.....ea.	8.00
38	Pass	81A-7002145, ivory.....ea.	8.00
39	Pass	91A-7002145, yellow.....ea.	8.00
40	Std Pass	01A-7002145-A, sand.....ea.	8.00
40	Dlx Pass	01A-7002145-B, maroon.....ea.	8.00
41	Pass	11A-7002145, tan, flat shaft.....ea.	8.00
41	Pass	11A-7213, tan, round shaft.....ea.	8.00
42-48	Pass	21A-7002145-B, black.....ea.	8.00
42	Dlx Pass	21A-7213-A, maroon.....ea.	8.00
42	Super Dlx	21A-7213-B, butterscotch.....ea.	8.00
46	Dlx Pass	51A-7213-A, brown.....ea.	8.00
46	Super Dlx	51A-7213-B, blue gray.....ea.	8.00
46	Super Dlx	51A-7213-C, gray tan.....ea.	8.00
47-48	Pass	51A-7213-C, gray tan.....ea.	8.00
39	Merc	99A-7002145, pinkish.....ea.	10.00
40	Merc	09A-7002145, dark blue.....ea.	10.00
40	PU	01A-7002145-A, sand.....ea.	8.00
41-47	PU	11C-8102145, black.....ea.	8.00
53-56	PU	BAAA-8102145, with rivets.....ea.	5.50

LIGHTER ASSEMBLY

Cigar Lighter Well



B-15055

B-15055-R

32-34	Pass	B-15055.....ea.	33.00
-------	------	-----------------	-------



32-34 Pass B-15055-R, for use w/o elementea. 28.00

Cigar Lighter Assembly with Well

For use with studded cigar knobs.



35-37	Pass	11A-15055ea.	22.50
40	Pass	11A-15055, w/o radioea.	22.50
41-55	Pass	11A-15055ea.	22.50
56	Pass	B6C-15055-A, 12Vea.	16.50
41-55	Merc	11A-15055ea.	22.50
48-55	PU	11A-15055ea.	22.50
56	PU	B6C-15055-A, 12Vea.	16.50

LIGHTER KNOBS

Cigar Lighter Knob w/Green Eye

This is for looks only. It does not function the lighter.



32 Pass B-15053ea. 30.00



33-34 Pass 40-15053-Rea. 30.00

Cigar Lighter Knob



35	Std Pass	48-701638-A, maroonea.	7.00
35	Dlx Pass	48-701638-B, ivoryea.	7.00
36	Std Pass	68-701638-A, early, dark brownea.	7.00
36	Dlx Pass	68-701638-B, early, light grayea.	7.00
36	Pass	68-701638-C, late, gray marbleea.	7.00
37	Std Pass	78-15053-A, light brownea.	7.00
37	Dlx Pass	78-15053-B, yellow brownea.	7.00
38	Pass	81A-15053, ivoryea.	8.00
39	Pass	91A-15053, yellowea.	8.00
40	Std Pass	01A-15053-A, sandea.	8.00
40	Dlx Pass	01A-15053-B, maroonea.	8.00
39	Merc	99A-15053, pinkishea.	10.00
40	Merc	09A-15053, dark blueea.	10.00

Cigar Lighter Knob with Stud

For use with replacement element and well.



35	Std Pass	48-15053-AR, maroonea.	10.00
35	Dlx Pass	48-15053-BR, ivoryea.	10.00
36	Std Pass	68-15053-AR, early, dark brownea.	10.00
36	Dlx Pass	68-15053-BR, early, light grayea.	10.00
36	Pass	68-15053-CR, late, gray marbleea.	10.00
37	Std Pass	78-15053-AR, light brownea.	10.00
37	Dlx Pass	78-15053-BR, yellow brownea.	10.00
40	Std Pass	01A-15053-AR, sandea.	10.00
40	Dlx Pass	01A-15053-BR, maroonea.	10.00
41	Pass	11A-701638, tanea.	8.00
42	Dlx Pass	21A-701638-A, maroonea.	8.00
42	Super Dlx	21A-701638-B, butterscotchea.	8.00
46	Dlx Pass	51A-701638-A, brownea.	8.00
46	Super Dlx	51A-701638-B, blue grayea.	8.00
46	Super Dlx	51A-701638-C, gray tanea.	8.00
47-48	Pass	6A-701638, gray tanea.	8.00
50	Pass	0A-15052-B, ivoryea.	7.00
50	Pass	0A-15052-C, blackea.	7.50
48-50	PU	7C-15052ea.	6.50
51-52	PU	1C-15052-Aea.	6.50
53-56	PU	BAAA-15052ea.	5.50

ASH TRAY

Ash Tray

33-34 Pass 40-9272-ATea. 30.00



40 Pass 01A-7004804/5, pull-out style, no knobspr. 90.00

Ash Tray Retainer



40 Pass 01A-7004802/3, for pull out style.....pr. 45.00

Front Ash Tray Knobs



33 Pass 40-701606-A, mahoganyea. 6.00
 34 Pass 40-701606-B, brown marble.....ea. 6.00
 36 Std Pass 68-701606-A, early, dark brown..ea. 6.00
 36 Dlx Pass 68-701606-B, early, light gray....ea. 6.00
 36 Pass 68-701606-C, late, gray marble...ea. 6.00
 37 Std Pass 78-701606-A, light brown.....ea. 7.00
 37 Dlx Pass 78-701606-B, yellow brown.....ea. 7.00



38 Pass 81A-701606, ivory.....ea. 8.00
 39 Pass 91A-701606, yellowea. 8.00
 40 Std Pass 01A-701606-A, sand.....pr. 8.00
 40 Dlx Pass 01A-701606-B, maroonpr. 8.00
 42 Dlx Pass 21A-701606-A, maroon.....pr. 9.00
 42 Super Dlx 21A-701606-B, butterscotch.....pr. 9.00
 46 Dlx Pass 51A-701606-A, brownpr. 9.00
 46 Super Dlx 51A-701606-B, blue gray.....pr. 9.00
 46 Super Dlx 51A-701606-C, gray tanpr. 9.00



47-48 Pass 51A-701606-C, gray tanpr. 9.00
 39 Merc 99A-701606, pinkish.....pr. 18.00
 48-50 PU 7C-8101656ea. 4.50
 53-56 PU BAAA-8101656.....ea. 4.50

Rear Seat Ash Tray Knobs

38 Pass 81A-7330710, ivory.....pr. 12.50

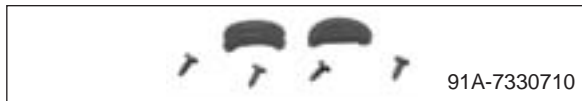

39 Pass 91A-7330710, yellow.....pr. 12.50
 50 Pass 0A-7030710-B, ivory.....ea. 5.50
 50 Pass 0A-7030710-C, blackea. 6.00
 39 Merc 99A-7330710, pinkish.....pr. 12.50

GLOVE BOX KNOBS

Glove Box Door Knob



33 Pass 40-701656-A, mahoganyea. 6.00
 34 Pass 40-701656-B, brown marble.....ea. 6.00
 35 Std Pass 48-701656-A, maroonea. 7.00
 35 Dlx Pass 48-701656-B, ivory.....ea. 7.00
 36 Std Pass 68-701656-A, early, dark brown..ea. 7.00
 36 Dlx Pass 68-701656-B, early, light gray....ea. 7.00
 36 Pass 68-701656-C, late, gray marble...ea. 7.00
 32-34 PU 40-701656-A.....ea. 6.00



35-39 PU 68-701656-A.....ea. 7.00
 53-56 PU BAAA-8101656.....ea. 4.50

CLOCK PARTS

Clock

Must use original clock mounting plate. No provision for light socket. Uses one AA battery.



40 Pass 01A-15000, battery poweredea. 90.00

Mirror Clock Face



28-35 Pass B-15034ea. 10.00
 35-36 Pass 48-15034-G, early.....ea. 10.00
 36 Pass 68-15034-M.....ea. 10.00



Glove Box Clock Face

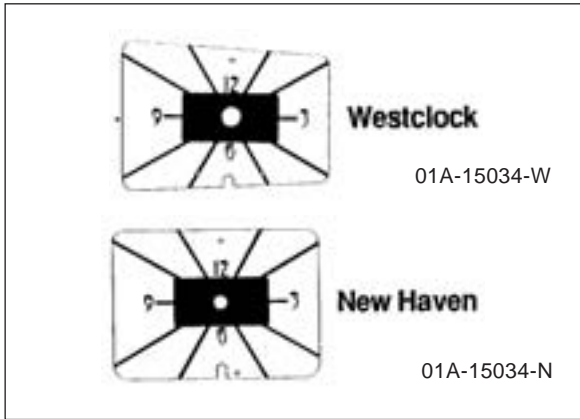

36	Pass	68-15034-G.....ea.	10.00
40	Pass	01A-15034-N, new havenea.	10.00
40	Pass	01A-15034-W, westclockea.	10.00

Clock Bezel



40	Pass	01A-15030, sand.....ea.	20.00
40	Pass	01A-9272-CPCD, chromeea.	20.00

Clock Knob



38	Pass	81A-15032, ivory.....ea.	6.00
39	Pass	91A-15032, yellowea.	6.00
40	Pass	01A-15032, sand.....ea.	6.00
39	Merc	99A-15032, pinkishea.	6.00

Clock Cover



49-50	Pass	8A-9273-CC, except wagonea.	43.00
-------	------	-----------------------------------	-------

ANTENNA HOLE PLUGS

Antenna Hole Plug for Dash



40	Std Pass	01A-7004395-A, sandea.	6.00
40	Dlx Pass	01A-7004395-B, maroon.....ea.	6.00
41	Pass	11A-7004395, tan.....ea.	6.00
42	Dlx Pass	21A-7004395-A, maroonea.	6.00
42	Super Dlx	21A-7004395-B, butterscotchea.	6.00
46	Dlx Pass	51A-7004395-A, brown.....ea.	6.00
46	Super Dlx	51A-7004395-B, blue grayea.	6.00
46	Super Dlx	51A-7004395-C, gray tan.....ea.	6.00
47-48	Pass	51A-7004395-C, gray tan.....ea.	6.00
40	Merc	09A-7004395, dark blue.....ea.	6.00

Antenna Hole Plug for Windshield Header



41-48	Conv	11A-7603454-R, brown.....ea.	10.00
41-48	Merc	11A-7603454-R, brown.....ea.	10.00

OVERDRIVE KNOBS

Columbia Overdrive Knob



37	Std Pass	78-4001-A, light brownea.	10.00
37	Dlx Pass	78-4001-B, yellow brownea.	10.00
38	Pass	81A-4001, ivory.....ea.	10.00
39	Pass	91A-4001, yellowea.	10.00
40	Std Pass	01A-4001-AB, sand.....ea.	10.00
40	Dlx Pass	01A-4001-BB, maroonea.	10.00
40	Merc	09A-4001, dark blue.....ea.	10.00

IGNITION CYLINDER/SWITCH PARTS

Ignition On/Off Switch Plate

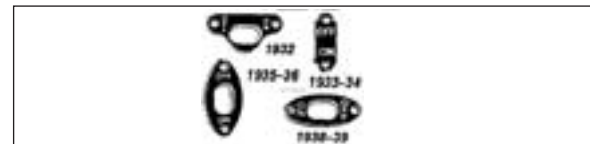

32	Pass	B-11556ea.	8.00
33-34	Pass	40-11556.....ea.	8.00
35-36	Pass	48-11556.....ea.	8.00
37	Pass	78-11556.....ea.	8.00
38-39	Pass	81A-11556.....ea.	8.00
40-47	Pass	78-11556.....ea.	8.00
41-47	Merc	78-11556.....ea.	8.00

32	PU	B-11556ea.	8.00
33-34	PU	40-11556ea.	8.00
35-37	PU	48-11556ea.	8.00
38-47	PU	81A-11556ea.	8.00

Ignition Switch On/Off Knob

39	Merc	99A-3690, pinkishea.	10.00
----	------	-------------------	----------	-------

Ignition Switch Cylinder & Keys

Includes 68-3729 pin.



35-47	Pass	48-3686, early 47kit.	18.00
39-47	Merc	48-3686, early 47kit.	18.00
35-47	PU	48-3686kit.	18.00

Ignition Switch Plate Case

38-40	Pass	81A-3712, good usedea.	10.00
38-47	PU	81A-3712, good usedea.	10.00

Ignition Switch Body & Brush

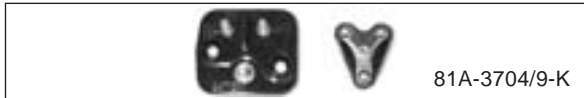

38-40	Pass	81A-3704/9-Kset.	20.00
38-47	PU	81A-3704/9-Kset.	20.00

Ignition Switch Body



32-37	Pass	B-3704ea.	10.52
38-40	Pass	81A-3704ea.	16.92
41-48	Pass	09A-3704ea.	15.96
41-48	Merc	09A-3704ea.	15.96
32-37	PU	B-3704ea.	10.52
38-47	PU	81A-3704ea.	16.92

Ignition & Door Key Blank-Concours Type

The 1932-48 keys have the correct "Hurd" logo. 1949-56 Keys have the correct "Ford" logo.



32-38	Pass	B-3685-Aea.	5.00
39-48	Pass	91A-3685ea.	5.00
49-50	Pass	8A-3685-Aea.	4.50
51	Pass	1A-3685-Aea.	4.50
52-56	Pass	BA-3685-Aea.	2.50
39-48	Merc	91A-3685ea.	5.00

52-56	Merc	BC-3685-Aea.	5.00
32-38	PU	B-3685-Aea.	5.00
39-47	PU	91A-3685ea.	5.00
48-52	PU	1A-3685-Aea.	4.50
53-56	PU	BA-3685-Aea.	2.50

Ignition & Door Key Blank-Replacement Type



32-48	Pass	B-3686-KBea.	5.00
32-47	PU	B-3686-KBea.	5.00

Ignition & Door Key Blank-Accessory Type

Has Ford crest logo on top of key. Looks similar to hood emblem plastic 0A-16637.

32-51	Pass	APA-18136ea.	10.00
52-56	Pass	BA-3685-ANVea.	10.00
32-52	PU	APA-18136ea.	10.00
53-56	PU	BA-3685-ANVea.	10.00

Trunk & Glove Box Key Blank-Concours Type

The 1932-48 keys have the correct "Hurd" logo. 1949-56 Keys have the correct "Ford" logo.



32-38	Pass	B-7006080ea.	5.00
39-48	Pass	91A-7006080ea.	5.00
49-50	Pass	8A-3685-Bea.	4.50
51	Pass	1A-3685-Bea.	4.50
52-56	Pass	BA-3685-Bea.	2.50
39-48	Merc	91A-7006080ea.	5.00

Trunk & Glove Box Key Blank-Replacement Type

32-48	Pass	B-3686-KCea.	5.50
-------	------	-----------	----------	------





Section 41 Interior

KICK PANELS

Fiberglass Kick Panels

Must drill holes for mounting. Hardware is NOT included. Please allow 2-3 weeks delivery time.



32	Pass	B-8102340/1-B, exc. 3w coupe	pr.	85.00
32	Cpe 3W	B-8102340/1-C.....	pr.	85.00
33-34	Roadster	40-8102340/1-B	pr.	85.00
33-34	Phaeton	40-8102340/1-B	pr.	85.00
33-34	Cpe	40-8102340/1-A.....	pr.	85.00
33-34	Sdn	40-8102340/1-A.....	pr.	85.00
35-36	Roadster	48-8102340/1-B	pr.	85.00
35-36	Phaeton	48-8102340/1-B	pr.	85.00
35-36	Cpe	48-8102340/1-A.....	pr.	85.00
35-36	Sdn	48-8102340/1-A.....	pr.	85.00
37-38	Pass	78-8102340/1	pr.	85.00
39	Std Pass	78-8102340/1	pr.	85.00
39	Dlx Pass	91A-8102340/1	pr.	85.00
40	Pass	91A-8102340/1	pr.	85.00
41-48	Pass	11A-8102340/1	pr.	85.00
39-40	Merc	99A-8102340/1	pr.	85.00
32-34	PU	B-8102340/1-A	pr.	85.00
35-36	PU	50-8102340/1-A.....	pr.	85.00
37-39	PU	77-8102340/1-A.....	pr.	85.00
40-47	PU	01C-8102340/1-A.....	pr.	85.00

ABS Plastic Kick Panels

Must drill holes for mounting. Hardware is NOT included.

35-36	PU	FORD-3536-TSP	pr.	58.50
-------	----	---------------------	-----	-------

ABS Kick Panels with Speakers

Available in black only. Include speakers. Must drill holes for mounting. Hardware is NOT included.

38-40	Cpe/Sdn	KFCU-39/40, 80 watt speakers.....	pr.	129.00
38-40	Cpe/Sdn	PIO-KFCU-39/40, 120 watt speakers.....	pr.	189.00
39-40	Conv	KFCV-39/40, 80 watt speakers.....	pr.	129.00
39-40	Conv	PIO-KFCV-39/40, 120 watt speakers.....	pr.	189.00

Cardboard Kick Panels

49-50	Pass	8A-7002341, benton gray.....	pr.	15.00
-------	------	---------------------------------	-----	-------

51	Pass	1A-7002341, benton gray.....	pr.	15.00
55-56	Pass	B5A-7002341-BL, black	pr.	15.00
55-56	Pass	B5A-7002341-BB, blue.....	pr.	15.00
55-56	Pass	B5A-7002341-G, gray.....	pr.	15.00
48-52	PU	7C-8102340-BL, black.....	pr.	25.00
48-52	PU	7C-8102340-BR, brown.....	pr.	25.00
48-52	PU	7C-8102340-GR, gray.....	pr.	25.00
53-55	PU	BAAA-8102340-41, gray.....	pr.	25.00
56	PU	B6C-8102340-41, gray.....	pr.	25.00

Plain Steel Kick Panel Retainers

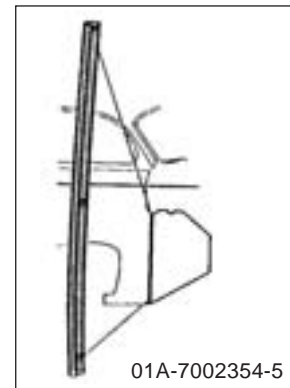

37-48	Pass	01A-7002354/5	pr.	40.00
39-48	Merc	01A-7002354/5	pr.	40.00
37-47	PU	01A-7002354/5	pr.	40.00

Stainless Kick Panel Retainers

37-48	Pass	01A-7002354-SS.....	pr.	50.00
39-48	Merc	01A-7002354-SS.....	pr.	50.00
37-47	PU	01A-7002354-SS.....	pr.	50.00

Kick Panel Clips

48-52	PU	7C-8102342, 6 pcs.....	set.	3.00
-------	----	------------------------	------	------

SUN VISORS

Sun Visor Bracket with Frame

Includes two brackets and two frames. Upholstery is NOT included.

32	Cpe 3W	B-47380-3W.....	pr.	45.00
----	--------	-----------------	-----	-------

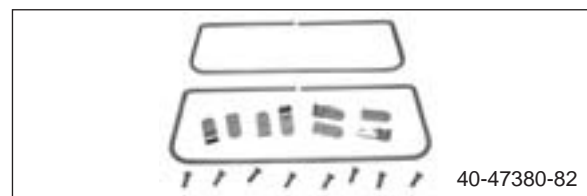

33	Cpe/Sdn	40-47380-82	pr.	45.00
34	Std Cpe	40-47380-82	pr.	45.00
34	Std 2D Sdn	40-47380-82	pr.	45.00
34	Std 4D Sdn	40-47380-82	pr.	45.00

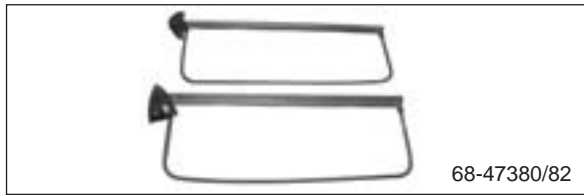

- 35-48 Pass 68-47380/82, chromepr. 50.00
- 39-48 Merc 68-47380/82, chromepr. 50.00

Cardboard Sunvisors

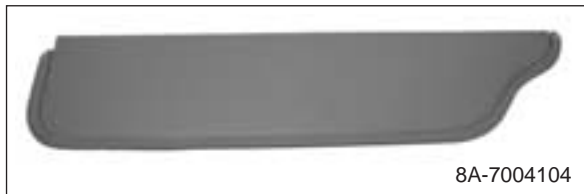

- 49-51 Cpe 8A-7004104, grayea. 25.00
- 49-51 Sdn 8A-7004104, grayea. 25.00



- 52 Cpe BA-7004104-A, grayea. 16.00
- 52 Sdn BA-7004104-A, grayea. 16.00



- 53 Cpe BF-7004104-A, grayea. 16.00
- 53 Sdn BF-7004104-A, grayea. 16.00



- 49-51 Merc 8M-7004104, grayea. 30.00
- 38-47 PU 01C-8104104-BL, blackea. 20.00
- 48-52 PU 7C-8104104-BL, blackea. 25.00
- 48-52 PU 7C-8104104-BR, brownea. 25.00
- 48-52 PU 7C-8104104-R, redea. 17.00



- 48-52 PU 7C-8104104-GR, grayea. 25.00

- 53-55 PU BAAA-8104104-AA, grayea. 25.00
- 56 PU B6C-8104104-AA, grayea. 25.00

Padded Sun Visor

Molded in a light beige color over a steel frame. Can be dyed to match your interior color or use as is. Sold in pairs only.

- 56 Conv B6A-6404104-PRpr. 80.00
- 56 Victoria B6A-6404104-PRpr. 80.00
- 56 Crown Vic B6A-6404104-PRpr. 80.00
- 56 Sdn 2D B6A-7004104-PRpr. 80.00
- 56 Sdn 4D B6A-7004104-PRpr. 80.00
- 56 Sedan Dly B6A-7004104-PRpr. 80.00
- 56 Wagon B6A-7004104-PRpr. 80.00

Sun Visor Brackets

- 49-50 Cpe 8A-7004144-CP, plainea. 25.00



- 49-50 Cpe 8A-7004144-CC, chromeea. 30.00
- 49-50 Sdn 8A-7004144-CP, plainea. 25.00
- 49-50 Sdn 8A-7004144-CC, chromeea. 30.00
- 49-51 Conv 1A-7604144-AC, plainea. 25.00



- 49-51 Conv 1A-7604144-CC, chromeea. 30.00
- 51 Cpe 1A-7004144-AP, plainea. 25.00
- 51 Cpe 1A-7004144-CC, chromeea. 30.00
- 51 Sdn 1A-7004144-AP, plainea. 25.00
- 51 Sdn 1A-7004144-CC, chromeea. 30.00
- 51 Hardtop 2D 1A-7604144-AC, plainea. 25.00
- 51 Hardtop 2D 1A-7604144-CC, chromeea. 30.00
- 49-51 Wagon 1A-7604144-AC, plain, must modify header panelea. 25.00
- 49-51 Wagon 1A-7604144-CC, chrome, must modify header panelea. 30.00
- 52-54 Conv BA-7604144-BP, RH, plainea. 50.00
- 52-54 Conv BA-7604145-BP, LH, plainea. 50.00



- 52-54 Conv BA-7604144-CC, RH, chromeea. 60.00
- 52-54 Conv BA-7604145-CC, LH, chromeea. 60.00
- 55-56 Conv B5A-7604144-BP, RH, plainea. 50.00
- 55-56 Conv B5A-7604145-BP, LH, plainea. 50.00



49-51	Merc Cpe	1A-7604144-AC, plain	ea.	25.00
49-51	Merc Cpe	1A-7604144-CC, chrome	ea.	30.00
49-51	Merc Sdn	1A-7604144-AC, plain	ea.	25.00
49-51	Merc Sdn	1A-7604144-CC, chrome	ea.	30.00
38-47	PU	01C-8104104-B, black	pr.	55.00
38-47	PU	01C-8104104-C, chrome.....	pr.	65.00
48-52	PU	7C-8104144-PP, painted	ea.	17.50

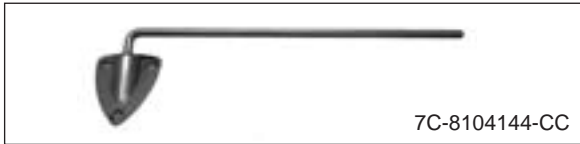

48-52	PU	7C-8104144-CC, chrome	ea.	30.00
53-55	PU	BAAA-8104144-PP, painted	ea.	17.50
53-55	PU	BAAA-8104144-CC, chrome	ea.	30.00
56-60	PU	B6C-8104144-AP, painted	ea.	17.50



56-60	PU	B6C-8104144-C, chrome	ea.	30.00
-------	----	--------------------------------	-----	-------

Sun Visor Bracket Screws

52-56	Pass	52353-SS, 3 pcs.....	set.	1.20
48-56	PU	52353-SS, 3 pcs.....	set.	1.20

Conv. Sun Visor Rod

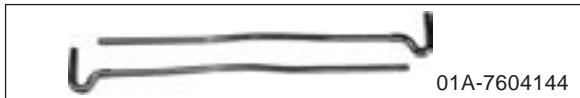

40	Conv	01A-7604144	pr.	82.50
----	------	-------------------	-----	-------

Sunvisor Center Mount Pin

Goes in center end of sunvisor.

52-56	Merc Conv	BC-7604114-B, 2-1/8" long, chrome	ea.	6.00
-------	-----------	--	-----	------

Accessory Sun Visor Mirror



35-37	Pass & PU	48-17676.....	ea.	55.00
42-49	Pass & PU	21A-18208.....	ea.	55.00

INTERIOR INSULATION KIT

ACOUSTISHIELD KIT

Kits are pre-cut with easy to follow instructions. These state of the art kits help with road noise, heat, and vibration. Kits include Dynamat and Quality Heat Shield. Can be modified to fit street rods. Kits are shipped in a large box and require oversize shipping. Shipping still applies if picked up at store.



*32	Roadster	FORD-3200-RAK.....	kit.	540.00
*32	Cpe 3W	FORD-3200-CAK3W	kit.	651.00
*32	Cpe 5W	FORD-3200-CAK5W	kit.	651.00
*32	Sdn 2D	FORD-3200-TSAK.....	kit.	596.00
*32	Sdn 4D	FORD-3200-FSAK.....	kit.	628.00
*33-34	Roadster	FORD 3334-RAK.....	kit.	540.00
*33-34	Cabriolet	FORD-3334-CBAK	kit.	540.00
*33-34	Cpe 3W	FORD-3334-CAK3W	kit.	651.00
*33-34	Cpe 5W	FORD-3334-CAK5W	kit.	651.00
*33-34	Sdn 2D	FORD-3334-TSAK/SB.....	kit.	596.00
*33-34	Sdn 4D	FORD-3334-FSAK/SB.....	kit.	628.00
*35-36	Roadster	FORD-3536-CVAK	kit.	540.00
*35-36	Cabriolet	FORD-3536-CABAK	kit.	540.00
*35-36	Cpe 3W	FORD-3536-CAK3W	kit.	651.00
*35-36	Cpe 5W	FORD-3536-CAK5W	kit.	651.00
*35-36	Sdn 2D Hump	FORD-3536-TSAK/TB.....	kit.	673.00
*35-36	Sdn 2D Flat	FORD-3536-TSAK/SB.....	kit.	657.00
*35-36	Sdn 4D Hump	FORD-3536-FSAK/TB.....	kit.	687.00
*35-36	Sdn 4D Flat	FORD-3536-FSAK/SB.....	kit.	705.00
*37-39	Cabriolet	FORD-3739-CVAK	kit.	540.00
*37-38	Cpe	FORD-3739-CAK5W	kit.	651.00
*37-39	Sdn 2D	FORD-3739-TSAK, except 39 Deluxe	kit.	673.00
*37-39	Sdn 4D	FORD-3739-FSAK, except 39 Deluxe	kit.	705.00
*39-40	Conv	FORD-3940-CVAK	kit.	540.00
*39-40	Cpe	FORD-3940-CAK5W, 39 Deluxe	kit.	651.00
*39-40	Sdn 2D	FORD-3940-TSAK, 39 Deluxe	kit.	673.00
*39-40	Sdn 4D	FORD-3940-FSAK, 39 Deluxe	kit.	705.00
*39-41	Sdn Dly	FORD-3940-SDAK.....	kit.	818.00
*41-48	Conv	FORD-4148-CVAK	kit.	540.00
*41-48	Cpe	FORD-4148-CAK5W	kit.	651.00
*41-48	Sdn 2D	FORD-4148-TSAK.....	kit.	673.00
*41-48	Sdn 4D	FORD-4148-FSAK.....	kit.	705.00
*42-48	Sdn Dly	FORD-4148-SDAK.....	kit.	818.00
*49-51	Conv	FORD-4951-CVAK	kit.	551.00
*49-51	Cpe	FORD-4951-CAK.....	kit.	662.00

*49-51	Sdn 2D	FORD-4951-SAKkit.	712.00
*49-51	Sdn 4D	FORD-4951-SAKkit.	712.00
*52-54	Conv	FORD-5254-CVAKkit.	551.00
*52-54	Hardtop 2D	FORD-5254-CAKkit.	662.00
*52-54	Sdn 2D	FORD-5254-SAKkit.	712.00
*52-54	Sdn 4D	FORD-5254-SAKkit.	712.00
*55-56	Conv	FORD-5556-CVAKkit.	551.00
*55-56	Hardtop 2D	FORD-5556-VAKkit.	674.00
*55-56	Sdn 2D	FORD-5556-SAKkit.	712.00
*55-56	Sdn 4D	FORD-5556-SAKkit.	712.00
*55-56	Wagon	FORD-5556-SWAKkit.	801.00
*55-56	Sdn Dly	FORD-5556-SDAKkit.	774.00
*41-48	Merc Conv	FORD-4148-CVAKkit.	540.00
*41-48	Merc Cpe	FORD-4148-CAK5Wkit.	651.00
*41-48	Merc 2D Sdn	FORD-4148-TSAKkit.	673.00
*41-48	Merc 4D Sdn	FORD-4148-FSAKkit.	705.00
*49-51	Merc Conv	MERC-4951-CVAKkit.	573.00
*49-51	Merc 2D	MERC-4951-CAKkti.	684.00
*49-51	Merc 4D	MERC-4951-SAKkit.	733.00
*32-34	PU	FORD-3234-TAKkit.	428.00
*35-36	PU	FORD-3536-TAKkit.	449.00
*37	PU	FORD-3700-TAKkit.	451.00
*38-39	PU	FORD-3839-TAKkit.	451.00
*40-47	PU	FORD-4047-TAKkit.	436.00
*48-52	PU	FORD-4852-TAKkit.	436.00
*53-55	PU	FORD-5355-TAKSWkit.	451.00
*53-55	Panel	FORD-5355-PDAKkit.	862.00
*56	PU	FORD-5600-TAKSW, small window cabkit.	451.00
*56	PU	FORD-5600-TAKLW, big window cabkit.	451.00
*56	Panel	FORD-5600-PDAKea.	862.00

SEAT PARTS

See Section 1 for Seat Belts

Opera Seat Leg Bumper



40-41	Cpe	01A-6760712pr.	20.00
-------	-----	-------------	----------	-------

Seat Adjusting Handle



32-34	Cpe	B-47836ea.	14.50
32-34	Sdn 4D	B-47836ea.	14.50
32-34	Cabriolet	B-47836ea.	14.50

Seat Adjusting Knob



55-56	Pass	B5A-7061755-Aea.	15.95
55-57	T-Bird	B5A-7061755-Aea.	15.95

Seat Button

46	Pass	51A-7063500-B, blue-grayea.	6.00
46-48	Pass	51A-7063500-C, gray-tanea.	6.00

Seat Back Stops

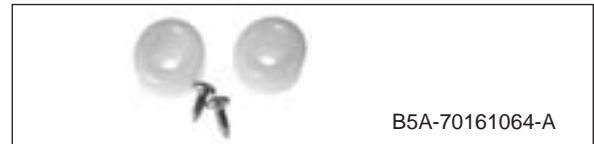

49-52	Pass	SB62-A, universalea.	6.50
53-59	Pass	B5A-70161064-Apr.	11.50

Seat Back Bumpers for Second Seat

50-56	Wagon	0A-7961333-PRpr.	7.50
50-55	Merc Wgn	0A-7961333-PRpr.	7.50

Seat Emblem

"Ford Crestmark" for passenger side of front seat.

54-56	Pass	B5A-7062186-DFea.	10.00
-------	------	----------------	----------	-------

Front Seat Pivot Rubber Covers

49	Pass	8A-7061978-PRpr.	25.00
----	------	---------------	----------	-------

Seat Mounting Bolt Kit

48-52	PU	6-0368, stainless steelkit.	4.75
-------	----	-------------------------	-----------	------

**Section 42
Glove Box**

DOOR

Steel Glove Box Door

Door only. Knob, trim, and hardware NOT included.

33-34	Pass	40-701650ea.	50.00
40	Std Pass	01A-7006020-A, smooth, no holes, will fit all 40 Passea.	55.00
40	Dlx Pass	01A-7006020-B, w/clock & dash trim mtg holesea.	55.00

Steel Glove Box Door Kit

Includes; hinge, spring, hardware kit, and glove box door repair kit.

33-34	Pass	40-701650-Kkit.	80.00
-------	------	-------------	-----------	-------



HINGE

Glove Box Door Hinge



33-34 Pass 40-701662ea. 18.00



40-48 Pass 01A-701662-S, w/striker platekit. 37.00

SPRINGS

Glove Box Door Spring & Pin

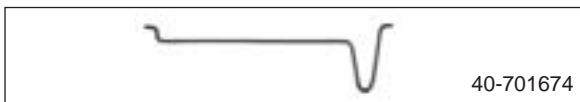

33-34 Pass 40-701674ea. 5.50

Glove Box Door Spring



35-37 Pass 48-701679, 2 req'dea. 8.00
 38-39 Pass 91A-7006068, 2 req'dea. 8.00
 35-47 PU 48-701679, 1 req'dea. 8.00

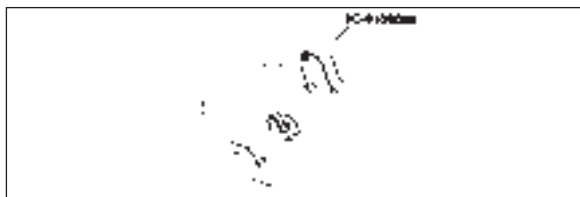

48-52 PU 8C-8106068, 1 req'dea. 5.00
 53-56 PU BAAA-8106068ea. 5.00

LOCK

Glove Box Door Lock

Striker Plate not included.



40 Pass 01A-7006081ea. 45.00
 42-48 Pass 21A-7006081ea. 45.00
 49 Pass 8A-7006081-PR, NOS, w/trunk lockset. 35.00
 56 Pass B6A-7006081-C, NOSea. 50.00

Glove Box Door Repair Kit



33-34 Pass 40-43000-RKkit. 12.50

LINER

Glove Box Liner

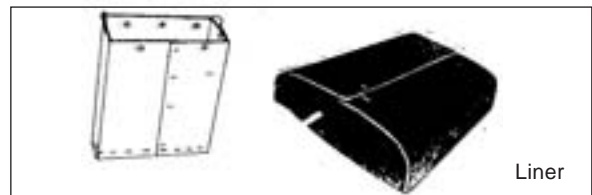

32 Cpe 3W B-43000ea. 16.00
 33-34 Pass 40-43000ea. 16.00
 35-36 Roadster 48-43000-BSea. 16.00
 35-36 Phaeton 48-43000-BSea. 16.00
 35-36 Pass 48-43000, exc. roadster, phaetonea. 16.00
 37 Pass 78-43000ea. 16.00
 38-39 Conv 81A-43000-Bea. 16.00
 38-39 Pass 81A-43000, exc.conv & wagonea. 16.00
 38-39 Wagon 81A-43000-Bea. 16.00
 40 Pass 01A-43000ea. 16.00
 41 Pass 11A-43000ea. 16.00
 42-48 Pass 21A-43000ea. 16.00
 49-50 Pass 8A-43000, except wagonea. 25.00
 49-51 Wagon 8A-43000ea. 25.00
 51 Pass 1A-43000, except wagonea. 25.00
 52-53 Pass BA-43000ea. 20.00
 54 Pass BM-43000ea. 20.00
 55 Pass B5A-43000, without ACea. 20.00
 55 Pass B5A-7006010-CC, with ACea. 20.00
 56 Pass B6A-43000, without ACea. 20.00

56	Pass	B6A-7006010-CC, with AC	ea.	20.00
40	Merc	09A-43000	ea.	16.00
42-48	Merc	59A-43000	ea.	16.00
49	Merc	8M-43000	ea.	51.50
50-51	Merc	0M-43000	ea.	25.00
52-54	Merc	BC-7006010.....	ea.	20.00
55-57	T-Bird	B5S-43000	ea.	20.00
35-37	PU	67-43000	ea.	16.00
38-39	PU	81C-43000	ea.	16.00
40-47	PU	01C-43000	ea.	16.00
48-52	PU	8T-43000	ea.	16.00
53-55	PU	53T-43000	ea.	16.00
56	PU	56T-43000	ea.	16.00

BUMPERS

Glove Box Door Bumpers

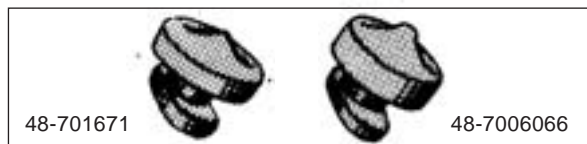

35-48	Pass	48-701671, thin	pr.	1.75
35-48	Pass	48-7006066, thick	pr.	1.75
49	Pass	8A-43001	pr.	3.00



50	Pass	0A-43001	pr.	3.00
50-51	Wagon	0A-43001	pr.	3.00
51	Pass	1A-43001	pr.	3.00
52-56	Pass	0A-16378	pr.	3.00
39-48	Merc	48-701671, thin	pr.	1.75
39-48	Merc	48-7006066, thick	pr.	1.75
50-56	Merc	0A-16378	pr.	3.00
35-47	PU	48-701671, thin	pr.	1.75
35-47	PU	48-7006066, thick	pr.	1.75
48-52	PU	1A-43001	pr.	3.00
53-66	PU	0A-16378	pr.	3.00

Glove Box Door Stops



40-48	Merc	09A-7006117	pr.	9.00
-------	------	-------------------	-----	------

Glove Box Door Arm Grommet

49-56	Pass	8A-7006122	ea.	2.50
49-51	Merc	0M-7206122	ea.	6.00

Glove Box Arm Stop



56	Pass	B7A-7006122	ea.	2.00
----	------	-------------------	-----	------

Glove Box & Glove Box Door Mounting Hardware



40-48	Pass	01A-43000-HK	kit.	15.00
-------	------	--------------------	------	-------

EMBLEM

Glove Box Door Emblem



55-56	Pass	B6A-7004407-A, "V8"	ea.	20.00
55-56	T-Bird	B6A-7004407-A, "V8"	ea.	20.00

Glove Box Door Script

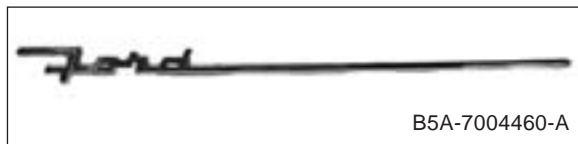

55-56	Pass	B5A-7004460-A, "Ford"	ea.	35.00
-------	------	--------------------------------	-----	-------

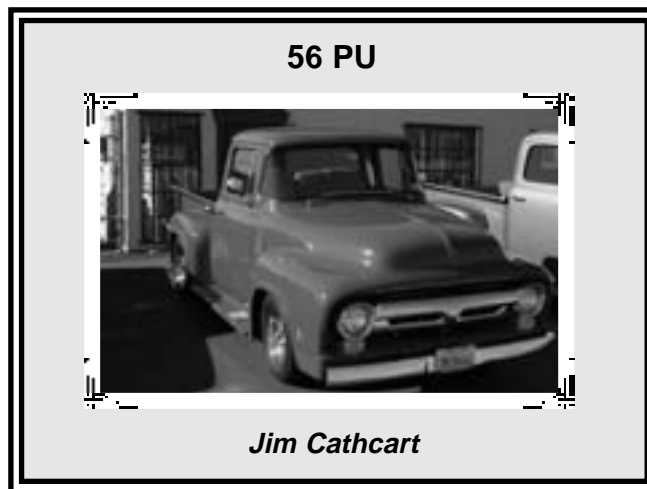



Section 43 Floormats

FRONT MATS

Car Front Floor Mat

Made from original Ford tooling. Some of the mats look cracked, but it is the mold that has the imperfections. The taupe color has been changed by the manufacturer, and has a green or olive drab color to them.

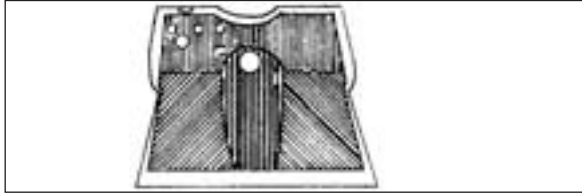

*32	Roadster	A-4005, taupeea.	175.00
*32	Cpe	A-4005, taupeea.	175.00
*33-34	Pass	A-4003, taupe,2 pcs.ea.	175.00
*35	Pass	A-4006, blackea.	137.00
*35	Pass	A-4002, taupeea.	175.00
*36	Pass	A-4001, blackea.	137.00
*36	Pass	A-4000, taupeea.	175.00
*37-39	Pass	A-4007, blackea.	137.00
*37-39	Pass	A-4013, taupeea.	175.00
*40	Pass	A-4008, blackea.	137.00
*40	Pass	A-4014, taupeea.	175.00
*41-48	Pass	A-4010, blackea.	137.00
*49-50	Pass	A-4015, blackea.	137.00
*51	Pass	A-4016-51PS, blackea.	137.00
*52-54	Pass	4505, blackea.	86.00
*55-56	Pass	4506, blackea.	86.00
*41-48	Merc	A-4010, blackea.	137.00
*52-54	Merc	4505, blackea.	86.00
*55-56	Merc	4506, blackea.	86.00

Pick Up Floor Mat

*33-47	PU	A-4004-A, no holes, trim to fitea.	149.95
*40-41	PU	A-4009, must cut hole for floor shiftea.	137.00
*42-47	PU	21C-7013000, w/holesea.	95.00
*48-52	PU	4904, exc.COEea.	99.95
*53-56	PU	4905, exc.COEea.	100.00

WAGON

Station Wagon Center Mat

*41-48	Merc Wgn	A-2581, blackea.	149.95
*41-48	Wagon	A-2581, blackea.	149.95

Station Wagon Rear Deck Mat

*41-48	Merc Wgn	A-2582, blackea.	179.95
*41-48	Wagon	A-2582, blackea.	179.95

REAR SEAT

Rear Seat Mat

36	Phaeton	A-2528, blackea.	75.00
36	Phaeton	A-2529, taupeea.	175.00

Universal Floor Mat

*All	Pass & PU	6020, black, 74"x36"ea.	120.00
------	-----------	----------------------	----------	--------

TRUNK

Trunk Mat

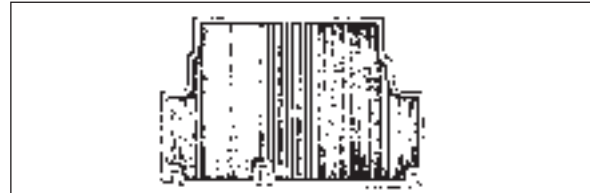

*40	Conv	A-2532ea.	137.00
*39-40	Cpe	A-2532ea.	137.00
*39-40	Sdn	A-2533ea.	137.00
*41-48	Conv	A-2536ea.	137.00
*46-48	Sportsman	A-2534ea.	136.95
*41-48	Cpe	A-2537ea.	137.00
*41-48	Sdn	A-2538ea.	137.00
*49-50	Conv	A-2540ea.	137.00
*49-50	Cpe	A-2540ea.	137.00
*49-50	Sdn	A-2539ea.	137.00
*51	Pass	A-2543, exc.2Dr Hrdtopea.	115.00
*52-54	Pass	A-2544ea.	116.00
55-56	Pass	B5A-7045455, plaidea.	90.00
*41-48	Merc Cpe	A-2537ea.	137.00
*41-48	Merc Conv	A-2536ea.	137.00
*41-48	Merc Sdn	A-2538ea.	137.00
55-56	T-Bird	B6S-7045455ea.	67.95

Floor Mat Clips

32-34	Pass	B-20018ea.	.75
35-40	Pass	48-20018ea.	.75

CARPET

Sewn carpet for front and back. Includes jute padding and heel pad. For cars with stock floor pans only. Please specify year and model of your vehicle, If ordering a color other than black, please send sample. Carpet is made to order.

Carpet

49-56	Pass	CARPETea.	195.00
-------	------	--------	----------	--------

Section 44 Floorboard

FLOORBOARD WOOD/SEALS

Wood Floorboards

33-34	Pass	40-700325ea.	36.00
35	Pass	48-700325pr.	36.00
37-38	Pass	78-700325pr.	36.00
39	Pass	91A-7011506/7pr.	40.00
40	Pass	01A-7011506/7pr.	40.00
33-34	PU	46-700325ea.	36.00
37-39	PU	75-700325ea.	36.00

Floorboard Seals



32-34	Pass	A-35130-S, , universal, with hardwarekit.	6.00
35-36	Pass	68-700364/5pr.	40.00
37-38	Pass	78-700364/5pr.	40.00
39	Pass	91A-7011508/9pr.	40.00
40	Pass	01A-7011508/9pr.	40.00
41-48	Pass	11A-7011508/9, 3 pieceskit.	25.00
41-48	Merc	11A-7011508/9, 3 pieceskit.	25.00
32-47	PU	A-35130-S, , universal, with hardwarekit.	6.00

Floorboard Screws

32	Pass	3140set.	3.50
33-40	Pass	3141set.	3.75

Rubber Floor Plugs for Floor Board

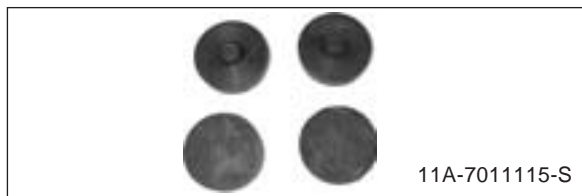

41-48	Pass	11A-7011115-S, 4 pcs.set.	6.50
-------	------	-----------------------	-----------	------

Section 45 Door

DOOR SEALS

Door Hinge Seal

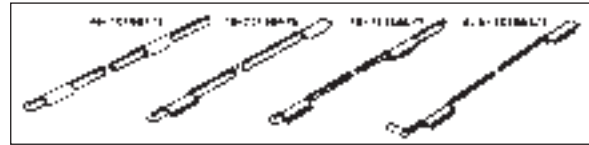

35-36	Pass	48-701884/5pr.	25.00
37	Pass	78-701884/5, exc.conv & wagonpr.	30.00
37-40	Conv	78-711686/7pr.	20.00
38-40	Pass	81A-701884/5, exc.conv & wagonpr.	25.00
41-48	Pass	11A-7020456/7, exc. conv & wagonpr.	25.00
41-48	Conv	11A-7620456/7pr.	30.00
41-48	Merc	11A-7020456/7, exc. conv & wagonpr.	25.00
41-48	Merc Conv	11A-7620456/7pr.	30.00

Upper Door Seal

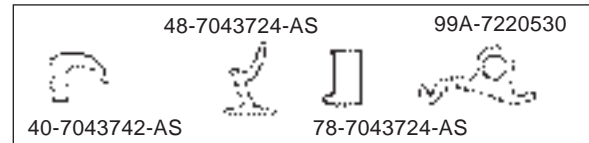

32	Cpe 3W	40-7043724-ASkit.	10.00
33-34	Cpe	40-7043724-ASkit.	10.00
33-34	Sdn 2D	40-7043724-ASkit.	10.00
33-34	Sdn 4D	40-7043724-BSkit.	15.00
35-36	Cpe	48-7043724-ASkit.	10.00
35-36	Sdn 2D	48-7043724-ASkit.	10.00
35-36	Sdn 4D	48-7043724-BSkit.	15.00
37-48	Cpe	78-7043724-ASkit.	10.00
37-48	Sdn 2D	78-7043724-ASkit.	10.00
37-48	Sdn 4D	78-7043724-BSkit.	15.00
39-40	Merc Cpe	99A-7220530kit.	50.00
41-48	Merc Cpe	78-7043724-ASkit.	10.00
41-48	Merc 2D Sdn	78-7043724-ASkit.	10.00
41-48	Merc 4D Sdn	78-7043724-BSkit.	15.00

Back Edge of Door Seal

The 4 door sedan seal goes on the back edge of the front doors and the back and front side of the rear doors.



41-48	Conv	11A-7620546kit.	6.00
-------	------	-------------	-----------	------



41-48	Cpe	11A-7020546kit.	7.00
41-48	Sdn 2D	11A-7020546kit.	7.00
41-48	Sdn 4D	11A-7320546kit.	20.00
41-48	Merc Conv	11A-7620546kit.	6.00
41-48	Merc Cpe	11A-7020546kit.	7.00
41-48	Merc 2D Sdn	11A-7020546kit.	7.00
41-48	Merc 4D Sdn	11A-7320546kit.	20.00

Lower Door Seal

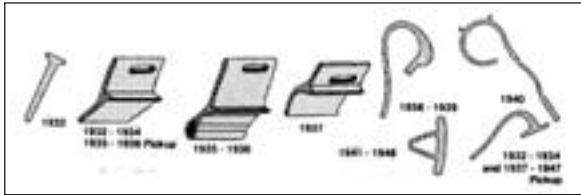

32	Roadster	B-35702kit.	20.00
32	Phaeton	B-35702kit.	20.00
32	Cpe/Sdn	40-701980ea.	10.00
32-40	Wagon	48-7920706, all 4 doorsset.	30.00
33-34	Pass	40-701980, exc. wgnea.	10.00
35-36	Pass	48-701980, exc. wgnea.	8.00
37	Pass	78-701980, exc. wgnea.	8.00
38-39	Pass	81A-701980, exc. wgnea.	6.00
40	Pass	01A-701980, exc. wgnea.	6.00
41-48	Pass	11A-701980ea.	6.00
41-48	Wagon	11A-701980, 3 requiredea.	6.00
39	Merc	81A-701980ea.	6.00
40	Merc	01A-701980ea.	6.00
41-48	Merc	11A-701980ea.	6.00
41-48	Merc Wgn	11A-701980, 3 requiredea.	6.00
32-34	PU	B-80230pr.	10.00
35-36	PU	40-701980ea.	10.00
37-51	PU	B-80230pr.	10.00

Lower Back Edge Door Seal



41-48	Pass	11A-7020548pr.	15.00
41-48	Merc	11A-7020548pr.	15.00

Black Weatherstrip Adhesive

Cannot be shipped air or overseas.



All	Pass & PU	3M-8011ea.	12.00
-----	-----------	---------	----------	-------

Streetrod Style Door Seal Kit

Improved design for noise and sealing. Seals all the way around the door, and includes the lower door seals. Easy to install, just peel and stick. Seals use a 3M adhesive. Lower door seals mount like original.

35-36	Cpe	BD-5048kit.	125.00
35-36	Sdn 2D	BD-5049kit.	125.00
35-36	Sdn 4D	BD-5048, front doors onlykit.	125.00
35-36	Sdn Dly	BD-5048kit.	125.00
37	Cpe	BD-5052kit.	125.00
37	Sdn 2D	BD-5053kit.	125.00
37	Sdn 4D	BD-5052, front doors onlykit.	125.00
37	Sdn Dly	BD-5052kit.	125.00
38-40	Cpe	BD-5050kit.	125.00
38-40	Sdn 2D	BD-5051kit.	125.00
38-40	Sdn 4D	BD-5050, front doors onlykit.	125.00
38-40	Sdn Dly	BD-5050kit.	125.00

Door Seal Kits

1952-1956 wagons use either 2-door sedan or 4-door sedan door seal kits. 4 Door sedan kits will have to add extra rubber to the rear doors.

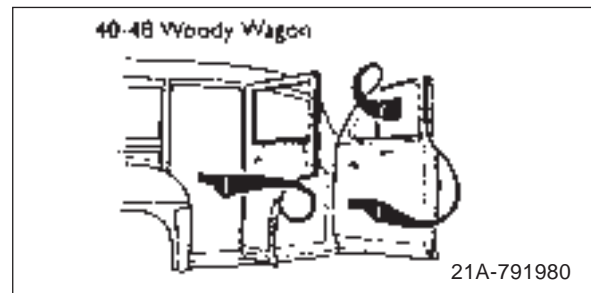

40-48	Wagon	21A-791980, except lower sealkit.	55.00
41-48	Conv	11A-7620530-Skit.	56.00
41-48	Cpe	11A-7020530-Skit.	62.00
41-48	Sdn 2D	11A-7020530-Skit.	62.00
41-48	Sdn 4D	11A-7320530-Skit.	97.00
49-51	Conv	8A-7620530-Spr.	110.00
49-51	Cpe	8A-7020530-Spr.	100.00
49-51	Sdn 2D	8A-7020530-Spr.	100.00
51	Hardtop 2D	8A-7620530-Spr.	110.00
49-51	Sdn 4D	8A-7320530-Sset.	190.00
49-51	Wagon	8A-7920530-Spr.	110.00
52-54	Conv	BA-7620530-Spr.	90.00
52-54	Sdn 2D	BA-7020530-Spr.	90.00
52-54	Hardtop 2D	BA-7620530-Spr.	90.00
52-54	Sdn 4D	BA-7320530-Sset.	200.00
55	Conv	B5A-7620530-Spr.	90.00
55	Sdn 2D	B5A-7020530-Spr.	90.00
55	Hardtop 2D	B5A-6020530-Spr.	90.00
55	Crown Vic	B5A-7620530-Spr.	90.00
55	Sdn 4D	B5A-7320530-Skit.	200.00
56	Conv	B6A-7620530-Spr.	90.00
56	Sdn 2D	B6A-7020530-Spr.	90.00
56	Hardtop 2D	B6A-7620530-Spr.	90.00
56	Crown Vic	B6A-7620530-Spr.	90.00
56	Sdn 4D	B6A-7320530-Sset.	200.00

41-48	Merc Conv	11A-7620530-Skit.	56.00
41-48	Merc Cpe	11A-7020530-Skit.	62.00
41-48	Merc 2D Sdn	11A-7020530-Skit.	62.00
41-48	Merc 4D Sdn	11A-7320530-Skit.	97.00
49-51	Merc Conv	8M-7620530-Spr.	110.00
49-51	Merc Cpe	8M-7020530-Spr.	110.00
49-51	Merc 2D Sdn	8M-7020530-Spr.	110.00
49-51	Merc 4D	8M-7320530-Sset.	200.00
52-54	Merc Conv	BA-7620530-Spr.	90.00
52-54	Merc 2D Sdn	BA-7020530-Spr.	90.00
52-54	Merc 2D HdtpBA-7620530-S	pr.	90.00
52-54	Merc 4D	BA-7320530-Sset.	200.00
55	Merc 2D Sdn	B5A-7020530-Spr.	90.00
55	Merc 2D HdtpB5A-6020530-S	pr.	90.00
55	Merc 4D	B5A-7320530-Skit.	200.00
56	Merc 2D Sdn	B6A-7020530-Spr.	90.00
56	Merc 2D HdtpB6A-7620530-S	pr.	90.00
56	Merc 4D	B6A-7320530-Sset.	200.00
48-52	PU	8C-8120530-Spr.	60.00
53-55	PU	BAAA-8120530-Spr.	60.00
56	PU	B6C-8120530-Spr.	70.00

Lower Door Seal Retainer Strip

Welds to bottom of door to hold bottom of door seal.

49-51	Pass	8A-7020712-PR, except wagonpr.	8.00
-------	------	-----------------------------	----------	------

Panel Rear Door Seals

48-52	Panel	8C-8243722-23pr.	75.00
53-56	Panel	BAAA-8243722-Spr.	75.00

Front of Division Bar Door Seal

55-57	T-Bird	B7S-4020330-Bpr.	7.00
-------	--------	---------------	----------	------

Top Rear of Door Door Seal

55	Conv	B6A-7620565-PR, latepr.	30.00
55	Hardtop 2D	B6A-7620565-PR, latepr.	30.00
55	Crown Vic	B6A-7620565-PR, latepr.	30.00

Front of Vent Window to Windshield Post Seal

56	Conv	B5A-7621382-PRpr.	8.00
----	------	----------------	----------	------

"I recently ordered parts from C&G for the first time. The person taking my order was very polite and professional, the parts arrived quickly and I am very satisfied."

 Paul D., Arizona

DOOR BUMPERS

Door Bumper

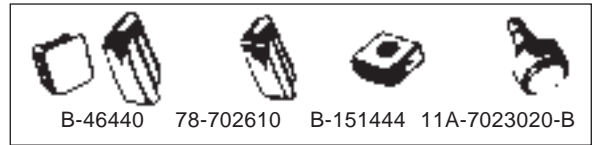

32-36	Pass	B-46440ea.	1.50
32	Victoria	B-191442-Bea.	3.00
32-39	Wagon	B-151444ea.	3.00
32-34	Sdn Dly	B-191442-Bea.	3.00
32-39	Conv Sdn	B-151444ea.	3.00
35-36	Conv Sdn	B-191442-Bea.	3.00
37-48	Pass	78-702610ea.	1.50
41-48	Cpe	11A-7023020-B, upper, round typepr.	3.00
41-48	Sdn	11A-7023020-B, upper, round typepr.	3.00
55-58	Conv	358939-Spr.	7.00
55-58	Hardtop 2D	358939-Spr.	7.00
37-48	Merc	78-702610ea.	1.50
41-48	Merc Cpe	11A-7023020-B, upper, round typepr.	3.00
41-48	Merc Sdn	11A-7023020-B, upper, round typepr.	3.00
32-52	PU	B-46440ea.	1.50

Door Bumper Kits

52-54	Conv	B4A-20127-EKkit.	3.00
-------	------	--------------	-----------	------

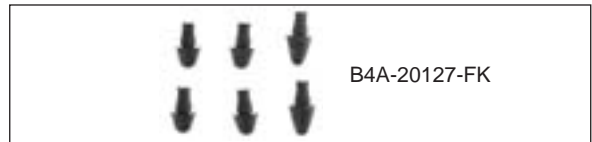

52-54	Sdn 2D	B4A-20127-DKkit.	6.50
52-54	Hardtop 2D	B4A-20127-EKkit.	3.00
52-54	Sdn 4D	B4A-20127-FKkit.	6.00
55-56	Conv	B5A-7620127-CKkit.	3.50



55-56	Sdn 2D	B5A-702127-AKkit.	5.50
55-56	Hardtop 2D	B5A-7620127-CKkit.	3.50
55-56	Sdn 4D	B5A-702127-BKkit.	7.50

Door Glass Bumper

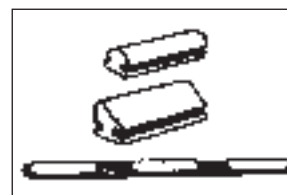

32-36	Pass	B-7021444, for garnish moldingea.	.50
-------	------	--------------------------------	----------	-----

Section 45 - Door



C&G Early Ford Parts, Inc.

32-36	Pass	B-7021452, fits into holes on door	ea.	.50
32-35	Conv Sdn	48-7821444	ea.	4.00
32-35	Cabriolet	48-7821444	ea.	4.00
32-36	PU	B-7021444, for garnish molding	ea.	.50
32-36	PU	B-7021452, fits into holes on door	ea.	.50

Door Window Lower Stop Bumper

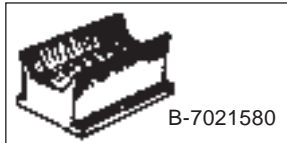

32-34	Pass	B-7021580	ea.	3.00
-------	------	-----------------	-----	------

Door Catch Bumper Kit



40	Conv	01A-7622015-S	kit.	8.00
----	------	---------------------	------	------

DOOR HINGE

Door Hinge

53-56	PU	BAAA-8122800-A, RH, fits upper or lower	ea.	75.00
53-56	PU	BAAA-8122801-A, LH, fits upper or lower	ea.	75.00

Door Hinge Pin Puller Tool

Does not work for all hinges.



All	Pass & PU	TL-100	ea.	25.00
-----	-----------	--------------	-----	-------

Door Hinge Pins

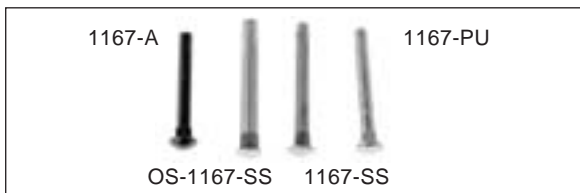

32	Roadster	1167-S	ea.	1.00
32	Phaeton	1167-S	ea.	1.00
32-40	Pass	1167-A, .279"	ea.	1.00
32-40	Pass	1167-SS, stainless, 2-3/4" long, .275" diameter	ea.	4.50
32-40	Pass	OS-1167-SS, stainless, oversize .341"	ea.	8.00
39-40	Merc	1167-A, .279"	ea.	1.00

39-40	Merc	1167-SS, stainless, 2-3/4" long, .275" diameter	ea.	4.50
39-40	Merc	OS-1167-SS, stainless, oversize .341"	ea.	8.00
32-40	PU	1167-A, .279"	ea.	1.00
32-52	PU	1167-SS, stainless, 2-3/4" long, .275" diameter	ea.	4.50
32-47	PU	OS-1167-SS, stainless, oversize .341"	ea.	8.00
32-52	PU	1167-PU, w/groove, .280"	ea.	2.00
48-56	Panel	1167-PU, w/groove, rear door, .280"	ea.	2.00

Door Hinge Screw



28-34	Pass	1166, 3 pcs	set.	2.25
-------	------	-------------------	------	------



28-34	Pass	1166L, cut to fit	ea.	1.00
-------	------	-------------------------	-----	------



35-36	Pass	3116, 3 pcs	set.	2.50
37-40	Pass	3117, 3 pcs., 5/16"-24x1"	set.	2.75
37-40	Pass	3118, 3 pcs. 5/16"-24x1-3/4"	set.	3.25
35-36	PU	1166L, cut to fit	ea.	1.00

Door Hinge Screw Washer



28-34	Pass	1166W	ea.	.35
35-36	PU	1166W	ea.	.35

Door Hinge Bolt

5/16" x 24 x 9/16"

55-58	Pass	20327-S8	ea.	.75
55-58	Pass	20327-SK, 50 pieces	pkg.	22.00
53-60	PU	20327-S8	ea.	.75
53-56	PU	20327-SK, 50 pieces	pkg.	22.00

Stainless Door Hinge Bolt Kit

53-56	PU	6-0217	kit.	9.25
-------	----	--------------	------	------

Stainless Door Hinge Latch & Catch Bolt Kit

48-52	PU	6-0333	kit.	14.00
53-56	PU	6-0254	kit.	16.50

LATCHES

Door Latches



38-40	Cpe	01A-7021812/3	pr.	150.00
38-40	Sdn	01A-7021812/3, front door of 4-door sedan	pr.	150.00
50-51	Pass	0A-7021812, RH, NOS	ea.	60.00
50-51	Pass	0A-7021813, LH, NOS	ea.	Call
50-51	Wagon	0A-7021812, RH, NOS	ea.	60.00
50-51	Wagon	0A-7021813, LH, NOS	ea.	Call
39	Merc Cpe	99A-7021812, RH, NOS	ea.	100.00
39	Merc Cpe	99A-7021813, LH, NOS	ea.	100.00
39	Merc Sdn	99A-7021812, RH, NOS	ea.	100.00
39	Merc Sdn	99A-7021813, LH, NOS	ea.	100.00
49	Merc	8M-7021812, RH, NOS	ea.	55.00
50-51	Merc	0A-7021812, RH, NOS	ea.	60.00
50-51	Merc	0A-7021813, LH, NOS	ea.	Call
38-40	Sdn Dly	01A-7021812/3	pr.	150.00
53-55	PU	BAAA-8121812-N, RH	ea.	75.00
53-55	PU	BAAA-8121813-N, LH	ea.	75.00
56	PU	B6C-8121812-B, RH	ea.	75.00
56	PU	B6C-8121813-B, LH	ea.	75.00

Door Latch and Remote Handle Assemblies

Includes right and left door latches with remote inside door handle mounts with linkage arms.

35-37	PU	50-811850/1	kit.	250.00
-------	----	-------------------	------	--------



38-47	PU	81C-811850/1	pr.	250.00
-------	----	--------------------	-----	--------

Door Latch and Lock Kit

Kit to make both doors lock. Includes two door latches, one pair of matching door locks, and mounting plate to install left door lock cylinder. Must drill hole in left door for lock cylinder.

38-40	Cpe	01A-7021812/3-K	kit.	250.00
38-40	Sdn	01A-7021812/3-K, front door of 4-door sedan	kit.	250.00
38-40	Sdn Dly	01A-7021812/3-K	kit.	250.00
35-37	PU	50-811850/1-K	kit.	350.00
38-47	PU	81C-811850/1-K	kit.	350.00

DOOR LATCH SPRINGS

Door Latch Springs



32	Pass	B-702267	ea.	4.00
33-34	Pass	40-702267-B	ea.	4.00
35-36	Pass	68-702267, early 36	ea.	5.00
36-37	Pass	78-702267, late 36	ea.	4.00
38-40	Pass	81A-702267	ea.	5.00
38-40	Pass	81A-702267-A	ea.	4.00
41-48	Pass	11A-702267	ea.	5.00
41-48	Pass	11A-702267-A	ea.	5.00
41-48	Merc	11A-702267	ea.	5.00
41-48	Merc	11A-702267-A	ea.	5.00
37-47	PU	78-702267	ea.	4.00

Door Latch Spring Clip



32-48	Pass	B-702269	ea.	4.00
39-48	Merc	B-702269	ea.	4.00

REMOTE HANDLE SHAFT

Door Handle Shaft & Link Assembly



38-40	Cpe	81A-732412/3	pr.	50.00
38-40	Sdn 4D	81A-732412/3, front door	pr.	50.00
38-40	Sdn Dly	81A-732412/3	pr.	50.00
53-56	PU	BAAA-8121818-N	ea.	40.00

Door Handle Shaft



38-40	Pass	81A-732412/3-NA, except wagon	pr.	44.00
53-56	PU	BAAA-8121818-R	ea.	30.00

Door Handle Shaft Repair Kit



53-56	PU	BAAA-8121818RK	ea.	15.00
-------	----	----------------------	-----	-------



Remote Handle Spring



32-40 Pass B-702268ea. 4.00



41-48 Pass 11A-702268ea. 4.00
 41-48 Wagon 11A-702268ea. 4.00
 39-40 Merc B-702268ea. 4.00
 41-48 Merc 11A-702268ea. 4.00
 41-48 Merc Wgn 11A-702268ea. 4.00

STRIKER PLATES

Door Strikers



32 Roadster B-35705-SS, stainless steelea. 17.50
 32 Phaeton B-35705-SS, stainless steelea. 17.50
 32 Cpe 3W B-702340-SS, stainlessea. 13.00
 32-34 Cpe 40-702340ea. 8.00
 32-34 Cpe 40-702340-SS, stainless steelea. 10.00
 32-34 Sdn 40-702340ea. 8.00
 32-34 Sdn 40-702340-SS, stainless steelea. 10.00
 33-36 Roadster 40-35705ea. 26.00
 33-36 Roadster 40-711830-B-SS, stainless steelpr. 45.00
 33-36 Phaeton 40-35705ea. 26.00
 33-36 Phaeton 40-711830-B-SS, stainless steelpr. 45.00
 35-37 Conv Sdn 48-742330-SS, stainless steelpr. 45.00
 35-39 Cpe 81A-702340ea. 7.50



35-39 Cpe 81A-702340-SS, stainless steel ...ea. 10.00
 35-39 Sdn 81A-702340ea. 7.50
 35-39 Sdn 81A-702340-SS, stainless steel ...ea. 10.00
 38 Conv 48-742330-SS, stainless steelpr. 45.00
 38 Phaeton 48-742330-SS, stainless steelpr. 45.00
 39-40 Conv 91A-7622010, Steelea. 25.00



39-40 Conv 91A-7622010-S, stainless steel ...ea. 30.00

40 Pass 01A-7022008, , except wagon & convea. 20.00



40 Pass 01A-7022008-C, chrome, except wagon & convea. 16.00
 41-48 Pass 11A-7022008, except wagonea. 15.00
 41-48 Pass 11A-7022008-C, chrome, except wagonea. 15.00
 41-48 Wagon 01A-7022008ea. 20.00
 41-48 Wagon 01A-7022008-C, chromeea. 16.00



50-54 Pass 8A-7022008, RHea. 20.00
 50-54 Pass 8A-7022009, LHea. 20.00
 55 Pass B5A-7022008-C, RHea. 20.00
 55 Pass B5A-7022009-C, LHea. 20.00
 56 Pass B6A-7022008, RHea. 20.00
 56 Pass B6A-7022009, LHea. 20.00
 41-48 Merc 11A-7022008, except wagonea. 15.00
 41-48 Merc 11A-7022008-C, chrome, except wagonea. 15.00
 41-48 Merc Wgn 01A-7022008ea. 20.00
 41-48 Merc Wgn 01A-7022008-C, chromeea. 16.00
 50-54 Merc 8A-7022008, RHea. 20.00
 50-54 Merc 8A-7022009, LHea. 20.00
 55 Merc B5A-7022008-C, RHea. 20.00
 55 Merc B5A-7022009-C, LHea. 20.00
 56 Merc B6A-7022008, RHea. 20.00
 56 Merc B6A-7022009, LHea. 20.00
 55 T-Bird B5A-7022008-C, RHea. 20.00
 55 T-Bird B5A-7022009-C, LHea. 20.00
 56-57 T-Bird B6A-7022008, RHea. 20.00
 56-57 T-Bird B6A-7022009, LHea. 20.00
 32-34 PU 40-702340ea. 8.00



32-34 PU 40-702340-SS, stainless steelea. 10.00
 35-52 PU 81A-702340ea. 7.50
 35-52 PU 81A-702340-SS, stainless steel ...ea. 10.00



53-55 PU BAAA-8122008-A, RHea. 22.00
 53-55 PU BAAA-8122009-A, LHea. 22.00
 56 PU B6C-8122008, RHea. 21.00
 56 PU B6C-8122009, LHea. 21.00

Door Striker Screws

28-32	Roadster	1168, black, set of 4.....set.	1.50
28-32	Phaeton	1168, black, set of 4.....set.	1.50
40	Pass	12-24X3/4, bright zincea.	.25

Door Striker Bolts

49-59	Pass	353382-S, 5/16"-24x1".....ea.	1.00
49-59	Merc	353382-S, 5/16"-24x1".....ea.	1.00
53-60	PU	353382-S, 5/16"-24x1".....ea.	1.00

Door Striker Shims

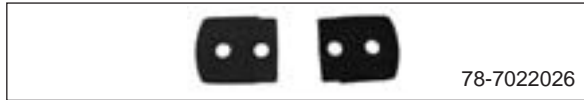

37-38	Cpe/Sdn	78-7022026pr.	3.00
40	Cpe/Sdn	01A-7022026pr.	2.00
41-48	Pass	11A-7022026, except wagonpr.	3.00
50-54	Pass	BA-7022058-Aea.	3.00



55-56	Pass	B5A-7022058-Aea.	3.00
41-48	Merc	11A-7022026, except wagonpr.	3.00
50-54	Merc	BA-7022058-Aea.	3.00
55-56	Merc	B5A-7022058-Aea.	3.00
53-56	PU	B6C-8122058-Aea.	3.00

Door Striker Mounting Plate



32-34	Cpe	48-702336-Apr.	10.00
32-34	Sdn	48-702336-Apr.	10.00

FEMALE DOVETAIL

Female Dovetail Assembly

32-36	Roadster	B-35576-AS, black.....pr.	25.00
-------	----------	---------------------------	-------



32-36	Roadster	18-35576-SS, stainless.....pr.	35.00
32-36	Phaeton	B-35576-AS, black.....pr.	25.00
32-36	Phaeton	18-35576-SS, stainless.....pr.	35.00
32	Cabriolet	B-35576-BS, black.....pr.	30.00
32	Cabriolet	B-35576-SS, stainless.....pr.	35.00
32	Cpe	B-35576-BS, black.....pr.	30.00
32	Cpe	B-35576-SS, stainless.....pr.	35.00
32	Sdn	B-35576-BS, black.....pr.	30.00
32	Sdn	B-35576-SS, stainless.....pr.	35.00
33-34	Cabriolet	40-35576-BS, black.....pr.	30.00



33-34	Cabriolet	40-35576-SS, stainless.....pr.	35.00
33-34	Cpe	40-35576-BS, black.....pr.	30.00
33-34	Cpe	40-35576-SS, stainless.....pr.	35.00
33-34	Sdn	40-35576-BS, black.....pr.	30.00
33-34	Sdn	40-35576-SS, stainless.....pr.	35.00
33-39	Wagon	40-35576-BS, black, front or rearpr.	30.00
33-39	Wagon	40-35576-SS, stainless, front or rearpr.	35.00
35-36	Cabriolet	40-35576-BS, black.....pr.	30.00
35-36	Cabriolet	40-35576-SS, stainless.....pr.	35.00
35-36	Conv Sdn	40-35576-BS, black.....pr.	30.00
35-36	Conv Sdn	40-35576-SS, stainless.....pr.	35.00

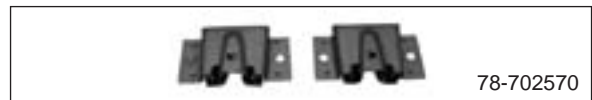

37-40	Cpe	78-702570pr.	20.00
37-40	Sdn	78-702570pr.	20.00
40	Wagon	40-35576-BS, black, front.....pr.	30.00
40	Wagon	40-35576-SS, stainless, front.....pr.	35.00
41-48	Pass	11A-702570, except wagonpr.	20.00
41-48	Wagon	40-35576-BS, black, front or rearpr.	30.00
41-48	Wagon	40-35576-SS, stainless, front or rear.....pr.	35.00
41-48	Merc	11A-702570, except wagonpr.	20.00
41-48	Merc Wgn	40-35576-BS, black, front or rearpr.	30.00
41-48	Merc Wgn	40-35576-SS, stainless, front or rear.....pr.	35.00
32	PU	B-35576-BS, black.....pr.	30.00

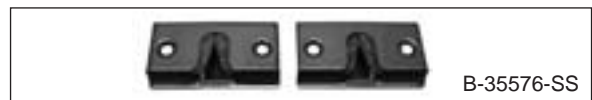

32	PU	B-35576-SS, stainless.....pr.	35.00
33-34	PU	40-35576-BS, black.....pr.	30.00
33-34	PU	40-35576-SS, stainless.....pr.	35.00
40-41	PU	78-702570pr.	20.00
42-52	PU	11A-702570pr.	20.00

Female Dovetail Kit



32-34	Cabriolet	B-702574-RK.....kit.	10.00
32-34	Cpe	B-702574-RK.....kit.	10.00
32-34	Sdn	B-702574-RK.....kit.	10.00
35-40	Cpe	48-702574-RKkit.	10.00
35-40	Sdn	48-702574-RKkit.	10.00
41-48	Pass	11A-702574-RKkit.	10.00



39-40	Merc	48-702574-RKkit.	10.00
41-48	Merc	11A-702574-RKkit.	10.00
32-34	PU	B-702574-RKkit.	10.00
35-41	PU	48-702574-RKkit.	10.00
42-52	PU	11A-702574-RKkit.	10.00

MALE DOVETAIL

Male Dovetail



32	Roadster	40-712018ea.	6.50
32	Phaeton	40-712018ea.	6.50



32	Cpe 3W	B-46421-A, 1-5/8" baseea.	10.00
32	Cpe 3W	40-702550-D, 2-1/8" baseea.	10.00
32	Cpe	B-46421-Aea.	10.00
32	Sdn	B-46421-Aea.	10.00
33-36	Roadster	40-712018ea.	6.50
33-36	Phaeton	40-712018ea.	6.50



33-34	Cabriolet	40-702550-Dea.	10.00
33-34	Cpe	40-702550-Dea.	10.00
33-34	Sdn	40-702550-Dea.	10.00
35-40	Pass	48-702550-Aea.	10.00
33-48	Wagon	B-46421-A, front doorea.	10.00
33-39	Wagon	B-46421-A, rear doorea.	10.00
39-40	Wagon	91A-7923006-A, rear door, replacement typeea.	5.00
41-48	Wagon	B-46421-A, rear doorea.	10.00



41-48	Pass	11A-7023006-A, except wagonea.	10.00
39-40	Merc	48-702550-Aea.	10.00
41-48	Merc	11A-7023006-A, except wagonea.	10.00
41-48	Merc Wgn	B-46421-A, front or rearea.	10.00
32-34	PU	B-46421-Aea.	10.00
35-41	PU	40-702550-Dea.	10.00
42-52	PU	11A-7023006-Aea.	10.00
48-56	Panel	81C-825950, rear doorea.	25.00

Male Dovetail Screws

32	Roadster	3101-A, 4 pcsset.	1.25
32	Phaeton	3101-A, 4 pcsset.	1.25
32	Cpe	3101, 4 pcsset.	1.00

32	Sdn	3101, 4 pcsset.	1.00
33-48	Pass	3102, 4 pcsset.	1.25
39-48	Merc	3102, 4 pcsset.	1.25

DOOR LOCK

Door Lock Cylinder & Keys

Part number 48-702302 includes a flipper with an indented circle and raised notch. Part number 21A-702302 includes a flipper with a raised teardrop notch.



32-48	Pass	B-7121984, replacement typeea.	13.00
32-48	Pass	B-7121984-PR, keyed alikepr.	27.00
35-41	Pass	48-702302, orig. styleea.	35.00
42-48	Pass	21A-702302, orig. styleea.	35.00
52-56	Pass	B7A-7021984-A, RHea.	48.00
52-56	Pass	B7A-7021985-A, LHea.	40.00
39-41	Merc	48-702302, orig. styleea.	35.00
39-48	Merc	B-7121984, replacement typeea.	13.00
42-48	Merc	21A-702302, orig. styleea.	35.00
32-52	PU	B-7121984, replacement typeea.	13.00
35-41	PU	48-702302, orig. styleea.	35.00
42-52	PU	21A-702302, orig. styleea.	35.00
53-60	PU	B7A-7021984-A, RHea.	48.00
53-60	PU	B7A-7021985-A, LHea.	40.00

Door Lock & Ignition Set

Set includes two door locks, and one ignition cylinder with matching key. Lock cylinder levers, springs, and retainer clips are NOT included.



52-56	Pass	BAAA-7022050-Sset.	50.00
55-57	T-Bird	BAAA-7022050-Sset.	50.00
53-60	PU	BAAA-7022050-Sset.	50.00

Door Lock Cylinder Lever



52-56	Pass	BAAA-21971ea.	5.50
55-57	T-Bird	BAAA-21971ea.	5.50
53-60	PU	BAAA-21971ea.	5.50

Door Lock Cylinder Lever Spring

52-58	Pass	B7A-7022075-Aea.	2.50
53-60	PU	B7A-7022075-Aea.	2.50

Door Lock Cylinder Screw

32-48	Pass	01A-7022055	ea.	1.00
39-48	Merc	01A-7022055	ea.	1.00
32-52	PU	01A-7022055	ea.	1.00

Door Lock Cylinder Retainer



52-56	Pass	B5A-7022023-A	ea.	5.00
53-56	PU	B5A-7022023-A	ea.	5.00

Door Lock Cylinder Pad



49-51	Pass	8A-7021985-S	pr.	4.00
49-51	Merc	8A-7021985-S	pr.	4.00
53-60	PU	8A-7021985-S	pr.	4.00

Door Lock Knob



33-34	Pass	A-61148-CR, exc. conv & wagon	ea.	5.50
-------	------	--	-----	------

Door Lock Button

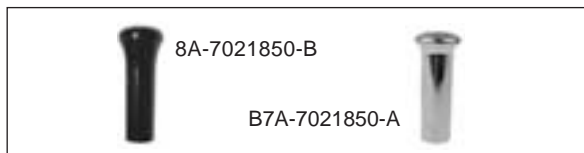

49-51	Pass	8A-7021850-B, black	ea.	6.00
53-59	Pass	B7A-7021850-B, black	ea.	6.50
53-59	Pass	B7A-7021850-A, chrome	ea.	8.00

Door Lock Button Grommet

52-56	Pass	8M-7221999	ea.	3.00
49-56	Merc	8M-7221999	ea.	3.00
55-56	T-Bird	8M-7221999	ea.	3.00

Suicide Door Lock Assembly



33-34	Pass	40-46105/6-S	set.	60.00
-------	------	--------------------	------	-------

DOOR CHECK

Door Check Arm & Bumper



32-48	Pass	B-702828-S	pr.	10.00
38-48	Pass	81A-702828-SS, 4", stainless, Drake type	ea.	15.00
39-48	Merc	B-702828-S	pr.	10.00
32-52	PU	B-702828-S	pr.	10.00
38-47	PU	81A-702828-SS, 4", stainless, Drake type	ea.	15.00

Door Check Arm Bumper



32-34	Pass	B-46590-A	ea.	3.00
32-51	Pass	B-46582	pr.	2.00
39-51	Merc	B-46582	pr.	2.00
32-52	PU	B-46582	pr.	2.00
40-52	Panel	01C-8244123, rear door	pr.	3.00

Door Check Strap

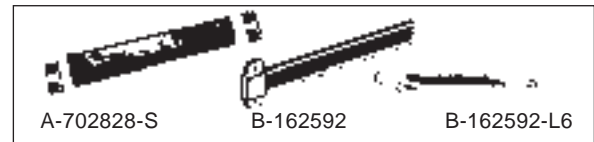

32	Roadster	A-702828-S, leather	kit.	22.00
32	Phaeton	A-702828-S, leather	kit.	22.00
32-34	Pass	B-162592, t-type	ea.	6.50
32-48	Pass	B-162592-L6, loop style, 6"	ea.	4.50
32-48	Pass	B-162592-L7, loop style, 7"	ea.	4.50
32-48	Pass	B-162592-L8, loop style, 8"	ea.	4.50

Brown Door Check Strap



32-36	Wagon	B-151587, 6-1/8", front or rear	pr.	27.00
37-39	Wagon	B-151587, 6-1/8", front	pr.	27.00
37-39	Wagon	78-794400, 5-1/8" , rear	pr.	27.00
40	Wagon	B-151587, 6-1/8", front or rear	pr.	27.00
41-48	Wagon	11A-7923504, 7-1/8" front or rear	pr.	30.00



41-48 Merc Wgn 11A-7923504, 7-1/8" front or rearpr. 30.00

Loop Style Door Check Strap Bracket



32-34 Pass B-42150-B, chromeea. 4.00
 32-48 Wagon B-42150-B, chromeea. 4.00
 41-48 Merc Wgn B-42150-B, chromeea. 4.00

Adjustable T-Type Door Check Strap Retainer



32-34 Pass B-162592-S.....ea. 5.00

Open Car Door Check Strap Bracket

Kit is for two doors. Kit includes 4 brackets and 8 stainless screws. Kits available in black, chrome, and stainless. Straps are NOT included.

28-32 Roadster B-35724-AK, black.....kit. 15.00
 28-32 Phaeton B-35724-AK, black.....kit. 15.00
 28-32 Roadster B-35724-CK, chrome.....kit. 15.00
 28-32 Phaeton B-35724-CK, chrome.....kit. 15.00
 28-32 Roadster B-35724-SK, stainlesskit. 15.00
 28-32 Phaeton B-35724-SK, stainlesskit. 15.00

SCUFF PLATES

All scuff plates are exact reproductions of originals, have the correct markings and fit perfectly. 1938-40 include lower door seal as original. The 1949-51 Mercury and the 1949-51 wagon scuff plates can take 6-9 months to get. Please call 1937 scuff plates, manufacturer is out of stock. Hope to be available by May of 2010.

Front Door Scuff Plates

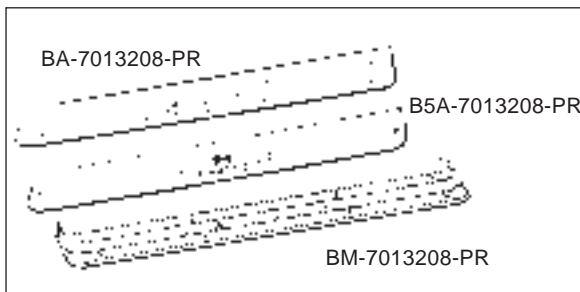

32 Cpe 5W B-338-1, polished stainlesspr. 45.00
 32 Sdn 2D B-338-1, polished stainlesspr. 45.00
 32 Sdn 4D B-338-1, polished stainlesspr. 45.00
 32 Roadster B-138-1, polished stainlesspr. 45.00
 32 Phaeton B-138-1, polished stainlesspr. 45.00
 33-34 Roadster 40-7113250/51pr. 215.00
 33-34 Phaeton 40-7113250/51pr. 215.00
 33-34 Cpe 3W 40-7013250-PRpr. 215.00
 33-34 Cpe 5W 40-7713250/51pr. 215.00
 33-34 Sdn 2D 40-7013250-PRpr. 215.00

33-34 Sdn 4D 40-7713250/51pr. 215.00
 35-36 Roadster 48-7713250/51pr. 215.00
 35-36 Phaeton 48-7713250/51pr. 215.00
 35-36 Cabriolet 48-7013250/51pr. 215.00
 35-36 Cpe 3W 48-7013250/51pr. 215.00
 35-36 Cpe 5W 48-7713250/51pr. 215.00
 35-36 Sdn 2D 48-7013250/51pr. 215.00
 35-36 Sdn 4D 48-7713250/51pr. 215.00
 37 Cpe 78-7313250/51pr. 215.00
 37 Club Cpe 78-7013250/51pr. 215.00
 37 Sdn 2D 78-7013250/51pr. 215.00
 37 Sdn 4D 78-7313250/51pr. 215.00
 38 Phaeton 81A-7413250/51pr. 80.00
 38-39 Conv 81A-7013250/51pr. 80.00
 38-39 Cpe 81A-7313250/51pr. 80.00
 38-39 Sdn 2D 81A-7013250/51pr. 80.00
 38-39 Sdn 4D 81A-7313250/51pr. 80.00
 38-39 Conv Sdn 81A-7413250/51pr. 80.00
 40 Conv 01A-7013250-PRpr. 80.00
 40 Cpe 01A-7713250/51pr. 80.00
 40 Sdn 2D 01A-7013250-PRpr. 80.00
 40 Sdn 4D 01A-7713250/51pr. 80.00
 40-41 Sdn Dly 01A-7713250/51pr. 80.00
 41-48 Conv 11A-7013250/51, 43"pr. 70.00
 41-48 Bus Cpe 11A-7713250-PR, 35-3/4"pr. 70.00
 41-48 Sdn Cpe 11A-7013250/51, 43"pr. 70.00
 41-48 Sdn 2D 11A-7013250/51, 43"pr. 70.00
 41-48 Sdn 4D 11A-7713250-PR, 35-3/4"pr. 70.00
 41-48 Wagon 11A-7013250/51, front, 43" trim to fit.....pr. 70.00
 42-48 Sdn Dly 11A-7713250-PR, 35-3/4"pr. 70.00
 49 Conv 8A-7013208/9-Apr. 110.00
 49 Cpe 8A-7013208/9-Apr. 110.00
 49 Sdn 2D 8A-7013208/9-Apr. 110.00
 49 Sdn 4D 8A-7313208/9pr. 110.00
 49 Wagon 8A-7913208-PRpr. 320.00
 50 Conv 0A-7013208/9-Apr. 110.00
 50 Cpe 0A-7013208/9-Apr. 110.00
 50 Sdn 2D 0A-7013208/9-Apr. 110.00
 50 Sdn 4D 0A-7313208/9pr. 110.00
 50 Wagon 0A-7913208-PRpr. 320.00
 51 Conv 1A-7013208-PRpr. 120.00

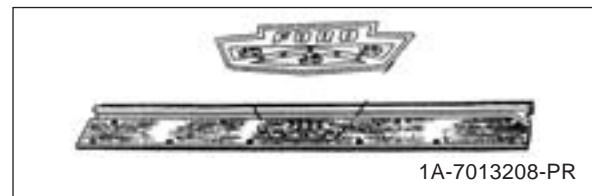

51 Cpe 1A-7013208-PRpr. 120.00
 51 Hardtop 2D 1A-7013208-PRpr. 120.00
 51 Sdn 2D 1A-7013208-PRpr. 120.00
 51 Wagon 1A-7913208-PRpr. 320.00
 52-54 Cpe BA-7013208/09-A.....pr. 110.00
 52-54 Conv BA-7013208/09-A.....pr. 110.00
 52-54 Hardtop 2D BA-7013208/09-A.....pr. 110.00
 52-54 Sdn 2D BA-7013208/09-A.....pr. 110.00

52-54	Sdn 4D	BA-7313208-PR.....pr.	110.00
52-54	Wgn	BA-7013208/09-A.....pr.	110.00
52-54	Wgn	BA-7313208-PR.....pr.	110.00
55-56	Sdn 2D	B5A-7013208-PR.....pr.	110.00
55-56	Conv	B5A-7013208-PR.....pr.	110.00
55-56	Hardtop 2D	B5A-7013208-PR.....pr.	110.00
55-56	Wgn	B5A-7013208-PR.....pr.	110.00
55-56	Sdn 4D	B5A-7313208-PR.....pr.	110.00
55-56	Wgn	B5A-7313208-PR.....pr.	110.00
39	Merc Conv	99A-7013250-51.....pr.	100.00
39	Merc 2D	99A-7013250-51.....pr.	100.00
40	Merc Conv	09A-7013250-PR.....pr.	100.00
40	Merc 2D	09A-7013250-PR.....pr.	100.00
41-48	Merc Conv	11A-7013250/51, 43".....pr.	70.00
41-48	Merc Cpe	11A-7713250-PR, 35-3/4".....pr.	70.00
41-48	Merc 2D Sdn	11A-7013250/51, 43".....pr.	70.00
41-48	Merc 4D	11A-7713250-PR, 35-3/4".....pr.	70.00
41-48	Merc Wgn	11A-7013250/51, front, 43", trim to fit.....pr.	70.00

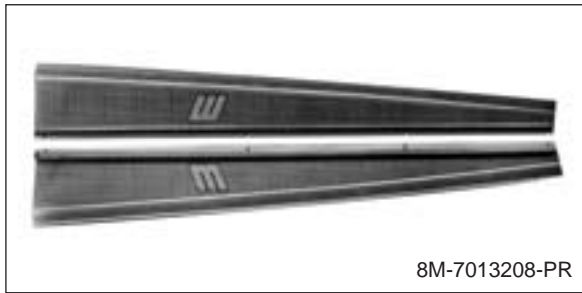

8M-7013208-PR

49-51	Merc 2D	8M-7013208-PR.....pr.	320.00
49-51	Merc Wgn	8M-7013208-PR.....pr.	320.00
49-51	Merc 4D	8M-7313208-SET.....set.	350.00
52-54	Merc 2D	BM-7013208/09.....pr.	150.00
52-54	Merc 4D	BM-7313208-PR.....pr.	150.00

Rear Door Scuff Plates

32	Sdn 4D	B-338-1, polished stainless, cut to fit.....pr.	45.00
32	Phaeton	B-138-1, polished stainless, cut to fit.....pr.	45.00
33-34	Sdn 4D	40-7313262/63.....pr.	215.00
33-34	Phaeton	40-7513262/63.....pr.	215.00
35-36	Phaeton	48-7313262/63.....pr.	215.00
35-36	Sdn 4D	48-7313262/63.....pr.	215.00
37	Phaeton	78-7413262/63.....pr.	160.00
37	Conv Sdn	78-7413262/63.....pr.	160.00
37	Sdn 4D	78-7313262/63.....pr.	215.00
38	Phaeton	81A-7413262-PR.....pr.	80.00
38-39	Conv Sdn	81A-7413262-PR.....pr.	80.00
38-39	Sdn 4D	81A-7313262/63.....pr.	80.00
40	Sdn 4D	01A-7313262/63.....pr.	80.00
41-48	Sdn 4D	11A-7313262/63, 23-3/8".....pr.	70.00
41-48	Wagon	11A-7313262/63, rear, 23-3/8".....pr.	70.00
49	Sdn 4D	8A-7313228/9.....pr.	110.00
50	Sdn 4D	0A-7313228/9.....pr.	110.00
52-54	Wgn	BA-7313228-PR.....pr.	110.00
52-54	Sdn 4D	BA-7313228-PR.....pr.	110.00
55-56	Wgn	B5A-7313228-PR.....pr.	110.00

55-56	Sdn 4D	B5A-7313228-PR.....pr.	110.00
41-48	Merc 4D	11A-7313262/63, 23-3/8".....pr.	70.00
41-48	Merc Wgn	11A-7313262/63, rear, 23-3/8".....pr.	70.00
52-54	Merc 4D	BM-7313228-PR.....pr.	150.00

Door Scuff Plate Screws

Included with 1933-36 scuff plates.

32-36	Pass	3103, 12 pcs.....set.	1.25
-------	------	-----------------------	------

Lower Door Seal Retainer

Lower door seal is sold separately.



41-48	Conv	11A-7013224-PR, 42-1/4".....pr.	70.00
41-48	Sdn 2D	11A-7013224-PR, 42-1/4".....pr.	70.00
41-48	Bus Cpe	11A-7313224-PR, 33-5/8".....pr.	70.00
41-48	Sdn 4D	11A-7313224-PR, front, 33-5/8".....pr.	70.00
41-48	Sdn 4D	11A-7313252-PR, rear, 22-1/16".....pr.	70.00
41-48	Wagon	11A-7013224-PR, front, 42-1/4".....pr.	70.00
41-48	Wagon	11A-7313252-PR, rear, 22-1/16".....pr.	70.00
41-48	Merc Conv	11A-7013224-PR, 42-1/4".....pr.	70.00
41-48	Merc 2D Sdn	11A-7013224-PR, 42-1/4".....pr.	70.00
41-48	Merc Cpe	11A-7313224-PR, 33-5/8".....pr.	70.00
41-48	Merc 4D Sdn	11A-7313224-PR, front, 33-5/8".....pr.	70.00
41-48	Merc 4D Sdn	11A-7313252-PR, rear, 22-1/16".....pr.	70.00
41-48	Merc Wgn	11A-7013224-PR, front, 42-1/4".....pr.	70.00
41-48	Merc Wgn	11A-7313252-PR, rear, 22-1/16".....pr.	70.00

Lower Door Seal

41-48	Pass	11A-701980.....ea.	6.00
41-48	Merc	11A-701980.....ea.	6.00

OUTSIDE DOOR HANDLES

Outside Door Handle



A-702350

32-33	Roadster	A-702350.....ea.	31.00
32-33	Phaeton	A-702350.....ea.	31.00
32	Cpe 3W	40-702350-PR, stainless, includes pads and screws, except wagon.....pr.	95.00
32	Cpe 3W	40-702350-R.H., chrome.....ea.	26.00
32	Cpe 3W	40-702351-L.H., chrome.....ea.	26.00



40-702350/1-L

32	Cpe 3W	40-702350/1-L, lock in handle.....pr.	50.00
----	--------	---------------------------------------	-------

Section 45 - Door



C&G Early Ford Parts, Inc.

32	Cpe 5W	B-702350-PR, stainless, includes pads and screws, except wagon.....pr.	95.00
32	Cpe 5W	B-702350-R.H., chromeea.	26.00
32	Cpe 5W	B-702351-L.H., chromeea.	26.00
32	Cpe 5W	B-702350/1-L, lock in handle, except wagon.....pr.	80.00



32	Sdn	B-702350-PR, stainless, includes pads and screws, except wagon.....pr.	95.00
32	Sdn	B-702350-R.H., chromeea.	26.00
32	Sdn	B-702351-L.H., chromeea.	26.00
32	Sdn	B-702350/1-L, lock in handle, except wagon.....pr.	80.00
33-34	Pass	40-702350-PR, stainless, includes pads and screws, except wagon.....pr.	95.00
33-34	Pass	40-702350-R.H., chrome, except wagonea.	26.00
33-34	Pass	40-702351-L.H., chrome, except wagonea.	26.00
33-34	Pass	40-702350/1-L, lock in handle, except wagon.....pr.	50.00
35	Pass	48-702350, , except wagon.....ea.	29.00
36	Pass	68-702350-A, straight.....ea.	29.00
36	Pass	68-702350-B, curved.....ea.	29.00
37	Pass	78-702350, except wagon.....ea.	29.00



38	Std Pass	81A-702350-A.....ea.	32.00
38	Dlx Pass	81A-702350-B, except wagon.....ea.	29.00
39	Pass	91A-702350, except wagon.....ea.	29.00
40	Cpe	01A-702350ea.	32.00
40	Sdn	01A-702350ea.	32.00
41	Pass	11A-702350, except wagon.....ea.	29.00



46-47	Pass	51A-702350, early 47 , except wagonea.	29.00
47-48	Pass	6A-702350, late 47, except wagonea.	29.00
49	Pass	8A-7022400, NOS, except wagonea.	30.00
50-51	Pass	0A-7022400-PR, no buttons, except wagon.....pr.	115.00
50-51	Pass	0A-7022400-RIGHT, RH, no button, except wagon.....ea.	60.00
50-51	Pass	0A-7022401-LEFT, LH, no button, except wagonea.	60.00

52-56	Pass	BA-7022400-PR, no buttons.....pr.	115.00
52-56	Pass	BA-7022400-RIGHT, RH, no buttonea.	60.00
52-56	Pass	BA-7022401-LEFT, LH, no buttonea.	60.00
32-34	PU	46-702350-Pea.	32.00



35-36	PU	50-702350ea.	32.00
37	PU	68-702350-Bea.	29.00
38-47	PU	81A-702350-A.....ea.	32.00
48-52	PU	7C-8122400-RIGHT, RHea.	35.00



48-52	PU	7C-8122401-LEFT, LHea.	35.00
53-56	PU	BAAA-8122400-PR, with buttons.....pr.	75.00
53-60	PU	BAAA-8122400-B, RH, no buttonea.	40.00
53-60	PU	BAAA-8122401-B, LH, no button.....ea.	40.00
48-56	Panel	7C-8226600-LS, rear, w/long shaft.....ea.	50.00

Outside Door Handle Button



50-51	Pass	0A-7022454ea.	15.00
52-56	Pass	BA-7022454-B, RH.....ea.	15.00
52-56	Pass	BA-7022455-B, LHea.	15.00
53-60	PU	BAAA-22454-81Aea.	15.00

Outside Door Handle Button Seal

53-60	T-Bird	BAAA-8122478-Aea.	1.50
53-60	PU	BAAA-8122478-Aea.	1.50

Outside Door Handle Pads

All handle pads listed are for two door handles, except 41-48 wagon which includes enough for four doors.



28-34	Roadster	B-35630.....pr.	5.00
28-34	Roadster	B-7622428-P, paper.....pr.	2.00
28-34	Phaeton	B-35630.....pr.	5.00
28-34	Phaeton	B-7622428-P, paper.....pr.	2.00
32-34	Pass	B-46212.....pr.	5.00
32-34	Pass	B-7022428-P, paper.....pr.	2.00

32-34	Wagon	B-46212.....	pr.	5.00
35-37	Pass	48-702356	pr.	6.00
35-37	Pass	48-7022428-P, paper	pr.	2.00
35-40	Wagon	48-702356	pr.	6.00
38-39	Pass	81A-7022428	pr.	6.00
38-39	Pass	81A-7022428-P, paper.....	pr.	2.00
40	Conv	01A-7622428	pr.	6.00
40	Cpe	99A-7022428	pr.	6.00
40	Sdn	99A-7022428	pr.	6.00
41-48	Wagon	11A-7922428-R	set.	20.00
50-51	Pass	0A-7022428, exc.wgn	pr.	8.00
50-51	Wagon	0M-7222428	pr.	9.00
52-56	Pass	BA-7222428	pr.	6.00
39	Merc	99A-7022428	pr.	6.00
41-48	Merc Wgn	11A-7922428-R	set.	20.00
49	Merc	8M-7222428, exc.wgn	pr.	15.50
50	Merc	0M-7222428, exc.wgn	pr.	9.00
50-51	Merc Wgn	0M-7222428	pr.	9.00
51	Merc	1M-7222428, exc.wgn	pr.	9.00
52-54	Merc	FAB-7222428	pr.	21.50
55-56	Montclair	BV-7222428	pr.	21.50
56	Merc	BU-7222428, exc. mntclr.....	pr.	26.00
32-36	PU	B-46212.....	pr.	5.00
37-47	PU	48-702356	pr.	6.00
37-47	PU	48-7022428-P, paper	pr.	2.00
48-52	PU	7C-8122428.....	pr.	4.00
53-60	PU	BAAA-8122428	pr.	6.00
48-56	Panel	BAAA-8222428-P, rear	ea.	4.00

Outside Door Handle Screws

28-34	Pass	1104-W, wood frame	ea.	.40
32-38	Pass	1104-L, stainless.....	ea.	.40
32-47	PU	1104-L, stainless.....	ea.	.40

Stainless Outside Door Handle Shield



53-56	PU	BAAA-22406-81	set.	22.00
-------	----	---------------------	------	-------

INSIDE DOOR HANDLE

Inside Door Handle

All inside door handles are chrome plated unless otherwise specified.



32	Roadster	18-702400-A	pr.	50.00
32	Phaeton	18-702400-A	pr.	50.00



32	Pass	B-702400-E	ea.	10.00
33-34	Roadster	A-702400-C	ea.	10.00
33-34	Phaeton	A-702400-C	ea.	10.00



33-34	Pass	40-702400-E	ea.	10.00
35	Roadster	48-7622600	pr.	24.00
35	Phaeton	48-7622600	pr.	24.00



35	Pass	48-702400-E	ea.	10.00
35	Dlx Pass	48-702400-G, gray.....	ea.	10.00
36	Roadster	68-7622600	pr.	24.00
36	Phaeton	68-7622600	pr.	24.00



36	Pass	68-702400-E	ea.	10.00
36	Dlx Pass	68-702400-G, early, dark gray	ea.	10.00
36	Dlx Pass	68-702400-M, late, dark mahogany	ea.	10.00
36	Wagon	68-7622600	pr.	24.00
37	Std Pass	78-7022600-A.....	ea.	13.50
37	Dlx Pass	78-7022600-B, brown.....	ea.	12.00
37-39	Wagon	68-792400-PR	pr.	170.00
38	Std Pass	81A-702400	ea.	10.00
38	Dlx Pass	81A-7022600-B	ea.	12.00



39	Std Pass	91A-7022600-A.....	ea.	15.00
39	Dlx Pass	91A-7022600-B, brown	ea.	12.00
40	Std Pass	91A-7022600-A	ea.	15.00
40	Dlx Pass	01A-7022600-B, brown	ea.	12.00
40	Dlx Pass	01A-7022600-D.....	ea.	15.00
40	Wgn	91A-7022600-A, front door	ea.	15.00



41-48	Pass	11A-702400ea.	15.00
41-48	Wgn	11A-702400, front doorea.	15.00
49	Pass	8A-7022614-Aea.	15.00
49	Wagon	8A-7022614-Aea.	15.00



50	Pass	0A-7022614-Bea.	15.00
50	Wagon	0A-7022614-Bea.	15.00
51-56	Pass	B5A-7022600-Aea.	25.00
51-56	Wagon	B5A-7022600-Aea.	25.00
55-56	T-Bird	B5A-7022600-Aea.	25.00
32-34	PU	46-702400, w/screwea.	10.00
35	PU	48-702400-Eea.	10.00
36-37	PU	68-702400-Eea.	10.00
38-47	PU	81A-702400ea.	10.00
38-40	PU	91A-7022600-A, not correctea.	15.00
48-52	PU	7C-8122614ea.	12.00
53-55	PU	BAAA-8122600ea.	15.00
56	PU	B6C-8122600ea.	14.00
32-56	Panel	A-702400-C, rearea.	10.00

Inside Rear Door Handle



36-48	Wagon	68-792400-PRpr.	170.00
41-48	Merc Wgn	68-792400-PRpr.	170.00

Inside Door Handle And Window Crank Pin

32-50	Pass	RP-702400ea.	.25
35-52	PU	RP-702400ea.	.25

Inside Door Handle And Window Crank Clip

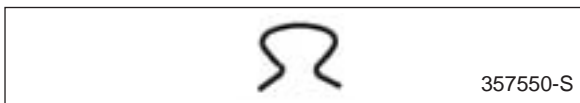

51-56	Pass	357550-Sea.	.50
53-55	PU	357550-Sea.	.50

Inside Door Handle Control Rod



32	Roadster	18-702401-Rpr.	8.50
32	Phaeton	18-702401-Rpr.	8.50

Chrome Door Pull Handle



33	Pass	40-702420-Aset.	69.95
----	------	-------------	-----------	-------

Rope Type Door Pull Straps & Brackets



34-35	Pass	40-702420set.	80.00
-------	------	-----------	-----------	-------

WINDOW CRANK

Window Crank

If the crank is chrome, only the color of the knob will be listed. 1935-40 Deluxe cars had painted handles with plastic knobs. 1941-56 Wagons use car handles.

32	Pass	B-702780-E, chrome knobea.	15.00
----	------	-------------------------	----------	-------



33-34	Pass	40-702780-E, chrome knobea.	20.00
35	Pass	48-702780-E, chrome knobea.	15.00
35	Dlx Pass	48-702780-G, gray handle, ivory knobea.	15.00



36	Pass	68-702780-E, chrome knobea.	15.00
36	Dlx Pass	68-702780-G, dark gray handle, gray knobea.	15.00
36	Dlx Pass	68-702780-M, dark brown handle, brown knobea.	15.00
37	Std Pass	78-702780, chrome knobea.	15.00
37	Std Pass	78-7023342-A, chrome handle, light brown knobea.	20.00
37	Dlx Pass	78-7023342-B, brown handle, yellow brown knobea.	20.00
38	Std Pass	81A-702780, chrome knobea.	15.00
38	Std Pass	81A-7023342-A, ivory knobea.	20.00
38	Dlx Pass	81A-7023342-B, brown handle, ivory knobea.	20.00

39	Std Pass	91A-7023342-A, yellow knob.....ea.	20.00
39	Dlx Pass	91A-7023342-B, brown handle, yellow knob.....ea.	20.00



39-40	Std Pass	91A-7023342-D, chrome knob.....ea.	20.00
40	Std Pass	01A-7023342-A, sand knob.....ea.	20.00
40	Dlx Pass	01A-7023342-B, brown handle, sand knob.....ea.	20.00
40	Dlx Pass	01A-7023342-D, chrome knob.....ea.	20.00



41-48	Pass	11A-702780-C, chrome knob.....ea.	15.00
41	Pass	11A-7023342, tan knob.....ea.	20.00
42	Dlx Pass	21A-7023342-A, maroon knob.....ea.	20.00



42	Super Dlx	21A-7023342-B, butterscotch knob.....ea.	20.00
46	Dlx Pass	51A-7023342-A, chocolate knob.....ea.	20.00
46	Super Dlx	51A-7023342-B, blue gray knob.....ea.	20.00
46	Super Dlx	51A-7023342-C, gray tan knob.....ea.	20.00
47-48	Pass	51A-7023342-C, gray tan knob.....ea.	20.00
49	Pass	8A-7023342-C, chrome knob.....ea.	17.50



49	Pass	8A-7023342-D, gray knob.....ea.	17.50
50	Pass	0A-7023342-B, ivory knob.....ea.	17.50
50	Pass	0A-7023342-C, black knob.....ea.	17.50



51-56	Pass	B5A-7023342-A, black knob.....ea.	26.00
55-56	T-Bird	B5A-7023342-A, black knob.....ea.	26.00
32-34	PU	46-702780, chrome knob.....ea.	15.00
35	PU	48-702780-E, chrome knob.....ea.	15.00
36-37	PU	68-702780-E, chrome knob.....ea.	15.00
38-40	PU	81A-702780, chrome knob.....ea.	15.00
39-47	PU	91A-7023342-D, chrome knob, not correct.....ea.	20.00



41-47	PU	11C-7023342, black knob.....ea.	15.00
48-52	PU	7C-8123342, black knob.....ea.	16.50
53-55	PU	BAAA-8123342, black knob.....ea.	20.00
56	PU	B6C-8123342, black knob.....ea.	15.00

Quarter Window Handle Kit



41-48	Conv	11A-7923410-DK, chrome.....kit.	50.00
42	Conv	21A-7923410-BK, butterscotch.....kit.	50.00
46-48	Conv	51A-7923410-CK, gray tan.....kit.	50.00

Quarter Window Handle



41	Conv	11A-7923410, tan knob.....ea.	15.00
42	Conv	21A-7923410-A, maroon knob.....ea.	15.00
42	Conv	21A-7923410-B, butterscotch knob.....ea.	15.00
46	Conv	51A-7923410-A, chocolate knob.....ea.	15.00
46	Conv	51A-7923410-B, blue-gray knob.....ea.	15.00
46-48	Conv	51A-7923410-C, gray-tan knob.....ea.	15.00
51-56	Conv	1A-7630322.....ea.	30.00
51-56	Hardtop 2D	1A-7630322.....ea.	30.00



Window Crank Knob

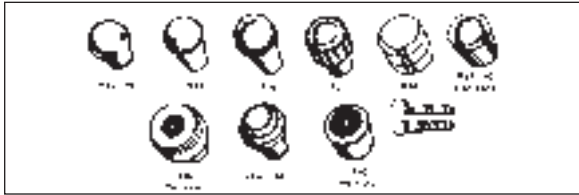

32-34	Pass	B-7023345, brown marble.....ea.	5.00
35	Dlx Pass	48-7023345-B, ivory.....ea.	5.00
36	Dlx Pass	68-7023345-B, light gray.....ea.	5.00
36	Dlx Pass	68-7023345-C, brown w/marble.....ea.	5.00
37	Std Pass	78-7023345-A, light brown.....ea.	5.00
37	Dlx Pass	78-7023345-B, yellow brown.....ea.	5.00
38	Pass	81A-7023345, ivory.....ea.	5.00
39	Pass	91A-7023345, light yellow.....ea.	5.00
40	Std Pass	01A-7023345-A, sand.....ea.	5.00
40	Dlx Pass	01A-7023345-B, sand.....ea.	5.00
41	Pass	11A-7023345, tan.....ea.	5.00
42	Dlx Pass	21A-7023345-A, maroon.....ea.	5.00
42	Super Dlx	21A-7023345-B, butterscotch.....ea.	5.00
46	Dlx Pass	51A-7023345-A, chocolate.....ea.	5.00
46	Super Dlx	51A-7023345-B, blue gray.....ea.	5.00
46	Super Dlx	51A-7023345-C, gray tan.....ea.	5.00
47-48	Pass	51A-7023345-C, gray tan.....ea.	5.00
49	Pass	8A-7023341-D, light gray.....ea.	5.50
50	Pass	0A-7023341-BS, ivory.....ea.	5.50
50	Pass	0A-7023341-CS, black.....ea.	6.00
51-56	Pass	1A-7023352, black.....ea.	6.00
39	Merc	99A-7023345, pink.....ea.	6.00
40	Merc	09A-7023345, dark blue.....ea.	6.00
55-56	T-Bird	1A-7023352, black.....ea.	6.00
41-47	PU	11C-7023345, black.....ea.	5.00
48-52	PU	7C-8123341-S, black.....ea.	6.50
53-56	PU	BAAA-8123341, black.....ea.	6.50

ESCUTCHEONS

Inside Handle Escutcheons

32	Roadster	B-46270-AS, chrome.....set.	18.00
32	Phaeton	B-46270-AS, chrome.....set.	18.00
32	Pass	B-48139-AC, stainless.....ea.	3.75



B-48139-A

32-36	Pass	B-48139-A, chrome, spring loaded.....ea.	5.00
33-34	Roadster	40-48139-BC, chrome.....ea.	3.75
33-34	Phaeton	40-48139-BC, chrome.....ea.	3.75
33-34	Pass	40-48139-AC, stainless.....ea.	3.75
35-36	Roadster	68-48139-BC, chrome.....ea.	3.75
35-36	Phaeton	68-48139-BC, chrome.....ea.	3.75



48-48139-AC

35-36	Pass	48-48139-AC, stainless.....ea.	3.75
35	Dlx Pass	48-7022618-B, gray.....ea.	4.00
36	Dlx Pass	68-7022618-B, gray.....ea.	4.00
36	Dlx Pass	68-7022618-C, red brown.....ea.	4.00
37	Std Pass	78-7022618-A, light brown.....ea.	4.00
37	Dlx Pass	78-7022618-B, yellow brown.....ea.	4.00
37	Pass	78-48139-SS, stainless.....ea.	3.75
38	Pass	81A-7022618, ivory.....ea.	4.00
38-39	Pass	81A-7022618-S, stainless.....ea.	10.00
39	Pass	91A-7022618, light yellow.....ea.	4.00
40	Std Pass	01A-7022618-A, sand.....ea.	4.00
40	Std Pass	81A-7022618-S, stainless.....ea.	10.00
40	Dlx Pass	01A-7022618-B, sand.....ea.	4.00
40	Dlx Pass	01A-7022618-D, stainless.....ea.	10.00
40	Wagon	91C-8122618, stainless, for door handle only.....ea.	8.00
41-48	Pass	11A-48139-SS, stainless.....ea.	15.00
41	Pass	11A-7022618, tan.....ea.	8.50
42	Dlx Pass	21A-7022618-A, maroon.....ea.	8.50
42	Super Dlx	21A-7022618-B, butterscotch.....ea.	8.50
46	Dlx Pass	51A-7022618-A, chocolate.....ea.	8.50
46	Super Dlx	51A-7022618-B, blue gray.....ea.	8.50
46	Super Dlx	51A-7022618-C, gray tan.....ea.	8.50
47-48	Pass	51A-7022618-C, gray tan.....ea.	8.50



0A-7022618-E

0A-7022618-F

49-50	Pass	0A-7022618-E, ivory w/chrome.....ea.	12.50
49-50	Pass	0A-7022618-F, chrome.....ea.	12.50
51	Wagon	1A-7922618, butterscotch.....ea.	12.50

39	Merc	99A-7022618, pink.....ea.	5.00
40	Merc	09A-7022618, blue.....ea.	5.00
51	Merc Wgn	1A-7922618, butterscotch.....ea.	12.50
32-34	PU	46-48139-AC, stainless.....ea.	3.75
32-37	PU	B-48139-A, chrome, spring loaded.....ea.	5.00
35-37	PU	48-48139-AC, stainless.....ea.	3.75
38-47	PU	91C-8122618, stainless.....ea.	8.00
48-52	PU	7C-8122618, stainless, fits 48-50 original regulators and 48-52 reproduction regulators.....ea.	9.00
51-52	PU	1C-8122618, chrome, use with original regulators.....ea.	8.00
53-55	PU	BAAA-8122618, stainless with rubber.....ea.	7.50
56	PU	B6C-8122618, stainless.....ea.	7.00

Door & Window Handle Backing Plate

Correct thin plastic with lip around hole in center.

51-63	Pass	B7A-7023370-B.....ea.	3.00
-------	------	-----------------------	------

Quarter Window Handle Escutcheon



52-59	Hardtop 2D	BAAA-8122618, stainless with rubber.....ea.	7.50
52-59	Conv	BAAA-8122618, stainless with rubber.....ea.	7.50
52-59	Merc 2D Hdt	BAAA-8122618, stainless with rubber.....ea.	7.50
52-59	Merc Conv	BAAA-8122618, stainless with rubber.....ea.	7.50

Escutcheon Spring

Fits between the door panel and the door.



28-56	Pass	B-48284.....ea.	.75
-------	------	-----------------	-----

Door Escutcheon Pad Kit



41-48	Merc Wgn	11A-7923465-K.....kit.	20.00
41-48	Wagon	11A-7923465-K.....kit.	20.00

Door Lock Escutcheon

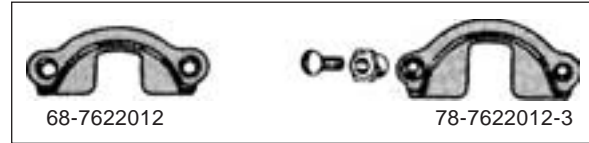

35-36	Roadster	68-7622012.....pr.	30.00
35-36	Phaeton	68-7622012.....pr.	30.00
35-36	Conv Sdn	78-7622012/3.....pr.	25.00
37-40	Conv	78-7622012/3.....pr.	25.00

DOOR PANELS

Fiberglass Door Panels

Must drill holes for mounting clips, B-20018, not included.

*35-37	PU	50-8123890/1.....pr.	135.00
*38-39	PU	81C-8123890/1.....pr.	135.00

ABS Plastic Door Panel

Must drill holes for mounting clips, B-20018, not included.

*35-36	PU	FORD-3536-TDP.....pr.	91.00
--------	----	-----------------------	-------

Cardboard Door Panels

Clips not included on 53-56 PU.



51-52	PU	1C-8123890-BL, black.....pr.	25.00
51-52	PU	1C-8123890-BR, brown.....pr.	25.00
51-52	PU	1C-8123890-GR, gray.....pr.	25.00
51-52	PU	1C-8123890-RD, red.....pr.	16.50
53-55	PU	BAAA-8123890/1, gray.....pr.	50.00
56	PU	B6C-8123890/1, gray.....pr.	50.00

Door Panel Clips

32-56	Pass	B-20015-EA.....ea.	.25
32-56	Pass	B-20015, 50 pcs.....set.	12.00
35-39	PU	B-20018.....ea.	.75
53-56	PU	BAAA-8120018.....set.	7.00

Door Panel Screws

48-52	PU	6-0361, stainless.....kit.	12.50
-------	----	----------------------------	-------



ARM RESTS

Door Arm Rest Kit

Sold in pairs. Upholstery is not included.



32-48 Pass A-56665-PR, frontpr. 75.00

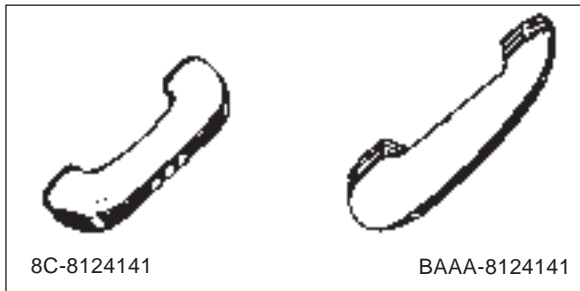

50-51 Pass BAAA-8124141, black, front or rearpr. 50.00
 48-50 PU 8C-8124141, blackpr. 50.00
 51-56 PU BAAA-8124141, blackpr. 50.00

Rear Arm Rest Kit

28-34 Pass A-56666-PRkit. 75.00

Arm Rest Pad

Included in arm rest kit.

32-48 Pass A-56665-Spr. 29.00

TRIM PANELS/GARNISH MOLDING

Door Window Trim Panels

Die stamped steel panels attach where cardboard door panel ends at garnish molding.

37-39 Pass 91A-7323810/11-Bpr. Call
 40 Std Pass 91A-7323810/11-Bpr. Call
 40 Dlx 91A-7323810/11-Apr. Call
 40 Sdn 4D 91A-7323810/11-A, firt doorspr. Call
 40 Sdn Dly 91A-7323810/11-A, firt doorspr. Call

Garnish Molding Clips

38-39 Pass 91A-7020930-B, set of 10kit. 48.00

DOOR EMBLEMS

Garnish Molding Insert

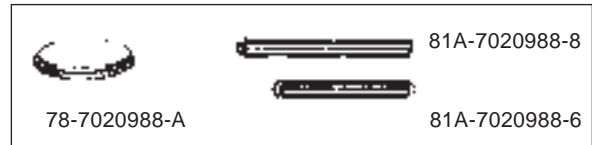

37 Std Pass 78-7020988-A, light brownpr. 15.00
 37 Dlx Pass 78-7020988-B, yellow brownpr. 15.00
 38 Pass 81A-7020988-6, 6"pr. 15.00
 38 Pass 81A-7020988-8, 8"pr. 15.00

Door Panel Emblem



49 Pass 8A-7020988/9Apr. 60.00



50 Conv 0A-7020988/9B, blackpr. 60.00
 50 Pass 0A-7020988/9A, gray, exc. convpr. 60.00
 50 Merc 0M-7220988-GPR, gold backgroundpr. 75.00



50 Merc 0M-7220988-BPR, black backgroundpr. 75.00

**Section 46
Vent**

VENT WINDOW FRAME

Vent Window Frame

53-55 PU BAAA-8121402-B, RH, stainlessea. 120.00
 53-55 PU BAAA-8121403-B, LH, stainlessea. 120.00

VENT WINDOW SEALS

Vent Window Seals

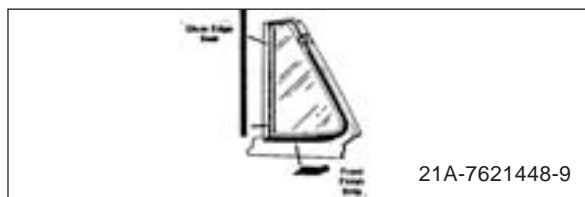

40	Conv	01A-7621448/9	pr.	50.00
40	Pass	01A-7021448/9, exc. conv	pr.	60.00
40-41	Sdn Dly	01A-7021448/9	pr.	60.00
41-48	Conv	21A-7621448/9	pr.	55.00
41-48	Pass	11A-7021448/9, except conv	pr.	60.00
41-48	Wagon	11A-7021448/9	pr.	60.00
49-50	Conv	8A-7621448/9B, early 50.....	pr.	120.00
50-51	Conv	0A-7621448/9, late 50.....	pr.	120.00
49	Pass	WR-3300, exc. conv.....	pr.	148.00
49-51	Pass	8A-7021448/9A, exc. conv	pr.	80.00
50-51	Wagon	8M-7921448-PR.....	pr.	250.00
51	Hardtop 2D	0A-7621448/9	pr.	120.00
52-54	Conv	BA-7621448/49-A.....	pr.	95.00
52-54	Pass	BA-7021448/49-A, exc. 2 Dr Hrdtop & conv	pr.	95.00
52-54	Hardtop 2D	BA-7621448/49-A.....	pr.	95.00
52-54	Wagon	BA-7021448/49-A.....	pr.	95.00
55-56	Conv	B5A-7621448/49-B.....	pr.	95.00
55-56	Pass	B5A-7021448/49-A, exc. 2 Dr Hrdtop & conv	pr.	95.00
55-56	Crown Vic	B5A-7621448/49-B.....	pr.	95.00
56	Hardtop 2D	B5A-7621448/49-B.....	pr.	95.00
55-56	Wagon	B5A-7021448/49-A	pr.	95.00
40	Merc Conv	WR-3319	pr.	158.00
40	Merc Cpe	WR-3318	pr.	158.00
41-48	Merc	11A-7021448/9, except conv	pr.	60.00
41-48	Merc Conv	21A-7621448/9	pr.	55.00
41-48	Merc Wgn	11A-7021448/9	pr.	60.00
49	Merc Conv	WR-3312	pr.	126.00
49	Merc Sdn	WR-3302	pr.	109.00
50-51	Merc Sdn	WR-3311	pr.	100.00
50-51	Merc Wgn	8M-7921448-PR.....	pr.	250.00
52-54	Merc	BA-7021448/49-A, exc. 2 Dr Hrdtop & conv	pr.	95.00
52-54	Merc 2D Hdtp	BA-7621448/49-A.....	pr.	95.00
52-54	Merc Conv	BA-7621448/49-A.....	pr.	95.00
52-54	Merc Wgn	BA-7021448/49-A.....	pr.	95.00
48-52	PU	7C-8121448/9.....	pr.	55.00
53-55	PU	BAAA-8121448/9	pr.	70.00
56	PU	B6C-8121448/9	pr.	70.00

Back Edge Vent Window Seal w/Steel Insert



40	Conv	01A-7022296-A	pr.	16.00
40-42	Pass	11A-7022296, felt, exc.conv.....	pr.	16.00
41-48	Conv	11A-7022296-A	pr.	16.00
41-42	Wagon	11A-7022296, felt.....	pr.	16.00
46-48	Pass	51A-7022296, except conv	pr.	25.00
46-48	Wagon	51A-7022296	pr.	25.00
49-51	Conv	8A-7621450	pr.	20.00
49-51	Pass	8A-7021450, exc. conv & wagon	pr.	20.00
51	Hardtop 2D	8A-7621450	pr.	20.00
50-51	Wagon	0A-7921450-PR	pr.	30.00
52-54	Pass	BA-7021450, exc. 2 Dr Hrdtop & conv	pr.	16.50
52-54	Hardtop 2D	BA-7621450	pr.	16.50
52-54	Conv	BA-7621450	pr.	16.50
52-54	Wagon	BA-7021450	pr.	16.50
55-56	Pass	B5A-7021450-PR, exc. 2 Dr Hrdtop & conv	pr.	16.50
55-56	Crown Vic	B5A-7621450	pr.	16.50
55-56	Conv	B5A-7621450	pr.	16.50
56	Hardtop 2D	B5A-7621450	pr.	16.50
55-56	Wagon	B5A-7021450-PR.....	pr.	16.50
41-48	Merc Conv	11A-7022296-A	pr.	16.00
41-42	Merc	11A-7022296, felt.....	pr.	16.00
41-42	Merc Wgn	11A-7022296, felt.....	pr.	16.00
46-48	Merc	51A-7022296, except conv	pr.	25.00
46-48	Merc Wgn	51A-7022296	pr.	25.00
49-51	Merc Conv	8M-7621450-PR.....	pr.	30.00
49	Merc	8M-7021450-PR, exc. conv & wagon	pr.	30.00
50-51	Merc	0M-7221450-PR, exc. conv & wagon	pr.	25.00
50-51	Merc Wgn	0A-7921450-PR	pr.	30.00
52-54	Merc	BA-7021450, exc. 2 Dr Hrdtop & conv	pr.	16.50
52-54	Merc 2D Hdtp	BA-7621450	pr.	16.50
52-54	Merc Conv	BA-7621450	pr.	16.50
52-54	Merc Wgn	BA-7021450	pr.	16.50
48-52	PU	7C-8121450-RM	pr.	17.50
53-55	PU	BAAA-8121450-PR	pr.	17.50
56	PU	B6C-8121450-PR.....	pr.	17.50

Front of Vent Window Foot Seal

49-51	Conv	8A-7623038-PR	pr.	25.00
49-51	Hardtop 2D	8A-7623038-PR	pr.	25.00
49-51	Merc Conv	WREX-3312.....	pr.	21.50



VENT WINDOW HANDLES/PIVOTS

Vent Window Handle



40-48	Pass	01A-7022916/7	pr.	55.00
49-56	Pass	A9AZ-7022916-A, RH, exc. 2Dr Hrdtop/conv	ea.	30.00



49-56	Pass	A9AZ-7022917-A, LH, exc. 2Dr Hrdtop/conv	ea.	30.00
49	Wagon	01A-7022916/7	pr.	55.00
40-48	Merc	01A-7022916/7	pr.	55.00



48-50	PU	78-7022916, RH	ea.	30.00
48-50	PU	78-7022917, LH	ea.	30.00
51-52	PU	8M-7022916, RH	ea.	30.00
51-52	PU	8M-7022917, LH	ea.	30.00



53-55	PU	BAAA-8122916, RH	ea.	25.00
53-55	PU	BAAA-8122917, LH	ea.	30.00
56	PU	A9AZ-7022916-A, RH	ea.	30.00
56	PU	A9AZ-7022917-A, LH	ea.	30.00

Vent Window Handle Button

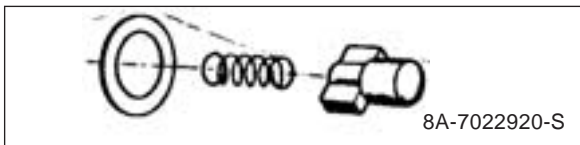

49-56	Pass	8A-7022920-S	kit.	5.50
51-56	PU	8A-7022920-S	kit.	5.50

Vent Window Handle Bracket



40-48	Pass	01A-7022938	ea.	15.00
49-56	Pass	8A-7022938-B, RH	ea.	15.00
49-56	Pass	8A-7022939-B, LH	ea.	15.00
40-48	Merc	01A-7022938	ea.	15.00
48-50	PU	7C-7022938	ea.	15.00
51-55	PU	01A-7022938	ea.	15.00



56	PU	8A-7022938-B, RH	ea.	15.00
56	PU	8A-7022939-B, LH	ea.	15.00

Vent Window Crank Handle & Escutcheon Kit

Kit includes two handles & two escutcheons. All handles are chrome with color choice of knob & escutcheon.

41	Pass	11A-7023410-K, tan, exc. wagon	kit.	50.00
42	Super Dlx	21A-7023410-BK, exc. wgn, butterscotch	kit.	50.00
42	Wagon	21A-7023410-BKW, butterscotch	ea.	50.00
46	Super Dlx	51A-7023410-BK, exc. conv/wgn, blue gray	kit.	50.00

Vent Window Crank Handle

Coupe, sedan, and convertible have 1-1/8" long shaft. Wagon have 7/8" long shaft.

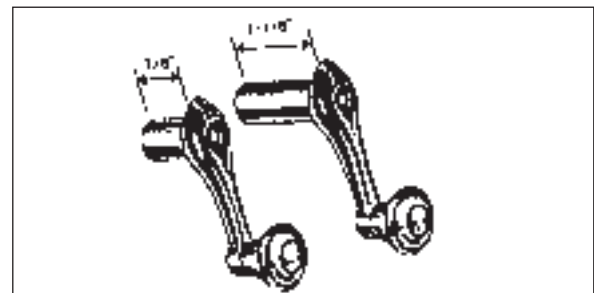

41-48	Cpe/Sdn	11A-702448, chrome knob	ea.	12.00
41-48	Wagon	51A-7923410-CC, chrome knob	ea.	15.00
41	Cpe/Sdn	11A-7023410, tan knob	ea.	15.00
41	Conv	11A-7023410, tan knob	ea.	15.00
41	Wagon	11A-7923410, tan knob	ea.	15.00
42	Cpe/Sdn	21A-7023410-A, maroon knob ...	ea.	15.00
42	Conv	21A-7023410-A, maroon knob ...	ea.	15.00
42	Wagon	21A-7923410-A, maroon knob ...	ea.	15.00
42	Cpe/Sdn	21A-7023410-B, butterscotch knob	ea.	15.00
42	Conv	21A-7023410-B, butterscotch knob	ea.	15.00
42	Wagon	21A-7923410-B, butterscotch knob	ea.	15.00
46	Cpe/Sdn	51A-7023410-A, chocolate knob	ea.	15.00
46	Conv	51A-7023410-A, chocolate knob	ea.	15.00
46	Wagon	51A-7923410-A, chocolate knob	ea.	15.00
46	Cpe/Sdn	51A-7023410-B, blue-gray knob	ea.	15.00
46	Conv	51A-7023410-B, blue-gray knob	ea.	15.00
46	Wagon	51A-7923410-B, blue-gray knob	ea.	15.00
46-48	Cpe/Sdn	51A-7023410-C, gray-tan knob	ea.	15.00

46-48	Conv	51A-7023410-C, gray-tan knob	ea.	15.00
46-48	Wagon	51A-7923410-C, gray-tan knob	ea.	15.00

Vent Window Crank Handle Fillister Screw

41-48	Pass	10-32X11/2, SS	ea.	.50
-------	------	----------------------	-----	-----

Vent Window Crank Escutcheon

41	Pass	11A-7023404, tan	ea.	4.00
42	Dlx	21A-7023404-A, maroon	ea.	4.00
42	Super Dlx	21A-7023404-B, butterscotch.....	ea.	4.00
46	Dlx	51A-7023404-A, chocolate.....	ea.	4.00
46	Super Dlx	51A-7023404-B, blue gray	ea.	4.00
46-48	Pass	51A-7023404-C, gray tan	ea.	4.00

Vent Window Gear Kit

Includes rivets and spring. One kit required per side.



41-48	Pass	11A-7023402	ea.	30.00
41-48	Merc	11A-7023402	ea.	30.00

Male Upper Vent Window Pivot

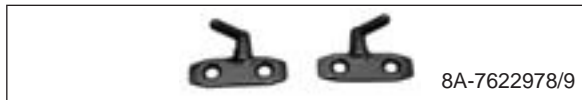

49-51	Conv	8A-7622978/9, SS.....	pr.	29.95
51	Hardtop 2D	8A-7622978/9, SS.....	pr.	29.95

Female Upper Vent Window Pivot

Chrome plated

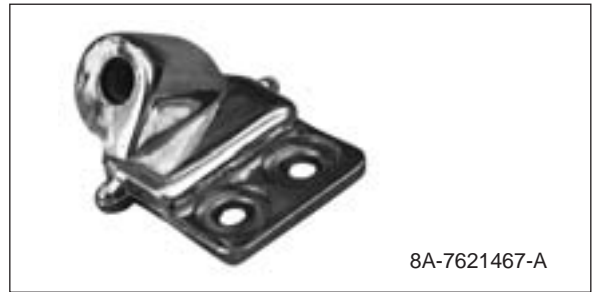

50-51	Conv	8A-7621467-A, LH	ea.	20.00
50-51	Conv	8A-7621466-A, RH	ea.	20.00
51	Hardtop 2D	8A-7621467-A, LH	ea.	20.00
51	Hardtop 2D	8A-7621466-A, RH	ea.	20.00

Vent Window Lower Pivot Kit

Includes stop washer, locating knurls, tension washers, and spring.

53-55	PU	BAAA-8121409-K, LH	ea.	32.50
53-55	PU	BAAA-8121408-K, RH.....	ea.	32.50

Vent Window Lower Pivot



53-55	PU	BAAA-8121408-S, RH or LH.....	ea.	34.00
-------	----	-------------------------------	-----	-------

Vent Window Lower Pivot Spring & Washer Set

53-55	PU	BAAA-8121410-K, 2 req	set.	15.00
53-55	PU	BAAA-8121410-K, 2 req	set.	15.00

Lower Vent Window Pivot Spring

53-56	Pass	B5A-7022926-A	ea.	5.00
-------	------	---------------------	-----	------

“Thanx for your reply. FYI, I sent out many many emails last week with the same inquiry...mostly garnered from the Web. You are the only one that had the courtesy to reply. I will keep you in mind if and when I have other needs and will give your name to others in 'the hobby'”

Dan L.

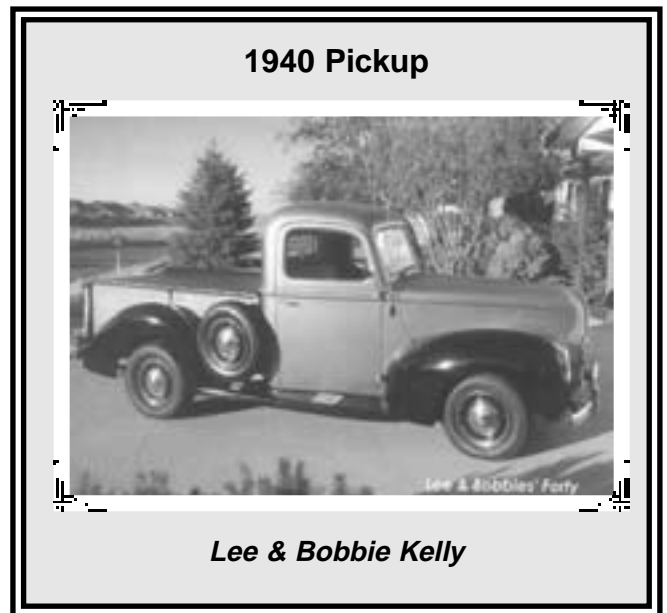



Section 47 Window

WINDOW CHANNEL KITS

Two kits available for 1934 cars; front mount or center mount inside door handle. Two kits available for 1935-36 cars; rubber bumpers or one sided felt on the garnish molding and door. 1941-42 pass used two types of lower guide channel; slotted holes or threaded holes. 1946-51 pass have stainless bead. All kits include mounting hardware. 1935-48 Pass kits DO NOT include original style hardware. 1949-51 Pass and 1948-56 pick-up include original style mounting hardware.

Car Front Door Window Channel Kits

One kit does both front doors.

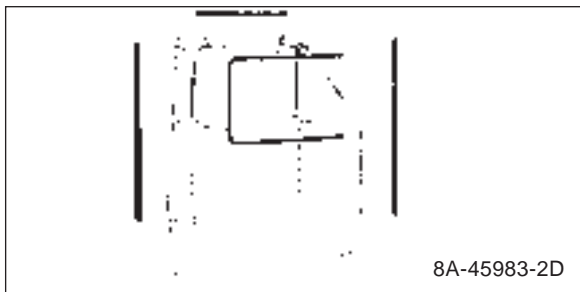

32	Cpe 3W	B-45983-3W	kit.	70.00
32	Cpe 5W	B-45983-5W/4D/2D	kit.	64.00
32	Victoria	B-45983-V	kit.	64.00
32	B-400	B-45983-V	kit.	64.00
32	Sdn 2D	B-45983-5W/4D/2D	kit.	64.00
32	Sdn 4D	B-45983-5W/4D/2D	kit.	64.00
33	Cpe 3W	18-45983-3W	kit.	75.00
33	Cpe 5W	18-459835W/4D/2D	kit.	63.00
33	Sdn	18-459835W/4D/2D	kit.	63.00
34	Cpe 3W	40-45983-3W	kit.	98.00
34	Cpe 5W	40-45983-5WC, w/center handles	kit.	98.00
34	Cpe 5W	40-45983-5WF, w/front handles	kit.	90.00
34	Sdn 2D	40-45983-2DC, w/center handles	kit.	98.00
34	Sdn 2D	40-45983-2DF, w/front handles	kit.	90.00
34	Sdn 4D	40-45983-4DC, w/center handles	kit.	98.00
34	Sdn 4D	40-45983-4DF, w/front handles	kit.	90.00
35-36	Cpe 3W	48-45983-3WB, w/felt	kit.	105.00
35-36	Cpe 3W	48-45983-3WA, w/rubber	kit.	95.00
35-36	Cpe 5W	48-45983-5W/4DB, w/felt	kit.	105.00
35-36	Cpe 5W	48-45983-5W/4DA, w/bumpers	kit.	98.00
35-36	Sdn 2D	48-45983-2DC, w/felt	kit.	105.00

35-36	Sdn 2D	48-45983-2DF, w/rubber	kit.	98.00
35-36	Sdn 4D	48-45983-5W/4DB, w/felt	kit.	105.00
35-36	Sdn 4D	48-45983-5W/4DA, w/bumpers	kit.	98.00
35-36	Cabriolet	48-45983-CA, w/stainless	kit.	75.00
37-39	Cpe	78-45983-5W/4D	kit.	105.00
37-38	Club Cpe	78-45983-2D, with swing out quarter windows	kit.	105.00
37-39	Sdn 2D	78-45983-2D	kit.	105.00
37-39	Sdn 4D	78-45983-5W/4D	kit.	105.00
40	Conv	01A-45983-C	kit.	56.00
40	Cpe	01A-45983-5W/4D	kit.	98.00
40	Sdn 2D	01A-45983-2D	kit.	98.00
40	Sdn 4D	01A-45983-5W/4D	kit.	98.00
40-41	Sdn Dly	01A-45983-5W/4D	kit.	98.00
41	Conv	11A-45983-C	kit.	65.00
41-42	Cpe	11A-45983-5W/4DB, w/threaded holes	kit.	98.00
41-42	Cpe	11A-45983-5W/4DA, w/slotted holes	kit.	98.00
41-42	Sdn Cpe	11A-45983-2DB, w/threaded holes	kit.	98.00
41-42	Sdn Cpe	11A-45983-2DA, w/slotted holes	kit.	98.00
41-42	Sdn 2D	11A-45983-2DB, w/threaded holes	kit.	98.00
41-42	Sdn 2D	11A-45983-2DA, w/slotted holes	kit.	98.00
41-42	Sdn 4D	11A-45983-5W/4DB, w/threaded holes	kit.	98.00
41-42	Sdn 4D	11A-45983-5W/4DA, w/slotted holes	kit.	98.00
42	Sdn Dly	11A-45983-5W/4DB, w/threaded holes	kit.	98.00
42	Sdn Dly	11A-45983-5W/4DA, w/slotted holes	kit.	98.00
42-48	Conv	21A-45983-C	kit.	65.00
46-48	Cpe	21A-45983-5W/4D	kit.	98.00
46-48	Sdn Cpe	21A-45983-2D	kit.	98.00
46-48	Sdn 2D	21A-45983-2D	kit.	98.00
46-48	Sdn 4D	21A-45983-5W/4D	kit.	98.00
49	Cpe	8A-45983-2D	kit.	100.00
49	Sdn 2D	8A-45983-2D	kit.	100.00
49	Sdn 4D	8A-45983-4D	kit.	100.00



50-51	Wagon	1A-45983-W	kit.	215.00
50	Cpe	0A-45983-2D	kit.	100.00
50	Sdn 2D	0A-45983-2D	kit.	100.00
50	Sdn 4D	0A-45983-4D	kit.	100.00
50-51	Cpe	1A-45983-2D, w/stainless	kit.	100.00
50-51	Sdn 2D	1A-45983-2D, w/stainless	kit.	100.00
50-51	Sdn 4D	1A-45983-4D, w/stainless	kit.	100.00
41	Merc Conv	11A-45983-C	kit.	65.00

41-42	Merc Cpe	11A-45983-5W/4DB, w/threaded holeskit.	98.00
41-42	Merc Cpe	11A-45983-5W/4DA, w/slotted holeskit.	98.00
41-42	Merc Sdn Cpe11A-45983-2DB, w/threaded holeskit.	98.00
41-42	Merc Sdn Cpe11A-45983-2DA, with slotted holeskit.	98.00
41-42	Merc 2D Sdn	11A-45983-2DB, w/threaded holeskit.	98.00
41-42	Merc 2D Sdn	11A-45983-2DA, w/slotted holeskit.	98.00
41-42	Merc 4D Sdn	11A-45983-5W/4DB, w/threaded holeskit.	98.00
41-42	Merc 4D Sdn	11A-45983-5W/4DA, w/slotted holeskit.	98.00
42-48	Merc Conv	21A-45983-Ckit.	65.00
46-48	Merc Cpe	21A-45983-2Dkit.	98.00
46-48	Merc Cpe	21A-45983-5W/4Dkit.	98.00
46-48	Merc 2D Sdn	21A-45983-2Dkit.	98.00
46-48	Merc 4D Sdn	21A-45983-5W/4Dkit.	98.00

Stainless Car Front Door Window Channel Kits

These kits have a stainless steel bead on the anti-rattlers and the u-channels. One kit does both front doors.

32	Cpe 3W	B-45983-3W-SSkit.	80.00
32	Cpe 5W	B-45983-5W/4D/2D-SSkit.	75.00
32	B-400	B-45983-V-SSkit.	75.00
32	Victoria	B-45983-V-SSkit.	75.00
32	Sdn 2D	B-45983-5W/4D/2D-SSkit.	75.00
32	Sdn 4D	B-45983-5W/4D/2D-SSkit.	75.00
33	Cpe 3W	18-45983-3W-SSkit.	85.00
33	Cpe 5W	18-45983-5W42-SSkit.	75.00
33	Sdn 4D	18-45983-5W42-SSkit.	75.00
34	Cpe 3W	40-45983-3W-SSkit.	100.00
34	Cpe 5W	40-45983-5WF-SS, with front mount handlekit.	100.00
34	Cpe 5W	40-45983-5WC-SS, with center mount handlekit.	105.00
34	Sdn 2D	40-45983-2DF-SS, with front mount handlekit.	100.00
34	Sdn 2D	40-45983-2DC-SS, with center mount handlekit.	105.00
34	Sdn 4D	40-45983-4DF-SS, with front mount handlekit.	100.00
34	Sdn 4D	40-45983-4DC-SS, with center mount handlekit.	105.00
35-36	Cpe 3W	48-45983-3WB-SSkit.	115.00
35-36	Cpe 5W	48-45983-5W4DBSSkit.	115.00
35-36	Sdn 2D	48-45983-2DC-SSkit.	115.00
35-36	Sdn 4D	48-45983-5W4DBSSkit.	115.00
37-39	Cpe	78-45983-5W4D-SS, except club coupekit.	115.00
37-38	Club Cpe	78-45983-2D-SSkit.	115.00
37-39	Sdn 2D	78-45983-2D-SSkit.	115.00
37-39	Sdn 4D	78-45983-5W4D-SSkit.	115.00
40	Cpe	01A-45983-5W4DSSkit.	105.00
40	Sdn 2D	01A-45983-2D-SSkit.	105.00
40	Sdn 4D	01A-45983-5W4DSSkit.	105.00
40	Conv	01A-45983-C-SSkit.	65.00
41-42	Cpe	11A-45983-5W4DSS, with short door, sloted holes in bracketkit.	105.00

41-42	Cpe	11A-45983-5W4BSS, with short door, threaded holes in bracket...kit.	105.00
41-42	Cpe	11A-45983-2DA-SS, with long door, slotted holes in bracketkit.	105.00
41-42	Cpe	11A-45983-2DB-SS, with long door, threaded holes in bracket...kit.	105.00
41-42	Sdn 2D	11A-45983-2DA-SS, with slotted holes in bracketkit.	105.00
41-42	Sdn 2D	11A-45983-2DB-SS, with threaded holes in bracketkit.	105.00
41-42	Sdn 4D	11A-45983-5W4DSS, with sloted holes in bracketkit.	105.00
41-42	Sdn 4D	11A-45983-5W4BSS, with threaded holes in bracketkit.	105.00
41	Conv	11A-45983-C-SSkit.	75.00
41-42	Merc Cpe	11A-45983-5W4DSS, with short door, sloted holes in bracketkit.	105.00
41-42	Merc Cpe	11A-45983-5W4BSS, with short door, threaded holes in bracket...kit.	105.00
41-42	Merc Cpe	11A-45983-2DA-SS, with long door, slotted holes in bracketkit.	105.00
41-42	Merc Cpe	11A-45983-2DB-SS, with long door, threaded holes in bracket...kit.	105.00
41-42	Merc 2D Sdn	11A-45983-2DA-SS, with slotted holes in bracketkit.	105.00
41-42	Merc 4D	11A-45983-5W4DSS, with sloted holes in bracketkit.	105.00
41-42	Merc 2D Sdn	11A-45983-2DB-SS, with threaded holes in bracketkit.	105.00
41-42	Merc 4D	11A-45983-5W4BSS, with threaded holes in bracketkit.	105.00
41	Merc Conv	11A-45983-C-SSkit.	75.00
32-34	PU	B-45983-PU-SSkit.	75.00
35-37	PU	50-45983-PUB-SSkit.	105.00
38-39	PU	81C-45983-PU-SSkit.	100.00
40-41	PU	01C-45983-PU-SSkit.	100.00
42-47	PU	21C-45983-PU-SSkit.	100.00

Rear Door Window Channel Kits

One kit does both rear doors.

32	Sdn 4D	B-56791kit.	77.00
33	Sdn 4D	18-56791kit.	77.00
34	Sdn 4D	40-56791-C, w/center handleskit.	80.00
34	Sdn 4D	40-56791-F, w/front handleskit.	80.00
35-36	Sdn 4D	48-56791-C, w/feltkit.	76.00
35-36	Sdn 4D	48-56791-F, w/bumperskit.	105.00
37-38	Sdn 4D	78-56791kit.	76.00
39-40	Sdn 4D	91A-56791kit.	76.00
41-42	Sdn 4D	11A-56791kit.	95.00
46-48	Sdn 4D	21A-56791kit.	95.00
49	Sdn 4D	8A-56791kit.	80.00
50	Sdn 4D	0A-56791kit.	80.00
50-51	Sdn 4D	1A-56791kit.	80.00
41-42	Merc 4D Sdn	11A-56791kit.	95.00
46-48	Merc 4D Sdn	21A-56791kit.	95.00

Stainless Rear Door Window Channel Kits

These kits have a stainless steel bead on the anti-rattlers and the u-channels. One kit does both rear doors.

32	Sdn 4D	B-56791-SSkit.	85.00
----	--------	----------------------	-------



33	Sdn 4D	18-56791-SS	kit.	85.00
34	Sdn 4D	40-56791-F-SS, with front handle.....	kit.	90.00
34	Sdn 4D	40-56791-C-SS, with center handle.....	kit.	90.00
35-36	Sdn 4D	48-56791-C-SS	kit.	85.00
37-38	Sdn 4D	78-56791-SS	kit.	85.00
39-40	Sdn 4D	91A-56791-SS.....	kit.	85.00
41-42	Sdn 4D	11A-56791-SS.....	kit.	105.00
41-42	Merc 4D	11A-56791-SS.....	kit.	105.00

Quarter Window Felt Kit

One kit does both quarter windows.

32	Victoria	B-56786-V	kit.	65.00
32-33	Sdn 2D	B-56786.....	kit.	65.00
34	Victoria	40-56786	kit.	75.00
34	Sdn 2D	40-56786	kit.	75.00
35-36	Sdn 2D	48-56786-B, w/felt	kit.	105.00
35-36	Sdn 2D	48-56786-F, w/bumpers.....	kit.	98.00
37	Sdn 2D	78-56786	kit.	98.00
38	Sdn 2D	78-56786, standard body	kit.	98.00
38	Dlx 2D Sdn	81A-56786	kit.	98.00
39-40	Sdn 2D	81A-56786	kit.	98.00
41-42	Sdn 2D	11A-56786	kit.	98.00
46-48	Sdn 2D	21A-56786	kit.	98.00
49	Sdn 2D	8A-56786	kit.	80.00
50	Sdn 2D	0A-56786	kit.	80.00
50-51	Sdn 2D	1A-56786, w/stainless.....	kit.	80.00
41-42	Merc 2D Sdn	11A-56786	kit.	98.00
46-48	Merc 2D Sdn	21A-56786	kit.	98.00



50-51	Wagon	0A-56786-WK, Late 50	kit.	300.00
-------	-------	----------------------------	------	--------

Stainless Quarter Window Felt Kit

These kits have a stainless steel bead on the anti-rattlers and the u-channels. One kit does both quarter windows.

32	Victoria	B-56786-V-SS	kit.	75.00
32-33	Sdn 2D	B-56786-SS.....	kit.	75.00
34	Sdn 2D	40-56786-SS	kit.	85.00
34	Victoria	40-56786-SS	kit.	85.00
35-36	Sdn 2D	48-56786-B-SS	kit.	115.00
37	Sdn 2D	78-56786-SS	kit.	105.00
38	Std 2D Sdn	78-56786-SS	kit.	105.00
38	Dlx 2D Sdn	81A-56786-SS.....	kit.	105.00
39-40	Sdn 2D	81A-56786-SS.....	kit.	105.00
41-42	Sdn 2D	11A-56786-SS.....	kit.	105.00
41-42	Merc 2D Sdn	11A-56786-SS, , for full window	kit.	105.00

Pick-up Door Window Channel Kits

Two kits are available for 1935-37 pick-up; rubber bumpers or one sided felt on the garnish molding and door. 1948-56 Pick-ups have stainless bead. All kits include mounting hardware. One kit will do both doors.



32-34	PU	B-45983-PU	kit.	64.00
35-37	PU	50-45983-PUA, w/bumpers.....	kit.	90.00
35-37	PU	50-45983-PUB, w/felt	kit.	98.00
38-39	PU	81C-45983-PU	kit.	90.00
38-40	C.O.E.	81W-45983	kit.	150.00
40-41	PU	01C-45983-PU	kit.	90.00
41-47	C.O.E.	11W-45983	kit.	150.00
42-47	PU	21C-45983-PU	kit.	90.00
48-52	PU	7C-8121460-CA, w/division bar	kit.	145.00
53-55	PU	BAAA-8121460-CA, w/division bar	kit.	170.00
56	PU	B6C-8121460-CA, w/division bar	kit.	160.00

Front Door Window Anti-Rattler Kits

One kit will do both front doors.

52-54	Sdn 2D	BA-21452/3-70A	kit.	79.95
52-54	Wgn	BA-21452/3-70A	kit.	79.95
55-56	Sdn 2D	B5A-21452/3-70A	kit.	69.95
55-56	Wgn	B5A-21452/3-70A	kit.	69.95
55-56	Sdn Dly	B5A-21452/3-70A	kit.	69.95

Front Door & Quarter Window Anti-Rattler Kits

One kit does both front doors and both quarter windows.

49-51	Conv	8A-21452/3-76K	kit.	99.95
51	Hardtop 2D	1A-21452/3-60K	kit.	105.00
52-54	Conv	BA-21452/3-76K	kit.	99.95
52-54	Hardtop 2D	BA-21452/3-76K	kit.	99.95
52-54	Cpe 2D	BA-21452/3-72K	kit.	99.95
52-54	Sdn 2D	BA-21452/3-70BK.....	kit.	109.95
55-56	Conv	B5A-21452/3-76K	kit.	89.95
55	Hardtop 2D	B5A-21452/3-60K	kit.	99.95

55-56	Sdn 2D	B5A-21452/3-70Kkit.	110.00
55-56	Crown Vic	B5A-21452/3-64Kkit.	139.95
56	Hardtop 2D	B6A-21452/3-60Kkit.	119.95
55-56	Merc 2D Hdtp	B5A-21452/3-60DKkit.	99.95

Front & Rear Door Window Anti-Rattler Kits

One kit does both front and rear doors.

52-54	Sdn 4D	BA-21452/3-73Kkit.	99.95
52-54	Wgn	BA-21452/3-73Kkit.	99.95
55-56	Sdn 4D	B5A-21452/3-73Kkit.	99.95
55-56	Wgn	B5A-21452/3-73Kkit.	99.95

Rear Quarter Window Anti-Rattlers

52-54	Hardtop 2D	BA-6029732-PR, 2 req'dpr.	15.00
55	Hardtop 2D	B5A-6029732-PR, RHpr.	25.00
55	Hardtop 2D	B5A-6029733-PR, LHpr.	25.00
55-56	Crown Vic	B5A-6429732-SET, 8 pcsset.	60.00
56	Hardtop 2D	B6A-6029732-PR, RHpr.	25.00
56	Hardtop 2D	B6A-6029733-PR, LHpr.	25.00

WINDOW CHANNEL PIECES

Complete Division Bar Assembly

Included in window channel kit.

48-52	PU	7C-8122296-CA, RHea.	41.00
48-52	PU	7C-8122297-CA, LHea.	41.00
53-55	PU	BAAA-8122296-CA, RHea.	47.00
53-55	PU	BAAA-8122297-CA, LHea.	47.00
56	PU	B6C-8122296-CA, RHea.	47.00
56	PU	B6C-8122297-CA, LHea.	47.00

Division Bar U-Channel Felt

46-48	Cpe/Sdn	51A-7022296-U, 96"ea.	40.00
46-48	Wagon	51A-7022296-U, 96"ea.	40.00

Division Bar Metal Channel

Must use old brackets

52-54	Sdn	BA-7022296-Uea.	14.00
55-56	Sdn	B5A-7022296-Uea.	14.00

Door Glass Anti-Rattler

55-56	Crown Vic	B5A-7621452-S, RHpr.	25.00
55-56	Crown Vic	B5A-7621453-S, LHpr.	25.00
55-56	Conv	B5A-7621452-S, RHpr.	25.00
55-56	Conv	B5A-7621453-S, LHpr.	25.00
55-56	Hardtop 2D	B5A-7621452-S, RHpr.	25.00
55-56	Hardtop 2D	B5A-7621453-S, LHpr.	25.00
40-41	PU	01C-8121452, 4 pcsset.	30.00
42-47	PU	21C-8121452, 4 pcsset.	30.00
48-52	PU	7C-8121452-53, 4 pcsset.	32.00
53-55	PU	BAAA-8121452-53pr.	20.00
56	PU	B6C-8121452/53pr.	20.00

Front Door Glass Run Lock Side

U-Channel that goes across the the top of the door glass and down the back side.

52	Cpe	BA-21550-70Uea.	36.95
52	Sdn Dly	BA-21550-70Uea.	36.95
52	Wagon 2D	BA-21550-70Uea.	36.95

52-53	Sdn 4D	BA-21550-73Uea.	36.95
52-53	Wagon 4D	BA-21550-73Uea.	36.95
53-54	Sdn 2D	BM-21550-70Uea.	39.95
53-54	Cpe	BM-21550-70Uea.	39.95
53-54	Sdn Dly	BM-21550-70Uea.	39.95
53-54	Wagon 2D	BM-21550-70Uea.	39.95
55-56	Sdn 2D	B5A-21550-70Uea.	36.95
55-56	Sdn 4D	B5A-21550-73Bea.	39.95
55-56	Wagon 2D	B5A-21550-70Uea.	36.95
55-56	Wagon 4D	B5A-21550-73Bea.	39.95
55-56	Sdn Dly	B5A-21550-70Uea.	36.95
40-47	PU	01C-8121555ea.	15.00
48-52	PU	7C-8121555ea.	15.00
53-55	PU	B4C-8121554ea.	35.00
56	PU	B6C-8121508-Aea.	27.50

Rear Door Glass Run Lock Side

U-Channel that goes across the the top of the door glass and down the back side.

52-53	Sdn 4D	BA-25760-73Uea.	33.00
52-53	Wagon 4D	BA-25760-73Uea.	33.00
55-56	Sdn 4D	B5A-25760-79Bea.	37.95
55-56	Wagon 4D	B5A-25760-79Bea.	37.95

Quarter Window U-Channel Felt

U-Channel that goes around the quarter glass.

53-54	Cpe	BA-30104/5-72Uea.	54.95
53-54	Sdn 2D	BA-30104/5-70Uea.	54.95
55-56	Sdn 2D	B5A-30104/5-70Uea.	54.95

Window Felt Fasteners

Each set contains 25 pieces, except where noted.

32-48	Pass	B-703536, screwsset.	4.00
35-39	Pass	48-703536-B, Z clipset.	5.50
35-40	Pass	48-703536-A, gator clipset.	11.00
37-48	Pass	78-703536, staplesset.	3.25
41-48	Pass	11A-703536, Y-Clipset.	5.50
49-56	Pass	STAPLESea.	.10
52-56	Pass	U-21452-EA, , anti-rattler clipea.	.50
52-56	Pass	U-21452-SET, , anti-rattler clip, 50 pcsbox.	15.00
32-48	PU	B-703536, screwsset.	4.00
35-40	PU	48-703536-A, gator clipset.	11.00

WINDOW FELT STRIPS

For those who like to make their own window felt kit, we offer the following strips. Sold in 8 foot lengths, oversize shipping required.

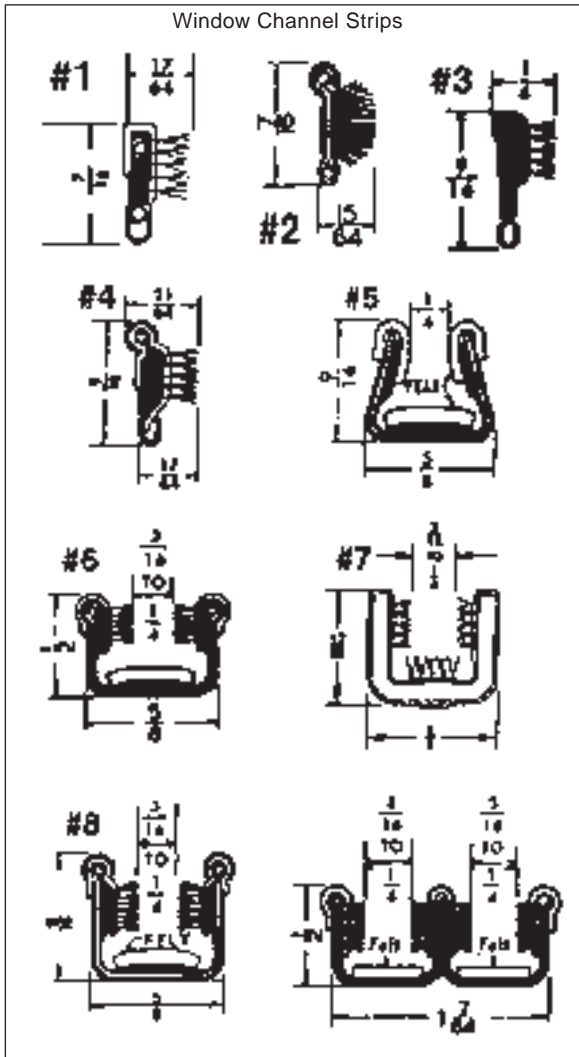

Window Channel Strips

*	All	45983#1, black bead.....ea.	28.00
*	All	45983#2, stainless bead.....ea.	23.00
*	All	45983#3, black bead.....ea.	33.00
*	All	45983#4, stainless bead.....ea.	31.00
*	All	45983#5, no bead.....ea.	42.00
*	All	45983#6, no bead.....ea.	38.00
*	All	45983#7, no bead.....ea.	36.00
*	All	45983#8, stainless bead.....ea.	44.00
*	All	45983DBL, double channel for sliding windows.....ea.	55.00

WINDOW REGULATOR/PARTS

Front Door Window Regulator Assembly

NOS regulators have surface rust and should be cleaned and lubricated before use.



32-33	Cpe	40-702700-A, RH.....ea.	75.00
32-33	Cpe	40-702701-A, LH.....ea.	75.00
32-33	Sdn	40-702700-A, RH.....ea.	75.00
32-33	Sdn	40-702701-A, LH.....ea.	75.00
34	Cpe	40-702700-B, RH.....ea.	75.00
34	Cpe	40-702701-B, LH.....ea.	75.00
34	Sdn	40-702700-B, RH.....ea.	75.00
34	Sdn	40-702701-B, LH.....ea.	75.00
37-38	Club Cpe	78-702700, RH, NOS.....ea.	125.00
37-38	Sdn 2D	78-702700, RH, NOS.....ea.	125.00
37-38	Sdn 4D	78-702700, RH, NOS.....ea.	125.00
40	Cpe	01A-7323200/1.....pr.	150.00
40	Cpe	01A-7323200, RH, NOS.....ea.	125.00
40	Sdn 2D	01A-7023200/1.....pr.	150.00
40	Sdn 4D	01A-7323200/1.....pr.	150.00
40	Sdn 4D	01A-7323200, RH, NOS.....ea.	125.00
40-41	Sdn Dly	01A-7323200, RH, NOS.....ea.	125.00
41-48	Cpe	11A-7323200-A, RH, NOS.....ea.	125.00
41-48	Sdn Cpe	11A-7023200, RH, NOS.....ea.	125.00
41-48	Sdn 2D	11A-7023200, RH, NOS.....ea.	125.00
41-48	Sdn 4D	11A-7323200-A, RH, NOS.....ea.	125.00
42-48	Sdn Dly	11A-7323200-A, RH, NOS.....ea.	125.00
28-34	PU	A-48105-A, RH.....ea.	37.00
28-34	PU	A-48106-A, LH.....ea.	37.00
35-37	PU	50-812700/1.....pr.	150.00
38-47	PU	81C-812700/1.....pr.	150.00
48-52	PU	7C-702700, RH.....ea.	79.00
48-52	PU	7C-702701, LH.....ea.	79.00
53-55	PU	BAAA-8123200-A, RH.....ea.	95.00
53-55	PU	BAAA-8123201-A, LH.....ea.	95.00
56	PU	B6C-8123200, RH.....ea.	80.00
56	PU	B6C-8123201, LH.....ea.	80.00

Rear Door Window Regulator Assembly

36	Sdn 4D	48-734300, NOS, RH.....ea.	100.00
41-48	Sdn 4D	11A-7327000-B, NOS, RH.....ea.	50.00

Window Regulator Mounting Kit

One kit will mount two regulators.

35-48	Pass	01A-7023200-HK, 32 pcs.....kit.	10.00
35-47	PU	01A-7023200-HK, 32 pcs.....kit.	10.00

Window Regulator Repair Kit



28-32	Pass	WRKA-48105-A, 5 teeth.....kit.	22.50
32-34	Pass	WRKB-48105, 10 teeth.....kit.	22.50
35-39	Pass	WRK-48105-C, , except conv and wagon.....kit.	22.50
40-48	Pass	WRK-48105-D, , except conv and wagon.....kit.	22.50

Window Regulator Handle Shaft

42-48	Wagon	21A-7923205-S, front or rear.....ea.	25.00
42-48	Merc Wgn	21A-7923205-S, front or rear.....ea.	25.00
53-55	PU	BAAA-8123205-S.....ea.	15.00



56-60	PU	B6C-8123205-S.....ea.	15.00
-------	----	-----------------------	-------

Window Regulator Spring



28-48	Pass	A-48105/6, except conv and wagon.....ea.	9.00
28-47	PU	A-48105/6.....ea.	9.00

GLASS CHANNEL

Front Door Glass Channel

Metal channel that holds the glass



32-33	Cpe 3W	18-45962, RH.....ea.	32.95
32-33	Cpe 3W	18-45963, LH.....ea.	32.95
32	Cpe 5W	B-45962, RH.....ea.	29.00
32	Cpe 5W	B-45963, LH.....ea.	29.00
32	Sdn 2D	B-55962, RH.....ea.	36.00
32	Sdn 2D	B-55963, LH.....ea.	36.00
32	Sdn 4D	B-45962, RH.....ea.	29.00
32	Sdn 4D	B-45963, LH.....ea.	29.00
33	Cpe 5W	40-45962-A, RH.....ea.	32.95
33	Cpe 5W	40-45963-A, LH.....ea.	32.95
33	Sdn 2D	40-55962-A, RH.....ea.	32.95
33	Sdn 2D	40-55963-A, LH.....ea.	32.95
33	Sdn 4D	40-45962-A, RH.....ea.	32.95

33	Sdn 4D	40-45963-A, LH.....ea.	32.95
34	Cpe 3W	40-55962-B, RH.....ea.	32.95
34	Cpe 3W	40-55963-B, LH.....ea.	32.95
34	Cpe 5W	40-45962-B, RH.....ea.	32.95
34	Cpe 5W	40-45963-B, LH.....ea.	32.95
34	Sdn 2D	40-55962-B, RH.....ea.	32.95
34	Sdn 2D	40-55963-B, LH.....ea.	32.95
34	Sdn 4D	40-45962-B, RH.....ea.	32.95
34	Sdn 4D	40-45963-B, LH.....ea.	32.95
35-36	Cpe	48-45962, RH.....ea.	32.95
35-36	Cpe	48-45963, LH.....ea.	32.95
35-36	Sdn 2D	48-55962, RH.....ea.	32.95
35-36	Sdn 2D	48-55963, LH.....ea.	32.95
35-36	Sdn 4D	48-45962, RH.....ea.	32.95
35-36	Sdn 4D	48-45963, LH.....ea.	32.95
37-39	Cpe	78-45962, RH.....ea.	32.95
37-39	Cpe	78-45963, LH.....ea.	32.95
37-39	Club Cpe	78-55962, RH.....ea.	32.95
37-39	Club Cpe	78-55963, LH.....ea.	32.95
37-39	Sdn 2D	78-55962, RH.....ea.	32.95
37-39	Sdn 2D	78-55963, LH.....ea.	32.95
37-39	Sdn 4D	78-45962, RH.....ea.	32.95
37-39	Sdn 4D	78-45963, LH.....ea.	32.95
40	Cpe	01A-45962, RH.....ea.	32.95
40	Cpe	01A-45963, LH.....ea.	32.95
40	Sdn 2D	01A-55962, RH.....ea.	32.95
40	Sdn 2D	01A-55963, LH.....ea.	32.95
40	Sdn 4D	01A-45962, RH.....ea.	32.95
40	Sdn 4D	01A-45963, LH.....ea.	32.95
41-48	Cpe	11A-55962, RH.....ea.	32.95
41-48	Cpe	11A-55963, LH.....ea.	32.95
41-48	Sdn 2D	11A-55962, RH.....ea.	32.95
41-48	Sdn 2D	11A-55963, LH.....ea.	32.95
41-48	Sdn 4D	11A-45962, RH.....ea.	32.95
41-48	Sdn 4D	11A-45963, LH.....ea.	32.95
41-48	Wgn	11A-7921462, RH.....ea.	35.00
41-48	Wgn	11A-7921463, LH.....ea.	35.00
49-51	Conv	8A-7621458-A, RH.....ea.	25.00
49-51	Conv	8A-7621459-A, LH.....ea.	25.00
49	Cpe	8A-7021458-A, RH.....ea.	25.00
49	Cpe	8A-7021459-A, LH.....ea.	25.00
49	Sdn 2D	8A-7021458-A, RH.....ea.	25.00
49	Sdn 2D	8A-7021459-A, LH.....ea.	25.00
49	Sdn 4D	8A-7321458-A, RH.....ea.	25.00
49	Sdn 4D	8A-7321459-A, LH.....ea.	25.00



50-51	Cpe	8A-7021458-B.....ea.	20.00
50-51	Sdn 2D	8A-7021458-B.....ea.	20.00
50-51	Sdn 4D	8A-7321458-B.....ea.	20.00
51	Hardtop 2D	8A-7621458-A, RH.....ea.	25.00
51	Hardtop 2D	8A-7621459-A, LH.....ea.	25.00
52-54	Conv	BA-7621458-C, RH.....ea.	35.00

Section 47 - Window



C&G Early Ford Parts, Inc.

52-54	Conv	BA-7621459-C, LH.....	ea.	35.00
52-54	Cpe	BA-7021458-A, RH.....	ea.	25.00
52-54	Cpe	BA-7021459-A, LH.....	ea.	25.00
52-54	Sdn 2D	BA-7021458-A, RH.....	ea.	25.00
52-54	Sdn 2D	BA-7021459-A, LH.....	ea.	25.00
52-54	Sdn 4D	BA-7321458-A, RH.....	ea.	25.00
52-54	Sdn 4D	BA-7321459-A, LH.....	ea.	25.00
52-54	Hardtop 2D	BA-7621458-C, RH.....	ea.	35.00
52-54	Hardtop 2D	BA-7621459-C, LH.....	ea.	35.00
52-54	Wagon 2D	BA-7021458-A, RH.....	ea.	25.00
52-54	Wagon 2D	BA-7021459-A, LH.....	ea.	25.00
52-54	Wagon 4D	BA-7321458-A, RH.....	ea.	25.00
52-54	Wagon 4D	BA-7321459-A, LH.....	ea.	25.00
55-56	Conv	B5A-6021458-B, RH.....	ea.	35.00
55-56	Conv	B5A-6021459-B, LH.....	ea.	35.00
55-56	Sdn 2D	B5A-7021458-B, RH.....	ea.	25.00
55-56	Sdn 2D	B5A-7021459-B, LH.....	ea.	25.00
55-56	Sdn 4D	B5A-7321458-B, RH.....	ea.	25.00
55-56	Sdn 4D	B5A-7321459-B, LH.....	ea.	25.00
55-56	Hardtop 2D	B5A-6021458-B, RH.....	ea.	35.00
55-56	Hardtop 2D	B5A-6021459-B, LH.....	ea.	35.00
55-56	Wagon 2D	B5A-7021458-B, RH.....	ea.	25.00
55-56	Wagon 2D	B5A-7021459-B, LH.....	ea.	25.00
55-56	Wagon 4D	B5A-7321458-B, RH.....	ea.	25.00
55-56	Wagon 4D	B5A-7321459-B, LH.....	ea.	25.00
41-48	Merc Cpe	11A-55962, RH.....	ea.	32.95
41-48	Merc Cpe	11A-55963, LH.....	ea.	32.95
41-48	Merc 2D Sdn	11A-55962, RH.....	ea.	32.95
41-48	Merc 2D Sdn	11A-55963, LH.....	ea.	32.95
41-48	Merc 4D Sdn	11A-45962, RH.....	ea.	32.95
41-48	Merc 4D Sdn	11A-45963, LH.....	ea.	32.95
41-48	Merc Wgn	11A-7921462, RH.....	ea.	35.00
41-48	Merc Wgn	11A-7921463, LH.....	ea.	35.00

Rear Door Glass Channel

Metal channel that holds the glass

32-34	Sdn 4D	B-56789, RH.....	ea.	32.95
32-34	Sdn 4D	B-56790, LH.....	ea.	32.95
35-36	Sdn 4D	48-56789, RH.....	ea.	32.95
35-36	Sdn 4D	48-56790, LH.....	ea.	32.95
37-40	Sdn 4D	78-56789, RH.....	ea.	32.95
37-40	Sdn 4D	78-56790, LH.....	ea.	32.95
41-48	Sdn 4D	11A-56789, RH.....	ea.	32.95
41-48	Sdn 4D	11A-56790, LH.....	ea.	32.95
49	Sdn 4D	8A-7326228-A, RH.....	ea.	20.00
49	Sdn 4D	8A-7326229-A, LH.....	ea.	20.00
50-51	Sdn 4D	8A-7326228-B.....	ea.	20.00
52-54	Sdn 4D	BA-7326228-A, RH.....	ea.	25.00
52-54	Sdn 4D	BA-7326229-A, LH.....	ea.	25.00
41-48	Merc 4D Sdn	11A-56789, RH.....	ea.	32.95
41-48	Merc 4D Sdn	11A-56790, LH.....	ea.	32.95

Quarter Window Glass Channel

Metal channel that holds the glass

32	Sdn 2D	B-56787-A, RH.....	ea.	32.95
32	Sdn 2D	B-56788-A, LH.....	ea.	32.95
33	Sdn 2D	B-56787-B, RH.....	ea.	32.95

33	Sdn 2D	B-56788-B, LH.....	ea.	32.95
34-40	Sdn 2D	40-56787, RH.....	ea.	32.95
34-40	Sdn 2D	40-56788, LH.....	ea.	32.95
41-48	Sdn 2D	11A-56786-C, RH.....	ea.	32.95
41-48	Sdn 2D	11A-56788, LH.....	ea.	32.95
49-51	Sdn 2D	8A-7029900-A, RH.....	ea.	20.00
49-51	Sdn 2D	8A-7029901-A, LH.....	ea.	20.00
52-54	Sdn 2D	BA-7029900-A, RH.....	ea.	25.00
52-54	Sdn 2D	BA-7029901-A, LH.....	ea.	25.00
55-56	Sdn 2D	B5A-7029900-A, RH.....	ea.	25.00
55-56	Sdn 2D	B5A-7029901-A, LH.....	ea.	25.00
41-48	Merc 2D Sdn	11A-56786-C, RH.....	ea.	32.95
41-48	Merc 2D Sdn	11A-56788, LH.....	ea.	32.95

Pick Up Door Glass Channel

Metal channel that holds the glass



32-34	PU	46-45962, RH.....	ea.	32.95
32-34	PU	46-45963, LH.....	ea.	32.95
35-37	PU	77-55962, RH.....	ea.	32.95
35-37	PU	77-55963, LH.....	ea.	32.95
38-47	PU	81C-55962, RH.....	ea.	36.00
38-47	PU	81C-55963, LH.....	ea.	36.00
48-52	PU	7C-8121462-A.....	ea.	20.00
53-55	PU	B5C-8121458-A.....	ea.	20.00
56	PU	B6C-8121458-A, RH.....	ea.	20.00
56	PU	B6C-8121459-A, LH.....	ea.	20.00

Window Channel Roller Stud

Must drill out, or grind end off of old one. New ones are a bolt on replacement.

34-39	Pass	78-702148-K, except conv and wagon.....	pr.	16.00
35-39	PU	78-702148-K.....	pr.	16.00

Door Glass Channel Roller



53-58	Pass	BA-7023240-A.....	ea.	4.50
53-58	Merc	BA-7023240-A.....	ea.	4.50
53-56	PU	BA-7023240-A.....	ea.	4.50

Convertible Window Roller Kit

Four complete roller assemblies, using hard plastic rollers to replace original steel type.



36-40	Conv	01A-6622218.....	kit.	80.00
-------	------	------------------	------	-------

39-40 Merc Conv 01A-6622218kit. 80.00

WINDOW GLASS SEALS

Glass Setting Tape

This is the material used between the glass and door glass channel, or between any glass and frame. To determine the right thickness you need, measure the width of your glass, then measure the width of the channel the glass fits in. Subtract the width of the glass from the width of the channel and divide that figure by two. All sizes are 1 1/2" wide x 20' long.

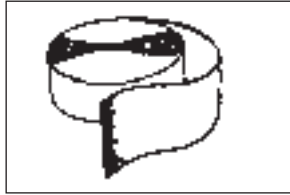

All	Pass & PU	B-37193-A, 1/32"roll.	7.50
All	Pass & PU	B-37193-B, 3/64"roll.	8.00
All	Pass & PU	B-37193-C, 1/16"roll.	10.00
All	Pass & PU	B-37193-D, 5/64"roll.	12.00

Door Glass to Body Seal

This seal fits in door glass channel and seals in between the door glass and door.

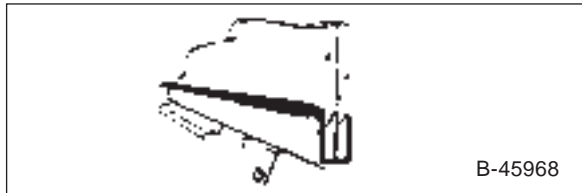

B-45968

28-38	Pass	B-45968, 6' rollea.	8.00
49-56	Pass	8A-7021478, 48"ea.	4.00
52-54	Conv	BA-7621478-C, 36"ea.	6.00
52-54	Hardtop 2D	BA-7621478-C, 36"ea.	6.00
52-54	Merc Conv	BA-7621478-C, 36"ea.	6.00
52-54	Merc 2D Hdtp	BA-7621478-C, 36"ea.	6.00
48-56	PU	8A-7021478, 48"ea.	4.00

Upper Door Glass to Body Seal

28-33	Cpe	A-45983ea.	15.00
28-33	Sdn	A-45983ea.	15.00

Conv Top to Door Glass Seal



32-39	Conv	18-45983ea.	15.00
32-39	Conv	18-45983-BD, "Drake" typeea.	15.00
32-39	Conv	18-45983-FG, 2-6' pieceskit.	25.00
40-48	Conv	01A-45983ea.	5.00
40-48	Conv	01A-45983-BD, "Drake" typeea.	15.00
39	Merc	18-45983ea.	15.00

39	Merc Conv	18-45983-BD, "Drake" typeea.	15.00
40-48	Merc Conv	01A-45983ea.	5.00
40-48	Merc Conv	01A-45983-BD, "Drake" typeea.	15.00

Flocked Conv Top to Door Window Seal

32-39	Conv	18-45983-FL, 30"ea.	11.00
40-51	Conv	01A-45983-F, 30"ea.	11.00
39	Merc	18-45983-FL, 30"ea.	11.00
40-51	Merc	01A-45983-F, 30"ea.	11.00

Conv Door Glass to Windshield Post Seal

35-39	Conv	68-740928/9pr.	35.00
40	Conv	01A-6602626/7pr.	30.00



41-48	Conv	11A-7602626, end only, need 01A-45983 to completepr.	8.00
49-50	Conv	8A-7602626-7pr.	45.00
51	Conv	0A-7602626-7pr.	30.00
51	Hardtop 2D	0A-7602626-7pr.	30.00
52-54	Conv	BA-7602626/27-Bpr.	34.50
55-56	Crown Vic	B5A-6002626-Apr.	9.00
55-56	Hardtop 2D	B5A-6002626-Apr.	9.00
41-48	Merc Conv	11A-7602626, end only, need 01A-45983 to completepr.	8.00

Windshield Post Seal Shim

49-51	Conv	0A-7602636-7pr.	15.00
51	Hardtop 2D	0A-7602636-7pr.	15.00

Roof Rail Seal



51	Hardtop 2D	1A-6051222-3Cpr.	120.00
52-54	Hardtop 2D	BF-6051222-PRpr.	220.00
55	Crown Vic	B5A-6451222-23-Dpr.	80.00
56	Crown Vic	B6A-6451676-77A, corner sealpr.	18.00
56	Hardtop 2D	B6A-6451676-77A, corner sealpr.	18.00
56	Hardtop 2D	B6A-6451678-79A, center sealpr.	18.00
52-54	Merc 2D Hdtp	BF-6051222-PRpr.	220.00
55-56	T-Bird	B6S-4020518-A, RHea.	110.00
55-56	T-Bird	B6S-4020519-A, LHea.	110.00



Door Window Glass to Frame Seal



35-50	Conv	48-762232ea.	10.00
39-50	Merc	48-762232ea.	10.00

Universal Window Glass Rubber Seal

Fits 1/4" glass.

All	Pass & PU	AV-4588, u-channel, fits 7/16" channelft.	1.25
All	Pass & PU	AV-4670, u-channel with lip, fits 1/2" channelft.	2.50

Upper Door Glass Back of Division Bar Bumper

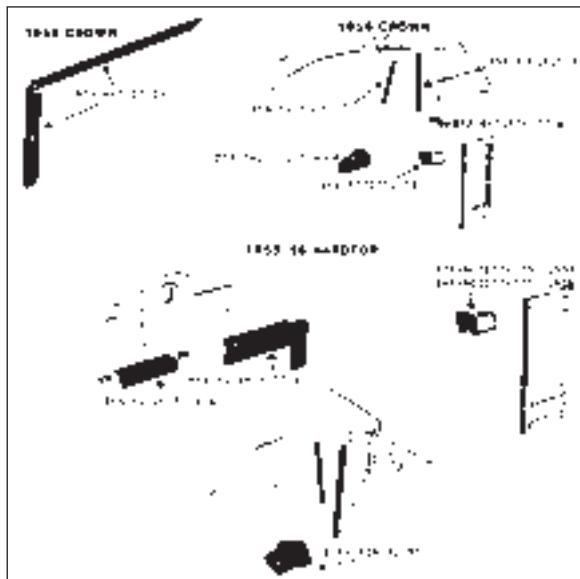

55-56	Conv	B5A-6021774/75pr.	14.00
55	Crown Vic	B5A-6021774/75pr.	14.00
55	Hardtop 2D	B5A-6021774/75pr.	14.00
56	Crown Vic	B6A-6021774-PRpr.	14.00

Rear of Door Glass to Body Bumper

55-56	Hardtop 2D	B5A-6420702/3Apr.	27.50
55-56	Crown Vic	B5A-6420702/3Apr.	27.50

Rear of Door Glass to Body Seal

56	Crown Vic	B6A-6428306-7, cloth coveredpr.	50.00
----	-----------	------------------------------	----------	-------

Door Window Flipper Spring

56	Hardtop 2D	BJ-6451659-A, coiled at both endsea.	7.00
56	Hardtop 2D	BJ-6451664-A, RH, coiled at one endea.	5.00
56	Hardtop 2D	BJ-6451665-A, LH, coiled at one endea.	5.00

Door Window Flipper Tab Cover

56	Hardtop 2D	BJ-6451662-A, 2 req'dea.	8.00
----	------------	-----------------------	----------	------

Section 48 Convertible

TOP IRONS

Universal Top Iron Kit

Perfect for the home builder. Will fit stock or chopped windshield frames. Kit is adjustable in three directions. Includes wood header, hardware and instructions. Top upholstery NOT included.

28-32	Roadster	SR-37500-KTkit.	495.00
-------	----------	-------------	-----------	--------

TOP SEALS

Conv Top Seal Kit

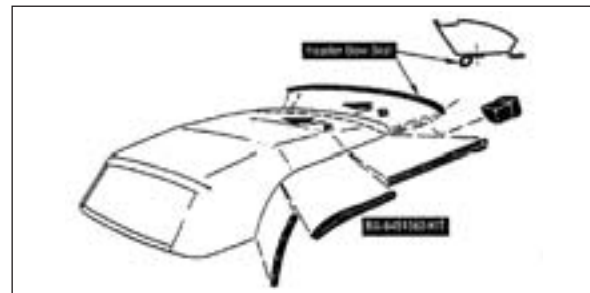

32-37	Cabriolet	18-45983-K, 5 piece kitkit.	65.00
38-39	Conv	18-45983-K, 5 piece kitkit.	65.00
40-48	Conv	01A-45983-K, 5 piece kitkit.	65.00
49	Conv	8A-6451562-KITset.	50.00
50	Conv	0A-6451562-KITkit.	100.00
51	Conv	1A-6451562-KITkit.	300.00
52-54	Conv	BA-6451562-KITkit.	350.00
55-56	Conv	B5A-6451562-KITkit.	325.00
40-48	Merc Conv	01A-45983-K, 5 piece kitkit.	65.00

Rubber Plugs for Convertible Top Irons

For the front joints.

49-50	Conv	8A-7650358-PRpr.	8.00
-------	------	---------------	----------	------

Conv Header Bow Seal

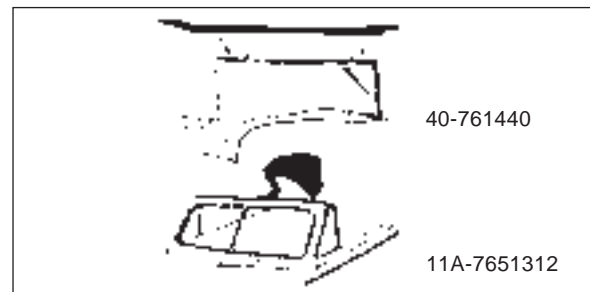

33-34	Cabriolet	40-761440ea.	20.00
35-36	Cabriolet	48-711302ea.	8.00
35-36	Conv Sdn	48-711302ea.	8.00
37-40	Conv	48-711302ea.	8.00
41-48	Conv	11A-7651312, on top of windshieldea.	8.00

41-48	Conv	11A-7651330, on bow	ea.	8.00
49-51	Conv	0A-7603476, on top of windshield.....	ea.	40.00
50-51	Conv	0A-7651338-PR, on bow	pr.	50.00
52-54	Conv	BA-7651338-B	ea.	11.00
55-56	Conv	B5A-7651338-A	ea.	8.50
41-48	Merc Conv	11A-7651312, on top of windshield.....	ea.	8.00
41-48	Merc Conv	11A-7651330, on bow	ea.	8.00
49-51	Merc Conv	8M-7603476-B, on top of windshield.....	ea.	20.00
50-51	Merc Conv	0M-7651338-PR, on bow	ea.	75.00

Top of Windshield Post Seal

55-56	Conv	B5A-7603198-PR.....	pr.	40.00
-------	------	---------------------	-----	-------

Conv Door Glass to Windshield Post Seal

35-39	Conv	68-740928/9	pr.	35.00
35-39	Conv Sdn	68-740928/9	pr.	35.00
40	Conv	01A-6602626/7	pr.	30.00
41-48	Conv	11A-7602626, end only, need 01A-45983 to complete	pr.	8.00
49-50	Conv	8A-7602626-7	pr.	45.00
51	Conv	0A-7602626-7	pr.	30.00
52-54	Conv	BA-7602626/27-B.....	pr.	34.50
55-56	Hardtop 2D	B5A-6002626-A.....	pr.	9.00
41-48	Merc Conv	11A-7602626, end only, need 01A-45983 to complete	pr.	8.00

Windshield Post Seal Shim

49-51	Conv	0A-7602636-7	pr.	15.00
51	Hardtop 2D	0A-7602636-7	pr.	15.00

Conv Top to Door Window Seal

Sold in 30" lengths except where noted.



32-39	Conv	18-45983	ea.	15.00
32-39	Conv	18-45983-BD, "Drake" type	ea.	15.00
32-39	Conv	18-45983-FG, 2-6' pieces.....	kit.	25.00
40-48	Conv	01A-45983	ea.	5.00
40-48	Conv	01A-45983-BD, "Drake" type	ea.	15.00
39	Merc	18-45983	ea.	15.00
39	Merc Conv	18-45983-BD, "Drake" type	ea.	15.00
40-48	Merc Conv	01A-45983	ea.	5.00
40-48	Merc Conv	01A-45983-BD, "Drake" type	ea.	15.00

Stainless Conv Top Seal Retainer

32-39	Conv	18-45983-SS, 30"	ea.	30.00
40-51	Conv	01A-45983-M, 36"	ea.	30.00
32-39	Merc	18-45983-SS, 30"	ea.	30.00
40-51	Merc	01A-45983-M, 36"	ea.	30.00

Adhesive Backed Felt

Goes on convertible top rubber

32-48	Conv	18-45983-F	roll.	15.00
-------	------	------------------	-------	-------

Door Window Glass to Frame Seal



35-50	Conv	48-762232	ea.	10.00
39-50	Merc	48-762232	ea.	10.00

Quarter Window Glass to Frame Seal



42-50	Conv	21A-762232	pr.	15.00
42-50	Merc	21A-762232	pr.	15.00

TOP PADS/HOLD DOWN

Top Latches and Brackets

Polished stainless steel, includes center and corner latches and brackets.



40	Conv	01A-6603463-K	kit.	600.00
----	------	---------------------	------	--------

Convertible Rear Window Straps

Includes strap, buckles, and tips.

40-48	Conv	01A-7653264	set.	27.00
40-48	Merc	01A-7653264	set.	27.00

Convertible Top Knob



40	Conv	01A-7650570-B	ea.	8.00
41	Conv	11A-7650570	ea.	8.00
42	Conv	21A-7650570-B	ea.	8.00
46	Conv	51A-7650570-C	ea.	8.00
47-48	Conv	6A-7650570	ea.	8.00

Conv Top Hold Down Screws

30-36	Roadster	B-37472	ea.	7.50
30-36	Phaeton	B-37472	ea.	7.50
35	Cabriolet	48-7650820	ea.	15.00
35	Conv Sdn	48-7650820	ea.	15.00
36	Cabriolet	68-7650820	ea.	15.00



36	Conv Sdn	68-7650820.....ea.	15.00
37-39	Cabriolet	78-7650820-A, on w/s header.....ea.	10.00
37-39	Cabriolet	78-7650820-C, top slat iron.....ea.	10.00
37-39	Conv Sdn	78-7650820-A, on w/s header.....ea.	10.00
37-39	Conv Sdn	78-7650820-B, center pillar.....ea.	10.00

Conv Top to Body Prop Nut

32	Roadster	B-37708-C, chrome.....ea.	6.00
32	Roadster	B-37708-SS, stainless.....ea.	7.50
32	Phaeton	B-37708-C, chrome.....ea.	6.00
32	Phaeton	B-37708-SS, stainless.....ea.	7.50

Conv Header Bow Bumpers

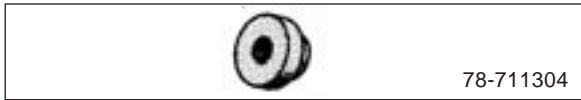

33-34	Cabriolet	40-761440-BK.....set.	10.00
37-40	Conv	78-711304.....set.	10.00

Conv Quarter to Top Bow Pad



36	Clb Cabrlet	68-763244/5.....pr.	85.00
35	Conv Sdn	48-7650548.....pr.	5.00
37-39	Conv	78-763244/5-B.....pr.	40.00



37-38	Conv Sdn	78-744858/9.....pr.	40.00
39	Conv Sdn	91A-744858/9.....pr.	40.00



40	Conv	01A-6628530/1.....pr.	40.00
40	Merc Conv	HD-300.....pr.	52.00

Conv Top Center Pillar Pads

35-38	Conv Sdn	48-743196/7, 4 pcs.....set.	50.00
39	Conv Sdn	91A-743196/7, 4 pcs.....set.	50.00
40	Merc Conv	09A-743196-SET.....set.	60.00

Conv Top Pad

Goes on conv top where top irons fold.

35-39	Conv Sdn	48-747162.....set.	12.00
-------	----------	--------------------	-------

Rear Conv Top Rest Pad

37-38	Conv Sdn	78-747048.....pr.	20.00
-------	----------	-------------------	-------

Conv Top Upper Corner Pad

36-39	Cabriolet	68-764860.....pr.	15.00
-------	-----------	-------------------	-------

Conv Top Arm Bumper

55-59	Conv	B5A-7629986-A.....pr.	11.00
-------	------	-----------------------	-------

Back of Quarter Window to Top of 1/4 Panel Pad

50-51	Conv	0A-7652752-PR.....pr.	25.00
-------	------	-----------------------	-------

TOP MOTOR PARTS

Conv Top Motor Grommets

42-48	Conv	21A-7653382.....set.	15.00
42-48	Merc	21A-7653382.....set.	15.00

Conv Top Vacuum "T"



40	Conv	01A-7650720.....pr.	10.00
40	Merc	01A-7650720.....pr.	10.00

Conv Top Iron Hardware

52-58	Conv	353014-S.....ea.	1.50
52-58	Conv	353014-SK, set of 22.....set.	22.00

SIDE CURTAIN

Side Curtain Body Socket Set



32-38	Roadster	A-81002.....set.	18.50
32-38	Phaeton	A-81002.....set.	18.50

Side Curtain Body Socket Installation Tool

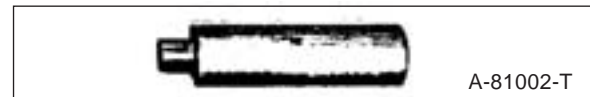

32-38	Roadster	A-81002-T.....ea.	2.50
32-38	Phaeton	A-81002-T.....ea.	2.50

Body Curtain Rod Socket



30-38	Roadster	A-180620.....ea.	25.00
30-38	Phaeton	A-180620.....ea.	25.00

Windshield Post Side Curtain Studs

28-35	Phaeton	1145.....set.	11.50
28-35	Roadster	1145.....set.	11.50

TOP DECK (ROOF) PARTS

Top Deck (Roof) Retainer Molding

Made of aluminum. Must be bent, comes in 70" lengths.

32	Cpe	B-705019, 2 req'dea.	24.95
32	Sdn	B-705019, 3 req'dea.	24.95
33-34	Cpe	40-705019, 2 req'dea.	24.95
33-34	Sdn	40-705019, 3 req'dea.	24.95

Top Deck (Roof) Retainer Rubber Seal

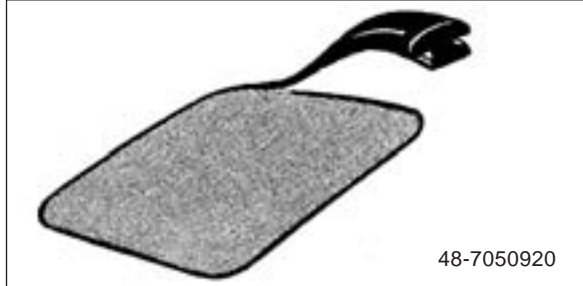

32-34	Cpe	B-7050920ea.	10.00
32-34	Sdn	B-7050920ea.	10.00
35-36	Cpe	48-7050920-Aea.	25.00
35-36	Sdn	48-7050920-Bea.	30.00
35-36	Sdn Dly	48-7050920-Cea.	40.00

**Section 49
Headliner**

HEADLINER

Vinyl Headliner

Special order, takes 7-10 days. Cloth like original NOT available.

49-54	Pass	B7A-6350202-CL, call with body typeea.	160.00
-------	------	--	----------	--------

Cardboard Headliner Kits

Kits include headliner, cab corners, strip below rear window, kick panels, & hardware.



*40-47	PU	01C-8151968-BL, blackkit.	175.00
--------	----	-----------------------	-----------	--------

*48-52	PU	7C-8151968-BL, blackkit.	175.00
*48-52	PU	7C-8151968-BR, brownkit.	175.00
*48-52	PU	7C-8151968-GR, graykit.	175.00

Cardboard Headliner

Seal and clips sold separately.

*53-55	PU	B5C-8151968, grayea.	90.00
*56	PU	B6C-8151968, grayea.	90.00
*56	PU	B6C-8251968-BW, gray, big windowea.	120.00
*53-55	Panel	B5C-8251968-Pea.	120.00
*56	Panel	B6C-8251968-Pea.	120.00

Headliner Seal

53-56	PU	BAAA-8150956ea.	18.50
-------	----	--------------	----------	-------

Headliner Seal Clips

53-56	PU	BAAA-8150960-S, 16 pcs.set.	7.00
-------	----	----------------------------	-----------	------

Fiberglass Headliner

The headliners are textured fiberglass molded to shape. No holes are drilled. There is a crating charge, plus oversize shipping.

Please allow 3-6 weeks for delivery.

*32-34	PU	B-8151968, includes header cover & cab cornerskit.	275.00
*35-36	PU	50-8151968ea.	175.00
*37	PU	77-8151968ea.	175.00
*38-39	PU	81C-8151968ea.	175.00
*40-47	PU	01C-8151968ea.	175.00

Fiberglass Cab Corners & Strip Below Rear Window

*35-39	PU	50-8151968-Aset.	85.00
*40-47	PU	01C-8151968-Aset.	120.00

ABS Plastic Headliner Kit

The headliners are textured and molded to shape. The corners and lower window strip are included. No holes are drilled. Please allow 2-3 weeks for delivery.

*35-36	PU	FORD-3536-THpr.	235.00
--------	----	--------------	----------	--------

Coat Hooks



53-63	Pass	B2A-7029025-A, chrome with screwspr.	9.95
-------	------	--------------------------------------	----------	------

GLASS TOP

Glass Top Rubber Seal

54	Pass	B4A-6450080-Aea.	100.00
55-56	Pass	B5A-6450080-Bea.	100.00
55-56	Merc	BU-6450080-Aea.	110.00



Section 50 Quarter Window

QUARTER SEALS

Swing-Out Quarter Window Seals

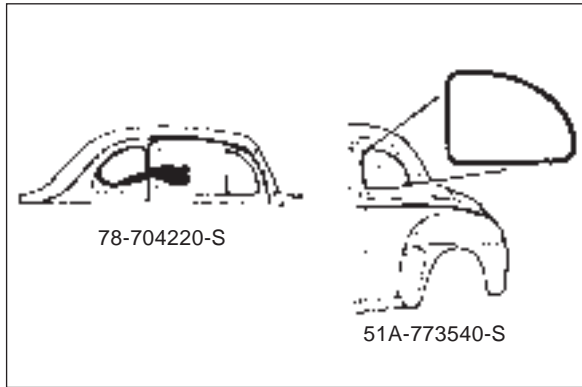

36	Sdn 4D	68-735130/1-B	pr.	160.00
37	Club Cpe	WR-3317-R	pr.	143.00
37	Hmpbk 4D	WR-3316-R	pr.	150.00
38-40	Sdn 4D	WR-3320-R	pr.	100.00
41-48	Cpe	51A-773540-S	pr.	85.00
41-48	Sdn 4D	51A-773540-S	pr.	85.00
49-51	Club Cpe	0A-7229904-PR	pr.	120.00
49-51	Sdn 2D	WR-3300-R	pr.	120.00
49-51	Sdn 4D	8A-7326894-PR	pr.	100.00
41-48	Merc Cpe	51A-773540-S	pr.	85.00
41-48	Merc 4D	51A-773540-S	pr.	85.00
49	Merc 4D	WR-3302-R	pr.	129.00
49-51	Merc 2D	WR-3305-R	pr.	166.00
50-51	Merc 4D	WR-3311-R	pr.	136.00

Quarter Window Division Bar Seal

49-51	Sdn 2D	8A-7030238-PR	pr.	20.00
-------	--------	---------------	-----	-------

Stationary Quarter Window Seals

32	Cpe 5W	B-704220-S	pr.	16.00
33-34	Cpe 5W	40-704220-S	pr.	15.00
35-36	Cpe 5W	48-704220-S	pr.	15.00
37-40	Cpe	78-704220-S	pr.	30.00
41	Cpe	B-7042084, cut to fit	ea.	15.00
49-51	Bus Cpe	8A-7229905-PR	pr.	40.00
49-51	Sdn 2D	0A-7030248-PR	pr.	50.00
52-54	Cpe	BA-7229904-PR	pr.	60.00
49-51	Merc 2D	VQT-3300	pr.	165.00

Stationary Quarter Window Conversion Seal

Converts original swing out windows to stationary windows. Kit includes 12' rubber for both quarter windows. This is the rubber seal only.

35-40	Sdn 4D	78-735130	kit.	45.00
37-38	Club Cpe	78-735130	kit.	45.00
41-48	Bus Cpe	78-735130	kit.	45.00
41-48	Sdn Cpe	78-735130	kit.	45.00

Front Edge of Quarter Window Seal



42-49	Conv	21A-7630106/7	pr.	45.00
50	Conv	0A-7630106-7	pr.	40.00
51	Conv	1A-7630106-7	pr.	40.00
51	Hardtop 2D	1A-7630106-7	pr.	40.00
52-56	Conv	BA-7630146-S	pr.	25.00
52-56	Conv	BA-7630146-SNC, no cloth	pr.	12.00
52-56	Hardtop 2D	BA-7630146-S	pr.	25.00
52-56	Hardtop 2D	BA-7630146-SNC, no cloth	pr.	12.00
42-48	Merc Conv	21A-7630106/7	pr.	45.00

Front of Quarter Window Pad

51	Conv	1A-7629132-33	pr.	15.00
51	Hardtop 2D	1A-7629132-33	pr.	15.00
52-54	Conv	BA-7629746/7	pr.	22.00
52-54	Hardtop 2D	BA-7629746/7	pr.	22.00
55-56	Conv	B5A-7629132/33	pr.	20.00
55-56	Hardtop 2D	B5A-7629132/33	pr.	20.00

Quarter Window Glass to Frame Seal



42-50	Conv	21A-762232	pr.	15.00
42-50	Merc	21A-762232	pr.	15.00

Door & Quarter Window Glass to Wood Seal



49-51	Merc Wgn	8M-7920902	kit.	30.00
49-51	Wagon	8M-7920902	kit.	30.00

Universal Glass Seal

Fits 1/4" glass.

All	Pass & PU	AV-4588, u-channel, fits 7/16" channel	ft.	1.25
All	Pass & PU	AV-4670, u-channel with lip, fits 1/2" channel	ft.	2.50

FELT KITS

Quarter Window Felt Kit

The following felt kits are exact replacements of originals. Each kit contains enough parts for two quarter windows. All kits come with necessary hardware to install. Stainless steel bead is available. To order add "-SS" to the end of the part number. These are a special order, and may take 1-2 weeks. The additional cost is \$10.00.

32	Victoria	B-56786-Vkit.	65.00
32-33	Sdn 2D	B-56786kit.	65.00
34	Victoria	40-56786kit.	75.00
34	Sdn 2D	40-56786kit.	75.00
35-36	Sdn 2D	48-56786-B, w/feltkit.	105.00
35-36	Sdn 2D	48-56786-F, w/bumperskit.	98.00
37	Sdn 2D	78-56786kit.	98.00
38	Sdn 2D	78-56786, standard bodykit.	98.00
38	Dlx 2D Sdn	81A-56786kit.	98.00
39-40	Sdn 2D	81A-56786kit.	98.00
41-42	Sdn 2D	11A-56786kit.	98.00
46-48	Sdn 2D	21A-56786kit.	98.00
49	Sdn 2D	8A-56786kit.	80.00
50	Sdn 2D	0A-56786kit.	80.00
50-51	Sdn 2D	1A-56786, w/stainlesskit.	80.00

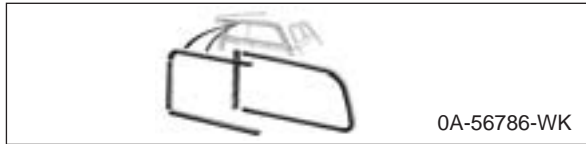

50-51	Wagon	0A-56786-WK, Late 50kit.	300.00
41-42	Merc 2D Sdn	11A-56786kit.	98.00
46-48	Merc 2D Sdn	21A-56786kit.	98.00

Sliding Quarter Window Glass Bumper Stop

Mounts in slide channel at rear.

50-51	Wagon	357385-Spr.	10.00
50-51	Merc Wgn	357385-Spr.	10.00

Rear Quarter Window Anti-Rattlers

52-54	Hardtop 2D	BA-6029732-PR, 2 req'dpr.	15.00
55	Hardtop 2D	B5A-6029732-PR, RHpr.	25.00
55	Hardtop 2D	B5A-6029733-PR, LHpr.	25.00
55-56	Crown Vic	B5A-6429732-SET, 8 pcsset.	60.00
56	Hardtop 2D	B6A-6029732-PR, RHpr.	25.00
56	Hardtop 2D	B6A-6029733-PR, LHpr.	25.00

Quarter Window U-Channel Felt

53-54	Cpe	BA-30104/5-72Uea.	54.95
53-54	Sdn 2D	BA-30104/5-70Uea.	54.95
55-56	Sdn 2D	B5A-30104/5-70Uea.	54.95

GLASS CHANNELS

Quarter Window Glass Channel

Metal channel that holds the glass

32	Sdn 2D	B-56787-A, RHea.	32.95
32	Sdn 2D	B-56788-A, LHea.	32.95
33	Sdn 2D	B-56787-B, RHea.	32.95

33	Sdn 2D	B-56788-B, LHea.	32.95
34-40	Sdn 2D	40-56787, RHea.	32.95
34-40	Sdn 2D	40-56788, LHea.	32.95
41-48	Sdn 2D	11A-56786-C, RHea.	32.95
41-48	Sdn 2D	11A-56788, LHea.	32.95
49-51	Sdn 2D	8A-702990-A, RHea.	20.00
49-51	Sdn 2D	8A-702990-A, LHea.	20.00
52-54	Sdn 2D	BA-702990-A, RHea.	25.00
52-54	Sdn 2D	BA-702990-A, LHea.	25.00
55-56	Sdn 2D	B5A-702990-A, RHea.	25.00
55-56	Sdn 2D	B5A-702990-A, LHea.	25.00
41-48	Merc 2D Sdn	11A-56786-C, RHea.	32.95
41-48	Merc 2D Sdn	11A-56788, LHea.	32.95

Quarter Window Regulator

35-36	Pass	40-702700-B, RHea.	75.00
35-36	Pass	40-702701-B, LHea.	75.00
37	Sdn 2D	78-703600-A, RH, NOSea.	125.00
37	Sdn 2D	78-703601-A, LH, NOSea.	125.00

HANDLES

Quarter Window Roll Back Handle



33-34	Sdn 4D	40-724470ea.	12.00
-------	--------	-----------	----------	-------

Swing Out Quarter Window Handle



37-38	Club Cpe	78-7022916, RHea.	30.00
37-38	Club Cpe	78-7022917, LHea.	30.00
37-48	Sdn 4D	78-7022916, RHea.	30.00
37-48	Sdn 4D	78-7022917, LHea.	30.00



49	Sdn 4D	01A-7022916/7pr.	55.00
50-51	Club Cpe	8M-7022916, RHea.	30.00
50-51	Club Cpe	8M-7022917, LHea.	30.00
50-51	Sdn 2D	8M-7022916, RHea.	30.00
50-51	Sdn 2D	8M-7022917, LHea.	30.00



50-51	Sdn 4D	8M-7022916, RHea.	30.00
50-51	Sdn 4D	8M-7022917, LHea.	30.00
49-51	Merc 4D	8M-7022916, RHea.	30.00

Section 51 - Rear Window



C&G Early Ford Parts, Inc.

49-51 Merc 4D 8M-7022917, LH.....ea. 30.00

Quarter Window Handle Kit



41-48 Conv 11A-7923410-DK, chromekit. 50.00
 42 Conv 21A-7923410-BK, butterscotchkit. 50.00
 46-48 Conv 51A-7923410-CK, gray tankit. 50.00

Quarter Window Handle



41-48 Conv 51A-7923410-CC, chrome knobea. 15.00
 41 Conv 11A-7923410, tan knobea. 15.00
 42 Conv 21A-7923410-A, maroon knob ...ea. 15.00
 42 Conv 21A-7923410-B, butterscotch knobea. 15.00
 46 Conv 51A-7923410-A, chocolate knobea. 15.00
 46 Conv 51A-7923410-B, blue-gray knobea. 15.00
 46-48 Conv 51A-7923410-C, gray-tan knobea. 15.00
 51-56 Conv 1A-7630322ea. 30.00
 51-56 Hardtop 2D 1A-7630322ea. 30.00

Quarter Window Handle Escutcheon

52-59 Hardtop 2D BAAA-8122618, stainless with rubber.....ea. 7.50
 52-59 Conv BAAA-8122618, stainless with rubber.....ea. 7.50
 52-59 Merc 2D Hdtp BAAA-8122618, stainless with rubber.....ea. 7.50
 52-59 Merc Conv BAAA-8122618, stainless with rubber.....ea. 7.50

Stainless Sliding Quarter Window Handles



38-48 Wagon 81A-793775-EAea. 25.00
 38-48 Wagon 81A-793775-A, 4 pcs.set. 80.00



49-51 Wagon 7A-7929754-Apr. 40.00
 41-48 Merc Wgn 81A-793775-EAea. 25.00

41-48 Merc Wgn 81A-793775-A, 4 pcs.set. 80.00

49-51 Merc Wgn 7A-7929754-Apr. 40.00

Sliding Quarter Window Handle Locks



46-48 Wagon 81A-793796, 4 pcs.....set. 200.00



49-50 Wagon 7A-7929670, early 50, rear, 2 req.....ea. 40.00



49-51 Wagon 7A-7929668, front, 2 req.....ea. 40.00
 46-48 Merc Wgn 81A-793796, 4 pcs.....set. 200.00
 49-50 Merc Wgn 7A-7929670, early 50, rear, 2 req.....ea. 40.00
 49-51 Merc Wgn 7A-7929668, front, 2 req.....ea. 40.00

Section 51 Rear Window

GLASS

Please specify clear or green tint, and body style. Wrap around rear window bubbled & tempered like original. These are drop shipped directly from our manufacturer.

Back Window Glass

32-40 Pass 789-BACKGLASS-Aea. 95.00
 41-48 Pass 11A-7042016-A2, except wagon and convea. 285.00
 41-48 Merc 11A-7042016-A2, except wagon and convea. 285.00
 32-56 PU 789-BACKGLASS-A, flat glass..ea. 95.00
 *56 PU B6C-8142006-CL, clear, with wrap around rear window....ea. 215.00
 *56 PU B6C-8142006-TN, tinted with wrap around rear window....ea. 315.00

SEALS

For body style number see Section 39, Windshield. With or without trim is specified for a vehicle with or without groove for trim. The rear window trim is not included.

Rear Window Rubber Seal

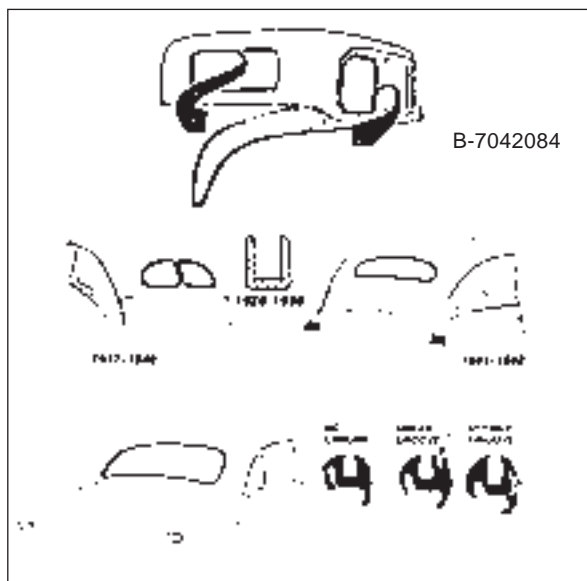

32-36	Cpe	B-7042084	ea.	15.00
32-36	Sdn	B-7042084	ea.	15.00
37-40	Cpe	78-7042084	pr.	25.00
37	Sdn	78-7042084	pr.	25.00
38	Std 2D Sdn	78-7042084	pr.	25.00
38	Dlx 2D Sdn	81A-7042084	pr.	25.00
39-40	Sdn	81A-7042084	pr.	25.00
40-41	Sdn Dly	01A-7842084	ea.	40.00
41-48	Cpe	11A-7042084, w/o chrome	ea.	30.00
41-48	Cpe	19A-7042084, w/chrome	ea.	30.00
41-48	Sdn	11A-7042084, w/o chrome	ea.	30.00
41-48	Sdn	19A-7042084, w/chrome	ea.	30.00
42-48	Sdn Dly	21A-7842084	ea.	40.00
49-51	Pass	8A-7042084, w/o chrome	ea.	60.00
49-51	Pass	8A-7042084-D, w/single groove	ea.	60.00
49-51	Pass	0A-7042084, w/double groove	ea.	60.00
51	Hardtop 2D	1A-6042084	ea.	140.00
52-54	Pass	BA-7042084-E, body #70A, 72C, 73A, w/o trim	ea.	70.00
52-54	Pass	BA-7042084-F, body #70B, 72B, 73B, w/trim	ea.	70.00
52	Hardtop 2D	BA-6042084-E	set.	160.00
54	Pass	BA-7042084-F, body #73C, w/trim	ea.	70.00
54	Wgn	BA-7942084-B, #59B, with trim	ea.	70.00
54	Skyliner	BF-6042084-A	ea.	80.00
52-54	Wgn	BA-5942084-B, #59, no trim	ea.	60.00

52-54	Wgn	BA-7942084-B, #79, with trim	ea.	70.00
52-54	Sdn Dly	BA-5942084-B, #78, no trim	ea.	60.00
53-54	Hardtop 2D	BF-6042084-A	ea.	80.00
55-56	Pass	B5A-7042084-D, body #70B, 70C, 73B, 73C, w/trim	ea.	80.00
55-56	Pass	B5A-7042084-E, body #70A, 70D, 73A, w/o trim	ea.	80.00
55	Hardtop 2D	B5A-7042084-D, #60	ea.	80.00
55	Crown Vic	B5A-6442084-C	ea.	90.00
55-56	Pass	B5A-5942084-C, body #59, 59A, 78, 79	ea.	80.00
56	Pass	B5A-7042084-D, body #70A, 70D, 73A, 57A, w/trim	ea.	80.00
56	Pass	B6A-6442084-H, body #64A, 64B, 64C, 64D	ea.	90.00
55-56	Pass	B5A-5942084-D, body #59B, 59C, 79, w/trim	ea.	80.00
56	Wagon	B5A-5942084-D, body #59A, w/trim	ea.	80.00
39-40	Merc Cpe	78-7042084	pr.	25.00
39-40	Merc Sdn	81A-7042084	pr.	25.00
41-48	Merc	11A-7042084, w/o chrome	ea.	30.00
41-48	Merc	19A-7042084, w/chrome	ea.	30.00
49-50	Merc	8M-7242084-B, for 1 pc. window	ea.	65.00
51	Merc	1M-7042084, w/lock strip	ea.	87.50
52	Merc Wgn	BA-7942084-B, #79D, with trim	ea.	70.00
52-54	Merc	BA-7042084-F, body #70B, 73B, 73C, w/trim	ea.	70.00
52-54	Merc Wgn	BA-7942084-B, #79B, with trim	ea.	70.00
53-54	Merc Cpe	BU-6042084-B, body #60G, 60E, 60F	ea.	80.00
55	Merc	B5A-7042084-D, body #60B, 60E, 70B, 73B, 73C, w/trim	ea.	80.00
55	Merc Cpe	B5A-6442084-C, body #64A, 64B	ea.	90.00
55-56	Merc Wgn	B5A-5942084-D, body #79, w/trim	ea.	80.00
56	Merc Sdn	B5A-7042084-D, body #70 & 73, w/trim	ea.	80.00
56	Merc	B6A-6442084-H, body #64A	ea.	90.00
55-57	T-Bird	B5S-4042084-A	ea.	47.50
32-39	PU	B-7042084	ea.	15.00
38-39	Panel	81T-7942084	ea.	40.00
38-47	C.O.E.	50-813370	ea.	25.00
40-47	Panel	01C-7842084	pr.	40.00
40-47	PU	01C-7042084	ea.	45.00
48-50	PU	7C-8142084-A	ea.	30.00
48-52	Panel	7C-8242084-P	ea.	60.00
51-52	PU	1C-8142084	ea.	30.00
53-56	PU	BAAA-8142084	ea.	30.00
53-56	Panel	BAAA-8242084-P	pr.	60.00



56	PU	B6C-8142084-A, w/wrap around windowea.	40.00
56	PU	B6C-8142084-NC, wrap around, w/o chromeea.	40.00

ROLL DOWN PARTS

Rear Window Bumpers

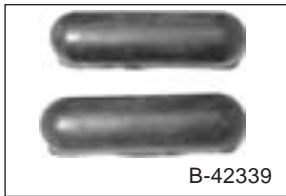

32	Roadster	B-42339.....pr.	15.00
----	----------	-----------------	-------

Roll Down Rear Window Felt Kit

30-34	Cpe	A-46108kit.	36.00
35-36	Cpe	48-46108kit.	52.00

Roll Down Rear Window Handle



33-34	Cpe	40-724470.....ea.	12.00
-------	-----	-------------------	-------

Roll Down Rear Window Regulator

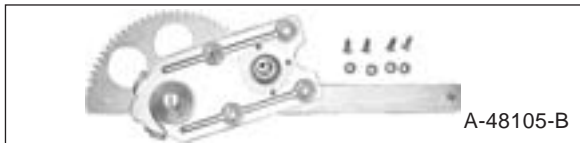

30-36	Cpe	A-48105-B.....ea.	39.00
-------	-----	-------------------	-------

Roll Down Rear Window Glass Channel



30-36	Pass	A-47106.....ea.	11.00
-------	------	-----------------	-------

Roll Down Rear Window Pad

35-36	Cpe	48-7042080.....ea.	1.00
-------	-----	--------------------	------

SLIDING REAR WINDOW

Sliding Rear Window Kit

Rare factory option usually seen on bigger trucks. A nice addition to any pick up. Kit includes garnish molding, glass pattern, glass channels, special cam lock knob, and instructions. Glass is NOT included.

35-39	PU	50-813396-K.....kit.	175.00
38-47	C.O.E.	50-813396-K.....kit.	175.00

CUSTOM CAB PANELS

Custom Cab Panel Behind Seat

*53-55	PU	BAAA-8142414.....pr.	60.00
--------	----	----------------------	-------

**Section 52
Trunk**

SEALS/BUMPERS

Trunk Lid Seal

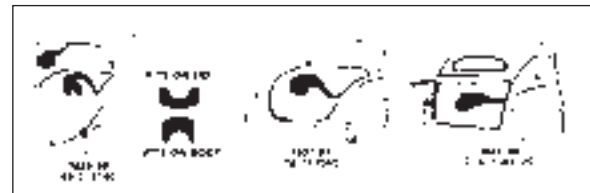

32-34	Roadster	40-713540.....ea.	25.00
32-34	Cabriolet	40-713540.....ea.	25.00
32-34	Cpe	40-713540.....ea.	25.00
35-36	Roadster	48-713540.....ea.	25.00
35-36	Cabriolet	48-713540.....ea.	25.00
35-36	Cpe	48-713540.....ea.	25.00
35-36	Hmpbk 4D	48-706860.....ea.	25.00
37-40	Pass	78-7043720.....ea.	25.00
37-40	Pass	78-713540, hollow.....ea.	30.00
37-40	Pass	78-713540-VI, hollow, mfg by Vintique.....ea.	27.50
41-48	Conv	78-7043720.....ea.	25.00
41-48	Conv	78-713540, hollow, mfg by Drake.....ea.	30.00
41-48	Conv	78-713540-VI, hollow, mfg by Vintique.....ea.	27.50
41-48	Cpe	78-7043720.....ea.	25.00
41-48	Cpe	78-713540, hollow, mfg by Drake.....ea.	30.00
41-48	Cpe	78-713540-VI, hollow, mfg by Vintique.....ea.	27.50
41-48	Sdn	21A-7043720.....ea.	50.00
46-48	Sportsman	51A-7143720.....ea.	30.00
46-48	Sportsman	51A-7143720.....ea.	30.00
49-51	Pass	8A-7043720.....ea.	25.00



52-59	Pass	BA-7043720.....ea.	17.50
37-40	Merc	78-7043720.....ea.	25.00
37-40	Merc	78-713540, hollow, mfg by Drake.....ea.	30.00

39-40	Merc	78-713540-VI, hollow, mfg by Vintique	ea.	27.50
41-48	Merc Conv	78-7043720	ea.	25.00
41-48	Merc Conv	78-713540, hollow, mfg by Drake	ea.	30.00
41-48	Merc Conv	78-713540-VI, hollow, mfg by Vintique	ea.	27.50
41-48	Merc Cpe	78-7043720	ea.	25.00
41-48	Merc Cpe	78-713540, hollow, mfg by Drake	ea.	30.00
41-48	Merc Cpe	78-713540-VI, hollow, mfg by Vintique	ea.	27.50
41-48	Merc Sdn	21A-7043720	ea.	50.00
49-51	Merc	8M-7043720	ea.	25.00
52-59	Merc	BA-7043720	ea.	17.50

Hollow Trunk Lid Seal with Bonded Corners

38	Dlx 2D Sdn	81A-713540	ea.	50.00
38	Dlx 4D Sdn	81A-713540	ea.	50.00
39	Dlx Cpe	91A-7243720	ea.	50.00
39	Sdn	81A-713540	ea.	50.00
40	Conv	01A-7643720	ea.	50.00
40	Cpe	91A-7243720	ea.	50.00
40	Sdn	81A-713540	ea.	50.00
41-48	Conv	11A-7243720	ea.	50.00
41-48	Cpe	11A-7243720	ea.	50.00
41-48	Merc Conv	11A-7243720	ea.	50.00
41-48	Merc Cpe	11A-7243720	ea.	50.00

Black Weatherstrip Adhesive

Cannot be shipped air or overseas.



All	Pass & PU	3M-8011	ea.	12.00
-----	-----------	---------------	-----	-------

Trunk Lid Seal Clip Kit

Clips help secure the seal in the corners.



41-48	Conv	11A-7244817-HK, 8pcs.	kit.	6.00
41-48	Cpe	11A-7244817-HK, 8pcs.	kit.	6.00
41-48	Merc Conv	11A-7244817-HK, 8pcs.	kit.	6.00
41-48	Merc Cpe	11A-7244817-HK, 8pcs.	kit.	6.00

Trunk Lid Lip Seal on Body

49-51	Pass	8A-7043734	ea.	10.00
-------	------	------------------	-----	-------

Trunk Lid Bumpers



28-34	Pass	B-41518	pr.	4.00
40	Conv	01A-7243800	pr.	4.00
40	Cpe	01A-7243800	pr.	4.00
41-48	Conv	11A-7243800	pr.	5.00
41-48	Cpe	11A-7243800	pr.	5.00



52-54	Pass	BD-16754-A	pr.	12.00
41-48	Merc Conv	11A-7243800	pr.	5.00
41-48	Merc Cpe	11A-7243800	pr.	5.00

License Plate to Trunk Lid Bumper

49-51	Pass	8A-8167-A	ea.	2.00
-------	------	-----------------	-----	------

Trunk Drain Hose

35-36	Cpe	48-725854	pr.	6.00
-------	-----	-----------------	-----	------

HINGES

Trunk Hinge

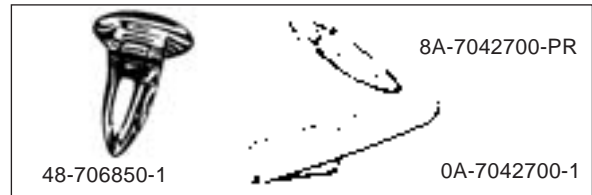

32	Roadster	B-41512-S	set.	16.00
----	----------	-----------------	------	-------

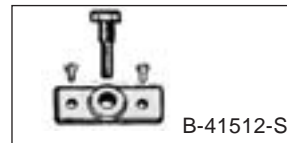

32	Cpe 5W	B-41512-S	set.	16.00
33-34	Roadster	40-713570-AK	pr.	135.00
33-34	Roadster	40-713570-AS, stainless	pr.	200.00
33-34	Cabriolet	40-713570-AK	pr.	135.00
33-34	Cabriolet	40-713570-AS, stainless	pr.	200.00



33-34	Cpe	40-713570-AK	pr.	135.00
33-34	Cpe	40-713570-AS, stainless	pr.	200.00
35-36	Cpe	48-713570-AS	pr.	200.00
35-36	Hmpbk 4D	48-706850/1	pr.	95.00
37	Fltbc Sdn	78-706850/51-A	pr.	150.00



37	Hmpbk 4D	78-706850/51-Bpr.	150.00
39-40	Cpe	91A-7742700pr.	150.00
40	Conv	01A-6642700pr.	150.00
41-48	Cpe	21A-7642700pr.	150.00
41-48	Conv	21A-7642700pr.	150.00
49	Pass	8A-7042700-PRpr.	120.00
50	Pass	0A-7042700/1pr.	100.00
41-48	Merc Cpe	21A-7642700pr.	150.00
41-48	Merc Conv	21A-7642700pr.	150.00

Trunk Hinge Pads

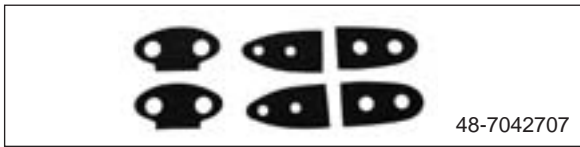

35-36	Hmpbk 4D	48-7042707, 6 pcs.set.	6.00
37	Fltbck Sdn	78-7042707-Bpr.	6.00
37	Hmpbk 4D	78-7042707-Apr.	6.00
37-38	Phaeton	78-7442707-Cpr.	6.00
37-38	Conv Sdn	78-7442707-Cpr.	6.00
49	Pass	8A-7042707-Aset.	6.00
50	Pass	0A-7042707-Bset.	6.00

Trunk Lid Hinge Locks



35-36	Hmpbk 4D	48-706902set.	200.00
-------	----------	-----------	-----------	--------

SUPPORTS

Trunk Support Arm



32	Roadster	A-41530ea.	19.95
32	Cabriolet	A-41530ea.	19.95
32	Cpe	A-41530ea.	19.95

Stainless Trunk Support Arm

Polished stainless with pivot hardware.

32	Cpe	B-41530-Skit.	57.00
32	Roadster	B-41530-Skit.	57.00
33-34	Cpe	40-714030-Sset.	57.00
33-34	Roadster	40-714030-Sset.	57.00
35-36	Cpe	48-714030-Sset.	57.00

35-36	Roadster	48-714030-Sset.	57.00
-------	----------	-------------	-----------	-------

Trunk Lid Supports



39-40	Cpe	91A-7744200/1pr.	145.00
40	Conv	91A-7744200/1pr.	145.00
41-48	Conv	11A-7744200/1pr.	145.00
41-48	Cpe	11A-7744200/1pr.	145.00
41-48	Sdn	99A-7044200/1pr.	145.00
39-40	Merc Sdn	99A-7044200/1pr.	145.00
41-48	Merc Conv	11A-7744200/1pr.	145.00
41-48	Merc Cpe	11A-7744200/1pr.	145.00
41-48	Merc Sdn	99A-7044200/1pr.	145.00

HANDLES

Trunk Lid Handle



32-34	Roadster	40-702352ea.	40.00
32-34	Cabriolet	40-702352ea.	40.00
32-34	Cpe	40-702352ea.	40.00
35-36	Roadster	48-702352-Bea.	37.00
35-36	Cabriolet	48-702352-Bea.	37.00
35-36	Cpe	48-702352-Bea.	37.00
37	Pass	78-702352ea.	40.00
41-48	Pass	11A-7043511ea.	75.00



50	Pass	0A-7043539-B, exc. wgn lock cylinder not includedea.	100.00
----	------	---	----------	--------



51	Pass	1A-7043530-B, exc. wgn lock cylinder not includedea.	175.00
----	------	---	----------	--------

Trunk Handle & Base Assembly

Includes handle, base, and license light.



40 Pass 01A-7043500-Kkit. 200.00



41-48 Pass 51A-7043511-Kkit. 200.00

Remote Trunk Release Handle



32 Cpe 3W 40-725900ea. 18.00
 33-34 Cpe 40-725900ea. 18.00
 33-34 Cabriolet 40-725900ea. 18.00

HANDLE PARTS

Trunk Lid Handle Nut

32-37 Pass 3104, w/washerea. 1.00

Trunk Handle Base Extension Nuts



38-39 Pass 81A-13567, 2 req'dea. 5.50
 40 Pass 01A-13567ea. 5.50

Trunk Handle Base Hardware Kit

40 Pass 99A-13553-H, 2 studskit. 4.00
 40 Pass 99A-13553-HK, 2 studs & extension nutkit. 10.00

Trunk Handle Base



40 Pass 99A-13553ea. 26.00
 41-48 Pass 11A-13550ea. 30.00
 51 Pass 1A-7043500-OR, N.O.S.ea. 25.00
 39 Merc 99A-13553ea. 26.00

Trunk Handle Inner Base



40 Pass 01A-13553ea. 9.50
 39 Merc 01A-13553ea. 9.50

Trunk Handle Mounting Set

Includes license light socket & pigtail, glass lens, lens gaskets, & hardware.



40-48 Pass 01A-13556-Skit. 22.00
 39 Merc 01A-13556-Skit. 22.00

Trunk Handle Base Lens

40-48 Pass 99A-13564ea. 7.00
 39-48 Merc 99A-13564ea. 7.00

Trunk Handle Base Lens Gaskets

38-39 Pass 81A-13568ea. 1.50
 40 Pass 01A-13568/9set. 2.00



41-48 Pass 11A-13568/9set. 2.00
 39-40 Merc 01A-13568/9set. 2.00
 41-48 Merc 11A-13568/9set. 2.00

Trunk Base to Handle Pad



38-39 Pass 81A-13573ea. .50

Trunk Handle Shaft Seal

40 Pass 01A-13557ea. 1.00

Trunk Handle Key Hole Cover & Hardware

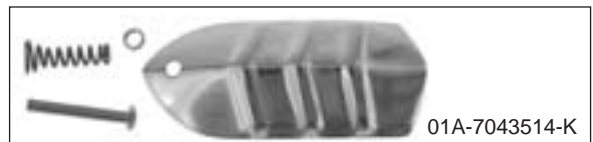

40 Pass 01A-7043514-Kkit. 15.00

Trunk Lid Handle Pad

32-37 Pass B-7043531ea. 4.00
 38-39 Pass 81A-13572-Bea. 15.00



40 Pass 99A-13572ea. 5.00



41-48 Pass 11A-13572ea. 6.00



42 Super Dlx 21A-13572kit. 20.00

49 Pass 8A-7043531ea. 8.00

50 Pass 0A-7043531pr. 8.00

51 Pass 1A-7043531ea. 12.00



52 Pass BA-7043531-Dea. 10.00

53 Pass BF-7043531-Aea. 10.00

54 Pass BM-7043531-Aea. 10.00

55 Mainline B5A-7043531-Aea. 10.00

55 Customline B5A-7043531-Aea. 10.00

39 Merc 99A-13572ea. 5.00

40 Merc 09A-13572ea. 20.00

41 Merc 19A-13572ea. 15.00



42-48 Merc 29A-13572ea. 15.00

49 Merc 8M-7043531ea. 27.00



50 Merc 0M-7043531ea. 18.00

LATCHES

Trunk Lid Latch



32 Roadster A-41604-A, mfg by Drakeea. 30.00

32 Cpe 3W A-52502, mfg by Vintique.....ea. 13.00

32 Cpe 3W A-41604-B, mfg by Drake.....ea. 30.00

32 Cpe 5W A-41604-A, mfg by Drakeea. 30.00

32-34	Roadster	A-52502, mfg by Vintique.....ea.	13.00
33-34	Roadster	A-41604-B, mfg by Drake.....ea.	30.00
33-34	Cpe	A-52502, mfg by Vintique.....ea.	13.00
33-34	Cpe	A-41604-B, mfg by Drake.....ea.	30.00
35-36	Pass	48-52502ea.	33.00
37	Pass	78-52502ea.	33.00
38-39	Sdn	81A-52502-Bea.	33.00
39-40	Cpe	91A-7043200-A.....ea.	33.00
40	Conv	91A-7043200-A.....ea.	33.00
40	Sdn	01A-52502-Bea.	33.00
41-48	Sdn	11A-52502ea.	33.00
42-48	Cpe	21A-52502ea.	33.00
42-48	Conv	21A-52502ea.	33.00

STRIKER PLATES

Trunk Lid Striker Plates



32 Cpe 5W B-41615ea. 8.50

32 Roadster B-41615ea. 8.50

41 Pass 11A-52500ea. 13.50

42-48 Sdn 11A-52500ea. 13.50

49 Pass 8A-7043252, N.O.S.ea. 22.00

Stainless Trunk Lid Striker Plates

Polished stainless with mounting screws.

35-36	Cpe	48-713780-Bkit.	35.00
36	Clb Cabrlet	48-713780-Bkit.	35.00
37-38	Phaeton	78-725680kit.	35.00
37-38	Conv Sdn	78-725680kit.	35.00
37-38	Clb Cabrlet	78-725680kit.	35.00
37-38	Cpe	78-725680kit.	35.00
37-39	Sdn 2D	78-706990-Akit.	35.00
37-39	Sdn 4D	78-706990-Akit.	35.00
39	Conv Sdn	78-706990-Akit.	35.00
39-40	Cpe	01A-52500-A.....ea.	35.00
40	Conv	01A-52500-A.....ea.	35.00
40	Sdn 2D	01A-7043252kit.	35.00
40	Sdn 4D	01A-7043252kit.	35.00
41-48	Conv	11A-7243252kit.	35.00
41-48	Cpe	11A-7243252kit.	35.00
41-48	Sdn 2D	11A-7043252kit.	35.00
41-48	Sdn 4D	11A-7043252kit.	35.00
46-48	Sportsman	11A-7243252kit.	35.00
41-48	Merc Conv	11A-7243252kit.	35.00
41-48	Merc Cpe	11A-7243252kit.	35.00
41-48	Merc 2D Sdn	11A-7043252kit.	35.00
41-48	Merc 4D Sdn	11A-7043252kit.	35.00

Trunk Lid Striker Plate Support

Mounts between trunk floor and under deck panel.



39	Dlx Cpe	91A-7744820ea.	50.00
40	Cpe	91A-7744820ea.	50.00
40	Conv	91A-7744820ea.	50.00
39-40	Sdn 2D	01A-7044806ea.	50.00
39-40	Sdn 4D	01A-7044806ea.	50.00

LOCKS

Trunk Lid Lock Cylinder



49	Pass	8A-7006081-PR, NOS, w/glove boxset.	35.00
52-59	Pass	B9A-6443505-Aea.	28.50

Trunk Lid Lock Housing & Cover



55-56	Pass	B5A-7043603-B, except wagonea.	50.00
-------	------	--------------------------------	----------	-------

Trunk Lid Lock Housing Cover

55-56	T-Bird	B5A-7043516-70Aea.	15.00
-------	--------	-----------------	----------	-------

Trunk Lid Lock Housing Pad



55-57	Frln	B5A-7043625-Bea.	3.50
55-56	T-Bird	B5S-4043625-ARea.	4.50
57	T-Bird	B7S-4043625-BRea.	3.50

TRUNK LIGHT

Trunk Handle Inner Base and Light Socket

Wiring and hardware are NOT included.



40	Pass	01A-13556-BDea.	20.00
39	Merc	01A-13556-BDea.	20.00

Accessory Interior Trunk Light Switch

This replaces original mercury switch. For use with your original light housing.

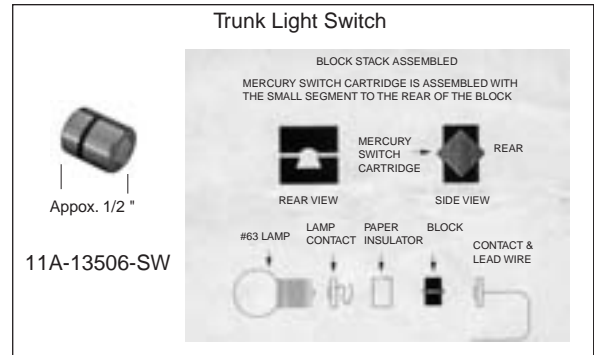

41-48	Pass	11A-13506-SWea.	40.00
-------	------	--------------	----------	-------

WOOD TOOL BOARDS

Trunk Tool Boards

37	Fltbck Sdn	78-7046106-BSpr.	28.00
37-38	Hmpbk 4D	78-7046106-CSpr.	25.00

TRUNK MAT

Trunk Mat

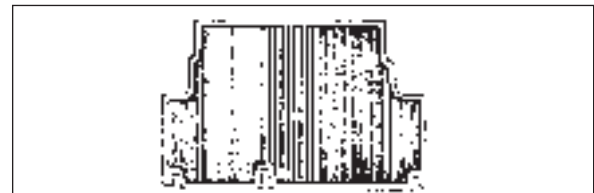

*39-40	Cpe	A-2532ea.	137.00
*39-40	Sdn	A-2533ea.	137.00
*40	Conv	A-2532ea.	137.00
*41-48	Conv	A-2536ea.	137.00
*41-48	Cpe	A-2537ea.	137.00
*41-48	Sdn	A-2538ea.	137.00
*46-48	Sportsman	A-2534ea.	136.95
*49-50	Conv	A-2540ea.	137.00
*49-50	Cpe	A-2540ea.	137.00
*49-50	Sdn	A-2539ea.	137.00
*51	Pass	A-2543, exc.2Dr Hrdtopea.	115.00
*52-54	Pass	A-2544ea.	116.00
55-56	Pass	B5A-7045455, plaidea.	90.00
*41-48	Merc Cpe	A-2537ea.	137.00
*41-48	Merc Conv	A-2536ea.	137.00
*41-48	Merc Sdn	A-2538ea.	137.00
55-56	T-Bird	B6S-7045455ea.	67.95

SIDE PANELS

Trunk Side Board Panels

*53-54	Pass	BM-7045415/6pr.	25.00
--------	------	--------------	----------	-------

Section 53 - Spare Tire



C&G Early Ford Parts, Inc.

*55	Pass	B5A-7045415/6.....pr.	25.00
*56	Pass	B6A-7045415/6.....pr.	25.00

Trunk Front Cardboard Panel

*55-56	Hardtop 2D	B5A-6445444-D.....ea.	55.00
*55-56	Crown Vic	B5A-6445444-D.....ea.	55.00
*55-56	Sdn	B5A-7045444-C.....ea.	70.00

INSULATION

See Section 1 for foil backed insulation

Waffle Pattern Body Insulation Sheeting

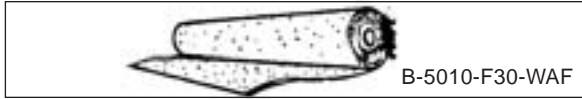

All	Pass & PU	B-5010-F30-WAFLE, 3'x8'x3/32".....ea.	100.00
All	Pass & PU	B-5010-F31-WAFLE, 3'x8'x1/8".....ea.	110.00

Section 53 Spare Tire

SPARE TIRE

Stainless Spare Tire Cover Trim w/Hardware

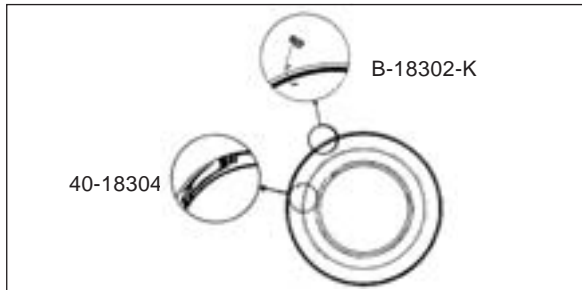

33-34	Pass	40-18304.....ea.	99.50
35-36	Pass	48-18304.....ea.	99.50

Spare Tire Cover Seal

32-36	Pass	B-18302-K.....ea.	8.00
32-51	Wagon	B-18302-K.....ea.	8.00
41-51	Merc Wgn	B-18302-K.....ea.	8.00

Spare Tire Lock Ring Seal



36	Pass	68-1351.....ea.	10.00
----	------	-----------------	-------

Spare Tire Mount Pad



33-34	Pass	40-1379-P.....ea.	17.50
-------	------	-------------------	-------

Spare Tire Lock Cylinder

N.O.S. limited to stock on hand.



36-37	Pass	68-18309-A.....ea.	25.00
-------	------	--------------------	-------

Spare Tire Mount Stud

N.O.S. limited to stock on hand.

32-34	Pass	B-1447.....ea.	5.00
32-35	PU	B-1447.....ea.	5.00

Spare Tire Hold Down Bracket



37-38	Pass	78-1492.....ea.	60.00
39	Conv Sdn	78-1492.....ea.	60.00



42-48	Conv	21A-1492.....ea.	60.00
37-38	PU	78-1492.....ea.	60.00

Spare Tire Hold Down Clamp



55-56	Pass	B5A-1446-A, exc. wagon & Sdn Dly.....ea.	16.00
-------	------	---	-------

Spare Tire Hold Down Wing Nut



52-58	Pass	BA-1457-A, exc. sdn dly, wgn.....ea.	16.00
55-58	T-Bird	BA-1457-A.....ea.	16.00

Spare Tire Hold Down Anti-Rattler



BA-1458-S

52-54 Pass BA-1458-S.....ea. 1.00

**Section 54
Rumble**

SEALS

Rumble Seat Lid Seal

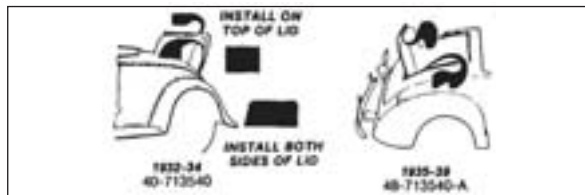

32-34	Roadster	40-713540.....ea.	25.00
32-34	Cabriolet	40-713540.....ea.	25.00
32-34	Cpe	40-713540.....ea.	25.00
35-36	Cpe	48-713540-A.....set.	25.00
35-37	Roadster	48-713540-A.....set.	25.00
35-39	Cabriolet	48-713540-A.....set.	25.00

HINGES

Rumble Seat Hinge Kits



48-41543-S

32	Roadster	B-41543-S.....kit.	63.00
32	Cpe 5W	B-41543-S.....kit.	63.00
33-34	Roadster	40-41543-S.....kit.	63.00
33-34	Cabriolet	40-41543-S.....kit.	63.00
33-34	Cpe	40-41543-S.....kit.	63.00
35-36	Roadster	48-41543-S.....kit.	63.00
35-36	Cabriolet	48-41543-S.....kit.	63.00
35-36	Cpe	48-41543-S.....kit.	63.00

Rumble Seat Hinge to Rumble Lid Screws

28-32	Roadster	A-41544-SK.....set.	2.00
28-32	Cabriolet	A-41544-SK.....set.	2.00
28-32	Cpe	A-41544-SK.....set.	2.00

Rumble Seat Hinge Spacer



B-526898

33-34	Roadster	B-526898.....pr.	13.00
33-34	Cabriolet	B-526898.....pr.	13.00
33-34	Cpe	B-526898.....pr.	13.00

LATCH

Rumble Seat Latch Assembly

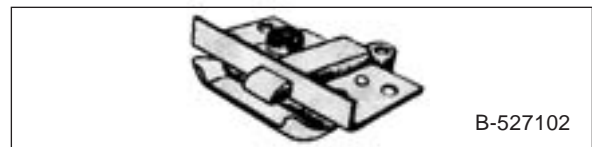

B-527102

32-34	Roadster	A-52502, mfg by Vintique.....ea.	13.00
32-34	Roadster	A-41604-B, mfg by Drake.....ea.	30.00
32	Cpe 3W	B-527102.....ea.	26.00
32	Cpe 5W	A-41604-B, mfg by Drake.....ea.	30.00
33-34	Cpe	A-52502, mfg by Vintique.....ea.	13.00
33-34	Cabriolet	B-527102.....ea.	26.00
39	Conv	B-527102.....ea.	26.00

HANDLE

Rumble Seat Lid Handle



40-702352

32-34	Roadster	40-702352.....ea.	40.00
32-34	Cabriolet	40-702352.....ea.	40.00
32-34	Cpe	40-702352.....ea.	40.00



48-702352-B

35-36	Roadster	48-702352-B.....ea.	37.00
35-36	Cabriolet	48-702352-B.....ea.	37.00
35-36	Cpe	48-702352-B.....ea.	37.00

Rumble Seat Lid Handle Pad



B-7043531

32-36 Pass B-7043531.....ea. 4.00



LATCH BRACKET

Rumble Seat Latch Mounting Bracket

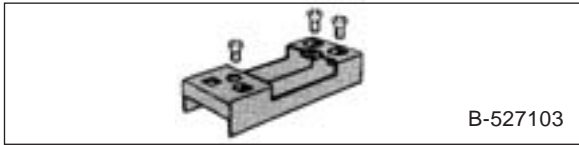

33-34	Roadster	B-527103ea.	13.00
33-34	Cabriolet	B-527103ea.	13.00
33-34	Cpe	B-527103ea.	13.00

GRAB HANDLES

Stainless Rumble Seat Grab Handles



28-32	Roadster	B-41500-SSpr.	45.00
28-32	Cpe	B-41500-SSpr.	45.00

STRIKERS

Rumble Seat Latch Striker Plate



28-32	Pass	A-52500-S, exc. 3W coupeea.	4.00
-------	------	-----------------------------	----------	------



32	Cpe 3W	B-765680ea.	11.00
----	--------	----------	----------	-------

STEP PADS

Rumble Seat Step Pad



32	Pass	B-41563, 2 req'd, 5" diameterea.	20.00
33-34	Pass	B-41563, 1 req'd, 5" diameterea.	20.00
33-34	Pass	B-2454, 1 req'dea.	35.00
35-36	Pass	40-2454ea.	8.50
37-39	Pass	78-2454ea.	8.50

Rumble Seat Step Reinforcing Bracket



33-34	Cpe	40-41564-Bea.	7.00
33-34	Roadster	40-41564-Bea.	7.00

REMOTE

Rumble Seat Remote Control Handle



32	Cpe 3W	40-725900ea.	18.00
33-34	Cpe	40-725900ea.	18.00
33-34	Cabriolet	40-725900ea.	18.00

Remote Handle Escutcheon



32	Cpe 3W	40-48139-ACea.	3.75
33-34	Cpe	40-48139-ACea.	3.75
33-34	Cabriolet	40-48139-ACea.	3.75

Rumble Seat Remote Control Rod

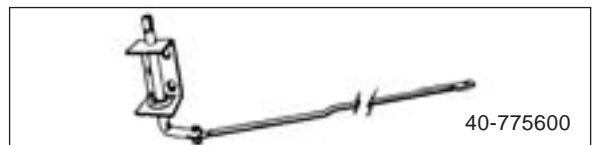

33-34	Cpe	40-775600ea.	26.00
-------	-----	-----------	----------	-------

Rumble Seat Remote Trip Lever

33-34	Cpe	B-526814pr.	14.00
33-34	Cabriolet	B-526814pr.	14.00

Rumble Seat Remote Trip Spring

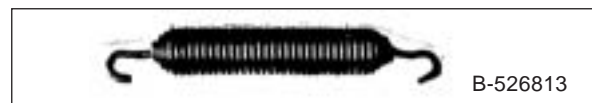

32	Cpe 3W	B-526813pr.	13.00
33-34	Cpe	B-526813pr.	13.00
33-34	Cabriolet	B-526813pr.	13.00

Rumble Seat Counter Balance Brackets



33-34	Cpe	B-526812.....pr.	20.00
33-34	Roadster	B-526812.....pr.	20.00

SEAT PARTS

Rumble Seat Retaining Section

Holds rear of seat spring to floor.

33-34	Roadster	40-41000-B.....ea.	33.00
33-34	Cabriolet	40-41000-B.....ea.	33.00
33-34	Cpe	40-41000-B.....ea.	33.00

Lower Rumble Seat Back Rest Clip



33-34	Roadster	40-41550-L.....pr.	16.00
33-34	Cabriolet	40-41550-L.....pr.	16.00
33-34	Cpe	40-41550-L.....pr.	16.00



35-36	Cpe	40-714200-Sset.	12.50
35-37	Roadster	40-714200-Sset.	12.50
35-39	Cabriolet	40-714200-Sset.	12.50

Upper Rumble Seat Back Rest Clip

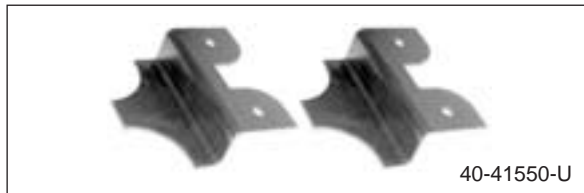

32-34	Roadster	40-41550-Upr.	16.00
32-34	Cabriolet	40-41550-Upr.	16.00
32-34	Cpe	40-41550-Upr.	16.00

Rumble Seat Lid Bumper



28-34	Roadster	B-41518.....pr.	4.00
28-34	Cabriolet	B-41518.....pr.	4.00
28-34	Cpe	B-41518.....pr.	4.00

Rumble Seat Lid Bumper Bracket



32-34	Roadster	B-41519.....pr.	16.00
32-34	Cabriolet	B-41519.....pr.	16.00
32-34	Cpe	B-41519.....pr.	16.00

Rumble Seat Lid Stop Brackets with Bumpers



32	Pass	B-714008-S, exc. 3W coupeset.	16.00
32	Cpe 3W	40-714008-Sset.	16.00
33-36	Cpe	40-714008-Sset.	16.00
33-37	Roadster	40-714008-Sset.	16.00
33-39	Cabriolet	40-714008-Sset.	16.00

Rumble Seat Lid Stop Bracket Bumpers

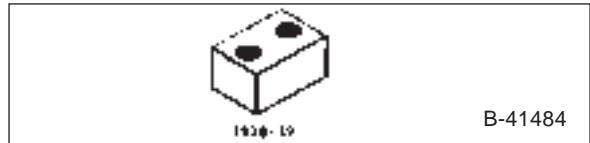

28-36	Cpe	B-41484set.	4.50
28-37	Roadster	B-41484set.	4.50
28-39	Cabriolet	B-41484set.	4.50

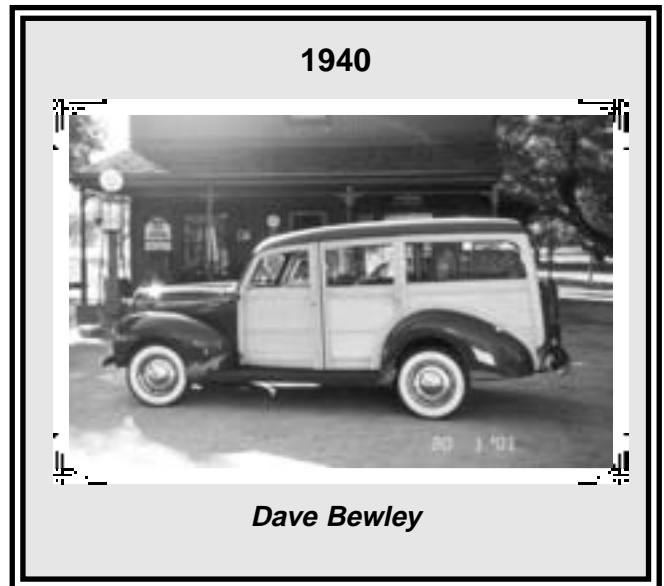



1934 Sedan, Clyde & Gail Bangiola

Section 55 Patch Panels

FLOOR PANS

Front Sloping Floor Section or Toe Boards

Connects the flat section of the floor pan to the firewall.



*52-54	Pass	BA-11132-RH, RH, hand stamped.....ea.	46.00
*52-54	Pass	BA-11133-LH, LH, hand stamped.....ea.	46.00
*55-56	Pass	B5A-11132-RH-HQ, RH, 18 gauge, die stamped.....ea.	145.00
*55-56	Pass	B5A-11133-LH-HQ, LH, 18 gauge, die stamped.....ea.	145.00

Front Floor Pan



*52-54	Pass	BA-157L, LH hand stamped.....ea.	66.00
*52-54	Pass	BA-157R, RH hand stamped.....ea.	66.00
*55-56	Pass	B5A-157L-HQ, LH, 18 gauge.....ea.	175.00
*55-56	Pass	B5A-157R-HQ, RH, 18 gauge.....ea.	175.00
*49-50	Merc	8M-157L, LH hand stamped.....ea.	60.00
*49-50	Merc	8M-157R, RH hand stamped.....ea.	60.00

Rear Floor Pan

*52-54	Pass	BA-158L, LH hand stamped.....ea.	66.00
*52-54	Pass	BA-158R, RH hand stamped.....ea.	66.00
*55-56	Pass	B5A-158L-HQ, LH.....ea.	205.00
*55-56	Pass	B5A-158R-HQ, RH.....ea.	205.00

Rear Center Floor Hump

55-56	Pass	B5A-11141, hand stamped.....ea.	25.00
-------	------	---------------------------------	-------

Dimmer Switch Cover Plate

55-56	Pass	B5A-406, hand stamped.....ea.	12.00
-------	------	-------------------------------	-------

Toe Board Kit

Replacement style, readily available.

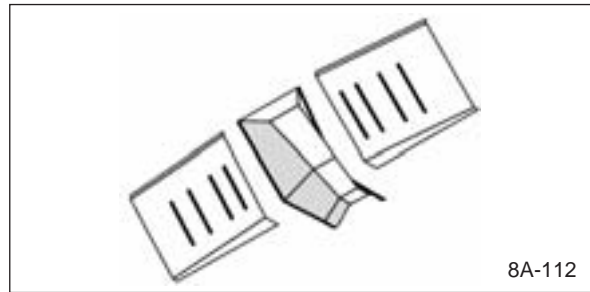

*49-51	Pass	8A-112, exc. conv and wagon.....kit.	250.00
*49-51	Conv	8A-112C.....ea.	145.00

Floor Pan Kits

Replacement style, readily available. Stamped from 18 gauge steel. Kit includes main flat section of floor; inner rockers, floor braces, and drive shaft tunnel. Use the toe board kit to make a nice floor pan. For wagons you have to add additional steel to the flat floor section and the inner rockers.



*49-51	Pass	8A-111, front.....kit.	315.00
--------	------	------------------------	--------



*49-51	Pass	8A-113, rear.....kit.	330.00
--------	------	-----------------------	--------

Pickup Floor Pans



*38-47	PU	81C-8111106, RH.....ea.	110.00
*38-41	PU	81C-8111107, LH.....ea.	110.00
*42-47	PU	21C-8111107, LH.....ea.	110.00
*48-52	PU	7C-8111106, RH.....ea.	110.00
*48-52	PU	7C-8111107, LH.....ea.	110.00



*48-52	PU	7C-8111106-PR, one piece type.....ea.	225.00
*53-55	PU	BAAA-8111106, RH.....ea.	110.00



*53-55	PU	BAAA-8111107, LH	ea.	110.00
*53-56	PU	BAAA-8111108, rear	ea.	240.00
*56	PU	B6C-8111106, RH, with battery hole.....	ea.	125.00
*56	PU	B6C-8111107, LH	ea.	125.00

Front Door Hinge Post to Floor Brace



35-36	Roadster	48-7010116-PR	pr.	65.00
35-36	Phaeton	48-7010116-PR	pr.	65.00

Floor Pan Braces



49-50	Pass	8A-157-BR, front	ea.	80.00
49-51	Pass	8A-158-BR, rear	ea.	80.00

Under Body Floor Braces

52-54	Pass	BA-11140-SET, 10 pcs.	set.	110.00
55-56	Pass	B5A-11140-SET, 10 pcs.	set.	110.00

TRANSMISSION HOLE COVER

Transmission Hole Cover

*37-38	Pass	78-7012108-NH, no hole.....	ea.	50.00
--------	------	-----------------------------	-----	-------



*40-47	PU	01C-7012108-NH, no hole	ea.	85.00
*48-52	PU	7C-8112108-A, no hole	ea.	133.00
*53-56	PU	BAAA-8112108-NH, no hole.....	ea.	59.00

Transmission Hole Cover Screws

33-34	Pass	3142.....	kit.	3.00
35-36	Pass	3143.....	kit.	3.00
37-40	Pass	3144.....	kit.	2.50

COWL PATCHES

Cowl Side Panels

Inner & outer cowl structure replaces up to the belt line. Pre-drilled holes for hood hinge, cowl trim, hood support, hood bumper, & door hinges. Fender cage nuts installed.

39	Dlx Pass	91A-400/1	pr.	675.00
40	Pass	91A-400/1	pr.	675.00

Cowl Patch Panel



35-36	Pass	48-7002054-PR-HQ	pr.	75.00
35-36	Pass	48-7002054/5	pr.	65.00
37-38	Pass	78-7002054-R, RH	ea.	123.00
37-38	Pass	78-7002055-L, LH.....	ea.	123.00
39	Std Pass	78-7002054-R, RH	ea.	123.00
39	Std Pass	78-7002055-L, LH.....	ea.	123.00
39	Dlx Pass	91A-7002054-R, RH	ea.	125.00
39	Dlx Pass	91A-7002055-L, LH.....	ea.	125.00
40	Pass	91A-7002054-R, RH	ea.	125.00
40	Pass	91A-7002055-L, LH.....	ea.	125.00
35-37	PU	67-7002054/5	pr.	45.00

Lower Inner Cowl Structure



37-40	Pass	78-148-L, LH.....	ea.	125.00
37-40	Pass	78-148-R, RH	ea.	125.00

DOOR

Door Bottom Patch Panel

Kit includes outer door skin and inner door structure. Outer door skin is stamped from 20 gauge steel and is 6 inches high. The inner door structure is stamped from 18 gauge steel.

35-36	Cpe 3W	48-7013240, RH.....	kit.	197.50
35-36	Cpe 3W	48-7013241, LH.....	kit.	197.50
35-36	Cpe 5W	48-7713240, RH.....	kit.	197.50
35-36	Cpe 5W	48-7713241, LH.....	kit.	197.50
35-36	Sdn 2D	48-7013240, RH.....	kit.	197.50
35-36	Sdn 2D	48-7013241, LH.....	kit.	197.50
35-36	Sdn 4D	48-7713240, RH, front.....	kit.	197.50
35-36	Sdn 4D	48-7713241, LH, front.....	kit.	197.50
37-40	Conv	78-7013240, RH.....	kit.	197.50

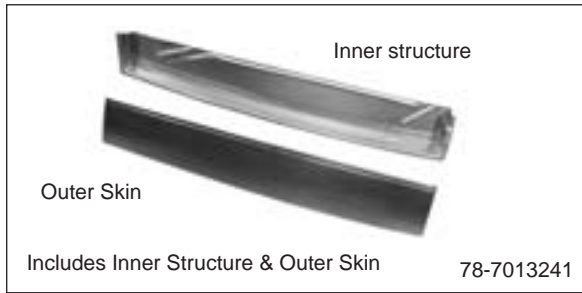

37-40	Conv	78-7013241, LH.....	kit.	197.50
37-40	Cpe	78-7713240, RH.....	kit.	197.50
37-40	Cpe	78-7713241, LH.....	ea.	197.50
37-40	Sdn 2D	78-7013240, RH.....	kit.	197.50
37-40	Sdn 2D	78-7013241, LH.....	kit.	197.50
37-40	Sdn 4D	78-7713240, RH, front.....	kit.	197.50
37-40	Sdn 4D	78-7713241, LH, front.....	ea.	197.50
41-48	Conv	11A-7013240, RH.....	kit.	197.50
41-48	Conv	11A-7013241, LH.....	kit.	197.50



41-48	Cpe	11A-7713240, RH, 35-3/4".....	kit.	197.50
41-48	Cpe	11A-7713241, LH, 35-3/4".....	kit.	197.50
41-48	Cpe	11A-7013240, RH, 44-3/8".....	kit.	197.50
41-48	Cpe	11A-7013241, LH, 44-3/8".....	kit.	197.50
41-48	Sdn 2D	11A-7013240, RH.....	kit.	197.50
41-48	Sdn 2D	11A-7013241, LH.....	kit.	197.50
41-48	Sdn 4D	11A-7713240, RH, front.....	kit.	197.50
41-48	Sdn 4D	11A-7713241, LH, front.....	kit.	197.50
49-51	Conv	8A-7013240, RH.....	kit.	205.00
49-51	Conv	8A-7013241, LH.....	kit.	205.00
49-51	Cpe	8A-7013240, RH.....	kit.	205.00
49-51	Cpe	8A-7013241, LH.....	kit.	205.00
49-51	Sdn 2D	8A-7013240, RH.....	kit.	205.00
49-51	Sdn 2D	8A-7013241, LH.....	kit.	205.00

ROCKER PANELS

Outer Rocker Patch Panel

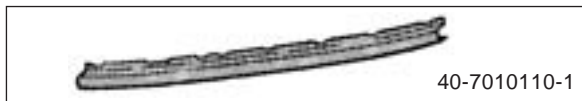

33-34	Pass 2D	40-7010110/1.....	pr.	Call
35-36	Pass 2D	48-7010110/1.....	pr.	197.50
37-40	Cpe	78-7010110/1-HQ.....	pr.	125.00
37-40	Sdn 2D	78-7010110/1-HQ.....	pr.	125.00
37-40	Pass 2D	78-7010110/1.....	pr.	80.00
41-48	Pass 2D	11A-7010110/1.....	pr.	60.00
49-51	Pass 2D	8A-7010130-PR.....	pr.	88.00
49-51	Pass 2D	8A-7010130-OR, LH, original style.....	ea.	125.00



49-51	Pass 2D	8A-7010131-OR, RH, original style.....	ea.	125.00
*49-51	Pass 4D	8A-7310130-PR.....	pr.	106.00
52-54	Pass 2D	BA-7010130-PR.....	pr.	83.00
*52-54	Pass 4D	BA-7310130-PR.....	pr.	104.00
55-56	Pass	B5A-7010130-HQ, RH, all 2 door models, high quality.....	ea.	120.00
55-56	Pass	B5A-7010131-HQ, LH, all 2 door models, high quality.....	ea.	120.00
55-56	Pass 2D	B5A-7010130-PR.....	pr.	83.00
*55-56	Pass 4D	B5A-7310130-PR.....	pr.	104.00
41-48	Merc 2D	11A-7010110/1.....	pr.	60.00
52-54	Merc 2D	BA-7010130-PR.....	pr.	83.00
*52-54	Merc 4D	BA-7310130-PR.....	pr.	104.00
55-56	Merc 2D	B5A-7010130-PR.....	pr.	83.00
*55-56	Merc 4D	B5A-7310130-PR.....	pr.	104.00
55-57	T-Bird	B5S-4010128-A, RH.....	ea.	49.00
55-57	T-Bird	B5S-4010129-A, LH.....	ea.	49.00
35-37	PU	67-7010110/1.....	pr.	80.00

Front Rocker Box Assembly



41-48	Pass	11A-166-L, LH.....	ea.	120.00
41-48	Pass	11A-166-R, RH.....	ea.	120.00

Center Rocker Box Assembly



41-48	Cpe	11A-159-L, LH.....	ea.	175.00
41-48	Cpe	11A-159-R, RH.....	ea.	175.00
41-48	Sdn Cpe	11A-162-L, LH.....	ea.	180.00
41-48	Sdn Cpe	11A-162-R, RH.....	ea.	180.00
41-48	Sdn 2D	11A-162-L, LH.....	ea.	180.00
41-48	Sdn 2D	11A-162-R, RH.....	ea.	180.00
41-48	Sdn 4D	11A-159-L, LH.....	ea.	175.00
41-48	Sdn 4D	11A-159-R, RH.....	ea.	175.00



Rear Rocker Box Assembly



41-48	Cpe	11A-163-L, LH.....ea.	80.00
41-48	Cpe	11A-163-R, RH.....ea.	80.00
41-48	Sdn Cpe	11A-160-L, LH.....ea.	80.00
41-48	Sdn Cpe	11A-160-R, RH.....ea.	80.00
41-48	Sdn 2D	11A-160-L, LH.....ea.	80.00
41-48	Sdn 2D	11A-160-R, RH.....ea.	80.00
41-48	Sdn 4D	11A-163-L, LH.....ea.	80.00
41-48	Sdn 4D	11A-163-R, RH.....ea.	80.00

Woodie Rocker Patch Panel

Sold in two sections, front and rear. Exact reproduction of original. They will join at the "B" pillar by an overlapping flange

35-40	Wagon	48-7910110/1, front.....pr.	370.00
35-36	Wagon	48-7920110/1, rear.....pr.	198.00
37-40	Wagon	78-7920110/1, rear.....pr.	198.00

Extended Outer Rocker Patch Panel



*49-51	Pass 2D	8A-7610130-PR.....pr.	98.00
*52-54	Pass 2D	BA-7610130-PR.....pr.	104.00
*55-56	Pass 2D	B5A-7610130-PR.....pr.	104.00

Inner Rocker Patch Panel

Replacement type, no ribs.

49-59	Pass	8A-230030-R, RH.....set.	26.00
49-59	Pass	8A-230031-L, LH.....set.	26.00

QUARTER PANELS

Front Lower Quarter Patch Panel

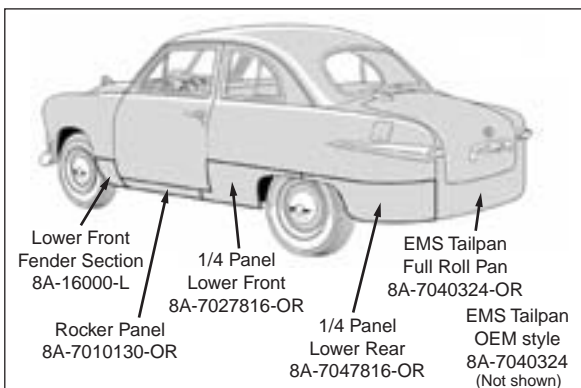

35-36	Pass	48-7027816/7.....pr.	75.00
-------	------	----------------------	-------

37-38	Cabriolet	81A-7027816/7, correct style.....pr.	225.00
39-40	Conv	81A-7027816/7, correct style.....pr.	225.00
37-40	Cpe	78-7027816/7-HQ, correct style..pr.	225.00



37-40	Sdn	81A-7027816/7, correct style.....pr.	225.00
41-48	Cpe	11A-7727816-RH, short door coupe, correct style.....ea.	165.00
41-48	Cpe	11A-7727816-LH, short door coupe, correct style.....ea.	165.00
41-48	Cpe	11A-7027816-RH, long door coupe, correct style.....ea.	135.00
41-48	Cpe	11A-7027816-LH, long door coupe, correct style.....ea.	135.00
41-48	Sdn 2D	11A-7027816-RH, correct style..ea.	135.00
41-48	Sdn 2D	11A-7027816-LH, correct style..ea.	135.00
*49-51	Pass	8A-7027816-OR, LH, except 4-door and wagon.....ea.	185.00
*49-51	Pass	8A-7027817-OR, RH, except 4-door and wagon.....ea.	185.00
55-56	Pass	B6A-7027840-HQ, RH, except 4 door.....ea.	160.00
55-56	Pass	B6A-7027841-HQ, LH, except 4 door.....ea.	160.00



41-48	Merc Cpe	11A-7727816-RH, short door coupe, correct style.....ea.	165.00
41-48	Merc Cpe	11A-7027816-RH, long door coupe, correct style.....ea.	135.00
41-48	Merc Cpe	11A-7727816-LH, short door coupe, correct style.....ea.	165.00
41-48	Merc Cpe	11A-7027816-LH, long door coupe, correct style.....ea.	135.00
41-48	Merc 2D Sdn	11A-7027816-RH, correct style..ea.	135.00
41-48	Merc 2D	11A-7027816-LH, correct style..ea.	135.00

Rear Section Quarter Patch Panel

*49-51	Pass	8A-7047816-OR, LH, except 4-door and wagon.....ea.	185.00
*49-51	Pass	8A-7047817-OR, RH, except 4-door and wagon.....ea.	185.00
52-54	Pass	BA-7027846, RH.....ea.	48.00



52-54	Pass	BA-7027847, LH.....ea.	48.00
55-56	Pass	B6A-7027846-HQ, RH.....ea.	160.00
55-56	Pass	B6A-7027847-HQ, LH.....ea.	160.00

Inner Quarter Patch Panel

52-54	Pass	B2A-27840-R, RH, hand stamped.....ea.	34.00
-------	------	---------------------------------------	-------

52-54	Pass	B2A-27841-L, LH, hand stamped.....ea.	34.00
55-56	Pass	B5A-27840-HQ, RH.....ea.	150.00
55-56	Pass	B5A-27841-HQ, LH.....ea.	150.00

Body to Frame Gusset

33-34	Pass	40-700134/5	pr. 55.00
-------	------	-------------------	-----------

TRUNK

Replacement Type Trunk Floor

Not correct for a restoration, but excellent for a street rod or driver car. Made from 18 gauge steel. 1941-Early 46 Used with cars that have a tool compartment at the back of the trunk, Late 1946-48 is for a flat trunk floor without a tool compartment.

41-46	Pass	11A-18-HR, early 46, includes right and left side and fuel filler neck cover.....ea.	165.00
46-48	Pass	51A-539-HR, late 46, includes right and left trunk floor, floor brace, floor extension, fuel filler neck cover.....ea.	185.00
41-46	Merc	11A-18-HR, early 46, includes right and left side and fuel filler neck cover.....ea.	165.00
46-48	Merc	51A-539-HR, late 46, includes right and left trunk floor, floor brace, floor extension, fuel filler neck cover.....ea.	185.00

Trunk Floor Main Section

These do not include cut out for spare tire well. Die formed 18 gauge.

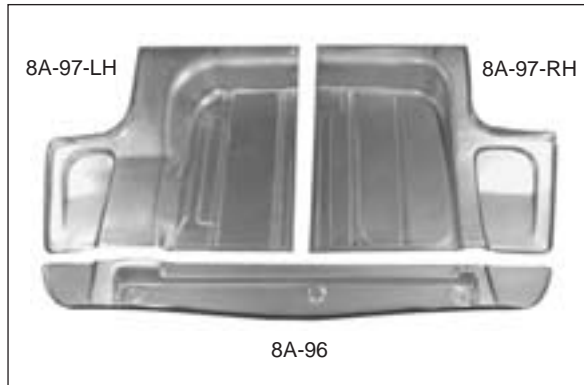

*49-51	Pass	8A-97-RH, RH	ea. 200.00
*49-51	Pass	8A-97-LH, LH.....ea.	200.00

Trunk Floor Rear Section

Die stamped 18 gauge. Mounts at rear of body, goes forward 8".

*49-51	Pass	8A-96.....ea.	185.00
--------	------	---------------	--------

Trunk Spare Tire Well

Not made like original. Holds tire straight, not at an angle like original.

*49-51	Pass	8A-194.....ea.	195.00
--------	------	----------------	--------

UNDER TRUNK LID

Under Trunk Lid Panel

*35-36	Roadster	48-7740324.....ea.	320.00
--------	----------	--------------------	--------

*35-36	Cabriolet	48-7740324.....ea.	320.00
*35-36	Cpe	48-7740324.....ea.	320.00

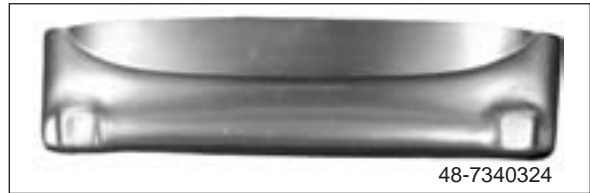

*35-36	Sdn	48-7340324.....ea.	315.00
*35-36	Hmpbk 4D	48-7040324-H.....ea.	300.00
*37	Roadster	78-7740324.....ea.	320.00
*37	Cabriolet	78-7740324.....ea.	320.00
*37	Phaeton	78-704058-B.....ea.	315.00
*37	Conv Sdn	78-704058-B.....ea.	315.00
*37-38	Cpe	78-7740324.....ea.	320.00
*37	Club Cpe	78-7740324.....ea.	320.00
*37	Sdn	78-704058-A-BD, MFG by Drake.....ea.	350.00
*37	Sdn	78-704058-A.....ea.	315.00
*37-38	Hmpbk 4D	78-704058-B.....ea.	315.00
*38-40	Sdn	91A-7040324.....ea.	300.00
*39-40	Cpe	91A-7740324, w/precut holes for bumper.....ea.	295.00
*39-40	Cpe	91A-7740324-EMS, w/precut holes for bumper, MFG by EMS.....ea.	330.00
*39-40	Cpe	01A-950, MFG by Drake.....ea.	450.00
*40	Conv	91A-7740324, w/precut holes for bumper.....ea.	295.00
*40	Conv	91A-7740324-EMS, w/precut holes for bumper, MFG by EMS.....ea.	330.00
*40	Conv	01A-950, MFG by Drake.....ea.	450.00



*41-47	Pass	11A-7040324, early 47.....ea.	315.00
*47-48	Pass	6A-7040320, late 47.....ea.	95.00
*49-51	Pass	8A-7040324, OEM style.....ea.	130.00



*49-51	Pass	8A-7040324-OR, full roll pan style.....ea.	225.00
*55-56	Pass	B5A-7040324, no holes.....ea.	315.00
*41-47	Merc	11A-7040324, early 47.....ea.	315.00
*47-48	Merc	6A-7040320.....ea.	95.00

Tool Tray



*35-36	Cabriolet	48-7740324-T.....ea.	300.00
--------	-----------	----------------------	--------



- *35-36 Roadster 48-7740324-Tea. 300.00
- *35-36 Cpe 48-7740324-Tea. 300.00
- *38-40 Sdn 91A-7040324-T,
must modify to fit.....ea. 300.00



- *41-47 Pass 11A-7040324-EXT,
early 47ea. 155.00

Tool Tray to Under Trunk Panel Braces

- 37 Sdn 78-704058-ABRset. 95.00

GAS TANK COVER

Steel Gas Tank Cover -Smooth No Holes

Has mounting holes. The filler neck hole is marked, must be cut open to use original gas tank.



- 33-34 Pass 40-16396-SM.....ea. 465.00

Gas Tank Cover Screws

- 33-34 Pass 3170set. 1.25

MISC

Weld in Hole Repair Kit

Made of 18 gauge 3/64" thick steel. 200 Piece kit. Includes 25 of each size: 1-1/4", 1", 7/8", 3/4", 5/8", 1/2", 3/8", 5/16"

- All HR-1580.....kit. 48.00

35-47 PU CAB PATCH PANELS

Complete Cab Floor

Must relocate gas tank on 42-47 PU. Floor includes toe boards, floor pans, cowl patch panels, rear cab corners, rocker panels, transmission cover, front cab mount, center hump, hinge posts, rear floor, and lower rear repair panel. Must be shipped via truck freight. Crating fee is extra. Sold as a kit, must be assembled. Please specify year.

- *40-47 PU 01C-FLOOR.....ea. 1130.00

**Order by 1:00pm (Pacific Time)
SAME DAY SHIPPING!**

Front Cab Mounts



- 40-47 PU 01C-8102056/7.....pr. 117.00

Cowl Patch Panel



- 35-37 PU 67-7002054-FULLpr. 146.00



- 40-47 PU 01C-8102054/5.....pr. 192.00

Door Hinge Post Section

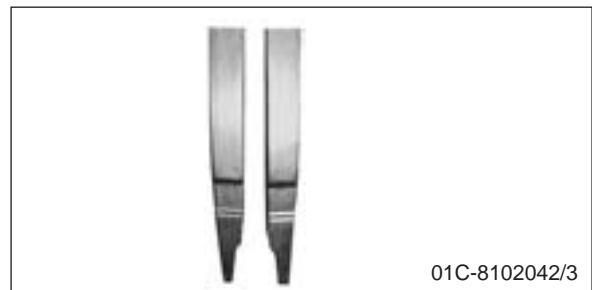

- 40-47 PU 01C-8102042/3.....pr. 58.50

Inner Door Bottom Patch Panel

- 35-37 PU 67-8110110/1pr. 110.00
- 38-47 PU 01C-8120124/5.....pr. 125.00

Outer Door Patch Panel

- 35-37 PU 67-8113240pr. 110.00

Rocker Patch Panel



40-47 PU 01C-8110110/1.....pr. 100.00

Toe Boards



40-47 PU 01C-8111103/4.....pr. 192.00

Floor Pans



*38-47 PU 81C-8111106, RH.....ea. 110.00
 *38-41 PU 81C-8111107, LH.....ea. 110.00
 *42-47 PU 21C-8111107, LH.....ea. 110.00

Transmission Hole Cover



*35-37 PU 50-7012108-NH, no hole.....ea. 75.00
 *38-39 PU 81C-7012108-NH, no hole.....ea. 75.00
 *40-47 PU 01C-7012108-NH, no hole.....ea. 85.00

Floor Center Hump

Goes between left & right floor pans; in between transmission hole cover and rear floor pan.

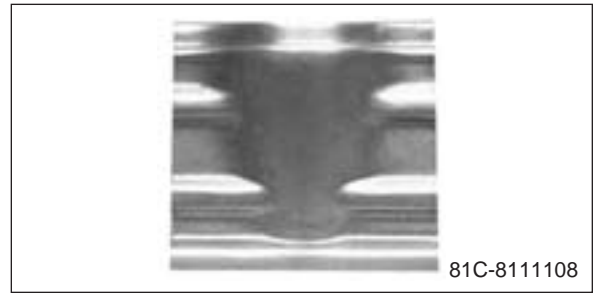

40-47 PU 81C-8111108ea. 50.00

Rear Cab Floor

Will fit 42-47 if you relocate gas tank.



*40-41 PU 01C-8111108ea. 315.00

Lower Rear Cab Repair Panel



35-37 PU 50-81040304ea. 62.50
 38-47 PU 01C-81040304ea. 63.00

Lower Rear Cab Corners



35-37 PU 67-81040302-3pr. 87.50



38-47 PU 81C-81040302/3.....pr. 87.50



48-52 PU CAB PATCH PANELS

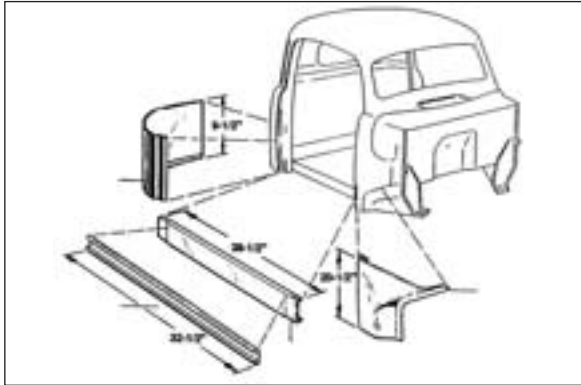

Cowl Patch Panel

48-52	PU	7C-8102054, RH.....ea.	70.00
48-52	PU	7C-8102055, LH.....ea.	70.00

Rocker Patch Panel

48-52	PU	8C-8110110-PRpr.	42.50
-------	----	------------------------	-------

Floor Pan

*48-52	PU	7C-8111106, RH.....ea.	110.00
*48-52	PU	7C-8111107, LH.....ea.	110.00
*48-52	PU	7C-8111106-PR, one piece type.....ea.	225.00

Transmission Hole Cover

*48-52	PU	7C-8112108-A, no hole.....ea.	133.00
--------	----	-------------------------------	--------

Lower Door Seal Retainer

48-52	PU	7C-8120712-PR, on cab.....pr.	7.00
-------	----	-------------------------------	------

Cab Corner Patch Panel

48-52	PU	7C-8140302, RH.....ea.	45.00
48-52	PU	7C-8140303, LH.....ea.	45.00

53-56 PU CAB PATCH PANELS

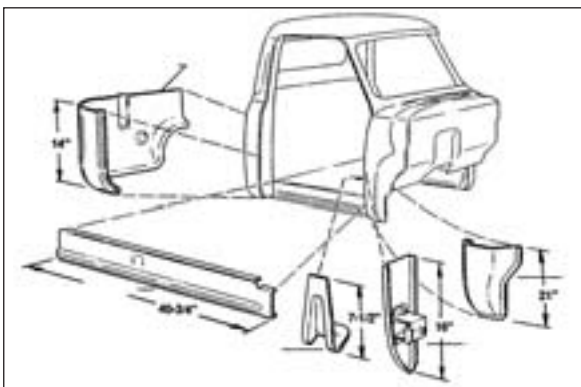

Cowl Patch Panel

53-56	PU	BAAA-8102054, RH.....ea.	50.00
53-56	PU	BAAA-8102055, LH.....ea.	50.00

Extended Cowl Patch Panel

53-56	PU	BAAA-8102052, RH.....ea.	60.00
53-56	PU	BAAA-8102053, LH.....ea.	60.00

Door Pillar Replacement

53-56	PU	BAAA-8102042, RH.....ea.	50.00
53-56	PU	BAAA-8102043, LH.....ea.	50.00

Front Body Mount

53-56	PU	BAAA-8102056, RH.....ea.	25.00
53-56	PU	BAAA-8102057, LH.....ea.	25.00

Upper Cab Mount Cup

Goes on top of large cab rubber mount.

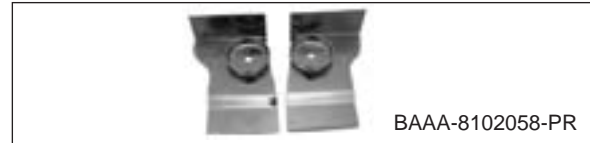

53-56	PU	BAAA-8102058-PR.....pr.	24.00
-------	----	-------------------------	-------

Rubber Mount Metal Cup

Goes under large cab rubber mount.



53-56	PU	BAAA-8102060-PR.....pr.	10.00
-------	----	-------------------------	-------

Rocker Patch Panel

53-56	PU	BAAA-8110110-PR.....pr.	100.00
-------	----	-------------------------	--------

Cab Skirt Channel

Goes from cab to running board seal

53-55	PU	BAAA-8110112-PR.....pr.	17.50
-------	----	-------------------------	-------

Floor Pan

*53-55	PU	BAAA-8111106, RH.....ea.	110.00
*53-55	PU	BAAA-8111107, LH.....ea.	110.00
*56	PU	B6C-8111106, RH, w/battery hole.....ea.	125.00
*56	PU	B6C-8111107, LH.....ea.	125.00

Steel Door

Steel door shell. Must be shipped via truck freight.

*53-55	PU	BAAA-702361, RH.....ea.	560.00
*53-55	PU	BAAA-702360, LH.....ea.	560.00

Inner Door Lower Patch Panel

53-56	PU	BAAA-8120124, RH.....ea.	45.00
53-56	PU	BAAA-8120125, LH.....ea.	45.00

Lower Outer Door Skin

53-56	PU	BAAA-8120200, RH.....ea.	45.00
53-56	PU	BAAA-8120201, LH.....ea.	45.00

Lower Door Seal Retainer on Door

53-60	PU	BAAA-8120712-PR.....pr.	8.00
-------	----	-------------------------	------

Cab Corner Patch Panel

53-56	PU	BAAA-8140302-S, RH.....ea.	40.00
53-56	PU	BAAA-8140303-S, LH.....ea.	40.00

Rear Inner Cab Corner

53-56	PU	BAAA-8140308-S, RH.....ea.	65.00
53-56	PU	BAAA-8140309-S, LH.....ea.	65.00

Section 56 Body Trim

HOOD TRIM

Top of Hood Trim



39	Dlx Pass	91A-16736ea.	55.00
40	Std Pass	01A-16736-Aea.	55.00
40	Dlx Pass	01A-16736-Bea.	55.00
41	Sdn Dly	01A-16736-Aea.	55.00
49-50	Pass	8A-16736ea.	50.00
40-41	PU	01C-16736ea.	55.00
42-47	PU	21C-16736, SSea.	75.00

Lower Front of Hood Trim



39	Dlx Pass	91A-8264-5, bottompr.	180.00
39	Dlx Pass	91A-8266/7-B, toppr.	52.50
40	Std Pass	01A-8216pr.	65.00



40	Dlx Pass	01A-16868/9, big trimpr.	95.00
40	Dlx Pass	01A-16954/5, small trimpr.	75.00
40	PU	01A-8216pr.	65.00
41	PU	11C-8264-5pr.	180.00

Hood Side Trim

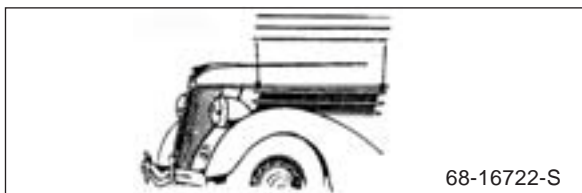

35	Pass	48-16722-SS, 8 pcs., w/clipsset.	110.00
36	Pass	68-16722-S, 6 pcs., w/clipsset.	110.00

39	Dlx Pass	91A-16722-B, RH, upperea.	53.50
39	Dlx Pass	91A-16723-B, LH, upperea.	53.50
39	Dlx Pass	91A-16724-B, RH/LH, lowerea.	30.00
40	Std Pass	01A-16722-A, RHea.	50.00
40	Std Pass	01A-16723-A, LHea.	50.00
40	Dlx Pass	01A-16722-B, RHea.	50.00
40	Dlx Pass	01A-16723-B, LHea.	50.00
47-48	Pass	6A-16722/3-Bpr.	160.00



48-50	PU	7C-16720, set of 4set4.	95.00
-------	----	--------------------	------------	-------

Hood Side End Trim

51	PU	1C-16732-Bpair.	125.00
----	----	------------	------------	--------

Hood Trim & Dummy Handle

Includes left hand dummy handle with vertical trim & the right hand vertical trim



48-50	PU	7C-16608/9kit.	100.00
-------	----	------------	-----------	--------

WINDSHIELDTRIM

Windshield Trim

Polished stainless. Includes right & left hand trim with joint clips and screws

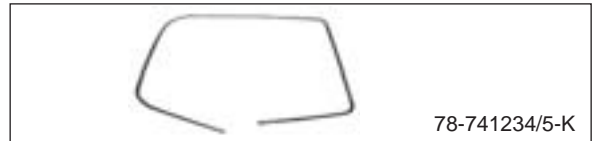

37-40	Conv	78-741234/5-Kpr.	395.00
37-40	Wagon	78-741234/5-Kpr.	395.00

COWL TRIM

Cowl Trim

39	Pass	91A-700328/9pr.	33.50
40	Pass	01A-700328/9pr.	40.00
47-48	Pass	6A-7002328/9-Bpr.	90.00



DOOR TRIM

Front Door Trim

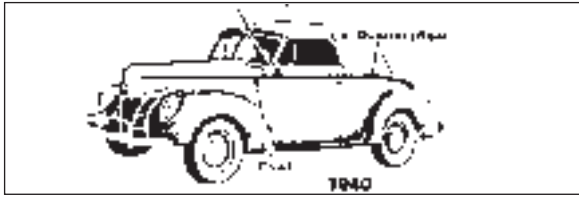

39	Conv	91A-7720934, RH	ea.	33.50
39	Conv	91A-7720935, LH	ea.	33.50
39	Conv Sdn	91A-7420934, RH	ea.	42.00
39	Conv Sdn	91A-7420935, LH	ea.	42.00
39	Cpe	91A-7320934, RH	ea.	30.00
39	Cpe	91A-7320935, LH	ea.	30.00
39	Sdn 2D	91A-7020934, RH	ea.	35.00
39	Sdn 2D	91A-7020935, LH	ea.	35.00
39	Sdn 4D	91A-7320934, RH	ea.	30.00
39	Sdn 4D	91A-7320935, LH	ea.	30.00
39	Sdn Dly	91A-7320934, RH	ea.	30.00
39	Sdn Dly	91A-7320935, LH	ea.	30.00
40	Conv	01A-7020934, RH	ea.	40.00
40	Conv	01A-7020935, LH	ea.	40.00
40	Cpe	01A-7320934, RH	ea.	40.00
40	Cpe	01A-7320935, LH	ea.	40.00
40	Sdn 2D	01A-7020934, RH	ea.	40.00
40	Sdn 2D	01A-7020935, LH	ea.	40.00
40	Sdn 4D	01A-7320934, RH	ea.	40.00
40	Sdn 4D	01A-7320935, LH	ea.	40.00
40	Sdn Dly	01A-7320934, RH	ea.	40.00
40	Sdn Dly	01A-7320935, LH	ea.	40.00
47-48	Conv	6A-7020934/5-B	pr.	160.00
47-48	Cpe	6A-7320934/5-B, short door	pr.	160.00
47-48	Sdn Cpe	6A-7020934/5-B, long door	pr.	160.00
47-48	Sdn 2D	6A-7020934/5-B	pr.	160.00
47-48	Sdn 4D	6A-7320934/5-B	pr.	160.00
47-48	Sdn Dly	6A-7320934/5-B	pr.	160.00
49-50	Conv	8A-20938-70B, RH	ea.	50.00
49-50	Conv	8A-20939-70B, LH	ea.	50.00

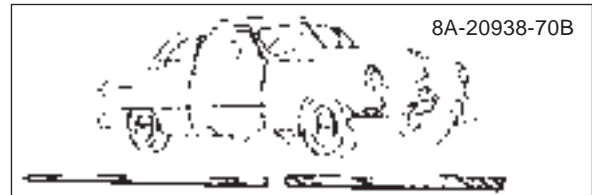

8A-20938-70B

49-50	Cpe	8A-20938-70B, RH	ea.	50.00
49-50	Cpe	8A-20939-70B, LH	ea.	50.00
49-50	Sdn 2D	8A-20938-70B, RH	ea.	50.00
49-50	Sdn 2D	8A-20939-70B, LH	ea.	50.00
49-50	Sdn 4D	8A-20938-73B, RH	ea.	50.00
49-50	Sdn 4D	8A-20939-73B, LH	ea.	50.00

Rear Door Trim

39	Conv Sdn	91A-7425554, RH	ea.	42.00
39	Conv Sdn	91A-7425555, LH	ea.	42.00
39	Sdn 4D	91A-7325554, RH	ea.	29.95
39	Sdn 4D	91A-7325555, LH	ea.	29.95
40	Sdn 4D	01A-7325554, RH	ea.	42.00
40	Sdn 4D	01A-7325555, LH	ea.	42.00

Custom Cab Door Trim



B6C-8120910-S

56	PU	B6C-8120910-S, w/clips	kit.	100.00
----	----	---------------------------	------	--------

QUARTER TRIM

Stainless Quarter Panel Trim

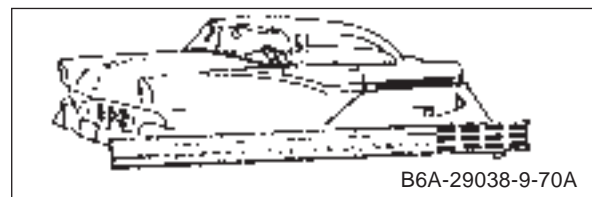

B6A-29038-9-70A

*39	Conv	91A-7629034, RH	ea.	59.95
*39	Conv	91A-7629035, LH	ea.	59.95
*39	Conv Sdn	91A-7429034, RH	ea.	83.00
*39	Conv Sdn	91A-7429035, LH	ea.	83.00
*39	Cpe	91A-7729034, RH	ea.	60.00
*39	Cpe	91A-7729035, LH	ea.	60.00
*39	Sdn 2D	91A-7029034, RH	ea.	62.00
*39	Sdn 2D	91A-7029035, LH	ea.	62.00
*39	Sdn 4D	91A-7329034, RH	ea.	58.00
*39	Sdn 4D	91A-7329035, LH	ea.	58.00
*39	Sdn Dly	91A-7829034, RH/LH	ea.	65.00
*40	Conv	01A-6629044-B, RH	ea.	60.00
*40	Conv	01A-6629045-B, LH	ea.	60.00
*40	Cpe	01A-7729034, RH	ea.	60.00
*40	Cpe	01A-7729035, LH	ea.	60.00

**Order by 1:00pm (Pacific Time)
SAME DAY SHIPPING!**

*40	Sdn 2D	01A-7029034, RHea.	60.00
*40	Sdn 2D	01A-7029035, LHea.	60.00
*40	Sdn 4D	01A-7329034, RHea.	58.00
*40	Sdn 4D	01A-7329035, LHea.	58.00
*40	Sdn Dly	01A-7829034, RH/LHea.	65.00
*47-48	Sdn Cpe	6A-7629034/5-Bpr.	200.00
*47-48	Sdn 2D	6A-7029034/5-Bpr.	200.00
*47-48	Conv	6A-7629034/5-Bpr.	200.00
*49-50	Cpe	8A-29038-70B, RHea.	80.00
*49-50	Cpe	8A-29039-70B, LHea.	80.00
*49-50	Conv	8A-29038-70B, RHea.	80.00
*49-50	Conv	8A-29039-70B, LHea.	80.00
*49-50	Sdn 2D	8A-29038-70B, RHea.	80.00
*49-50	Sdn 2D	8A-29039-70B, LHea.	80.00
*55	Pass 2D	B5A-29038-70C, RH or LHea.	65.00
*56	Pass 2D	B6A-29038/9-70A, RH or LHea.	115.00

Chrome Rear Quarter Trim Tail Lamp Spears

51	Pass	1A-29028/9-70pr.	249.95
----	------	---------------	----------	--------

Chrome Rear Quarter Trim Spears



54	Merc	BR-25622-73B, 6 pcs.set.	299.95
----	------	----------------------	-----------	--------

Stainless Quarter Panel Stone Guard

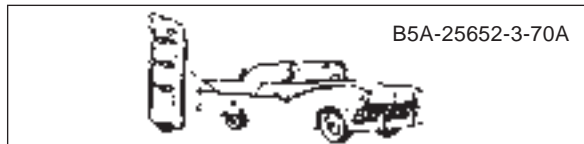

55-56	Pass	B5A-25652/3-70Apr.	39.50
-------	------	-----------------	----------	-------

Stainless Fender Skirt Stone Guard

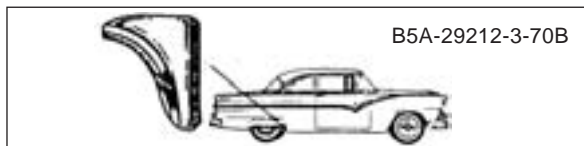

55-56	Pass	B5A-29212/3-70Bpr.	59.95
-------	------	-----------------	----------	-------

“Your company was very helpful and quick to make sure we were satisfied and I thank you so much for your professionalism. We will be ordering from you again. Thanks so much!!!!”
Sincerely,
Sharron M., Texas

BELT LINE

Wagon Belt Line Trim

Set of 4 with mounting hardware.

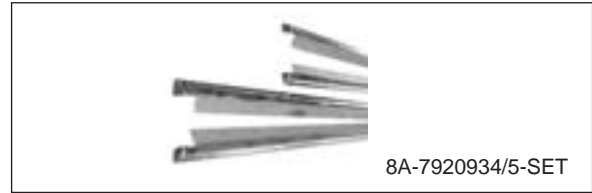

*49-51	Ford Wgn	8A-7920934/5-SETset.	495.00
*49-51	Merc Wgn	8M-7920934/5-SETset.	495.00

FENDER TRIM

Front Fender Trim

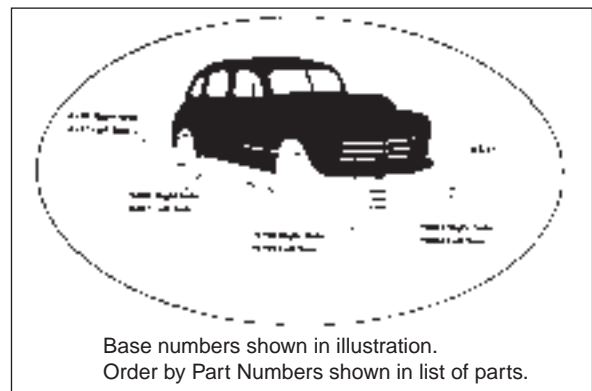

47-48	Pass	6A-16003, RHea.	60.00
47-48	Pass	6A-16004, LHea.	60.00
49-50	Pass	8A-16003, RHea.	55.00
49-50	Pass	8A-16004, LHea.	55.00

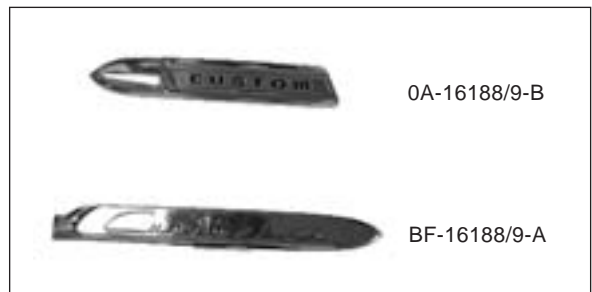

50	Wagon	0A-16188/9-B, "Custom", N.O.S.pr.	55.00
53	Pass	BF-16188/9-A, "Customline", N.O.S.pr.	75.00



Polished Stainless Front Fender Gravel Shield



49-51	Pass	1A-18268, has 3 studs on back, needs 1 #19378 clip	pr.	129.95
49-51	Merc	0L-16210-PR, w/hardware	pr.	175.00

Rear Fender Trim

47-48	Cpe	6A-16196-A, RH	ea.	67.00
47-48	Cpe	6A-16197-A, LH	ea.	67.00
47-48	Sdn	6A-16196-A, RH	ea.	67.00
47-48	Sdn	6A-16197-A, LH	ea.	67.00

RUNNING BOARD TRIM

Running Board Extension Trim



47-48	Pass	6A-16168/9	pr.	65.00
-------	------	------------------	-----	-------

Running Board Trim

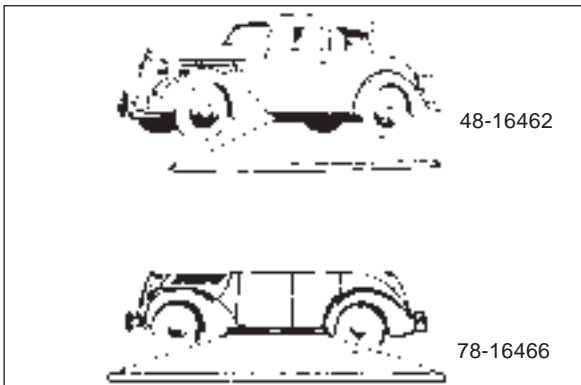

*35-36	Pass	48-16462	pr.	175.00
*37-38	Pass	78-16466	pr.	100.00
*39	Std Pass	78-16466	pr.	100.00
*47-48	Pass	6A-16466/7	pr.	100.00

ROCKER TRIM

Rocker Panel Trim

Clips included.

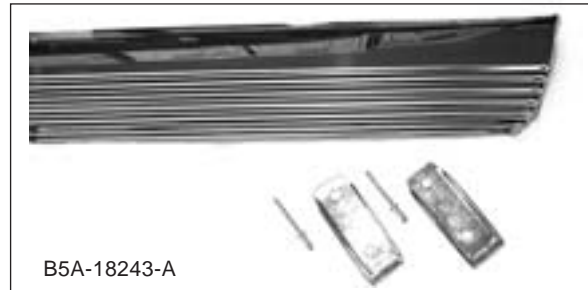

*49-51	Pass	8A-7010176-PR	pr.	300.00
*52-54	Pass	B2A-18243-A, 84"	pr.	315.00
*55-56	Pass	B5A-18243-A, 79-1/2"	pr.	315.00
*49-50	Merc	0M-7010176-PR, 85-1/4"	pr.	335.00
*51	Merc	1M-7010176-PR, 84"	pr.	335.00

**Section 57
Pick-Up Bed**

COMPLETE BEDS

Complete Assembled Beds

The following prices are for authentic beds. Fender bolts and gas filler holes are not installed in bed sides. Prices do not include wooden crates or shipping containers. All orders must be prepaid. The beds are shipped freight collect. Please allow 8-12 weeks for delivery.

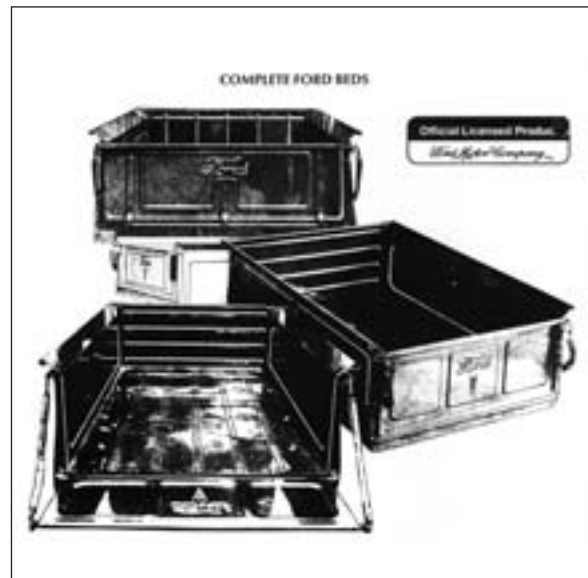

28-31	PU	BED-B-28-31	ea.	2250.00
31	PU	BED-B-31, wide bed	ea.	2800.00
32	PU	BED-B-32	ea.	2800.00

33-34	PU	BED-B-33-34.....ea.	2800.00
35-36	PU	BED-B-35-36.....ea.	2800.00
37	PU	BED-B-37.....ea.	2800.00
38-40	PU	BED-B-38-40.....ea.	2800.00
41	PU	BED-B-41.....ea.	2800.00
42-47	PU	BED-B-42-47.....ea.	2800.00
48-50	PU	BED-B-48-50, early 50.....ea.	2800.00
50-52	PU	BED-B-50-52, late 50, flat sides on bed.....ea.	1725.00
53-72	PU	BED-B-53-72.....ea.	2088.00

Assembled Bed With Stainless Strips and Wood

The following prices are for beds with stainless strips and custom wood. Fender bolts and gas filler holes are not installed in bed sides. Prices do not include wooden crates or shipping containers. All orders must be prepaid. The beds are shipped freight collect. Please allow 8-12 weeks for delivery.

32	PU	BED-B-32-SS.....ea.	2950.00
33-34	PU	BED-B-33-34-SS.....ea.	2950.00
35-36	PU	BED-B-35-36-SS.....ea.	2950.00
37	PU	BED-B-37-SS.....ea.	2950.00
38-40	PU	BED-B-38-40-SS.....ea.	2950.00
41	PU	BED-B-41-SS.....ea.	2950.00
42-47	PU	BED-B-42-47-SS.....ea.	2950.00
48-50	PU	BED-B-48-50-SS, early 50.....ea.	2950.00
50-52	PU	BED-B-50-52-SS, late 50, flat sides on bed.....ea.	1875.00
53-56	PU	BED-B-53-72-SS.....ea.	2238.00

BED MOUNT PARTS

Bed to Frame Mounting Wood

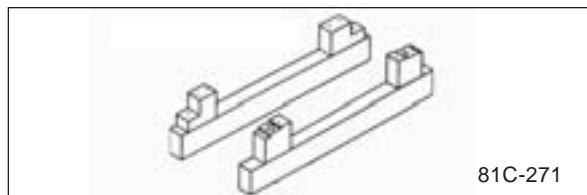

35-37	PU	50-270.....pr.	28.50
38-41	PU	81C-271.....pr.	110.00

Bed to Frame Bolts

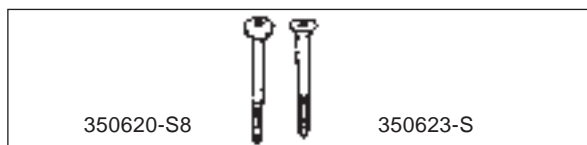

	PU	10329, 8" long.....ea.	10.50
	PU	10330, 8" carriage type.....ea.	10.50
33-34	PU	10328.....ea.	7.00
48-63	PU	350623-S, countersink, 4 req'd.....ea.	4.00
48-63	PU	350620-S8, front of bed, 2 req'd.....ea.	3.00

Bed to Frame Bolt Nut

48-63	PU	34447-S2.....ea.	1.00
-------	----	------------------	------

Bed to Frame Bolt Countersink Washers

48-72	PU	7C-8144440, cadmium.....ea.	1.50
48-72	PU	7C-8144440-SS, stainless.....ea.	2.50

Bed to Frame Bolt Kit

38-41	PU	TM-3841-P, plain.....set.	50.00
38-41	PU	TM-3841-S, unpolished stainless.....set.	65.00
42-50	PU	TM-4250-P, early 1950, plain.....set.	33.00
42-50	PU	TM-4250-S, early 1950, unpolished stainless.....set.	54.00
51-52	PU	TM-5072-P, plain.....kit.	35.00
51-52	PU	6-0305, unpolished stainless.....kit.	46.00
51-52	PU	TM-5072, polished stainless.....kit.	55.00
53-56	PU	6-0309, stainless.....kit.	42.00

Bed to Frame Pads



48-52	PU	7C-8144155-S.....kit.	7.00
53-56	PU	BAAA-8144155-S.....kit.	7.00

BED PANEL

Front Bed Panel

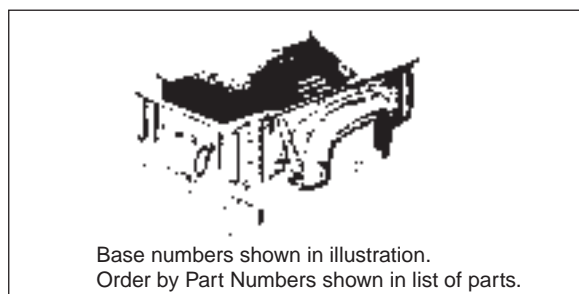

*32-37	PU	B-78244.....ea.	215.00
*38-41	PU	81C-830360.....ea.	175.00
*42-50	PU	21C-8300124.....ea.	185.00
*50-72	PU	8C-8300124.....ea.	150.00

BED SIDES

Complete Bed Side

Holes need to be drilled for fender mounting. Crating fee extra. Shipped by truck freight.

38-41	PU	81C-8327840-A, RH.....ea.	485.00
38-41	PU	81C-8327841-A, LH.....ea.	485.00
*42-47	PU	21C-8327840-A, RH.....ea.	485.00
*42-47	PU	21C-8327841-A, LH.....ea.	485.00
*48-50	PU	7C-8327840-A, RH,early 50.....ea.	425.00
*48-50	PU	7C-8327841-A, LH,early 50.....ea.	425.00
*50-52	PU	8C-8327840-A, RH, late 50.....ea.	250.00

Section 57 - Pick-Up Bed



C&G Early Ford Parts, Inc.

*50-52	PU	8C-8327841-A, LH, late 50.....ea.	250.00
*53-72	PU	BAAA-8327840-A, RH.....ea.	250.00
*53-72	PU	BAAA-8327840-AWO, RH, without stake pocketsea.	275.00
*53-72	PU	BAAA-8327841-A, LH.....ea.	250.00
*53-72	PU	BAAA-8327841-AWO, LH, without stake pocketsea.	275.00

Bed Side Support



37-50	PU	81C-830538ea.	16.00
-------	----	---------------------	-------

Lower Bed Side Panel

This panel fits under bed between the running board and fender.

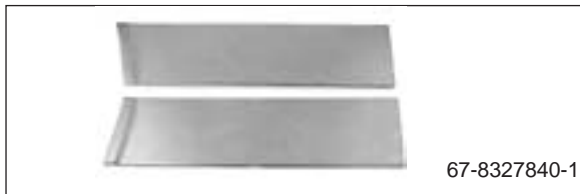

35-37	PU	67-8327840/1pr.	65.00
38-41	PU	01C-8327840-PRpr.	52.00
42-47	PU	21C-830516, RH.....ea.	23.00
42-47	PU	21C-830517, LH.....ea.	23.00

STAKE POCKET

Bed Stake Pocket

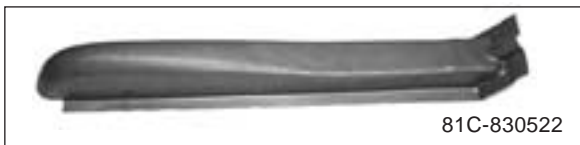

31-37	PU	B-78330, frontea.	39.00
31-37	PU	46-830532, rear.....ea.	39.00
38-50	PU	81C-830522, front/rearea.	40.00
50-52	PU	8C-830522-LR, LH rear.....ea.	45.00
50-52	PU	8C-830522-RR, RH rear.....ea.	45.00
50-72	PU	8C-830522, frontea.	22.00
53-72	PU	BAAA-830522-LR, LH rear.....ea.	45.00
53-72	PU	BAAA-830522-RR, RH rearea.	45.00

Bed Stake Pocket Brace



38-50	PU	81C-830522-B, RH.....ea.	19.00
38-50	PU	81C-830523-B, LH.....ea.	19.00

TAILGATE

Tailgate for 1/2 Ton



*32-34	PU	B-830700ea.	345.00
*35-36	PU	46-830700ea.	345.00
*35-36	PU	46-830700ea.	345.00
*37	PU	77-830700ea.	345.00
*38-40	PU	81C-830700ea.	345.00
*41	PU	11C-8340700ea.	345.00
*42-50	PU	21C-8340700, early 1950, chain bracket in tailgate roll.....ea.	345.00
*50-52	PU	8C-8340700, late 1950, chain bracket below tailgate roll .ea.	345.00

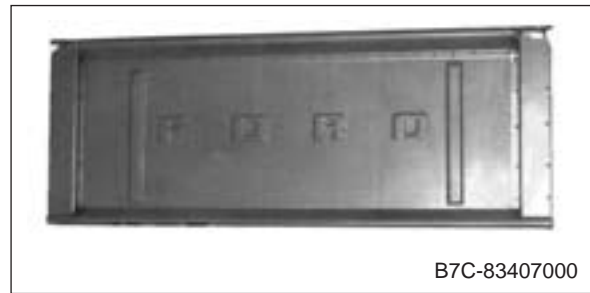

*53-56	PU	B7C-83407000, F-100.....ea.	375.00
*53-72	PU	B7C-8340700-NH, , without hooks for chainsea.	400.00

Tailgate for 3/4 Ton & 1 Ton

*53-79	PU	B7D-8340700-Aea.	400.00
--------	----	------------------------	--------

Tailgate Hinge



31-36	PU	B-78446, 3 req'dea.	6.00
37-72	PU	8C-8343018ea.	6.00
37-72	PU	8C-8343018-SS, stainless.....ea.	15.00

Tailgate Hinge Strap

28-36	PU	B-78454-L, longea.	18.00
28-36	PU	B-78454-S, short.....ea.	18.00

Tailgate Hinge Rod

31-36	PU	B-78456, plainea.	14.00
31-36	PU	B-78456-SS, stainless.....ea.	27.50

Tailgate Top Bar

31-37	PU	B-78460, plainea.	18.00
31-37	PU	B-78460-SS, stainless.....ea.	32.00

Tailgate End



38-50 PU 81C-830700-Aea. 10.00

Tailgate Chain Assembly



38-50 PU 21C-8344456-Apr. 63.00



50-52 PU 1C-8344456-A, late 50, w/coverspr. 63.00
 53-72 PU BAAA-8344456-A, cadmium.....pr. 80.00
 53-72 PU BAAA-8344456-SS, polished stainlesspr. 120.00

Tailgate Chain

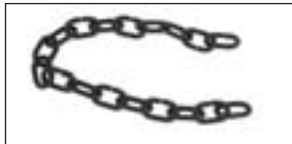

28-37 PU B-78001-Aea. 4.50

Tailgate Chain Link



26-37 PU A-65010-Sea. 3.50

Tailgate Chain Hook



32-52 PU B-78438ea. 7.00

Tailgate Chain Hook Retainer Spring



33-50 PU 46-830824, 2 req'd.....ea. 4.50

Tailgate Chain Bracket



31-37 PU B-78003-Aea. 12.00



38-50 PU 10213ea. 7.00

Tailgate Chain Cover

32-47 PU B-78420ea. 4.50
 48-72 PU 7C-8144450-S, rubber.....pr. 10.00

Tailgate Chain Bumper

53-72 PU BAAA-8344458-S, fits in bracket.....set. 5.00

Tailgate Bumper



53-72 PU BAAA-8340725-Apr. 4.00

Custom Tailgate Latch

Replaces tailgate chains. Modification of tailgate required.



53-56 PU TG-8344456-PR.....pr. 120.00

BED CROSSMEMBERS

Front Bed Crossmember

42-50 PU 8C-8310610-Aea. 40.00
 50-52 PU 1C-8310610-Aea. 40.00
 53-72 PU BAAA-8310610-Aea. 40.00

Center Bed Crossmember

38-41 PU 81C-8310610, front center, 45-1/4"ea. 58.50
 38-41 PU 81C-8310705, rear, center, 44-1/8"ea. 58.50
 42-50 PU 21C-8310705, 2 req'dea. 60.00
 50-72 PU 8C-8310705, 2 req'dea. 40.00



Rear Bed Crossmember



32-37	PU	B-830108	ea.	60.00
38-41	PU	81C-830108	ea.	55.00
42-50	PU	21C-81310608	ea.	60.00
51-66	PU	BAAA-8310608-A	ea.	90.00

Front Bed Metal Crossmember to Bed Wood Spacer



48-72	PU	8C-8110611-PR	pr.	4.00
-------	----	---------------------	-----	------

BED FLOOR

Metal Bed Floor

Made exactly like original for use in original bed. Crating fee is extra. Truck freight collect.

*32	PU	B-10172	ea.	400.00
*33-34	PU	46-10173	ea.	400.00
*35-36	PU	48-10174	ea.	400.00
*37	PU	77-10175	ea.	400.00
*38-41	PU	81C-10176	ea.	400.00
*42-50	PU	21C-10177, Early 50	ea.	400.00

Metal Bed Floor Sub Wood

This is the wood below the metal floor that supports the steel floor.

*38-41	PU	88016	set.	350.00
--------	----	-------------	------	--------

BED WOOD

White Oak Bed Wood



*50-72	PU	7C-8111215-S, late 50, 8 pcs.	set.	360.00
--------	----	---------------------------------------	------	--------

Bed Side to Wood Seal

48-56	PU	7C-8144150-S	pr.	15.00
-------	----	--------------------	-----	-------

Custom Wood Kit

Replaces original steel floor. Includes white oak wood with stainless strips and bolts.

*32-36	PU	B-8111215-KIT	kit.	400.00
*37	PU	77-8111215-KIT	kit.	400.00
*38-41	PU	81C-8111215-KIT	kit.	400.00
*42-50	PU	21C-8111215-KIT	kit.	400.00

METAL STRIPS

Bed Strips with Holes Square Punched

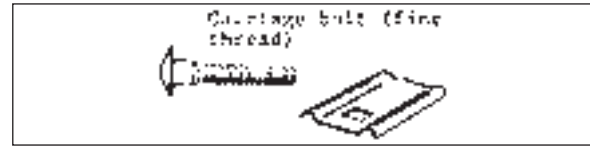

*48-56	PU	7C-8112605-CR, steel, 76-3/4"	ea.	11.50
*48-56	PU	7C-8112605-SS, bright stainless, 76-3/4"	ea.	25.00
*48-56	PU	7C-8112605-SSP, 7 pcs. polished stainless, 76-3/4"	set.	240.00

Bed Strips without Holes

The bed strips that are 144" long must be shipped by truck freight collect.

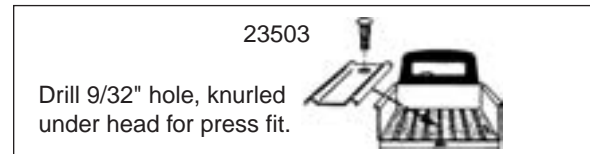

*48-56	PU	7C-8112605-CRU, steel, 76-3/4"	ea.	6.00
*48-56	PU	7C-8112605-SSU, bright stainless, 76-3/4"	ea.	20.00
*48-56	PU	7C-8112605-SSUP, polished stainless, 76-3/4"	set.	220.00
*48-56	PU	BAAA-8112605-CRU, steel, 95"	ea.	8.00
*48-56	PU	BAAA-8112605-SSU, bright stainless, 95"	ea.	22.50
*All	PU	B6C-8112605-CR, steel, 144"	ea.	15.00
*All	PU	B6C-8112605-SS, stainless, 144"	ea.	30.00

Bed Wood/Strip End Cap

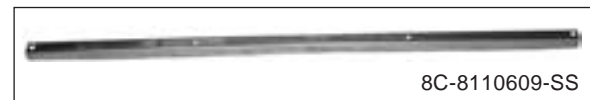

48-72	PU	8C-8110609-CR, steel	ea.	15.00
48-72	PU	8C-8110609-SS, stainless	ea.	30.00
48-72	PU	8C-8110609-SSP, polished stainless	ea.	40.00

BOLTS FOR STRIPS

Bed Strip Bolt Kit w/Holes

For use with square hole punched strips. These kits include 49 bolts and 21 flat large washers.

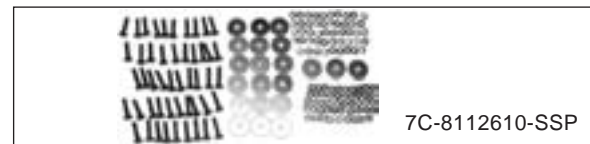

48-56	PU	7C-8112610-CC, chrome	kit.	55.00
-------	----	-----------------------------	------	-------

48-56	PU	7C-8112610-PF, plainkit.	30.00
48-56	PU	7C-8112610-SS, stainlesskit.	50.00
48-56	PU	7C-8112610-SSP, polished stainlesskit.	75.00

Bed Strip Bolt Kit w/o Holes

For use with strips without holes. These kits includes 63 bolts, zinc plated nuts, lock washers and 21 flat large washers. The bolts have knurled underheads. To install them you must drill a 9/32" hole in the strip for a press fit.

48-56	PU	BAAA-8112612-PF, plainkit.	35.00
48-56	PU	BAAA-8112612-CC, chromekit.	65.00

Bed Strip & Wood Bolt Kit

For use when replacing all of the wood and bed strips. All nuts & washers are zinc plated. Includes 65 fine threaded carriage bolts, 65 nuts & lock washers, 21 large flat washers, & 6 small washers. Placement instructions are included.

48-56	PU	7C-8112615-PF, plainkit.	37.50
48-56	PU	7C-8112615-CC, chrome.....kit.	72.50
48-56	PU	7C-8112615-SS, stainlesskit.	70.00
48-56	PU	7C-8112615-SSP, polished stainlesskit.	95.00

Bed Strip & Wood Bolt Kit for 8' Bed

53-56	PU	BAAA-8112615-PF, plain.....kit.	42.50
53-56	PU	BAAA-8112615-CC, chromekit.	72.50

BED RIVETS

Bed Rivet Kit

31-56	PU	RIVET-KITkit.	30.00
-------	----	---------------------	-------

Bed Rivet Setting Tool



31-56	PU	RIVET-TOOL-A-1/4, 1/4", air poweredea.	20.00
31-56	PU	RIVET-TOOL-A-3/8, 3/8", air poweredea.	20.00
31-56	PU	RIVET-TOOL-M-1/4, 1/4", manualea.	12.00
31-56	PU	RIVET-TOOL-M-3/8, 3/8", manualea.	12.00

**Section 58
Woodye/Wagon**

BOOKS

Famous Ford Woodyes

Another excellent book by Lorin Sorensen. Includes history on 1929-51 Ford and Mercury Woodyes with factory photos in black and white and color. Technical data and information make this a must have for any wood restorer. Hardcover.



MB-136890-C

MB-136890-C, 248 pagesea. 49.95

Ford Station Wagons Photo History

From the Model T to the Pinto Cruising Wagon, this book chronicles Ford's wagons.

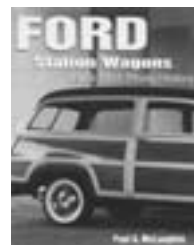

MB-136385-AE

29-91 Wagon MB-136385-AE, 120 pgsea. 24.95

SCUFF PLATES

Door Scuff Plates

1949-51 Scuff plates can take 6-9 months to get if out of stock.

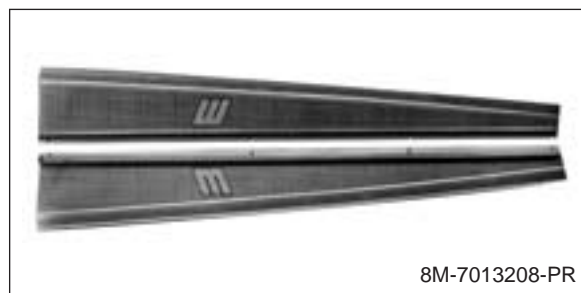

41-48	Wagon	11A-7013250/51, front, 43" trim to fitpr.	70.00
41-48	Wagon	11A-7313262/63, rear, 23-3/8"pr.	70.00
49	Wagon	8A-7913208-PRpr.	320.00
50	Wagon	0A-7913208-PRpr.	320.00
51	Wagon	1A-7913208-PRpr.	320.00
41-48	Merc Wgn	11A-7013250/51, front, 43", trim to fitpr.	70.00
41-48	Merc Wgn	11A-7313262/63, rear, 23-3/8"pr.	70.00
49-51	Merc Wgn	8M-7013208-PR.....pr.	320.00



MIRROR

For original style mirrors see section 32.

Swan Neck Style Mirror

This is the type used on 1949-51 wagons. Mounts in the corner of the front door by removing the original blind nut. Must remove studs included with mirrors and replace with new bolts from a hardware store.



All Pass & PU HR-18414-PR, round headpr. 100.00

TRIM

Windshield Trim

Polished stainless. Includes right & left hand trim with joint clips and screws. These are in limited supply.

37-40 Wagon 78-741234/5-Kpr. 395.00

Windshield Division Bar

Polished stainless steel.

41-48 Wagon 11A-7003078-Bea. 50.00

49-51 Wagon 8A-7903078ea. 105.50

41-48 Merc Wgn 11A-7003078-Bea. 50.00

Interior Windshield Division Bar

49-51 Wagon 0A-7903076-APea. 111.50

Belt Line Trim

Sets of 4, includes mounting hardware

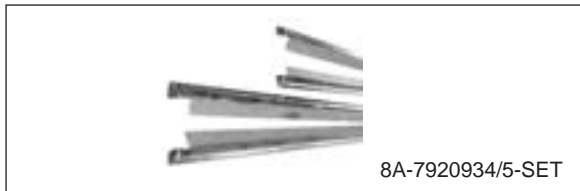

*49-51 Wagon 8A-7920934/5-SETset. 495.00

*49-51 Merc Wgn 8M-7920934/5-SETset. 495.00

Door Emblem

51-54 Wagon 1A-7920978-PR, 2 pr required "Country Squire"pr. 150.00

Tail Light Bracket Trim

Stainless trim on top of tail light bracket.



49-51 Wagon 8A-13476ea. 30.00

WIPER

Wiper Pivot Bezels



49-51 Wagon 8A-17515-B, includes nuts and padspr. 60.00

DOOR HARDWARE

Door Latches



50-51 Wagon 0A-7021812, RH, NOSea. 60.00

50-51 Wagon 0A-7021813, LH, NOSea. Call

Door Latch Covers

Fit front or rear doors.



42-48 Wgn 21A-7926414-PRpr. 50.00

42-48 Merc Wgn 21A-7926414-PRpr. 50.00

Door Striker Plate

41-48 Wagon 01A-7022008ea. 20.00



41-48 Wagon 01A-7022008-C, chromeea. 16.00

50-51 Wagon 8A-7022008, RHea. 20.00



50-51 Wagon 8A-7022009, LHea. 20.00

41-48 Merc Wgn 01A-7022008ea. 20.00

41-48 Merc Wgn 01A-7022008-C, chromeea. 16.00

Female Dovetail

33-39 Wagon 40-35576-BS, black, front or rearpr. 30.00

33-39 Wagon 40-35576-SS, stainless, front or rearpr. 35.00

40 Wagon 40-35576-BS, black, frontpr. 30.00

40	Wagon	40-35576-SS, stainless, front.....pr.	35.00
41-48	Wagon	40-35576-BS, black, front or rearpr.	30.00



41-48	Wagon	40-35576-SS, stainless, front or rear.....pr.	35.00
41-48	Merc Wgn	40-35576-BS, black, front or rearpr.	30.00
41-48	Merc Wgn	40-35576-SS, stainless, front or rear.....pr.	35.00

Male Dovetail



33-48	Wagon	B-46421-A, front door.....ea.	10.00
33-39	Wagon	B-46421-A, rear doorea.	10.00
39-40	Wagon	91A-7923006-A, rear door, replacement type.....ea.	5.00
41-48	Wagon	B-46421-A, rear doorea.	10.00
41-48	Merc Wgn	B-46421-A, front or rearea.	10.00

Door Bumpers

32-39	Wagon	B-151444ea.	3.00
-------	-------	-------------------	------

STONE GUARD

Rear Fender Stone Guards

Rubber bonded to metal, like original. Limited supply available.

42-48	Wagon	51A-16349-50-Bpr.	325.00
42-48	Merc Wgn	51A-16349-50-Bpr.	325.00

TAIL LIGHT BRACKET

Tail Light Bracket Assembly

Includes tail light, license plate bracket and light.



42-48	Wagon	21A-13470-W, RH.....ea.	310.00
42-48	Wagon	21A-13471-W, LH.....ea.	310.00
42-48	Merc Wgn	21A-13470-W, RH.....ea.	310.00
42-48	Merc Wgn	21A-13471-W, LH.....ea.	310.00

Original Style Tail Light Assembly

Includes 12 volt light bulb.

32-42	Wgn	B-13402-DR, RH.....ea.	30.00
32-42	Wgn	B-13403-DL, LH.....ea.	30.00

46-48	Wgn	48-13402-DR, RHea.	30.00
46-48	Wgn	48-13403-DL, LH.....ea.	30.00

Stainless Tail Light Assembly

Will fit stock tail light brackets. Includes 12 volt bulb.

32-42	Wagon	18-13402-DR, RHea.	30.00
32-42	Wagon	18-13403-DL, LH.....ea.	30.00
46-48	Wagon	40-13402-DR, RHea.	30.00
46-48	Wagon	40-13403-DL, LH.....ea.	30.00

Tail Light Bracket Hinge Assembly

Mounts the tail light to the tailgate.



41-48	Wagon	11A-13425, RH or LH.....ea.	100.00
41-48	Merc Wgn	11A-13425, RH or LH.....ea.	100.00

Tail Light Bracket Support Assembly

Mounts to the tail light bracket assembly and to the lower tailgate to keep the tail light straight when the tailgate is lowered.



41-48	Wagon	11A-13470-A, RH or LHea.	100.00
41-48	Merc Wgn	11A-13470-A, RH or LHea.	100.00

TAILGATE & LIFTGATE PARTS

Rear Window Frame

Made out of steel like original. Includes upper hinge. Rubber seals and glass setting tape are NOT included.

*37-39	Wagon	78-796154/6.....ea.	700.00
--------	-------	---------------------	--------

Tailgate Bumpers



34-37	Wagon	46-865711-S.....pr.	30.00
39-41	Wagon	91A-7943916pr.	20.00
42-48	Wagon	21A-7943916pr.	20.00
41	Merc Wgn	91A-7943916pr.	20.00
42-48	Merc Wgn	21A-7943916pr.	20.00

Lower Tailgate Counter Balance Spring

35-48	Wagon	68-795720, 1 requiredea.	103.00
41-48	Merc Wgn	68-795720, 1 requiredea.	103.00



Lower Tailgate Supports

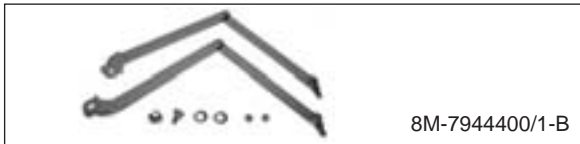

49-50 Wagon 8M-7944400/1-B, early 50 with wood on gate.....pr. 265.00



50-51 Wagon 0A-7944400/1-A, late 50, all steel tailgatepr. 315.00
 49-50 Merc Wgn 8M-7944400/1-B, early 50 with wood on gate.....pr. 265.00
 50-51 Merc Wgn 0A-7944400/1-A, late 50, all steel tailgatepr. 315.00

Lower Tailgate Hook

Polished stainless steel with stainless hardware.



50-51 Merc Wgn 0A-7944434/5pr. 132.00
 50-51 Wagon 0A-7944434/5pr. 132.00

Lower Tailgate Hook Catch Brackets

Mounts to lower tailgate, has hole where the hook goes through to hold the lower tailgate closed. Polished stainless steel. Includes mounting hardware.



50-51 Wagon 0A-7944424-PRpr. 60.00
 50-51 Merc Wgn 0A-7944424-PRpr. 60.00

Liftgate Swing Arm Bracket Assembly



37-48 Wagon 78-796122pr. 77.50
 41-48 Merc Wgn 78-796122pr. 77.50

Tailgate Stainless Upper Lift Arm

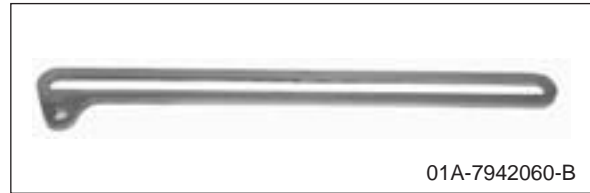

37-48 Wagon 01A-7942060-B, 11-3/4"pr. 125.00
 40-48 Wagon 01A-7942060-S, 9-1/8"pr. 60.00
 41-48 Merc Wgn 01A-7942060-S, 9-1/8"pr. 60.00
 41-48 Merc Wgn 01A-7942060-B, 11-3/4"pr. 125.00

Liftgate Swing Arm Bracket on Liftgate

Includes screw to attach swing arm to bracket.



40-48 Wagon 01A-7942062pr. 75.00
 41-48 Merc Wgn 01A-7942062pr. 75.00

Tailgate Support Rod Anti-Rattler



40-48 Wagon 01A-7944412pr. 8.00
 41-48 Merc Wgn 01A-7944412pr. 8.00

Tailgate Inside Rubber Bumpers



49-51 Merc Wgn 0A-7940741pr. 10.00
 49-51 Wagon 0A-7940741pr. 10.00

Rear Lamp Rubber Bumpers

Mounts on outside of tailgate for tail light arm to rest on.



49-51 Merc Wgn 352394-Spr. 10.00
 49-51 Wagon 352394-Spr. 10.00

BLIND NUTS

Polished Solid Stainless Wood Finish Blind Nut

Sold in sets of 10 pieces.



Wagon	352353-S25, 5/16-18 thread, with 10/16" shaft	set.	40.00
Wagon	352353-S25SC, 5/16-18 thread, with .37" shaft.....	set.	40.00
Wagon	352353-S25SF, 5/16-24 thread, with .37" shaft.....	set.	40.00
Merc Wgn	352353-S25, 5/16-18 thread, with 10/16" shaft	set.	40.00
Merc Wgn	352353-S25SC, 5/16-18 thread, with .37" shaft.....	set.	40.00
Merc Wgn	352353-S25SF, 5/16-24 thread, with .37" shaft.....	set.	40.00

Polished Solid Stainless Wood Finish Blind Nut

Sold each.

Wagon	352353-S25-EA, 5/16-18 thread, with 10/16" shaft	ea.	4.50
Wagon	352353-S25SC-EA, 5/16-18 thread, with .37" shaft.....	ea.	4.50
Wagon	352353-S25SF-EA, 5/16-24 thread, with .37" shaft.....	ea.	4.50
Merc Wgn	352353-S25-EA, 5/16-18 thread, with 10/16" shaft	ea.	4.50
Merc Wgn	352353-S25SF-EA, 5/16-24 thread, with .37" shaft.....	ea.	4.50
Merc Wgn	352353-S25SC-EA, 5/16-18 thread, with .37" shaft.....	ea.	4.50

Blind Nut Kits

Sold in kits for the whole car. These blind nuts have a stainless cap.

37-39	Wagon	81A-352353-KIT, 45 pieces.....	kit.	135.00
40	Wagon	01A-352353-KIT, 50 pieces.....	kit.	150.00
41-48	Wagon	11A-352353-KIT, 70 pieces.....	kit.	210.00
49-50	Wagon	8A-352353-WKIT, with wood tailgate, 68 pieces	kit.	204.00
50-51	Wagon	8A-352353-MKIT, with metal tailgate, 56 pieces	kit.	168.00
41-48	Merc Wgn	11A-352353-KIT, 70 pieces.....	kit.	210.00
49-50	Merc Wgn	8A-352353-WKIT, with wood tailgate, 68 pieces	kit.	204.00
50-51	Merc Wgn	8A-352353-MKIT, with metal tailgate, 56 pieces	kit.	168.00

Stainless Cap Blind Nuts

41-48	Merc Wgn	352353-SC, .95", 4 required.....	ea.	3.00
41-48	Wagon	352353-SC, .95", 4 required.....	ea.	3.00

Wood Finish Blind Nuts with Chrome Caps

Wagon	350967-S23, 10 pcs., 5/16 - 18 thread, with 5/16" shaft	set.	40.00
Merc Wgn	350967-S23, 10 pcs., 5/16 - 18 thread, with 5/16" shaft	set.	40.00

GUTTER CLIPS

Rain Gutter Molding Clips with Screws



38-48	Wagon	81A-63266-BR	set.	32.00
41-48	Merc Wgn	81A-63266-BR	set.	32.00

DOME LIGHT

Dome Light Assembly



28-48	Wgn	A-13771, w/o switch	ea.	45.00
28-48	Wgn	A-13771-WS, w/switch	ea.	52.00

Dome Light Housing & Lens



49-51	Wagon	BAAA-13786-NH, chrome.....	ea.	40.00
49-51	Merc Wgn	BAAA-13786-NH, chrome.....	ea.	40.00

INSIDE HANDLE

Inside Front Door Handle



36	Wagon	68-7622600	pr.	24.00
37-39	Wagon	68-792400-PR	pr.	170.00
40	Wgn	91A-7022600-A	ea.	15.00
41-48	Wgn	11A-702400	ea.	15.00
49	Wagon	8A-7022614-A	ea.	15.00



50	Wagon	0A-7022614-B.....ea.	15.00
51-56	Wagon	B5A-7022600-A.....ea.	25.00

Front Door Escutcheon

40	Wagon	91C-8122618, stainless, for door handle only.....ea.	8.00
51	Wagon	1A-7922618, butterscotch.....ea.	12.50
51	Merc Wgn	1A-7922618, butterscotch.....ea.	12.50

Window Crank Handle Shaft

42-48	Merc Wgn	21A-7923205-S, front or rear.....ea.	25.00
42-48	Wagon	21A-7923205-S, front or rear.....ea.	25.00

Inside Rear Door Handle

36-48	Wagon	68-792400-PR.....pr.	170.00
41-48	Merc Wgn	68-792400-PR.....pr.	170.00

Upper Tailgate Inside Handle



49-51	Wagon	A-702400-C.....ea.	10.00
-------	-------	--------------------	-------

OUTSIDE HANDLE

Tailgate Outside Handle



38-39	Wagon	48-702352-B, locking.....ea.	37.00
-------	-------	------------------------------	-------

Tailgate Handle Pad



38-48	Wagon	B-41648.....ea.	4.00
41-48	Merc Wgn	B-41648.....ea.	4.00

License Plate Light to Tailgate Pad



55-56	Wagon	B5A-13572-B.....ea.	15.00
-------	-------	---------------------	-------

SLIDING HANDLES

Stainless Sliding Door & Quarter Window Handles

49-Early 50 rear quarter window handles must be drilled for locks.
38-48 Wagon 81A-793775-EA.....ea. 25.00



38-48	Wagon	81A-793775-A, 4 pcs.set.	80.00
49-51	Wagon	7A-7929754-A.....pr.	40.00
41-48	Merc Wgn	81A-793775-EA.....ea.	25.00
41-48	Merc Wgn	81A-793775-A, 4 pcs.set.	80.00



49-51	Merc Wgn	7A-7929754-A.....pr.	40.00
-------	----------	----------------------	-------

Chrome Sliding Quarter Window Handle Locks



46-48	Wagon	81A-793796, 4 pcs.....set.	200.00
-------	-------	----------------------------	--------



49-50	Wagon	7A-7929670, early 50, rear, 2 req.....ea.	40.00
-------	-------	---	-------



49-51	Wagon	7A-7929668, front, 2 req.....ea.	40.00
46-48	Merc Wgn	81A-793796, 4 pcs.....set.	200.00
49-50	Merc Wgn	7A-7929670, early 50, rear, 2 req.....ea.	40.00
49-51	Merc Wgn	7A-7929668, front, 2 req.....ea.	40.00

FELT KITS

Front Door Window Felt Kit

Includes complete division bar with back edge of vent seal, upper u-channel, and anti-rattlers for both doors.

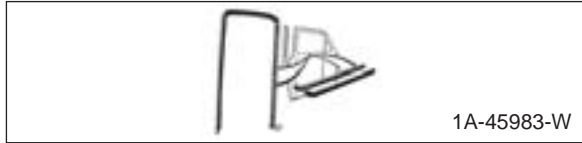

1A-45983-W

- 50-51 Wagon 1A-45983-Wkit. 215.00
- 50-51 Merc Wgn 1A-45983-Wkit. 215.00

Quarter Window Felt Kit

Includes sliding window u-channels, vertical anti-rattler, and rubber u-channel that goes around rear quarter window.



0A-56786-WK

- 50-51 Wagon 0A-56786-WK, Late 50kit. 300.00

Sliding Quarter Window Glass Bumper Stop

Mounts in slide channel at rear.

- 50-51 Wagon 357385-Spr. 10.00
- 50-51 Merc Wgn 357385-Spr. 10.00

Division Bar U-Channel Felt

- 46-48 Wagon 51A-7022296-U, 96"ea. 40.00
- 46-48 Merc Wgn 51A-7022296-U, 96"ea. 40.00

Front Door Glass Channel

Metal channel that holds the glass.

- 41-48 Wgn 11A-7921462, RHea. 35.00
- 41-48 Wgn 11A-7921463, LHea. 35.00
- 41-48 Merc Wgn 11A-7921462, RHea. 35.00
- 41-48 Merc Wgn 11A-7921463, LHea. 35.00

RUBBER SEALS

See section 39 for Windshield seals

Upper Tailgate Window Seals

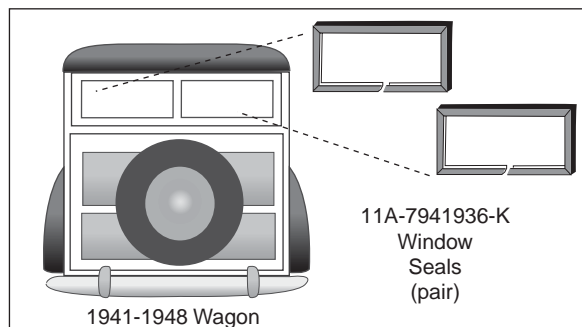

11A-7941936-K
Window
Seals
(pair)

1941-1948 Wagon

- 41-48 Wagon 11A-7941936-Kpr. 35.00
- 49-50 Wagon 7A-7941954-A, early 50pr. 50.00
- 50-51 Wagon 0A-7941954, late 50pr. 50.00
- 41-48 Merc Wgn 11A-7941936-Kpr. 35.00

- 49-50 Merc Wgn 7A-7941954-A, early 50pr. 50.00
- 50-51 Merc Wgn 0A-7941954, late 50pr. 50.00

Tailgate and Rear Lift Window Seal Kit

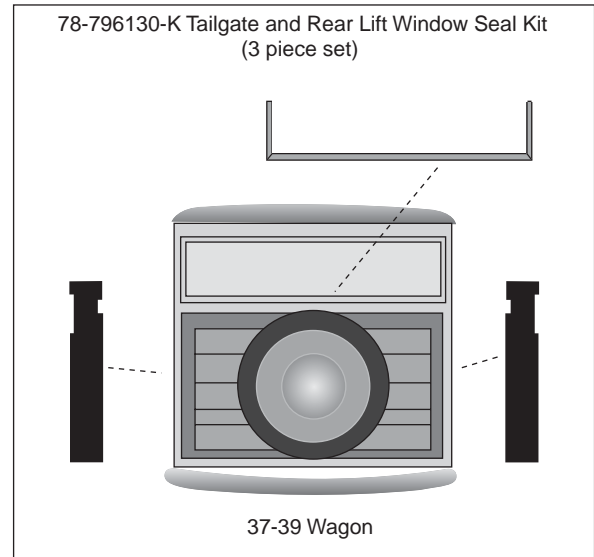

78-796130-K Tailgate and Rear Lift Window Seal Kit
(3 piece set)

37-39 Wagon

- 37-39 Wagon 78-796130-K, 2 tailgate sides,
1 U-shape window bottom,
brown rubberkit. 125.00

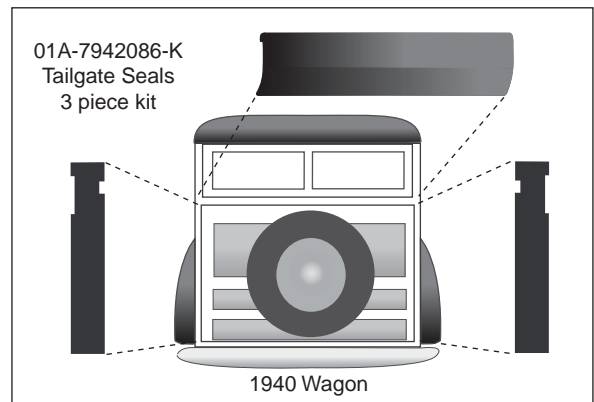

01A-7942086-K
Tailgate Seals
3 piece kit

1940 Wagon

- 40 Wagon 01A-7942086-K, 2 tailgate sides,
1 window bottom,
brown rubberkit. 95.00

1951 Woody



Rich Cravens

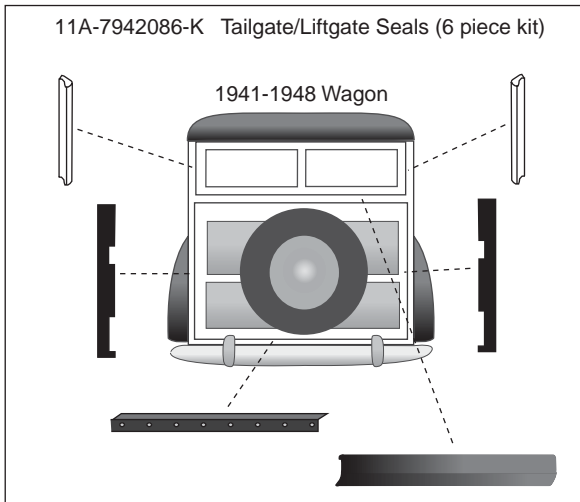

41-48	Wagon	11A-7942086-K, 2 posts, 2 tailgate sides, 1 window bottom, 1 tailgate bottom.....kit.	60.00
41-48	Merc Wgn	11A-7942086-K, 2 posts, 2 tailgate sides, 1 window bottom, 1 tailgate bottom.....kit.	60.00

Liftgate to Body Rubber Seal

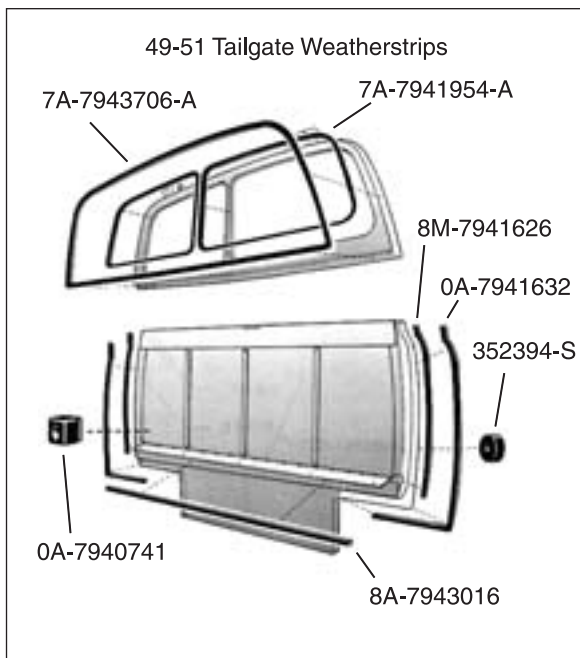

49-51	Wagon	7A-7943706-A, 44 13/16".....ea.	50.00
49-51	Merc Wgn	7A-7943706-A, 44 13/16".....ea.	50.00

Liftgate Top to Body Seal

Goes under metal retainer at hinge on body.

49-51	Wagon	8M-7943706-A.....ea.	10.00
49-51	Merc Wgn	8M-7943706-A.....ea.	10.00

Tailgate Side Seals

49-51	Wagon	8M-7941626, 22 3/8".....pr.	20.00
49-51	Merc Wgn	8M-7941626, 22 3/8".....pr.	20.00

Tailgate Side and Bottom Seal

50-51	Wagon	0A-7941632.....pr.	40.00
50-51	Merc Wgn	0A-7941632.....pr.	40.00

Tailgate Bottom Seal

49-51	Wagon	8A-7943016, 54 1/2".....ea.	10.00
52-56	Wagon	B5A-5941608-D, trim to fit on 52-54.....ea.	50.00
49-51	Merc Wgn	8A-7943016, 54 1/2".....ea.	10.00
52-56	Merc Wgn	B5A-5941608-D, trim to fit on 52-54.....ea.	50.00

Tailgate Upper Seal

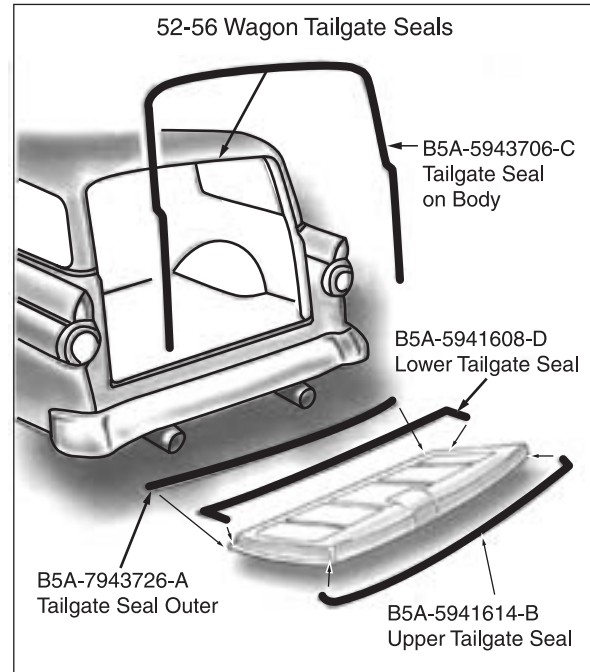

52-56	Wagon	B5A-5941614-B, trim to fit on 52-54.....ea.	60.00
52-56	Merc Wgn	B5A-5941614-B, trim to fit on 52-54.....ea.	60.00

Tailgate Bottom Outer Seal

52-57	Wagon	B5A-5943726-A, 46", trim to fit on 52-54.....ea.	10.00
52-57	Merc Wgn	B5A-5943726-A, 46", trim to fit on 52-54.....ea.	10.00

Tailgate/Liftgate Seal on Body

52-56	Wagon	B5A-5943706-C, trim to fit on 52-54.....ea.	20.00
52-56	Merc Wgn	B5A-5943706-C, trim to fit on 52-54.....ea.	20.00

Vent Window Seal

41-48	Wagon	11A-7021448/9.....pr.	60.00
50-51	Wagon	8M-7921448-PR.....pr.	250.00
41-48	Merc Wgn	11A-7021448/9.....pr.	60.00
50-51	Merc Wgn	8M-7921448-PR.....pr.	250.00

Back Edge of Vent Window Seal

41-42	Wagon	11A-7022296, felt.....pr.	16.00
46-48	Wagon	51A-7022296.....pr.	25.00
50-51	Wagon	0A-7921450-PR.....pr.	30.00

41-42	Merc Wgn	11A-7022296, felt.....pr.	16.00
46-48	Merc Wgn	51A-7022296pr.	25.00
50-51	Merc Wgn	0A-7921450-PRpr.	30.00

Door Seals

1952-56 Wagons see door seal section.

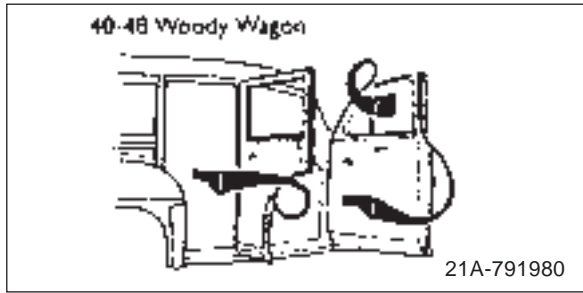

40-48	Wagon	21A-791980, exc. lower seal.....kit.	55.00
49-51	Wagon	8A-7920530-S.....pr.	110.00
41-48	Merc Wgn	21A-791980, exc. lower seal.....kit.	55.00
49-51	Merc Wgn	8A-7920530-S.....pr.	110.00

Lower Door Seal

32-40	Wagon	48-7920706, all 4 doors.....set.	30.00
41-48	Wagon	11A-701980, 3 requiredea.	6.00
41-48	Merc Wgn	11A-701980, 3 requiredea.	6.00

Door & Quarter Window Glass to Wood Seal

"T" Shaped rubber, sold in 50 foot length.



49-51	Merc Wgn	8M-7920902.....kit.	30.00
49-51	Wagon	8M-7920902.....kit.	30.00

Outside Door Handle Pads



32-34	Wagon	B-46212.....pr.	5.00
35-40	Wagon	48-702356pr.	6.00
41-48	Wagon	11A-7922428-Rset.	20.00
50-51	Wagon	0M-7222428.....pr.	9.00
41-48	Merc Wgn	11A-7922428-Rset.	20.00
50-51	Merc Wgn	0M-7222428.....pr.	9.00

Inside Door Handle Escutcheon Pads

41-48	Merc Wgn	11A-7923465-K.....kit.	20.00
41-48	Wagon	11A-7923465-K.....kit.	20.00

Rear Interior Trim Panel to Floor Trim Strip

Brown vinyl like original. Sold in 20 foot lengths, enough for one car.

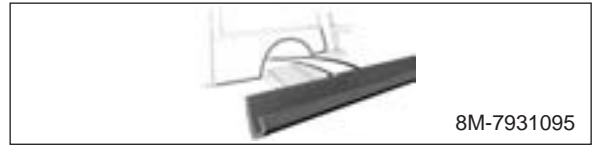

49-51	Merc Wgn	8M-7931095ea.	40.00
49-51	Wagon	8M-7931095ea.	40.00

Gas Neck Grommet

35-37	Wgn	48-9081.....ea.	15.00
49-51	Wgn	0A-9084.....ea.	25.00
49-51	Merc Wgn	0A-9084.....ea.	25.00

Gas Filler Neck to Floor Seal

50-51	Merc Wgn	7A-9072-B.....ea.	10.00
50-51	Wagon	7A-9072-B.....ea.	10.00

CHECK STRAPS

Brown Rubber Door Check Strap



32-36	Wagon	B-151587, 6-1/8", front or rearpr.	27.00
37-39	Wagon	B-151587, 6-1/8", front.....pr.	27.00
37-39	Wagon	78-794400, 5-1/8" , rear.....pr.	27.00
40	Wagon	B-151587, 6-1/8", front or rearpr.	27.00
41-48	Wagon	11A-7923504, 7-1/8" front or rearpr.	30.00
41-48	Merc Wgn	11A-7923504, 7-1/8" front or rearpr.	30.00

Black Rubber Door Check Strap

32-48	Wagon	B-162592-L6, 6".....ea.	4.50
32-48	Wagon	B-162592-L7, 7".....ea.	4.50
32-48	Wagon	B-162592-L8, 8".....ea.	4.50

Door Check Strap Bracket

32-48	Wagon	B-42150-B, chromeea.	4.00
-------	-------	----------------------------	------



41-48	Merc Wgn	B-42150-B, chromeea.	4.00
-------	----------	----------------------------	------

MATS

Front Floor Mat

33-34	Wagon	A-4003, taupe, 2 pcs.....ea.	175.00
35	Wagon	A-4006, blackea.	137.00
35	Wagon	A-4002, taupeea.	175.00
36	Wagon	A-4001, blackea.	137.00



37-39	Wagon	A-4007, black	ea.	137.00
40	Wagon	A-4008, black	ea.	137.00
41-48	Wagon	A-4010, black	ea.	137.00
41-48	Merc Wgn	A-4010, black	ea.	137.00

Behind Front Seat Mat

*41-48	Wagon	A-2581, black	ea.	149.95
*41-48	Merc Wgn	A-2581, black	ea.	149.95

Rear Deck Mat

*41-48	Merc Wgn	A-2582, black	ea.	179.95
*41-48	Wagon	A-2582, black	ea.	179.95

COLLECTIBLES

1/43 Die Cast Collectible



48	Wagon	ACC-94251-BU, burgundy	ea.	7.00
48	Wagon	ACC-94251-T, turquoise.....	ea.	7.00

1/18 Die Cast

Wagon models include surf board. Sportsman models include top and top boot.



46	Sportsman	ACC-46SPT-B, burgundy	ea.	64.95
----	-----------	-----------------------------	-----	-------



48	Wagon	ACC-48WDY-B, burgundy	ea.	61.50
48	Wagon	ACC-48WDY-C, cream	ea.	61.50

Wavecrest Poster

Poster from the annual woodie show in Encinitas California. 24" x 18".

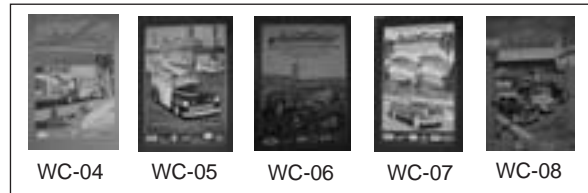

WC-03, 2003	ea.	30.00
WC-04, 2004, 25th annual	ea.	25.00
WC-05, 2005	ea.	20.00
WC-06, 2006	ea.	15.00
WC-07, 2007	ea.	15.00
WC-08, 2008	ea.	15.00

**Section 59
Street Rod**

STEERING

Steering Wheel

40	Dlx Pass	01A-3600-SR, 15", only fits GM steering column.....	ea.	290.00
----	----------	---	-----	--------

SPRING PARTS

Stainless Spring Shackle Kits

Polished stainless with urethane bushings. Sold in pairs.



All	Pass & PU	HR-BD-2630-S, 1-3/4" wide	pr.	60.00
All	Pass & PU	HR-BD-2632-S, 2" wide.....	pr.	60.00
All	Pass & PU	HR-BD-2634-S, 2-1/4" wide	pr.	60.00

Front Spring U-Bolt Kit

Polished stainless. Made for hot rods using traditional style spring. Will fit up to 2-3/8" wide cross member.



All	HR-410-K	kit.	109.00
-----	----------------	------	--------

Shackle Bushings

Urethane bushings, sold in set of 8.

35-40	Pass	BD-2633-BS, for 2" wide	kit.	20.00
35-41	PU	BD-2633-BS, for 2" wide	kit.	20.00

Leaf Spring Clamp

Polished stainless steel with tapered head bolts with nylon lock nuts.

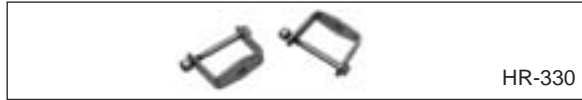

All	Pass & PU	HR-330, 1-3/4" wide.....pr.	30.00
All	Pass & PU	HR-331, 2" wide.....pr.	30.00
All	Pass & PU	HR-332, 2-1/4" wide.....pr.	30.00

SHOCK KIT

Highboy Front Upper Shock Mounts

Bolts to the side of frame. Works on boxed or non-boxed frames. Includes mounting hardware and upper shock bushings. Made of solid stainless.

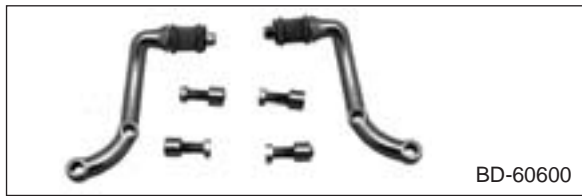

All	BD-60600.....pr.	150.00
-----	------------------	--------

Front Tube Shock Kits

Designed to bolt in place of original shocks. No welding. Front axle perch bolt is included.



35-36	Pass	48-18124-KITkit.	212.95
37-40	Pass	78-18124-KIT, cannot use original sway bar on 1940.....kit.	212.95
42-48	Pass	11A-18124-KITkit.	212.95
42-48	Merc	11A-18124-KITkit.	212.95
35-36	PU	48-18124-KITkit.	212.95
37-40	PU	78-18124-KIT, cannot use original sway bar on 1940.....kit.	212.95

Rear Tube Shock Kits

Designed to bolt in place of original shocks. No welding. Must remove brake drum to install lower shock bracket.

35-36	Pass	48-18125-KITkit.	212.95
37-40	Pass	78-18125-KITkit.	212.95
41-48	Pass	11A-18125-KITkit.	212.95
41-48	Merc	11A-18125-KITkit.	212.95
35-36	PU	48-18125-KITkit.	212.95

37-41	PU	78-18125-KITkit.	212.95
-------	----	------------------------	--------

SWAY BAR KIT

Stabilizer Bar/Sway Bar Kit

For use on 1940-48 cars, and 1940-41 pick-ups when using front tube shock kit. Includes 1" sway bar; urethane bushings and end links to mount to the replacement axle bolts that are included in the front shock kit. 1942-48 cars need modification to mount on frame.

40-48	Pass	01A-3535-STea.	212.95
40-41	PU	01A-3535-STea.	212.95

FRAME

Universal Body to Frame Pads

Perfect for a street rod or hot rod project, or for any make of car or truck. All pads are round 2" diameter with a 3/8" hole in the center. Pads have inter-locking grooves so they can be stacked. Sold in sets of 25 pieces. Also available in a 50 piece variety kit that includes 10 of each size.

All	BD-5001-A, 1/8" thickset.	25.00
All	BD-5001-B, 3/16" thick.....set.	25.00
All	BD-5001-C, 1/4" thick.....set.	25.00
All	BD-5001-D, 5/16" thick.....set.	30.00
All	BD-5001-E, 3/8" thick.....set.	30.00
All	BD-5001-K, 50 piece variety, 10 of each sizekit.	50.00

Body to Frame Rubber Liner

Rubber extrusion perfect for early Fords that want to use something different than webbing. Can be layered to help with shimming. Has a peel-n-stick adhesive backing.

All	BD-5010-A, 1/8" x 2" x 25'.....kit.	50.00
-----	-------------------------------------	-------

Frame Spreader Bar

Polished Stainless with hardware.

32	Pass	B-5041-SS, front, straightea.	95.00
32	Pass	HR-1111, front, "V" shapeea.	140.00
33-34	Pass	HR-1115, front, "V" shapeea.	165.00
32	Pass	B-18575-SB, rear.....ea.	130.00
32	PU	B-18575-SB, rear.....ea.	130.00

Bolt In Crossmember Kit

Converts your stock crossmember so you can use any modern stick or automatic. Complete with hardware and instructions.



*35-40	Pass	HR-48-5025ea.	529.95
*35-41	PU	HR-48-5025ea.	529.95



RUBBER

Universal Sponge Seal-Hollow Core

Half round hollow core seal perfect for any universal application. Sold in 8 and 20 foot lengths.

All	FG-300-8, 7/32" high, 3/8" wide, 8' length.....ea.	15.00
All	FG-300-20, 7/32" high, 3/8" wide, 20' length.....ea.	25.00
All	FG-350-8, 3/8" high, 5/8" wide, 8' length.....ea.	20.00
All	FG-350-20, 3/8" high, 5/8" wide, 20' length.....ea.	30.00

Universal Sponge Seal-Solid Ribbed

Square seal with a ribbed top seal perfect for any universal application. Sold in 8 and 20 foot lengths.

All	FG-200-8, 3/16" high, 3/8" wide, 8' length.....ea.	15.00
All	FG-200-20, 3/16" high, 3/8" wide, 20' length.....ea.	25.00
All	FG-250-8, 3/8" high, 5/8" wide, 8' length.....ea.	20.00
All	FG-250-20, 3/8" high, 5/8" wide, 20' length.....ea.	30.00

ENGINE

Cylinder Head Bolt/Stud Chrome Acorn Nut Covers



All	Pass	A-6040, acorn nut 5/8".....ea.	.75
32-53	Pass	3123-B, 48 pcs., V-8, 11/16".....set.	30.00
32-53	Pass	3123-B-EACH, V-8.....ea.	.75
39-53	Merc	3123-B, 48 pcs. 11/16".....set.	30.00
39-53	Merc	3123-B-EACH.....ea.	.75
All	PU	A-6040, acorn nut 5/8".....ea.	.75
32-53	PU	3123-B, 48 pcs., V-8, 11/16".....set.	30.00
32-53	PU	3123-B-EACH, V-8.....ea.	.75

Intake Manifold Bolt Chrome Acorn Nut Covers



32-53	Pass	34711-C, set of 20.....set.	12.00
39-53	Merc	34711-C, set of 20.....set.	12.00
32-53	PU	34711-C, set of 20.....set.	12.00

HEADERS

Cast Iron Headers

Includes mounting gasket. Must bend dip stick tube to fit.

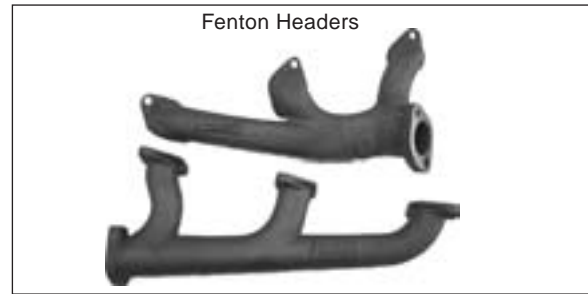

32-53	Pass	FENTON-HEADERS, V-8.....pr.	309.95
32-53	PU	FENTON-HEADERS, V-8.....pr.	309.95

Front Header Extension for Fenton Headers

36-40	Pass	FENT-EXT-48.....pr.	100.00
41-48	Pass	FENT-EXT-11A.....pr.	100.00
49-51	Pass	FENT-EXT-8A.....pr.	100.00
52-53	Pass	FENT-EXT-BA.....pr.	100.00
41-48	Merc	FENT-EXT-11A.....pr.	100.00
52-53	Merc	FENT-EXT-BA.....pr.	100.00
36-40	PU	FENT-EXT-48.....pr.	100.00

Tube Headers

These do not require dip stick tube bending.



32-34	Pass	B-9430-PR, V-8.....pr.	190.00
32-34	Pass	B-9430-A, V-8, w/48-52 PU box.....pr.	215.00
32-34	Pass	B-9430-B, V-8, w/53-56 PU box.....pr.	215.00
35-38	Pass	48-9430-PR, V-8.....pr.	215.00
39	Std Pass	48-9430-PR, V-8.....pr.	215.00
39	Dlx Pass	91A-9430-PR, V-8.....pr.	190.00
40	Pass	91A-9430-PR, V-8.....pr.	190.00
41-48	Pass	21A-9430-PR, V-8.....pr.	190.00
49-51	Pass	8A-9430-PR, V-8, except conv and wagon.....pr.	190.00
49-50	Conv	8A-9430-CNV.....pr.	215.00
52-53	Pass	BA-9430-PR, V-8.....pr.	215.00
54	Pass	B4A-9430-AE, 1-3/4" tube type, V-8.....pr.	258.50
55-58	Pass	B4A-9430-A, 1 3/4" tube , V-8.....pr.	258.50
55-58	Pass	B4A-9430-B, 2" tube , V-8.....pr.	258.50
39-40	Merc	91A-9430-PR, V-8.....pr.	190.00
41-48	Merc	21A-9430-PR, V-8.....pr.	190.00

49-51	Merc	8M-9430-PR, V-8.....pr.	190.00
52-53	Merc	BA-9430-PR, V-8.....pr.	215.00
54-58	Merc	B4A-9430-A, 1 3/4" tube , V-8.....pr.	258.50
54-58	Merc	B4A-9430-B, 2" tube , V-8.....pr.	258.50
55-57	T-Bird	B5S-9430-PR.....pr.	595.00
32-34	PU	B-9430-PR, V-8.....pr.	190.00
35-39	PU	48-9430-PR, V-8.....pr.	215.00
40-41	PU	91A-9430-PR, V-8.....pr.	190.00
42-47	PU	21A-9430-PR, V-8.....pr.	190.00
48-52	PU	B-9430-PR, V-8.....pr.	190.00
48-52	PU	8C-9430-PR, 3 into 1, long tube.....pr.	275.00
53	PU	BA-9430-PR, V-8.....pr.	215.00
*54-64	PU	B4C-9430-PR, V-8, long tube.....pr.	245.00
54-64	PU	B4C-9430-STU, V-8, stubbie.....pr.	245.00

Front Header Extension for Tube Headers



32-34	Pass	B-5246.....pr.	58.50
35-36	Pass	48-5246, w/o stock battery.....pr.	58.50
35-36	Pass	48-5246-WB, w/ stock battery.....pr.	58.50
37-40	Pass	78-5246.....pr.	58.50
41-48	Pass	11A-5246.....pr.	58.50
49-51	Pass	8A-5246.....pr.	58.50
51	Pass	1A-5246, Fordomatic.....pr.	58.50
52-53	Pass	BA-5246.....pr.	58.50
39-40	Merc	78-5246.....pr.	58.50
49-50	Merc	8M-5246.....pr.	58.50
52-53	Merc	BA-5246.....pr.	58.50
32-34	PU	B-5246.....pr.	58.50
35-36	PU	48-5246.....pr.	58.50
37-41	PU	78-5246.....pr.	58.50
48-52	PU	7C-5246.....pr.	58.50
53	PU	BAAA-5246.....pr.	58.50

AIR CLEANER

Chrome Louvered Air Cleaner & Clamp

Fits 97 or 94 carb. Includes filter.



34-56	Pass & PU	HR-9600-L4.....ea.	11.00
-------	-----------	--------------------	-------

Louvered Air Cleaner Filter

34-56	Pass & PU	HR-9600-E.....ea.	4.50
-------	-----------	-------------------	------

ALTERNATOR

6V Alternator w/Bracket Kit

Includes correct pulley for stated application. Can use original fan with 32-39Pass kit. Kits are for V-8 only except 60 HP.

32-38	Pass	18-10300-K6.....kit.	295.00
39	Std Pass	18-10300-K6.....kit.	295.00
39	Dlx Pass	91A-10300-K6.....kit.	235.00
40-41	Pass	91A-10300-K6.....kit.	235.00
42-48	Pass	21A-10300-K6.....kit.	235.00
49	Pass	8A-10300-K6.....kit.	235.00
50-53	Pass	0A-10300-K6.....kit.	260.00
54-55	Pass	B4A-10300-K6.....kit.	295.00
32-39	PU	18-10300-K6.....kit.	295.00
40-41	PU	91A-10300-K6.....kit.	235.00
42-47	PU	21A-10300-K6.....kit.	235.00
48-53	PU	8A-10300-K6.....kit.	235.00
54-55	PU	B4A-10300-K6.....kit.	295.00

12V Alternator w/Bracket Kit

Includes correct pulley for stated application. Can use original fan with 32-39Pass kit. Kits are for V-8 only except 60 HP.

32-38	Pass	18-10300-12V.....kit.	295.00
39	Std Pass	18-10300-12V.....kit.	295.00
39	Dlx Pass	91A-10300-K12.....kit.	235.00
40-41	Pass	91A-10300-K12.....kit.	235.00
42-48	Pass	21A-10300-K12.....kit.	235.00
49	Pass	8A-10300-K12.....kit.	235.00
50-53	Pass	0A-10300-K12.....kit.	260.00
54-55	Pass	B4A-10300-K12.....kit.	295.00
56-62	Pass	B6A-10300-K12, fits 292, 312...kit.	295.00
32-39	PU	18-10300-12V.....kit.	295.00
40-41	PU	91A-10300-K12.....kit.	235.00
42-47	PU	21A-10300-K12.....kit.	235.00
48-53	PU	8A-10300-K12.....kit.	235.00
54-55	PU	B4A-10300-K12.....kit.	295.00
56	PU	B6A-10300-K12.....kit.	295.00



V-8 Alternator Bracket

These fit GM style alternators.



33-41	Pass	B-10313-A	ea.	61.50
42-48	Pass	B-10313-C	ea.	70.00
49-53	Pass	B-10313-B, must modify the alternator on 49 wide belt.....	ea.	61.50
39-41	Merc	B-10313-A	ea.	61.50
42-48	Merc	B-10313-C	ea.	70.00
49-53	Merc	B-10313-B, must modify the alternator on 49 wide belt.....	ea.	61.50
33-41	PU	B-10313-A	ea.	61.50
42-47	PU	B-10313-C	ea.	70.00
48-53	PU	B-10313-B, must modify the alternator on wide belt.....	ea.	61.50

Alternator Pulley

These fit GM style alternators.



32-49	Pass	A-10130-ALT, for wide belt, no provision for a fan	ea.	27.00
50-53	Pass	A-10130-N, for narrow belt 3/8"	ea.	35.00
39-49	Merc	A-10130-ALT, for wide belt, no provision for a fan	ea.	27.00
50-53	Merc	A-10130-N, for narrow belt 3/8"	ea.	35.00
32-53	PU	A-10130-ALT, for wide belt, no provision for a fan	ea.	27.00

GENERATOR/STARTER

Stainless Generator Cover

39-48	Pass	GENCOVER39-48, 2 hole	ea.	31.95
49-53	Pass	GENCOVER49-53, 2 pcs.	ea.	31.95
39-48	Merc	GENCOVER39-48, 2 hole	ea.	31.95
49-53	Merc	GENCOVER49-53, 2 pcs.	ea.	31.95
39-47	PU	GENCOVER39-48, 2 hole	ea.	31.95
48-53	PU	GENCOVER49-53, 2 pcs.	ea.	31.95

Stainless Starter Cover

32-53	Pass	STARTCVR.....	ea.	30.95
39-53	Merc	STARTCVR.....	ea.	30.95
32-53	PU	STARTCVR.....	ea.	30.95

LIGHTS

Dietz Headlights

With 12V sealed beam bulb



28-36	Pass	D-13000-SBC, chrome	pr.	69.00
28-36	Pass	D-13000-SBP, plain.....	pr.	69.00
28-39	PU	D-13000-SBC, chrome	pr.	69.00
28-39	PU	D-13000-SBP, plain.....	pr.	69.00

King Bee Headlights

With 12V halogen bulb



28-36	Pass	KB-13000-QC, chrome.....	pr.	90.00
28-36	Pass	KB-13000-QSS, stainless	pr.	160.00
28-39	PU	KB-13000-QC, chrome.....	pr.	90.00
28-39	PU	KB-13000-QSS, stainless	pr.	160.00

Baby Deuce Headlights

Similar design to 1932 headlights. Polished stainless steel. 7-1/2" Diameter. Includes flex-loom #HR-13020.

All		HR-13000-6, 6 volt	pr.	265.00
All		HR-13000-12, 12 volt	pr.	265.00

Flex-Loom Headlight Conduit

Looks like 32 style headlight conduit. 15" Long, male threads include nuts and washers. Polished stainless.

All		HR-13020, male and female ends	pr.	60.00
All		HR-13020-B, male on both ends	pr.	60.00

Stainless Dropped Headlight Bar

32	Pass	B-13114	ea.	195.00
----	------	---------------	-----	--------

Highboy Headlight Mounts



All		BD-3375-S, mounts headlights to top of weld on shock mounts, polished stainless	pr.	70.00
-----	--	---	-----	-------



All		BD-60500, bolts to top of frame, polished stainless	pr.	125.00
-----	--	--	-----	--------

"Hot Rod" Tail Lights

Chrome plated bezel w/glass lens, rubber pad, & 12V bulb. 4-1/2" Diameter x 1-3/4" high.



- All Pass & PU HR-13405, red lens.....pr. 125.00
- All Pass & PU HR-13405-BD, w/blue dot.....pr. 125.00

"Baby" Hot Rod Tail Lights

Stainless bezel w/glass lens, rubber pad, & 12V bulb. 3-3/4"Diameter x 1" high



- All Pass & PU 6A-13200-T/Lpr. 100.00

Brushed Aluminum Third Brake Light Assembly

- All Pass & PU BA-13613ea. 48.00

FIREWALLS

Street Rod Firewall

Instructions are included. Some trimming may be required for correct fit.

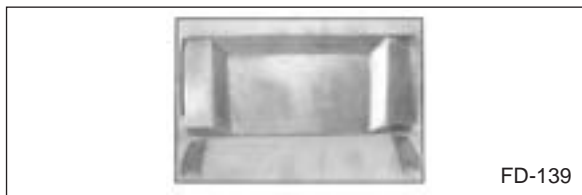

- *32 Pass FD-227, 1-3/4" setback.....ea. 338.00
- *33-34 Pass FD-125, 3" setbackea. 375.00
- *33-34 Pass FD-126, 5" setbackea. 402.00
- *35-36 Pass FD-132, 3" setbackea. 375.00
- *35-36 Pass FD-131, 5" setbackea. 402.00
- *37-40 Pass FD-136, 3" setbackea. 375.00
- *37-40 Pass FD-137, 5" setbackpr. 402.00
- *41-48 Pass FD-139, 2" setbackea. 349.00
- *41-48 Pass FD-140, 4" setbackea. 375.00
- *49-51 Pass FD-254, 3" setbackea. 379.00
- *49-51 Pass FD-253, 4" setbackea. 408.00
- *41-48 Merc FD-139, 2" setbackea. 349.00
- *41-48 Merc FD-140, 4" setbackea. 375.00
- *32 PU FD-227, 1-3/4" setback.....ea. 338.00
- *33-34 PU FD-206, 2" setbackea. 349.00

- *33-34 PU FD-207.....ea. 271.00
- *35-39 PU FD-235, 3" setbackea. 375.00
- *40-47 PU FD-191, 2" setbackea. 343.00
- *40-47 PU FD-246, 4" setbackea. 373.00
- *48-52 PU FD-220, 2" setbackea. 363.00
- *53-56 PU FD-224, 4" setbackea. 442.00

FLOOR PANS

Street Rod Front Floor Kit

These kits are designed for use with the street rod firewalls. Instructions are included. Some trimming may be required for correct fit.



- *32 Pass FD-194.....ea. 251.00
- *33-34 Pass FD-127, use w/3" setback.....ea. 271.00
- *33-34 Pass FD-128, use w/5" setback.....ea. 271.00
- *35-40 Pass FD-134, use w/3" setback.....ea. 275.00
- *35-40 Pass FD-133, use w/5" setbackpr. 275.00
- *41-48 Pass FD-141, use w/2" setback.....ea. 248.00
- *41-48 Pass FD-142, use w/4" setback.....ea. 248.00
- *49-51 Pass FD-251, use w/3" setback.....ea. 475.00
- *49-51 Pass FD-252, use w/4" setback.....ea. 475.00
- *41-48 Merc FD-141, use w/2" setback.....ea. 248.00
- *41-48 Merc FD-142, use w/4" setback.....ea. 248.00
- *32 PU FD-227.....ea. 338.00
- *33-34 PU FD-207.....ea. 271.00
- *35-39 PU FD-236.....ea. 275.00
- *40-47 PU FD-192, use w/2" setback.....ea. 270.00
- *40-47 PU FD-247, use w/4" setback.....ea. 270.00
- *48-52 PU FD-221.....ea. 270.00
- *53-56 PU FD-225.....ea. 276.00

Street Rod Front Floor Kit for Stock Firewall

These kits are designed for use with the stock firewall. Instructions are included. Some trimming may be required for correct fit.

- *32 Pass FD-122.....ea. 251.00
- *33-34 Pass FD-129.....ea. 271.00
- *35-40 Pass FD-135.....ea. 275.00
- *41-48 Pass FD-143.....ea. 248.00
- *33-34 PU FD-270.....ea. 271.00
- *35-39 PU FD-301.....ea. 275.00
- *40-47 PU FD-210.....ea. 270.00
- *48-52 PU FD-265.....ea. 270.00
- *53-56 PU FD-264.....ea. 276.00



Street Rod Toeboard and Extension

Use with stock firewall. Includes transmission hole cover, extension from transmission hole cover to firewall, and left and right toeboards that replace factory wood pieces.

*35-40 Pass	FD-198.....ea.	208.00
*41-48 Pass	FD-243.....ea.	208.00
*41-48 Merc	FD-243.....ea.	208.00

Street Rod Rear Floor Kit

These kits are designed for use with the street rod front floor kits. Instructions are included. Some trimming may be required for correct fit. The 32-34 kits include trunk floor also.



*32 Roadster	FD-188.....ea.	300.00
*32 Cpe 3W	FD-187.....ea.	300.00
*32 Cpe 5W	FD-188.....ea.	300.00
*32 Sdn 2D	FD-189.....ea.	300.00
*32 Sdn 4D	FD-190.....ea.	300.00
*33-34 Pass	FD-130.....ea.	251.00
*35-36 Cpe	FD-195, to seat riser.....ea.	243.00
*35-36 Sdn	FD-193, to seat riser.....ea.	243.00
*37-40 Pass	FD-138, to seat riser.....ea.	176.00
*41-48 Pass	FD-154, to seat riser.....ea.	243.00
*40-47 PU	FD-223, under seat.....ea.	145.00

Street Rod Trunk Floor Kit

These kits are designed for use with the street rod rear floor kits. Instructions are included. Some trimming may be required for correct fit.



*35-36 Cpe	FD-196.....kit.	276.00
*35-36 Sdn	FD-197.....kit.	276.00
*37-40 Pass	FD-197.....kit.	276.00
*41-48 Pass	FD-211.....kit.	197.00

**Section 60
Decals**

DECAL KITS

Decal Detailing Kit

Save up to \$10.00 by buying the decal kit for your car.



52-53 Pass	DK013, V-8, 11 pcs.....kit.	29.00
54 Pass	DK014, V-8, 11 pcs.....kit.	32.00
55 Pass	DK015, V-8, 15 pcs.....kit.	39.00
56 Pass	DK016, V-8, 18 pcs.....kit.	47.00
55 T-Bird	DK35, 10 pcs.....kit.	22.00
56 T-Bird	DK36, 13 pcs.....kit.	22.00
57 T-Bird	DK37, 12 pcs.....kit.	22.00

AIR CLEANER

Dry Type Air Cleaner Decal



33-36 Pass	DF1.....ea.	3.50
37-38 Pass	DF2.....ea.	3.50

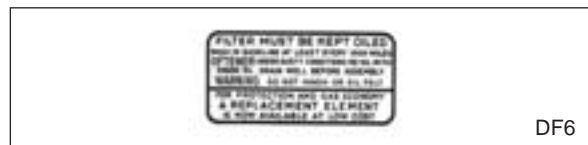

39-41 Pass	DF6, white/black.....ea.	3.50
------------	--------------------------	------

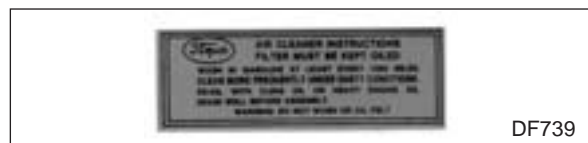

46-48 Pass	DF739.....ea.	3.50
39-41 Merc	DL191.....ea.	3.50
39-41 Merc	DL194, hat style.....ea.	3.50
33-36 PU	DF1.....ea.	3.50

37-38	PU	DF2	ea.	3.50
39-41	PU	DF6, white/black.....	ea.	3.50
46-47	PU	DF739	ea.	3.50

Oil Bath Air Cleaner Decal

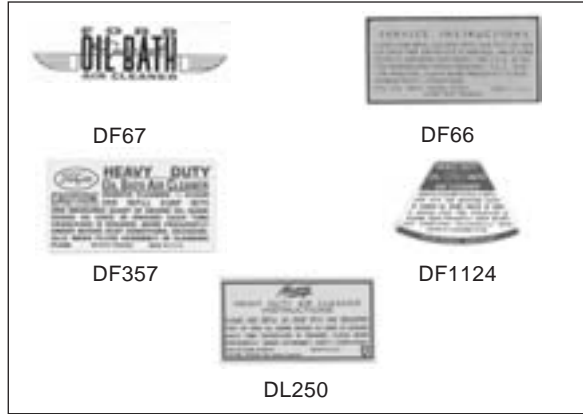

35-40	Pass	DF65, oval, blue & white	ea.	3.50
37-38	Pass	DF462, rectangle	ea.	3.50
39-41	Pass	DF4, rectangle, black&yellow	ea.	3.50
42-48	Pass	DF28	ea.	3.50
37-48	Pass	DF754, heavy duty	ea.	3.50
49-51	Pass	DF143	ea.	3.50
52-53	Pass	DF286, front	ea.	5.50
52-53	Pass	DF287, side.....	ea.	5.50
54	Pass	DF231, front	ea.	5.50
54	Pass	DF232, side.....	ea.	5.50
55-56	Pass	DF66, side.....	ea.	5.50
55-56	Pass	DF67, front	ea.	5.50
39-40	Merc	DL324, heavy duty	ea.	3.50
39-41	Merc	DL192	ea.	3.50
39-48	Merc	DL196, caution	ea.	3.50
46-48	Merc	DL198	ea.	3.50
50-51	Merc	DL250	ea.	4.00
52	Merc	DL325	ea.	4.00
53	Merc	DL350	ea.	4.00
54-55	Merc	DL143	ea.	4.00
56	Merc	DL263	ea.	5.50
35-41	PU	DF4, oval	ea.	3.50
37-38	PU	DF462, rectangle	ea.	3.50
42-47	PU	DF28	ea.	3.50
37-47	PU	DF754, heavy duty	ea.	3.50
48-51	PU	DF357	ea.	3.50
54-56	PU	DF1124	ea.	4.00

VALVE COVER

V-8 Valve Cover Decal

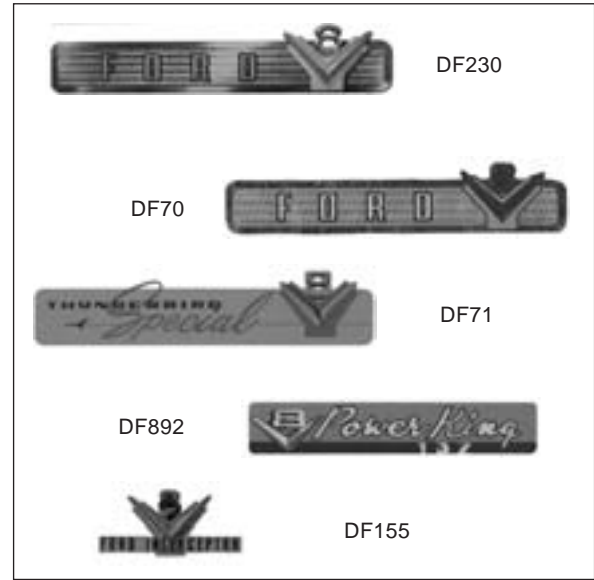

54	Pass	DF230, "Ford V8"	pr.	10.50
54-58	Pass	DF155, Police "Ford Interceptor"	pr.	12.50
55-59	Pass	DF810, Police "Ford interceptor".....	pr.	10.50
55-60	Pass	DF70, 272 & 292, "Ford V8".....	pr.	10.50
56	Pass	DF72, 292 "Thunderbird V8"	pr.	10.50
56	T-Bird	DF72, 292 "Thunderbird V8"	pr.	10.50
57	T-Bird	DF71, "Thunderbird Special" grey, black, and red	pr.	10.50
57	T-Bird	DF136, "Thunderbird Special" clear, white, and red	pr.	10.50
54	PU	DF642, "Power King 130"	pr.	10.50
55	PU	DF892, "Power King 132"	pr.	10.50
55-60	PU	DF70, 272 & 292, "Ford V8".....	pr.	10.50

6 Cyl Valve Cover Decal

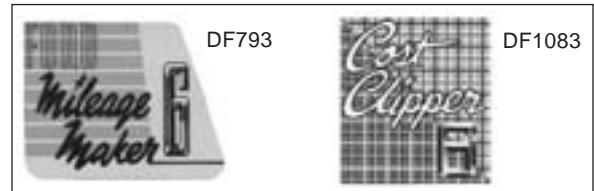

52-54	Pass	DF793, "Mileage Maker"	ea.	5.50
55-56	Pass	DF885, "I-6"	ea.	5.50
55-56	Pass	DF450, "I-Block".....	ea.	5.50
52-56	PU	DF1083, "Cost Clipper"	ea.	6.50
54	PU	DF1299, "Cost Clipper"	ea.	6.50
55-56	PU	DF450, "I-Block".....	ea.	5.50



OIL FILLER CAP

Oil Filler Cap Decal

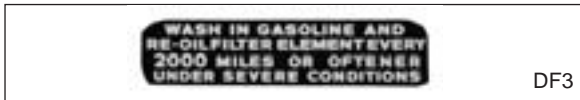

DF3

35-36 Pass & PU DF3ea. 3.50

OIL FILTER

Oil Filter Decal



DF5

DF64

DF82

35-48	Pass	DF5, for "AC" filterea.	4.00
39-48	Pass	DEC-3, water transferea.	3.00
39-51	Pass	DF64, stick-onea.	4.00
52-53	Pass	DF375, V-8set.	10.50
39-40	Merc	DL193ea.	4.00
49-51	Merc	DL618ea.	4.00
52-53	Merc	DL668ea.	5.50
54-56	Merc	DL88ea.	5.50
35-48	PU	DF5, for "AC" filterea.	4.00
39-47	PU	DEC-3, water transferea.	3.00
39-51	PU	DF64, stick-onea.	4.00
52-53	PU	DF375, V-8set.	10.50
54-56	PU	DF82ea.	5.50

GENERATOR/VOLT REGULATOR

Generator Decal

56	Pass	DF68ea.	4.00
56	Merc	DL89ea.	4.00
56	PU	DF68ea.	4.00

Generator Metal Tag with Rivets



CC-101

49-53	Pass	CC-101ea.	6.50
54-55	Pass	CC-102ea.	6.50
48-53	PU	CC-101ea.	6.50
54-55	PU	CC-102ea.	6.50

Generator Warning Tag



DF1125

56-64	All	DF1125ea.	3.50
39-55	Merc	DL616ea.	3.50
56-64	Merc	DL615ea.	3.50

Voltage Regulator Decal

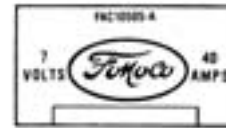

DF109

56-57	Pass	DF32ea.	4.00
52-54	Merc	DL91ea.	4.00
55	Merc	DL163ea.	4.00
56-57	Merc	DL84ea.	4.00
52-54	PU	DF109ea.	4.00
55	PU	DF84ea.	4.00
56-57	PU	DF32ea.	4.00

Voltage Regulator Metal Tag with Rivets



CC-104

49-53	Pass	CC-104ea.	6.50
48-53	PU	CC-104ea.	6.50

IGNITION

Distributor Tag with Rivets



CC-105

49-53	Pass & PU	CC-105, aluminum housingea.	6.50
-------	-----------	--------------------------	----------	------



CC-106

49-53	Pass & PU	CC-106, cast iron housingea.	6.50
-------	-----------	---------------------------	----------	------

Coil Decal

56	Pass	DF33ea.	4.00
56-58	Merc	DL86ea.	4.00
56	PU	DF33ea.	4.00

BATTERY

Power Punch Battery Decal



DZ273

54-55 Pass & PU DZ273ea. 5.00

Battery Warranty Card



DF117

56-57 Pass & PU DF117ea. 3.00

STARTER

Starter Decal



DF131

56-57 Pass DF131ea. 4.00

56-57 Merc DL94ea. 4.00

56-57 PU DF131ea. 4.00

Starter Metal Tag with Rivets

49-55 Pass & PU CC-103ea. 6.50

HEATER/AIR CONDITIONING

Hot Air Heater Decal

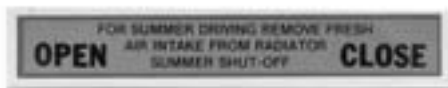

DF126

39-40 Pass DF126ea. 4.00

39-40 Merc DL669ea. 4.00

39-40 PU DF126ea. 4.00

Heater Instruction Tag



DF24

39-40 Pass DF491ea. 4.00

46-48 Pass DF24ea. 3.00

50 Pass DF263ea. 3.00

39 Merc DL129ea. 4.00

40 Merc DL737, hot airea. 4.00

40 Merc DL738ea. 5.00

39-40 PU DF491ea. 4.00

Heater Box Instruction Decal



DF683

52-54 Pass DF683ea. 3.00

55-56 Pass DF38ea. 3.00

50-51 Merc DL658ea. 5.00

52-54 Merc DL292ea. 3.00

55-56 Merc DL200ea. 3.00

55-57 T-Bird DF39ea. 3.00

Heater Door Decal

50-51 Merc DL752ea. 4.00

Heater Control Panel Decal



DF490

53-56 PU DF490, fresh airea. 3.00



DF561

53-56 PU DF561, recirculatingea. 3.50

Antifreeze Tag



DF120

53-66 Pass & PU DF120, "FoMoCo"ea. 3.50

56 Merc DL38ea. 3.50

Air Conditioner Decal

55-56 Pass DF358, compressorea. 4.00

55-56 Merc DL269, compressorea. 4.00

56 Merc DL176ea. 6.50

Air Scoop Removal Decal

55-57 T-Bird DF89ea. 4.00

WINDSHIELD WASHER

Windshield Washer Bottle Decal



DF1160

46-48 Pass DF1160ea. 4.00

46-48 Merc DL727ea. 4.00

Section 60 - Decals



C&G Early Ford Parts, Inc.

49-53 Merc DL295ea. 4.00

Windshield Washer Bottle Bracket Decal



DF623

46-48 Pass DF685ea. 4.00
 49-51 Pass DF687ea. 4.00
 52-54 Pass DF623ea. 4.00
 46-48 Merc DL294ea. 4.00
 49-53 Merc DL149ea. 4.00
 54-58 Merc DL617ea. 4.00
 48-52 PU DF686ea. 4.00

Windshield Washer Lid Decal

54-58 Merc DL368ea. 4.00

RADIO

Radio Instruction Tag



DF23

37-39 Pass DF591ea. 3.50
 46-48 Pass DF23ea. 3.00
 37-39 PU DF591ea. 3.50

Radio Warranty Tag

40 Pass DF21ea. 3.00
 46-48 Pass DF22ea. 3.00
 46-56 Merc DL118ea. 4.00
 52 Merc DL355ea. 4.00
 53-54 Merc DL354ea. 4.00

Radio Schematic Decal

56 Pass DF273ea. 3.00

GLOVE BOX/POLICIES

Glove Box Tire Pressure & Oil Decal



DF128

DF129

41 Pass DF581ea. 3.50
 42 Pass DF674ea. 3.50
 46-48 Pass DF128ea. 4.00
 49-51 Pass DF129ea. 4.00
 52-56 Pass DF94ea. 4.00
 41 Merc DL166ea. 3.50

42 Merc DL184ea. 3.50
 46-48 Merc DL93ea. 4.00
 49-51 Merc DL623ea. 4.00
 52-53 Merc DL315ea. 4.00

Glove Box Automatic Transmission Decal



DF81

55-59 Pass DF81ea. 4.00
 51-57 Merc DL131ea. 4.00
 55-59 PU DF81ea. 4.00

Air Condition Service Glove Box Decal

55 Pass DF359ea. 4.00



DF572

56-59 Pass DF572ea. 4.00
 55 Merc DL270ea. 4.00

Glass Top Glove Box Decal

55-56 Pass DF342ea. 4.00
 55 Merc DL262ea. 4.00

Convertible Top Warning Decal

55-56 Merc DL648ea. 4.00

Folding Top Glove Box Decal

55-57 T-Bird DF90ea. 4.00

Glove Box Engine Oil Decal

55-56 PU DF390ea. 4.00

Glare Proof Mirror Tag

50-56 Pass DF154ea. 3.00
 50-51 Merc DL686ea. 3.00

Prismatic Mirror Instruction Tag

52-57 Merc DL147ea. 3.00

Clock Warranty Tag

37-48 Pass & PU DF11ea. 3.00

Electric Clock Instruction Tag

49-56 Pass DF156ea. 3.50
 49-56 Merc DL687ea. 3.50

Chrome Care Instruction Decal

51-53 Pass DF130ea. 3.00
 49-50 Merc DL685ea. 3.00
 51-52 Merc DL314ea. 4.00
 53 Merc DL348ea. 4.00

New Car Delivery Report

49-51 Pass DF108ea. 3.00
 55-56 Pass DF152ea. 3.00

Service Policy



DL358

39-40	Pass	DF8ea.	3.00
41-48	Pass	DF144ea.	3.00
54-55	Pass	DF445ea.	3.00
51-52	Merc	DL352ea.	4.00
53-54	Merc	DL358ea.	4.00
39-40	PU	DF8ea.	3.00
41-48	PU	DF144ea.	3.00

Tubeless Tire Insert Instructions

54-56	Pass	DF151ea.	3.00
-------	------	-------	----------	------

Tubeless Tire Folder Installation

54-56	Pass	DF121ea.	3.00
-------	------	-------	----------	------

Pre-Delivery Sheet

53-56	PU	DF679ea.	3.00
-------	----	-------	----------	------

Battery Warranty Certificate



DL351

39-53	Pass	DF9ea.	3.00
51-53	Merc	DL351ea.	4.00
39-53	PU	DF9ea.	3.00

TRUNK/JACK

Jack Instruction Tag



DF722

39	Pass	DF106ea.	3.00
40	Pass	DF18ea.	3.00
41	Pass	DF681ea.	3.00
42	Pass	DF682ea.	3.00
49-51	Pass	DF722ea.	3.00
39-40	Merc	DL127ea.	3.00

Jack Instruction Decal



DF268

52-53	Pass	DF396ea.	3.00
54-56	Pass	DF50ea.	3.00
53	Merc	DL349ea.	3.00
54	Merc	DL6ea.	3.50
55-56	Merc	DL8ea.	3.50
55-56	Merc Wgn	DL68ea.	3.50
52-56	Wagon	DF268ea.	3.00

Jack Base Decal

50-51	Merc	DL10ea.	3.00
-------	------	------	----------	------

Tire Stowage Instruction Decal

52-53	Pass	DF415ea.	3.00
-------	------	-------	----------	------

TAILGATE

Tailgate Letter Decal Set "F.O.R.D."

53-72	PU	DF688, blueset.	7.50
53-72	PU	DF689, whiteset.	7.50
53-72	PU	DF690, blackset.	7.50
53-72	PU	DF691, silverset.	7.50
53-72	PU	DF692, redset.	7.50

MISCELLANEOUS

Fan Hub Instructions Decal



DF-27

42-48	Pass	DF27ea.	3.50
42-48	Merc	DL197ea.	3.50
42-48	PU	DF27ea.	3.50

Columbia Axle Decal

35-48	Pass & PU	DG-024ea.	4.00
-------	-----------	--------	----------	------

Engine Foundry Water Pump Tag

54-57	Pass	DF229ea.	4.00
55-57	Merc	DL100ea.	4.00

Body "Life Guard" Decal



DF93

56-57	Pass	DF93ea.	6.00
-------	------	------	----------	------



"Paint OK" Decal

55	Pass	DF235ea.	4.00
56	Pass	DF236ea.	4.00
55	T-Bird	DF235ea.	4.00
56	T-Bird	DF236ea.	4.00

"Genuine Ford Parts" 3" Oval Decal



All	Pass & PU	DF531ea.	3.00
-----	-----------	-------	----------	------

"Ford" Oval Decals with White Background



All	Pass & PU	DF361, 3-1/2"ea.	3.00
All	Pass & PU	DF362, 6-1/2"ea.	3.50
All	Pass & PU	DF363, 9-1/2"ea.	4.00
All	Pass & PU	DF364, 17"ea.	5.50

"Ford" Oval Decals with Clear Background

All	Pass & PU	DF1388, 3-1/2"ea.	3.00
All	Pass & PU	DF1389, 6-1/2"ea.	3.50
All	Pass & PU	DF1390, 9-1/2"ea.	4.00
All	Pass & PU	DF1391, 17"ea.	5.50

"50 Year Anniversary" Decal 48-98 F Series

48-UP	PU	F85Z-15423A68-AAea.	19.00
-------	----	------------------	----------	-------

**Section 61
Hardware**

BODY TRIM CLIP KIT

1934 Passenger Trim Clips

34	Pass	40-20001, grille (12 clips)set.	5.00
----	------	--------------------------------	-----------	------

1935-38, & 39 Standard Running Board Trim Clip

Universal clips, cut to size, with stud.

35-38	Pass	19378ea.	1.00
39	Std Pass	19378ea.	1.00

1935 Passenger Trim Clips

35	Pass	48-20001, grille (34 clips)set.	9.00
35	Pass	48-20004, hood side (32 clips)set.	9.00
35	Pass	48-20000, includes 48-20001, 48-20004set.	18.00

1936 Passenger Trim Clips

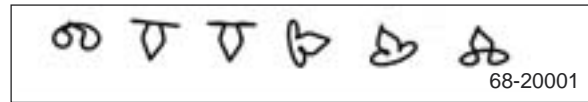

36	Pass	68-20001, grille center strip wire clips (6 clips)set.	4.00
36	Pass	68-20002, grille outer (16 clips)set.	5.50
36	Pass	68-20004, hood side (24 clips)set.	7.50
36	Pass	68-20000, includes 68-20001, 68-20002, 68-20004set.	17.00

1937 Passenger Trim Clips

37	Pass	78-16720/1-CP, hood side, and grill side trimkit.	20.00
----	------	--	-----------	-------

1938 Standard Passenger Trim Clips

38	Std Pass	81A-20001-A, grille & hood side (56 clips)set.	11.50
38	Std Pass	81A-20004-A, grille side & hood side (12 clips)set.	5.00
38	Std Pass	81A-20005, body belt (58 clips)set.	11.50
38	Std Pass	81A-20006, body belt bolts (14 pcs.)set.	7.00
38	Std Pass	81A-20000-A, includes 81A-20001-A, 81A-20004-A, 81A-20005, 81A-20006set.	35.00

1938 Deluxe Passenger Trim Clips

38	Dlx Pass	81A-20004-B, grille side & hood side (10 clips)set.	5.00
38	Dlx Pass	81A-20005, body belt (58 clips)set.	11.50
38	Dlx Pass	81A-20006, body belt bolts (14 pcs.)set.	7.00
38	Dlx Pass	81A-20000-B, includes 81A-20004-B, 81A-20005, 81A-20006set.	23.50

1939 Standard Passenger Trim Clips

39	Std Pass	91A-20001-A, grille bars & hood side louvers (30 clips)set.	9.00
39	Std Pass	81A-20005, body belt (58 clips)set.	11.50
39	Std Pass	81A-20006, body belt bolts (14 pcs.)set.	7.00
39	Std Pass	91A-20000-A, includes, 91A-20001-A, 81A-20005, 81A-20006set.	27.50

1939 Deluxe Passenger Trim Clips

39	Dlx Pass	91A-20001-B, grille bars (82 clips)set.	16.50
----	----------	--	-----------	-------

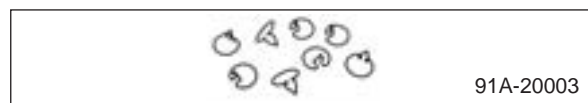

39	Dlx Pass	91A-20003, hood center (8 clips)set.	5.00
39	Dlx Pass	91A-20004, grille side (8 clips)set.	4.00



39	Dlx Pass	91A-20005, body belt (70 clips).....set.	14.00
39	Dlx Pass	81A-20006, Body belt bolts (14 pcs.).....set.	7.00
39	Dlx Pass	91A-20020-B, dash trim (6 clips).....set.	4.00
39	Dlx Pass	91A-20000-B, includes, 91A-20001-B, 91A-20003, 91A-20004, 91A-20005, 91A-20006, 91A-20020-B.....set.	46.50

1940 Standard Passenger Trim Clips

40	Std Pass	91A-20003, hood center (8 clips).....set.	5.00
40	Std Pass	01A-20005, body belt (58 clips).....set.	11.50
40	Std Pass	01A-20006, Body belt bolts (8 clips).....set.	5.00
40	Std Pass	01A-20000-A, includes, 91A-20003, 01A-20005, 01A-20006.....set.	21.50

1940 Deluxe Passenger Trim Clips

40	Dlx Pass	01A-20001, grille.....set.	6.00
40	Dlx Pass	01A-20002, lower front of hood (6 pcs.) wide strip (big trim).....set.	5.00

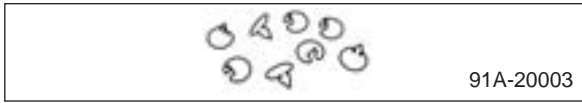

40	Dlx Pass	91A-20003, hood center (8 clips).....set.	5.00
40	Dlx Pass	01A-20005, body belt (58 clips).....set.	11.50
40	Dlx Pass	01A-20006, body belt bolts (8 clips).....set.	5.00
40	Dlx Pass	01A-20000-B, includes 01A-20001, 01A-20002, 91A-20003, 01A-20005, 01A-20006.....set.	32.50

1941-46 Passenger Window Reveal Molding Clips

41-46	Cpe 2D	11A-20007, straight (36 clips, 4 bolts).....set.	12.00
41-46	Cpe 2D	11A-20008, curved (24 clips).....ea.	7.50
41-46	Sdn 2D	11A-20007, straight (36 clips, 4 bolts).....set.	12.00
41-46	Sdn 2D	11A-20008, curved (24 clips).....ea.	7.50
41-46	Sdn 4D	11A-20009, straight (56 clips, 6 bolts).....set.	17.00
41-46	Sdn 4D	11A-20010, curved (24 clips).....set.	10.00

1941 Passenger Trim Clips

41	Pass	11A-20005, body belt (55 clips, 6 bolts).....set.	18.00
41	Pass	11A-20003, hood center (10 clips, 2 bolts).....set.	6.00

41	Pass	11A-20011, fenders (52 bolts).....set.	22.00
41	Conv	11A-20000-A, includes #11A-20005, 11A-20003, 11A-20011.....kit.	46.00
41	Cpe 2D	11A-20000-B, includes #11A-20005, 11A-20007, 11A-20008, 11A-20003, 11A-20011.....kit.	65.50
41	Sdn 2D	11A-20000-B, includes #11A-20005, 11A-20007, 11A-20008, 11A-20003, 11A-20011.....kit.	65.50
41	Sdn 4D	11A-20000-C, includes #11A-20005, 11A-20003, 11A-20011, 11A-20009, 11A-20010.....kit.	73.00

1942-46 Passenger Trim Clips



42-46	Pass	21A-20005, body belt (50 clips, 6 bolts).....set.	17.00
42-46	Pass	21A-20011, fenders (38 bolts).....set.	17.00
46	Pass	51A-20012, trunk Lid (12 clips, 4 bolts).....set.	6.00
42-46	Conv	21A-20000-A, includes #21A-20005, 21A-20011, 51A-20012.....set.	40.00
42-46	Cpe 2D	21A-20000-B, includes #21A-20005, 21A-20011, 51A-20012, 11A-20007, 11A-20008.....set.	59.50
42-46	Sdn 2D	21A-20000-B, includes #21A-20005, 21A-20011, 51A-20012, 11A-20007, 11A-20008.....set.	59.50
42-46	Sdn 4D	21A-20000-C, Includes #21A-20005, 21A-20011, 51A-20012, 11A-20009, 11A-20010.....kit.	67.00

1947-48 Passenger Trim Clips

47-48	Pass	6A-20001, front splash apron (8 clips).....set.	5.00
47-48	Pass	6A-20005, body belt (50 clips, 6 bolts).....set.	17.00
47-48	Pass	6A-20011, fenders (38 bolts).....set.	17.00
47-48	Pass	6A-20000-A, includes above 3 kits.....set.	39.00

1949-51 Passenger Trim Clips

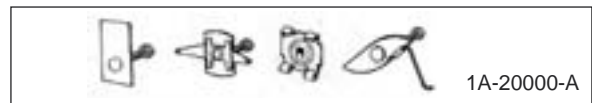

49-50	Pass	8A-20000-A, complete kit, fits coupe, all sedans, and convertible, except wagon and crestliner.....kit.	110.00
51	Pass	1A-20000-A, complete kit, fits coupe, all sedans, and convertible, except wagon and crestliner.....kit.	125.00
49-50	Pass	358314-KIT, splash apron kit.....kit.	12.00

Section 61 - Hardware



C&G Early Ford Parts, Inc.

49-50	Pass	358314-S3, , splash apron, 6 requiredea.	2.00
49-50	Pass	355323-S8, splash apron end clip, 2 required.....ea.	2.00
49-51	Pass	357039-S, front fender clip, 4 required.....ea.	3.00
49-50	Pass	8A-20003, hood center, wire type, 3 required.....kit.	3.00
49-51	Pass	2295, hood centerea.	1.50
49-50	Pass	352362-S, body side, 26 required for 2-door, 22 required for 4-doorea.	3.00
49-50	Pass	356761-S, T bolt, 6 required 2-door, 10 required 4-door.....ea.	2.50
51	Pass	357280-S, body side and below trunk, 14 required 2-door, 12 required 4-door.....ea.	3.00
51	Pass	357316-S, body side, 28 required 2-door, 30 required 4-door.....ea.	3.00
51	Pass	C8GY-16A076-A, , below trunk, 3 requiredea.	2.00

1949-50 Mercury Trim Clips

49-50	Merc	352396-S, body side trim clipea.	2.00
-------	------	--	------

1940-47 Pick-Up Trim Clips

40-47	PU	91A-20003, hood center (8 clips).....set.	5.00
-------	----	---	------

1948-50 Pick-Up Trim Clips

48-50	PU	358158-S3, hood side trim, 20 required.....ea.	1.50
48-50	PU	358158-SET, 20 piece setset.	27.00

1951 Pick-Up Trim Clips

51-52	PU	357841-SET, hood side center trim only, set of 10set.	8.00
51-52	PU	357841-S, hood side center trim, sold each.....ea.	1.00

1956 Pick-Up Trim Clips

56	PU	B6C-8120915-S, door trimset.	5.00
----	----	------------------------------------	------

INDIVIDUAL TRIM CLIPS

Top Front Windshield Molding Clip



55-56	Pass	B5A-6403166-Aea.	3.00
55-56	Merc	B5A-6403166-Aea.	3.00

Garnish Molding Trim Clip

52-54	Pass	2464ea.	1.50
52-54	Merc	2464ea.	1.50

Door & Quarter Belt Molding Clip

52-54	Pass	2458ea.	1.50
-------	------	---------------	------



55	Pass	2569ea.	1.50
55-56	Pass	2567ea.	2.00
52-54	Merc	2458ea.	1.50
55	Merc	2569ea.	1.50



55-56	Merc	2567ea.	2.00
-------	------	---------------	------

Front Door Belt Molding Clip



56-57	Pass	2696ea.	2.00
-------	------	---------------	------

Body Side Molding Clip

52-53	Pass	2587ea.	1.50
-------	------	---------------	------



55-56	Pass	2608ea.	2.00
-------	------	---------------	------

Door & Fender Molding Clip



52-53	Pass	2455ea.	2.50
-------	------	---------------	------



54	Pass	2513ea.	2.50
----	------	---------------	------



54-56	Merc	2512ea.	2.50
-------	------	---------------	------

Fender, Door, & Quarter Molding Clip

56	Pass	2493ea.	2.50
----	------	---------------	------



56-59	Pass	2614ea.	2.50
56	Merc	2493ea.	2.50

Door & Quarter Side Molding Clip



54 Pass 2511ea. 2.50



55-56 Pass 2568ea. 2.00
55-56 Merc 2568ea. 2.00

Quarter Panel Molding Clip



52-56 Pass 2600ea. 2.50



56 Pass 2615ea. 2.50
55 Merc 1083ea. 2.50

Roof Molding Clip



56 Hardtop 2D 2513ea. 2.50

Roof Rail Molding Clip



55-56 Pass 11000ea. 2.50



55-56 Pass 11001ea. 2.95
55-56 Merc 11000ea. 2.50
55-56 Merc 11001ea. 2.95

Rocker Panel Molding Clip



49-54 Pass 2468ea. 2.95
52-56 Pass 1011ea. 2.95
49-54 Merc 2468ea. 2.95



55-56 Merc 1047ea. 2.50

Molding Clip



52-54 Pass 2454ea. 2.50



54 Pass 2478ea. 2.00

Universal Break-Off Type Molding Fastener



19378,
3/4" wide x 2-1/2"
long, w/1/4"-20 threadsea. 1.00

TRIM SCREW KITS

Interior Trim Screw Kits

All of our interior trim screw sets are USA made. The 1932-41 kits are slotted screws as original. Conv rear window screws are supplied as needed. 1942-56 kits are a mix of slotted and phillips screws as required.

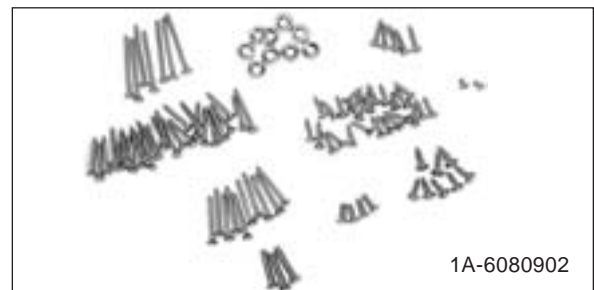

32	Roadster	320.....kit.	11.00
32	Phaeton	321.....kit.	12.50
32	Cabriolet	328.....kit.	19.00
32	Cpe 3W	322.....kit.	18.00
32	Cpe 5W	323.....kit.	19.00
32	Sdn 2D	324.....kit.	19.50
32	Victoria	326.....kit.	19.50
32	B-400	327.....kit.	20.00
32	Sdn 4D	325.....kit.	23.50
33-34	Roadster	330.....kit.	11.00
33-34	Phaeton	331.....kit.	12.50
33-34	Cabriolet	335.....kit.	12.50



33-34	Cpe	332.....	kit.	14.00
33-34	Sdn 2D	333.....	kit.	14.00
33-34	Sdn 4D	334.....	kit.	18.00
35-36	Roadster	350.....	kit.	11.00
35-36	Phaeton	351.....	kit.	12.50
35-36	Cabriolet	355.....	kit.	12.50
35-36	Conv Sdn	356.....	kit.	12.50
35-36	Cpe	352.....	kit.	12.50
35-36	Sdn 2D	353.....	kit.	12.50
35-36	Sdn 4D	354.....	kit.	12.50
37	Phaeton	370.....	kit.	12.50
37	Cabriolet	374.....	kit.	12.50
37	Conv Sdn	375.....	kit.	14.00
37	Cpe	371.....	kit.	12.50
37	Sdn 2D	372.....	kit.	12.50
37	Sdn 4D	373.....	kit.	14.00
38-39	Conv	383.....	kit.	14.00
38-39	Conv Sdn	384.....	kit.	12.50
38-39	Cpe	380.....	kit.	12.50
38-39	Sdn 2D	381.....	kit.	12.50
38-39	Sdn 4D	382.....	kit.	12.50
40	Conv	403.....	kit.	14.00
40	Cpe	400.....	kit.	12.50
40	Sdn 2D	401.....	kit.	11.00
40	Sdn 4D	402.....	kit.	12.50
41	Conv	413.....	kit.	12.50
41	Cpe	410.....	kit.	11.00
41	Sdn 2D	411.....	kit.	11.00
41	Sdn 4D	412.....	kit.	12.50
42-48	Conv	422.....	kit.	12.50
42-48	Cpe 2D	420.....	kit.	11.00
42-48	Sdn 2D	420.....	kit.	11.00
42-48	Sdn 4D	421.....	kit.	12.50
49	Conv	8A-7680902	kit.	16.00
49	Sdn 2D	8A-7080902	kit.	16.00
49	Sdn 4D	8A-7380902	kit.	16.50
50	Conv	0A-7680902	kit.	16.00
50	Sdn 2D	0A-7080902	kit.	16.00
50	Sdn 4D	0A-7380902	kit.	16.50
51	Conv	1A-7680902	kit.	16.00
51	Hardtop 2D	1A-6080902	kit.	16.50
51	Sdn 2D	1A-7080902	kit.	16.00
51	Sdn 4D	1A-7380902	kit.	16.50
52	Sdn 2D	BA-7080902.....	kit.	16.00
52	Hardtop 2D	BA-6080902.....	kit.	16.00
52	Sdn 4D	BA-7380902.....	kit.	16.50
52	Conv	BA-7680902.....	kit.	16.00
53	Conv	BF-7680902	kit.	16.00
53	Hardtop 2D	BF-6080902	kit.	16.00
53	Sdn 2D	BF-7080902	kit.	16.00
53	Sdn 4D	BF-7380902	kit.	16.50
54	Conv	BM-7680902.....	kit.	16.00
54	Hardtop 2D	B4A-6080902.....	kit.	16.00
54	Sdn 2D	B4A-7080902.....	kit.	16.00
54	Sdn 4D	B4A-7380902.....	kit.	16.50
55	Conv	B5A-7680902.....	kit.	16.00

55	Crown Vic	B5A-6480902.....	kit.	16.50
55	Hardtop 2D	B5A-6080902.....	kit.	16.00
55	Sdn 2D	B5A-7080902.....	kit.	16.00
55	Sdn 4D	B5A-7380902.....	kit.	16.50
56	Conv	B6A-7680902.....	kit.	16.00
56	Hardtop 2D	B6A-6080902.....	kit.	16.00
56	Crown Vic	B6A-6480902.....	kit.	16.50
56	Sdn 2D	B6A-7080902.....	kit.	16.00
56	Sdn 4D	B6A-7380902.....	kit.	16.50
32-34	PU	329.....	kit.	14.00

DRIVETRAIN

Cotter Pin Set



32-48	Pass	3121, 165 pcs.....	set.	6.00
32-41	PU	3121, 165 pcs.....	set.	6.00

Stainless Cotter Pin Set

32-48	Pass	3121-SS.....	set.	17.50
32-41	PU	3121-SS.....	set.	17.50

HOLE PLUGS

Rubber Hole Plugs



All	Pass & PU	352291-S, 3/4".....	ea.	2.00
All	Pass & PU	352284-S, 1 1/4".....	ea.	2.00
All	Pass & PU	352285-S, 1 1/2".....	ea.	2.00
All	Pass & PU	357216-S, 1 3/4".....	ea.	2.00

Rubber Floor Plugs for Floor Board

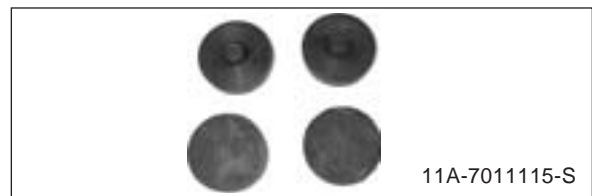

41-48	Pass	11A-7011115-S, 4 pcs.....	set.	6.50
-------	------	---------------------------	------	------

Back of Cab Hole Plug

53-56	PU	352285-S, 1 1/2", 2 required	ea.	2.00
-------	----	------------------------------------	-----	------

MISC.

Castle Nuts



All	Pass & PU	CN1/4, 1/4".....ea.	.90
All	Pass & PU	CN5/16, 5/16".....ea.	1.00
All	Pass & PU	CN3/8, 3/8".....ea.	1.00
All	Pass & PU	CN7/16, 7/16".....ea.	1.00
All	Pass & PU	CN1/2, 1/2".....ea.	1.50

Cage Nuts



All	Pass & PU	1/4-20, 1/4"-20.....	Call
All	Pass & PU	3145, 5/16"-24.....ea.	1.50
All	Pass & PU	3/8-24, 3/8"-24.....ea.	2.50

Clinch Nuts (D-Nuts)



All	Pass & PU	1123A, 10/32.....ea.	.50
All	Pass & PU	1123B, 1/4-20.....ea.	.50
All	Pass & PU	1123, 12-24.....ea.	.50
All	Pass & PU	1123D, 5/16-24.....ea.	1.50

T-Nut



All	Pass & PU	1166T, 5/16-24.....ea.	.75
-----	-----------	------------------------	-----

Black Body Bolt



All	Pass & PU	353483-S, 5/16-24x1",.....ea.	.50
-----	-----------	-------------------------------	-----

All	Pass & PU	353483-SET, 5/16-24x1", 50 pcs.....pkg.	20.00
-----	-----------	--	-------

Carriage Bolt

All	Pass & PU	23501-P, plain, 1-1/2" fine thread.....ea.	1.00
All	Pass & PU	23501-CC, chrome, 1-1/2" fine thread.....ea.	2.00
All	Pass & PU	23501-SS, stainless, 1-1/2" fine thread.....ea.	2.00
All	Pass & PU	23501-SSP, polished stainless, 1-1/2" fine thread.....ea.	2.50

Seat Wood to Back of Cab Bolt

30-34	PU	A-65023.....ea.	1.75
-------	----	-----------------	------

Speed Nut

Looks like a push on clip. Usually used on emblems. Listed by stud size, sold each.

All		1903, 1/4-20 stud.....ea.	.20
All		1912, #12 stud.....ea.	.20
All		1914, 3-32" stud.....ea.	.15
All		2089, 6-32" stud.....ea.	.15
All		2091, 8-32" stud.....ea.	.15
All		2092, 10-24 stud.....ea.	.15
All		2098, 1/16" stud.....ea.	.15
All		2099, 1/8" stud.....ea.	.15
All		2103, 3/16" stud.....ea.	.15
All		2105, 1/4" stud.....ea.	.15
All		3138, 5/16" stud.....ea.	.15
All		3139, 7/16" stud.....ea.	.15

Barrel Clip or Tube Nut

Used for emblems. Sold by stud size.

All		2595, 1/8" stud, round.....ea.	.15
All		2596, 3/32" stud, square.....ea.	.15
All		2610, 1/4" stud, square.....ea.	.20
All		3136, 1/16" stud, round.....ea.	.20
All		5854, 1/8" stud, round.....ea.	.25

Universal Molding Fastner

Check molding size before ordering.

All		2619, length=1-11/32" width=1/2".....ea.	1.00
All		2744, length=3/4" width=5/16".....ea.	1.00
All		2752, length=1-25/32" width=9/16".....ea.	1.00
All		2789, length=1-5/8" width=9/16".....ea.	1.50
All		2818, length=3/4" width=5/16".....ea.	1.00
All		5889, round, fits 5/16"-1/2" wide molding.....ea.	.75



STAINLESS BOLT KITS



Stainless Pickup Body Bolt Kit

Kit is comprised of hex bolts and phillips screws. Includes cab mount, cowl vent, door hinge latch & catch, interior, front & inner fender, grill top & support, horn bracket kit (48-50), hood latch, catch, brace & hinge, radiator support & brace kit, running board bolts (except 41-47), seat mounting kit, and transmission & steering column cover. Does NOT include bolts for bed.

41-47	PU	6-6802kit.	136.00
48-50	PU	6-0363, 782 pcs.kit.	188.50
51-52	PU	6-0365, 782 pcs.kit.	182.00
53-56	PU	6-0272, 780 pcs.kit.	200.00

Stainless Pickup Body & Bed Bolt Kit

Kit is comprised of hex bolts and phillips screws. Includes cab mount, cowl vent, door hinge latch & catch, interior, front & inner fender, grill top & support, horn bracket (48-50), hood latch, catch, brace & hinge, radiator support & brace, running board, seat mounting, and transmission & steering column cover, bed strips, bumpers, tail light, tailgate, and rear fender.

41-47	PU	6-6804kit.	220.00
48-50	PU	6-0302, 1172 pcs.kit.	335.00
51-52	PU	6-0357, 1172 pcs.kit.	322.00
53-56	PU	6-0255, 1198 pcs.kit.	290.00

Stainless Master Cylinder Mount Kit

48-56	PU	6-0356kit.	3.50
-------	----	--------	-----------	------

Stainless Cab Mount Bolt Kit

53-56	PU	6-0275kit.	40.00
-------	----	--------	-----------	-------

Stainless Interior Trim Screw Kit

48-52	PU	6-0335kit.	19.50
-------	----	--------	-----------	-------

Stainless Door Hinge Bolt Kit

53-56	PU	6-0217kit.	9.25
-------	----	--------	-----------	------

Stainless Door Hinge Latch & Catch Bolt Kit

48-52	PU	6-0333kit.	14.00
-------	----	--------	-----------	-------

Stainless Front Fender Brace Bolt Kit

53-56	PU	6-0205ea.	6.00
-------	----	--------	----------	------

Stainless Front & Inner Fender Bolt Kit

48-52	PU	6-0304kit.	60.50
53-56	PU	6-0252kit.	43.00

Stainless Hood Bolt Kit

Includes hood latch, catch, braces and hinges.

48-50	PU	6-0321kit.	9.00
51-52	PU	6-0324kit.	9.25

Stainless Hood Brace Bolt Kit

53-56	PU	6-0209ea.	3.50
-------	----	--------	----------	------

Stainless Hood Latch Bolt Kit

53-56	PU	6-0214kit.	2.75
-------	----	--------	-----------	------

Stainless Tailgate Hinge & Tail Light Bolt Kit

48-56	PU	6-0222kit.	18.00
-------	----	--------	-----------	-------

**Section 62
Paint and Insulation**

ENGINE PAINT

Engine Spray Paint

Cannot be shipped air or overseas.



All	Pass	D7AZ-19000-A, argent (silver)...	ea.	14.50
28-41	Pass	M-200, greenea.	6.25
42-49	Pass	M-202, blueea.	5.75
49-51	Pass	8A-6000-S, bronzeea.	23.00
52-53	Pass	BA-6000-S, orangeea.	23.00
55-57	Pass	B5S-6000-S, redea.	23.00
39-41	Merc	M-200, greenea.	6.25
42-48	Merc	M-202, blueea.	5.75
All	PU	D7AZ-19000-A, argent (silver)...	ea.	14.50
28-41	PU	M-200, greenea.	6.25
42-47	PU	M-202, blueea.	5.75
48-52	PU	7C-6000-S, dark redea.	23.00

Engine Paint

Cannot be shipped air or overseas.

28-41	Pass	A-6000, greenqt.	25.00
42-49	Pass	21A-6000, blueqt.	42.00
49-51	Pass	8A-6000, bronzeqt.	60.00
52-53	Pass	BA-6000, orangeqt.	42.00
55-57	Pass	B5S-6000, redqt.	50.00
39-41	Merc	A-6000, greenqt.	25.00
42-48	Merc	21A-6000, blueqt.	42.00
49-53	Merc	8M-6000, greenqt.	60.00
55-57	T-Bird	B5S-6000, redqt.	50.00
28-41	PU	A-6000, greenqt.	25.00
42-47	PU	21A-6000, blueqt.	42.00

Blue Emblem Paint

Cannot be shipped air or overseas.

B-17751, 1 ozea.	5.00
B-17751, 1 ozea.	5.00

INTERIOR PAINT

Dash, Steering Column, & Steering Wheel Paint

Cannot be shipped air or overseas.

40	Dlx Pass	40-DLX-MAR-S, spray, monaida maroon.....ea.	24.50
40	Dlx Pass	40-DLX-TAN-S, spray, copper sand metallic.....ea.	24.50

Top Assembly Paint

Cannot be shipped air or overseas.

36-37	Pass	36/37-TOPASSY-QT.....qt.	45.00
-------	------	--------------------------	-------

LUBRICANTS

Gear Oil

Cannot be shipped air or overseas.



M-400

All	Pass & PU	M-400, 600 weight, 32 oz.....ea.	11.00
All	Pass & PU	M-85140, 85-140 weight, 32 oz.....ea.	4.00

INSULATION

Single Foil Backed Insulation

Great for firewall, under carpet and between headliner and roof.



HR-700770

*All	Pass & PU	HR-700770, 4'x6'x3/8".....ea.	33.50
*All	Pass & PU	HR-700770-A, 4'x15'x3/8".....ea.	84.00

Double Foil Backed Insulation

Great for firewall, under carpet and between headliner and roof.

*All	Pass & PU	HR-700770-B, 4'x6'x5/16".....ea.	47.50
*All	Pass & PU	HR-700770-C, 4'x15'x3/8".....ea.	109.95

Stick On Insulation Squares

Excellent for inside doors and quarter panels. Very plyable and easy to conform to shapes.

	Pass & PU	HR-700770-ST, 13"x13".....ea.	4.00
--	-----------	-------------------------------	------

ADHESIVES

Sticky Stuff Spray

Adhesive for insulation. Cannot be shipped air or overseas.



All	Pass & PU	STICKY-STUFF, 12 oz.....ea.	13.50
-----	-----------	-----------------------------	-------

Aluminized Foil Tape

Tape for insulation



All	Pass & PU	TAPE-INSUL, 30 ft.....roll.	5.00
-----	-----------	-----------------------------	------

Black Weatherstrip Adhesive

Cannot be shipped air or overseas.



3M-8011

All	Pass & PU	3M-8011.....ea.	12.00
-----	-----------	-----------------	-------

Running Board Adhesive

Cannot be shipped air or overseas.

All	Pass	G-16450.....ea.	16.50
-----	------	-----------------	-------

BODY SHOP SUPPLY

Chassis Black Spray Paint

	E-10025Z.....ea.	17.00
--	------------------	-------

High Temp Coating

Perfect for exhaust, resists heat up to 1200 F.

	E-10364Z, gray, 16 oz.....ea.	34.00
--	-------------------------------	-------



A

Accelerator Parts	129-130
Accessories	8-15, 72, 217
Acoustishield	262-263
Adhesives	359
Air Cleaner & Parts	130
Air Conditioner Parts	236
Air Deflector Seals	113
Air Vent Knob	255
Air Vent Seals	234-235
Alternator & Parts	133-134
Antennas & Parts	230-231, 258
Anti Squeak	74, 201
Arm Rest	284
Ash Trays & Knobs	256-257
Automatic Transmission Parts	104, 186
Axle Bumper - Front	48, 52
Axle Bumper - Rear	68
Axle Housing Parts	64-66
Axle Housing Repair Sleeve	65

B

Back Window Parts	302-304, 337
Back-Up Light Switch & Part	154
Back-Up Lights & Parts	154, 170, 171, 191
Ball Joints	50-51
Batteries & Parts	134-138
Battery Cables & Parts	137-138
Battery Hold Down	136
Battery Hole Cover	137
Battery Tray	135-136
Bearing - Differential	63-66
Bearing - Front Hub	35
Bearing - Rear Axle/Hub	36-37
Beauty Rings	32
Bed Parts	326-331
Belt Line Trim - Wagon	325, 332
Belts	110-111
Blue Dots	166
Body Medallion Emblem/Bezel	197-198
Body Molding Clips	352-355
Body Number/Style Information	244
Body Number Plate	240
Body Parts Book	21
Body To Frame Bolts & Pads	72-73
Body Trim Molding	323-326
Body Webbing	74
Books	16-29
Brake Cable Parts	45-46
Brake Drum Retainer	34
Brake Drums	33-34
Brake Energizer - Floaters	44
Brake Fittings	40-41
Brake Fluid - Silicone	37
Brake Hardware	43-44
Brake Hoses	40
Brake Light Switch	41, 153-154

Brake Lines - Steel	40
Brake Parts	33-48
Brake Pedal Parts	46-48
Brake Rods & Anti-Rattlers	44
Brake Shoes & Lining	42
Bulbs	160, 171-173
Bumper Arm Grommets & Pads	224-225
Bumper Guards	225
Bumper Hardware	225-226
Bumper Parts	223-226
Bumper Wing Tips	225
Bumpers & Brackets	223-225

C

Cab Corners & Strips	299
Cab To Frame Parts	72-73
Cab To Frame Wood	73
Cage Nuts	357
Camshaft & Parts	82-83
Car Covers	Call
Carburetors & Parts	128-129
Carpet Kits	266
Carriage Bolts	357
Castle Nuts	357
CD - Shop Manual	17
Choke & Throttle Cables	129
Choke & Throttle Knobs	254
Choke & Throttle Parts	129, 254
Choke & Throttle Rods	129
Cigar Lighter & Knobs	255-256
Clinch Nuts	357
Clock Parts	257
Clutch Bearings & Seals	100-101
Clutch Disc & Pressure Plate	99-100
Clutch Pedal Parts	102-103
Clutch Shaft & Parts	102
Coat Hooks	299
Coils	148-149
Columbia Axle Parts	68-69
Columbia Carburetor Plate	68
Columbia Dash Control	68
Columbia Firewall Parts	68
Columbia Vacuum Parts	68
Condenser	145
Connecting Rod Parts	86-87
Control Arm Bushings	50-51
Conv Hold Down Parts	297
Conv Side Curtain Hardware	298
Conv Top Knobs	297
Conv Top Motor Parts	298
Conv Top Pads & Bumpers	298
Conv Top Parts	296-298
Conv Top Rubber	296-297
Conv Top Seal Retainer	297
Conv Window Seal	296
Cooling System Parts	104-114

Cotter Pins	356
Cowl Lace	210
Cowl Lights & Parts	163
Cowl Mirror	221
Cowl Patch Panels	316
Cowl to Engine Wires	182-183
Cowl To Firewall Seal	239
Cowl Trim	323
Cowl Vent Knobs	237-238
Cowl Vent Parts	237-238
Crankshaft Parts	87-89
Crossover Pipe	70
Custom Cab Panel-Behind Seat	304
Cutout, Generator	133
Cylinder Head Nuts & Covers	81-82

D

Dash Board Jewel	253
Dash Emblems/Bezels	251, 265
Dash Grommets	251-252
Dash Knob Kits	252-253
Dash Light Dimmer Switch/Knob	152, 253-254
Dash & Dash Panels	246
Dash Plastic	249-250
Dash Trim	250, 265
Dash Parts	246-259
Dash Wires	183-184
Data Plate, Patent	240
Decals & Kits	346-352
Deck Lid Emblem/Bezel	198
Deck Lid Handle & Parts	306-308
Deck Lid Panel	319
Deck Lid Parts	304-310
Deck Lid Support	306
Defroster Parts	236
Dice - Fuzzy	12
Die Cast Models	11-12
Diff. Cover Inspection Plate	69
Differential Parts	63-66
Dimmer Switch	150
Distributor - Rebuilt	142
Distributor Metal Tags	348
Distributor Parts	142-146
Dome Light & Parts	152-153, 169-170
Dome Light Wires	187-188
Door Bumpers	269-270
Door Check Straps & Parts	275-276
Door Dovetails	273-274
Door Emblems	197, 284
Door Escutcheons	282-283
Door Felt Kit	288-289
Door Garnish Molding Insert	284
Door Glass Bumpers	270
Door Glass Channel	293-294
Door Glass To Body Seals	295
Door Glass To Frame Seals	295
Door Handle - Inside	279-280

Door Handle - Outside	277-278
Door Handle Parts	278-279
Door Hardware	270
Door Hinge Pins	270
Door Hinge Seal	267
Door Lock Escutcheons	283
Door Locks & Parts	274-275
Door Panel Emblem/Bezel	284
Door Panels	283
Door Parts	267-284
Door Patch Panels	316-317
Door Scuff Plates	276-277
Door Seals	267-269
Door Springs	271
Door Strikers & Hardware	272-273
Door Trim	284, 324
Door Window Flipper Parts	296
Door Window Trim	324
Drag Links	58
Driveshaft Parts	64, 99
Duffle Bag	12

E

Electric Fan	110
Electric Fuel Pump	125
Electric Wiper Motor	213-214
Electrical - Wiring	178-193
Electronic Ignition	144
Emblems	194-198
Emergency Brake Cables	45-46
Emergency Brake Handle & Parts	45
Engine Gaskets	78-80
Engine Hardware	81-82
Engine Manual	19-20
Engine Paint	76, 358
Engine Parts	76-92
Escutcheons	282-283
Exhaust Deflectors	8, 72
Exhaust System Parts	69-72

F

Fan Belts	110-111
Fan Hub Parts	110
Fans	110
Fender Aprons & Parts	199, 201
Fender Braces/Supports	199-201
Fender Emblems	196-197
Fender Hardware	203-204
Fender Skirts & Parts	202
Fender Stone Guard & Trim	203, 325-326
Fender To Cowl Seals	201
Fender Trim	202, 325-326
Fender Welting	201
Fenders	198-199
Fenders & Parts	198-204
Firewall Grommets	239-240



Firewall Insulation 359
 Firewall Insulator 238
 Firewall Insulator Button 238
 Flashers 152
 Floorboards & Seals 267
 Floor Mats & Clips 266
 Floor Pans 315
 Flywheel Parts 88-89, 140
 Fog Lights & Brackets 9
 Foot Rest Post & Base 131
 Ford Oval Stickers 352
 Frame Horn Covers 74, 123
 Frame Parts 75
 Frame Webbing 74
 Front Axle Parts 48-49
 Front Suspension Parts 50-52
 Fuel Lines & Parts 127
 Fuel Pumps & Parts 125-127
 Fuel System 121-131
 Fuzzy Dice 12

G

Garnish Molding Insert & Seals 252, 284
 Gas Caps 123-124
 Gas Gauge Airline Kit 127
 Gas Filler Neck 122-123
 Gas Neck Grommet 122-123
 Gas Neck Hose & Clamps 122
 Gas Pedal 130-131
 Gas Tank Cover 123, 320
 Gas Tank Door Spring & Bumpers 123
 Gas Tank Parts 121-124
 Gas Tank Sending Unit & Parts 124
 Gas Tanks 121
 Gauge Face Kit 248
 Gauges 247-249
 Gear Oil 359
 Gear Shift Boots 98
 Gear Shift Knobs 97-98
 Gear Shift Parts 97-98
 Generator Belts 110-111
 Generator Metal Tags 348
 Generators & Parts 131-133
 Gift Certificates Call
 Glass Channels 293-294
 Glass Custom Made 240-241
 Glass Setting Tape 295
 Glass Top Seal 299
 Glove Box & Bumpers 263-265
 Glove Box Door 263
 Glove Box Hardware 264
 Glove Box Knobs 257
 Glove Box Lock 264
 Glue 359
 Gravel Deflector 226
 Gravel Pan Seal 226

Greyhound Ornament 8, 107, 119
 Grille Emblems/Ornaments 119-120, 194
 Grille Guard 120
 Grille Sheetmetal 116-117
 Grille Shell Lace & Bumpers 120
 Grille Trim 118, 202
 Grilles & Parts 114-121

H

Halogen Headlight Bulb 160
 Halogen Headlights 154-155
 Halogen Tail Light Bulb 171
 Hardware 352-358
 Head Gaskets 79
 Headers 69-70, 342-343
 Headlight Bulbs 160
 Headlight Dimmer Floor Switch 150
 Headlight Door Top Molding 159
 Headlight Gaskets & Pads 156-157
 Headlight Halogen Reflector Kit 158
 Headlight Hardware 159-160
 Headlight Lens 157
 Headlight Parts 154-160
 Headlight Reflector & Parts 157-158
 Headlight Switch & Parts 61, 150, 253
 Headlight Trim 159
 Headlight Wire Crossover Channel 112
 Headlight Wires 178-180
 Headlights 154-155
 Headliner & Parts 299
 Heater & Defroster Cable 233
 Heater Control Valve 233
 Heater Core 233
 Heater Hose & Hardware 235-236
 Heater Knobs & Brackets 232-233
 Heater Motor 232
 Heater Motor Switch 153
 Heater Parts 232-236
 Heater Plenum 236
 Heater Seals 234-235
 Heater Wires 184-185
 Highbeam Jewel 253
 Highbeam Socket & Wire 183, 253
 Hinge Pin 270
 Hinge Pin Mirror 221
 Hinge Pin Puller Tool 270
 Hole Plugs 356
 Hood Arm Supports & Parts 206
 Hood Bumpers 210
 Hood Cable Knob 208
 Hood Emblems 194-196
 Hood Handle 207-209
 Hood Hinge & Parts 205
 Hood Lace & Seals 210
 Hood Latches & Parts 206-207
 Hood Light Switch 206
 Hood Ornaments & Inserts 208-209

Hood Parts	204-210
Hood Prop Kit	206
Hood Release Cable	208
Hood Safety Catch	207
Hood Side/Fender Hardware	208
Hood Trim	323
Horn Buttons & Parts	59-60
Horn Light Switch Rod Parts	60-61, 180
Horn Relay	153, 180
Horn Wires	180
Horns & Parts	176-177
Hose Clamps	109
Hose Kits	107-108
Hub Cap Medallion	32
Hub Caps	31-32
Hydraulic Brake Adapter Kit	34

I

Idler Arm & Parts	58
Ignition - Electronic	144
Ignition On-Off Plate	150, 258
Ignition Parts	142-149
Ignition Resistor	149
Ignition Switch Parts	150-151, 258-259
Inside Door Handle	279-280
Inside Mirrors	220-221
Instrument Panel	249-250
Insulation	359
Intake Manifold Gasket	79-80
Interior Insulation Kit	262-263
Interior Paint	359
Interior Trim Screw Sets	355-356

K

Key Rings	11
Keys	259
Kick Down Switch	103
Kick Panels & Retainer	260
King Pins & Parts	48

L

License Light Wires	190
License Plate Bracket	173
License Plate Bumper	174
License Plate Frame & Parts	175-176
License Plate Light	174
License Plate Light Lens & Parts	174, 307
Light Bulbs	171-173
Lower Door Patch Panel	316-317
Lower Door Seal Retainer	277, 320
Lower Door Seals	268
Lubricants	359
Lug Nuts	33
Luggage Rack	8
Luggage Rack Emblem	8

M

Map	3
Master Cylinder & Parts	38
Mechanical Brake Parts	44-45
Mirrors, Inside	220-221
Mirrors & Brackets	220-222
Mirrors, Outside	221-222
Molding, Belt Line	325, 332
Molding, Fender	202, 324
Molding, Grille	117-118, 202
Molding Clips	352-355
Motor Mounts & Parts	76-78
Mufflers & Clamps	71

N

N.O.S. Parts	Call
--------------	------

O

Oil Breather Caps	92
Oil Dipstick & Parts	91
Oil Filter	91
Oil Filter Adapter	92
Oil Pan Gaskets	80
Oil Pan Parts	90-91
Oil Pump & Parts	89-90
Oil Sending Unit	90
Opera Seat Leg Bumper	263
Order Form	367
Outside Door Handle	277-278
Outside Mirrors	221-222
Overdrive Parts	68-69, 103-104
Overdrive Switch	103
Overdrive Wires	185-186
Overflow Tank	113
Owners Manual	16-17

P

Paint	359
Parking Light Hardware	163
Parking Light Housings	114, 161
Parking Light Lens & Gaskets	161-162
Parking Light Trim	162
Parking Light Wire	178-179
Parking Lights & Parts	160-163
Patch Panels	315-322
Patent Data Plate	240
Pickup Bed Hardware	327
Pickup Bed Parts	326-331
Pickup Bed Strips & Bolts	330-331
Pickup Bed Wood	330
Pickup Beds	326-327
Pickup Patch Panels	320-322
Pictures	14-15
Pilot Bearing	100
Pinion Parts	63-64



Pistons & Rings85-86
 Pitman Arm57
 Points144-145
 Power Converter227
 Power Steering Parts62

Q

Quail Radiator Cap8, 106
 Quarter Panel Emblem/Bezel197-198
 Quarter Patch Panels318-319
 Quarter Post Emblem/Bezel198
 Quarter Trim324-325
 Quarter Window Felt Kit301
 Quarter Window Glass Channel301
 Quarter Window Handle301-302
 Quarter Window Parts300-302
 Quarter Window Seals300

R

Radiator Cap8, 106-107
 Radiator Drain Cock112
 Radiator Hardware111-112
 Radiator Hoses & Clamps107-109
 Radiator Mounting Kit111
 Radiator Overflow Tank113
 Radiator Pan112
 Radiator Parts106-113
 Radiator Seals113
 Radiator Support Rods & Brackets111-112
 Radiators106
 Radio Covers229
 Radio Dial Decals229
 Radio Foot Control Switch229
 Radio Knobs & Dials228
 Radio Mounting Hardware229
 Radio Parts227-231
 Radio Speakers & Parts227
 Radius Rod Bushing53
 Rear Axle Parts63-69
 Rear View Mirror220-221
 Rear Window Roll Down Parts304
 Rear Window Seal303-304
 Restoration Guide21-22
 Ring & Pinion Set63
 Rocker Patch Panels317-318
 Rocker Trim326
 Roof Rail Seals295
 Rotor145
 Rumble Seat Handles312
 Rumble Seat Hinges311
 Rumble Seat Latches311
 Rumble Seat Lid Seal311
 Rumble Seat Parts311-313
 Rumble Seat Remote Control312
 Rumble Seat Step Pad312
 Rumble Seat Strikers312

Running Board211
 Running Board Braces212
 Running Board Covers211
 Running Board Hardware211-212
 Running Board Parts211-212
 Running Board Seals212
 Running Board Step Plate212
 Running Board Trim325

S

Sales Brochures23
 Scuff Plates276-277
 Seat Belts10-11
 Seat Handle263
 Seat Knob263
 Shackle Kits48-49, 67, 340
 Sheetmetal, Cab Patch Panels320-322
 Sheetmetal, Patch Panel315-322
 Shift Linkage Grommet Kit98
 Shirts13
 Shocks & Parts52-53
 Shop Manual17-18
 Solenoid, Starter140-141
 Spare Tire Cover Trim & Parts310-311
 Spark Plug Wires & Parts146-147
 Spark Plugs148
 Spreader Bars74
 Speaker Parts227
 Speedometer Cable & Parts218-219
 Speedometer Drive Gear & Parts219
 Speedometer Face248
 Speedometer Plastic Dome250
 Spindle Nuts35-36
 Splash Apron Seals202
 Spotlights & Brackets10
 Spring Liner49, 67
 Spring Parts, Front48-49
 Spring Parts, Rear66-67
 Spring Perch Parts49
 Spring Shackle Kits48-49, 67, 340
 Stabilizer Swivel54
 Stabilizer/Sway Bar Bushings53-54
 Starter & Parts138-140
 Starter Buttons141
 Starter Metal Tag349
 Starter Solenoid140-141
 Steering Box Parts54-57
 Steering Boxes - RebuiltCall
 Steering Column Parts61
 Steering Wheels & Parts59-60
 Step Plates212
 Stone Deflector & Seals226
 Stone Guards & Trim202, 325-326
 Street Rod Firewall345
 Street Rod Floor Pan345-346

Sun Visor Vanity Mirror	9, 220, 262
Sun Visors & Brackets	260-262
Suspension Parts	50-52
Sway Bar Parts	53-54
Switches	150-154
Synchronizer Parts	96-97

T

Tags & Decals	346-352
Tail Light Brackets	168-169
Tail Light Hardware	169
Tail Light Lens & Gaskets	165-167
Tail Light Trim	167-168
Tail Light Wire Shield	169
Tail Light Wires	188-189
Tail Lights	164-169
Tail Pipes & Clamps	71-72
Tailgate & Parts	328-329
Tandem Wiper Kit	217
Tape	359
Tappets	85
Temperature Control Knobs	255
Temperature Gauges	247
Temperature Senders & Bushings	113-114
Thermostat	109
Thermostat Housing & Gaskets	109-110
Third Brake Light	345
Tie Rod & Ends	57-58
Timing Cover Parts	80
Toggle Switch	154
Tool Tray & Braces	319-320
Top Deck Parts	299
Tote Bag	12
Track Bar Bushings	54
Transmission Bearings & Seals	93-94
Transmission Dipstick	104
Transmission Floor Seals	103
Transmission Gaskets	93
Transmission Gears & Parts	93-96
Transmission Hole Cover	103, 316
Transmission Mounts	92
Transmission Parts	92-99
Trim Clips & Screws	352-355
Trim Ring	32
Trunk Drain Hose	305
Trunk Emblems & Bezels	198
Trunk Floor Pan	319
Trunk Handles & Parts	307-309
Trunk Hinges & Parts	305-306
Trunk Latches	308
Trunk Lid Parts	304-310
Trunk Lid Supports	306
Trunk Lock Parts	309
Trunk Mats	309
Trunk Parts	304-310
Trunk Seal & Bumpers	304-305
Trunk Side Panels	309-310

Trunk Striker Plates	308
Trunk Tool Boards	309
T-Shirts	13
Tube Shock Kit	53, 341
Turn Signal Kits & Parts	152, 161
Turn Signal Knob	253
Turn Signal Switch	151-152

U

U-Joint	99
U-Joint Gaskets	99
Upper Door Seal	267

V

Vacuum Advance	144
Vacuum Wiper Hose	217
Vacuum Wiper Motor	212
Valley Cover Gasket	80
Valve Covers & Hardware	85
Valve Train Parts	82-85
Vanity Mirror	9, 220, 262
Vent Window Escutcheons	287
Vent Window Gear Kits	287
Vent Window Handles & Parts	286-287
Vent Window Pivots	287
Vent Window Seals	285
Voltage Drops & Reducers	249
Voltage Regulator	133
Voltage Regulator Metal Tags	348

W

Wagon Rain Gutter Clips	335
Wagon Sliding Window Handles	302, 336
Wagon Tailgate Parts	331-340
Water Pumps & Parts	104-106
Water Wetter	108
Wheel Bearing/Seals/Races	35
Wheel Cylinders & Kits	39
Wheel Hub Parts	34-36
Wheel Studs & Nuts	33
Wind Wing Brackets	8-9
Wind Wing Mirror	222
Window Channel Kits	288-291
Window Channel Strips	292
Window Cranks & Knobs	280-281
Window Regulators & Parts	292-293
Window Rollers	294
Window Shades	9
Windshield Division Bar & Screws	246
Windshield Frame Hardware	241-242
Windshield Frames & Parts	241-243
Windshield Garnish Molding	246
Windshield Parts	241-246
Windshield Post Seal	297
Windshield Regulator & Repair Kit	242
Windshield Seals	244-245

Windshield Trim245
 Windshield Washer Parts218
 Wiper Arm & Blade216-217
 Wiper Hose & Hardware217
 Wiper Motor213-214
 Wiper Motor Switch & Parts214
 Wiper Parts212-218

Wiper Pivot Shafts & Parts215-216
 Wiper Towers215
 Wiring178-193
 Wiring Hardware193-194
 Wishbone Rubber Ball53
 Woodie Parts - Wagon331-340

Early Ford V-8 Club of America



An International Organization

"Preserving and Restoring 1932-1953 Ford Motor Company Vehicles as Henry Built Them."

- ★ **Over 170 Regional Groups -
There's One In Your Area**
- ★ **Restoration Books**
- ★ **Restoration Help**
- ★ **V-8 TIMES -Award Winning
Bi-Monthly Magazine**
- ★ **Annual Membership Roster**

Visit Our website:
www.earlyfordv8.org

Information:
**Early Ford V-8 Club
 P.O. Box 1715
 Maple Grove, MN 55311**



C&G Early Ford Parts, Inc.
 1941 Commercial St.
 Escondido, CA 92029-1233
Phone (760) 740-2400 **Fax** (760) 740-8700
 Toll Free Order Line (800) 266-0470 Toll Free Fax (888) 836-7353
 Order online - www.cgfordparts.com

BILL TO: Business Residence

Name _____
 Address _____
 City/State/Zip _____
 Email address _____

SHIP TO: Business Residence
 (if different from Bill To: address)

Name _____
 Address _____
 City/State/Zip _____

Order Date _____

Vehicle Year _____ Model _____

MC VISA AM EX NOVUS/DISC

Card # _____

Expiration date _____ 3-Digit Code _____

Customer Signature _____

Customer # _____ or New customer

Resale Number _____

Home phone () _____

Work phone () _____

	PAGE	QTY.	PART NUMBER and DESCRIPTION	UNIT PRICE	AMOUNT
1.					
2.					
3.					
4.					
5.					
6.					
7.					
8.					
9.					
10.					
11.					
12.					
13.					
14.					
15.					
16.					
17.					
18.					
19.					
20.					

Out of stock parts usually ship within 2 weeks. Hard-to-acquire parts may take longer.
 Hard-to-acquire or unavailable parts may be canceled from your order.

SUB TOTAL
CA Sales Tax
S&H
TOTAL

What is your preference? Cancel items not available for immediate shipment
 Ship the out of stock items when they become available

Returns: All returns must be in their original packaging. All returns must be accompanied by invoice or copy of invoice.
ABSOLUTELY NO RETURNS ON ELECTRICAL, SPECIAL ORDER PARTS, OR PRINTED MATTER.
 Returns after 30 days *will* be charged a 20% restocking fee.
 Refunds on purchases paid by check are refunded after 10 banking days.
Core refunds: No core refund without receipt. Cores must be in rebuildable condition and identical to part purchased.
Returned Checks: There will be a \$20.00 charge on all returned checks.

Prices are subject to change without notice.

Uncertain about what to buy a FORD enthusiast?



C & G
EARLY FORD PARTS

C & G Early Ford Parts
1941 Commercial St.
Escondido, CA 92029-1233
(760) 740-2400

Date _____

This Certificate Entitles _____ Dollars \$

To Merchandise
Valued at _____

Presented By _____

Use only for merchandise account credit. Expiration date: _____

Gift Certificate

Authorized Signature _____

Available in any dollar amount

Gift Certificates Available!



**C&G Early Ford Parts
T-Shirt design
See page 13 for T-Shirt
ordering information.**