

# Table of Contents

## Categorized Listing

MISCELLANEOUS HARDWARE TABLE OF CONTENTS	1201	SHELF SUPPORTS, RIGID	1217
ACCESS DOORS	1205	<i>STERLING 11" SHELF SUPPORTS</i>	1217
<i>ELMDOR ACCESS DOORS</i>	1205	SHELF BRACKETS, DECORATIVE	1217
ATTIC LADDERS	1206	<i>STANLEY DECORATIVE SHELF BRACKETS</i>	1217
<i>WERNER ATTIC MASTER LADDERS</i>	1206	SHELF BRACKETS, UTILITY	1218
CASTERS, BALL	1207	<i>STANLEY UTILITY SHELF BRACKETS</i>	1218
<i>SHEPHERD BALL CASTERS</i>	1207	CORBELS, KEYHOLE	1218
CASTERS, TWIN WHEEL	1207	<i>NW WOOD SHELF BRACKETS</i>	1218
<i>SHEPHERD CASTERS</i>	1207	SHELF BRACKETS, PINE	1219
CASTERS, INDUSTRIAL	1208	<i>NW WOOD SHELF BRACKETS</i>	1219
<i>SHEPHERD CASTERS</i>	1208	CORNER BRACES	1219
CASTERS, MEDIUM DUTY	1208	<i>BRAINERD CORNER BRACES</i>	1219
<i>SHEPHERD CASTERS</i>	1208	<i>KNAPE &amp; VOGT CORNER BRACES</i>	1219
FURNITURE, CARPET CUPS	1209	<i>STANLEY CHAIR LEG BRACES</i>	1219
<i>SHEPHERD CARPET &amp; RUG CUPS</i>	1209	<i>BAINBRIDGE CORNER BRACES</i>	1219
GLIDES, CUSHIONED	1209	<i>STANLEY CORNER BRACES</i>	1220
<i>SHEPHERD CUSHIONED GLIDES</i>	1209	CORNER PLATES	1222
GLIDES, NAIL-ON	1209	<i>STANLEY FLAT CORNER IRONS</i>	1222
<i>SHEPHERD NAIL-ON GLIDES FOR WOODEN LEGS</i>	1209	<i>STANLEY MENDING PLATES</i>	1223
GLIDES, NYLON	1209	TEE PLATES	1223
<i>SHEPHERD NYLON GLIDES</i>	1209	<i>STANLEY TEE PLATES</i>	1223
RUBBER TIPS	1210	CORNERS, BOX	1224
<i>SHEPHERD RUBBER TIPS FOR TUBULAR LEGS</i>	1210	<i>BRAINERD BOX CORNERS</i>	1224
LEVELERS	1210	RING PULL	1224
<i>GRASS BASE LEVELER</i>	1210	<i>STANLEY TRAP DOOR RING PULLS</i>	1224
CLOSET ROD, EPCO	1210	CHEST HANDLES	1224
<i>EPCO CLOSET ROD TUBING</i>	1210	<i>STANLEY CHEST HANDLES</i>	1224
CLOSET ROD, FLANGES	1211	DOORBELL BUTTONS	1224
<i>EPCO CLOSET ROD FLANGES</i>	1211	<i>BALDWIN DOORBELL BUTTONS</i>	1224
CLOSET ROD, KV	1211	<i>NUTONE PUSHBUTTONS</i>	1225
<i>HAFELE CLOSET ROD</i>	1211	<i>SPORE PUSH BUTTONS</i>	1225
CLOSET ROD, FLANGES	1211	<i>SPORE PUSHBUTTONS</i>	1225
<i>EPCO CLOSET ROD FLANGES</i>	1211	DOORBELL RINGER	1226
CLOSET ROD, KV	1211	<i>SPORE DOORBELL RINGER</i>	1226
<i>KNAPE &amp; VOGT CLOSET ROD TUBING</i>	1211	DOOR CHIME ACCESSORIES	1226
CLOSET RODS, ADJUSTABLE	1213	<i>NUTONE DOOR CHIME ACCESSORIES</i>	1226
<i>STANLEY ADJUSTABLE ROUND CLOSET ROD</i>	1213	DOOR CHIMES	1226
CLOSET ROD, STANLEY	1213	<i>NUTONE DOOR CHIMES</i>	1226
<i>CLOSET ROD TUBING</i>	1213	<i>NUTONE WIRELESS DOOR CHIMES</i>	1227
CLOTHING CARRIER	1213	DOOR GRILLES	1227
<i>KNAPE &amp; VOGT CLOTHING CARRIER</i>	1213	<i>TRIMCO DOOR GRILLES</i>	1227
POLE SOCKETS	1213	DOOR GUARD	1227
<i>BAINBRIDGE POLE SOCKETS</i>	1213	<i>DELTANA HEAVY DUTY DOOR GUARD</i>	1227
<i>IVES POLE SOCKETS</i>	1214	DOOR KNOCKERS	1227
<i>TAYMOR POLE SOCKETS</i>	1214	<i>BALDWIN DOOR KNOCKERS</i>	1227
<i>S &amp; S WOOD POLE SOCKETS</i>	1214	<i>DELTANA DOOR KNOCKER WITH VIEWER</i>	1228
SHELF AND ROD SUPPORTS	1214	<i>IVES DOOR KNOCKERS</i>	1228
<i>HAGER CLOSET SHELF AND ROD SUPPORTS</i>	1214	<i>SCHLAGE DOOR KNOCKERS</i>	1229
<i>HAFELE ADJUSTABLE CLOSET ROD SUPPORT</i>	1214	DOOR VIEWERS	1229
<i>STERLING HD ADJUSTABLE ROD SUPPORT</i>	1215	<i>BALDWIN OBSERV-O-SCOPE</i>	1229
<i>STERLING HD NON-ADJUSTABLE SHELF AND ROD SUPPORT</i>	1215	<i>BRAINERD DOOR VIEWERS</i>	1229
<i>STERLING ADJUSTABLE ROD SUPPORT</i>	1215	<i>DELTANA DOOR VIEWER</i>	1230
<i>TSM CHROME PLATED CLOSET SHELF AND ROD SUPPORT</i>	1215	<i>IVES DOOR VIEWERS</i>	1230
<i>TAYMOR CLOSET SHELF AND ROD SUPPORTS</i>	1215	<i>M.A.G. IND. DOOR VIEWERS</i>	1230
SHELF BRACKETS, FOLDING	1216	DOOR VIEWERS	1231
<i>KNAPE &amp; VOGT SHELF BRACKETS</i>	1216	<i>M.A.G. IND. DOOR VIEWERS</i>	1231
<i>STANLEY H.D. FOLDING SHELF BRACKETS</i>	1216	<i>SCHLAGE DOOR VIEWERS</i>	1231
<i>ULTRA FOLDING SHELF BRACKETS</i>	1216	<i>SLIDECO DOOR VIEWER</i>	1231
SHELF BRACKETS, RIGID	1216	<i>STANLEY DOOR VIEWERS</i>	1231
<i>HAGER SHELF BRACKETS</i>	1216	<i>TAYMOR DOOR VIEWERS</i>	1231
<i>KNAPE &amp; VOGT SHELF BRACKETS</i>	1216	<i>HOME PROTECTOR "PEEKO" DOOR VIEWER</i>	1231
<i>FASTCAP SPEED BRACE SHELF BRACKETS</i>	1216	CHAIN DOOR GUARDS	1232
<i>KNAPE &amp; VOGT SHELF BRACKETS</i>	1217	<i>BRAINERD CHAIN DOOR GUARDS</i>	1232
<i>STANLEY H.D. RIGID SHELF BRACKETS</i>	1217	<i>BRAINERD CHAIN DOOR GUARDS WITH BOLT</i>	1232
		<i>SCHLAGE CHAIN DOOR GUARDS</i>	1232
		<i>STANLEY CHAIN DOOR GUARD</i>	1232
		FLIP LOCKS	1232
		<i>M.A.G. IND. FLIP LOCKS</i>	1232

# Table of Contents

## Categorized Listing

SLIDE-CO FLIP LOCKS	1233	TABLE BRACE	1255
DOOR CLUB	1233	STANLEY DROP LEAF TABLE BRACE	1255
WINNER THE DOOR CLUB	1233	TABLE HINGES, DROP LEAF	1255
JAMB ARMOR	1233	HAFELE DROP LEAF TABLE HINGE	1255
ARMOR CONCEPTS JAMB ARMOR	1233	TABLE HINGES, FLIP TOP	1255
ARMOR CONCEPTS JAMB ARMOR COMBO SETS	1233	SELBY FLIP TOP TABLE HINGES	1255
SLIDING DOOR BAR	1234	TABLE LEG BRACES	1255
M.A.G. IND. SLIDING DOOR BAR	1234	STANLEY TABLE LEG BRACES AND SUPPORTS	1255
SLIDING DOOR LOCKS	1234	HOOKS, COAT AND HAT	1255
M.A.G. IND. SLIDING DOOR LOCKS	1234	BULLDOG COAT AND HAT HOOKS	1255
SLIDE-CO GLASS DOOR LOCKS	1234	AMEROCK COAT AND HAT HOOKS	1256
LOCKS, PATIO DOOR	1234	BALDWIN COAT AND HAT HOOKS	1256
M.A.G. IND. SLIDING PATIO DOOR PIN LOCK	1234	DELTANA COAT HOOKS	1256
SLIDE-CO PATIO DOOR LOCKING PIN	1234	IVES COAT AND HAT HOOKS	1256
WRIGHT SLIDING PATIO DOOR PIN LOCK	1234	SCHLAGE COAT AND HAT HOOKS	1257
WRIGHT REPLACEMENT PATIO DOOR HARDWARE	1234	IVES COAT AND HAT HOOKS	1257
SLIDING WINDOW LOCKS	1235	STANLEY COAT AND HAT HOOKS	1257
M.A.G. IND. SLIDING WINDOW LOCKS	1235	HOOKS, COAT AND HAT	1258
HOUSE NUMBERS	1235	HOOKS, GARMENT	1258
BALDWIN HOUSE NUMBERS	1235	KNAPE & VOGT GARMENT HOOKS	1258
BRAINERD HOUSE NUMBERS	1236	STANLEY GARMENT HOOK	1258
SCHLAGE HOUSE NUMBERS	1237	HOOKS, MAGNETIC	1259
STANLEY HOUSE NUMBERS	1238	STANLEY MAGNETIC HOOK	1259
HOUSE NUMBERS & LETTERS	1238	HOOKS, SELF-ADHESIVE	1259
DELTANA HOUSE NUMBERS	1238	STANLEY SELF-ADHESIVE HOOK	1259
HOUSE NUMBERS & LETTER	1239	STANLEY SELF-ADHESIVE UTILITY HOOK	1259
DELTANA HOUSE NUMBERS	1239	HOOKS, MAGNETIC	1260
HOUSE NUMBERS & LETTERS	1239	STANLEY MAGNETIC HOOK	1260
DELTANA HOUSE LETTERS	1239	HOOKS, OVER-THE-DOOR	1260
MOUNTAIN HOME WOOD HOUSE NUMBERS AND LETTERS	1239	STANLEY OVER-THE-DOOR HOOK	1260
TAYMOR HOUSE NUMBERS & LETTERS	1242	STANLEY OVER-THE-DOOR CLOTHES HOOK	1260
MAIL BOXES, APARTMENT	1245	HOOKS, ROBE	1260
BOMMER APARTMENT HOUSE MAIL BOXES	1245	STANLEY ROBE HOOKS	1260
KEY BLANKS, BOMMER	1247	HOOKS, UTILITY	1261
HUDSON KEY BLANKS FOR BOMMER MAILBOXES	1247	KNAPE & VOGT UTILITY HOOK	1261
MAIL BOXES	1247	HOOKS, WARDROBE	1261
ARCHITECTURAL MAIL BOXES	1247	IVES WARDROBE HOOKS	1261
FULTON MAIL BOXES	1247	SCHLAGE WARDROBE HOOKS	1261
SALSBURY HOME MAIL BOXES	1248	HOOKS, WARDROBE	1262
MAIL SLOTS	1248	IVES WARDROBE HOOKS	1262
BALDWIN MAIL SLOTS	1248	SCHLAGE WARDROBE HOOKS	1262
LAWRENCE (ULTRA) MAIL SLOT	1248	HOOKS, CEILING	1262
IVES MAIL SLOTS	1249	IVES CEILING HOOKS	1262
SCHLAGE MAIL SLOTS	1249	HOOKS, WIRE COAT	1262
HANDRAIL BRACKETS	1249	IVES WIRE COAT HOOKS	1262
ACORN HANDRAIL BRACKET	1249	STANLEY WIRE COAT AND HAT HOOKS	1262
BULLDOG HANDRAIL BRACKETS	1249	MOP HOLDER	1262
CAL-ROYAL HAND RAIL BRACKETS	1250	BASSICK TOOL OR MOP HOLDER	1262
DELTANA HANDRAIL BRACKETS	1250	BROOM HOLDER	1263
IVES HAND RAIL BRACKETS	1250	STANLEY BROOM HOLDER	1263
SCHLAGE HAND RAIL BRACKETS	1251	STORAGE HOOKS	1263
IVES HAND RAIL BRACKETS	1251	LEHIGH WHEELBARROW HOLDER	1263
STANLEY HAND RAIL BRACKETS	1252	LUMB-R-GRIP TOOLESS HANGERS	1263
STANLEY H.D. HANDRAIL BRACKETS	1252	STANLEY HEAVY DUTY STORAGE HOOKS	1263
TAYMOR HANDRAIL BRACKETS	1252	STANLEY OVERHEAD STORAGE HOOKS	1263
JULIUS BLUM HANDRAIL BRACKETS	1252	STANLEY LADDER STORAGE HOOKS	1264
FLAP HINGE	1253	STANLEY TOOL STORAGE HOOKS	1264
GRASS FLAP HINGE	1253	STANLEY UTILITY STORAGE HOOKS	1264
FLAP STAYS	1253	STANLEY ALL-PURPOSE STORAGE HOOKS	1265
SELBY FLAP STAYS WITH BRAKING ACTION	1253	STANLEY STORAGE CLIP	1265
LID SUPPORTS	1253	STANLEY MAGNETIC TOOL BAR	1265
BRAINERD LID SUPPORTS	1253	STANLEY SUPER GRIP TOOL HOLDER	1265
KNAPE & VOGT STEEL SUPPORT HINGE	1254	STANLEY MULTI HOLDER RAIL TOOL HOLDER	1266
SELBY LID SUPPORTS	1254	PEGBOARD HOOKS	1267
STANLEY LID SUPPORTS	1254	STANLEY PEGBOARD HOOKS	1267
		MURPHY BED HARDWARE	1268
		SELBY MURPHY BED SYSTEM	1268
		IRONING CENTERS	1268

## Table of Contents

### Categorized Listing

<i>IRON-A-WAY BUILT-IN IRONING CENTERS</i>	1268
<i>NUTONE BUILT-IN IRON CENTERS</i>	1270
IRONING CENTERS	1271
<i>NUTONE BUILT-IN IRON CENTERS</i>	1271
VACUUM SYSTEMS, POWER UNITS	1272
<i>NUTONE BUILT-IN CENTRAL CLEANING SYSTEM</i>	1272
VACUUM SYSTEMS, ACCESSORIES	1273
<i>NUTONE BUILT-IN CENTRAL CLEANING SYSTEM</i>	1273
VACUUM SYSTEMS, ACCESSORIES	1274
<i>NUTONE BUILT-IN CENTRAL CLEANING SYSTEM</i>	1274
VACUUM SYSTEMS, ROUGH-IN	1274
<i>NUTONE BUILT-IN CENTRAL CLEANING SYSTEM</i>	1274
<i>NUTONE BUILT-IN CENTRAL CLEANING SYSTEM</i>	1275
VACUUM SYSTEMS, ROUGH-IN	1276
TARPS	1278
<i>FOREMOST TARPS</i>	1278
PAPER BAGS	1279
<i>XPEDX PAPER BAGS</i>	1279
<i>SAALFELD PAPER BAGS</i>	1279
PAPER, WRAPPING	1280
<i>XPEDX BROWN WRAPPING PAPER</i>	1280

---



**ACCESS DOORS**

**ELMDOR ACCESS DOORS**

**Dry Wall Access Doors (DW Series)**

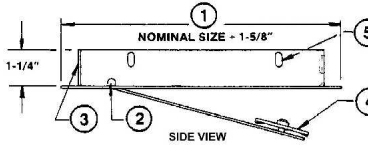
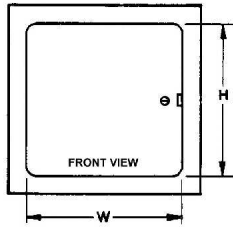

Doors are ideally suited for new installations or for remodeling, in masonry, tile, wood or other wall surfaces. Door features rounded safety corners.  
**Door and Frame** is fabricated from 16 gauge, galvanized steel with a prime coat finish.  
**Frame** is one-piece construction, 1" wide and provides perfect concealment of the rough wall opening. Wall frame is provided with 1/4" mounting holes for fastening within the furred spaces allowing faster installation and giving maximum clearance.  
**Concealed Pivoting Rod Hinge** prevents distortion and closes door squarely. Doors 24" or larger are provided with a continuous piano hinge.  
**Latch** is screwdriver operated.  
**Finish** is a prime coat suitable for painting.

1. Overall outside size
2. Concealed pivoting rod hinge
3. Wall frame
4. Screwdriver operated latch
5. 1/4" mounting holes

**DW = Drywall Access Door**  
**PC = Prime Coat**  
**SDL = Screwdriver Latch**

BHS#	DESCRIPTION	U/M	BOX	RETAIL
561-606	ELMDOR DW 6 X 6 PC SDL ACCESS DR	ea	1	\$32.16
561-10808	ELMDOR DW 8 X 8 PC SDL ACCESS DR	ea	1	\$33.42
561-11212	ELMDOR DW 12 X 12 PC SDL ACCESS DR	ea	1	\$39.56
561-11414	ELMDOR DW 14 X 14 PC SDL ACCESS DR	ea	1	\$50.92
561-11616	ELMDOR DW 16 X 16 PC SDL ACCESS DR	ea	1	\$60.30
561-12424	ELMDOR DW 24 X 24 PC SDL ACCESS DR	ea	1	\$99.16

**Fire Rated Ceiling Access Doors (FRC Series)**

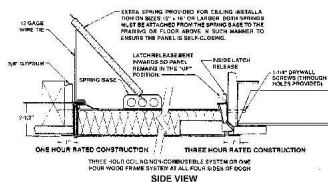
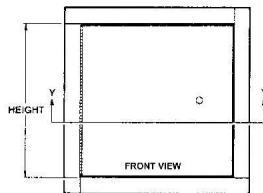

Doors are rated by Underwriters Laboratories for 1.5 hours, "B" label in walls, and by Warnock Hershey for 3 hours in ceilings. The FRC Series Doors should be utilized when providing access in fire rated walls and ceilings. FRC Series Doors have heavy-duty spring closures to ensure positive latching when panel closes. An interior latch release is also included on all doors to enable unlocking from inside.  
**Door** is fabricated from 20 gauge, phosphate-treated steel with a prime coat finish.  
**Door panel** is provided with two inches of insulation in a sandwich type construction.  
**Frame** is fabricated from 16 gauge, phosphate-treated steel with a prime coat finish and provided with masonry anchors and boltholes.  
**Hinge** is a continuous piano type and mounted on the long side of the rectangular door panel.  
**Exterior Latch** is recessed and is operated using a ring attached to the sliding bolt.  
**Interior Latch Release Slide** is included enabling door to be opened from the inside.

**FRC = Fire Rated Ceiling Door**  
**PC = Prime Coat**  
**D/U = Dual Lock**

BHS#	DESCRIPTION	U/M	BOX	RETAIL
561-41212	ELMDOR FRC 12 X 12 PC DUL ACCESS DR	ea	1	\$175.54
561-41818	ELMDOR FRC 18 X 18 PC DUL ACCESS DR	ea	1	\$227.80
561-42230	ELMDOR FRC 22 X 30 PC DUL ACCESS DR ; FOO	ea	1	\$407.35
561-42424	ELMDOR FRC 24 X 24 PC DUL ACCESS DR	ea	1	\$321.59

**ACCESS DOORS**

**ELMDOR ACCESS DOORS**

**Fire Rated Wall Access Doors (FR Series)**

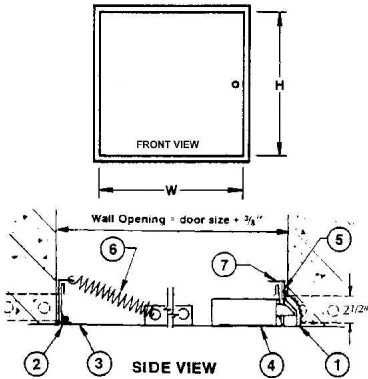

**Doors** are Fire Rated by Underwriters Laboratories Inc. for 1 1/2 hours, "B" Label, and meet ANSI - UL 10B standard. Door has a heavy duty spring closer to assure positive latching when panel closes.  
**Door and Frame** is fabricated from 16 gauge, galvanized steel with a prime coat finish.  
**Door** has a heavy-duty spring to assure positive latching.  
**Frame** is equipped with both masonry anchors and boltholes to facilitate installation in all kinds of wall construction.  
**Concealed Hinge** operates completely out of sight so that only the door and frame is visible.  
**Exterior Latch** is recessed and is operated using a ring attached to the sliding bolt.  
**Interior Latch Release Slide** is included enabling door to be opened from the inside.  
**Finish** is a prime coat suitable for painting.

1. Chip out masonry to clear bolt cover
2. Concealed hinge
3. Door
4. Recessed latch
5. Interior latch release slide
6. Closing spring
7. Frame

**FR = Fire Rated**  
**PC = Prime Coat**  
**RTL = Recess Turn Latch**

BHS#	DESCRIPTION	U/M	BOX	RETAIL
561-31212	ELMDOR FR 12 X 12 PC RTL ACCESS DR; FOO	ea	1	\$127.30

**Surf Access Doors (SF Series)**

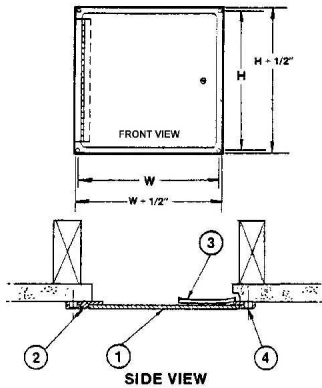

**Doors** are designed for surface installation on drywall, masonry or thin-coat plaster. Door features rounded safety corners and is attached to the frame with a continuous piano hinge allowing a 175° opening.  
**Door and Frame** are fabricated from 14 gauge, galvanized steel.  
**Frame** is easily secured to the studs and anchored through pre-drilled holes in each corner. No additional reinforcement is required.  
**Latch** is screwdriver operated.  
**Finish** is a prime coat suitable for painting.

1. Door
2. Piano Hinge
3. Screwdriver operated latch
4. Mounting holes

**SF = Surf Access Door**  
**PC = Prime Coat**  
**SDL = Screwdriver Latch**

*"Other Sizes and Styles Available. Ask your salesperson for details."*

BHS#	DESCRIPTION	U/M	BOX	RETAIL
561-80808	ELMDOR SF 8 X 8 PC SDL ACCESS DR; FOO	ea	1	\$40.20
561-81212	ELMDOR SF 12 X 12 PC SDL ACCESS DR	ea	1	\$54.94
561-82424	ELMDOR SF 24 X 24 PC SDL ACCESS DR FOO	ea	1	\$140.43

**ATTIC LADDERS**

**WERNER ATTIC MASTER LADDERS**

Pine

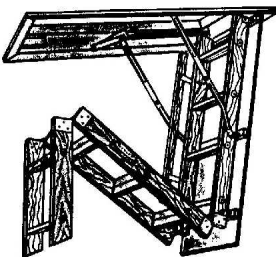

Overhead access to attic, loft, carport, garage, cabin. Easy open/close with unique offset spring bar designed to lock ladder in either the up or down position. High quality fir plywood 1/4" door has a full width 90° wraparound hinge that minimizes heat loss. Heavy duty plate hinges bear on each other to avoid wood crushing. Ensures rigid structure. Steel rods inserted in bottom groove of wood steps increases step strength and tightens the step to siderail connection. Select pine, grooved slip-resistant, flush steps and quality finished rails with eased edges. Individual merchandising carton with installation manual inside. Fully assembled ready to install.

BHS#	DESCRIPTION	U/M	BOX	RETAIL
872-1000	WERNER W2208 22.5x54x8'5" STAIRS	ea	1	\$329.92
872-1100	WERNER W2210 22.5x54x10'0" STAIRS	ea	1	\$345.66
872-2000	WERNER W2508 25x54x8'5" STAIRS	ea	1	\$345.66
872-2100	WERNER W2510 25x54x10'0" STAIRS; FOO	ea	1	\$361.16
872-4000	WERNER WH3008 30.5x54x8'5" STAIRS	ea	1	\$533.61
872-4100	WERNER WH3010 30.5x54x10'0" STAIRS	ea	1	\$569.36

**ATTIC LADDERS**

**WERNER ATTIC MASTER LADDERS**

**Aluminum**



Available in aluminum as Factory Order Only.

BHS#	DESCRIPTION	U/M	BOX	RETAIL
872-540	WERNER A2512 25x66x12'0 STAIRS;FOO	ea	1	\$1,118.22

**Additional Information for Werner Attic Ladders**



Model No.	Rough Opening Width-Length	Floor to Floor Height Range	Floor to Ceiling Height Range	Approx. Ladder Width	Approx. Shipping Wt.	Weight Capacity
W2208	22-1/2" x 54"	7' 4" x 8' 9"	7' to 8' 5"	14-1/4"	56	250 lbs.
W2210	22-1/2" x 54"	8' 9" x 10' 6"	8' 5" ' to 10' 3"	14-1/4"	59	250 lbs.
W2508	25" x 54"	7' 4" x 8' 9"	7' to 8' 5"	16-3/4"	59.5	250 lbs.
W2510	25" x 54"	8' 9" x 10' 6"	8' 5" to 10' 3"	16-3/4"	62.5	250 lbs.
WH3008	30-1/2" x 54"	7' 4" to 8' 9"	7' to 8' 5"	22-1/4"	73.5	300 lbs.
WH3010	30-1/2" x 54"	8' 9" to 10' 6"	8' 5" to 10' 3"	22-1/4"	76.5	300 lbs.

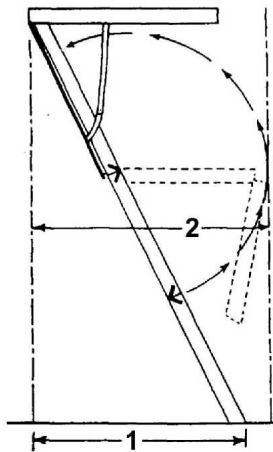

Ceiling Height	Landing Space (1)	Projection (2)
8' 5"	4' 5"	5' 2"
10'	5' 3"	6' 2"

**CASTERS, BALL**

**SHEPHERD BALL CASTERS**

**2" Dia. Metal Wheel**

Specifically designed to add mobility to medium weight furniture on carpets; small sofas, chairs, TV stands, servers, dinette carts, etc. Load rating: 75 lbs. ea. Mounting height: approx. 2 1/2".

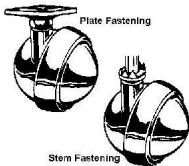

BHS#	DESCRIPTION	U/M	BOX	RETAIL
318-580	SHEP 9305 2" METAL CASTER; PLATE;AC	cd	6	\$12.05

**CASTERS, TWIN WHEEL**

**SHEPHERD CASTERS**

**2" Twin Wheel for Medium Weight Furniture.** With square plate fastening - 1 1/2" square plate with 4 holes for use with No. 8 flat wood screws. With stem fastening - 1 1/2" long, with 3/8" diameter sockets. Body and wheels are made of tough nylon. For use on small sofas, chairs, TV stands, servers, carts, etc. Load rating 75 lbs. ea. Mounting height: approx. 2 3/4" for plate, 2 1/2" for stem. Packaged 2 per card.

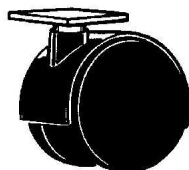

BHS#	DESCRIPTION	U/M	BOX	RETAIL
318-999	SHEP 9417 2" PLASTIC CASTER; PLATE	cd	6	\$6.10

**CASTERS, INDUSTRIAL**

**SHEPHERD CASTERS**

**Economy Swivel Models**

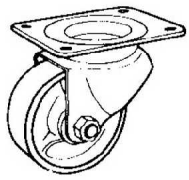

BHS#	DESCRIPTION	U/M	BOX	RETAIL
318-910	SHEP 9392 2" SWIVEL CASTER; PLATE LR=125#	ea	36	\$2.88
318-920	SHEP 9393 2-1/2" SWIVEL CASTER PLATE; LR=175#	ea	12	\$5.40

**Medium-Heavy Duty Rigid Models**

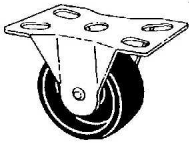

BHS#	DESCRIPTION	U/M	BOX	RETAIL
318-1120	SHEP 9481 2" RIGID CASTER; PLATE LR=125#	ea	16	\$3.55
318-1130	SHEP 9482 2-1/2" RIGID CASTER; PLATE LR=175#	ea	8	\$7.00
318-1140	SHEP 9483 3" RIGID CASTER; PLATE LR=210#	ea	8	\$8.93
318-1150	SHEP 9484 4" RIGID CASTER; PLATE LR=255#	ea	5	\$15.20

**Medium-Heavy Duty Swivel Models**



BHS#	DESCRIPTION	U/M	BOX	RETAIL
318-1070	SHEP 9477 2" SWIVEL CASTER; PLATE LR=125#	ea	30	\$4.00
318-1080	SHEP 9478 2-1/2" SWIVEL CASTER PLATE LR=175#	ea	50	\$7.65
318-1090	SHEP 9479 3" SWIVEL CASTER; PLATE LR=210#	ea	20	\$9.55
318-1100	SHEP 9480 4" SWIVEL CASTER; PLATE LR=255#	ea	10	\$17.25

**Rubber Wheel Swivel Casters with Brake**

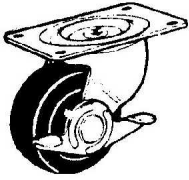

BHS#	DESCRIPTION	U/M	BOX	RETAIL
318-1189	SHEP 9510 2-1/2" SWIVEL/LK CASTER PLATE; LR=175#	ea	20	\$7.80
318-1190	SHEP 9511 3" SWIVEL/LOCK CASTER PLATE; LR=210#	ea	20	\$10.28
318-1191	SHEP 9512 4" SWIVEL/LOCK CASTER PLATE; LR=255#	ea	10	\$19.03

**CASTERS, MEDIUM DUTY**

**SHEPHERD CASTERS**

**Medium Duty Double Race Ball Bearing Wheel Casters**

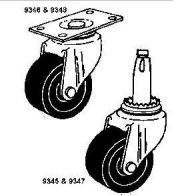

Black soft rubber wheel for hard floors. Double race ball bearing construction allows instant swiveling. One set of 2 per card. Color finish: Copper Oxide. With Rectangular Plate Fastening: 2" x 1 3/16" rectangular plate with 4 holes for wood screws. With Stem Fastening: 1 1/2" long, with 3/8" dia. socket.

**1 5/8" Wheel** - For lighter weight furniture. Load rating: 70 lbs. ea. Mounting height: approx. 2 5/16".

**2" Wheel** - For medium weight furniture. Load rating: 80 lbs. ea. Mounting height: approx. 2 5/16".

BHS#	DESCRIPTION	U/M	BOX	RETAIL
318-880	SHEP 9347 1-5/8" WHEEL CASTER STEM FOO	cd	6	\$9.38
318-890	SHEP 9348 1-5/8" WHEEL CASTERS PLATE; FOO	cd	6	\$9.38
318-860	SHEP 9345 2" WHEEL CASTERS; STEM	cd	6	\$9.63
318-870	SHEP 9346 2" WHEEL CASTERS; PLATE	cd	6	\$9.63



**FURNITURE, CARPET CUPS**

**SHEPHERD CARPET & RUG CUPS**

**Cushioned Rubber Cups, Brown, for Hard Floors**

Floor cups are used under furniture legs to prevent crushing and wearing of carpet pile, as well as to protect hard floors from scratches and dents. On carpets use spiked cups; on hard floors use plain vinyl, carpet base metal or cushioned rubber cups; on both carpets and hard floors use plain plastic cups. Packaged 4 per card. Items marked F.O.O. - Allow 3 - 4 weeks for delivery, full box only.

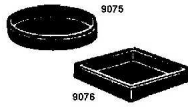

BHS#	DESCRIPTION	U/M	BOX	RETAIL
318-110	SHEP 9075 RUBBER CUPS; 1-1/2" I.D.	cd	6	\$2.00

**GLIDES, CUSHIONED**

**SHEPHERD CUSHIONED GLIDES**

Non-rust nickel base, threaded stem cushion glides. For office and household furniture on carpeted surfaces. Packaged 4 per card.

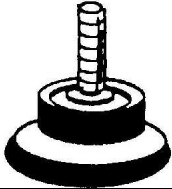

BHS#	DESCRIPTION	U/M	BOX	RETAIL
318-1050	SHEP 9449 CUSHION GLIDES	cd	6	\$3.25

**GLIDES, NAIL-ON**

**SHEPHERD NAIL-ON GLIDES FOR WOODEN LEGS**

**Carpet Base**

Packed 4 per card.



BHS#	DESCRIPTION	U/M	BOX	RETAIL
318-340	SHEP 9103 1" NAIL ON GLIDES; 4/cd	cd	6	\$2.18

**Rubber Cushion Nickel Base**

Packed 4 per card.



BHS#	DESCRIPTION	U/M	BOX	RETAIL
318-280	SHEP 9099 7/8" NAIL GLIDE	cd	6	\$1.85
318-290	SHEP 9100 1-1/16" NAIL GLIDE	cd	6	\$2.10
318-300	SHEP 9101 1-1/4" NAIL GLIDE	cd	6	\$2.43

**White Plastic**

Packed 4 per card.



BHS#	DESCRIPTION	U/M	BOX	RETAIL
318-320	SHEP 9102 7/8" TACK GLIDES	cd	6	\$1.00

**GLIDES, NYLON**

**SHEPHERD NYLON GLIDES**

Nail on glides for wooden legs. Non-rust nylon base. Set of 4 per card, 6 cards per shelf pack. Size 1 1/8".

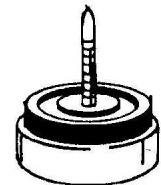

BHS#	DESCRIPTION	U/M	BOX	RETAIL
318-1030	SHEP 9448 CUSHION NAIL-ON GLIDE	cd	6	\$1.88

**RUBBER TIPS**

**SHEPHERD RUBBER TIPS FOR TUBULAR LEGS**



White. packed 4 per card. F.O.O. Items - Allow 4 weeks for delivery.

BHS#	DESCRIPTION	U/M	BOX	RETAIL
318-440	SHEP 9119 3/4" RUBBER TIPS; FOO	cd	6	\$2.00
318-450	SHEP 9120 7/8" RUBBER TIPS	cd	6	\$2.18
318-460	SHEP 9121 1" RUBBER TIPS	cd	6	\$2.28

**LEVELERS**

**GRASS BASE LEVELER**

N/A



400 lb. load rating. Height adjustable 90-100mm (3 5/8" - 4".)

BHS#	DESCRIPTION	U/M	BOX	RETAIL
605-17050	GRASS 499.133.94.0115 LEVELERS;4/ST 605-17050; FOO (MEPLA)	st	25	\$17.60

**CLOSET ROD, EPCO**

**EPCO CLOSET ROD TUBING**

**1-1/16" Dia. Bright Stainless Steel Clad, 13 Gauge**

Note: For our complete line of shower rods, see our Bath Accessories Section.



BHS#	DESCRIPTION	U/M	BOX	RETAIL
106-370	EPCO 870-4 SS 1-1/16"DIA 48" TUBING	ea	1	\$37.66
106-371	EPCO 870-5 SS 1-1/16"DIA 60" TUBING	ea	1	\$47.06
106-372	EPCO 870-6 SS 1-1/16"DIA 72" TUBING	ea	1	\$56.48
106-374	EPCO 870-8 SS 1-1/16"DIA 96" TUBING	ea	1	\$75.31
106-376	EPCO 870-10 SS 1-1/16"DIA 120" TUBING	ea	1	\$94.11
106-378	EPCO 870-12 SS 1-1/16"DIA 144" TUBING; FOO	ea	1	\$112.95

**1-1/16" Dia. Polished Chrome Plated Steel, 14 Gauge**



BHS#	DESCRIPTION	U/M	BOX	RETAIL
106-390	EPCO 890-4 PC 1-1/16"DIA 48" TUBING ; CUT FROM 890-8	ea	1	\$13.00
106-391	EPCO 890-5 DT PC 1-1/16"DIA 60" ~ TUBING	ea	1	\$16.26
106-392	EPCO 890-6 DT PC 1-1/16"DIA 72" ~ TUBING	ea	1	\$19.51
106-394	EPCO 890-8 PC 1-1/16"DIA 96" TUBING	ea	1	\$26.02
106-396	EPCO 890-10 PC 1-1/16" 120" TUBING	ea	1	\$32.52
106-398	EPCO 890-12 PC 1-1/16" 144" TUBING	ea	1	\$39.02

**1-5/16" Dia. Polished Chrome Plated Steel, 14 Gauge**



BHS#	DESCRIPTION	U/M	BOX	RETAIL
106-352	EPCO 895-6 PC 1-5/16"DIA 72" TUBING	ea	5	\$24.53
106-354	EPCO 895-8 PC 1-5/16"DIA 96" TUBING	ea	5	\$32.70
106-356	EPCO 895-10 PC 1-5/16" 120" TUBING	ea	5	\$40.88
106-358	EPCO 895-12 PC 1-5/16" 144" TUBING	ea	5	\$49.05

**1 5/16" Dia. Oil-Rubbed Bronze, 14 Gauge**

Diameter: 1-5/16" (33mm), Length: 96" (2438mm)



DESCRIPTION	U/M	BOX	RETAIL
EPCO 895-8 ORB 1-5/16"DIA 96" TUBING; OIL RUBBED BRONZE	ea	5	\$41.09

**CLOSET ROD, FLANGES**

**EPCO CLOSET ROD FLANGES**

**For 1" and 1 1/16" Tubing**

Polished chrome plated steel.



BHS#	DESCRIPTION	U/M	BOX	RETAIL
106-160	EPCO 850 PC 1-1/16" FLANGE; OPEN END	ea	50	\$2.83
106-170	EPCO 860 PC 1-1/16" FLANGE; CLOSED END	ea	50	\$2.60

**CLOSET ROD, KV**

**HAFELE CLOSET ROD**

**Oval Tubing**

Dimension: 30 x 15 x 2500, 98 7/16" Length, Material: steel.

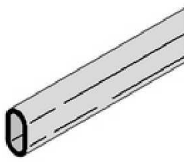

BHS#	DESCRIPTION	U/M	BOX	RETAIL
141-129211	HAFELE 802.04.208 SURF MTD CTR BRKT	ea	1	\$3.17
141-189541	HAFELE 801.13.201 OVAL TUBE 2.5m STEEL CHROME-PLATED.30x15x1.0 (same as EPCO 830-8)	ea	1	\$8.36
141-90350	HAFELE 803.33.210 CHROME TUBE SUPPORT ( same as epco 841)	ea	1	\$.68

**CLOSET ROD, FLANGES**

**EPCO CLOSET ROD FLANGES**

**For 1 1/4" and 1 5/16" Tubing**

Polished chrome plated steel.



BHS#	DESCRIPTION	U/M	BOX	RETAIL
106-162	EPCO 851 PC 1-5/16" FLANGE; OPEN EN	ea	50	\$5.53
.	EPCO 851 ORB 1-5/16" FLANGE; OPEN END; OIL RUBBED BRONZE	ea	50	\$3.09
106-172	EPCO 861 PC 1-5/16" FLANGE; CLOSED END	ea	50	\$5.54
.	EPCO 861 ORB 1-5/16" FLANGE; CLOSED END; OIL RUBBED BRONZE	ea	50	\$2.91

**For 1 1/16" and 1 5/16" Tubing**

Stainless steel. Closed flange for 1" and 1 1/16" tubing.



BHS#	DESCRIPTION	U/M	BOX	RETAIL
106-197940	EPCO 856 SS 1-1/16 STAINLESS STEEL FLANGE	ea	50	\$20.83

**CLOSET ROD, KV**

**KNAPE & VOGT CLOSET ROD TUBING**

**1-1/16" Bright Stainless Steel Tubing .087" Thickness**

Bright stainless finish 29/32" inside diameter, 1 1/16" outside diameter. Parts available for adapting for use on wall brackets. Contact us for further information. **Note: For our complete line of shower rods, see our Bath Accessories Section.**



BHS#	DESCRIPTION	U/M	BOX	RETAIL
194-1032	KV 660 SS 48" TUBING (cut from 96")	ea	6	\$26.88
194-1033	KV 660 SS 60" TUBING (cut from 120")	ea	6	\$33.60
194-1034	KV 660 SS 72" TUBING	ea	6	\$45.41
194-1035	KV 660 SS 96" TUBING	ea	6	\$60.45
194-1036	KV 660 SS 120" TUBING	ea	6	\$77.36

**CLOSET ROD, KV**

**KNAPE & VOGT CLOSET ROD TUBING**

**1-5/16" Chrome Look Tubing .075" Thickness**

Nickel plated. 1 5/16" outside diameter.

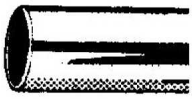

BHS#	DESCRIPTION	U/M	BOX	RETAIL
194-1076	KV 750-5 CHR 72" TUBING	ea	6	\$35.80
194-1078	KV 750-5 CHR 96" TUBING	ea	6	\$42.88
194-1080	KV 750-5 CHR 120" TUBING	ea	6	\$53.65
194-1082	KV 750-5 CHR 144" TUBING	ea	6	\$64.37

**1-5/16" Chrome Look Tubing .109" Thickness**

Heavy wall steel tubing. Polished chrome finish. 1 5/16" outside diameter.



BHS#	DESCRIPTION	U/M	BOX	RETAIL
194-1086	KV 770-5 CHR 48" TUBING (CUT FROM A 96" PIECE)	ea	6	\$60.46
194-1087	KV 770-5 CHR 60" TUBING (CUT FROM A 120" PIECE)	ea	6	\$74.93
194-1088	KV 770-5 CHR 72" TUBING	ea	6	\$85.83
194-1089	KV 770-5 CHR 96" TUBING	ea	6	\$114.43
194-1090	KV 770-5 CHR 120" TUBING	ea	6	\$146.96
194-1091	KV 770-5 CHR 144" TUBING	ea	6	\$179.87

**Flanges for 1-1/16" Tubing**

Polished chrome for 1 1/16" OD. tubing. Packed with screws.



BHS#	DESCRIPTION	U/M	BOX	RETAIL
194-1070	KV 734 CHR CLOSED FLANGE	ea	50	\$3.02
194-1071	KV 735 CHR OPEN FLANGE	ea	50	\$3.41

**Flanges for 1-5/16" Tubing**

Polished chrome for 1 5/16" OD. tubing. Packed with screws.



BHS#	DESCRIPTION	U/M	BOX	RETAIL
194-1074	KV 764 CHR CLOSED FLANGE	ea	12	\$4.13
194-1075	KV 766 CHR OPEN FLANGE	ea	12	\$4.61

**Center Support**

Nickel plate. For 1 1/16" O.D. tubing. 24" long. Can be cut to any size.



BHS#	DESCRIPTION	U/M	BOX	RETAIL
194-1073	KV 760 ANO CENTER SUPPORT	ea	12	\$9.24

**Cutting Charge for Tubing**

Cutting Charge Per Cut.

**No Illustration Available**

BHS#	DESCRIPTION	U/M	BOX	RETAIL
061-1270	CUTTING CHARGE; NON-STOCK SIZE; (STEEL)	ea	1	\$7.50

**CLOSET RODS, ADJUSTABLE**

**STANLEY ADJUSTABLE ROUND CLOSET ROD**

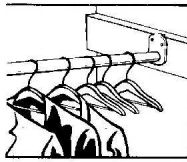

Steel - Zinc finish, with screws. An ideal, sturdy rod for closets. PermaSeam™ design consists of two structurally strong rolled shapes that telescope for easy adjustment. Closet rods exceed ANSI-BHMA 156.16 Deflection Standards when installed with center support(s). Escutcheons are swaged and staked to tubes to provide double pull-away protection and eliminate initial sag associated with loose escutcheon assemblies. Center support 7050 included with 72" rod at no extra charge. F.O.O. Items - Full Box Only - Allow 2 weeks.

BHS#	DESCRIPTION	U/M	BOX	RETAIL
332-3932	STAN V7052 US2C 18-30"ROD 193008;	ea	10	\$5.28
332-3934	STAN V7052 US2C 30-48" ROD; FOO 193028	ea	10	\$7.15
332-3936	STAN V7052 US2C 48-72" ROD 193038	ea	10	\$9.98
332-3938	STAN V7052 US2C 72-96"ROD 193048; FOO	ea	10	\$13.21
332-3940	STAN V7052 US2C 72-120" ROD; FOO 193065	ea	10	\$14.61

**CLOSET ROD, STANLEY**

**CLOSET ROD TUBING**



Stanley Home Designs Satin Nickel Closet Flange Set for 1-5/16-inch diameter rods. Supports ends of closet rods. Strong zinc die cast material. Mounting screws included for easy installation. Fits closet rods up to 1-5/16-inch.

BHS#	DESCRIPTION	U/M	BOX	RETAIL
332-194097	STAN V8185 SN FLANGE S820-167	pk	5	\$9.02
332-194098	STAN V8186 SN 11 X 12-5/8" SHELF HANG ROD BRACKET S820-209	ea	10	\$13.53
332-194073	STAN BB8182 SN 6' ROD 820100	ea	6	\$36.11
332-217474	STAN BB8182 SN 8' ROD S820-035	ea	4	\$39.99
332-217477	STAN BB8184 ORB 6' ROD S833-871	ea	6	\$29.99
332-217478	STAN BB8184 ORB 8' ROD S833-889	ea	4	\$39.99

**CLOTHING CARRIER**

**KNAPE & VOGT CLOTHING CARRIER**



Mounts under closet shelves, greatly increasing capacity, and making garments more accessible. Anachrome finish. Packed one in box with screws.

BHS#	DESCRIPTION	U/M	BOX	RETAIL
194-11	KV KV1 ANO 12" CLOTHING CARRIER	ea	12	\$31.44

**POLE SOCKETS**

**BAINBRIDGE POLE SOCKETS**

**1 Set per Bag**

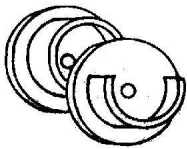

For 1 3/8" pole. B-brown plastic, W-white plastic. Packaged 1 set per bag.

BHS#	DESCRIPTION	U/M	BOX	RETAIL
030-12010	BAIN 1323-AL-65 POLE SOCKETS;ALMOND ;1set/pk	pk	10	\$.89
030-12020	BAIN 1323-WH-65 POLE SOCKETS; WHITE ;1set/pk	pk	10	\$.89

**1 Set per Bag, 5mm Pegs Spaced 32mm Apart**

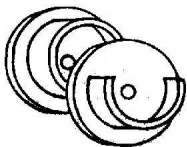

Same as 1323 but with 2 each 5mm pegs spaced 32 mm apart for 32mm applications. Poly bagged - 1 set per bag.

BHS#	DESCRIPTION	U/M	BOX	RETAIL
030-12110	BAIN 1324-AL-65 POLE SOCKETS;ALMOND ;1set/pk	pk	10	\$.89
030-12120	BAIN 1324-WH-65 POLE SOCKETS; WHITE ;1set/pk	pk	10	\$.89

**40 or 100 Sets per box**

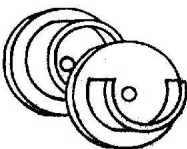

For 1 3/8" pole. B-brown plastic, W-white plastic. 40 bags per carton (8 cartons per case) or 100 bags per carton (4 cartons per case).

BHS#	DESCRIPTION	U/M	BOX	RETAIL
030-250	BAIN P-1323-T-32 POLE SOCKETS (100) TAN; (replacing 1323-T-32)	st	100	\$.34
030-260	BAIN 1323-W-10 POLE SOCKETS(40) WHT	st	40	\$.85
030-270	BAIN P-1323-W-20 POLE SOCKETS (100) WHT; (replacing 1323-W-32)	st	100	\$.33

**POLE SOCKETS**

**IVES POLE SOCKETS**

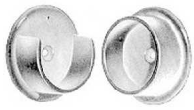

White plastic. Top-of-line heavy duty plastic provides long life and extra strength. Single screw mounting. Accommodates pole or pipe outside diameter - 1 3/8". Packed 2 per bag with screws.

BHS#	DESCRIPTION	U/M	BOX	RETAIL
174-1829	IVES SP 586P POLE SOCKETS; 2/bag	bg	20	\$1.10

**TAYMOR POLE SOCKETS**

**Plastic Pole Socket Set**

Standard Plastic Pole Socket Set. 1 3/8" diameter. White finish. Poly-bagged complete with screws.



BHS#	DESCRIPTION	U/M	BOX	RETAIL
785-8340	TAYM 25-2820 WHITE POLE SOCKETS SET	st	50	\$.49

**S & S WOOD POLE SOCKETS**

**Heavy Duty Wood Pole Sockets**

New England Hardwood Closet Pole Sockets for 1 3/8" poles.

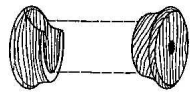

BHS#	DESCRIPTION	U/M	BOX	RETAIL
312-160	CINDOCO HPS-138 CLOSET POLE SOCKETS	pr	12	\$3.07

**Wood Pole Sockets**

New England Hardwood Closet Pole Sockets for 1 3/8" poles.

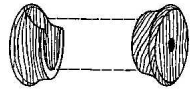

BHS#	DESCRIPTION	U/M	BOX	RETAIL
312-150	CINDOCO XF40-138 CLOSETPOLE SOCKETS	pr	40	\$1.94

**SHELF AND ROD SUPPORTS**

**HAGER CLOSET SHELF AND ROD SUPPORTS**

**Non-Adjustable Brackets**

Same as Adjustable Bracket. White enamel finish.

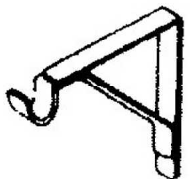

BHS#	DESCRIPTION	U/M	BOX	RETAIL
142-797	HAGER 1797 NON-ADJ SHELF BRKT (Ref: HAGER Quote# 33168-1-1) (replaces SOLAR 4800-0000)	ea	20	\$4.15

**Adjustable Brackets**

WROUGHT STEEL - WHITE ENAMEL FINISH - WITH SCREWS  
For Shelves up to 12" wide - For Rods up to 1 3/8" Diameter

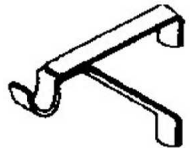

For use in hanging shelves and rods in clothes closets in new or old residential, industrial, commercial or institutional construction. Made of heavy gauge wrought steel, embossed at points of greatest strain; screw holes punched for use with round head wood screws; can be used with or without hanging strips, bar receives support from hook at end of bracket. Suggested application: Two brackets are recommended for 4 ft. shelves, with an extra bracket for each 2 ft or fraction thereof in shelf length. Enameled finish may be repainted.

BHS#	DESCRIPTION	U/M	BOX	RETAIL
142-799	HAGER 1799 ADJUST. SHELF BRKT (Ref: HAGER Quote# 33168-1-1) (replaces SOLAR 4700-0000)	ea	20	\$4.15

**HAFELE ADJUSTABLE CLOSET ROD SUPPORT**

**Bracket F/40mm Round**



BHS#	DESCRIPTION	U/M	BOX	RETAIL
	HAFELE 805.39.202 ADJ CLOSET BRACKET F/40mm ROUND ST. CHR.	ea	1	\$5.92

**SHELF AND ROD SUPPORTS**

**STERLING HD ADJUSTABLE ROD SUPPORT**



Available in White & Off White.

BHS#	DESCRIPTION	U/M	BOX	RETAIL
338-197972	STERLING RP 0043 WT SHELF & ROD SUPPORT; ADJUSTABLE w/o screws; 3" HOOK DEPTH	ea	20	\$3.20

**STERLING HD NON-ADJUSTABLE SHELF AND ROD SUPPORT**



For use with or without wall cleat. Available in Off White.

BHS#	DESCRIPTION	U/M	BOX	RETAIL
338-198040	STERLING RP 0045 WT SHELF & ROD SUPPORT; NON ADJUSTABLE w/o screws; 3" HOOK DEPTH (replaces SOLAR 4800)	ea	20	\$3.11

**STERLING ADJUSTABLE ROD SUPPORT**

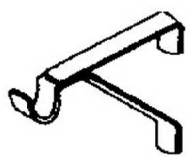

SHELF & ROD BRACKET For use with or without shelf cleat .105", thick, 12 gauge steel, 2-1/2" hook Baked enamel finish Adjustable; screws included 0043-B ROD/POLE BRACKET FINISH: Off White

BHS#	DESCRIPTION	U/M	BOX	RETAIL
338-201938	STERLING 0043-B PW SHELF & ROD SUPPORT; ADJUSTABLE w/screws; 2-1/2" HOOK DEPTH	ea	20	\$3.02

**TSM CHROME PLATED CLOSET SHELF AND ROD SUPPORT**



BHS#	DESCRIPTION	U/M	BOX	RETAIL
370-95	TSM DB-1 SHELF & ROD SUPPORT; CHR	ea	1	\$17.80

**TAYMOR CLOSET SHELF AND ROD SUPPORTS**

**Adjustable Support**

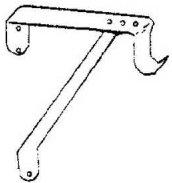

WROUGHT STEEL - WHITE ENAMEL FINISH - WITH SCREWS

**For Shelves up to 12" wide - For Rods up to 1 3/8" Diameter**

For use in hanging shelves and rods in clothes closets in new or old residential, industrial, commercial or institutional construction. Made of heavy gauge wrought steel, embossed at points of greatest strain; screw holes punched for use with round head wood screws; can be used with or without hanging strips, bar receives support from hook at end of bracket. Suggested application: Two brackets are recommended for 4 ft. shelves, with an extra bracket for each 2 ft or fraction thereof in shelf length. Enameled finish may be repainted. Accommodates up to 1 1/2" rod. Packed with screws.

BHS#	DESCRIPTION	U/M	BOX	RETAIL
785-10001	TAYM 25-2800 ADJUST. SHELF&ROD BRKT	ea	20	\$3.24

**Non-Adjustable Support**

See Adjustable Bracket above for description. White Enamel finish.



BHS#	DESCRIPTION	U/M	BOX	RETAIL
785-10002	TAYM 25-2810 NON-ADJ SHELF&ROD BRKT	ea	20	\$3.24

**SHELF BRACKETS, FOLDING**

**KNAPE & VOGT SHELF BRACKETS**

**Folding L-Bracket**

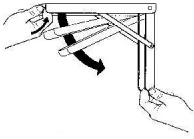

Adjustable to one of four positions: 90°, 80°, 70° and 0° (closed), and hold up to 750 lbs. per pair. Constructed of durable steel for strength and stability with an integrated spring-loaded release for ease of closing. Convenient one-hand release mechanism was designed with safety and ease of operation in mind. The mechanism makes the bracket easy-to-open release mechanism without danger of getting hands caught in a folding crossbar.

BHS#	DESCRIPTION	U/M	BOX	RETAIL
194-526	KV 206 ZC 12" ADJUSTABLE BRACKET	ea	10	\$21.79
194-527	KV 206 ZC 16" ADJUSTABLE BRACKET	ea	10	\$30.96

**STANLEY H.D. FOLDING SHELF BRACKETS**

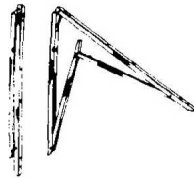

Heavy duty bracket for large folding tables or shelves. Use with plywood or flush door to create folding counter. Stores flat against wall in closed position. Zinc plated to resist rust. Packed 1 pair per pack with screw shelf leg 23 3/4", wall leg 21".

BHS#	DESCRIPTION	U/M	BOX	RETAIL
332-2498	STAN V772 US2C BRACKETS 250080;2/pk	pk	1	\$63.04

**ULTRA FOLDING SHELF BRACKETS**

**Deluxe Heavy Duty Steel**

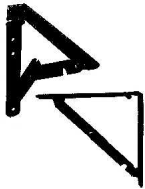

For drop down shelves. From 8" to 24" in width. Automatic safety locking device. Quick release folding mechanism. Solid rivet construction. Epoxy white enamel painted finish.

BHS#	DESCRIPTION	U/M	BOX	RETAIL
840-11030	ULTRA 11030 1888 8x8 WHITE BRACKET	pr	3	\$18.78
840-11035	ULTRA 11035 1222 12x12 WHITE BRKT	pr	6	\$23.35
840-11040	ULTRA 11040 1666 16x16 WHITE BRKT	pr	3	\$32.72

**SHELF BRACKETS, RIGID**

**HAGER SHELF BRACKETS**

**Adjustable Brackets**

BHS#	DESCRIPTION	U/M	BOX	RETAIL
142-197408	HAGER 1802 SHELF SUPPORT; NON-ADJ	ea	20	\$3.22

**Non-Adjustable Brackets**

DESCRIPTION	U/M	BOX	RETAIL
HAGER 1801 BY SHELF SUPPORT;NON-ADJ	ea	20	\$2.95

**KNAPE & VOGT SHELF BRACKETS**

**Silhouette Brackets**

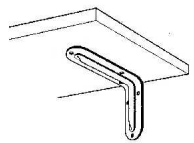

The Silhouette shelf brackets reflect a European feeling of sleek simplicity. Softly contoured profile compliments both contemporary and eclectic home decors. Consumers can mix and match brackets with all KV wood shelving. Shelf brackets are a decorative, affordable addition to your wall-mounted shelving line. Made of heavy duty epoxy coated steel for substantial support.

BHS#	DESCRIPTION	U/M	BOX	RETAIL
194-550	KV 217 WH 8" SILHOUTTE SHELF BRKT	ea	30	\$3.41
194-551	KV 217 WH 10" SILHOUTTE SHELF BRKT	ea	24	\$4.20
194-552	KV 217 WH 12" SILHOUTTE SHELF BRKT	ea	18	\$5.16

**FASTCAP SPEED BRACE SHELF BRACKETS**



Extra heavy to support big loads (500 pounds per pair when mounted on 16 inch centers); they have intelligently located notches to make alignment easy, and they are punched out to make it easy to run wires for all the electronics commonly used in today's office environments. The flange is 1-9/16" wide, and the countersunk mounting holes are 1/4" diameter and suitable for screws from #8 to #12.

BHS#	DESCRIPTION	U/M	BOX	RETAIL
109-169056	FASTCAP SPEEDBRACE SB-15X18WH WHITE 15" X 18"	ea	1	\$26.93
109-169059	FASTCAP SPEEDBRACE SB-21X28WH WHITE 21" X 28"	ea	1	\$31.42
109-169054	FASTCAP SPEEDBRACE SB-8X12WH WHITE 8" X 12"	ea	1	\$22.44



**SHELF BRACKETS, RIGID**

**KNAPE & VOGT SHELF BRACKETS**

**Ultimate L-Bracket**

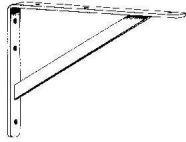

The Ultimate L-Bracket. Load Rating; holds up to 1000 lbs. per pair of brackets. Material: 5mm bar stock. Finish: White Epoxy Paint. Recommended Mounting Hardware (not included): lag bolts, 5/16" dia. by 3" long or longer. Mounting should be into or through a wooden wall stud.

BHS#	DESCRIPTION	U/M	BOX	RETAIL
194-540	KV 208 WH 300 L-BRACKET 300mm 12"	ea	10	\$5.78
194-541	KV 208 WH 400 L-BRACKET 400mm 16"	ea	10	\$7.42
194-542	KV 208 WH 500 L-BRACKET 500mm 20"	ea	10	\$8.88
194-543	KV 208 WH 550 L-BRACKET 550mm 22"	ea	10	\$10.22

**STANLEY H.D. RIGID SHELF BRACKETS**



Rigid shelf bracket can be used as a support or brace. Heavy duty steel construction. First measurement is the shelf size. Use prime coated white finish or paint to match finished application. Visual pack with screws. Packed 2 per box without screws. Price per each bracket.

BHS#	DESCRIPTION	U/M	BOX	RETAIL
332-2500	STAN 796 PCW 16 X 18 BRACKET 257561	ea	10	\$29.03

**SHELF SUPPORTS, RIGID**

**STERLING 11" SHELF SUPPORTS**

N/A



BHS#	DESCRIPTION	U/M	BOX	RETAIL
338-208678	STERLING CD0143-WT SHELF BRACKET SCREWS; WHITE; 20/pk	pk	10	\$4.35
338-197975	STERLING RP 0046-WT SHELF BRACKET; NON-ADJ. w/o screws; (replaces SOLAR 4825-0000)	ea	20	\$3.11

**SHELF BRACKETS, DECORATIVE**

**STANLEY DECORATIVE SHELF BRACKETS**

**Traditional Decor**



see full description under Modern Decor.

BHS#	DESCRIPTION	U/M	BOX	RETAIL
332-32330	STAN 773 US1D 7" x 8" TRADITIONAL DECOR SHELF BRACKET 250590	ea	10	\$15.14
332-32335	STAN 773 10A 7" x 8" TRADITIONAL DECOR SHELF BRACKET 250592	ea	10	\$15.20
332-32340	STAN 773 15 7" x 8" TRADITIONAL DECOR SHELF BRACKET 250591	ea	10	\$15.12

**Rustic Decor**



see full description under Modern Decor.

BHS#	DESCRIPTION	U/M	BOX	RETAIL
332-32315	STAN 773 US1D 7" x 8" RUSTIC DECOR SHELF BRACKET 250593	ea	10	\$15.04
332-32320	STAN 773 10A 7" x 8" RUSTIC DECOR SHELF BRACKET 250595	ea	10	\$15.14
332-32325	STAN 773 15A 7" x 8" RUSTIC DECOR SHELF BRACKET 250594	ea	10	\$15.12

**Modern Decor**



Designed to complement top-selling cabinet hardware. Available in 3 styles and 5 finishes. Weight-rated for 200 lbs. ANSI/BHMA Grade 1 product. Comes with finish-matched screws to provide a complete look.

BHS#	DESCRIPTION	U/M	BOX	RETAIL
332-32300	STAN 773 US1D 7" x 8" MODERN DECOR SHELF BRACKET 250596	ea	10	\$14.90
332-32305	STAN 773 15 7" x 8" MODERN DECOR SHELF BRACKET 250597	ea	10	\$14.87
332-32310	STAN 773 WH 7" x 8" MODERN DECOR SHELF BRACKET 250598	ea	10	\$15.00

**SHELF BRACKETS, UTILITY**

**STANLEY UTILITY SHELF BRACKETS**

**Almond**



Utility shelf bracket can be used as a support or brace. Strengths exceed ANSI/BHMA standards. Brackets are designed for use with standard dimensional lumber. First measurement indicates nominal width of shelf leg - second measurement denotes nominal length of wall leg. Scannable - brackets are supplied with factory applied UPC labels. F.O.O. Items - Full box only - Allow 2 weeks.

BHS#	DESCRIPTION	U/M	BOX	RETAIL
332-2502	STAN 797 ALM 5 X 6 BRACKET 250510	ea	20	\$1.51
332-2503	STAN 797 ALM 6 X 8 BRACKET 250532	ea	20	\$1.18
332-2504	STAN 797 ALM 8 X 10 BRACKET 250549: FOO	ea	20	\$1.51
332-2505	STAN 797 ALM 10 X 12 BRACKET 250566:FOO	ea	20	\$2.46
332-2506	STAN 797 ALM 12 X 14 BRACKET 250572	ea	20	\$3.44

**Gray**



See Almond 797 Brackets for description.

BHS#	DESCRIPTION	U/M	BOX	RETAIL
333-21946	NAT-STAN 211BC GR 4 X 6 BRACKET N172-601 (replacing STAN 797 BG 4 X 6 BRACKET 250515)	ea	20	\$.69
333-21947	NAT-STAN 211BC GR 6 X 8 BRACKET N171-066 (replacing STAN 797 BG 6 X 8 BRACKET 250530)	ea	20	\$.77
332-2512	STAN 797 BG 8 X 10 BRACKET 250545	ea	20	\$.89
332-2514	STAN 797 BG 10 X 12 BRACKET 250560	ea	20	\$1.34
332-2516	STAN 797 BG 12 X 14 BRACKET 250575 (replaced by 172619)	ea	20	\$1.93

**Walnut**



See Almond 797 Brackets for description.

BHS#	DESCRIPTION	U/M	BOX	RETAIL
332-2526	STAN 797 WAL 8 X 10 BRKT 250556;FOO	ea	20	\$1.41
332-2528	STAN 797 WAL 10 X 12 BRACKET 250571 (185-041)	ea	20	\$2.29
332-2530	STAN 797 WAL 12 X 14 BRACKET 250581	ea	20	\$3.08

**White**



See Almond 797 Brackets for description.

BHS#	DESCRIPTION	U/M	BOX	RETAIL
332-2540	STAN 797 WH 4 X 6 BRACKET 266-254 (250518)	ea	20	\$1.06
333-21957	NAT-STAN 211BC WH 6 X 8 BRACKET N218-891 (replacing STAN 797 WH 6 X 8 BRACKET 250534)	ea	20	\$1.16
333-21958	NAT-STAN 211BC WH 8 X 10 BRACKET N218-925 (replacing STAN 797 WH 8 X 10 BRACKET 250559)	ea	20	\$1.35
332-2546	STAN 797 WH 10 X 12 BRACKET 250574 (REPLACED BY 218958)	ea	20	\$2.46
333-21960	NAT-STAN 211BC WH 12 X 14 BRACKET N245-779 (replacing STAN 797 WH 12 X 14 BRACKET 250585)	ea	20	\$2.73

**CORBELS, KEYHOLE**

**NW WOOD SHELF BRACKETS**



Each pine corbel individually shrink-wrapped with keyhole hardware. 3x5 bracket for shelves up to 6"; 5x8 bracket for shelves up to 8"; 7x10 bracket for shelves up to 10".

BHS#	DESCRIPTION	U/M	BOX	RETAIL
634-390	NW WOOD NWC-35 3 X 5 PINE CORBEL; replacing S&S TWBC-35	ea	20	\$2.68
634-392	NW WOOD NWC-58 5 X 8 PINE CORBEL; replacing S&S TWBC-58	ea	20	\$3.72
634-394	NW WOOD NWC-710 7 X 10 PINE CORBEL;	ea	20	\$4.64

**SHELF BRACKETS, PINE**

**NW WOOD SHELF BRACKETS**



Packaged individually; includes mounting hardware. Made of solid Pine wood.

BHS#	DESCRIPTION	U/M	BOX	RETAIL
634-350	NW WOOD NWB-401 4" x 6" PINE BRKT; replacing S&S TWB-401	ea	10	\$4.33
634-355	NW WOOD NWB-601 6" x 9" PINE BRKT; replacing S&S TWB-601	ea	10	\$6.33
634-360	NW WOOD NWB-801 7-3/4"x11-1/4" PINE BRKT; replacing S&S TWB-801	ea	10	\$8.15
634-365	NW WOOD NWB-1001 9-3/4"x13" PINE	ea	10	\$9.67

**CORNER BRACES**

**BRAINERD CORNER BRACES**



Solid brass. Four on a card with screws.

BHS#	DESCRIPTION	U/M	BOX	RETAIL
054-125	BRAIN 401-1/2XC BUR BR BRCKT	cd	10	\$2.96
054-120	BRAIN 401XC BURNISHED BR BRACKET; FDWO	cd	10	\$2.80

**KNAPE & VOGT CORNER BRACES**

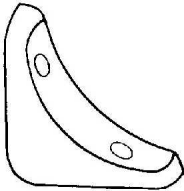

Zinc plated stamped steel. Packed less screws. Use 3/4" No. 10 flat head wood screws. Items marked F.O.O. - Allow 2 weeks for delivery.

BHS#	DESCRIPTION	U/M	BOX	RETAIL
194-828	KV 341 ZC BRACES	hd	100	\$74.40
194-829	KV 342 ZC BRACES;FOO "FULLBOX ONLY"	hd	100	\$148.80

**STANLEY CHAIR LEG BRACES**

**Bulk**



Provides strong reinforcement of chair and table legs. Rust resistant. Wrought steel. (D7) bright copper finish.

BHS#	DESCRIPTION	U/M	BOX	RETAIL
332-3004	STAN 996-1/2 D7 1" COR.BRACE 501820 FOO	ea	25	\$.82

**Carded**



Carded - packed 4 per card with screws.- (BL) brown lacquer finish.

BHS#	DESCRIPTION	U/M	BOX	RETAIL
332-3008	STAN CD996-1/2 BL 1"COR.BRAC 730300 4/CD	cd	10	\$4.22

**BAINBRIDGE CORNER BRACES**

**1-1/4" x 1-1/4" x 1-3/4"**

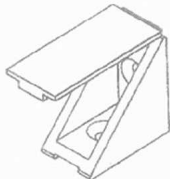

Attach inside corners of closet shelves and conceal screw heads at the same time.

BHS#	DESCRIPTION	U/M	BOX	RETAIL
030-12260	BAIN 1655-WH-65 CORNER BRACE; 2/pk; 1-1/4x1-1/4x1-3/4"	pk	10	\$2.23

**3/4" x 3/4" x 1"**

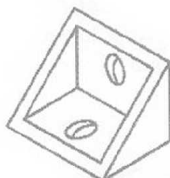

Designed for small applications and used to hold cabinet fronts firmly in place. Attached with screws or staples.

BHS#	DESCRIPTION	U/M	BOX	RETAIL
030-12300	BAIN 1682-WH-65 CORNER BRACE; 4/pk; 3/4x3/4x1"	pk	10	\$2.52

**CORNER BRACES**

**BAINBRIDGE CORNER BRACES**

**1-1/2" x 1-1/2" x 3"**

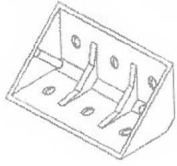

Specifically designed for heavy load-bearing applications. Attached with screws or staples.

<b>BHS#</b>	<b>DESCRIPTION</b>	<b>U/M</b>	<b>BOX</b>	<b>RETAIL</b>
030-12305	BAIN 1683-NAT-65 CORNER BRACE;1/pk; 1-1/2x1-1/2x3"	pk	10	\$1.21

**1-1/8" x 1-1/8"**



This brace can be used for both corners or shelves. It is designed for use with #8 wood screws. 2 per poly bag.

<b>BHS#</b>	<b>DESCRIPTION</b>	<b>U/M</b>	<b>BOX</b>	<b>RETAIL</b>
030-12310	BAIN 1685-CL-65 SHELF BRACE; CLEAR; 2/pk	pk	10	\$1.97

**2-1/2" x 2-1/2" x 3/4"**

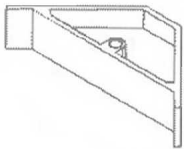

Designed for corner block applications. Screw or staple in place.

<b>BHS#</b>	<b>DESCRIPTION</b>	<b>U/M</b>	<b>BOX</b>	<b>RETAIL</b>
030-12315	BAIN 1693-NAT-65 CORNER BRACE;2/pk; 2-1/2x2-1/2x3/4"	pk	10	\$1.15

**3/4" x 3/4" x 2"**

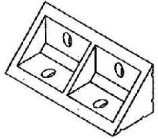

This 3/4" x 3/4" x 2" HIPS corner brace can be screwed, stapled or glued in place. 2 per poly bag.

<b>BHS#</b>	<b>DESCRIPTION</b>	<b>U/M</b>	<b>BOX</b>	<b>RETAIL</b>
030-12325	BAIN 1698-WH-65 CORNER BRACE; 2/pk; 3/4x3/4x2"	pk	10	\$.92
030-12320	BAIN 1698-BK-65 SHELF BRACE; BLACK; 2/pk; FOO	pk	10	\$.92

**3/4" x 3/4" x 3-1/2"**

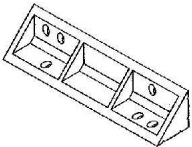

This 3/4" x 3/4" x 3 1/2" HIPS corner brace can be screwed, stapled or glued in place. 2 per poly bag.

<b>BHS#</b>	<b>DESCRIPTION</b>	<b>U/M</b>	<b>BOX</b>	<b>RETAIL</b>
030-12330	BAIN 1699-BK-65 SHELF BRACE; BLACK; 2/pk; FOO	pk	10	\$1.13

**STANLEY CORNER BRACES**

**3 Surface Inside Corners, Carded**



Provides heavy duty reinforcement for right angle corner joints and three surface inside corners. Rust resistant, zinc (US2C) finish. Carded - 2 per card with screws. Items marked F.O.O. - Full Box Only - Allow 2 weeks.

<b>BHS#</b>	<b>DESCRIPTION</b>	<b>U/M</b>	<b>BOX</b>	<b>RETAIL</b>
332-4922	STAN CD992 US2C 2"COR.BRC 755550; 2/CD	cd	5	\$5.62
332-4923	STAN CD992 US2C 3"COR.BRC 755560; 2/CD	cd	5	\$6.79
332-4924	STAN CD992 US2C 4"COR.BRC 755565; 2/CD; FOO	cd	5	\$9.75

**CORNER BRACES**

**STANLEY CORNER BRACES**

**L-Shaped, Bulk**

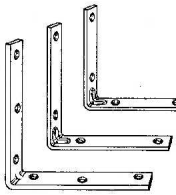

Reinforces right angle corner joints. Screw holes are staggered in 5" and larger. F.O.O. Items - Full Box Only - Allow 2 weeks. Steel, bright zinc plated. Screws not included. (Similar to Lawrence #130ZN).

BHS#	DESCRIPTION	U/M	BOX	RETAIL
332-4387	STAN 997 US2C 1" CORN.BRACE 266270 (replacing 303000)	ea	25	\$.40
332-4388	STAN 997 US2C 1.5" COR.BRACE 303160	ea	25	\$.46
332-4389	STAN 997 US2C 2" CORN.BRACE 303320	ea	25	\$.59
332-4390	STAN 997 US2C 2.5" COR.BRACE 303480	ea	25	\$.79
332-4391	STAN 997 US2C 3" CORNER PLT 303640	ea	25	\$1.02
332-4392	STAN 997 US2C 4" CORN.BRACE 303960	ea	10	\$1.87
332-4393	STAN 997 US2C 5" CORN.BRACE 304140	ea	10	\$2.96
332-4394	STAN 997 US2C 6" CORN.BRACE 304240	ea	5	\$3.87
332-4395	STAN 997 US2C 8" CORN.BRACE 304360	ea	5	\$7.38
332-4396	STAN 997 US2C 10" CORN.BRACE 304500	ea	5	\$9.10

**L-Shaped, Carded**



Reinforces right angle corner joints. Screw holes are staggered in 5" and larger. F.O.O. Items - Full Box Only - Allow 2 weeks. Packed 2 pair per card with screws. (Similar to Lawrence #130ZN).

BHS#	DESCRIPTION	U/M	BOX	RETAIL
332-3022	STAN CD997-R ST4C 1" CORNER BRACE 802190; 4/CD	cd	10	\$3.03
332-3023	STAN CD997-R ST4C 1-1/2" CORNER BRACE 802201; 4/CD	cd	10	\$3.96
332-3024	STAN CD997-R ST4C 2" CORNER BRACE 802211; 4/CD	cd	10	\$4.82
332-3025	STAN CD997-R ST4C 2-1/2" CORNER BRACE 802219; 4/CD	cd	10	\$5.06
332-3026	STAN CD997-R ST4C 3" CORNER BRACE 802221; 4/CD	cd	10	\$6.34
332-3011	STAN CD997-R US2C 1" CORN.BRACE 756104; 4/CD	cd	10	\$2.82
332-3012	STAN CD997-R US2C 1.5" COR.BRAC 756111; 4/CD	cd	10	\$3.42
332-3013	STAN CD997-R US2C 2" CORN.BRACE 756241; 4/CD	cd	10	\$4.36
332-3014	STAN CD997-R US2C 2.5" CORN.BRAC 756371; 4/CD	cd	10	\$4.66
332-3015	STAN CD997-R US2C 3" CORN.BRACE 756501; 4/CD	cd	10	\$5.91
332-3016	STAN CD997-R US2C 3.5" CORN BRC 756507; 4/CD	cd	10	\$8.18
332-3017	STAN CD997-R US2C 4" CORN.BRACE 756511; 4/CD	cd	5	\$8.97
332-3018	STAN CD997-R US2C 5" CORN.BRACE	cd	5	\$9.01

**Right Angle Corner Joints, Carded**

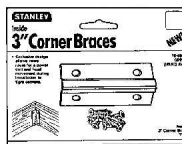

Reinforces inside right angle corner joints. Screw holes are staggered in 5" and larger. Rust resistant. Two per pack with screws. Finish - US2C. Items marked F.O.O. - Allow 2 weeks for delivery.

BHS#	DESCRIPTION	U/M	BOX	RETAIL
332-4902	STAN CD991 US2C 2" COR.BRC 755500; 2/CD	cd	5	\$4.05
332-4903	STAN CD991 US2C 3" COR.BRC 755505; 2/CD	cd	5	\$4.97
332-4904	STAN CD991 US2C 4" COR.BRC 755510; 2/CD; FOO	cd	5	\$8.09

**CORNER BRACES**

**STANLEY CORNER BRACES**

**Double Wide Corner Brace, Carded**



Provides double holding power by reinforcing inside of right angle corner joints Ideal for wood beams. Rust resistant, Steel/Zinc plated. 1-1/2" width.

BHS#	DESCRIPTION	U/M	BOX	RETAIL
332-4942	STAN CD994 US2C 1-1/2" CORNER BRACE 755680; 2/CD	cd	5	\$4.49
332-4943	STAN CD994 US2C 2" CORNER BRACE 755685; 2/CD	cd	5	\$5.03
332-4944	STAN CD994 US2C 2-1/2" CORNER BRACE 755690; 2/CD	cd	5	\$5.70

**CORNER PLATES**

**STANLEY FLAT CORNER IRONS**

**Carded**

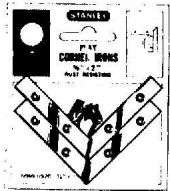

Steel zinc plated. Packed 4 per pack with screws.

BHS#	DESCRIPTION	U/M	BOX	RETAIL
332-3047	STAN CD999-R ST4C 2" CORNER IRON 802301; 4/CD	cd	10	\$3.82
332-3049	STAN CD999-R ST4C 2.5" CORNR IRON 802311; 4/CD	cd	10	\$4.53
332-3044	STAN CD999-R US2C 1.5"COR.IRON 756618; 4/CD	cd	10	\$3.14
332-3046	STAN CD999-R US2C 2" CORNER IRON 756631; 4/CD	cd	10	\$3.42
332-3048	STAN CD999-R US2C 2.5" COR.IRON 756761; 4/CD	cd	10	\$4.09
332-3051	STAN CD999-R US2C 3.5" CORN.IRON	cd	10	\$5.22
332-3050	STAN CD999-R US2C 3" CORN.IRON 756891; 4/CD	cd	10	\$4.36
332-3052	STAN CD999-R US2C 4" CORN.IRON 757021; 4/CD	cd	5	\$5.91
332-3054	STAN CD999-R US2C 5" CORN.IRON	cd	10	\$6.27
332-3053	STAN CD999-R ST2H 4" CORNER IRON 757022; 2/CD	cd	5	\$7.08

**Bulk**

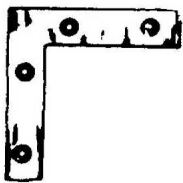

Steel, bright zinc plated. Without screws. Items marked F.O.O. - Allow 2 weeks for delivery.

BHS#	DESCRIPTION	U/M	BOX	RETAIL
332-3038	STAN 999 US2C 2" CORNER IRON 305520 FOO	ea	25	\$.46
332-3039	STAN 999 US2C 2.5" CORN.IRON 305840 FOO	ea	25	\$.59
332-3040	STAN 999 US2C 3"COR.IRON 306040;FOO	ea	25	\$.69
332-3041	STAN 999 US2C 4" CORNER IRON 306560	ea	25	\$.98
332-4427	STAN 999 US2C 5" CORN.IRON 306800;	ea	25	\$1.51
332-3042	STAN 999 US2C 6" CORNER IRON 307080	ea	25	\$2.07

**CORNER PLATES**

**STANLEY MENDING PLATES**

**Bulk**

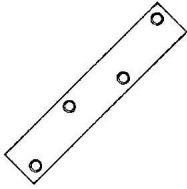

Reinforces joints, seams, and cracks. Rust resistant. Steel- bright zinc plated, without screws. F.O.O. Items - Full Box Only - Allow 2 weeks. Other sizes are available as Factory Order Only.

BHS#	DESCRIPTION	U/M	BOX	RETAIL
332-2977	STAN 995 US2C 2" MENDING PLT 272-716 (was 300120)	ea	25	\$.42
332-2978	STAN 995 US2C 3" MENDING PLT 819987 (was 300400)	ea	25	\$.55
332-2979	STAN 995 US2C 4" MENDING PLT 300680 FOO	ea	25	\$.75
332-2980	STAN 995 US2C 5" MEND.PLT 300840	ea	25	\$1.02
332-2981	STAN 995 US2C 6" MEND.PLT 300960; FOO	ea	25	\$1.32
332-2993	STAN 995 US2C 12" MEND.PLT 301160	ea	10	\$3.75
332-2988	STAN 995 US2C 10" MEND.PLT 301140	ea	10	\$3.05
332-2982	STAN 995 US2C 8" MEND.PLT 301120	ea	10	\$2.46

**Carded**



Reinforces joints, seams, and cracks. Rust resistant. Carded, with screws, steel-right zinc plated. Packed 4 per card except 6", packed 2 per card.

BHS#	DESCRIPTION	U/M	BOX	RETAIL
332-2983	STAN CD995-R ST4C 3" MEND 802101; 4/CD	cd	10	\$4.41
332-2989	STAN CD995-R ST4C 4" MEND 802111; 4/CD	cd	10	\$5.39
332-2984	STAN CD995-R US2C 2" MEND 755711; 4/CD	cd	10	\$3.39
332-2985	STAN CD995-R US2C 3" MEND 755733; 4/CD	cd	10	\$3.98
332-2986	STAN CD995-R US2C 4" MEND 755851; 4/CD	cd	10	\$4.99
332-2987	STAN CD995-R US2C 6" MEND 756048; 2/CD	cd	10	\$4.36

**TEE PLATES**

**STANLEY TEE PLATES**

**Bulk**



Provides strong reinforcement to wood boxes, crates, toys, furniture, screens and windows. Reinforces joints, seams, and cracks. Rust resistant. Heavy wrought steel - bright zinc plated, without screws.

BHS#	DESCRIPTION	U/M	BOX	RETAIL
332-2990	STAN 995-1/2 US2C 3" TEE-PLT 301600	ea	25	\$1.76
332-2991	STAN 995-1/2 US2C 4" TEE-PLT 301805; FOO	ea	25	\$2.46

**Carded**

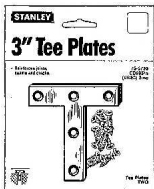

Provides strong reinforcement to wood boxes, crates, toys, furniture, screens and windows. Reinforces joints, seams, and cracks. Rust resistant. Carded - 2 per card with screws. Heavy wrought steel - zinc plated.

BHS#	DESCRIPTION	U/M	BOX	RETAIL
332-2994	STAN CD995-1/2 US2C 3" TEE 755750; 2/CD	cd	10	\$4.05

**CORNERS, BOX**

**BRAINERD BOX CORNERS**

**Brass Plated**

Brass plated steel. Four on a card with screws.



BHS#	DESCRIPTION	U/M	BOX	RETAIL
054-210	BRAIN 0476XC BRASS PLATED CORNER; FDWO	cd	10	\$3.56

**RING PULL**

**STANLEY TRAP DOOR RING PULLS**

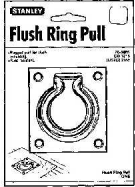

Flush ring pull. Mortised design for flush installation with flooring. Bail stores flush with mounting plate. Helps minimize danger of tripping. Steel - bright zinc finish. Carded - one per card with screws. See **Door Track** section for more flush ring pulls.

BHS#	DESCRIPTION	U/M	BOX	RETAIL
332-3218	STAN CD1215 US2C TRAP DR RING 763865	cd	5	\$7.81

**CHEST HANDLES**

**STANLEY CHEST HANDLES**

**Carded - Steel - Bright Zinc Plated**



Surface mounted chest handle is for use on chests, crates and storage boxes. Vertical corrugations reinforce the stop. Heavy steel handle with large bail allows for a firm, comfortable grip. Screws can be driven on all sizes without raising bail. Carded - one per card with screws.

BHS#	DESCRIPTION	U/M	BOX	RETAIL
332-3202	STAN CD1205 US2C 2-3/4" CHEST 758300	cd	10	\$4.53
332-3204	STAN CD1205 US2C 3-1/2" CHEST 758305	cd	5	\$6.50

**Polybag - Steel - Bright Zinc Plated**

Poly-bagged with screws. Items marked F.O.O. - Allow 2 weeks for delivery.

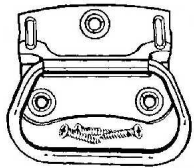

BHS#	DESCRIPTION	U/M	BOX	RETAIL
332-33193	STAN SP1205 US2C 2-3/4" CHEST.H 331301	pk	10	\$3.51
332-33195	STAN SP1205 US2C 3-1/2" CHEST.H 333380	pk	10	\$4.72
332-33196	STAN SP1205 US2C 4" CHEST HANDLE 334180; FOO	pk	10	\$6.23
332-33197	STAN SP1205 US2C 4-3/4" CHEST.H 335050	pk	10	\$9.46

**DOORBELL BUTTONS**

**BALDWIN DOORBELL BUTTONS**

**Solid Brass Illuminated Doorbell Buttons**

All illustrated electrical bell buttons have been designed to accessorize Baldwin's line of entrance locksets. Each product is manufactured from solid brass. A brass ring surrounds the plastic push button for added strength. The antique white button is always illuminated for detection at night or in unlit areas. Note: The ring surrounding the plastic push button is manufactured from brass and is finished in US4 only. F.O.O. Items - allow 6 to 8 weeks for delivery.

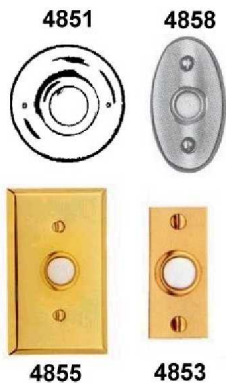

BHS#	DESCRIPTION	U/M	BOX	RETAIL
032-1465	BALDW 4851.003 ROUND BELL BUTTN;FOO	ea	1	\$48.00
032-1470	BALDW 4851.030 ROUND BELL BUTTON	ea	1	\$41.00
032-1466	BALDW 4851.102 ROUND BELL BUTTON FOO	ea	1	\$41.00
032-1467	BALDW 4851.150 ROUND BELL BUTTN;FOO	ea	1	\$41.00
032-1472	BALDW 4853.003 BELL BUTTN 2.25"x 1"	ea	1	\$39.00
032-1473	BALDW 4853.102 BELL BUTTN 2.25"x 1"	ea	1	\$33.00
032-1474	BALDW 4853.150 BELL BUTTN 2.25"x 1"	ea	1	\$33.00
032-1490	BALDW 4858.003 OVAL BELL BUTN;3.0"	ea	1	\$57.00



**DOORBELL BUTTONS**

**NUTONE PUSHBUTTONS**

**Decorator Series - Replacement Bulb**

	<b>BHS#</b>	<b>DESCRIPTION</b>	<b>U/M</b>	<b>BOX</b>	<b>RETAIL</b>
<b>No Illustration Available</b>	274-140	NUTONE PBL-2 REPL. LIGHT BULB; FOO replacement bulb for PB-18LCL *Broken Box Pricing* (*WHD*)	ea	12	\$4.72

**Masterpiece Series**

Solid brass line of lighted pushbuttons.

	<b>BHS#</b>	<b>DESCRIPTION</b>	<b>U/M</b>	<b>BOX</b>	<b>RETAIL</b>
	274-95	NUTONE PB-18L-WHCL LITED PUSHBUTTON ;was PB-18LCL; repl. RCPB733	ea	12	\$6.94
	274-126286	NUTONE PB-15L-BR OILRUBBED BRNZ LITED PUSHBUTTON (replaces RCPB740)	ea	3	\$23.42

**SPORE PUSH BUTTONS**

Spore De Light Doorbell buttons will give your guests an inviting welcome! These buttons are made with a soft to the touch polymer resin button and anodized aluminum. The lighting is provided by an LED light source that has an extremely long life. The installation is simple and works with most existing and new systems.

	<b>BHS#</b>	<b>DESCRIPTION</b>	<b>U/M</b>	<b>BOX</b>	<b>RETAIL</b>
	776-166078	SPORE DBD-A-S AMBER x SATIN ALUM DOORBELL BUTTON	ea	1	\$39.50
	776-114364	SPORE DBD-W-S WHITE x SATIN ALUM DOORBELL BUTTON	ea	1	\$39.50

**SPORE PUSHBUTTONS**

Illuminated. Easy install. Consumes less than 1 watt of power. Long life, colorful. Works with standard doorbell systems.

	<b>BHS#</b>	<b>DESCRIPTION</b>	<b>U/M</b>	<b>BOX</b>	<b>RETAIL</b>
	776-128500	SPORE DBD-R-S RED x SATIN ALUM DOORBELL BUTTON	ea	1	\$39.50
	776-112286	SPORE DBD-W-P WHITE x POLISHED ALUM DOORBELL BUTTON	ea	1	\$39.50
	776-112285	SPORE DBD-B-S BLUE x SATIN ALUM DOORBELL BUTTON	ea	1	\$39.50
	776-111944	SPORE DBD-A-B AMBER x DARK BRONZE DOORBELL BUTTON	ea	1	\$39.50

**TDB Series**

	<b>BHS#</b>	<b>DESCRIPTION</b>	<b>U/M</b>	<b>BOX</b>	<b>RETAIL</b>
	776-217721	SPORE TDB-A-BR AMBER LIGHT X BRONZE ILLUMINATED DOORBELL BUTTON	ea	1	\$61.00

**DOORBELL RINGER**

**SPORE DOORBELL RINGER**

Chrome or bronze.



BHS#	DESCRIPTION	U/M	BOX	RETAIL
776-124056	SPORE CHR-B RING DOOR CHIME; BRONZE	ea	1	\$135.00
776-112287	SPORE CHR-P RING DOOR CHIME;POL.CHR	ea	1	\$135.00

**DOOR CHIME ACCESSORIES**

**NUTONE DOOR CHIME ACCESSORIES**

16-volt, 30-watt

"Visu-Pac" transformers meet new U.L. requirement for 120 volt primary rating. Contains automatic resetting circuit breaker - protects against overload or short circuits. Prevents nuisance tripping and burnouts. Standard bulk pack. Items marked F.O.O. - Allow 2 weeks for delivery.

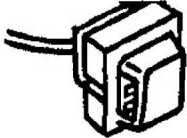

BHS#	DESCRIPTION	U/M	BOX	RETAIL
274-34	NUTONE 301T TRANSFORMER; FOO	ea	12	\$24.64

**Fitting Set for Hawa Junior 80/B**



For 1 and 2 sliding wood doors. Minimum installation height. Smooth quiet operation. Outstanding durability. Rattle-free bottom guide. Suspension with carrier profile. Heights adjustable. Door stop with adjustable retention spring.

BHS#	DESCRIPTION	U/M	BOX	RETAIL
274-32	NUTONE C907 TRANSFORMER; 16v 30w	ea	6	\$23.86

**DOOR CHIMES**

**NUTONE DOOR CHIMES**

**Wellington Chime**



BHS#	DESCRIPTION	U/M	BOX	RETAIL
274-200	NUTONE LA-70MA WELLINGTON CHIME: FOO	ea	1	\$277.44

**Bellewood**

High gloss white. Two notes for front door, single note for second door. 7 1/2" wide x 5 3/4" high x 2 5/16" deep.



BHS#	DESCRIPTION	U/M	BOX	RETAIL
274-220	NUTONE LA-130WH DOOR CHIME	ea	6	\$55.16

**Non-Electric - "Pre-Vue"**

2-note non-electric door chime with optical lens viewer. Nameplate mounts outside. Cover with viewer mounts inside. Nameplate has sculptured pushbutton and room for name and house or apartment number. Gold trimmed nameplate, with Walnut or French White inside cover or silver trim nameplate with French White cover. Items marked F.O.O. - Allow 2 weeks for delivery.

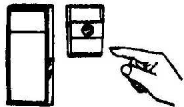

BHS#	DESCRIPTION	U/M	BOX	RETAIL
274-280	NUTONE MCV-309N-WHGL WH & GD CHIME	ea	6	\$52.92

**DOOR CHIMES**

**NUTONE WIRELESS DOOR CHIMES**

**Plug-in Wireless Chime**



Receiver plugs into any AC outlet. Color - White.

<b>BHS#</b>	<b>DESCRIPTION</b>	<b>U/M</b>	<b>BOX</b>	<b>RETAIL</b>
274-250	NUTONE LA-203WH PLUGIN WIRELS CHIME	ea	3	\$42.40

**Economy Wireless Chime**



Compact, contemporary design. Sounds two notes. Mount receiver to wall or place on table. Receiver is powered by three AA batteries (purchase separately). Color - White.

<b>BHS#</b>	<b>DESCRIPTION</b>	<b>U/M</b>	<b>BOX</b>	<b>RETAIL</b>
274-255	NUTONE LA-205WH WIRELESS DOOR CHIME	ea	3	\$37.44

**Select-A-Tone**



Contemporary wave design in bright white. Receiver mounts to wall or can be placed on table. Receiver powered by four D-size batteries (purchase separately). Includes one button. 8" wide x 8 1/2" high x 2 3/4" deep.

<b>BHS#</b>	<b>DESCRIPTION</b>	<b>U/M</b>	<b>BOX</b>	<b>RETAIL</b>
274-260	NUTONE LA-206WH WIRELESS CHIME	ea	3	\$57.36

**DOOR GRILLES**

**TRIMCO DOOR GRILLES**

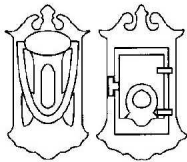

Solid cast bronze. Size 3 5/16" x 6 1/4". Cutout 2 1/4" x 4". Items marked F.O.O. - Allow 2 to 3 weeks for delivery.

<b>BHS#</b>	<b>DESCRIPTION</b>	<b>U/M</b>	<b>BOX</b>	<b>RETAIL</b>
360-10	TRIMCO 912 605 DOOR GRILLE; FOO	ea	1	\$105.00
360-20	TRIMCO 912 609 DOOR GRILLE; FOO	ea	1	\$105.00

**DOOR GUARD**

**DELTANA HEAVY DUTY DOOR GUARD**



Length - 6 3/4" Width - 2" Bar Width - 1/2" Solid Brass.

<b>BHS#</b>	<b>DESCRIPTION</b>	<b>U/M</b>	<b>BOX</b>	<b>RETAIL</b>
546-169104	DELTANA DGSB675U15 DOOR GUARD	ea	5	\$25.00
546-206836	DELTANA DGSB675U10B DOOR GUARD	ea	5	\$25.00

**DOOR KNOCKERS**

**BALDWIN DOOR KNOCKERS**

**"S" Knocker - CTC of Bolts: 5", Size - 2" dia. Base, 7.75" H**



Solid Brass. 2.75" Projection.

<b>BHS#</b>	<b>DESCRIPTION</b>	<b>U/M</b>	<b>BOX</b>	<b>RETAIL</b>
032-73	BALDW 0113.003 "S" DOOR KNOCKER;FOO	ea	1	\$163.00

**DOOR KNOCKERS**

**BALDWIN DOOR KNOCKERS**

**Colonial - CTC of Bolts: 4"**



Solid Brass. Size: 6.5" x 3.5"

<b>BHS#</b>	<b>DESCRIPTION</b>	<b>U/M</b>	<b>BOX</b>	<b>RETAIL</b>
032-71	BALDW 0102.003 COLONIAL DR KNOCKER	ea	1	\$74.00
032-50	BALDW 0102.102 COLONIAL DR KNOCKER	ea	1	\$63.00
032-51	BALDW 0102.150 COLONIAL DR KNOCKER; FOO	ea	1	\$63.00

**French - CTC of Bolts: 5.687"**



Solid Brass. Size: 7.5" x 2.5"

<b>BHS#</b>	<b>DESCRIPTION</b>	<b>U/M</b>	<b>BOX</b>	<b>RETAIL</b>
032-72	BALDW 0106.003 FRENCH DR KNOCKER	ea	1	\$81.00

**Ring - CTC of Bolts: 3.75"**



Size: 4.25" x 5.5". F.O.O. Items - Allow 8 weeks minimum for delivery.

<b>BHS#</b>	<b>DESCRIPTION</b>	<b>U/M</b>	<b>BOX</b>	<b>RETAIL</b>
032-88	BALDW 0195.030 RING DR KNOCKER; FOO	ea	1	\$119.00

**Tahoe - CTC of Bolts: 4"**



Overall size: 5.5" x 4/03".

<b>BHS#</b>	<b>DESCRIPTION</b>	<b>U/M</b>	<b>BOX</b>	<b>RETAIL</b>
032-60	BALDW 0105.112 TAHOE DOOR KNOCKER	ea	1	\$87.00
032-61	BALDW 0105.412 TAHOE DOOR KNOCKER; FOO	ea	1	\$87.00
032-62	BALDW 0105.452 TAHOE DOOR KNOCKER; FOO	ea	1	\$103.00

**DELTANA DOOR KNOCKER WITH VIEWER**



Solid brass material. Integrated viewer. 9/16" bore.

<b>BHS#</b>	<b>DESCRIPTION</b>	<b>U/M</b>	<b>BOX</b>	<b>RETAIL</b>
546-189609	DELTANA DKV630U15 DOOR KNOCKER w/ VIEWER	ea	100	\$26.00
546-206837	DELTANA DKV630U10B DOOR KNOCKER w/ VIEWER	ea	100	\$26.00

**IVES DOOR KNOCKERS**

**Plain**



Forged Brass. Length: 5-15/16" Width: 3" Projection: 1-1/16"

<b>BHS#</b>	<b>DESCRIPTION</b>	<b>U/M</b>	<b>BOX</b>	<b>RETAIL</b>
174-1955	IVES 02-3125 605 KNOCKER	ea	1	\$22.00
174-1956	IVES 02-3125 609 KNOCKER	ea	1	\$26.00
174-1957	IVES 02-3125 619 KNOCKER	ea	1	\$26.00
174-1958	IVES 02-3125 625 KNOCKER	ea	1	\$26.00
174-1959	IVES 02-3125 626 KNOCKER	ea	1	\$26.00
174-19595	IVES 02-3125 716 KNOCKER	ea	1	\$26.00

**DOOR KNOCKERS**

**IVES DOOR KNOCKERS**

**With Viewer**



Forged Brass + UL Listed with #701 120° viewer for 1 3/4" doors. Length: 5-15-16" Width: 3" Projection: 1-1/16"

BHS#	DESCRIPTION	U/M	BOX	RETAIL
174-1964	IVES 02-31252 605 KNOCKER w/VIEWER	ea	1	\$33.30
174-1961	IVES 02-31252 613 KNOCKER w/VIEWER	ea	1	\$83.10
174-1962	IVES 02-31252 619 KNOCKER w/VIEWER	ea	1	\$83.10
174-1963	IVES 02-31252 620 KNOCKER w/VIEWER	ea	1	\$83.10
174-1966	IVES 02-31252 625 KNOCKER w/VIEWER	ea	1	\$83.10
174-1967	IVES 02-31252 626 KNOCKER w/VIEWER	ea	1	\$37.90

**SCHLAGE DOOR KNOCKERS**

**Carded, Solid Brass**



BHS#	DESCRIPTION	U/M	BOX	RETAIL
174-173315	SCH SC 2-3125 605 DOOR KNOCKER	cd	5	\$22.82
174-173317	SCH SC 2-3125 619 DOOR KNOCKER	cd	5	\$27.42
174-173319	SCH SC 2-3125 716 DOOR KNOCKER; CARDED	cd	5	\$27.42

**Carded, Solid Brass, Imperial Style**



BHS#	DESCRIPTION	U/M	BOX	RETAIL
174-173313	SCH SC 2-3107 605 DOOR KNOCKER	cd	2	\$41.16
174-173314	SCH SC 2-3107 619 DOOR KNOCKER	cd	2	\$50.84

**DOOR VIEWERS**

**BALDWIN OBSERV-O-SCOPE**



1/2" diameter quality lens. Adjustable for door thickness from 1.312" to 2.25". The exterior lens is constructed of a scientific glass to prohibit scratching while creating a field of vision exceeding 160°. Individually poly-bagged.

BHS#	DESCRIPTION	U/M	BOX	RETAIL
032-87	BALDW 0155.260 DOOR VIEWER	ea	1	\$15.00

**BRAINERD DOOR VIEWERS**

**160deg. Door Viewer**

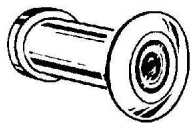

BHS#	DESCRIPTION	U/M	BOX	RETAIL
054-335	BRAIN 647XC 160 BRASS VIEWER; FDWO	cd	5	\$4.78

**180deg. Door Viewer**

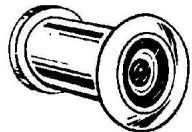

BHS#	DESCRIPTION	U/M	BOX	RETAIL
054-340	BRAIN 648XC 180 BRASS VIEWER; FDWO	cd	5	\$8.03

**200deg. Door Viewer**

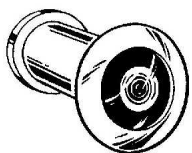

BHS#	DESCRIPTION	U/M	BOX	RETAIL
054-345	BRAIN 649XC 200deg BRASS VIEWER; FDWO	cd	5	\$12.31

**DOOR VIEWERS**

**DELTANA DOOR VIEWER**



<i>BHS#</i>	<i>DESCRIPTION</i>	<i>U/M</i>	<i>BOX</i>	<i>RETAIL</i>
546-124106	DELTANA 55211U15 DOOR VIEWER	ea	12	\$6.80
546-106528	DELTANA 55211U10B DOOR VIEWER	ea	12	\$6.80
546-161744	DELTANA 55211U26D DOOR VIEWER	ea	12	\$6.80

**IVES DOOR VIEWERS**

**120deg. View Angle - Door Thickness 1 3/8" to 2 1/16"**

UL listed for rated fire doors 1 hour or less. One-way vision. Individually poly-bagged.



<i>BHS#</i>	<i>DESCRIPTION</i>	<i>U/M</i>	<i>BOX</i>	<i>RETAIL</i>
174-1862	IVES U700B 4 DOOR VIEWER	ea	10	\$9.00
174-1864	IVES U700B 26D DOOR VIEWER	ea	10	\$9.00

**120deg. View Angle - Door Thickness 2" to 2 3/4"**



<i>BHS#</i>	<i>DESCRIPTION</i>	<i>U/M</i>	<i>BOX</i>	<i>RETAIL</i>
174-1872	IVES U701B 4 120deg DOOR VIEWER	ea	10	\$7.30

**150deg. View Angle - Door Thickness 1 3/8" to 2 1/16"**

UL listed for rated fire doors 1 hour or less. One-way vision. Individually poly-bagged.



<i>BHS#</i>	<i>DESCRIPTION</i>	<i>U/M</i>	<i>BOX</i>	<i>RETAIL</i>
174-1840	IVES U696B 4 150deg DOOR VIEWER	ea	10	\$13.20
174-1842	IVES U696B 26D 150deg DOOR VIEWER	ea	10	\$13.20

**190deg. View Angle - Door Thickness 1 3/8" to 2 1/8"**



<i>BHS#</i>	<i>DESCRIPTION</i>	<i>U/M</i>	<i>BOX</i>	<i>RETAIL</i>
174-18340	IVES 698B 3 DR VIEWR 190dg	ea	10	\$15.40
174-18343	IVES 698B 26D DOOR VIEWER 190deg	ea	10	\$15.40
174-18345	IVES 698B 716 DOOR VIEWER 190deg NEW NUMBER 698P-B716	ea	1	\$15.40
174-1845	IVES U698B 26D DOOR VIEWER	ea	10	\$18.40

**M.A.G. IND. DOOR VIEWERS**

**160deg. Viewer 1/2" dia. Bore**

Solid brass with optical glass lens. Fits 1 3/8" to 2" doors.

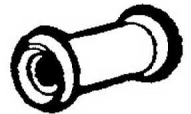

<i>BHS#</i>	<i>DESCRIPTION</i>	<i>U/M</i>	<i>BOX</i>	<i>RETAIL</i>
228-8720	MAG 8720 160deg DOOR VIEWER	cd	10	\$4.66

**190deg. Viewer 1/2" dia. Bore**

Solid brass with optical glass lens. Fits 1 3/8" to 2" doors.



<i>BHS#</i>	<i>DESCRIPTION</i>	<i>U/M</i>	<i>BOX</i>	<i>RETAIL</i>
228-8724	MAG 8724 190deg DOOR VIEWER; BRASS	cd	5	\$7.37

**DOOR VIEWERS**

**M.A.G. IND. DOOR VIEWERS**

**Super Door Viewer 1" dia. Bore**

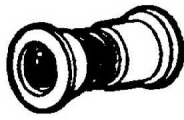

Solid brass with optical glass lens. Fits 1 3/8" to 2" doors.

BHS#	DESCRIPTION	U/M	BOX	RETAIL
228-8728	MAG 8728 SUPER DOOR VIEWER	cd	10	\$13.51

**SCHLAGE DOOR VIEWERS**

**120deg. View Angle - Door Thickness 1 3/8" To 2 1/8"**



BHS#	DESCRIPTION	U/M	BOX	RETAIL
174-173394	SCH SC 700P-B 605 DOOR VIEWER 120dg	cd	5	\$6.70

**190deg. View Angle - Door Thickness 1 3/8" To 2 1/8"**



BHS#	DESCRIPTION	U/M	BOX	RETAIL
174-173391	SCH SC 698P-B 605 DOOR VIEWER 190dg	cd	5	\$15.86
174-173392	SCH SC 698P-B 619 DOOR VIEWER 190dg	cd	5	\$17.78
174-173393	SCH SC 698P-B 716 DOOR VIEWER 190dg	cd	5	\$17.78

**SLIDECO DOOR VIEWER**

**For 3/4" Thick Panel**



DESCRIPTION	U/M	BOX	RETAIL
SLIDECO U-10351 DOOR VIEWER; BRASS (for 3/4" thick panel)	ea	6	\$7.10
SLIDECO U-10392 DOOR VIEWER; SATIN NICKEL (for 3/4" thick panel)	ea	6	\$15.63

**STANLEY DOOR VIEWERS**

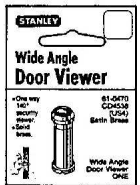

Solid brass with wide-angle lens. Fits all standard doors from 1 3/8" to 1 7/8" thick. One-way 140° security viewer. Easy to install. Carded - one per card.

BHS#	DESCRIPTION	U/M	BOX	RETAIL
332-3683	STAN CD4538 US3 120dg VIEWER 610470	cd	5	\$7.32

**TAYMOR DOOR VIEWERS**



BHS#	DESCRIPTION	U/M	BOX	RETAIL
785-9001	TAYM 37-B4841B US3 DR VWR 160deg	ea	1	\$2.63
785-9000	TAYM 37-B4841AB US5 DR VWR 160deg	ea	1	\$2.63
785-9004	TAYM 37-B4841ORB 10B DR VIEWER 160deg	ea	1	\$2.84
785-9002	TAYM 37-B4841N US14 VIEWER 160deg	ea	1	\$2.63
785-9003	TAYM 37-B4841SN US15 VIEWER 160deg	ea	1	\$2.84

**HOME PROTECTOR "PEEKO" DOOR VIEWER**

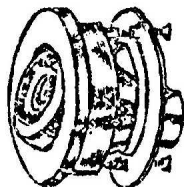

Revolving door viewer engineered to provide a full 140° visibility. Revolves from inside to provide an extra measure of safety. For doors 1" to 2" in thickness. Bore 2 3/8".

BHS#	DESCRIPTION	U/M	BOX	RETAIL
164-10	HOME PROTECTOR 595 US3 DOOR VIEWER (PEEKO)	ea	1	\$60.90
164-20	HOME PROTECTOR 595 US5 DOOR VIEWER (PEEKO); FOO	ea	1	\$60.90
164-70	HOME PROTECTOR 595 26D DOOR VIEWER (PEEKO)	ea	1	\$60.90

**CHAIN DOOR GUARDS**

**BRAINERD CHAIN DOOR GUARDS**

**Antique Solid Brass - Extruded**

Carded with screws.



<b>BHS#</b>	<b>DESCRIPTION</b>	<b>U/M</b>	<b>BOX</b>	<b>RETAIL</b>
054-275	BRAIN 585AXC ANTIQUE BRASS GUARD; FDWO	cd	10	\$5.51

**Polished Brass**

Carded with screws.



<b>BHS#</b>	<b>DESCRIPTION</b>	<b>U/M</b>	<b>BOX</b>	<b>RETAIL</b>
054-265	BRAIN 583XC POLISHED BR GUARD; FDWO	cd	10	\$4.26

**Polished Solid Brass - Extruded**

Carded with screws.



<b>BHS#</b>	<b>DESCRIPTION</b>	<b>U/M</b>	<b>BOX</b>	<b>RETAIL</b>
054-270	BRAIN 585XC POLISHED BR GUARD; FDWO	cd	10	\$4.80

**BRAINERD CHAIN DOOR GUARDS WITH BOLT**

Can be used separately - as a chain door guard or as a dead bolt - but for double protection, both safety features can be used. Hand polished brass case. Size: Door Plate 3 3/8" x 1 1/2", Holder Plate 3/4" x 1 1/2". Carded with screws.



<b>BHS#</b>	<b>DESCRIPTION</b>	<b>U/M</b>	<b>BOX</b>	<b>RETAIL</b>
054-280	BRAIN 588XC POLISHED BR GUARD; FDWO	cd	10	\$7.74

**SCHLAGE CHAIN DOOR GUARDS**

<b>BHS#</b>	<b>DESCRIPTION</b>	<b>U/M</b>	<b>BOX</b>	<b>RETAIL</b>
174-173351	SCH SC 481F 3 CHAIN DOOR GUARD	cd	5	\$5.98
174-173352	SCH SC 481F 619 CHAIN DOOR GUARD	cd	5	\$5.98
174-173353	SCH SC 481F 716 CHAIN DOOR GUARD	cd	5	\$5.98

**STANLEY CHAIN DOOR GUARD**

For use to limit entrance door openings in residences and apartments. Finely finished chain door guard features a solid brass receiver and base. Steel chain provides strength for added security. Modern design is complemented by attractive bright brass finish. Door Plate Length x Width 3 1/2" x 2 9/32".



<b>BHS#</b>	<b>DESCRIPTION</b>	<b>U/M</b>	<b>BOX</b>	<b>RETAIL</b>
332-4006	STAN CD7088 US4 DOOR GUARD 610240	cd	10	\$2.99

**FLIP LOCKS**

**M.A.G. IND. FLIP LOCKS**

**Standard Privacy Flip Lock**

For in-opening doors only. Left or right handed doors. Brass finish.

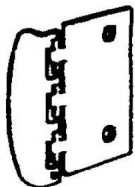

<b>BHS#</b>	<b>DESCRIPTION</b>	<b>U/M</b>	<b>BOX</b>	<b>RETAIL</b>
228-8705	MAG 8705 BRASS PRIVACY FLIP LOCK	cd	10	\$1.60



**FLIP LOCKS**

**SLIDE-CO FLIP LOCKS**

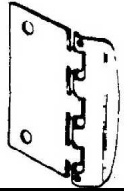

Double lock your door. F.O.O. Items - Allow 2 weeks.

BHS#	DESCRIPTION	U/M	BOX	RETAIL
324-1250	SLIDECO 15267 SAFETY LOCK; FOO	ea	6	\$2.69

**DOOR CLUB**

**WINNER THE DOOR CLUB**



Reliable Home Security from the leaders in Automotive Security Products. Solid steel construction for homes, apartments, condominiums, student dormitories, offices, hotels and more! Can easily resist over 2 tons of direct force, keeping burglars from kicking the door in. Comes complete with all the necessary hardware to effectively secure any door in your home. For best results and added security, install The Door Club on solid core doors. Not only one of the strongest anti-burglar devices available, it's also an attractive accessory to your door. The brass or antique finish will add to the beauty of your home.

BHS#	DESCRIPTION	U/M	BOX	RETAIL
879-208526	WINNERS 20CA US3 THE DOOR CLUB POLISHED BRASS	ea	1	\$28.75
879-208530	WINNERS 25CA US5 THE DOOR CLUB ANTIQUÉ BRASS	ea	1	\$28.75

**JAMB ARMOR**

**ARMOR CONCEPTS JAMB ARMOR**



- An easy, effective way to repair a broken door jamb and help prevent an existing door from being kicked in. The Exterior FIX-A-JAMB piece is a 36-inch long sleeve that easily slides over a damaged jamb and can be installed in about 20 minutes. FAJ-EXT-10000 is the jamb only. See the universal combo sets below for sets that include hinge protection and latch guards.

BHS#	DESCRIPTION	U/M	BOX	RETAIL
481-208276	ARMOR FAJ-EXT-10000-RP EXTERIOR FIX-A-JAMB PKG	ea	1	\$70.52

**ARMOR CONCEPTS JAMB ARMOR COMBO SETS**

**2 3/4" B.S.**



An easy, effective way to repair a broken door jamb and help prevent an existing door from being kicked in. 5 steel sleeves (that come with the combo set) slide over the existing door jamb, essentially turning a wooden frame into a steel frame. Pieces work together to reinforce all of the weak points on an entry door. Installation does not require removal of the door or alteration of the jamb in any way. Equipped with 1 ultra jamb shield (designed with knockouts that allow pieces to be used on nearly any door), 2 hinge shields to reinforce the top and bottom hinges, and a 2-piece door shield set (1 for the deadbolt and knob). All pieces come in powder-coated white and can be painted to match the color of the door or jamb. Compatible with any standard (1 3/4"-thick) entry door with a 3/4" jamb. Available for doors with 2 3/8" and 2 3/4" backset locks. Installation screws included.

BHS#	DESCRIPTION	U/M	BOX	RETAIL
481-208275	ARMOR SET-UNI-20002 UNIVERSAL COMBO SET 2-3/4"BS	ea	1	\$125.96

**2 3/8" B.S.**



- An easy, effective way to repair a broken door jamb and help prevent an existing door from being kicked in. 5 steel sleeves (that come with the combo set) slide over the existing door jamb, essentially turning a wooden frame into a steel frame. Pieces work together to reinforce all of the weak points on an entry door. Installation does not require removal of the door or alteration of the jamb in any way. Equipped with 1 ultra jamb shield (designed with knockouts that allow pieces to be used on nearly any door), 2 hinge shields to reinforce the top and bottom hinges, and a 2-piece door shield set (1 for the deadbolt and knob). All pieces come in powder-coated white and can be painted to match the color of the door or jamb. Compatible with any standard (1 3/4"-thick) entry door with a 3/4" jamb. Available for doors with 2 3/8" and 2 3/4" backset locks. Installation screws included.

BHS#	DESCRIPTION	U/M	BOX	RETAIL
481-208274	ARMOR SET-UNI-10002 UNIVERSAL COMBO SET 2-3/8"BS	ea	1	\$125.96

**SLIDING DOOR BAR**

**M.A.G. IND. SLIDING DOOR BAR**

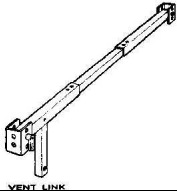

**Patio and Sliding Door Locks**

Heavy Gauge Steel. Maximum security. Locks in vented or closed position. Adjusts to fit 28" to 48" door. Mounts on inside or outside sliders. Lock prevents lifting bar from outside. Easy installation. Stores neatly when not in use.

BHS#	DESCRIPTION	U/M	BOX	RETAIL
228-8820	MAG 8820 SLIDING DOOR BAR	cd	5	\$18.43

**SLIDING DOOR LOCKS**

**M.A.G. IND. SLIDING DOOR LOCKS**

**Sliding Door and Window Locks**

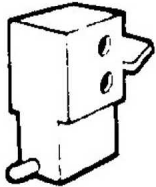

Foot or hand operated. Mounts on top or bottom. Can be used on inside or outside sliders.

BHS#	DESCRIPTION	U/M	BOX	RETAIL
228-8755	MAG 8755 SLIDING DOOR LOCK	cd	10	\$3.69

**SLIDE-CO GLASS DOOR LOCKS**

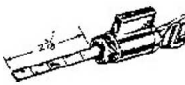

Keyed Cylinder Lock, Weiser Keyway, Keyed Differently.

BHS#	DESCRIPTION	U/M	BOX	RETAIL
324-350	SLIDECO 1505 KEYED CYL LOCK (same as E-2103)	ea	6	\$11.98

**LOCKS, PATIO DOOR**

**M.A.G. IND. SLIDING PATIO DOOR PIN LOCK**

**Sliding Door and Window Locks**

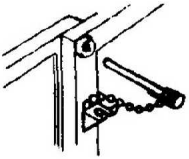

Pin locks into retaining ring prevents removal from outside.

BHS#	DESCRIPTION	U/M	BOX	RETAIL
228-8752	MAG 8752 SLIDING PATIO DR PIN LOCK	cd	10	\$1.95

**SLIDE-CO PATIO DOOR LOCKING PIN**

**Glass Door Locks**

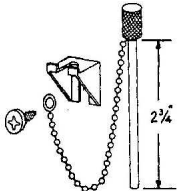

Drill a 3/16" dia. hole through meeting stiles from interior side of door. Insert pin in hole and fasten chain grommet with screw provided. Allow slack in chain to remove pin for door operation. 1 per package with screw and holder.

BHS#	DESCRIPTION	U/M	BOX	RETAIL
324-1290	SLIDECO 15301 PATIO DR LOCK PIN	ea	6	\$2.39

**WRIGHT SLIDING PATIO DOOR PIN LOCK**

**Patio Hardware**

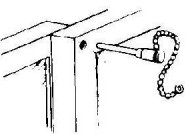

Installs by drilling 3/16" hole through sliding door and into one side of stationary door. Skin pack.

BHS#	DESCRIPTION	U/M	BOX	RETAIL
414-170	WRIGHT V108 PATIO PIN LOCK	ea	10	\$3.49

**WRIGHT REPLACEMENT PATIO DOOR HARDWARE**

**Surface Mounted - V1104**

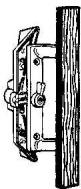

Internal latching. Reversible for right or left hand application. Either automatic locking or "No Lock Out" feature (your choice during installation). Oak Handle. For 1" to 1 3/8" Aluminum doors. Aluminum finish.

BHS#	DESCRIPTION	U/M	BOX	RETAIL
414-470	WRIGHT V1104 ALUM PATIO LATCH	ea	6	\$27.43

**LOCKS, PATIO DOOR**

**WRIGHT REPLACEMENT PATIO DOOR HARDWARE**

**Surface Mounted - V1200**

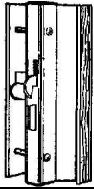

Reversible for right or left hand application. Surface mount by drilling three 1/4" holes. Retractable latch prevents lock out. Anti-lift bolt resists prying or lifting of door. For 7/8" to 1 1/4" thick doors. Aluminum finish. Skin pack.

BHS#	DESCRIPTION	U/M	BOX	RETAIL
414-550	WRIGHT V1200 ALUM PATIO LATCH	ea	6	\$36.63

**Surface Mounted, Inside Only - V1104IS**

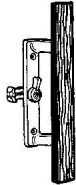

Inside portion of the V1104. Oak Handle. Aluminum finish.

BHS#	DESCRIPTION	U/M	BOX	RETAIL
414-490	WRIGHT V1104IS ALUM INSIDE ASSEMBLY FOO	ea	6	\$30.74

**Surface Mounted, with Key Locking unit - VK1104**

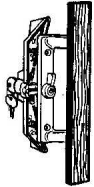

Internal latching. Reversible for right or left hand application. Either automatic locking or "No Lock Out" feature (your choice during installation). Oak Handle. For 1" to 1 3/8" Aluminum doors. Key lock for extra security. Aluminum finish.

BHS#	DESCRIPTION	U/M	BOX	RETAIL
414-500	WRIGHT VK1104 ALUM PATIO LOCK	ea	6	\$30.74

**SLIDING WINDOW LOCKS**

**M.A.G. IND. SLIDING WINDOW LOCKS**

**Heavy Duty with Security Screw**

With Pointed Security Screw, Heavy Duty. For winow or door. 2 per card. Aluminium.



BHS#	DESCRIPTION	U/M	BOX	RETAIL
228-8732	MAG 8732 H.D. SLIDING WINDOW LOCK	cd	10	\$1.95

**HOUSE NUMBERS**

**BALDWIN HOUSE NUMBERS**

**5" Lifetime Finish 003**



Forged brass including screws. Carded. Packed 5 per carton. Size: 5" (127mm), thickness: .406" (10mm).

BHS#	DESCRIPTION	U/M	BOX	RETAIL
032-440	BALDW 9 0670.003 5" HOUSE NUMBER #0 (CARDED)	ea	1	\$23.00
032-441	BALDW 9 0671.003 5" HOUSE NUMBER #1 (CARDED)	ea	4	\$23.00
032-442	BALDW 9 0672.003 5" HOUSE NUMBER #2 (CARDED)	ea	1	\$23.00
032-443	BALDW 9 0673.003 5" HOUSE NUMBER #3 (CARDED)	ea	1	\$23.00
032-444	BALDW 9 0674.003 5" HOUSE NUMBER #4 (CARDED)	ea	1	\$23.00
032-445	BALDW 9 0675.003 5" HOUSE NUMBER #5 (CARDED)	ea	1	\$23.00
032-446	BALDW 9 0676.003 5" HOUSE NUMB #6/9 (Use for #6 or #9) (CARDED)	ea	1	\$23.00
032-447	BALDW 9 0677.003 5" HOUSE NUMBER #7 (CARDED)	ea	1	\$23.00
032-448	BALDW 9 0678.003 5" HOUSE NUMBER #8 (CARDED)	ea	1	\$23.00

**HOUSE NUMBERS**

**BALDWIN HOUSE NUMBERS**

**5" Finish - 102 Oil Rubbed Bronze**



Forged brass including screws. Carded. Packed 5 per carton. Size: 5" (127mm), thickness: .406" (10mm).

<b>BHS#</b>	<b>DESCRIPTION</b>	<b>U/M</b>	<b>BOX</b>	<b>RETAIL</b>
032-430	BALDW 9 0670.102 5" HOUSE NUMBER #0 (CARDED)	ea	1	\$20.00
032-431	BALDW 9 0671.102 5" HOUSE NUMBER #1 (CARDED)	ea	1	\$20.00
032-432	BALDW 9 0672.102 5" HOUSE NUMBER #2 (CARDED)	ea	1	\$20.00
032-433	BALDW 9 0673.102 5" HOUSE NUMBER #3 (CARDED)	ea	1	\$20.00
032-434	BALDW 9 0674.102 5" HOUSE NUMBER #4 (CARDED)	ea	1	\$20.00
032-435	BALDW 9 0675.102 5" HOUSE NUMBER #5 (CARDED)	ea	1	\$20.00
032-436	BALDW 9 0676.102 5" HOUSE NUMB #6/9 (Use for #6 or #9) (CARDED)	ea	1	\$20.00
032-437	BALDW 9 0677.102 5" HOUSE NUMBER #7 (CARDED)	ea	1	\$20.00
032-438	BALDW 9 0678.102 5" HOUSE NUMBER #8 (CARDED)	ea	1	\$20.00

**5" Finish - 150 Satin Nickel**



Forged brass including screws. Carded. Packed 5 per carton. Size: 5" (127mm), thickness: .406" (10mm).

<b>BHS#</b>	<b>DESCRIPTION</b>	<b>U/M</b>	<b>BOX</b>	<b>RETAIL</b>
032-450	BALDW 9 0670.150 5" HOUSE NUMBER #0 (CARDED)	ea	1	\$20.00
032-451	BALDW 9 0671.150 5" HOUSE NUMBER #1 (CARDED)	ea	1	\$20.00
032-452	BALDW 9 0672.150 5" HOUSE NUMBER #2 (CARDED)	ea	1	\$20.00
032-453	BALDW 9 0673.150 5" HOUSE NUMBER #3 (CARDED)	ea	1	\$20.00
032-454	BALDW 9 0674.150 5" HOUSE NUMBER #4 (CARDED)	ea	1	\$20.00
032-455	BALDW 9 0675.150 5" HOUSE NUMBER #5 (CARDED)	ea	1	\$20.00
032-456	BALDW 9 0676.150 5" HOUSE NUMB #6/9 (Use for #6 or #9) (CARDED)	ea	1	\$20.00
032-457	BALDW 9 0677.150 5" HOUSE NUMBER #7 (CARDED)	ea	1	\$20.00
032-458	BALDW 9 0678.150 5" HOUSE NUMBER #8 (CARDED)	ea	1	\$20.00

**BRAINERD HOUSE NUMBERS**

**5" High, Black Plastic**



<b>BHS#</b>	<b>DESCRIPTION</b>	<b>U/M</b>	<b>BOX</b>	<b>RETAIL</b>
054-1200	BRAIN 3050 5" BLACK PLASTIC #0	ea	10	\$1.25
054-1201	BRAIN 3050 5" BLACK PLASTIC #1	ea	10	\$1.25
054-1203	BRAIN 3050 5" BLACK PLASTIC #3	ea	10	\$1.25
054-1204	BRAIN 3050 5" BLACK PLASTIC #4	ea	10	\$1.25
054-1205	BRAIN 3050 5" BLACK PLASTIC #5	ea	10	\$1.25
054-1206	BRAIN 3050 5" BLACK PLASTIC #6	ea	10	\$1.25
054-1207	BRAIN 3050 5" BLACK PLASTIC #7	ea	10	\$1.25
054-1208	BRAIN 3050 5" BLACK PLASTIC #8	ea	10	\$1.25
054-1209	BRAIN 3050 5" BLACK PLASTIC #9	ea	10	\$1.25

**HOUSE NUMBERS**

**SCHLAGE HOUSE NUMBERS**

**4" Bright Brass, Clear Coated, Carded**



BHS#	DESCRIPTION	U/M	BOX	RETAIL
174-173283	SCH SC 2-3006 605 #0 HOUSE NO.; 4"	cd	5	\$6.93
174-173286	SCH SC 2-3016 605 #1 HOUSE NO.; 4"	cd	5	\$6.93
174-173289	SCH SC 2-3026 605 #2 HOUSE NO.; 4"	cd	5	\$6.93
174-173292	SCH SC 2-3036 605 #3 HOUSE NO.; 4"	cd	5	\$6.93
174-173295	SCH SC 2-3046 605 #4 HOUSE NO.; 4"	cd	5	\$6.93
174-173298	SCH SC 2-3056 605 #5 HOUSE NO.; 4"	cd	5	\$6.93
174-173301	SCH SC 2-3066 605 #6 HOUSE NO.; 4"	cd	5	\$6.93
174-173304	SCH SC 2-3076 605 #7 HOUSE NO.; 4"	cd	5	\$6.93
174-173307	SCH SC 2-3086 605 #8 HOUSE NO.; 4"	cd	5	\$6.93
174-173310	SCH SC 2-3096 605 #9 HOUSE NO.; 4"	cd	5	\$6.93

**4" Satin Nickel, Clear Coated, Carded**



BHS#	DESCRIPTION	U/M	BOX	RETAIL
174-173284	SCH SC 2-3006 619 #0 HOUSE NO.; 4"	cd	5	\$8.96
174-173287	SCH SC 2-3016 619 #1 HOUSE NO.; 4"	cd	5	\$8.96
174-173290	SCH SC 2-3026 619 #2 HOUSE NO.; 4"	cd	5	\$8.96
174-173293	SCH SC 2-3036 619 #3 HOUSE NO.; 4"	cd	5	\$8.96
174-173296	SCH SC 2-3046 619 #4 HOUSE NO.; 4"	cd	5	\$8.96
174-173299	SCH SC 2-3056 619 #5 HOUSE NO.; 4"	cd	5	\$8.96
174-173302	SCH SC 2-3066 619 #6 HOUSE NO.; 4"	cd	5	\$8.96
174-173305	SCH SC 2-3076 619 #7 HOUSE NO.; 4"	cd	5	\$8.96
174-173308	SCH SC 2-3086 619 #8 HOUSE NO.; 4"	cd	5	\$8.96
174-173311	SCH SC 2-3096 619 #9 HOUSE NO.; 4"	cd	5	\$8.96

**4" Aged Bronze, Clear Coated, Carded**



BHS#	DESCRIPTION	U/M	BOX	RETAIL
174-173285	SCH SC 2-3006 716 #0 HOUSE NO.; 4"	cd	5	\$8.96
174-173288	SCH SC 2-3016 716 #1 HOUSE NO.; 4"	cd	5	\$8.96
174-173291	SCH SC 2-3026 716 #2 HOUSE NO.; 4"	cd	5	\$8.96
174-173294	SCH SC 2-3036 716 #3 HOUSE NO.; 4"	cd	5	\$8.96
174-173297	SCH SC 2-3046 716 #4 HOUSE NO.; 4"	cd	5	\$8.96
174-173300	SCH SC 2-3056 716 #5 HOUSE NO.; 4"	cd	5	\$8.96
174-173303	SCH SC 2-3066 716 #6 HOUSE NO.; 4"	cd	5	\$8.96
174-173306	SCH SC 2-3076 716 #7 HOUSE NO.; 4"	cd	5	\$8.96
174-173309	SCH SC 2-3086 716 #8 HOUSE NO.; 4"	cd	5	\$8.96
174-173312	SCH SC 2-3096 716 #9 HOUSE NO.; 4"	cd	5	\$8.96

**HOUSE NUMBERS**

**STANLEY HOUSE NUMBERS**

**Finish 1D**

Full 4" size for greater visibility. Made of non-ferrous, rust proof metal. Black (US1D) finish. Packed 10 per box. Weight per box 1 lb.

**012**

<i>BHS#</i>	<i>DESCRIPTION</i>	<i>U/M</i>	<i>BOX</i>	<i>RETAIL</i>
332-4061	STAN CD7130 US1D #0 HOUSE NO. 579917	cd	10	\$3.37
332-4062	STAN CD7130 US1D #1 HOUSE NO. 579922	cd	10	\$3.37
332-4063	STAN CD7130 US1D #2 HOUSE NO. 579928	cd	10	\$3.37
332-4064	STAN CD7130 US1D #3 HOUSE NO. 579933	cd	10	\$3.37
332-4065	STAN CD7130 US1D #4 HOUSE NO. 579938	cd	10	\$3.37
332-4066	STAN CD7130 US1D #5 HOUSE NO. 579943	cd	10	\$3.37
332-4067	STAN CD7130 US1D #6 HOUSE NO. 579948	cd	10	\$3.37
332-4068	STAN CD7130 US1D #7 HOUSE NO. 579953	cd	10	\$3.37
332-4069	STAN CD7130 US1D #8 HOUSE NO. 579958	cd	10	\$3.37
332-4070	STAN CD7130 US1D #9 HOUSE NO. 579963	cd	10	\$3.37

**HOUSE NUMBERS & LETTERS**

**DELTANA HOUSE NUMBERS**

**4" Polished Brass Number**

1  
2  
3  
4



<i>BHS#</i>	<i>DESCRIPTION</i>	<i>U/M</i>	<i>BOX</i>	<i>RETAIL</i>
546-212288	DELTANA RN4-0 CR003 #0 4" NUMBER	ea	10	\$16.40
546-212289	DELTANA RN4-1 CR003 #1 4" NUMBER	ea	10	\$16.40
546-212291	DELTANA RN4-3 CR003 #3 4" NUMBER	ea	10	\$16.40
546-212293	DELTANA RN4-5 CR003 #5 4" NUMBER	ea	10	\$16.40
546-212296	DELTANA RN4-8 CR003 #8 4" NUMBER	ea	10	\$16.40
546-212297	DELTANA RN4-9 CR003 #9 4" NUMBER	ea	10	\$16.40

**4" Satin Nickel Number**

1  
2  
3  
4



<i>BHS#</i>	<i>DESCRIPTION</i>	<i>U/M</i>	<i>BOX</i>	<i>RETAIL</i>
546-127868	DELTANA RN4-0U15 #0 4" NUMBER	ea	10	\$10.95
546-127841	DELTANA RN4-1U15 #1 4" NUMBER	ea	10	\$10.95
546-127844	DELTANA RN4-2U15 #2 4" NUMBER	ea	10	\$10.95
546-127845	DELTANA RN4-3U15 #3 4" NUMBER	ea	10	\$10.95
546-127846	DELTANA RN4-4U15 #4 4" NUMBER	ea	10	\$10.95
546-127847	DELTANA RN4-5U15 #5 4" NUMBER	ea	10	\$10.95
546-127858	DELTANA RN4-6U15 #6 4" NUMBER	ea	10	\$10.95
546-127864	DELTANA RN4-7U15 #7 4" NUMBER	ea	10	\$10.95
546-127865	DELTANA RN4-8U15 #8 4" NUMBER	ea	10	\$10.95
546-127866	DELTANA RN4-9U15 #9 4" NUMBER	ea	10	\$10.95

**4" Oil-Rubbed Bronze Number**

1  
2  
3  
4



<i>BHS#</i>	<i>DESCRIPTION</i>	<i>U/M</i>	<i>BOX</i>	<i>RETAIL</i>
546-172148	DELTANA RN4-0U10B #0 4" NUMBER	ea	10	\$10.95
546-170196	DELTANA RN4-1U10B #1 4" NUMBER	ea	10	\$10.95
546-170197	DELTANA RN4-2U10B #2 4" NUMBER	ea	10	\$10.95
546-170198	DELTANA RN4-3U10B #3 4" NUMBER	ea	10	\$10.95

**HOUSE NUMBERS & LETTER**

**DELTANA HOUSE NUMBERS**

**4" Oil-Rubbed Bronze Number**

	<b>BHS#</b>	<b>DESCRIPTION</b>	<b>U/M</b>	<b>BOX</b>	<b>RETAIL</b>
	546-170199	DELTANA RN4-4U10B #4 4" NUMBER	ea	10	\$10.95
	546-172149	DELTANA RN4-5U10B #5 4" NUMBER	ea	10	\$10.95
	546-172151	DELTANA RN4-6U10B #6 4" NUMBER	ea	10	\$10.95
	546-172146	DELTANA RN4-7U10B #7 4" NUMBER	ea	10	\$10.95
	546-172145	DELTANA RN4-8U10B #8 4" NUMBER	ea	10	\$10.95
	546-170200	DELTANA RN4-9U10B #9 4" NUMBER	ea	10	\$10.95

**HOUSE NUMBERS & LETTERS**

**DELTANA HOUSE LETTERS**

**4" Letters**

	<b>BHS#</b>	<b>DESCRIPTION</b>	<b>U/M</b>	<b>BOX</b>	<b>RETAIL</b>
	546-136077	DELTANA RL4A-10B 4" LETTER 'A'	ea	10	\$14.40
	546-136078	DELTANA RL4B-10B 4" LETTER 'B'	ea	10	\$14.40
	546-137322	DELTANA RL4A-15 4" LETTER 'A'	ea	10	\$14.40
	546-137363	DELTANA RL4B-15 4" LETTER 'B'	ea	10	\$14.40

**MOUNTAIN HOME WOOD HOUSE NUMBERS AND LETTERS**

**4" Letters**

All letters guaranteed against knots and defects. Made of Washington State ponderosa pine.

	<b>BHS#</b>	<b>DESCRIPTION</b>	<b>U/M</b>	<b>BOX</b>	<b>RETAIL</b>
	256-10	BEAVERWD 'A' 4" PINE LETTER	ea	1	\$2.66
	256-11	BEAVERWD 'B' 4" PINE LETTER	ea	1	\$2.66
	256-12	BEAVERWD 'C' 4" PINE LETTER	ea	1	\$2.66
	256-13	BEAVERWD 'D' 4" PINE LETTER	ea	1	\$2.66
	256-14	BEAVERWD 'E' 4" PINE LETTER	ea	1	\$2.66
	256-16	BEAVERWD 'F' 4" PINE LETTER	ea	1	\$2.66
	256-17	BEAVERWD 'G' 4" PINE LETTER	ea	1	\$2.66
	256-18	BEAVERWD 'H' 4" PINE LETTER	ea	1	\$2.66
	256-19	BEAVERWD 'I' 4" PINE LETTER	ea	1	\$2.66
	256-20	BEAVERWD 'J' 4" PINE LETTER	ea	1	\$2.66
	256-22	BEAVERWD 'K' 4" PINE LETTER	ea	1	\$2.66
	256-23	BEAVERWD 'L' 4" PINE LETTER	ea	1	\$2.66
	256-24	BEAVERWD 'M' 4" PINE LETTER	ea	1	\$2.66
	256-25	BEAVERWD 'N' 4" PINE LETTER	ea	1	\$2.66
	256-26	BEAVERWD 'O' 4" PINE LETTER	ea	1	\$2.66
	256-28	BEAVERWD 'P' 4" PINE LETTER	ea	1	\$2.66
	256-29	BEAVERWD 'Q' 4" PINE LETTER	ea	1	\$2.66
	256-30	BEAVERWD 'R' 4" PINE LETTER	ea	1	\$2.66
	256-31	BEAVERWD 'S' 4" PINE LETTER	ea	1	\$2.66
	256-32	BEAVERWD 'T' 4" PINE LETTER	ea	1	\$2.66
	256-34	BEAVERWD 'U' 4" PINE LETTER	ea	1	\$2.66
	256-35	BEAVERWD 'V' 4" PINE LETTER	ea	1	\$2.66
	256-36	BEAVERWD 'W' 4" PINE LETTER	ea	1	\$2.66
	256-37	BEAVERWD 'X' 4" PINE LETTER	ea	1	\$2.66
	256-38	BEAVERWD 'Y' 4" PINE LETTER	ea	1	\$2.66
	256-39	BEAVERWD 'Z' 4" PINE LETTER	ea	1	\$2.66
256-40	BEAVERWD '&' 4" PINE AMPERSAND	ea	1	\$2.66	

**HOUSE NUMBERS & LETTERS**

**MOUNTAIN HOME WOOD HOUSE NUMBERS AND LETTERS**

**4" Numbers**



All numbers guaranteed against knots and defects. Made of Washington State ponderosa pine. For Number 9, use Number 6 upside down.

BHS#	DESCRIPTION	U/M	BOX	RETAIL
256-50	BEAVERWD #0 4" PINE NUMBER	ea	1	\$2.66
256-51	BEAVERWD #1 4" PINE NUMBER	ea	1	\$2.66
256-52	BEAVERWD #2 4" PINE NUMBER	ea	1	\$2.66
256-53	BEAVERWD #3 4" PINE NUMBER	ea	1	\$2.66
256-54	BEAVERWD #4 4" PINE NUMBER	ea	1	\$2.66
256-55	BEAVERWD #5 4" PINE NUMBER	ea	1	\$2.66
256-56	BEAVERWD #6/#9 4" PINE NUMBER	ea	1	\$2.66
256-57	BEAVERWD #7 4" PINE NUMBER	ea	1	\$2.66
256-58	BEAVERWD #8 4" PINE NUMBER	ea	1	\$2.66

**6" Letters**



All letters guaranteed against knots and defects. Made of Washington State ponderosa pine.

BHS#	DESCRIPTION	U/M	BOX	RETAIL
256-70	BEAVERWD 'A' 6" PINE LETTER	ea	1	\$3.15
256-71	BEAVERWD 'B' 6" PINE LETTER	ea	1	\$3.15
256-72	BEAVERWD 'C' 6" PINE LETTER	ea	1	\$3.15
256-73	BEAVERWD 'D' 6" PINE LETTER	ea	1	\$3.15
256-74	BEAVERWD 'E' 6" PINE LETTER	ea	1	\$3.15
256-76	BEAVERWD 'F' 6" PINE LETTER	ea	1	\$3.15
256-77	BEAVERWD 'G' 6" PINE LETTER	ea	1	\$3.15
256-78	BEAVERWD 'H' 6" PINE LETTER	ea	1	\$3.15
256-79	BEAVERWD 'I' 6" PINE LETTER	ea	1	\$3.15
256-80	BEAVERWD 'J' 6" PINE LETTER	ea	1	\$3.15
256-82	BEAVERWD 'K' 6" PINE LETTER	ea	1	\$3.15
256-83	BEAVERWD 'L' 6" PINE LETTER	ea	1	\$3.15
256-84	BEAVERWD 'M' 6" PINE LETTER	ea	1	\$3.15
256-85	BEAVERWD 'N' 6" PINE LETTER	ea	1	\$3.15
256-86	BEAVERWD 'O' 6" PINE LETTER	ea	1	\$3.15
256-88	BEAVERWD 'P' 6" PINE LETTER	ea	1	\$3.15
256-89	BEAVERWD 'Q' 6" PINE LETTER	ea	1	\$3.15
256-90	BEAVERWD 'R' 6" PINE LETTER	ea	1	\$3.15
256-91	BEAVERWD 'S' 6" PINE LETTER	ea	1	\$3.15
256-92	BEAVERWD 'T' 6" PINE LETTER	ea	1	\$3.15
256-94	BEAVERWD 'U' 6" PINE LETTER	ea	1	\$3.15
256-95	BEAVERWD 'V' 6" PINE LETTER	ea	1	\$3.15
256-96	BEAVERWD 'W' 6" PINE LETTER	ea	1	\$3.15
256-97	BEAVERWD 'X' 6" PINE LETTER	ea	1	\$3.15
256-98	BEAVERWD 'Y' 6" PINE LETTER	ea	1	\$3.15
256-99	BEAVERWD 'Z' 6" PINE LETTER	ea	1	\$3.15
256-100	BEAVERWD '&' 6" PINE AMPERSAND	ea	1	\$3.15

**6" Numbers**



All numbers guaranteed against knots and defects. Made of Washington State ponderosa pine. For Number 9, use Number 6 upside down.

BHS#	DESCRIPTION	U/M	BOX	RETAIL
256-110	BEAVERWD #0 6" PINE NUMBER	ea	1	\$3.15
256-111	BEAVERWD #1 6" PINE NUMBER	ea	1	\$3.15
256-112	BEAVERWD #2 6" PINE NUMBER	ea	1	\$3.15
256-113	BEAVERWD #3 6" PINE NUMBER	ea	1	\$3.15
256-114	BEAVERWD #4 6" PINE NUMBER	ea	1	\$3.15
256-115	BEAVERWD #5 6" PINE NUMBER	ea	1	\$3.15
256-116	BEAVERWD #6/#9 6" PINE NUMBER	ea	1	\$3.15
256-117	BEAVERWD #7 6" PINE NUMBER	ea	1	\$3.15
256-118	BEAVERWD #8 6" PINE NUMBER	ea	1	\$3.15



**HOUSE NUMBERS & LETTERS**

**MOUNTAIN HOME WOOD HOUSE NUMBERS AND LETTERS**

**8" Letters**

All letters guaranteed against knots and defects. Made of Washington State ponderosa pine. F.O.O. Items - allow 2 weeks for delivery.



<b>BHS#</b>	<b>DESCRIPTION</b>	<b>U/M</b>	<b>BOX</b>	<b>RETAIL</b>
256-130	BEAVERWD 'A' 8" PINE LETTER; FOO	ea	1	\$6.58
256-131	BEAVERWD 'B' 8" PINE LETTER; FOO	ea	1	\$6.58
256-132	BEAVERWD 'C' 8" PINE LETTER; FOO	ea	1	\$6.58
256-133	BEAVERWD 'D' 8" PINE LETTER; FOO	ea	1	\$6.58
256-134	BEAVERWD 'E' 8" PINE LETTER; FOO	ea	1	\$6.58
256-135	BEAVERWD 'F' 8" PINE LETTER; FOO	ea	1	\$6.58
256-136	BEAVERWD 'G' 8" PINE LETTER; FOO	ea	1	\$6.58
256-137	BEAVERWD 'H' 8" PINE LETTER; FOO	ea	1	\$6.58
256-138	BEAVERWD 'I' 8" PINE LETTER; FOO	ea	1	\$6.58
256-139	BEAVERWD 'J' 8" PINE LETTER; FOO	ea	1	\$6.58
256-140	BEAVERWD 'K' 8" PINE LETTER; FOO	ea	1	\$6.58
256-141	BEAVERWD 'L' 8" PINE LETTER; FOO	ea	1	\$6.58
256-142	BEAVERWD 'M' 8" PINE LETTER; FOO	ea	1	\$6.58
256-143	BEAVERWD 'N' 8" PINE LETTER; FOO	ea	1	\$6.58
256-144	BEAVERWD 'O' 8" PINE LETTER; FOO	ea	1	\$6.58
256-145	BEAVERWD 'P' 8" PINE LETTER; FOO	ea	1	\$6.58
256-146	BEAVERWD 'Q' 8" PINE LETTER; FOO	ea	1	\$6.58
256-147	BEAVERWD 'R' 8" PINE LETTER; FOO	ea	1	\$6.58
256-148	BEAVERWD 'S' 8" PINE LETTER; FOO	ea	1	\$6.58
256-149	BEAVERWD 'T' 8" PINE LETTER; FOO	ea	1	\$6.58
256-150	BEAVERWD 'U' 8" PINE LETTER; FOO	ea	1	\$6.58
256-151	BEAVERWD 'V' 8" PINE LETTER; FOO	ea	1	\$6.58
256-152	BEAVERWD 'W' 8" PINE LETTER; FOO	ea	1	\$6.58
256-153	BEAVERWD 'X' 8" PINE LETTER; FOO	ea	1	\$6.58
256-154	BEAVERWD 'Y' 8" PINE LETTER; FOO	ea	1	\$6.58
256-155	BEAVERWD 'Z' 8" PINE LETTER; FOO	ea	1	\$6.58

**8" Numbers**

All numbers guaranteed against knots and defects. Made of Washington State ponderosa pine. For Number 9, use Number 6 upside down. F.O.O. Items - allow 2 weeks for delivery.



<b>BHS#</b>	<b>DESCRIPTION</b>	<b>U/M</b>	<b>BOX</b>	<b>RETAIL</b>
256-160	BEAVERWD #0 8" PINE NUMBER; FOO	ea	1	\$6.58
256-161	BEAVERWD #1 8" PINE NUMBER; FOO	ea	1	\$6.58
256-162	BEAVERWD #2 8" PINE NUMBER; FOO	ea	1	\$6.58
256-163	BEAVERWD #3 8" PINE NUMBER; FOO	ea	1	\$6.58
256-164	BEAVERWD #4 8" PINE NUMBER; FOO	ea	1	\$6.58
256-165	BEAVERWD #5 8" PINE NUMBER; FOO	ea	1	\$6.58
256-166	BEAVERWD #6/#9 8" PINE NUMBER; FOO	ea	1	\$6.58
256-167	BEAVERWD #7 8" PINE NUMBER; FOO	ea	1	\$6.58
256-168	BEAVERWD #8 8" PINE NUMBER; FOO	ea	1	\$6.58

**HOUSE NUMBERS & LETTERS**

**MOUNTAIN HOME WOOD HOUSE NUMBERS AND LETTERS**

**12" Letters**

All letters guaranteed against knots and defects. Numbers and letters made of Washington State ponderosa pine. F.O.O. Items - allow 2 weeks for delivery.



<b>BHS#</b>	<b>DESCRIPTION</b>	<b>U/M</b>	<b>BOX</b>	<b>RETAIL</b>
256-171	BEAVERWD 'A' 12" PINE LETTER; FOO	ea	1	\$24.51
256-172	BEAVERWD 'B' 12" PINE LETTER; FOO	ea	1	\$24.51
256-173	BEAVERWD 'C' 12" PINE LETTER; FOO	ea	1	\$24.51
256-174	BEAVERWD 'D' 12" PINE LETTER; FOO	ea	1	\$24.51
256-175	BEAVERWD 'E' 12" PINE LETTER; FOO	ea	1	\$24.51
256-176	BEAVERWD 'F' 12" PINE LETTER; FOO	ea	1	\$24.51
256-177	BEAVERWD 'G' 12" PINE LETTER; FOO	ea	1	\$24.51
256-178	BEAVERWD 'H' 12" PINE LETTER; FOO	ea	1	\$24.51
256-179	BEAVERWD 'I' 12" PINE LETTER; FOO	ea	1	\$24.51
256-180	BEAVERWD 'J' 12" PINE LETTER; FOO	ea	1	\$24.51
256-181	BEAVERWD 'K' 12" PINE LETTER; FOO	ea	1	\$24.51
256-182	BEAVERWD 'L' 12" PINE LETTER; FOO	ea	1	\$24.51
256-183	BEAVERWD 'M' 12" PINE LETTER; FOO	ea	1	\$24.51
256-184	BEAVERWD 'N' 12" PINE LETTER; FOO	ea	1	\$24.51
256-185	BEAVERWD 'O' 12" PINE LETTER; FOO	ea	1	\$24.51
256-186	BEAVERWD 'P' 12" PINE LETTER; FOO	ea	1	\$24.51
256-187	BEAVERWD 'Q' 12" PINE LETTER; FOO	ea	1	\$24.51
256-188	BEAVERWD 'R' 12" PINE LETTER; FOO	ea	1	\$24.51
256-189	BEAVERWD 'S' 12" PINE LETTER; FOO	ea	1	\$24.51
256-190	BEAVERWD 'T' 12" PINE LETTER; FOO	ea	1	\$24.51
256-191	BEAVERWD 'U' 12" PINE LETTER; FOO	ea	1	\$24.51
256-192	BEAVERWD 'V' 12" PINE LETTER; FOO	ea	1	\$24.51
256-193	BEAVERWD 'W' 12" PINE LETTER; FOO	ea	1	\$24.51
256-194	BEAVERWD 'X' 12" PINE LETTER; FOO	ea	1	\$24.51
256-195	BEAVERWD 'Y' 12" PINE LETTER; FOO	ea	1	\$24.51
256-196	BEAVERWD 'Z' 12" PINE LETTER; FOO	ea	1	\$24.51

**12" Numbers**

All numbers guaranteed against knots and defects. Numbers and letters made of Washington State ponderosa pine. For Number 9, use Number 6 upside down. F.O.O. Items - allow 2 weeks for delivery.



<b>BHS#</b>	<b>DESCRIPTION</b>	<b>U/M</b>	<b>BOX</b>	<b>RETAIL</b>
256-200	BEAVERWD #0 12" PINE NUMBER; FOO	ea	1	\$24.51
256-201	BEAVERWD #1 12" PINE NUMBER; FOO	ea	1	\$24.51
256-202	BEAVERWD #2 12" PINE NUMBER; FOO	ea	1	\$24.51
256-203	BEAVERWD #3 12" PINE NUMBER; FOO	ea	1	\$24.51
256-204	BEAVERWD #4 12" PINE NUMBER; FOO	ea	1	\$24.51
256-205	BEAVERWD #5 12" PINE NUMBER; FOO	ea	1	\$24.51
256-206	BEAVERWD #6/#9 12" PINE NUMBER; FOO	ea	1	\$24.51
256-207	BEAVERWD #7 12" PINE NUMBER; FOO	ea	1	\$24.51
256-208	BEAVERWD #8 12" PINE NUMBER; FOO	ea	1	\$24.51

**TAYMOR HOUSE NUMBERS & LETTERS**

**3" Solid Brass Letters**

**Elegant Style**

Solid Brass. Non Rusting, Beautifully finished. Comes with screws. Factory Order Only. Packed 5 per Box. Weight 3/4 lb.

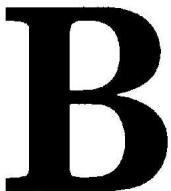

<b>BHS#</b>	<b>DESCRIPTION</b>	<b>U/M</b>	<b>BOX</b>	<b>RETAIL</b>
785-8600	TAYM 27-BL3 3" LETTER (SPECIFY);FOO	ea	1	\$9.24

**HOUSE NUMBERS & LETTERS**  
**TAYMOR HOUSE NUMBERS & LETTERS**

**4" Aluminum Numbers**

	<b>BHS#</b>	<b>DESCRIPTION</b>	<b>U/M</b>	<b>BOX</b>	<b>RETAIL</b>
	785-8300	TAYM 25-ANC40 4" ALUM NUMBER #0	ea	1	\$6.04
	785-8301	TAYM 25-ANC41 4" ALUM NUMBER #1	ea	1	\$6.04
	785-8302	TAYM 25-ANC42 4" ALUM NUMBER #2	ea	1	\$6.04
	785-8303	TAYM 25-ANC43 4" ALUM NUMBER #3	ea	1	\$6.04
	785-8304	TAYM 25-ANC44 4" ALUM NUMBER #4	ea	10	\$6.04
	785-8305	TAYM 25-ANC45 4" ALUM NUMBER #5	ea	1	\$6.04
	785-8306	TAYM 25-ANC46 4" ALUM NUMBER #6	ea	1	\$6.04
	785-8307	TAYM 25-ANC47 4" ALUM NUMBER #7	ea	1	\$6.04
	785-8308	TAYM 25-ANC48 4" ALUM NUMBER #8	ea	1	\$6.04
	785-8309	TAYM 25-ANC49 4" ALUM NUMBER #9	ea	1	\$6.04

**4" Black Numbers**

	<b>BHS#</b>	<b>DESCRIPTION</b>	<b>U/M</b>	<b>BOX</b>	<b>RETAIL</b>
	785-83100	TAYM 25-NZP40 4" BLACK ZC NUMBER #0	ea	1	\$.93
	785-83101	TAYM 25-NZP41 4" BLACK ZC NUMBER #1	ea	1	\$.93
	785-83102	TAYM 25-NZP42 4" BLACK ZC NUMBER #2	ea	1	\$.93
	785-83103	TAYM 25-NZP43 4" BLACK ZC NUMBER #3	ea	1	\$.93
	785-83104	TAYM 25-NZP44 4" BLACK ZC NUMBER #4	ea	1	\$.93
	785-83105	TAYM 25-NZP45 4" BLACK ZC NUMBER #5	ea	1	\$.93
	785-83106	TAYM 25-NZP46 4" BLACK ZC NUMBER #6	ea	1	\$.93
	785-83107	TAYM 25-NZP47 4" BLACK ZC NUMBER #7	ea	1	\$.93
	785-83108	TAYM 25-NZP48 4" BLACK ZC NUMBER #8	ea	1	\$.93
	785-83109	TAYM 25-NZP49 4" BLACK ZC NUMBER #9	ea	1	\$.93

**4" Solid Brass Numbers**

	<b>BHS#</b>	<b>DESCRIPTION</b>	<b>U/M</b>	<b>BOX</b>	<b>RETAIL</b>
		<b>Elegant Style</b>			
		Solid Brass. Non Rusting, Beautifully finished. Comes with screws. Factory Order Only. Packed 5 per Box. Weight 3/4 lb.			
	785-8500	TAYM 25-BN40 4" BRASS NUMBER #0	ea	1	\$4.34
		(replacing 27-BN40)			
	785-8510	TAYM 25-BN41 4" BRASS NUMBER #1	ea	1	\$4.34
		(replacing 27-BN41)			
	785-8520	TAYM 25-BN42 4" BRASS NUMBER #2	ea	1	\$4.34
		(replacing 27-BN42)			
	785-8530	TAYM 25-BN43 4" BRASS NUMBER #3	ea	1	\$4.34
		(replacing 27-BN43)			
785-8540	TAYM 25-BN44 4" BRASS NUMBER #4	ea	1	\$4.34	
	(replacing 27-BN44)				
785-8550	TAYM 25-BN45 4" BRASS NUMBER #5	ea	1	\$4.34	
	(replacing 27-BN45)				
785-8560	TAYM 25-BN46 4" BRASS NUMBER #6	ea	1	\$4.34	
	(replacing 27-BN46)				
785-8570	TAYM 25-BN47 4" BRASS NUMBER #7	ea	1	\$4.34	
	(replacing 27-BN47)				
785-8580	TAYM 25-BN48 4" BRASS NUMBER #8	ea	1	\$4.34	
	(replacing 27-BN48)				
785-8590	TAYM 25-BN49 4" BRASS NUMBER #9	ea	1	\$4.34	
	(replacing 27-BN49)				

**HOUSE NUMBERS & LETTERS**

**TAYMOR HOUSE NUMBERS & LETTERS**

**4" Solid Brass Numbers, Oil-Rubbed Bronze**



<i>BHS#</i>	<i>DESCRIPTION</i>	<i>U/M</i>	<i>BOX</i>	<i>RETAIL</i>
785-218958	TAYM 25-ORBN43 4" ORB NUMBER #3	ea	1	\$5.89
785-218957	TAYM 25-ORBN42 4" ORB NUMBER #2	ea	1	\$5.89
785-218961	TAYM 25-ORBN45 4" ORB NUMBER #5	ea	1	\$5.89
718-212376	TAYM 25-ORBN40 4" ORB NUMBER #0	ea	1	\$5.89
785-218964	TAYM 25-ORBN48 4" ORB NUMBER #8	ea	1	\$5.89
785-218965	TAYM 25-ORBN49 4" ORB NUMBER #9	ea	1	\$5.89
785-218962	TAYM 25-ORBN46 4" ORB NUMBER #6	ea	1	\$5.89
785-218960	TAYM 25-ORBN44 4" ORB NUMBER #4	ea	1	\$5.89
785-218963	TAYM 25-ORBN47 4" ORB NUMBER #7	ea	1	\$5.89
718-212377	TAYM 25-ORBN41 4" ORB NUMBER #1	ea	1	\$5.89

**4" Solid Brass Numbers, Satin Nickel Finish**



<i>BHS#</i>	<i>DESCRIPTION</i>	<i>U/M</i>	<i>BOX</i>	<i>RETAIL</i>
785-8480	TAYM 25-SN40 4" SAT.NICK NUMBER #0	ea	1	\$5.32
785-8486	TAYM 25-SN46 4" SAT.NICK NUMBER #6	ea	1	\$5.32
785-8487	TAYM 25-SN47 4" SAT.NICK NUMBER #7	ea	1	\$5.32
785-8488	TAYM 25-SN48 4" SAT.NICK NUMBER #8	ea	1	\$5.32
785-8489	TAYM 25-SN49 4" SAT.NICK NUMBER #9	ea	1	\$5.32
785-8481	TAYM 25-SN41 4" SAT.NICK NUMBER #1	ea	1	\$5.32
785-8482	TAYM 25-SN42 4" SAT.NICK NUMBER #2	ea	1	\$5.32
785-8483	TAYM 25-SN43 4" SAT.NICK NUMBER #3	ea	1	\$5.32
785-8485	TAYM 25-SN45 4" SAT.NICK NUMBER #5	ea	1	\$5.32
785-8484	TAYM 25-SN44 4" SAT.NICK NUMBER #4	ea	1	\$5.32

**6" Solid Brass Letters**

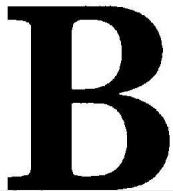

**Elegant Style**

Solid Brass. Non Rusting, Beautifully finished. Comes with screws. Factory Order Only. Packed 5 per Box. Weight 3/4 lb.

<i>BHS#</i>	<i>DESCRIPTION</i>	<i>U/M</i>	<i>BOX</i>	<i>RETAIL</i>
785-8610	TAYM 27-BL6 6" LETTER (SPECIFY);FOO	ea	1	\$19.39

**6" Satin Nickel Numbers**



<i>BHS#</i>	<i>DESCRIPTION</i>	<i>U/M</i>	<i>BOX</i>	<i>RETAIL</i>
785-85900	TAYM 25-SN60 6" SAT.NICK NUMBER #0	ea	1	\$8.73
785-85901	TAYM 25-SN61 6" SAT.NICK NUMBER #1	ea	1	\$8.73
785-85902	TAYM 25-SN62 6" SAT.NICK NUMBER #2	ea	1	\$8.73
785-85903	TAYM 25-SN63 6" SAT.NICK NUMBER #3	ea	1	\$8.73
785-85904	TAYM 25-SN64 6" SAT.NICK NUMBER #4	ea	1	\$8.73
785-85905	TAYM 25-SN65 6" SAT.NICK NUMBER #5	ea	1	\$8.73
785-85906	TAYM 25-SN66 6" SAT.NICK NUMBER #6	ea	1	\$8.73
785-85907	TAYM 25-SN67 6" SAT.NICK NUMBER #7	ea	1	\$8.73
785-85908	TAYM 25-SN68 6" SAT.NICK NUMBER #8	ea	1	\$8.73
785-85909	TAYM 25-SN69 6" SAT.NICK NUMBER #9	ea	1	\$8.73

**HOUSE NUMBERS & LETTERS**

**TAYMOR HOUSE NUMBERS & LETTERS**

**6" Solid Brass Numbers**



<i>BHS#</i>	<i>DESCRIPTION</i>	<i>U/M</i>	<i>BOX</i>	<i>RETAIL</i>
785-66964	TAYM 25-BN60 6" BRASS NUMBER #0 *K (replacing 27-BN60)	ea	1	\$8.73
785-66965	TAYM 25-BN61 6" BRASS NUMBER #1 *K (replacing 27-BN61)	ea	1	\$8.73
785-66966	TAYM 25-BN62 6" BRASS NUMBER #2 *K (replacing 27-BN62)	ea	1	\$8.73
785-66967	TAYM 25-BN63 6" BRASS NUMBER #3 *K (replacing 27-BN63)	ea	1	\$8.73
785-66968	TAYM 25-BN64 6" BRASS NUMBER #4 *K (replacing 27-BN64)	ea	1	\$8.73
785-66969	TAYM 25-BN65 6" BRASS NUMBER #5 *K (replacing 27-BN65)	ea	1	\$8.73
785-66972	TAYM 25-BN66 6" BRASS NUMBER #6 *K (replacing 27-BN66)	ea	1	\$8.73
785-66973	TAYM 25-BN67 6" BRASS NUMBER #7 *K (replacing 27-BN67)	ea	1	\$8.73
785-66974	TAYM 25-BN68 6" BRASS NUMBER #8 *K (replacing 27-BN68)	ea	1	\$8.73
785-66975	TAYM 25-BN69 6" BRASS NUMBER #9 *K (replacing 27-BN69)	ea	1	\$8.73
785-212389	TAYM 25-ORBN60 6" ORB NUMBER #0 *K	ea	1	\$9.89
785-212390	TAYM 25-ORBN61 6" ORB NUMBER #1 *K	ea	1	\$9.89
785-214638	TAYM 25-ORBN62 6" ORB NUMBER #2 *K	ea	1	\$9.89
785-214645	TAYM 25-ORBN63 6" ORB NUMBER #3 *K	ea	1	\$9.89
785-214651	TAYM 25-ORBN64 6" ORB NUMBER #4 *K	ea	1	\$9.89
785-214652	TAYM 25-ORBN65 6" ORB NUMBER #5 *K	ea	1	\$9.89
785-214653	TAYM 25-ORBN66 6" ORB NUMBER #6 *K	ea	1	\$9.89
785-212391	TAYM 25-ORBN67 6" ORB NUMBER #7 *K	ea	1	\$9.89
785-214654	TAYM 25-ORBN68 6" ORB NUMBER #8 *K	ea	1	\$9.89
785-214655	TAYM 25-ORBN69 6" ORB NUMBER #9 *K	ea	1	\$9.89

**MAIL BOXES, APARTMENT**

**BOMMER APARTMENT HOUSE MAIL BOXES**

**US28 Natural Anodized Aluminum**



Each mailbox consists of 3 to 7 compartments enclosed within a wall box. The wall box and compartments are constructed of heavy guage galvanized and chromated steel providing both durability and resistance to rust. Access for loading is gained by unlocking a U.S.P.D. control lock and pivoting the compartments forward.  
 Compartment size: 15" high x 5" wide x 6" deep. Door Lock: 5-pin cam type with 2 keys. Door Identification: Name and number slots in door with card holder.

<i>BHS#</i>	<i>DESCRIPTION</i>	<i>U/M</i>	<i>BOX</i>	<i>RETAIL</i>
044-1650	BOM 9040-3 GANG 628 MAILBOXES	ea	1	\$158.46
044-1660	BOM 9040-4 GANG 628 MAILBOXES	ea	1	\$205.79
044-1670	BOM 9040-5 GANG 628 MAILBOXES	ea	1	\$253.33
044-1680	BOM 9040-6 GANG 628 MAILBOXES	ea	1	\$301.00
044-1690	BOM 9040-7 GANG 628 MAILBOXES	ea	1	\$348.54

**US28 Natural Anodized Aluminum Collars**

**VERTICAL MAILBOX COLLARS (For Mounting 9000 Series)**



MODEL 9341

Mounting frames are designed to permit mounting of standard mailbox units in locations where recessed mounting is not practical. Each mounting frame accommodates a single mailbox unit having 3 to 7 compartments. Aluminum full surface (mailbox projects 6 3/4").

<i>BHS#</i>	<i>DESCRIPTION</i>	<i>U/M</i>	<i>BOX</i>	<i>RETAIL</i>
044-1770	BOM 9341-3 GANG 628 FULL SUR FRAME	ea	1	\$49.73
044-1780	BOM 9341-4 GANG 628 FULL SUR FRAME	ea	1	\$56.11
044-1790	BOM 9341-5 GANG 628 FULL SUR FRAME	ea	1	\$62.65
044-1800	BOM 9341-6 GANG 628 FULL SUR FRAME	ea	1	\$69.11
044-1810	BOM 9341-7 GANG 628 FULL SUR FRAME; FOO	ea	1	\$75.57

**MAIL BOXES, APARTMENT**

**BOMMER APARTMENT HOUSE MAIL BOXES**

**US28 Natural Anodized Aluminum Semi-recess Collars**



MODEL 9343

Aluminum semi-recess (4" wall depth required - mailbox projects 3").

BHS#	DESCRIPTION	U/M	BOX	RETAIL
044-1890	BOM 9343-5 GANG 988 SEMI-REC FRAME; FOO; replacing 688 finish	ea	1	\$49.64

**US28G Gold Anodized Aluminum**



Each mailbox consists of 3 to 7 compartments enclosed within a wall box. The wall box and compartments are constructed of heavy gauge galvanized and chromated steel providing both durability and resistance to rust. Access for loading is gained by unlocking a U.S.P.D. control lock and pivoting the compartments forward.

Compartment size: 15" high x 5" wide x 6" deep. Door Lock: 5-pin cam type with 2 keys. Door Identification: Name and number slots in door with card holder.

BHS#	DESCRIPTION	U/M	BOX	RETAIL
044-1710	BOM 9040-3 GANG 988 MAILBOXES; FOO replacing 688 finish	ea	1	\$190.08
044-1720	BOM 9040-4 GANG 988 MAILBOXES; replacing 688 finish	ea	1	\$246.94
044-1730	BOM 9040-5 GANG 988 MAILBOXES. replacing 688 finish	ea	1	\$303.99
044-1740	BOM 9040-6 GANG 988 MAILBOXES; replacing 688 finish	ea	1	\$361.19
044-1750	BOM 9040-7 GANG 988 MAILBOXES; replacing 688 finish	ea	1	\$418.18

**US28G Gold Anodized Aluminum Collars**



MODEL 9341

Aluminum full surface (mailbox projects 6 3/4").

BHS#	DESCRIPTION	U/M	BOX	RETAIL
044-1830	BOM 9341-3 GANG 988 FULL SUR FRAME; FOO; replacing 688 finish	ea	1	\$59.59
044-1840	BOM 9341-4 GANG 988 FULL SUR FRAME; replacing 688 finish; FOO	ea	1	\$67.41
044-1850	BOM 9341-5 GANG 988 FULL SUR FRAME; replacing 688 finish; FOO	ea	1	\$75.23
044-1860	BOM 9341-6 GANG 988 FULL SUR FRAME; replacing 688 finish; FOO	ea	1	\$83.05
044-1870	BOM 9341-7 GANG 988 FULL SUR FRAME; FOO; replacing 688 finish	ea	1	\$90.70

**Lock or Cylinder**



670-07



25301

BHS#	DESCRIPTION	U/M	BOX	RETAIL
044-1910	BOM 25300 MAILBOX LOCK; was 25301	ea	1	\$14.60
044-1920	BOM 670-07 MAILBOX LOCK	ea	1	\$14.60

**N/A**



DESCRIPTION	U/M	BOX	RETAIL
BOMMER*MAILBOX INFORMATION FOR CATALOG USE ONLY	ea	1	\$ .00

**KEY BLANKS, BOMMER**

**HUDSON KEY BLANKS FOR BOMMER MAILBOXES**



For use with Bommer mailboxes.

BHS#	DESCRIPTION	U/M	BOX	RETAIL
185-2000	HUDSON H20 5-PIN KEY BLANK	ea	50	\$1.86
185-2010	HUDSON H21 5-PIN KEY BLANK	ea	50	\$1.86

**MAIL BOXES**

**ARCHITECTURAL MAIL BOXES**

**Metropolis**



The robust Metropolis is constructed of stainless steel for unparalleled resistance to the elements. The incoming slot is perfect for residents receiving larger items, such as magazines and bank check boxes. The storage compartment is wide and deep and is protected by a durable stainless steel cam lock with dust shutter. Each Metropolis mailbox includes mounting hardware, instructions and two mail compartment keys.

BHS#	DESCRIPTION	U/M	BOX	RETAIL
482-127798	ARCHMAIL 2407PS METROPOLIS MAILBOX ***NonReturnable***	ea	1	\$163.20

**Soho**



The stylish Soho is constructed of galvanized steel finished with a durable powder coat inside and out for long lasting resistance against all types of weather elements. The incoming slot is perfect for residents receiving larger items, such as magazines and bank check boxes. The storage compartment is wide and deep and is protected by a durable stainless steel cam lock with dust shutter. Each Soho mailbox includes mounting hardware, instructions and two mail compartment keys.

BHS#	DESCRIPTION	U/M	BOX	RETAIL
482-147626	ARCHMAIL 2480S SAND SOHO MAIL BOX ***NonReturnable***	ea	1	\$109.14
482-155861	ARCHMAIL 2480Z BRONZE SOHO MAIL BOX ***NonReturnable***	ea	1	\$109.14
482-178015	ARCHMAIL 2480B BLACK SOHO MAIL BOX ***NonReturnable***	ea	1	\$109.14

**FULTON MAIL BOXES**

**Ranch Models 16" Wide**

Satin Black, 16" W x 9" H x 3 1/2" D.



BHS#	DESCRIPTION	U/M	BOX	RETAIL
775-190699	SOLAR E1100B00 BLACK MAILBOX; E11B **Add Freight Charge separately**	ea	1	\$24.57
775-190562	SOLAR PBK00000 BLACK POST FOR MAILBOX; PBK **Add Freight Charge separately**	ea	1	\$29.06
120-90	FULTON 700 MAILBOX: FOO	ea	1	\$35.40

**Ranch Models 10-1/2" Wide**

Contemporary Satin Black, 10 1/2" W x 5 H x 2 1/2" D.



BHS#	DESCRIPTION	U/M	BOX	RETAIL
120-200	FULTON 2000 MAILBOX; replaces 200SH FOO	ea	1	\$14.44

**Upright Models**

Satin Black with security hasp. 5 1/2" W x 10 1/2" H x 2" D.



BHS#	DESCRIPTION	U/M	BOX	RETAIL
120-10	FULTON 15W MAILBOX	ea	1	\$12.70

**MAIL BOXES**

**SALSBURY HOME MAIL BOXES**

**Black Vertical Mailbox**



<i>BHS#</i>	<i>DESCRIPTION</i>	<i>U/M</i>	<i>BOX</i>	<i>RETAIL</i>
313-171161	SALSBURY 4620BLK BLACK VERT. MAILBX	ea	1	\$74.88

**Security Kit for 4510 Vertical**



<i>BHS#</i>	<i>DESCRIPTION</i>	<i>U/M</i>	<i>BOX</i>	<i>RETAIL</i>
313-171941	SALSBURY 4511 SECURITY KIT-OPTION	ea	1	\$24.96

**Stainless Steel Horizontal Mailbox**



<i>BHS#</i>	<i>DESCRIPTION</i>	<i>U/M</i>	<i>BOX</i>	<i>RETAIL</i>
313-144840	SALSBURY 4510 SS HORIZONTAL MAILBOX	ea	1	\$99.84

**Security Kit for 4620 Horizontal**



<i>BHS#</i>	<i>DESCRIPTION</i>	<i>U/M</i>	<i>BOX</i>	<i>RETAIL</i>
313-205233	SALSBURY 4621 SECURITY KIT OPTION	ea	1	\$24.96

**MAIL SLOTS**

**BALDWIN MAIL SLOTS**

**Letter Box/Mail Slot Sleeve**



Made of stainless steel for 1 3/4" doors. Rough opening dimensions 11.375" L x 2.75" W x 1.6875" D. Fits letter box plates 0012 and 0013.

<i>BHS#</i>	<i>DESCRIPTION</i>	<i>U/M</i>	<i>BOX</i>	<i>RETAIL</i>
032-70	BALDW 0052.324 SLEEVE FOR LETTER BX	ea	1	\$36.00

**Mail Plate - Standard Backplate**

Made of heavy gauge wrought brass, bronze and aluminum. Front flap is augmented by bronze spring to ensure tight closed position. Can be installed horizontally or vertically. Conforms to Post Office specifications. Finished opening size 11" x 2" will accommodate large magazines without folding. Overall size: 13" x 3.625". Attachment by wood screws both sides.



<i>BHS#</i>	<i>DESCRIPTION</i>	<i>U/M</i>	<i>BOX</i>	<i>RETAIL</i>
032-8	BALDW 0012.003 LETTER BOX PLATE	ea	5	\$89.00
032-13	BALDW 0012.102 LETTER BOX PLATE	ea	1	\$75.00
032-101	BALDW 0012.112 LETTER BOX PLATE	ea	5	\$75.00
032-12	BALDW 0012.150 LETTER BOX PLATE	ea	1	\$75.00
032-14	BALDW 0012.264 LETTER BOX PLATE	ea	1	\$75.00

**LAWRENCE (ULTRA) MAIL SLOT**

N/A

Satin Brass finish in poly bag. 10 3/4" W x 3 7/16" H overall. 8" W x 1 1/2" H opening.



<i>BHS#</i>	<i>DESCRIPTION</i>	<i>U/M</i>	<i>BOX</i>	<i>RETAIL</i>
206-203506	LAWR 67100 BRASS PLATED MAIL SLOT (ULTRA)	ea	10	\$16.60



**MAIL SLOTS**

**IVES MAIL SLOTS**

Magazine Size, Overall Size: 13" x 3-9/16"



Weather-Tite interlocking feature. Rugged construction IVES exclusive interlocking flap and frame of heavy wrought stock gives complete weather protection. Bronze spring augments gravity to ensure tightly closed position and makes vertical installation possible. Finish: Bright Solid Brass.

BHS#	DESCRIPTION	U/M	BOX	RETAIL
174-1831	IVES 620B 3 MAIL SLOT PLATE	ea	1	\$62.90

**SCHLAGE MAIL SLOTS**

Letter Box/Mail Slot Sleeve



BHS#	DESCRIPTION	U/M	BOX	RETAIL
	SCH SC 601 STAINLESS STEEL SLEEVE	cd	2	\$15.75

Magazine Size, Overall Size: 13" X 3-9/16"



BHS#	DESCRIPTION	U/M	BOX	RETAIL
174-173386	SCH SC 620B 605 MAIL SLOT; US3	cd	2	\$64.80
174-173390	SCH SC 620B 716 MAIL SLOT	cd	2	\$79.60
174-173388	SCH SC 620B 619 MAIL SLOT	cd	2	\$79.60

**HANDRAIL BRACKETS**

**ACORN HANDRAIL BRACKET**



Made from strong and durable cast iron, this handrail bracket has a simple design meant to enhance the look of your stairway.

BHS#	DESCRIPTION	U/M	BOX	RETAIL
004-50	ACORN ACABG WALL RAIL BRACKET	ea	1	\$26.99

**BULLDOG HANDRAIL BRACKETS**

3506121463 Handrail Bracket

BHS#	DESCRIPTION	U/M	BOX	RETAIL
058-159514	BULLDOG 3506121463 US3 HANDRAIL BRACKET (1-pk) DHH-275	ea	6	\$5.51

No Illustration Available

3506121473 Handrail Bracket

BHS#	DESCRIPTION	U/M	BOX	RETAIL
058-159515	BULLDOG 3506121473 WH HANDRAIL BRACKET (1-pk) DHH-277	ea	6	\$5.51

No Illustration Available

3506111523T Handrail Bracket

BHS#	DESCRIPTION	U/M	BOX	RETAIL
058-163210	BULLDOG 3506111523T US3 HANDRAIL BRACKET (1-pk) DHH-240	ea	6	\$3.50

No Illustration Available

**HANDRAIL BRACKETS**

**CAL-ROYAL HAND RAIL BRACKETS**

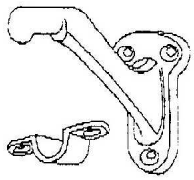

Heavy-duty handrail bracket.

BHS#	DESCRIPTION	U/M	BOX	RETAIL
526-700	CAL-ROY HDHB40 US15 HANDRAIL BRKT	ea	50	\$2.77
526-705	CAL-ROY HDHB40 US15A HANDRAIL BRKT	ea	50	\$2.77

**DELTA NA HANDRAIL BRACKETS**

**Solid Brass, Round Base**



BHS#	DESCRIPTION	U/M	BOX	RETAIL
546-158227	DELTA NA HRC175U15 HANDRAIL BRACKET	ea	5	\$18.80
546-153759	DELTA NA HRC175U10B HANDRAIL BRACKET	ea	5	\$18.80

**Solid Brass**



BHS#	DESCRIPTION	U/M	BOX	RETAIL
546-100997	DELTA NA HRB325U15 HANDRAIL BRACKET	ea	10	\$16.80
546-105494	DELTA NA HRB325U10B HANDRAIL BRACKET	ea	10	\$16.80

**Zinc**



BHS#	DESCRIPTION	U/M	BOX	RETAIL
546-201812	DELTA NA ZHRBB325U3 HANDRAIL BRKT ZINC	ea	50	\$5.50
546-201813	DELTA NA ZHRBB325U5 HANDRAIL BRKT ZINC	ea	50	\$5.50
546-201808	DELTA NA ZHRBB325U15 HANDRAIL BRKT ZINC	ea	50	\$5.50
546-201809	DELTA NA ZHRBB325U15A HANDRAIL BRKT ZINC	ea	50	\$5.50
546-201807	DELTA NA ZHRBB325U10B HANDRAIL BRKT ZINC	ea	50	\$5.50
546-201810	DELTA NA ZHRBB325U26 HANDRAIL BRKT ZINC	ea	50	\$5.50
546-201811	DELTA NA ZHRBB325U26D HANDRAIL BRKT ZINC	ea	50	\$5.50

**IVES HAND RAIL BRACKETS**

**"BP" Pack - Individually poly-bagged w/screws**

Sold in Full Box Quantities Only. Cast aluminum burnished. Base 2 1/4" x 1 3/8". Base to center or rail 2 7/16". Individually poly-bagged with screws.



BHS#	DESCRIPTION	U/M	BOX	RETAIL
174-2008	IVES BP 059A 10 HANDRAIL BRKT (75) Sold in FULL BOX QTY (75) only. FOO	ea	75	\$2.90

**Slim-Pack**

Base: 2-1/4" H x 1-3/8" W; Base to Center of Rail: 2-7/16"



BHS#	DESCRIPTION	U/M	BOX	RETAIL
174-432	IVES SP 059A 3 HANDRAIL BRACKET	ea	20	\$2.90
174-434	IVES SP 059A 5 HANDRAIL BRACKET	ea	20	\$2.90
174-438	IVES SP 059A 14 HANDRAIL BRACKET	ea	20	\$2.90
174-440	IVES SP 059A 92 HANDRAIL BRACKET	ea	20	\$2.90

**HANDRAIL BRACKETS**

**IVES HAND RAIL BRACKETS**

**Box-Pack**



BHS#	DESCRIPTION	U/M	BOX	RETAIL
174-391	IVES 059A 10B HANDRAIL BRACKET	ea	20	\$2.90

**Box Pack - Solid Brass**

Solid Brass. Base 2 1/4" x 1 3/8". Base to center or rail 2 7/16". Individually poly-bagged with screws.



BHS#	DESCRIPTION	U/M	BOX	RETAIL
174-395	IVES 059B 3 HANDRAIL BRACKET	ea	10	\$16.30
174-392	IVES 059B 10B HANDRAIL BRACKET	ea	10	\$18.70
174-393	IVES 059B 15 HANDRAIL BRACKET	ea	10	\$18.70
174-394	IVES 059B 15A HANDRAIL BRACKET	ea	10	\$18.70
174-396	IVES 059B 716 HANDRAIL BRACKET	ea	10	\$18.70

**SCHLAGE HAND RAIL BRACKETS**

**Carded, Solid Brass**



BHS#	DESCRIPTION	U/M	BOX	RETAIL
174-173278	SCH SC 059B 605 HANDRAIL BRACKET	cd	5	\$16.80
174-173280	SCH SC 059B 619 HANDRAIL BRACKET	cd	5	\$19.30
174-173282	SCH SC 059B 716 HANDRAIL BRACKET	cd	5	\$19.30

**IVES HAND RAIL BRACKETS**

**Box Pack**



BHS#	DESCRIPTION	U/M	BOX	RETAIL
174-436	IVES 059A 10 HANDRAIL BRACKET	ea	20	\$2.90

**Box Pack - Aluminum**



BHS#	DESCRIPTION	U/M	BOX	RETAIL
174-420	IVES 59A 716 HANDRAIL BRACKET	ea	10	\$3.60

**Slim Pack - Aluminum**

Base: 2-13/16" H x 1-1/2" W; Base to Center of Rail: 2-3/4"



BHS#	DESCRIPTION	U/M	BOX	RETAIL
174-422	IVES SP 59A 3 HANDRAIL BRACKET	ea	15	\$3.00
174-424	IVES SP 59A 5 HANDRAIL BRACKET	ea	15	\$3.60
174-426	IVES SP 59A 10 HANDRAIL BRACKET	ea	15	\$3.00
174-428	IVES SP 59A 92 HANDRAIL BRACKET	ea	15	\$3.00

**Box Pack - Cast Brass**

Cast brass. Base 2 13/16" x 1 1/2". Base to center of rail 2 3/4". Individually poly-bagged with screws. Conforms to Fed. Spec. 1064AL. (Available in cast brass or bronze for Fed. Spec. 1064B - F.O.O.)



BHS#	DESCRIPTION	U/M	BOX	RETAIL
174-430	IVES 59MB 3 HANDRAIL BRACKET	ea	10	\$17.30
174-431	IVES 59MB 5 HANDRAIL BRACKET	ea	10	\$19.90
174-425	IVES 59MB 15 HANDRAIL BRACKET	ea	10	\$19.90
174-427	IVES 59MB 15A HANDRAIL BRACKET	ea	10	\$23.90
174-433	IVES 59MB 716 HANDRAIL BRACKET	ea	10	\$19.90

**HANDRAIL BRACKETS**

**IVES HAND RAIL BRACKETS**

159A

Cast aluminum. Diameter of base 3". Base to center of rail 3 1/8". Packed with 1/2" x 4" square head iron lag screw and expansion shield. Conforms to Fed. Spec. 1065B - AL. (Also available in cast brass Fed. Spec. 1065B - F.O.O.)



BHS#	DESCRIPTION	U/M	BOX	RETAIL
174-952	IVES HB159 3AL HANDRAIL BRACKET; was 159A 3 (ALUM)	ea	5	\$13.20
174-956	IVES HB159 27AL HANDRAIL BRACKET; was 159A 92	ea	5	\$13.20

**STANLEY HAND RAIL BRACKETS**

Aluminum Die Cast

Aluminum die cast - Bright Brass or Antique Brass finish, with screws. For use to support handrails at any angle of stairway. Strong design with added strength provided by hardened steel screws. Polished brass finish retains luster with easy to care for instructions.

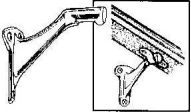

BHS#	DESCRIPTION	U/M	BOX	RETAIL
332-3994	STAN CD7081 US3 HANDRAIL BRK 756055	cd	5	\$5.22
332-3993	STAN CD7081 F8 HANDRAIL BRKT 756054	cd	5	\$5.46

**STANLEY H.D. HANDRAIL BRACKETS**

Supports wooden handrails at any angle of stairway Especially designed to support heavy railings Base material: Zinc die cast



BHS#	DESCRIPTION	U/M	BOX	RETAIL
332-4029	STAN CD7094 US3 HD HANDRAIL BRACKET 756051	cd	5	\$5.77

**TAYMOR HANDRAIL BRACKETS**

Individually poly-bagged. Complete with screws. Projection from wall is 3".

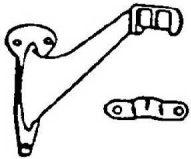

BHS#	DESCRIPTION	U/M	BOX	RETAIL
785-8375	TAYM 25-6370SN SN HANDRAIL BRKT	ea	1	\$7.98
785-8370	TAYM 25-6370ORB ORB HANDRAIL BRKT *T	ea	1	\$7.98
785-8360	TAYM 25-B6350B US3 HANDRAIL BRKT	ea	1	\$1.95
785-8358	TAYM 25-B6350AB US5 HANDRAIL BRKT	ea	1	\$1.95
785-8364	TAYM 25-B6350ORB 10B HANDRAIL BRK	ea	1	\$2.32
785-8361	TAYM 25-B6350N US14 HANDRAIL BRKT	ea	1	\$1.95
785-8363	TAYM 25-B6350SN US15 HANDRAIL BRKT	ea	1	\$2.32
785-8359	TAYM 25-B6350AN 15A HANDRAIL BRKT	ea	1	\$2.32
785-8362	TAYM 25-B6350SC 26D HANDRAIL BRKT	ea	1	\$2.32

**JULIUS BLUM HANDRAIL BRACKETS**

Available as Special Order

**Julius Blum Handrail Brackets**

SPECIAL CONDITION HANDRAIL BRACKETS AVAILABLE, CONTACT US FOR DELIVERY AND PRICE INFORMATION.

Wall brackets for pipe railing shown here.

Screws are not included. Screws must be ordered in lots of 100. Handrails can be ordered in any quantity.

		a	b	c
376	Aluminum	2 1/2"	3 1/8"	1 9/16"
376A	Aluminum	2 1/2"	3 1/8"	1 9/16"
375	Bronze	2 1/2"	3 1/8"	1 9/16"
319	Bronze	3 1/8"	3 3/4"	1 7/8"
176	Nickel-Silver	2 1/2"	3 1/8"	1 9/16"
275	Stainless	2 1/2"	3 1/8"	1 9/16"
378	Malleable Iron	2 1/2"	3 1/8"	1 9/16"

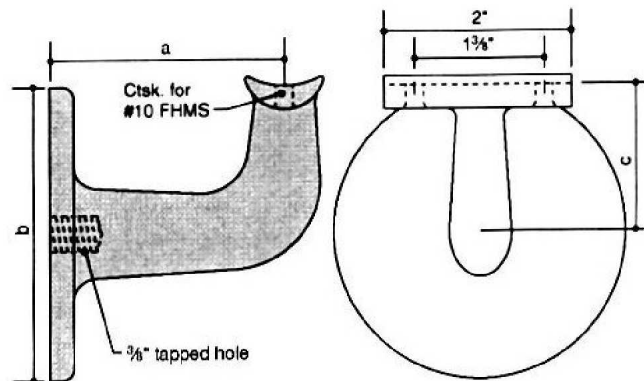

**FLAP HINGE**

**GRASS FLAP HINGE**

N/A



90° opening. Detachable for separate mounting on flap and shelf. Bottom and flap door are flush inside the cabinet when doors are open. For flap thicknesses up to 3/4in.(20mm). Identical drilling pattern for base and flap door. Features 3-dimensional adjustment and sturdy design. Includes screws.

BHS#	DESCRIPTION	U/M	BOX	RETAIL
605-5436	GRASS 210.735.04.0015 FLAP HNG;FOO	ea	100	\$11.46
	605-5436 (MEPLA)			

**FLAP STAYS**

**SELBY FLAP STAYS WITH BRAKING ACTION**

200mm

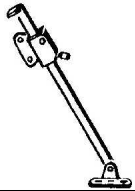

Unique braking action. Infinitely adjustable using miniature nylon cylinders to correct for all flap weights. Cannot jam or slam. Not affected by temperature changes. All functions on 32mm system. For vertical or horizontal application. Chromed steel bar & nylon parts in brown. Paired, lefts & rights. For flaps up to 13 - 15" height.

BHS#	DESCRIPTION	U/M	BOX	RETAIL
314-180	SELBY SI8425/AB-B FLAP STAY LH/RH 7-13/16"	pr	2	\$24.77

300mm

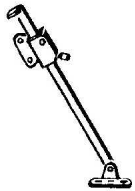

For flaps up to 13 - 15" height. See 200mm Stay Flaps above for full description.

BHS#	DESCRIPTION	U/M	BOX	RETAIL
314-190	SELBY SI8440/AB-B FLAP STAY LH/RH 11-7/16"	pr	2	\$24.77

**LID SUPPORTS**

**BRAINERD LID SUPPORTS**

1085XC

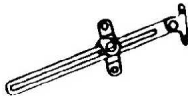

Brass plated steel. Adjustable holding action. 1 per card with screws. Handed.

BHS#	DESCRIPTION	U/M	BOX	RETAIL
054-565	BRAIN L1085XC BP LID SUPPORT	cd	10	\$2.96
054-566	BRAIN R1085XC BP LID SUPPORT	cd	10	\$2.96

1086XC

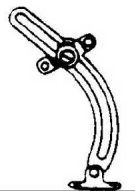

Brass plated steel. One per card. Handed.

BHS#	DESCRIPTION	U/M	BOX	RETAIL
054-570	BRAIN L1086XC BP LID SUPPORT	cd	10	\$3.75
054-571	BRAIN R1086XC BP LID SUPPORT; FDWO	cd	10	\$3.75

1088XC and 1089XC



Carded. Allows smooth and easy opening and closing of lids, yet provides protection against slamming. Order center support (1088XC) or left or right support (L1089XC or R1089XC).

BHS#	DESCRIPTION	U/M	BOX	RETAIL
054-580	BRAIN 1088XC AB LID SUPPORT; FDWO	cd	10	\$4.78
054-585	BRAIN L1089XC AB LID SUPPORT; FDWO	cd	10	\$5.27
054-586	BRAIN R1089XC AB LID SUPPORT	cd	10	\$5.27

**LID SUPPORTS**

**KNAPE & VOGT STEEL SUPPORT HINGE**

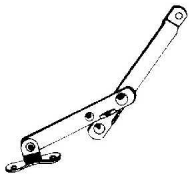

Left and right handed. Measured open 6" or 10". (Specify size when ordering). Anochrome finished steel. Packed by the pair.

BHS#	DESCRIPTION	U/M	BOX	RETAIL
194-957	KV 472 ANO 6" LID SUPPORT L&RH	ea	12	\$7.01
194-958	KV 472 ANO 10" LID SUPPORT L/R	ea	12	\$7.44

**SELBY LID SUPPORTS**

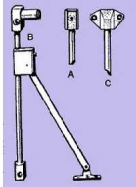

**Adjustable Braking Action**

Delivered pre-set to brake a 10 lb. lid. Chromed steel rod and bar with nylon slider-control and nylon ends, black, white or brown. Paired, lefts and rights. For vertical and horizontal use. Hole distance in units of 32 mm. Mounting Height: 288 mm (11 5/16"), Flap Height (Vertical): 16 - 19", Case Depth (Horizontal): 13" - 16".

BHS#	DESCRIPTION	U/M	BOX	RETAIL
314-87622	SELBY SX8528-A BLACK STAYS LH/RH*pr	pr	25	\$48.53

**STANLEY LID SUPPORTS**

**Folding Lid Support, 1/2 Pair**



For use on lids of desks and cabinets. Reversible. Bright brass plated. Carded: 1/2 pair (1 each) per visual pack with screws. F.O.O. Items - Full Box Only - Allow 2 weeks.

BHS#	DESCRIPTION	U/M	BOX	RETAIL
332-1962	STAN CD430 US3 7-1/2" SUPPT 801525	cd	10	\$4.41

**Folding Lid Support, 1 Pair**



For use on lids of desks and cabinets. Non-reversible. Carded. Steel, brass plated.

BHS#	DESCRIPTION	U/M	BOX	RETAIL
332-1982	STAN CD432 US3 SUPPORT 801535;2/CD	cd	10	\$9.01

**Friction Lid Support, 1/2 Pair per Card**

Use on storage containers where holding lid in open position is desired. May be used on toy chests, tool boxes and other furniture items.



BHS#	DESCRIPTION	U/M	BOX	RETAIL
332-2005	STAN CD444 US3 LH FRICTION LID SUPPORT 800446; 1/cd	cd	5	\$5.06
332-2006	STAN CD444 US3 RH FRICTION LID SUPPORT 800445; 1/cd	cd	5	\$5.06

**Safety Lid Support, Center Mounting**

For use on storage containers where holding lid in open position is desired. May be used on toy chests, tool boxes, and other furniture items. For center mounting applications only.



BHS#	DESCRIPTION	U/M	BOX	RETAIL
332-2020	STAN CD447 F8 SAFETY LID SUPPORT 800447; 1/cd	cd	5	\$6.58

**Safety Lid Support, 1/2 Pair per Card**

For use on storage containers where holding lid in open position is desired. May be used on toy chests, tool boxes, and other furniture items. For side mounting applications only.



BHS#	DESCRIPTION	U/M	BOX	RETAIL
332-2021	STAN CD448 F8 RH SAFETY LID SUPPORT 800448; 1/cd	cd	5	\$6.58
332-2022	STAN CD449 F8 LH SAFETY LID SUPPORT 800449; 1/cd	cd	5	\$6.58

**TABLE BRACE**

**STANLEY DROP LEAF TABLE BRACE**

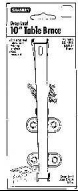

Steel, brown lacquer finish. Brace is ideal for drop leaves of tables or for folding shelves. Correctly applied, "jackknifing" of brace is prevented as leaf is held securely in place by spring tension. Spring also holds leaf in dropped position. Can be used with regular hinges or, with No. 810 drop leaf hinges.

BHS#	DESCRIPTION	U/M	BOX	RETAIL
332-33534	STAN 1956 US1D 10" LEAF SUPP. 497840	ea	2	\$12.75
332-33536	STAN CD1956 US1D 10" LEAFSUP 730550	cd	5	\$12.48

**TABLE HINGES, DROP LEAF**

**HAFELE DROP LEAF TABLE HINGE**



BHS#	DESCRIPTION	U/M	BOX	RETAIL
141-193393	HAFELE 642.70.515 DROP LEAF TABLE HINGES *each (replacing SELBY H899-P)	ea	100	\$6.70

**TABLE HINGES, FLIP TOP**

**SELBY FLIP TOP TABLE HINGES**

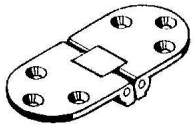

Solid brass, opens 180°, closes flush. 2 3/4" longs x 1 3/16" wide.

BHS#	DESCRIPTION	U/M	BOX	RETAIL
314-30	SELBY H116-P BRASS FLIPTOP HINGE	ea	20	\$16.85

**TABLE LEG BRACES**

**STANLEY TABLE LEG BRACES AND SUPPORTS**

**Carded**

Ideal for use on folding legs of light tables. Locks in open position. Steel, bright brass plated. Length 9 1/2", Width 1/2". Carded - two in pack with screws.

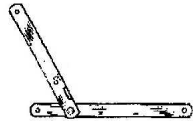

BHS#	DESCRIPTION	U/M	BOX	RETAIL
332-2002	STAN CD441 US3 BRACES 763755; 2/CD	cd	5	\$7.78

**Heavy Duty 13-1/2" X 5/8"**

Heavy steel, bright zinc plated. For banquet tables, tennis tables, folding counters. Made with a positive, easily operated locking feature. Hand identified on leg of brace.

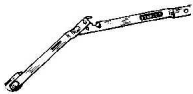

BHS#	DESCRIPTION	U/M	BOX	RETAIL
332-2016	STAN 446-1/4 US2C LEG BRACES 496080 LH & RH	st	5	\$27.46

**Extra Heavy Duty 16-5/8" X 1-1/4"**

Extra heavy steel, bright zinc plated. For banquet tables, tennis tables, folding counters. Made with a positive, easily operated locking feature. Hand identified on leg of brace; includes screws.



BHS#	DESCRIPTION	U/M	BOX	RETAIL
332-2012	STAN 446 US2C LEG BRACES 495680 LH & RH	st	10	\$60.58

**HOOKS, COAT AND HAT**

**BULLDOG COAT AND HAT HOOKS**



BHS#	DESCRIPTION	U/M	BOX	RETAIL
058-163129	BULLDOG 3506111547T US26 COAT HOOK (1-pk) DHH-215	ea	6	\$3.92
058-163121	BULLDOG 3506111560T US3 COAT HOOK (1-pk) DHH-255	ea	6	\$4.15
058-163312	BULLDOG 3506111561T US3 COAT HOOK (1-pk) DHH-205	ea	6	\$2.60

**HOOKS, COAT AND HAT**

**AMEROCK COAT AND HAT HOOKS**

N/A



BHS#	DESCRIPTION	U/M	BOX	RETAIL
014-216562	AMRK H 55465-ORB PILLTOP COAT/HAT HOOK	ea	10	\$5.48

**BALDWIN COAT AND HAT HOOKS**

Height: 2.875", Projection: 3.25"



Solid Brass. F.O.O. Items - allow 8 weeks for delivery.

**NOTE: For other Robe Hooks by Baldwin and Bath Unlimited, Bath Accessories section.**

BHS#	DESCRIPTION	U/M	BOX	RETAIL
032-465	BALDW 0781.030 COSTUME HOOK 3-1/4"; FOO	ea	1	\$26.00

Height: 4.375", Projection: 2.3125"



Solid Brass. F.O.O. Items - allow 8 weeks for delivery.

BHS#	DESCRIPTION	U/M	BOX	RETAIL
032-470	BALDW 0786.030 COSTUME HOOK; FOO	ea	1	\$25.00

Height: 5.375", Projection: 3.5"



Solid Brass.

BHS#	DESCRIPTION	U/M	BOX	RETAIL
032-460	BALDW 0742.030 COSTUME HOOK 5-3/8"	ea	1	\$29.00

**DELTANA COAT HOOKS**



BHS#	DESCRIPTION	U/M	BOX	RETAIL
546-135942	DELTANA CAHH35U15 COAT & HAT HOOK	ea	15	\$12.80
546-178270	DELTANA CAHH35U10B COAT & HAT HOOK	ea	15	\$12.80

**IVES COAT AND HAT HOOKS**

**405A "BP" Pack - Individually poly-bagged w/screws**



"BP" Pack - individually poly-bagged. Size: 1-1/2" H x 7/8" W x 2-1/2" projection. Sold in Full Box Quantities Only.

BHS#	DESCRIPTION	U/M	BOX	RETAIL
174-2032	IVES BP 405A 3 COAT HOOK (150); FOO Sold in FULL BOX QTY (150) only.	ea	150	\$2.00

**405A Slim-Pack -**



Wide body design is ideal for public buildings, schools, dormitories, etc., where hook must withstand unusual stress and strain. Made from cast aluminum. Projection: 2-1/2".

BHS#	DESCRIPTION	U/M	BOX	RETAIL
174-1411	IVES 405A 3 COAT & HAT HOOK	ea	20	\$2.00
174-1414	IVES SP 405A 14 COAT & HAT HOOK	ea	25	\$2.00
174-1415	IVES 405A 92 COAT & HAT HOOK	ea	20	\$2.00



**HOOKS, COAT AND HAT**

**IVES COAT AND HAT HOOKS**

**571A Slim-Pack -**



All purpose hook in traditional design. Projection: 3".

BHS#	DESCRIPTION	U/M	BOX	RETAIL
174-1692	IVES SP 571A 3 COAT & HAT HOOK	ea	25	\$1.20
174-1694	IVES SP 571A 5 COAT & HAT HOOK	ea	25	\$1.40
174-1696	IVES 571A 10 COAT & HAT HOOK	ea	20	\$1.20
174-1698	IVES SP 571A 14 COAT & HAT HOOK	ea	25	\$1.40
174-1700	IVES SP 571A 92 COAT & HAT HOOK	ea	25	\$1.20
174-1800	IVES SP 571A W COAT & HAT HOOK	ea	25	\$1.90

**571MB Box Pack - Cast Brass**



Cast Brass or Bronze. Machine polished. Conforms to Fed. Spec. 1172. Items marked F.O.O. - Allow 3 to 4 weeks for delivery.

BHS#	DESCRIPTION	U/M	BOX	RETAIL
174-1722	IVES 571B 3 COAT & HAT HOOK	ea	10	\$6.60
174-1724	IVES 571MB 10 COAT & HAT HOOK;FOO	ea	10	\$8.30
174-1726	IVES 571B 10B COAT & HAT HOOK	ea	10	\$8.00
174-1720	IVES 571B 716 COAT & HAT HOOK	ea	20	\$8.00
174-1725	IVES 571B 15 COAT & HAT HOOK	ea	10	\$8.30
174-1727	IVES 571B 15A COAT & HAT HOOK; FOO	ea	10	\$8.30
174-1728	IVES 571B 26 COAT & HAT HOOK	ea	10	\$8.00
174-1730	IVES 571B 26D COAT & HAT HOOK	ea	10	\$8.00

**SCHLAGE COAT AND HAT HOOKS**

**Carded, Cast Brass**



BHS#	DESCRIPTION	U/M	BOX	RETAIL
174-173354	SCH SC 571MB 605 COAT & HAT HOOK	cd	5	\$7.24
174-173356	SCH SC 571MB 619 COAT & HAT HOOK	cd	5	\$8.82
174-173358	SCH SC 571MB 716 COAT & HAT HOOK	cd	5	\$8.82

**IVES COAT AND HAT HOOKS**

**Costume Hooks**



IVES wardrobe hook available several finishes. Compact hook is perfect for where space is limited.

BHS#	DESCRIPTION	U/M	BOX	RETAIL
174-1762	IVES 575A 3 COAT & HAT HOOK	ea	15	\$4.00
174-1764	IVES 575A 92 COAT & HAT HOOK	ea	15	\$4.00

**STANLEY COAT AND HAT HOOKS**

**3" Coat and Hat Hook**



Ideal for use in bedroom, bathroom or foyer Extra heavy for added strength Round corners reduce clothing tears Base material: Zinc die cast

BHS#	DESCRIPTION	U/M	BOX	RETAIL
332-3952	STAN CD7067 US3 HEAVY COAT & HAT HOOK 819175; 1/CD	cd	5	\$4.82

**5" Coat and Hat Hook**



Extra large and heavy for added strength Round corners reduce clothing tears Contemporary styling enhances any décor Base material: Zinc die cast

BHS#	DESCRIPTION	U/M	BOX	RETAIL
332-3954	STAN CD7068 US3 C&H HOOK 819179;FOO	cd	5	\$7.14

**HOOKS, COAT AND HAT**

**STANLEY COAT AND HAT HOOKS**

**Cast Metal, Brass Plated**

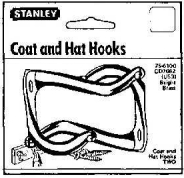

Packed two per card with screws.

BHS#	DESCRIPTION	U/M	BOX	RETAIL
332-4002	STAN CD7082 US3 C&H HOOK 756100; 2/CD	cd	10	\$3.42
332-4004	STAN CD7082 F8 C&H HOOK 756103;2/CD	cd	10	\$5.06
332-3997	STAN CD7082 WHITE C&H HOOK 756110; 2/CD	cd	5	\$6.20
332-3998	STAN CD7082 US15 C&H HOOK 756117; 2/CD	cd	10	\$5.43
332-3999	STAN CD7082 15A C&H HOOK 756118; 2/CD	cd	10	\$5.43

**Solid Brass**



Made of solid brass. 1 per card.

BHS#	DESCRIPTION	U/M	BOX	RETAIL
332-4412	STAN CD80-4020 US3 C&H HOOK 804020	cd	5	\$11.12

**Mini Coat and Hat Hook**



Generously formed with no sharp or protruding parts Can be used to hang lightweight coats, hats and towels Base material: Zinc die cast Upper hook projection: 1-1/2"

BHS#	DESCRIPTION	U/M	BOX	RETAIL
332-4007	STAN CD7084 US3 MINI COAT & HAT HOOKS 758440; 2/CD	cd	10	\$2.60

**HOOKS, GARMENT**

**KNAPE & VOGT GARMENT HOOKS**

**Bright Chrome Look**



Classic institutional garment hook. 5 1/4" high with 3" projection.

BHS#	DESCRIPTION	U/M	BOX	RETAIL
194-1704	KV P 2038 CHR HOOK; FOO	ea	10	\$5.86

**STANLEY GARMENT HOOK**

**Bright Brass**



Ideal for use in bedrooms, bathrooms, closets and foyers Contemporary styling adds a sophisticated flair to any décor Base material: Zinc die cast.

BHS#	DESCRIPTION	U/M	BOX	RETAIL
332-3987	STAN CD7078 US3 GARMENT HOOK 758441	cd	5	\$7.86

**Garment Hook, Solid Brass**



Carded - 1 per card.

BHS#	DESCRIPTION	U/M	BOX	RETAIL
332-4420	STAN CD80-4035 US3 GARM.HOOK 804035	cd	5	\$28.00

**HOOKS, GARMENT**

**STANLEY GARMENT HOOK**



Ideal for use in bedrooms, bathrooms, offices, etc. Attractive white finish complements any decor Upper hole projection: 4-13/64"

<i><b>BHS#</b></i>	<i><b>DESCRIPTION</b></i>	<i><b>U/M</b></i>	<i><b>BOX</b></i>	<i><b>RETAIL</b></i>
332-4810	STAN CD8505 WHITE GARMENT HOOK; 752013; 1/CD	cd	5	\$2.74

**Single Prong**



Ideal for use in bedrooms, offices, etc. Attractive white finish complements any decor. Installed projection: 1-5/8"

<i><b>BHS#</b></i>	<i><b>DESCRIPTION</b></i>	<i><b>U/M</b></i>	<i><b>BOX</b></i>	<i><b>RETAIL</b></i>
332-4816	STAN CD8508 WHITE SGL PRONG HOOK 752016; 1/CD	cd	5	\$3.28

**HOOKS, MAGNETIC**

**STANLEY MAGNETIC HOOK**



Ideal for use in the kitchen, office, or workshop - stores towels, pot holders, etc. No installation required. Attaches to any steel surface. Can be easily moved. Attractive white finish complements any décor.

<i><b>BHS#</b></i>	<i><b>DESCRIPTION</b></i>	<i><b>U/M</b></i>	<i><b>BOX</b></i>	<i><b>RETAIL</b></i>
332-4822	STAN CD8511 WHITE MAGNETIC SGL PRONG HOOK 752019; 2/CD;	cd	5	\$3.31

**HOOKS, SELF-ADHESIVE**

**STANLEY SELF-ADHESIVE HOOK**

**Oval Single Hook**



Ideal for use in the kitchen, bathroom or bedroom. Installs easily to store clothing, towels or kitchen utensils. Attractive white finish complements any décor.

<i><b>BHS#</b></i>	<i><b>DESCRIPTION</b></i>	<i><b>U/M</b></i>	<i><b>BOX</b></i>	<i><b>RETAIL</b></i>
332-4818	STAN CD8509 WHITE SELF-ADHESIVE SGL PRONG HOOK 752017; 2/CD	cd	5	\$2.51

**Quadruple Hook**

Ideal for use in the kitchen, bathroom or bedroom. Installs easily to store clothing, towels, kitchen utensils, etc. Attractive white finish complements any décor.



<i><b>BHS#</b></i>	<i><b>DESCRIPTION</b></i>	<i><b>U/M</b></i>	<i><b>BOX</b></i>	<i><b>RETAIL</b></i>
332-4826	STAN CD8513 WHITE SELF-ADHESIVE ALL PURPOSE HOOK; 752021; 1/CD	cd	5	\$3.10

**STANLEY SELF-ADHESIVE UTILITY HOOK**

**Round Single Hook**



Ideal for use in the kitchen, bathroom or bedroom. Installs easily to store clothing, towels or kitchen utensils. Attractive white finish complements any décor. Installed projection: 1-5/64"

<i><b>BHS#</b></i>	<i><b>DESCRIPTION</b></i>	<i><b>U/M</b></i>	<i><b>BOX</b></i>	<i><b>RETAIL</b></i>
332-4812	STAN CD8506 WHITE SELF-ADHESIVE HOOK 752014; 4/CD	cd	5	\$3.79

**HOOKS, MAGNETIC**

**STANLEY MAGNETIC HOOK**

**Plastic Clip**



Ideal for use in the kitchen, office or workshop. No installation required. Attaches to any steel surface. Can be easily moved. Attractive white finish complements any décor.

BHS#	DESCRIPTION	U/M	BOX	RETAIL
332-4828	STAN CD8514 WHITE MAGNETIC CLIP 752024; 2/CD	cd	5	\$4.53

**HOOKS, OVER-THE-DOOR**

**STANLEY OVER-THE-DOOR HOOK**



Ideal for hanging laundry, dry-cleaning or ironing. Can be placed over any 1-3/8" interior door to create an instant closet. Attractive white finish complements any décor. Installed projection: 1-9/32"

BHS#	DESCRIPTION	U/M	BOX	RETAIL
332-4824	STAN CD8512 WHITE OVER-THE-DOOR HOOK; 752020; 1/CD	cd	10	\$2.27

**STANLEY OVER-THE-DOOR CLOTHES HOOK**



Ideal for hanging laundry, dry-cleaning or ironing. Can be placed over any 1-3/8" interior door to create an instant closet. Available in attractive white or clear finish - complements any décor. Installed projection: 5-1/4"

BHS#	DESCRIPTION	U/M	BOX	RETAIL
332-4836	STAN CD8515 WHITE OVER-THE-DOOR HOOK 752022; 1/CD	cd	5	\$3.53
332-4834	STAN CD8515 CLEAR OVER-THE-DOOR HOOK 752023; 1/CD; FOO	cd	5	\$3.53

**HOOKS, ROBE**

**STANLEY ROBE HOOKS**

**Single Prong Robe Hook**

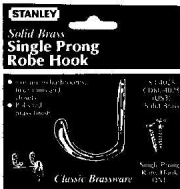

Made of solid brass. Carded - 1 per card.

BHS#	DESCRIPTION	U/M	BOX	RETAIL
332-4416	STAN CD80-4025 US3 SGL HOOK 804025	cd	5	\$6.12

**Double Prong Robe Hook**

Made of solid brass. Carded - 1 per card.



BHS#	DESCRIPTION	U/M	BOX	RETAIL
332-4418	STAN CD80-4030 US3 DBL HOOK 804030	cd	5	\$7.69

**Single Prong Robe Hook - Zinc**



For use where a single hook, or a series of single hooks, is desired Adds a decorative accent to any room Base material: Zinc die cast

BHS#	DESCRIPTION	U/M	BOX	RETAIL
332-3620	STAN CD4025 US3 SGL PRONG COAT HOOK 819080; 2/CD	cd	5	\$3.61
332-3625	STAN CD4025 US26 SGL PRONG COAT HOOK 819070; 2/CD	cd	5	\$3.98
332-3626	STAN CD4025 WHITE SGL PRONG COAT HOOK 819116; 2/CD	cd	5	\$4.49

**HOOKS, ROBE**

**STANLEY ROBE HOOKS**

**Double Prong Robe Hook - Zinc**



Ideal for use in bedroom, bath, kitchen or closet Makes excellent shirt hooks Contemporary design blends with many decorating schemes Base material: Zinc die cast

BHS#	DESCRIPTION	U/M	BOX	RETAIL
332-3630	STAN CD4030 US3 DBL PRONG COAT HOOK 819076; 1/CD	cd	5	\$2.20
332-3633	STAN CD4030 US15 DBL PRONG COAT HOOK 819092; 1/CD	cd	5	\$3.18
332-3634	STAN CD4030 15A DBL PRONG COAT HOOK 819093; 1/CD	cd	5	\$3.14
332-3635	STAN CD4030 US26 DBL PRONG COAT HOOK 819077; 1/CD	cd	5	\$2.36
332-3636	STAN CD4030 WHITE DBL PRONG COAT HOOK 819120; 1/CD	cd	5	\$2.76

**Heavy Duby White Robe Hook**



Ideal for use in the bedroom, bathroom, etc. Screws are concealed for a more decorative appearance. Attractive white finish complements any decor. Installed projection: 1-25/32"

BHS#	DESCRIPTION	U/M	BOX	RETAIL
332-4814	STAN CD8507 WHITE H/D ROBE HOOK 752015; 2/CD	cd	5	\$3.79

**HOOKS, UTILITY**

**KNAPE & VOGT UTILITY HOOK**



Sturdy steel rod for extra hanging space. 5 1/2" and 10" length. 1/2" diameter. Screws furnished. Anochrome.

BHS#	DESCRIPTION	U/M	BOX	RETAIL
194-24	KV PKV3 ANO 5-1/2" UTILITY HOOK	ea	10	\$14.86
194-25	KV PKV3 ANO 10" GARMENT BRKT	ea	10	\$15.84

**HOOKS, WARDROBE**

**IVES WARDROBE HOOKS**

**Cast Aluminum, Single Prong**



Compact hook is perfect where space is limited, ideal for behind doors where low profile is desired. Packed with screws. Cast aluminum, burnished or machine polished. Base 1 1/8" H x 1 1/8" W, projection 1 11/16".

BHS#	DESCRIPTION	U/M	BOX	RETAIL
174-1802	IVES SP 581A 3 SGL WARDROBE HOOK	ea	50	\$1.30
174-1807	IVES SP 581A 92 SGL WARDROBE HOOK	ea	50	\$1.30
174-1808	IVES SP 581A-W SGL WARDROBE HOOK	ea	20	\$1.77

**Cast Brass, Single Prong**



Compact hook is perfect where space is limited, ideal for behind doors where low profile is desired. Packed with screws. Cast brass, machine polished. Base 1 1/8" H x 1 1/8" W, projection 1 11/16".

BHS#	DESCRIPTION	U/M	BOX	RETAIL
174-1801	IVES 581MB 3 SGL WARDROBE HOOK	ea	10	\$4.50
174-1805	IVES 581B 10B SGL WARDROBE HOOK	ea	10	\$5.30
174-1809	IVES 581MB 15 SGL WARDROBE HOOK	ea	10	\$5.60
174-1810	IVES 581MB 26 SGL WARDROBE HOOK	ea	10	\$5.30
174-1819	IVES 581B 26D SGL WARDROBE HOOK	ea	10	\$5.30

**SCHLAGE WARDROBE HOOKS**

**Cast Brass, Single Prong**



BHS#	DESCRIPTION	U/M	BOX	RETAIL
174-173359	SCH SC 581MB 605 SGL WARDROBE HOOK	cd	5	\$4.87
174-173361	SCH SC 581MB 619 SGL WARDROBE HOOK	cd	5	\$6.11
174-173363	SCH SC 581MB 716 SGL WARDROBE HOOK	cd	5	\$6.11

**HOOKS, WARDROBE**

**IVES WARDROBE HOOKS**

**Cast Brass, Double Prong**



Compact hook is perfect where space is limited, ideal for behind doors where low profile is desired. Packed with screws. Cast aluminum, burnished and machine polished. Base 1 1/8" H x 1 1/8" W, projection 1 1/8".

BHS#	DESCRIPTION	U/M	BOX	RETAIL
174-1824	IVES 582MB 3 DBL WARDROBE HOOK	ea	10	\$6.00
174-1825	IVES 582B 5 DBL WARDROBE HOOK	ea	10	\$6.60
174-1826	IVES 582MB 15 DBL WARDROBE HOOK	ea	10	\$7.50
174-1821	IVES 582B 716 DBL WARDROBE HOOK	ea	20	\$7.50
174-1827	IVES 582MB 26 DBL WARDROBE HOOK	ea	10	\$7.20
174-1828	IVES 582B 26D DBL WARDROBE HOOK	ea	10	\$7.20

**Cast Aluminum, Double Prong**



Compact hook is perfect where space is limited, ideal for behind doors where low profile is desired. Packed with screws. Cast aluminum, burnished and machine polished. Base 1 1/8" H x 1 1/8" W, projection 1 1/8".

BHS#	DESCRIPTION	U/M	BOX	RETAIL
174-1822	IVES 582A 3 DBL WARDR HOOK	ea	20	\$1.40
174-1835	IVES 582A 92 DBL WARDROBE HOOK	ea	20	\$1.40
174-1820	IVES 582A W DBL WARDROBE HOOK	ea	20	\$2.00

**SCHLAGE WARDROBE HOOKS**

**Cast Brass, Double Prong**



BHS#	DESCRIPTION	U/M	BOX	RETAIL
174-173364	SCH SC 582MB 605 DBL WARDROBE HOOK	cd	5	\$6.27
174-173366	SCH SC 582MB 619 DBL WARDROBE HOOK	cd	5	\$7.82
174-173368	SCH SC 582MB 716 DBL WARDROBE HOOK	cd	5	\$7.82

**HOOKS, CEILING**

**IVES CEILING HOOKS**



Case aluminum burnished or machine polished. Projection 2 1/4". Individually poly-bagged with screws.

BHS#	DESCRIPTION	U/M	BOX	RETAIL
174-1792	IVES SP 580A 3 CEILING HOOK	ea	25	\$2.20
174-1794	IVES SP 580A 92 CEILING HOOK	ea	25	\$2.20

**HOOKS, WIRE COAT**

**IVES WIRE COAT HOOKS**

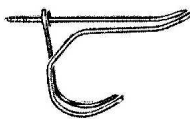

Steel, brass plated. Projection 3 1/8". Two per poly bag.

BHS#	DESCRIPTION	U/M	BOX	RETAIL
174-1742	IVES SP 573F 3 COAT & HAT HOOK 2/BG	ea	15	\$2.10

**STANLEY WIRE COAT AND HAT HOOKS**

**Wire**



One piece wire hook easily screws to wall. Base metal: steel. Upper hook projection: 3 1/8".

BHS#	DESCRIPTION	U/M	BOX	RETAIL
332-4003	STAN CD7083 ST4C/3 COAT HOOKS 577327; 2/CD	cd	10	\$2.60
332-4005	STAN CD7083 US2C COAT HOOKS 756056; 2/CD	cd	10	\$2.30

**MOP HOLDER**

**BASSICK TOOL OR MOP HOLDER**



Serrated molded rubber cam, spring loaded. Riveted to 16 ga. zinc plated steel chassis. Packed 50 per carton. Screws not included.

BHS#	DESCRIPTION	U/M	BOX	RETAIL
098-10	BASSICK M515 BASSICK MOP HOLDER	ea	1	\$4.40

**BROOM HOLDER**

**STANLEY BROOM HOLDER**



Ideal for use in laundry areas, basements, garages, etc. Bright red rollers are easy to see in dimly lighted areas. Available in rust resistant bright chrome finish. Projection: 1-1/16"

BHS#	DESCRIPTION	U/M	BOX	RETAIL
332-4848	STAN CD8522 US2C/RED VINYL BROOM HOLDER; 2/CD; 752025	cd	5	\$3.08

**STORAGE HOOKS**

**LEHIGH WHEELBARROW HOLDER**

**For Storing Your Wheelbarrow**

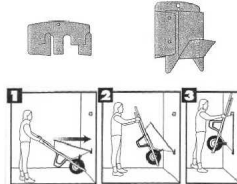

Roll wheelbarrow up against lower bracket. Tip wheelbarrow up and push forward making sure bottom of wheelbarrow fits in lower bracket. Push top of wheelbarrow against top bracket locking wheelbarrow in place. This holder has a safety catch to avoid accidental release.

BHS#	DESCRIPTION	U/M	BOX	RETAIL
582-29350	CRAWFORD WBH WHEELBARROW HOLDER	ea	12	\$11.43

**LUMB-R-GRIP TOOLES HANGERS**

Red, 2 per card



Without fasteners or tools, attach the grip end on the wood and hang whatever you want from the hook end. Each Hook holds up to 200 lbs. Constructed of dipped and coated steel. Has holes for permanent mounting with screws (not included). Each is 7"l., 3 oz.

BHS#	DESCRIPTION	U/M	BOX	RETAIL
594-142788	LUMB-R-GRIP LRG-21240 HANGERS; RED; 2/cd (repl. YOISTERS); 12cd/bx	bx	12	\$71.14

**STANLEY HEAVY DUTY STORAGE HOOKS**

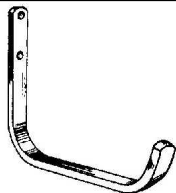

For hanging ladders, lawn chairs, bicycles, etc. Holds up to 50 lbs. each. Curved hook prevents products from falling off. Rust resistant, zinc plated. Two per card. Finish - US2C. Size - 5".

BHS#	DESCRIPTION	U/M	BOX	RETAIL
332-4072	STAN CD8309 US2C STOR.HOOK 819250; 2/CD; FOO	cd	10	\$5.77

**STANLEY OVERHEAD STORAGE HOOKS**

Vinyl Coated



BHS#	DESCRIPTION	U/M	BOX	RETAIL
332-4700	STAN CD8330 US2C OVERHEAD STOR.HOOK 819260; 2/CD	cd	10	\$2.44

Bulk



Ideal for storing rakes, shovels and hoes Vinyl coating helps protect the surface of item being stored Maximum load: 15 lbs. 1/4" Wire diameter

BHS#	DESCRIPTION	U/M	BOX	RETAIL
332-4830	STAN DP8330 2C w/RED VINYL HOOK; 132600	ea	80	\$.89

**STORAGE HOOKS**

**STANLEY LADDER STORAGE HOOKS**

Vinyl Coated

	<b>BHS#</b>	<b>DESCRIPTION</b>	<b>U/M</b>	<b>BOX</b>	<b>RETAIL</b>
	332-4071	STAN CD8331 US2C LADDER STOR/HOOKS; 2/cd; 819270	cd	10	\$3.39

**STANLEY TOOL STORAGE HOOKS**

Vinyl Coated

	<b>BHS#</b>	<b>DESCRIPTION</b>	<b>U/M</b>	<b>BOX</b>	<b>RETAIL</b>
	332-4072	STAN CD8332 US2C TOOL STORAGE HOOKS 2/cd; 819280	cd	10	\$2.51

Bulk

	Ideal for storing rakes, shovels and hoes Vinyl coating helps protect the surface of item being stored Maximum load: 15 lbs. 1/4" Wire diameter				
--	---	--	--	--	--

	<b>BHS#</b>	<b>DESCRIPTION</b>	<b>U/M</b>	<b>BOX</b>	<b>RETAIL</b>
	332-4832	STAN DP8332 2C TOOL STORAGE HOOK; 132620	ea	100	\$1.02
	332-4866	STAN 751073 2C w/ BLACK VINYL H/D RAFTER HANGER	ea	50	\$3.80
	332-4864	STAN 751054 2C w/ BLACK VINYL H/D LADDER HANGER	ea	50	\$3.80

**STANLEY UTILITY STORAGE HOOKS**

Vinyl Coated

	<b>BHS#</b>	<b>DESCRIPTION</b>	<b>U/M</b>	<b>BOX</b>	<b>RETAIL</b>
	332-4073	STAN CD8333 US2C UTILITY STOR.HOOK	cd	10	\$4.30

Bulk Vinyl Coated

	<b>BHS#</b>	<b>DESCRIPTION</b>	<b>U/M</b>	<b>BOX</b>	<b>RETAIL</b>
	332-4860	STAN 751074 2C w/ BLACK VINYL H/D UTILITY HANGER	ea	40	\$3.80



**STORAGE HOOKS**

**STANLEY ALL-PURPOSE STORAGE HOOKS**

**Vinyl Coated**

Ideal for hanging plants, lamps and extension cords Vinyl coating helps protect the surface of item being stored Maximum load: 120 lbs. 1/4" Wire diameter



BHS#	DESCRIPTION	U/M	BOX	RETAIL
332-4074	STAN CD8334 US2C ALL-PURP STOR/HOOK 2/cd; 819300	cd	10	\$2.44

**STANLEY STORAGE CLIP**

**Holding Range 1/2" to 1 1/4"**

Spring-loaded clip is ideal for storing tools such as screwdrivers, paint brushes, etc. For use in garages, sheds, workshops and basements. Available in rust resistant zinc finish. Rod diameter holding range: 1/2" - 1-1/4"



BHS#	DESCRIPTION	U/M	BOX	RETAIL
332-4838	STAN CD8517 US2C GIANT TOOL STORAGE CLIP; 752001;	cd	5	\$2.08

**Holding Range 9/16" to 1 1/4"**

Spring-loaded clips are ideal for storing smaller tools such as screwdrivers, paint brushes, etc. For use in garages, sheds, workshops and basements. Available in rust resistant zinc finish. Rod diameter holding range: 9/16" - 1-1/4". Installed projection: 2-19/32"



BHS#	DESCRIPTION	U/M	BOX	RETAIL
332-4840	STAN CD8518 US2C TOOL STORAGE CLIP; 2/CD; 752003	cd	5	\$3.08

**Multiple Clips, Holding Range 9/16" to 1 1/4"**

Spring-loaded clip s are ideal for storing smaller tools such as screwdrivers, paint brushes, etc. For use in garages, sheds, workshops and basements. Available in rust resistant zinc finish. Rod diameter holding range: 9/16" - 1-1/4" Installed projection: 2-7/8"



BHS#	DESCRIPTION	U/M	BOX	RETAIL
332-4842	STAN CD8519 US2C 8" TOOL STORAGE CLIP; 1/CD; 752004	cd	5	\$5.55
332-4846	STAN CD8521 US2C 15" TOOL STORAGE CLIP; 1/CD; 752006	cd	5	\$8.74

**STANLEY MAGNETIC TOOL BAR**

Ideal for storage of tools with metallic surface. For use in garages, sheds, workshops and basements. Available in rust resistant bright red finish. Installed projection: 9/32"



BHS#	DESCRIPTION	U/M	BOX	RETAIL
332-4850	STAN CD8523 RED STEEL MAGNETIC TOOL BAR; 752031	cd	5	\$12.82

**STANLEY SUPER GRIP TOOL HOLDER**

BHS#	DESCRIPTION	U/M	BOX	RETAIL
332-1065	STAN DP8404 HD SUPER GRIP TOOL HOLDER; 2/PK 751084	ea	5	\$4.53

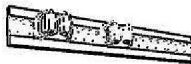

**STORAGE HOOKS****STANLEY MULTI HOLDER RAIL TOOL HOLDER**

Use for brooms, mops and long handled garden tools. Position the hooks where you want them. Maximum load: 5 lbs or 2 kgs per hook. Recommended to mount in studs or concrete walls. 2``H x 17-1/4``L x 1-1/4``W.

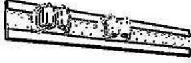

<b>BHS#</b>	<b>DESCRIPTION</b>	<b>U/M</b>	<b>BOX</b>	<b>RETAIL</b>
332-1070	STAN DP8403 MULTI HOLDER RAIL 751086	ea	50	\$19.70

**PEGBOARD HOOKS**

**STANLEY PEGBOARD HOOKS**

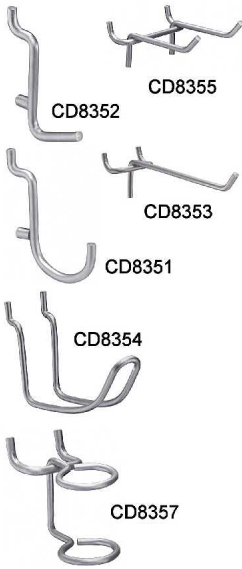

Fits 1/8" and 1/4" pegboard For use in garages, sheds, basements and workshops Available in rust resistant zinc finish

BHS#	DESCRIPTION	U/M	BOX	RETAIL
332-4720	STAN CD8345 US2C STORAGE CLIP; 2/pk 819420	cd	5	\$1.89
332-4729	STAN CD8351-1/4 US2C CURVED PEGBOARD HOOKS 819510; 10/CD; FOO	cd	10	\$1.96
332-4730	STAN CD8351-1/2 US2C 1" CURVED PEGBOARD HOOKS 819515; 10/CD	cd	10	\$1.96
332-4731	STAN CD8351-1 US2C 1-1/2" CURVED PEGBOARD HOOKS 819520; 8/CD	cd	10	\$1.96
332-4732	STAN CD8351-1.5 US2C CURVED PEGBOARD HOOKS 819525; 6/CD	cd	10	\$1.96
332-4741	STAN CD8352-1 US2C 1" ANGLED PEGBOARD HOOKS 819530; 8/CD	cd	10	\$1.96
332-4742	STAN CD8352-1.5 US2C 1.5" ANGLED PEGBOARD HOOKS 819535; 8/CD	cd	10	\$1.96
332-4078	STAN CD8352 US2C 2-1/2" PEGBOARD	cd	10	\$1.96
332-4753	STAN CD8353-2 US2C 2" STRAIGHT PEGBOARD HOOKS 819545; 4/CD	cd	10	\$2.08
332-4755	STAN CD8353-4 US2C 4" STRAIGHT PEGBOARD HOOKS 819550; 3/CD	cd	10	\$2.08
332-4757	STAN CD8353-6 US2C 6" STRAIGHT PEGBOARD HOOKS 819555; 3/CD	cd	10	\$2.08
332-4080	STAN CD8353-8 US2C 8" STRAIGHT PEGBOARD HOOKS 819560; 3/CD	cd	10	\$2.15
332-4764	STAN CD8354-3 US2C 3" DOUBLE LOOP PEGBOARD HOOKS 819565; 2/CD	cd	10	\$1.72
332-4766	STAN CD8354-5 US2C 5" DOUBLE LOOP PEGBOARD HOOKS 819570; 2/CD	cd	10	\$1.89
332-4773	STAN CD8355-2 US2C DOUBLE STRAIGHT PEGBOARD HOOKS 819575; 2/CD	cd	10	\$1.96
332-4774	STAN CD8355-4 US2C DOUBLE STRAIGHT PEGBOARD HOOKS 819580; 2/CD	cd	10	\$2.20
332-4775	STAN CD8356 US2C PLIERS HOLDERS 819585; 4/CD	cd	10	\$1.89
332-4777	STAN CD8357 US2C TOOL HOLDERS 819590; 2/CD	cd	10	\$1.96
332-4779	STAN CD8358 US2C MULTI TOOL HOLDERS 819595; 1/CD	cd	10	\$3.08
332-4785	STAN CD8363-5/8" US2C CURVED PEGBOARD HOOKS; 8/CD 819625	cd	10	\$2.51
332-4787	STAN CD8365-6 US2C 6" STRAIGHT HOOKS; 2/CD 819645	cd	10	\$2.63
332-4399	STAN CD8379 US2C 32 PIECE LOCKING PEG HOOK ASSRT. 751082	cd	5	\$7.60
332-4398	STAN CD8380 4; 6 & 8" STRAIGHT PEG HOOK US2C. 751076 (also CD751076)	cd	10	\$5.91
332-4439	STAN CD81-9841 PEGBOARD HOOK ASSORTMENT; 819841	cd	4	\$10.34
332-1060	STAN CD8377 H.D.32 PIECE PEG HOOK US2C 751057	cd	5	\$12.66
332-1052	STAN CD8381 H.D. 3" & 5" US2C DBL PEG HOOK 751077	cd	10	\$6.39
332-1050	STAN CD8378 H.D. 27 PIECE LOCKING PEG US2C 751078	cd	5	\$7.51

**MURPHY BED HARDWARE**

**SELBY MURPHY BED SYSTEM**

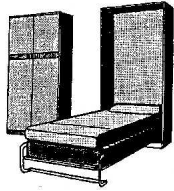

**Inside Mount - Double and Queen Size Platform Bed (Cabinet Mounted)**

**Counterbalance and foot rest ONLY. The rest is self-supplied.**

Wood frame is built on back side of door to receive mattress or box spring. Adjustable-tension counterbalanced spring units control descent and assist ascent. Fully mounted inside cabinet, not bolted to the floor! Pivoting footrest folds inside cabinet when closed. Cabinet fastens to the wall with a small "L" bracket at top. Cabinet depth only 14". Outside mount is available. F.O.O. Allow 2 weeks for delivery. Specify Inside or Outside mount. Must be shipped via autofreight.

BHS#	DESCRIPTION	U/M	BOX	RETAIL
314-36991	SELBY XSMVO54/75I INSIDE MOUNT; FOO (was XSMVO-138) MURPHY BED SYSTEM (Must be shipped via autofreight)	ea	1	\$1,444.08
314-36992	SELBY XSMVO54/75X OUTSIDEMOUNT; FOO (was XSMVO-138) MURPHY BED SYSTEM (Must be shipped via autofreight)	ea	1	\$1,444.08

**IRONING CENTERS**

**IRON-A-WAY BUILT-IN IRONING CENTERS**

**Deluxe 42" w/Birch Door & Swivel Board**



90° left/right, industry standard 42" swivel board with birch door. Solid-state, silent timer, side-mounted swivel light, electrical outlet, on/off pilot light, hot iron and accessory storage, and easy, 4 in. height adjustment. Outside dimensions: 15" x 47 7/8" x 7 3/8". Rough-in opening size: 14 1/4" x 47 1/8" x 3 7/8". Outside door dimensions: 15" x 47 7/8".

BHS#	DESCRIPTION	U/M	BOX	RETAIL
171-2005	IRONAWAY A-42A w/ BIRCH DOOR "NEW STYLE" IRONING CENTER *171-2005	ea	1	\$697.63

**42" w/Birch Door**



Attractive wood door is ready to finish. Easy to install on wall surface of recessed between standard 16" stud space. Includes 42" ventilated steel ironing board with pad and cover set. Handy utility shelf and hot iron storage area standard. Outside dimensions: 15" x 47 7/8" x 7 3/8". Rough-in opening size: 14 1/4" x 47 1/8" x 3 7/8". Outside door dimensions: 15" x 47 7/8".

BHS#	DESCRIPTION	U/M	BOX	RETAIL
171-2020	IRONAWAY E-342A w/ BIRCH DOOR "NEW STYLE" IRONING CTR *171-2020	ea	1	\$516.03

**42" w/Birch Door & Swivel**



Features a 90°-left/right 42" swivel board. Illuminated rocker switch turns power on and off. Attractive wood door. Attractive wood door is ready to finish. Easy to install on wall surface of recessed between standard 16" stud space. Includes 42" ventilated steel ironing board with pad and cover set. Handy utility shelf and hot iron storage area standard. Outside dimensions: 15" x 47 7/8" x 7 3/8". Rough-in opening size: 14 1/4" x 47 1/8" x 3 7/8". Outside door dimensions: 15" x 47 7/8".

BHS#	DESCRIPTION	U/M	BOX	RETAIL
171-2025	IRONAWAY ES-342A w/ BIRCH DOOR "NEW STYLE" & SWIVEL *171-2025 PLEASE INSPECT THIS ITEM FOR DAMAGE	ea	1	\$638.10

**IRONING CENTERS**

**IRON-A-WAY BUILT-IN IRONING CENTERS**

**42" Non-Electric w/Birch Door**



Iron-A-Way's functional, economical ironing center includes 42" ventilated steel ironing board with pad and cover set. Handy utility shelf and hot iron storage area standard. Outside dimensions: 15" x 47 7/8" x 7 3/8". Rough-in opening size: 14 1/4" x 47 1/8" x 3 7/8". Outside door dimensions: 15" x 47 7/8".

<b>BHS#</b>	<b>DESCRIPTION</b>	<b>U/M</b>	<b>BOX</b>	<b>RETAIL</b>
171-2030	IRONAWAY NE-342A w/ BIRCH DOOR "NEW STYLE" IRONING CENTER; 171-2030 PLEASE INSPECT THIS ITEM FOR DAMAGE	ea	1	\$367.15

**Deluxe 46" w/Birch Door**



Compact Iron-A-Way ironing center. Solid core birch door to finish as you like. Can be surface-mounted or recessed. Outside dimensions: 15" x 60 5/8" x 6 7/8". Rough-in opening size: 14 1/4" x 59 7/8" x 3 7/8". Outside door dimensions: 15" x 60 5/8".

<b>BHS#</b>	<b>DESCRIPTION</b>	<b>U/M</b>	<b>BOX</b>	<b>RETAIL</b>
171-2010	IRONAWAY A-46A w/ BIRCH DOOR "NEW STYLE" IRONING CENTER *171-2010 PLEASE INSPECT THIS ITEM FOR DAMAGE	ea	1	\$683.41

**Sleeve Board/Holder**

<b>No Illustration Available</b>	<b>BHS#</b>	<b>DESCRIPTION</b>	<b>U/M</b>	<b>BOX</b>	<b>RETAIL</b>
	171-1000	IRONAWAY SLEEVEBOARD/HOLDER 171-1000	ea	1	\$47.47

**Cover Pad**

Cover Pad for 42" or 46" Boards

<b>No Illustration Available</b>	<b>BHS#</b>	<b>DESCRIPTION</b>	<b>U/M</b>	<b>BOX</b>	<b>RETAIL</b>
	171-58850	IRONAWAY COVER PAD FOR 42" OR 46"	ea	1	\$36.70

**Mirror Door Brackets**

<b>No Illustration Available</b>	<b>BHS#</b>	<b>DESCRIPTION</b>	<b>U/M</b>	<b>BOX</b>	<b>RETAIL</b>
	171-115794	IRONAWAY MIRROR DOOR BRACKETS ONLY; FOO	st	1	\$31.82

**Surface Mount Trim**

Added Surface Mount Trim - Optional.

<b>No Illustration Available</b>	<b>BHS#</b>	<b>DESCRIPTION</b>	<b>U/M</b>	<b>BOX</b>	<b>RETAIL</b>
	171-1100	IRONAWAY SURFACE MOUNT TRIM 42";FOO	ea	1	\$42.70
	171-1110	IRONAWAY SURFACE MOUNT TRIM 46";FOO	ea	1	\$42.70

**IRONING CENTERS**

**IRON-A-WAY BUILT-IN IRONING CENTERS**

**Additional Information**

COMPONENT	MODEL A-46A	MODEL A-42A	MODEL E-342A	MODEL NE-342A
Ironing Board	46" Ventilated steel with 4" vertical adjustment	42" Ventilated steel with 4" vertical adjustment	42" Ventilated steel	42" Ventilated steel
Hot Iron Storage Compartment	Standard	Standard	Standard	Standard
Storage Shelf	Standard	Standard	Standard	Standard
Full Length Piano Hinge	Standard	Standard	Standard	Standard
Ironing Board Cover & Pad	Standard	Standard	Standard	Standard
Electrical System	Motor timer, safety door switch, appliance outlet, indicator light	Motor timer, safety door switch, appliance outlet, indicator light	Rocker switch with lighted indicator, safety door switch, appliance outlet	Not Available
Hot Iron Rest	Standard	Optional	Optional	Optional
Electrical Cord Cover	Standard	Not Available	Not Available	Not Available
Electrical Cord Wrap	Not Available	Standard	Optional	Optional
Garment Bar	Standard	Optional	Optional	Optional
Garment Hook	Not Available	Standard	Standard	Standard
Sleeveboard/Holder	Optional	Optional	Optional	Optional
Spotlight (less bulb)	Standard	Standard	Optional	Not Available
Adjustable Swivel Board	Optional	Standard	Optional	Optional
Surface Mount Trim	Optional	Optional	Optional	Optional
Mirror and Brackets	Optional	Optional	Optional	Optional
Birch Veneer Door*	Standard	Standard	Standard	Standard
Oak Raised Panel Door*	Optional	Optional	Optional	Optional
Maple Raised Panel Door*	Optional	Optional	Optional	Optional
Pine Raised Panel Door*	Optional	Optional	Optional	Optional
White Raised Panel Door*	Optional	Optional	Optional	Optional
White Flat Door*	Optional	Optional	Optional	Optional
No Door	Optional	Optional	Optional	Optional
Steam/Dry Iron	Optional	Optional	Optional	Optional
Added Surface Mount Trim	Optional	Optional	Optional	Optional
Interior Color	Cool Gray	Cool Gray	Cool Gray	Cool Gray
Outside Dimensions	15" x 60 5/8" x 6 7/8"	15" x 47 7/8" x 7 7/8"	15" x 47 7/8" x 7 3/8"	15" x 47 7/8" x 7 3/8"
Opening Size for Recessed Mounting	14 1/4" x 59 7/8" x 3 7/8"	14 1/4" x 47 1/8" x 3 7/8"	14 1/4" x 47 1/8" x 3 7/8"	14 1/4" x 47 1/8" x 3 7/8"
Outside Door Dimensions	15" x 60 5/8"	15" x 47 7/8"	15" x 47 7/8"	15" x 47 7/8"

\*All units can be provided with a left hinged door (without garment hook) upon request. Right hinge is standard.

**NUTONE BUILT-IN IRON CENTERS**

**Pressrite Deluxe Ironing Center - No Door**



**Deluxe Model Ironing Centers**

**Benefits -**

Ventilated Metal Durable board, resistant to moisture, cools quickly.  
 All Metal Construction Iron board, support beams are all metal, excellent quality.  
 Height Adjustable - provides comfort based on user height. 180 degree swivel  
 Unit can fit in tight corners, additional ergonomics.

**Storage -**

Hot iron storage shelf  
 Deep and tall to accommodate today's larger sized irons.  
 Utility/Storage Shelves to store spray bottles, starch, other items in cabinet.

**Door -**

Multiple styles are available.  
 Provides flexibility for customized look fitting into the consumers décor.  
 Provides a complete unit for consumer, no need to buy separate door.  
 Mounting, both left and right hand provides more consumer flexibility during installation.  
 Note: Custom Doors - Unfinished so that consumers can "stain or paint to match" their décor.  
 Mirror Door features a 1" beveled edge.  
 Electrical Built-In Light (40 watt) provides functional lighting behind a cover to shield heat.  
 Safety Switch/Auto Shutoff Electric supply is turned off when door is closed.  
 Silent Timer Choose when power is supplied, no "ticking" noise.  
 Pilot Light - since timer is silent, shows when power is "on".  
 UL and cUL Approved & Listed Unit meets electrical safety standards in US and Canada.  
 Wall Mounting - Recess Provides neat, "built-in" appearance in the home.  
 Mounting - Surface. Optional collar allows surface mounting.

BHS#	DESCRIPTION	U/M	BOX	RETAIL
274-96480	NUTONE AVD-50N IRON.CTR CABINET	ea	1	\$535.08
	PLEASE INSPECT THIS ITEM FOR DAMAGE			

**IRONING CENTERS**

**NUTONE BUILT-IN IRON CENTERS**

**Pressrite Basic Ironing Center - No Door**

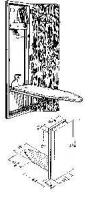

**Basic Model Ironing Centers**

**Benefits -**  
 Ventilated Metal Durable board, resistant to moisture, cools quickly  
 All Metal Construction Iron board, support beams are all metal, excellent quality.

**Storage -**  
 Hot iron storage shelf  
 Deep and tall to accommodate today's larger sized irons.  
 Utility/Storage Shelves Ability to store spray bottles, starch, other items in cabinet.

**Door -**  
 Multiple styles are available.  
 Provides flexibility for customized look fitting into the consumers décor.  
**Order door separately.**  
 Mounting both left and right hand  
 Provides more consumer flexibility during installation.  
 Note: Custom Doors - Unfinished so that consumers can "stain or paint to match" their décor.  
 Mirror Door features a 1" beveled edge.  
 Wall Mounting; Recess Provides neat, "built-in" appearance in the home.

<b>BHS#</b>	<b>DESCRIPTION</b>	<b>U/M</b>	<b>BOX</b>	<b>RETAIL</b>
274-96482	NUTONE AVD-40N IRON.CTR CABINET ONLY; NO DOOR; PRESSRITE PLEASE INSPECT THIS ITEM FOR DAMAGE	ea	1	\$314.76

**Door, Mirror with 1" Beveled Edge**



<b>BHS#</b>	<b>DESCRIPTION</b>	<b>U/M</b>	<b>BOX</b>	<b>RETAIL</b>
274-96486	NUTONE AVD-MFPNH MIRROR DOOR; was AVD-MFPN	ea	1	\$169.98

**Door, Unfinished Birch Flat Panel**



<b>BHS#</b>	<b>DESCRIPTION</b>	<b>U/M</b>	<b>BOX</b>	<b>RETAIL</b>
274-96485	NUTONE AVD-OFPN BIRCH FLAT PANEL UNFINISHED DOOR	ea	1	\$113.30

**IRONING CENTERS**

**NUTONE BUILT-IN IRON CENTERS**

**Door, Unfinished Oak Raised Panel**



<i>BHS#</i>	<i>DESCRIPTION</i>	<i>U/M</i>	<i>BOX</i>	<i>RETAIL</i>
274-96483	NUTONE AVD-ORPN OAK RAISED PANEL UNFINISHED DOOR	ea	1	\$151.08

**Door, White Raised Panel**



<i>BHS#</i>	<i>DESCRIPTION</i>	<i>U/M</i>	<i>BOX</i>	<i>RETAIL</i>
274-96484	NUTONE AVD-WRPN WHITE RAISED PANEL DOOR	ea	1	\$132.22

**Hinge Kit**



<i>BHS#</i>	<i>DESCRIPTION</i>	<i>U/M</i>	<i>BOX</i>	<i>RETAIL</i>
274-96488	NUTONE 99525229A HINGE KIT; repl. AVD-HKN (eff. 4/19/06)	ea	1	\$32.46

**Cover Pad, Replacement**



<i>BHS#</i>	<i>DESCRIPTION</i>	<i>U/M</i>	<i>BOX</i>	<i>RETAIL</i>
274-96487	NUTONE AVD-CPN COVER PAD	ea	1	\$26.28

**VACUUM SYSTEMS, POWER UNITS**

**NUTONE BUILT-IN CENTRAL CLEANING SYSTEM**

**VX-475**



Cleans powerfully, HEPA filtration, Microban protection, simplified bag removal and filter changing. Convenient installation. Left- or right-hand intake ports simplify new or retrofit installations. The slim profile lets the tank fit in tight corners.

<i>BHS#</i>	<i>DESCRIPTION</i>	<i>U/M</i>	<i>BOX</i>	<i>RETAIL</i>
274-420	NUTONE VX475 VACUUM POWER UNIT - BAGGED	ea	1	\$506.14



**VACUUM SYSTEMS, POWER UNITS**  
**NUTONE BUILT-IN CENTRAL CLEANING SYSTEM**

**VX-550**



Cleans powerfully, HEPA filtration, Microban protection, simplified bag removal and filter changing. Convenient installation. Left- or right-hand intake ports simplify new or retrofit installations. The slim profile lets the tank fit in tight corners.

BHS#	DESCRIPTION	U/M	BOX	RETAIL
274-422	NUTONE VX550 VACUUM POWER UNIT - BAGGED	ea	1	\$683.86

**VACUUM SYSTEMS, ACCESSORIES**  
**NUTONE BUILT-IN CENTRAL CLEANING SYSTEM**

**30 Ft Low Voltage Hose**



BHS#	DESCRIPTION	U/M	BOX	RETAIL
274-1205	NUTONE CH-230 30'HOSE;REPL.OLD 572	ea	1	\$121.12

**32 Ft Standard Hose**



Soft vinyl over steel wire interwoven with nylon cord. 1-1/4" diameter. Rotary control on handle regulates suction. Warm gray.

BHS#	DESCRIPTION	U/M	BOX	RETAIL
274-1010	NUTONE 372 32' STANDARD HOSE	ea	1	\$103.42

**30 Ft Deluxe Current-Carrying Hose**



BHS#	DESCRIPTION	U/M	BOX	RETAIL
274-1207	NUTONE CH-520 30'HOSE;REPL.OLD CH510 AND 549 HOSES	ea	1	\$305.94

**30 Ft Deluxe Direct Plug Hose**



30 ft. warm grey 1-3/8" inner hose diameter. For use with NuTone CI390 and CI395 series Inlets, Electrovalve® and Hayden Supervalve®. Sleek, ergonomic handle styling. Soft touch grip handle with full 360° swivel. Improved vacuum release. Easy to use thumb slide three position switch. UL and CUL recognized. Patent Pending Universal Hose End.

BHS#	DESCRIPTION	U/M	BOX	RETAIL
274-1209	NUTONE CH-620 DELUXE 30' HOSE (REPLACES CH-610)	ea	1	\$305.94

**Hose Sock**



Protects furniture, walls and woodwork against scuffs. Fits all 30' - 32' hoses, 1 1/4" - 1 3/8" diameter. Gray knit, 95% polyester and 5% lycra. Washable.

BHS#	DESCRIPTION	U/M	BOX	RETAIL
274-1208	NUTONE CA-130 HOSE SOCK	ea	6	\$39.00

**Basic Tool Set**



Combination floor/rug tool moves from floor to carpet with single pedal operation. Swivel neck on floor/rug tool allows a full range of motion for vacuuming around and under furniture. 10-5/8" wide nozzle with edge-to-edge cleaning and two lint strips. Attractive, durable co-polymer housing. Durable ABS plastic wands, contemporary European styling. Dusting brush with nylon bristles. Upholstery tool. Tools store on handy clip-on caddy, easily accessible as you vacuum. Soft Gray.

BHS#	DESCRIPTION	U/M	BOX	RETAIL
274-1210	NUTONE CK-110 BASIC TOOL SET	ea	6	\$47.46

**VACUUM SYSTEMS, ACCESSORIES**

**NUTONE BUILT-IN CENTRAL CLEANING SYSTEM**

**Standard Tool Set with Hang Bag**



Standard combination floor/rug tool features dual wheels for smooth performance and even air flow. Single pedal mechanism quickly, reliably adjusts nozzle from floor to carpet position. Double orifice baseplate with two lint strips for thorough one-pass cleaning. Edge-to-edge cleaning in wide 10-5/8" path. Dual-action swivel neck for easy maneuverability. Attractive, durable co-polymer housing. Two chrome-steel wands lock securely with button-lock fit. Dusting brush and upholstery tool have nylon bristles. Snap-on tool caddy provides fingertip convenience while vacuuming; cloth caddy for additional storage.

BHS#	DESCRIPTION	U/M	BOX	RETAIL
274-1212	NUTONE CK-120 STANDARD TOOL SET	ea	1	\$98.30

**Deluxe Tool Set with Hang Bag**



Sleek combination floor/rug tool moves from floor to carpet without adjustment. Front and rear wheels provide superior balance to maintain even airflow and easy maneuverability. Soft bristle brush strip allows better dusting of floors. Lint strip picks up tough surface litter like pet hair and string. 11" wide nozzle - full-width air channel for edge-to-edge cleaning. Double swivel neck for better maneuverability. Ratcheting chrome steel wand extends from 22" to 39" at 1" intervals. 10" notched crevice tool provides continuous air flow. Convertible upholstery tool can be used with or without natural bristle brush. Dust brush features natural bristles. Snap-on tool caddy for fingertip convenience while vacuuming; attractive canvas caddy for additional storage. Handsome black finish.

BHS#	DESCRIPTION	U/M	BOX	RETAIL
274-1214	NUTONE CK-230 DELUXE TOOL SET	ea	1	\$115.76

**Deluxe Electric Kit**



**Combination Floor/Rug Tool**

Great maneuverability in sleek new design - moves from floor to carpet without mechanically changing position (no pedal switch). Front and rear wheels provide superior balance for even air flow. Edge-to-edge cleaning with 11" wide air channel and extra wide lint strip. Soft bristle brush strip for better dusting of floors. Double swivel neck for easy maneuverability around and under furniture. Durable non-marring textured gray plastic housing

**Also Features:** Ratcheting Chrome Steel Wand, Notched Crevice Tool, Convertible Upholstery Tool, Dust Brush, Snap-On Tool Caddy, Cloth Caddy, (1) CT600 Deluxe Electric Power Brush, (1) CH615 Current-Carrying Direct Connect Crushproof Hose, (1) CA130 Protective Hose Cover

BHS#	DESCRIPTION	U/M	BOX	RETAIL
274-1219	NUTONE CK-355 DELUXE VACUUM KIT	ea	1	\$661.78

**Delux Dirt-Sensing Power Brush**



4-position height adjustment - Hi, Med, Low, Extra-Low - for all types of carpet Dual edge cleaning, with protective bumper Convenient built-in headlamp Overload reset button Overall size: 14-1/4"W x 9-3/4"D x 3-1/2"H Styled in handsome black Includes two chrome-plated steel wands, UL Listed Assembly. Use with CH-520 and CH-620 hoses.

BHS#	DESCRIPTION	U/M	BOX	RETAIL
274-1217	NUTONE CT-650 DELUXE POWER BRUSH	ea	1	\$552.78

**Turbine Stair Tool**



Hand-held turbine brush is more than a stair tool - use for deep-cleaning in all those tight places. Great for car interiors. Comfortable size - easy to handle. Durable ABS plastic housing, covered belt.

BHS#	DESCRIPTION	U/M	BOX	RETAIL
274-860	NUTONE CT-330B TURBINE STAIR TOOL; FOO	ea	1	\$58.98

**VACUUM SYSTEMS, ROUGH-IN**









**NUTONE BUILT-IN CENTRAL CLEANING SYSTEM**

**100 Ft Wire 18/2**

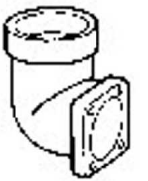

BHS#	DESCRIPTION	U/M	BOX	RETAIL
274-1025	NUTONE 376 WIRE 100' 18/2	ea	6	\$20.90

**VACUUM SYSTEMS, ROUGH-IN**  
**NUTONE BUILT-IN CENTRAL CLEANING SYSTEM**

<b>30deg. Ell</b>					
	<b>BHS#</b> 274-1085	<b>DESCRIPTION</b> NUTONE CF386 30deg ELBOW; was 386	<b>U/M</b> ea	<b>BOX</b> 10	<b>RETAIL</b> \$3.86
<b>45deg. Ell</b>					
	<b>BHS#</b> 274-1080	<b>DESCRIPTION</b> NUTONE CF385 45deg ELBOW; was 385	<b>U/M</b> ea	<b>BOX</b> 20	<b>RETAIL</b> \$2.08
<b>45deg. Street Ell</b>					
	<b>BHS#</b> 274-990	<b>DESCRIPTION</b> NUTONE CF369 45deg STREET ELBOW; was 369	<b>U/M</b> ea	<b>BOX</b> 20	<b>RETAIL</b> \$2.48
<b>45deg. Wye</b>					
	<b>BHS#</b> 274-1100	<b>DESCRIPTION</b> NUTONE CF387 45deg WYE; was 387	<b>U/M</b> ea	<b>BOX</b> 10	<b>RETAIL</b> \$4.28
<b>Mounting Bracket with Plaster Guard</b>					
	<b>BHS#</b> 274-930	<b>DESCRIPTION</b> NUTONE CF361 MTG BRACKET; was 361	<b>U/M</b> ea	<b>BOX</b> 20	<b>RETAIL</b> \$7.06
<b>90deg. Flanged Ell - Standard</b>					
	<b>BHS#</b> 274-935	<b>DESCRIPTION</b> NUTONE CF362 FLANGED ELBOW; was 362	<b>U/M</b> ea	<b>BOX</b> 20	<b>RETAIL</b> \$2.84
<b>90deg. Ell - Special for 3" Walls</b>					
	<b>BHS#</b> 274-950	<b>DESCRIPTION</b> NUTONE CF363 FLANGED ELBOW; FOO was 363	<b>U/M</b> ea	<b>BOX</b> 10	<b>RETAIL</b> \$4.26
<b>Flanged Tee</b>					
	<b>BHS#</b> 274-955	<b>DESCRIPTION</b> NUTONE CF364 FLANGED TEE; was 364	<b>U/M</b> ea	<b>BOX</b> 10	<b>RETAIL</b> \$4.28

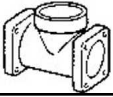
**VACUUM SYSTEMS, ROUGH-IN**
**NUTONE BUILT-IN CENTRAL CLEANING SYSTEM**
**Double Flanged Tee**

**BHS#**  
274-960

**DESCRIPTION**  
NUTONE CF365 DBL FLANGED TEE; was  
365

**U/M**  
ea

**BOX**  
10

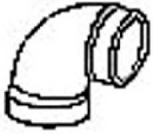
**RETAIL**  
\$4.28

**90deg. Street Ell**

**BHS#**  
274-985

**DESCRIPTION**  
NUTONE CF368 90deg STEET ELBOW; was  
368

**U/M**  
ea

**BOX**  
20

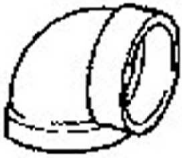
**RETAIL**  
\$2.48

**90deg. Sweep Ell**

**BHS#**  
274-1055

**DESCRIPTION**  
NUTONE CF382 90deg SWEEP ELBOW; was  
382

**U/M**  
ea

**BOX**  
20

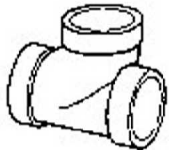
**RETAIL**  
\$2.02

**90deg. Tee**

**BHS#**  
274-1070

**DESCRIPTION**  
NUTONE CF383 90deg TEE; was 383

**U/M**  
ea

**BOX**  
20

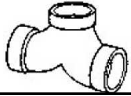
**RETAIL**  
\$3.86

**3 Way Ell**

**BHS#**  
274-1075

**DESCRIPTION**  
NUTONE CF384 3-WAY ELBOW; FOO; was  
384

**U/M**  
ea

**BOX**  
10

**RETAIL**  
\$6.72

**Stop Coupling**

**BHS#**  
274-1105

**DESCRIPTION**  
NUTONE CF388 STOP COUPLING; was 388

**U/M**  
ea

**BOX**  
40

**RETAIL**  
\$1.08

**Cap**

**BHS#**  
274-1110

**DESCRIPTION**  
NUTONE CF389 CAP; was 389; FOO

**U/M**  
ea

**BOX**  
10

**RETAIL**  
\$1.82

**Straight Flange**

**BHS#**  
274-965

**DESCRIPTION**  
NUTONE CF366 STRAIGHT FLANGE; FOO  
was 366

**U/M**  
ea

**BOX**  
10

**RETAIL**  
\$2.48

**VacPan Automatic Dustpan Inlet**

Automatic inlet installs in cabinet toe kick or baseboard. Activates vacuum system automatically with flip of toeswitch - allows you to sweep away dirt instantly. Ultimate convenience - no dust pans, no bending. Great for kitchens, baths, laundry rooms - wherever there is smooth flooring. Rough-in dimensions: 6 1/2" W x 4" D x 1 1/2" H, not including tubing.

**BHS#**  
274-928

**DESCRIPTION**  
NUTONE CI-365W AUTOMATIC DUST PAN

**U/M**  
ea

**BOX**  
6

**RETAIL**  
\$54.92

**VACUUM SYSTEMS, ROUGH-IN**  
**NUTONE BUILT-IN CENTRAL CLEANING SYSTEM**

**Dustpan Inlet Quick Trim - White**



Finish trim plate for front-entry access in installation of VacPan™ inlet. Overall size: 10 9/16" W x 4" H. Can be shortened to 3 1/2" or 3" on site.

BHS#	DESCRIPTION	U/M	BOX	RETAIL
274-929	NUTONE CI-366W QUIKTRIM VACPAN FINISH PLT; FOO	ea	6	\$6.46

**Automatic On/Off Wall Inlet**



Can be installed in wall or floor. Size: 3 3/4" W x 3" H x 5/8" D installed. Install with 361 mounting bracket.

BHS#	DESCRIPTION	U/M	BOX	RETAIL
274-920	NUTONE 360BG INLET; BEIGE	ea	20	\$18.86
274-927	NUTONE 360W INLET; WHITE	ea	20	\$18.86

**Supervalue Electrified Inlet**

No Illustration Available

BHS#	DESCRIPTION	U/M	BOX	RETAIL
274-1090	NUTONE CI-358IV DIRECT CONNECT WALL VALVE; FOO	ea	10	\$21.24
274-1092	NUTONE CI-358W DIRECT CONNECT WALL VALVE	ea	10	\$21.24

**Flexible Tubing 2" ID x 36"**



2" ID. x 36" L vinyl over steel wire, interwoven with nylon cord, can be cut to any length.

BHS#	DESCRIPTION	U/M	BOX	RETAIL
274-980	NUTONE CF367 36" FLEXIBLE TUBING; FOO; was 367	ea	6	\$15.20

**Metal Wall Cap**



Terminates exhaust discharge tube to outside. Size: 6 1/2" W x 6 1/2" H. Brown finish.

BHS#	DESCRIPTION	U/M	BOX	RETAIL
274-1135	NUTONE 393 WALL CAP	ea	6	\$11.28

**Muffler**



Optional muffler suggested to reduce air noise on CV series power units. Mounts conveniently to air exhaust outlet at power unit. Muffler included with Quiet Series Power Unit models CV850, CV750 and CV653.

BHS#	DESCRIPTION	U/M	BOX	RETAIL
274-1130	NUTONE 392 MUFFLER; was CF392	ea	1	\$25.90

**Nail Plate**



Nails to outside of stud to prevent accidental penetration of pipe.

BHS#	DESCRIPTION	U/M	BOX	RETAIL
274-1040	NUTONE 378 NAIL PLATE; FOO	ea	20	\$.84

**Solvent Cement**



Used for PVC connection. (Plastic to plastic only).

BHS#	DESCRIPTION	U/M	BOX	RETAIL
274-1045	NUTONE 379 CEMENT	ea	6	\$5.38

**PVC Tubing - 2" O.D. x 8 Ft Long**



Semi-rigid, exceptional tensile strength. Lightweight and easy to handle - can be cut easily with an ordinary saw. Installs vertically or horizontally without bending. Not affected by weather or moisture - won't rust or deteriorate. Self-extinguishing; will not support combustion. 2" OD. x 8': eight pieces - 64 ft.

BHS#	DESCRIPTION	U/M	BOX	RETAIL
274-1050	NUTONE 3808 PVC TUBING 8'0"	ea	8	\$9.88

**VACUUM SYSTEMS, ROUGH-IN**

**NUTONE BUILT-IN CENTRAL CLEANING SYSTEM**

**Replacement Bags - Pack of 3**



Set of three (3)  
 VX-3918: 8 gallon bag for use with VX550 and VX1000  
 VX-3916: 6 gallon bag for use with VX475  
 391: 6 gallon bag for use with CV350, CV352, CV353, CV450, CV653 & CV750

BHS#	DESCRIPTION	U/M	BOX	RETAIL
274-412	NUTONE VX3918 BAGS; 3/PACK	pk	6	\$67.46
274-1115	NUTONE 391 BAGS; 3/PACK (for the CV sieres)	pk	6	\$10.80
274-410	NUTONE VX3916 VACUUM BAGS; 3/pack	pk	6	\$15.72

**Rough-in Package for 3-inlet Installation**

**Suggested Rough-In and Pre-Installation Packages For New Construction**

**No Illustration Available**

3 ea. #361 Mounting Brackets, 3 ea. 362 90° Flange Ells, 1 ea. #368 90° Street Ell, 1 ea. #369 45° Street Ell, 1 ea. #376 UL Wire, 100', 18/2, 6 ea. #378 Nail Plates, 1 ea. #379 Solvent Cement, 6 ea. #382 90° Sweep Ells, 2 ea. #383 Tees, 3 ea. #385 45° Ells, 6 ea. #388 Stop Couplings.

BHS#	DESCRIPTION	U/M	BOX	RETAIL
274-1150	NUTONE 3963 ROUGH-IN PACKAGE	ea	1	\$86.10

**Rough-in Package to Expand 396-3 by 1 Additional Inlet**

**Suggested Rough-In and Pre-Installation Packages For New Construction**

**No Illustration Available**

1 ea. #361 Mounting Bracket, 1 ea. #362 90° Flange Ell, 1 ea. #368 90° Street Ell, 1 ea. #369 45° Street Ell, 2 ea. #378 Nail Plates, 2 ea. #382 90° Sweep Ells, 1 ea. #385 45° Ell, 1 ea. #387 45° Wye, 2 ea. #388 Stop Couplings.

BHS#	DESCRIPTION	U/M	BOX	RETAIL
274-1145	NUTONE 3961 ROUGH-IN PACKAGE	ea	1	\$26.24

**TARPS**

**FOREMOST TARPS**

**Blue Tarps**



BHS#	DESCRIPTION	U/M	BOX	RETAIL
114-689	FOREMOST 000689 6' X 8' BLUE TARP	ea	40	\$3.23
114-24364	FOREMOST 024364 24' X 36' BLUE TARP	ea	2	\$58.16

**White Tarps**



14 x 14 Cross weave fabric. 5.5 oz. per square yard. 12' x 20' tarp fits standard 10' x 20' portable shelter/canopy. Heavy Duty Industrial Polyethylene Material is laminated on both sides for maximum weatherproofing.

BHS#	DESCRIPTION	U/M	BOX	RETAIL
114-308105	FOREMOST 308105 8' X 10' WHITE TARP	ea	20	\$9.87
114-310122	FOREMOST 310122 10' X 12' WHITE TARP	ea	12	\$14.81
114-316209	FOREMOST 316209 16' X 20' WHITE TARP; FOO	ea	5	\$39.49
114-320305	FOREMOST 320305 20' X 30' WHITE TARP; FOO	ea	2	\$74.05

**Brown/Green Reversible Tarps**



BHS#	DESCRIPTION	U/M	BOX	RETAIL
114-108101	FOREMOST 108101 8' X 10' BRN/GRN TARP	ea	25	\$5.39
114-112160	FOREMOST 112160 12' X 16' BRN/GRN TARP	ea	10	\$12.93
114-116205	FOREMOST 116205 16' X 20' BRN/GRN TARP	ea	6	\$21.54
114-118247	FOREMOST 118247 18' X 24' BRN/GRN TARP; FOO	ea	5	\$29.08
114-110203	FOREMOST 110128 10' X 12' BRN/GRN TARP	ea	20	\$8.08

**TARPS**

**FOREMOST TARPS**

**Silver/Brown Reversible Tarps**

	<b>BHS#</b>	<b>DESCRIPTION</b>	<b>U/M</b>	<b>BOX</b>	<b>RETAIL</b>
	114-208108	FOREMOST 208108 8' X 10' SILVER TARP	ea	20	\$9.87
	114-210125	FOREMOST 210125 10' X 12' SILVER TARP	ea	12	\$14.81
	114-212167	FOREMOST 212167 12' X 16' SILVER TARP	ea	8	\$23.70
	114-216202	FOREMOST 216202 16' X 20' SILVER TARP	ea	5	\$39.49
	114-218244	FOREMOST 218244 18' X 24' SILVER TARP	ea	4	\$53.32
	114-220308	FOREMOST 220308 20' X 30' SILVER TARP	ea	2	\$74.05
	114-220408	FOREMOST 240603 40' X 60' SILVER TARP; FOO	ea	1	\$296.21

**PAPER BAGS**

**XPEDX PAPER BAGS**

**As Sold by Sleeve or Bale**



These strong, durable paper bags work excellent for tools and hardware. Self-opening style with strong seams. Made of extra super weight of natural brown kraft for heavy loads and items with sharp corners. **Call for pricing by the sleeve.**

<b>BHS#</b>	<b>DESCRIPTION</b>	<b>U/M</b>	<b>BOX</b>	<b>RETAIL</b>
304-40	XPEDX #5 SUPER GROCERY BAGS;	bl	4	\$109.16

**SAALFELD PAPER BAGS**

**As Sold by Bale**



These strong, durable paper bags work excellent for tools and hardware. Self-opening style with strong seams. Made of extra super weight of natural brown kraft, for heavy loads and items with sharp corners.

<b>BHS#</b>	<b>DESCRIPTION</b>	<b>U/M</b>	<b>BOX</b>	<b>RETAIL</b>
304-10	SAALFELD 2# KRAFT GROC BAGS 696306 (Sleeve=250); replaces XPEDX 2# 1NMF500002; AJM2BRNXHD	sl	12	\$12.10
304-40	SAALFELD 6# KRAFT GROC BAGS 710703 (Sleeve=500); repl XPEDX 1NMF500005; 590890	sl	4	\$19.65
304-100	SAALFELD 8# SUPER GROC BAGS 720477 (Sleeve=500; 2 sleeves in a bale); repl XPEDX 1NMF500008; 590875	sl	2	\$30.76
304-160	SAALFELD 12# SUPER GROC BAGS 710856 (Bale=500); repl. XPEDX 1NMF600012; 590894	bl	1	\$36.82
304-190	SAALFELD 20# KRAFT GROC BAGS 696318 (Sleeve=250); repl XPEDX 1NMF600020; AJM20BRNXHD	sl	2	\$37.01
304-210	SAALFELD 52# SUPER GROC BAGS 710652 (Bale=500); replaces; 35# XPEDX 1NMF5035ST; 590883	bl	1	\$58.92
304-220	SAALFELD 60# KRAFT CARRYSACK 710847 (Bale=500); repl. XPEDX 0NMF601217; 590879	bl	1	\$72.03

**PAPER, WRAPPING****XPEDX BROWN WRAPPING PAPER**

Made from pulp produced by a sulfate process, this paper wrapping works well for shipping, mailing, and packaging. 9" Diameter rolls in widths as shown, 60# kraft paper. 825 Feet.



<b>BHS#</b>	<b>DESCRIPTION</b>	<b>U/M</b>	<b>BOX</b>	<b>RETAIL</b>
304-310	XPEDX 60# 24" X 825' NK WRAP PAPER; 521209 BU0361	rl	1	\$45.70
304-330	XPEDX 60# 36" X 825' NK WRAP PAPER; 526106	rl	1	\$68.67