

PRINCESS AUTO



**ANY
JOB.
ANY
SEASON.**

FALL & WINTER 2011

ALL SEASONS
Seasonal • Farm
Outdoor Equipment
Recreational

TRAILER
Truck • Winch Centre
Cargo Control

WORKSHOP
Shop & Garage • Welding
Air Compressors & Tools
Power Tools • Hand Tools

DRIVELINE
Hydraulics
Driveline Components
Motors & Controls

SURPLUS
Always changing
Always unique



Shell Lubricants Available here

What's your perfect match?

Go to www.Shell.ca/Lubematch and find the ideal lubricant for your vehicle or machinery.
Princess Auto can special order all Shell oil products. Ask a team member for details.

Visit us today to maximize your system performance!



www.princessauto.com

Our goal is for you to have an outstanding shopping experience every time you visit us online, in our stores, or contact our National Call Centre.

PEOPLE

behind our Products & Services

Whether you're looking for advice on a project you're working on, or need help in choosing the right product, we want to ensure our team members have the expertise to provide you with all the answers to your questions.

That's why we invest heavily in the training and development of our Team Members. In-store training, outside programs and trips to our Winnipeg Home Office training centre enable our team members to expand their product knowledge and customer service skills on an ongoing basis.

We know that our people are the key to ensure your shopping experience at Princess Auto, is an outstanding one.



Home of an outstanding shopping experience, every time!

NEW LOOK

SAME GREAT SELECTION

ALL SEASONS

Seasonal	pg. 3
Farm	pg. 24
Outdoor Equipment	pg. 48
Recreational	pg. 57

TRAILER

Trailer	pg. 63
Truck	pg. 84
Winch Centre	pg. 93
Cargo Control	pg. 96

WORKSHOP

Shop and Garage	pg. 102
Air Compressors & Tools	pg. 131
Power Tools	pg. 150
Welding	pg. 166
Hand Tools	pg. 179

DRIVELINE

Hydraulics	pg. 242
Driveline Components	pg. 268
Motors and Controls	pg. 277

SURPLUS pg. 280



Search...

Here are 4 ways to narrow down your search:

Step 1:

Select your Category by colour:

- ALL SEASONS
- TRAILER
- WORKSHOP
- DRIVELINE
- SURPLUS

Step 2:

Refine your search:

- | | |
|-------------|---------|
| ALL SEASONS | pg. 3 |
| TRAILER | pg. 62 |
| WORKSHOP | pg. 101 |
| DRIVELINE | pg. 242 |

Step 3:

Go to your area of interest and select your page

Step 4:

Find an specific item through the newly expanded index

Pages 290 - 295



Seasonal	3 - 23
Garden Hose	18
Heaters & Accessories	3 - 7
Pet Heating Products	7
Pressure Washers, Chemicals & Accessories	20 - 23
Pumps & Accessories	12 - 18
Snow Products	8
Shop Wear & Gloves	9 - 12
Water Tanks & Filtration	19
Farm	24 - 48
Aircraft Cable, Rope & Accessories	45 - 48
Casters & Hardware	42 - 44
Electric Fencing & Accessories	34 - 36
Fans	30
Fuel Equipment	24 - 27
Grease Guns & Accessories	28 - 29
Lighting	31 - 32
Livestock Supplies	34
Security Locks	32 - 33
Shovels, Hoes, Squeegees & Brooms	37 - 39
Tarps & Accessories	39 - 41

Outdoor Equipment	48 - 56
3-Point Hitch Hardware	52 - 53
ATV / Lawn Tractor Implements	54
Generators	48 - 49
Log Splitters	54 - 56
Solar Panels & Accessories	50 - 51
Tractor Seats	52
Recreational	57 - 61
Food Processing	60 - 61
Power Sports Accessories	58 - 59
Recreational Equipment	57

Seasonal

Unit Heaters



- A) 8 pc 3" Vertical Vent Kit**
For 45,000 BTU model only
8065831 – Wt. 11.4 lb **129⁹⁹**
- B) 7 pc 4" Horizontal Vent Kit**
8208373 – Wt. 13.0 lb **139⁹⁹**



- 24V Thermostat**
- Allows user to set desired comfort setting of unit heater so manual temperature adjustment is not necessary
 - For use with 8165799 and 8164683 heaters
- 8065856 – Wt. 0.3 lb... **39⁹⁹**



Natural Gas Shop Heater

- Quiet operation
- Power exhaust allows for vertical or horizontal venting from left or right side
- Tubular heat exchanger for maximum efficiency and longer life
- Spark ignition features self-diagnostic control module
- 3-year warranty on parts and burner, 10-year warranty on heat exchanger
- Heats up to 700 sq ft
- Low profile design
- Cabinet size: 18" w x 25" d x 12" h
- Requires 3" vertical (#8065831) or 4" horizontal (#8208373) vent kit
- Thermostat also available, sold separately (#8065856)

- 45,000 BTU**
8065799 – Wt. 66.5 lb **699⁹⁹**
- 75,000 BTU**
8164683 – Wt. 89.0 lb **799⁹⁹**



THE ORIGINAL 
Mr. Heater[®]

- Radiant Propane Heaters
- Tank Top Heaters
- Directional Radiant Heaters
- Convection Propane Heaters
- Electric Heaters
- Propane & Kerosene Forced Air Heaters
- Propane & Natural Gas Unit Heaters
- Propane Torches

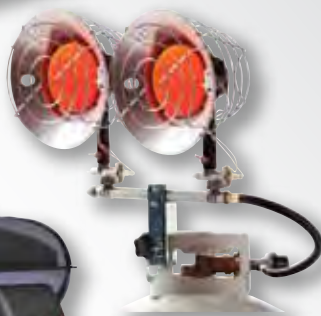

Cut the cord and turn down the noise.

Designing the WORLD'S FIRST cordless forced air propane heater that delivers up to 8 full hours of warmth from an internal rechargeable battery was just the start.

Add 35,000 BTU of heat for instant comfort anywhere, any time – QBT™ Burner Technology that's 50% quieter than any other forced air heater – the option to run plugged to power – and a 5-hour recharge, even while it's running, and you have the most versatile heater ever conceived.

The Mr. Heater Hero. Now Cold has Nowhere to Hide.



Powerful. Quiet. Cordless.
 35,000 BTU/HR PORTABLE PROPANE FORCED AIR HEATER // MULTIPLE PATENTS PENDING
WWW.MRHEATERHERO.COM



35,000 BTU Portable Propane Heater

- Heats up to 800 sq. ft for up to 12 hours on a 20 lb propane tank (not included)
- Consumes up to 1.6 lb/hr. of propane
- Piezo push-button ignition
- Heater shuts off with loss of flame or tip over
- Folding handle and transport wheels

8007150 – Wt. 23.3 lb **199⁹⁹**



Tank Top Heaters

- Heater shuts off automatically with loss of flame
- Mounts directly to propane tank (not included)

A) Single Element

- 3 heat settings: 8, 12 & 14,000 BTU
- 30 to 52 hours on 20 lb tank

8336331 – Wt. 3.3 lb **79⁹⁹**

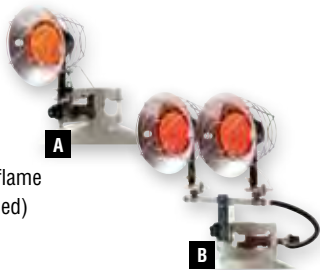

B) Double Element

- 6 heat settings: 8, 12, 14, 16, 24 & 28,000 BTU
- Up to 15 hours (at Hi) on a 20 lb tank

8336364 – Wt. 8.4 lb **129⁹⁹**



Buddy Heaters Propane Filter

- Helps protect your Buddy Heater from propane hose and propane tank contaminants
- For use with Buddy Heaters (8270720 & 8172462)

8124315 – Wt. 0.6 lb... **11⁹⁹**



Propane Hose Assemblies

For 5 to 20 lb tanks with hand tightening knob on one end

5 ft
8008633 – Wt. 0.9 lb... **24⁹⁹**

12 ft
8008567 – Wt. 1.7 lb... **34⁹⁹**



Optional A/C Power Adapter

Power supply for the Big Buddy Heater
8175663 – Wt. 0.6 lb... **19⁹⁹**



Propane Tank Stabilizer

Fits 20 lb, 30 lb and 40 lb cylinders

8292278 – Wt. 0.9 lb **9⁹⁹**



Gas Approved Thread Tape

- Extra thick premium tape
- Safe for air, gasoline and compressed gases
- 1/2" x 20 ft

6050054 – Wt. 0.1 lb **4⁴⁹**



16,000 to 41,000 BTU Floor-Type Patio Heater

- Stainless steel body
- Upside-down switch and safety shut-off device
- Piezo electric ignition
- Propane or butane
- Adjustable heat output

8331605 – Wt. 38.3 lb **199⁹⁹**

Radiant Heaters

Buddy Heaters

- Quiet, odour-free and lightweight
- No electricity required
- Piezo push-button ignition
- Low oxygen and tip-over shut-off system

C) Little Buddy Heater

- 3,800 BTU
- Heats up to 200 square feet
- Large easy grip handle
- Separate ON / OFF push buttons
- Fits directly on 1 lb propane bottle (not included), 5-1/2 hour run time
- Ideal for camping and cottage

8208472 – Wt. 6.2 lb **79⁹⁹**



D) Portable Buddy Heater

- 4,000 to 9,000 BTU, heats up to 200 sq. ft
- 3 to 6 hours on 1 lb tank, 48 to 110 hours on 20 lb tank

8270720 – Wt. 10.6 lb **129⁹⁹**

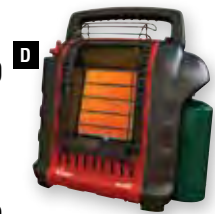

E) Big Buddy Heater

- 4,000 to 18,000 BTU, heats up to 400 sq. ft
- Uses two 1 lb cylinders (3 to 12 hours) or two 20 lb cylinders (50 to 220 hours) propane cylinders with optional hose connection
- Optional A/C adapter available (8175663)
- Use 4 "D" cell batteries to power blower fan

8172462 – Wt. 18.7 lb **189⁹⁹**



Forced Air Heaters



Forced Air Propane Heaters

- Heavy duty high output fan
- Heater shuts off with loss of flame or power supply
- 10 ft hose, POL and regulator included
- Propane tanks not included



BTU	Heat	Ignition	Height Control	Thermostat	Min. Tank Size	Consumption	CFM	Wt. (lb)	ITEM	PRICE
35,000	Up to 800 sq. ft	Piezo	No	No	20 lb	1.6 lb/hr	100	14.4	8264517	139.99
30 - 60,000	Up to 1,250 sq. ft	Continuous	Adjustable	No	20 lb	1.2 to 2.1 lb/hr	300	16.8	8264533	189.99
75 - 125,000	Up to 3,000 sq. ft	Continuous	Adjustable	No	40 lb	3.5 to 5.8 lb/hr	350	21.2	8264541	229.99
125 - 175,000	Up to 4,000 sq. ft	Solid State	Adjustable	Built-in	100 lb	5.8 to 7.9 lb/hr	450	26.7	8264558	379.99



Forced Air Kerosene Heaters

- Heavy duty high output fan
- Continuous ignition

BTU	Heat	Consumption	Tank Size	Thermostat	Wt. (lb)	ITEM	PRICE
60,000	1,250 sq. ft	1.2 to 2.08 litre/hr.	11 hours/15.1 L (4 gal.) tank	No	43.0	8264392	239.99
75,000	1,750 sq. ft	2.1 litre/hr	11 hours/22.7 L (6 gal.) tank	Built-in	38.7	8264442	279.99



Kerosene

For kerosene heaters, catalytic stoves, and wick oil lamps

6480123
Wt. 18.0 lb **24⁹⁹**



Convection Heaters



Convection Propane Heaters

- No electricity required
- Standing pilot with piezo push button ignitor for safety
- 10 ft hose and POL fitting included

30,000 to 80,000 BTU

• Heats approximately 1,900 sq. ft for up to 14 hours on a 20 lb propane tank (not included)

- 1.4 to 3.7 lb/hour fuel consumption

8000985 – Wt. 18.4 lb **169⁹⁹**

75,000 to 200,000 BTU

• Heats approximately 4,700 sq. ft for up to 29 hours on a 100 lb propane tank (not included)

- 3.5 to 9.3 lb/hr fuel consumption

8000988 – Wt. 19.6 lb **189⁹⁹**



Cordless Forced Air Propane Heater

- 35,000 BTU
- Built in rechargeable battery
- Heats up to 800 sq ft
- 50% quieter than a standard FALP heater

8387136 – Wt. 17.0 lb **229⁹⁹**



ELECTRIC HEATERS

Cabinet Infrared Heater

- Heats rooms up to 1,000 sq. ft
- Turn unit ON / OFF, adjust temperature and heating time with convenient remote control
- Temperature range: 10 to 30°C (59 to 86°F)
- 1,500W (high), 750W (low); 120V, 60 Hz
- Time adjustment range: 0.5 to 8 hours

Cherry (shown)

8369985 – Wt. 44.3 lb



Oak

8377111 – Wt. 44.3 lb **199⁹⁹** /ea



Construction Heaters

- 160 CFM
- 240 V, 4,800 W
- 6 ft grounded 30A cord

Without Enclosed Motor (shown)

O'all dim.: 13.25" h x 8.7" w x 9.7" d
8398240 – Wt. 10.5 lb **99⁹⁹**

With Enclosed Motor

O'all dim.: 13.8" h x 9.25" w x 10.5" d
8398273 – Wt. 11.9 lb **129⁹⁹**



A) Heater Fan

- 750 / 1500W
- Adjustable thermostat
- Stay cool body with moulded handle

8387243 – Wt. 2.7 lb **24⁹⁹**

B) Oscillating Radiant Dish Heater

- 2 heat settings - 700/100 watts
- 70° oscillation
- Adjustable horizontal tilt

8387227 – Wt. 7.5 lb **39⁹⁹**

Honeywell

C) 1,500W Ceramic Pro Series Heater

- 2 heat settings
- Adjustable thermostat for total comfort control

8325359 – Wt. 6.7 lb **49⁹⁹**

D) Oscillating Heater Tower with Remote

8325268 – Wt. 8.9 lb **59⁹⁹**

Honeywell

E) 1,500W Electric Heater

8174393 – Wt. 8.6 lb **49⁹⁹**

Honeywell

F) Cool Touch Digital Heater

- Smart energy plus technology - initial intense heat boost to warm you up, and automatically shifts to Energy Saver mode after 1 hr while keeping you warm

• Digital controls
• Oscillating
8325334 – Wt. 5.9 lb **59⁹⁹**

G) Overhead Radiant Heater

- Capable of warming a 14 ft x 14 ft area (200 sq ft)
- 2 settings: 750W and 1,500W
- Directional 25W halogen lamp
- 120V, 12.5A
- Ceiling or wall mount

8226979 – Wt. 7.5 lb **69⁹⁹**

NEW Honeywell®

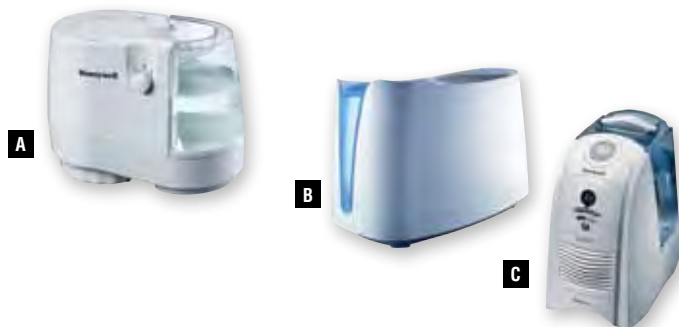

A) 2 Gallon Natural Cool Humidifier

- Automatic moisture balance system
- Antimicrobial treated filter
- 3 year limited warranty

8326217 – Wt. 6.1 lb. **29⁹⁹**

B) 2 Gallon Germ Free Humidifier

- Kills up to 99.9% of bacteria
- Patented germicidal chamber

8326308 – Wt. 9.8 lb. **59⁹⁹**

C) 4 Gallon QuickSteam Humidifier

- QuickSteam technology instantly provides bacteria-free vapour
- Runs up to 3 times faster than other warm mist humidifiers
- New EasySet digital controls
- 3 moisture output settings
- Automatic shut-off for added safety
- Timer function - up to 18 hrs

8326274 – Wt. 7.7 lb. **79⁹⁹**

Pet Heating

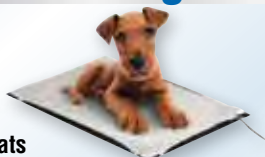

Heated Pet Mats

- Durable weather-resistant ABS plastic mat
- Regulates pet's body temperature automatically
- On at 39°C (102°F), off at 42°C (108°F)
- 5 ft long power cord with 3-prong grounded plug and anti-chew cord protector
- Use indoor or outdoors
- Includes washable fleece cover

13" x 19" 8223059 – Wt. 3.1 lb. **69⁹⁹**

17" x 24" 8134108 – Wt. 5.4 lb. **79⁹⁹**

24" x 29" 8171886 – Wt. 9.6 lb. **99⁹⁹**



Floating Tank De-Icer

- Thermostatically controlled to operate only when necessary
- Heavy duty anti-chew cord protector

D) 1,000W - Not for plastic 8079139 – Wt. 1.9 lb. **29⁹⁹**

E) 1,250W - Safe in plastic 8017184 – Wt. 3.2 lb. **44⁹⁹**

Water Heating

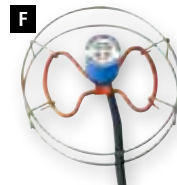

Submersible Tank De-Icer

- Constructed of cast aluminum for ultimate efficiency and safety
- Thermostatically controlled to operate only when necessary
- Heavy duty anti-chew cord protector
- SAFE IN PLASTIC

F) 1,000W 8079162 – Wt. 2.4 lb. **34⁹⁹**

G) 1,500W 8016210 – Wt. 3.1 lb. **69⁹⁹**

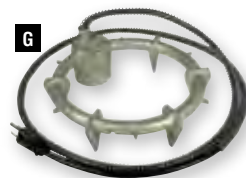

L) Heated Pet Bowl

- Only operates as necessary when temperatures reach freezing to reduce operating costs
- Sturdy twin wall anti-tip construction
- Heavy duty anti-chew cord protector

950 ml 8134090 – Wt. 1.3 lb. **24⁹⁹**

5.5 Litre 8079170 – Wt. 2.0 lb. **29⁹⁹**

M) Stainless Steel Heated Pet Dish

- Built-in thermostat to control the water temperature: on at 1.5°C (35°F) and off at 7°C (45°F)
- Only operates as necessary when temperatures reach freezing to reduce operating costs
- Heavy duty anti-chew cord protector

2.8 Litre 8223067 – Wt. 2.4 lb. **39⁹⁹**

5.5 Litre 8179087 – Wt. 3.4 lb. **49⁹⁹**



Heated Buckets

- Thermostatically controlled to operate only when necessary
- Heavy duty bail with reinforced connectors
- Table of measurements

H) 8 Litre (2 Gal) 8001030 – Wt. 2.7 lb. **39⁹⁹**

I) 19 Litre (5 Gal) 8001029 – Wt. 5.0 lb. **54⁹⁹**

J) 60 Litre (16 Gal) 8001031 – Wt. 6.9 lb. **84⁹⁹**

K) Heated Rubber Buckets

- 19 litre capacity, 150W
- Thermostatically controlled to operate only when necessary
- Bail allows buckets to be hung in stall
- Cord comes out of the side - unnoticed by animals

8019823 – Wt. 7.1 lb. **59⁹⁹**

Snow Shovels



A) Emergency Snow Shovel
8171795 – Wt. 1.1 lb..... **8⁹⁹**

B) Telescoping Snow Shovel
• Collapses for convenient storage
• Heavy duty poly blade: 9.8" x 12.2"
• Comfortable D-handle
• Expands from 30" to 38"
8218349 – Wt. 1.3 lb..... **9⁹⁹**

C) 21" Poly Snow Shovel
• 21" wide x 12" tall deep rib blade
• D-handle grip
8215873 – Wt. 3.3 lb..... **11⁹⁹**

D) 13" All Purpose Shovel
Poly blade, steel ergo shaft, ergo handle
8391716 – Wt. 3.2 lb..... **16⁹⁹**

E) 18" Ergonomic Snow Scoop
• Contractor grade
• Rust resistant powder coated steel tube with ergonomic D-handle
• 18" x 13" polypropylene blade with metal edge
8218331 – Wt. 3.9 lb..... **16⁹⁹**

F) 18" Combo Shovel
8391732 – Wt. 3.3 lb..... **19⁹⁹**

G) 26" Pusher Shovel
8391724 – Wt. 3.6 lb..... **21⁹⁹**



H) Kids Snow Shovel
Assorted colours
8285876 – Wt. 0.9 lb..... **8⁹⁹**

I) Kids Snowpusher
• Poly blade
• 33-3/4" total length
• Assorted colours
8286593 – Wt. 1.5 lb..... **8⁹⁹**

J) Foldable Emergency Snow Shovel
• PVC
• Multiple grips for optimal hand placement and comfort
• Blade offers 150 square inches of coverage
8340853 – Wt. 2.0 lb..... **11⁹⁹**

K) 18" Yukon Snow Shovel
8284788 – Wt. 3.2 lb..... **29⁹⁹**

L) 24" Snow Shovel
Ergonomic handle
8340846 – Wt. 5.7 lb..... **39⁹⁹**

M) 36" Yukon Snow Pusher
Poly blade with ergonomic handle
8392243 – Wt. 7.5 lb..... **39⁹⁹**

Snow Brushes

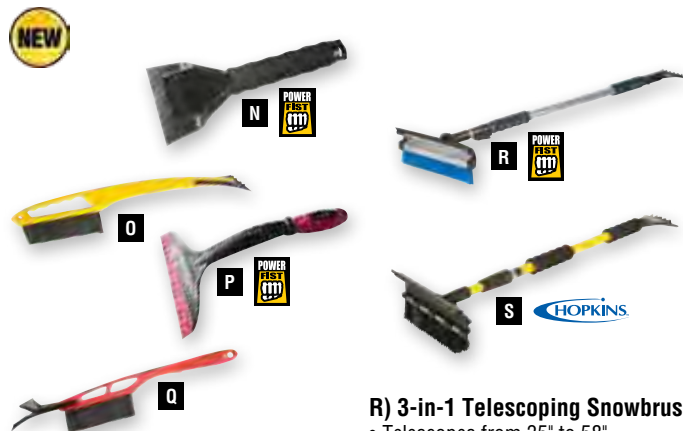

N) Snow Scraper / Chisel
8171811 – Wt. 0.3 lb..... **1⁹⁹**

O) 20" Snow Brush with Ice Scraper
8208886 – Wt. 0.5 lb..... **2⁹⁹**

P) Snow Scraper
8214694 – Wt. 0.2 lb..... **3⁹⁹**

Q) Snow Brush and Scraper
8217580 – Wt. 0.5 lb..... **4⁹⁹**

R) 3-in-1 Telescoping Snowbrush
• Telescopes from 35" to 58"
• Multi-position locking head for versatility and easy storage
8171803 – Wt. 1.4 lb..... **12⁹⁹**

S) 48" Extender Snowbroom
• 7 1/2" snowbroom with removable squeegee
• 4" scraper blade
• Heavy duty steel pole
• Foam grips
8340861 – Wt. 1.1 lb..... **12⁹⁹**

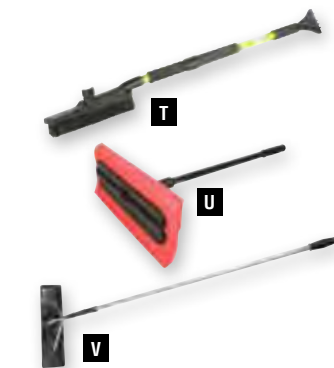

T) Monster Snowbrush
• 60" long when fully extended
• Changeable brush position
8299232 – Wt. 2.0 lb..... **19⁹⁹**

U) Arctic Plow Scraper
• Telescopic handle extends to 51"
• 16" wide foam head
8299240 – Wt. 2.0 lb..... **21⁹⁹**

V) Roof Snow Scraper
• Aluminum handle telescopes from 6 ft 4" to 21 ft
• Polycarbonate and ABS composite blade: 24.8" x 5.9"
8218356 – Wt. 6.0 lb..... **39⁹⁹**

NEW Breast Cancer partner: 10% of all sales to be donated to The Canadian Breast Cancer Foundation



Pink Snow Tools
W) 12" Scraper
• 4" flexible blade
• Foam grip for added comfort
• Plastic body
8340903 – Wt. 0.2 lb..... **4⁹⁹**

X) 24" Snow Brush
• 3 rows of bristles
• 4" flexible scraper
• Foam grip for added comfort
• Plastic and aluminum body
8340911 – Wt. 0.6 lb..... **9⁹⁹**



Lined Rubber Boots

- Waterproof with adjustable nylon collar
- Removable Thermal Guard liner

Size	Wt. (lb)	ITEM	PRICE
9	4.5	8325748	39.99
10	4.6	8325755	39.99
11	4.7	8325763	39.99
12	4.8	8325771	39.99



Safety Work Boots

- CSA type one steel toe and plate
- Lightweight and durable

Size	Wt. (lb)	ITEM	PRICE
8	3.7	8321580	79.99
9	3.8	8321606	79.99
10	5.0	8321614	79.99
11	4.2	8321622	79.99
12	4.4	8321630	79.99
13	4.4	8321648	79.99



A) Disposable Coveralls

- Elastic on wrist and ankle
- Polypropylene material

40g
8307662 – Wt. 0.3 lb **2⁹⁹**

60g
8307670 – Wt. 0.4 lb **4⁹⁹**

B) Shop Coats

Covered front button closure
Wt. 1.6 lb

8183352 – Medium

8183394 – Large

8183402 – XL **29⁹⁹** /ea

Shop Wear



C) Coveralls

- Loss-proof front pocket
- 2 rear patch pockets

Wt. 2.4 lb

8334468 – Medium

8334476 – Large

8334484 – XL **39⁹⁹** /ea

8334492 – XXL **42⁹⁹**

D) Overalls

- Elasticized adjustable shoulder straps
- Multi pocket design

Wt. 2.6 lb

8334518 – Medium

8334526 – Large

8334534 – XL **39⁹⁹** /ea

8334542 – XXL **42⁹⁹**



Large Shoe Cleats

Non-slip traction for snow and ice

Size L

8076218 – Wt. 0.4 lb

Size XL

8076234 – Wt. 0.5 lb... **5⁹⁹** /pr

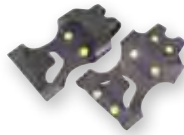

2 pk Hand Warmers

Provides up to 8 hours of continuous warmth

8082554 – Wt. 0.1 lb **99¢**

Body Warmer

Provides up to 20 hours of continuous warmth

8086530 – Wt. 0.1 lb **99¢**

2 pk Toe Warmer

Provides up to 5 hours of continuous warmth

8086548 – Wt. 0.1 lb **1⁴⁹**

E) Quilt Lined Flannel Shirt

Wt. 2.5 lb

8391401 – Large

8391419 – XL

8391427 – XXL **24⁹⁹** /ea

F) Pile Lined Fleece Shirt

- Covered zipper front

- Assorted sizes

(M to XXL) and colours

8210528 – Wt. 1.9 lb **24⁹⁹**

G) Polar Fleece Shirt with Zipper

Polar fleece jacket with

boa lining and zipper

8267858 – Wt. 2.8 lb **24⁹⁹**



H) Quilted Freezer Jackets

Wt. 2.5 lb

8351736 – Large

8351744 – XL **29⁹⁹** /ea

8351751 – XXL **32⁹⁹**

I) Jersey Bomber Hoodies

Wt. 3.0 lb

8391369 – Large

8391385 – XL **49⁹⁹** /ea

8391393 – XXL **54⁹⁹**

J) Zip-Off Sleeve Jackets

Wt. 3.0 lb

8391278 – Large

8391286 – XL **69⁹⁹** /ea

8391294 – XXL **74⁹⁹**



Winter Head Wear

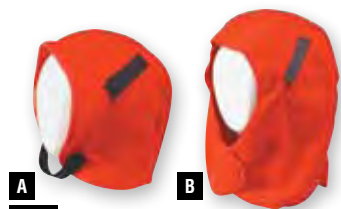

Headband
Black (shown)
 8266280 – Wt. 0.1 lb
Orange
 8266298 – Wt. 0.1 lb..... **3⁹⁹** /ea



Fleece Hard Hat Liners

A) Small
 8084048 – Wt. 0.1 lb
B) Large
 8084055 – Wt. 0.1 lb..... **2⁹⁹** /ea

Hats
 8250342 – Black
 8250367 – Navy
 8250391 – Brown
 Wt. 0.1 lb..... **4⁹⁹** /ea



J) Fur Trim Hat
 8267288 – Wt. 0.4 lb..... **11⁹⁹**

Trapper Hats

K) Black
 8296923 – Wt. 0.5 lb
L) On the Pond Hockey
 8296907 – Wt. 0.5 lb
M) Dobby Snowflake
 8392250 – Wt. 0.5 lb..... **2⁹⁹** /ea

N) Farmers Feed Families Canadian Backwood Canvas
Camo / Black (shown)
 8392268 – Wt. 0.5 lb
Tan / Black
 8392276 – Wt. 0.5 lb..... **2⁹⁹** /ea
O) Tough Duck Aviator Hat
Black (shown)
 8334682 – Wt. 0.4 lb
Brown
 8334708 – Wt. 0.4 lb..... **2⁹⁹** /ea



Toques

C) Fleece Lined
 8260911 – Wt. 0.2 lb
D) Black and White
 8314726 – Wt. 0.2 lb
E) Brown
 8314734 – Wt. 0.2 lb
F) Camouflage
 8260879 – Wt. 0.1 lb..... **4⁹⁹** /ea
G) Green
 8260887 – Wt. 0.1 lb
H) Black and Brown
 8260903 – Wt. 0.2 lb..... **5⁹⁹** /ea
I) Thinsulate™ Lined Toques
Black
 8033714 – Wt. 0.2 lb
Orange
 8181364 – Wt. 0.2 lb..... **5⁹⁹** /ea
Beige (shown)
 8125833 – Wt. 0.3 lb..... **6⁹⁹**



Thinsulate™ Balaclavas

P) 1-Hole
Black (shown)
 8181422 – Wt. 0.2 lb
Orange
 8181430 – Wt. 0.2 lb
Q) 3-Hole
 8181398 – Wt. 0.2 lb..... **5⁹⁹** /ea
R) Black Fleece
 8266306 – Wt. 0.1 lb
S) Black (shown)
 8314668 – Wt. 0.2 lb
Grey
 8314692 – Wt. 0.2 lb..... **5⁹⁹** /ea
T) Camo (shown)
 8260929 – Wt. 0.3 lb..... **6⁹⁹**

Winter Gloves



HORIZON
Snowmobile Mitts
U) Pile Lined
 Gauntlet cuff with adjustable wrist strap
 8176679 – Wt. 0.9 lb..... **11⁹⁹**
V) Black Leather
 8326910 – Wt. 0.5 lb
W) Black / Yellow Leather
 8328601 – Wt. 0.5 lb..... **2⁹⁹** /pr

Snowmobile Gloves
X) Black Leather
 8326928 – Wt. 0.5 lb
Y) Black / Yellow Leather
 8328619 – Wt. 0.5 lb..... **2⁹⁹** /pr
Leather Mitts
Z) Pile Lined Split
 5050006 – Wt. 0.5 lb..... **9⁹⁹**
1) Pile Lined
 8078826 – Wt. 0.4 lb..... **16⁹⁹**

WATSON
 GLOVES
 Quality since 1918

2) Winter Whammy Glove
 8351843 – Wt. 0.6 lb..... **3⁹⁹**
3) North Paws Thinsulate Lined Work Gloves
 8324188 – Wt. 0.7 lb..... **9⁹⁹**
4) Big Kahuna Heavy Duty Lined Work Gloves
 8324204 – Wt. 0.9 lb..... **19⁹⁹**



- A) Jersey Fleece Gloves**
8006344 – Wt. 0.2 lb. **3⁹⁹**
- B) Jersey Gloves**
Assorted colours
8001120 – Wt. 0.3 lb. **5⁹⁹**
- C) Cowhide Leather Work Gloves**
Foam and fleece lined
5050071 – Wt. 0.5 lb. **5⁹⁹**
- D) Water Barrier Cowsplit Gloves**
8006838 – Wt. 0.5 lb. **7⁹⁹**
- E) Thinsulate Leather Gloves**
C100 Thinsulate lined
deerskin leather driver glove
Size L
8326944 – Wt. 0.3 lb
Size XL
8326951 – Wt. 0.4 lb. **16⁹⁹** /pr
- F) Large Lined Antivibration Mechanics Gloves**
Gel padded palm
8078800 – Wt. 0.3 lb. **19⁹⁹**

- M) Rubber Palm Gloves**
Brushed poly fleece lining
8078784 – Wt. 0.3 lb. **4⁹⁹**
- N) Nitrile Pile Lined Gloves**
8078818 – Wt. 0.4 lb. **8⁹⁹**
- O) 12" PVC Gloves**
• Fleece lined
• Oil, grease and solvent resistant
5050001 – Wt. 0.7 lb. **8⁹⁹**



- W) 3 Pair Nitrile Dipped Gloves**
8372252 – Wt. 0.4 lb. **4⁹⁹**
- X) 3 Pair Nitrile Dipped Gloves**
8200107 – Wt. 0.3 lb. **4⁹⁹**



Looking for the perfect gift?
GIFT CARDS
are available at any Princess Auto location

Work Gloves



- G) Nitrile Gloves**
• Powder free
• Extra durable, 3 times stronger than latex or vinyl
10 pk
8166076 – Wt. 0.2 lb. **2⁹⁹**
- H) 100 Large Vinyl Gloves**
Lightly powdered with anti-bacterial formulation
8190258 – Wt. 1.3 lb. **8⁹⁹**
- I) 100 pk Grease Monkey Large**
8397309 – Wt. 1.4 lb. **19⁹⁹**
- J) 50 pk Black Heavy Duty Nitrile Gloves**
Superior abrasive and puncture resistance
Large
8260226 – Wt. 1.4 lb
X-Large
8373136 – Wt. 1.7 lb. **19⁹⁹** /pk
- K) 50 pk Heavy Duty Latex Gloves**
8064750 – Wt. 2.1 lb. **19⁹⁹**
- L) Magnetic Box Holder**
Holds a box of gloves or tissues
8245094 – Wt. 2.0 lb. **9⁹⁹**



- P) Fully Dipped Nitrile Gloves**
8004729 – Wt. 0.3 lb. **3⁹⁹**
- Q) PVC Dipped Gloves with Knitted Wrist**
8004732 – Wt. 0.3 lb. **3⁹⁹**
- R) Rubber Coated Palm Gloves**
8193971 – Small
8004874 – Large
Wt. 0.2 lb. **4⁹⁹** /pr
- S) 3/4 Dipped Nitrile Gloves**
8162109 – Wt. 0.1 lb. **4⁹⁹**
- T) 14" PVC Coated Gauntlet Gloves**
8004829 – Wt. 0.6 lb. **4⁹⁹**
- U) Rubber Coated Gloves**
8004873 – Wt. 0.4 lb. **4⁹⁹**
- V) PVC Palm Gloves**
8075780 – Wt. 0.3 lb. **5⁹⁹**



HORIZON

W.L. wells lamont

Leather Work Gloves

- A) Children's Cowhide Leather Gloves**
5050083 – Wt. 0.2 lb **3⁹⁹**
- B) Cowsplit Leather Work Gloves**
5050034 – Wt. 0.4 lb **3⁹⁹**
- C) Cowhide Work Gloves**
Small
8082489 – Wt. 0.3 lb **7⁹⁹**
- D) 4 Pair Cowsplit Gloves**
8166084 – Wt. 1.1 lb **7⁹⁹**
- E) Grain Leather Work Gloves**
8082505 – Wt. 0.5 lb **9⁹⁹**
- F) Driving / Ranching Gloves**
8004822 – Large
8004825 – XL
Wt. 0.4 lb **12⁹⁹ /pr**
- G) Split Leather Gloves**
Large
8001103 – Wt. 0.3 lb **12⁹⁹**
- H) C100 Thinsulate Lined Deerskin Gloves**
8179863 – Wt. 0.4 lb **12⁹⁹**
- I) Thinsulate Lined Gloves**
8176687 – Wt. 0.3 lb **19⁹⁹**
- J) 12 Pair Split Leather Work Gloves**
8004872 – Wt. 3.7 lb **24⁹⁹**



HORIZON

Cloth Work Gloves

- K) Brown Jersey Gloves**
8004856 – Wt. 0.1 lb **1⁹⁹**
- L) Rubber Crisscross Gloves**
8058596 – Wt. 0.3 lb **2⁹⁹**
- M) 6 Pair White Cotton Gloves**
8004864 – Wt. 0.6 lb **5⁹⁹**
- N) 12 Pair Cotton / Poly Knit Gloves**
8074619 – Wt. 1.2 lb **7⁹⁹**

W.L. wells lamont

O) Stretch Fabric Gloves

- Medium**
8001108 – Wt. 0.2 lb
- Large**
8001109 – Wt. 0.3 lb **9⁹⁹ /pr**

P) Mechanic's Gloves

- Assorted colours
- Medium**
8006872 – Wt. 0.2 lb
- Large**
8006875 – Wt. 0.2 lb **16⁹⁹ /pr**



Welcome to our Unique World!



Home of an outstanding shopping experience, every time!

Submersible Pumps

NEW

BURCAM

Emergency 12V Sump Pump

- Takes over sump action in case of power failure or primary sump pump failure
 - Automatic start-stop cycle
 - Primary pump, marine battery and piping not included
- 8371809 – Wt. 9.2 lb **199⁹⁹**



POWER FIRST

1/3 HP Column Sump Pump

- 115V, 60 Hz motor with thermal protection
 - Top mount switch automatically actuated by thermo-plastic float
 - PVC plastic column for corrosion-free operation
 - 1-1/4" NPT discharge
 - 6 ft power cord
 - Impeller, open trash design, handles liquid
 - GPH @ head: 1,000 @ 20 ft; 1,550 @ 15 ft; 2,400 @ 10 ft; 2,850 @ 5 ft
- 8003416 – Wt. 15.6 lb **69⁹⁹**

PEAK VS NET HORSEPOWER RATINGS

Princess Auto advertises our engines in peak or gross horsepower which is different than actual net HP ratings. The net horsepower is defined as the measured output of the engine at the crankshaft end which would also be defined as the true horsepower of the engine.

The peak or gross horsepower would be the horsepower the engine would produce working at peak efficiency in relatively idealistic atmospheric conditions.

In all cases the net horsepower should be less than the peak / gross horsepower.





■ Burcam
 ■ Little Giant
 ■ PowerFist

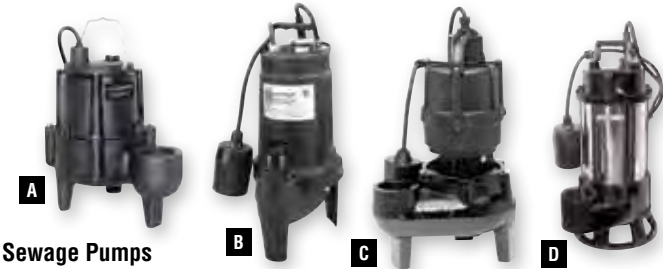

Sewage Pumps

- Tethered float
- 2" NPT outlet

	GPH @ Head	HP	Features	Wt. (lb)	ITEM	PRICE
A	4,800 GPH @ 5 ft, 3,000 GPH @ 10 ft, 960 GPH @ 15 ft	4/10	Noryl impeller, cast iron body	40.5	8307399	349.99
B	3,000 GPH @ 5 ft, 2,760 GPH @ 10 ft, 2,520 GPH @ 15 ft	1/2	Cast iron impeller, Cast iron pump body	34.2	8184939	199.99
C	4,500 GPH @ 5 ft, 3,120 GPH @ 10 ft, 720 GPH @ 15 ft	1/2	Noryl impeller, Cast iron pump body	29.1	8038205	249.99
D	4,200 @ 5 ft, 3,300 @ 10 ft, 2,400 @ 15 ft	3/4	Cast iron grinder impeller, stainless steel housing	40.1	8307316	399.99



Moving water at an affordable price is our business



8038152

Protect your basement
This alarm alerts you when the water reaches a critical level.



8307324

Empty your sump quietly and rapidly
Install a high capacity 1/2 HP submersible pump.

PRINCESS AUTO

carries a wide selection of Burcam pumps and accessories.



Submersible Sump Pumps

	GPH @ Head	HP	Switch	Features	NPT Outlet	Wt. (lb)	ITEM	PRICE
E	1,000 @ 15 ft, 1,500 @ 10 ft, 1,850 @ 5 ft, 2,150 @ 0 ft	1/4	Tethered float	Polypropylene housing	1", 1-1/4"	10.6	8259103	79.99
	700 @ 15 ft, 1,800 @ 10 ft, 2,150 @ 5 ft, 2,450 @ 0 ft	1/3	Tethered float	Polypropylene housing	1", 1-1/4"	11.2	8259137	99.99
F	1,450 @ 18 ft, 2,000 @ 15 ft, 2,500 @ 10 ft, 3,000 @ 5 ft	1/3	Tethered float	Noryl impeller	1-1/2"	9.0	8038036	119.99
G	700 @ 15 ft, 1,800 @ 10 ft, 2,150 @ 5 ft	1/3	Tethered float	Stainless steel body	1-1/2"	14.1	8146953	119.99
H	300 @ 20 ft, 900 @ 15 ft, 1,600 @ 10 ft, 2,400 @ 5 ft	1/3	Mechanical float	Cast-iron body	1-1/2"	17.4	8066433	119.99
I	550 @ 18 ft, 1,500 @ 15 ft, 2,100 @ 10 ft, 2,500 @ 5 ft	1/3	Vert. Float	Noryl impeller	1-1/2"	10.5	8038090	149.99
J	1,600 @ 15 ft, 2,200 @ 10 ft, 2,600 @ 5 ft, 2,800 @ 0 ft	1/2	Tethered float	Polypropylene housing	1", 1-1/4"	13.2	8259244	99.99
K	300 @ 15 ft, 1,700 @ 10 ft, 3,000 @ 5 ft	1/2	Tethered float	Stainless steel body	1-1/2"	14.5	8146979	139.99
L	1,000 @ 22 ft, 1,600 @ 18 ft, 2,300 @ 15 ft, 2,850 @ 10 ft, 3,200 @ 5 ft	1/2	Tethered Float	Noryl impeller	1-1/2"	10.5	8038152	149.99
M	360 @ 15 ft, 1,900 @ 10 ft, 3,300 @ 5 ft	1/2	Tethered float	Cast iron body	1-1/2"	16.4	8145278	159.99
N	475 @ 25 ft, 1,500 @ 20 ft, 2,300 @ 15 ft, 2,700 @ 10 ft, 3,000 @ 5 ft	1/2	Vert. Float	Cast iron body	1-1/2"	21.7	8038189	169.99
O	2,300 @ 15 ft, 3,200 @ 10 ft, 4,000 @ 5 ft	3/4	Tethered float	Stainless steel construction	1-1/2"	16.5	8307233	229.99

Utility Pumps



Bilge Pumps

- Operates on 12V battery or transformer
- Can be used in aquariums, fountains & boats



A) VDC

- Cap. approx. 170 GPH
- Use 3/8" I.D. discharge hose
- Fully submersible
- Inlet at bottom

4270013 - Wt. 0.5 lb **14⁹⁹**

B) 12V

- 5.5A
- Capacity: 600 GPH @ 5 ft head, 400 GPH @ 10 ft head
- Outlet: 1"

8197055 - Wt. 1.6 lb **39⁹⁹**

C) 12V DC

- 11A
- Capacity: 1,500 GPH @ 5 ft, 1,200 GPH @ 10 ft
- 1" outlet, max. lift: 11.5 ft

8197063 - Wt. 2.9 lb **49⁹⁹**



No sale is final until you're satisfied!
We guarantee to make it right. We will repair, replace or refund any product to your satisfaction.



Submersible Utility Pumps

	GPH @ Head	HP	Features	NPT Outlet	Wt. (lb)	ITEM	PRICE
D	840 @ 15 ft, 1,000 @ 10 ft, 1,100 @ 5 ft	1/6	Epoxy coated cast aluminum construction	1"	8.4	8307407	119.99
E	600 @ 15 ft, 900 @ 10 ft, 1,200 @ 5 ft	1/4	Plastic body 3 adapters	1/2", 3/4", 1"	8.2	5770096	74.99
F	960 @ 15 ft, 1200 @ 10 ft, 1320 @ 5 ft	1/4	Thermoplastic body	1-1/4"	7.3	8354078	79.99
G	800 @ 15 ft, 1,000 @ 10 ft, 1,200 @ 5 ft	1/4	Bottom suction to 1/8", Continuous duty motor	1/2", 3/4", 1"	7.3	8037652	119.99



Self-Priming Drill Pump

- Attaches to electric drill
- Empties aquariums, water beds, appliances, crank case motor oil, etc.
- Self-priming 8 ft to 10 ft
- Pumps 240 GPH
- 1,000 - 3,000 RPM for operation speed

5770771 - Wt. 0.7 lb **9⁹⁹**



Metal Drill Pump

- Pumps up to 660 GPH
- 5/16" shaft
- 3/4" garden hose inlet and outlet
- Max. head 100 ft
- Self-priming to 15-1/2"

5770250 - Wt. 0.7 lb **19⁹⁹**

Pump Switches



Pressure Switches

- 1/4" NPT female
- 1.5 HP/115 V or 3.0 HP/230 V
- Wt. 0.9 lb

8127987 - 20 to 40 PSI
8127995 - 30 to 50 PSI **14⁹⁹** /ea



1/4" Female Thread Pressure Switch

- 1 HP/115V or 1.5 HP/230V
- Wt. 1.0 lb

5771290
With Barb Fitting
Preset at 20/40 PSI **21⁹⁹**

8039909
Preset at 30/50 PSI **24⁹⁹**



Pony Pumps

- Ideal for homeowners, RV owners, boaters, ranchers, campers, and contractors
- Chrome-plated brass body
- Flexible nitrite impeller, compounded for long life
- Temperature range from 4°C to 60°C (40°F to 140°F)
- Extra impeller and gasket included
- Dual ports have 3/4" external garden hose thread and 3/8" NPT internal thread



Pony Pump Conversion Kit (not shown)

- Converts pump for use with very hot water, fertilizers, other liquids, light oils, and antifreeze.
- Includes: 2 "Viton" seals and 2 "Hydrin" impellers that will not swell.

5771241 - Wt. 0.1 lb **34⁹⁹**

Pony Pump Repair Kit (not shown)

- Includes impeller and gasket

5771456 - Wt. 0.1 lb **24⁹⁹**

Model	Gallons Per Hour					Shut Off	Load	Wt. (lb)	ITEM	PRICE
	1 ft	5 ft	10 ft	20 ft	40 ft					
H	110 VAC	360	342	300	270	90	48.3	1.75A / 360 GPH	5.0	5771233 99.99
I	12 VDC	300	258	240	202	90	46.0	7A / 300 GPH	4.1	5771431 99.99
J	12 VDC	240	220	200	180	-	23	7A / 240 GPH	4.1	8171118 69.99



Liquid Level Alarm System

- Can be used anywhere to detect high or low liquid level conditions
- Easy to install
- Loud horn alarm
- Red warning light

8307324 - Wt. 3.1 lb **79⁹⁹**



Mechanical Float Switches

- Both switches rated 115 VAC, 15 amps
- Use with submersible sump pumps
- Designed to remove water from basin
- 5770124 - Wt. 1.3 lb
- Universal piggy back type
- Designed to maintain water level

8038385 - Wt. 1.1 lb **39⁹⁹** /ea





A) Water Pressure Tanks

- Working pressure: 90 PSI
- Butyl membrane
- Designed for water systems equipped with a jet pump

9.2 Gallon
8131799 – Wt. 16.0 lb **59⁹⁹**

20.5 Gallon Water
8131781 – Wt. 28.2 lb **119⁹⁹**

B) 26.6 Gallon Pressure Tank

- No water-air or water-tank contact for rust free and no seeping operation
- No waterlogging, eliminates the need for air volume control
- Bladder is made from synthetic rubber to increase reliability and life span
- Max. operating pressure is 75 PSI
- Designed for water systems equipped with a jet pump

• Draw down @ 20/40 PSI: 8.8 gal
8085201 – Wt. 33.4 lb **199⁹⁹**

»BURCAM«



Hose & Tubing

Braided Hose by the Foot

Wt. 0.1 lb

Inside Dia.	Working Pressure	Bursting Pressure	ITEM	PRICE /ft
1/4"	140 PSI	700 PSI	8040292	0.29
3/8"	140 PSI	700 PSI	8040309	0.49
1/2"	112 PSI	490 PSI	8040318	0.69
3/4"	84 PSI	420 PSI	8040327	1.49
1"	70 PSI	280 PSI	8040336	1.59
1-1/4"	42 PSI	170 PSI	8040345	1.99

Clear Vinyl Tubing by the Foot

Wt. 0.1 lb

Inside Dia.	Working Pressure	Bursting Pressure	ITEM	PRICE /ft
1/8"	50 PSI	200 PSI	8040247	0.19
1/4"	50 PSI	200 PSI	8040096	0.19
5/16"	50 PSI	200 PSI	8040265	0.29
3/8"	50 PSI	200 PSI	8040201	0.29
1/2"	40 PSI	150 PSI	8040210	0.39
3/4"	25 PSI	100 PSI	8040229	0.59
1"	25 PSI	100 PSI	8040238	0.69

10 ft Clear PVC Tubing

- Lightweight and flexible
- Oil, heat and acid resistant

Wt. 0.1 lb

Inside Dia.	Working Pressure	Bursting Pressure	ITEM	PRICE
1/8"	50 PSI	200 PSI	8234130	2.49
1/4"	50 PSI	200 PSI	8234148	2.99
5/16"	50 PSI	200 PSI	8234155	3.49
3/8"	50 PSI	200 PSI	8234163	3.99
1/2"	50 PSI	200 PSI	8234171	4.99
3/4"	40 PSI	150 PSI	8234189	5.99
1"	25 PSI	100 PSI	8234197	7.99

10 ft Clear Vinyl Tubing

- Lightweight and flexible
- Oil, heat and acid resistant

Wt. 0.1 lb

Inside Dia.	Working Pressure	Bursting Pressure	ITEM	PRICE
1/4"	140 PSI	700 PSI	8234064	3.99
5/16"	140 PSI	700 PSI	8234072	4.99
3/8"	140 PSI	700 PSI	8234080	5.99
1/2"	112 PSI	490 PSI	8234098	6.49
3/4"	84 PSI	420 PSI	8234106	6.99
1"	70 PSI	280 PSI	8234122	8.99

Double Ear Hose Clamps

Wt. 0.1 lb

Size	ITEM	PRICE
1/2" O.D.	5714308	1.89
9/16" O.D.	5714316	1.99
5/8" O.D.	5714324	2.09



PVC Foot Valves

Size (NPT)	O'all Length	Wt. (lb)	ITEM	PRICE
1"	6-1/8"	0.4	5770019	4.99
1-1/4"	6-1/4"	0.4	5770020	6.99
1-1/2"	8"	1.1	8007248	11.99
2"	9"	1.1	5700009	17.99
3"	12-1/4"	4.2	5770031	49.99



12 pc Assorted Hose Clamps
5710200 – Wt. 1.4 lb **3⁹⁹**

Low Pressure Liquid Filled Gauges

- Stainless steel construction
- 2-1/2" dia. aluminum dial
- Scale shows PSI and kPa (kilopascal)

Port Size	Range kPa	Wt. (lb)	ITEM	PRICE
0 - 30 PSI	0 - 210	0.5	8214306	15.99
0 - 60 PSI	0 - 400	0.5	8214322	15.99
0 - 100 PSI	0 - 700	0.5	8214330	15.99
0 - 200 PSI	0 - 1,400	0.5	8214348	15.99
0 - 300 PSI	0 - 2,100	0.5	8214355	15.99
0 - 600 PSI	0 - 4,000	0.5	8214363	15.99



Hose Accessories



Stainless Steel Hose Clamps

Maximum corrosion resistance

Qty	Size	Size Range	Wt. (lb)	ITEM	PRICE
1	3/8"	3/8" to 7/8"	0.1	8125791	0.59
1	1/2"	1/2" to 1"	0.1	8125817	0.69
1	5/8"	9/16" to 1-1/16"	0.1	8125825	0.79
1	1"	11/16" to 1-1/2"	0.1	8125841	0.99
1	1-1/2"	1-1/16" to 2"	0.1	8125858	1.09
1	2"	1-9/16" to 2-1/2"	0.1	8125866	1.19
1	2-1/4"	1-13/16" to 2-3/4"	0.1	8125882	1.29
1	3"	2-3/4" to 4"	0.1	8125916	1.39
1	3-1/2"	3-1/4" to 4-1/4"	0.1	8125924	1.49
1	4-1/2"	3-3/4" to 5"	0.1	8125940	1.59
1	5-1/2"	4-1/4" to 6"	0.1	8126005	1.69
1	6-1/2"	5" to 7"	0.1	8126013	1.89
10	3/8"	3/8" to 7/8"	0.1	8250656	4.99
10	1/2"	1/2" to 1"	0.1	8250664	5.99
10	5/8"	9/16" to 1-1/16"	0.1	8250672	6.49
10	1"	11/16" to 1-1/2"	0.4	8250680	8.99



Pump Fittings

Plastic Insert Fittings



Size	A) Elbow			B) Fitting			C) Male Adapter		
	Wt. (lb)	ITEM	PRICE	Wt. (lb)	ITEM	PRICE	Wt. (lb)	ITEM	PRICE
1-1/4"	0.1	5700067	0.99	0.1	5700000	0.69	0.1	5700034	0.69
1-1/2"	0.1	5700075	1.29	0.1	5700018	0.89	0.1	5700042	0.79
2"	0.2	5700083	1.89	0.2	5700026	1.39	0.1	5700059	1.39

Hose Menders & Elbows



Size (hose barb)	D) Elbow			E) Mender		
	Wt. (lb)	ITEM	PRICE	Wt. (lb)	ITEM	PRICE
1/4" x 1/4"	0.1	5710253	1.99	0.1	5710259	1.29
3/8" x 3/8"	0.1	5710254	1.99	0.1	5710260	1.39
1/2" x 3/8"	0.1	5710285	1.99	-	-	-
1/2" x 1/2"	0.1	5710255	1.99	0.1	5710261	1.49
5/8" x 5/8"	0.1	5710257	1.99	0.1	5710262	1.59
3/4" x 3/4"	0.1	5710258	1.99	0.1	5710263	1.69

Connectors & Elbows



Size (Male x Hose Barb)	F) Elbow			G) Connector		
	Wt. (lb)	ITEM	PRICE	Wt. (lb)	ITEM	PRICE
3/8" NPT x 1/2"	0.1	5710275	1.99	-	-	-
1/2" NPT x 3/8"	0.1	5710276	1.99	-	-	-
1/2" NPT x 1/2"	0.1	5710277	1.99	0.1	5710273	1.39
3/4" NPT x 1/2"	0.1	5710278	1.99	0.1	5710274	1.49
3/4" NPT x 3/4"	0.1	5710279	2.09	-	-	-

Connectors & Couplings



Size (NPT)	H) Male Threads			I) Female Threads		
	Wt. (lb)	ITEM	PRICE	Wt. (lb)	ITEM	PRICE
3/8" x 1/4"	0.1	5710293	1.49	-	-	-
3/8" x 3/8"	0.1	5710289	1.49	-	-	-
1/2" x 3/8"	0.1	5710294	1.49	-	-	-
1/2" x 1/2"	0.1	5710290	1.49	0.1	5710241	2.99
3/4" x 1/2"	0.1	5710295	1.49	-	-	-
3/4" x 3/4"	0.1	5710291	1.49	0.1	5710242	3.49
1" x 1"	0.1	5710292	1.99	-	-	-
1-1/2" x 1-1/2"	-	-	-	0.1	5710245	7.99

PUMP FITTINGS

The important thing to remember is to use a fitting with a smooth bend. By using smooth bend curves you conserve pumping power. Every pumps loses a bit of flow for every fitting included in the line and the more abrupt the change, the more flow is lost due to pressure drop.

Galvanized Insert Pipe Fittings



Size	Wt. (lb)	ITEM	PRICE
1/2"	0.2	5712195	1.69
3/4"	0.2	5712203	1.99
1"	0.4	5712211	2.49
1-1/4"	0.5	5712229	3.29
1-1/2"	0.7	8232209	3.99
2"	1.1	5712245	4.99

Elbows

Female x Hose Barb



Size (NPT)	Wt. (lb)	ITEM	PRICE
1/2" x 1/2"	0.1	5710281	3.49
3/4" x 3/4"	0.1	5710282	3.49

Tees

Wt. 0.1 lb



Size (hose barb)	ITEM	PRICE
1/4" x 1/4" x 1/4"	5710266	1.99
3/8" x 3/8" x 3/8"	5710267	1.99
3/8" x 1/2" x 1/2"	5710286	1.99
1/2" x 1/2" x 1/2"	5710268	2.49
5/8" x 5/8" x 5/8"	5710269	2.49
3/4" x 3/4" x 3/4"	5710270	2.99

Female NPT Tees

1/2" x 1/2" x 1/2" NPT (female)

5710284 - Wt. 0.1 lb **4.49**



Ball Valves

- PVC construction
- Max. pressure: 150 PSI
- For water and oil use



Port Size	Wt. (lb)	ITEM	PRICE
1/2"	0.2	5770032	3.99
3/4"	0.2	5770033	4.99
1"	0.5	5770034	5.99
1-1/4"	0.8	5770035	7.99
1-1/2"	1.0	5770036	9.99
2"	1.3	5770038	12.99



1-1/4" Sump Pump Check Valve

For vertical pumps
8036600 - Wt. 0.2 lb **4.99**

Reducer Bushings



Size (NPT) (Male x Female)	Wt. (lb)	ITEM	PRICE
3/8" x 1/4"	0.1	5710228	1.99
1/2" x 1/4"	0.1	5710229	2.29
1/2" x 3/8"	0.1	5710230	2.49
3/4" x 3/8"	0.1	5710232	2.49
3/4" x 1/2"	0.1	5710233	2.49
1" x 3/4"	0.1	5710234	2.49
1-1/4" x 1"	0.1	5710235	2.99
1-1/2" x 1"	0.1	5710236	3.49
1-1/2" x 1-1/4"	0.1	5710237	3.59
2" x 1-1/2"	0.1	5710238	3.79

Hex Plugs



Size (NPT)	Wt. (lb)	ITEM	PRICE
1/4" male	0.1	5710247	1.59
3/8" male	0.1	5710248	1.69
1/2" male	0.1	5710307	1.79
1" male	0.1	5710252	1.99



60 pc Hose Connectors

T, L, Y and I type connectors from 3 to 10 mm in dia.
8289753 - Wt. 0.3 lb **9.99**



Gate Valves

- Casted brass
- For water and oil use
- Working pressure: 100 PSI
- Female pipe thread on both ends



Size	Wt. (lb)	ITEM	PRICE
1/2"	0.5	5713060	7.99
3/4"	0.7	5713078	8.99
1"	1.0	5713086	9.99
2"	2.8	5710180	27.99

2" Sewage Check Valve

• Black ABS housing
• Includes: 1 check valve with 2" dia. ports, two 2-3/8" rubberized vinyl sleeves to fit 2" I.D. tubing, 4 stainless steel screws and 4 hose clamps
8005045 - Wt. 1.1 lb **14.99**



Hex Bushing Reducers



1/4" x 1/8"	Wt. (lb)	ITEM	PRICE
1/4" x 1/8"	0.1	5710176	1.69
3/8" x 1/4"	0.1	5710177	1.69
1/2" x 1/4"	0.1	5714506	1.69
1/2" x 3/8"	0.1	5713953	1.69
3/4" x 3/8"	0.1	5714498	1.89
3/4" x 1/2"	0.1	5713961	1.89
1" x 3/4"	0.2	5713979	1.89
1-1/4" x 1"	0.3	5713987	2.49
1-1/2" x 1"	0.5	5714126	3.49
2" x 1-1/4"	0.8	5714142	3.89
2" x 1-1/2"	1.6	5714159	3.89

Coupler Reducers

Size NPT	Wt. (lb)	ITEM	PRICE
3/8" x 1/4"	0.1	5713896	1.69
1/2" x 3/8"	0.2	5713904	1.69
3/4" x 1/2"	0.3	5713912	1.69
1" x 3/4"	0.4	5713920	2.59
1-1/4" x 1/2"	0.5	5714134	3.29
1-1/4" x 1"	0.7	5713938	3.49

90° Reducing Elbows

Size NPT	Wt. (lb)	ITEM	PRICE
3/8" x 1/4"	0.1	5713847	2.49
1/2" x 3/8"	0.2	5713854	2.49
3/4" x 1/2"	0.3	5713862	2.49

6" Long Nipple - Black
5713029 - Wt. 0.2 lb..... **229**

You think
THIS catalogue
has a lot of
information?

You should check out
princessauto.com
for our newest products, additional
product info and customer reviews.



Brass Ball Valves

Female pipe thread on both ends



Size	Working Pressure		Wt. (lb)	ITEM	PRICE
	1	2			
1/4"	600 PSI	150 PSI	0.3	8137028	5.99
3/8"	600 PSI	150 PSI	0.3	8137036	6.99
1/2"	600 PSI	150 PSI	0.5	8137044	7.99
3/4"	600 PSI	150 PSI	0.7	8137051	8.99
1"	500 PSI	150 PSI	1.1	8137069	13.99
1-1/4"	500 PSI	150 PSI	1.5	8137077	19.99
1-1/2"	500 PSI	150 PSI	2.4	8137085	29.99
2"	500 PSI	150 PSI	3.4	8137093	39.99

PVC Check Valves



Size	O'all Length	Wt. (lb)	ITEM	PRICE
1/2" NPT	3-3/4"	0.3	5770062	4.99
3/4" NPT	4-1/8"	0.4	5770063	4.99
1" NPT	5"	0.6	5770021	6.99
1-1/4" NPT	6"	0.7	5770022	9.99
1-1/2" NPT	7"	1.1	8384174	12.99
2" NPT	7-1/8"	1.3	5770064	15.99



1" Bronze Check Valve

- Tapered seat valve with a stainless steel spring
- Noise free and chatter proof action

8038580 - Wt. 0.9 lb **1999**



Standard Black Malleable Pipe Fittings

Size NPT	A) 90° Elbow			B) 45° Elbow			C) 90° Street Elbow			D) 45° Elbow		
	Wt. (lb)	ITEM	PRICE	Wt. (lb)	ITEM	PRICE	Wt. (lb)	ITEM	PRICE	Wt. (lb)	ITEM	PRICE
1/4"	0.1	5710171	1.79	0.1	5712989	1.99	0.1	5710172	2.29	-	-	-
3/8"	0.2	5713433	1.79	0.1	5713482	1.99	0.2	5713532	2.29	0.1	5713581	2.49
1/2"	0.3	5713441	1.99	0.2	5713490	1.99	0.2	5713540	2.29	0.2	5713599	2.49
3/4"	-	-	-	0.3	5713508	1.99	0.4	5713557	2.29	0.3	5713607	3.29
1"	0.6	5713466	2.19	-	-	-	0.6	5713565	2.99	-	-	-
1-1/4"	-	-	-	-	-	-	0.9	5713573	4.49	-	-	-
1-1/2"	1.2	5714068	3.99	-	-	-	-	-	-	-	-	-
2"	1.9	5714076	5.29	-	-	-	-	-	-	-	-	-

Size NPT	E) Straight Tee			F) Cross			G) Coupling			H) Plug		
	Wt. (lb)	ITEM	PRICE	Wt. (lb)	ITEM	PRICE	Wt. (lb)	ITEM	PRICE	Wt. (lb)	ITEM	PRICE
1/4"	0.2	5710173	2.09	0.2	5710174	5.49	0.1	5712997	1.69	0.1	5713003	0.99
3/8"	0.2	5713631	2.29	0.3	5713680	5.79	0.1	5713730	1.69	0.1	5713789	0.99
1/2"	0.4	5713649	2.49	0.4	5713698	5.79	0.2	5713748	1.69	0.1	5713797	0.99
3/4"	0.5	5713656	2.89	0.6	5713706	5.79	0.3	5713755	1.79	0.1	5713805	1.49
1"	0.9	5713664	3.49	-	-	-	0.4	5713763	2.49	0.2	5713813	1.69
1-1/4"	1.3	5713672	4.99	-	-	-	0.7	5713771	3.19	0.4	5713821	1.59
1-1/2"	-	-	-	-	-	-	1.0	5714100	3.89	-	-	-
2"	-	-	-	-	-	-	1.4	5714118	5.79	-	-	-

Size NPT	I) Close			J) Short			K) 3" Long			L) Hex Cap		
	Wt. (lb)	ITEM	PRICE	Wt. (lb)	ITEM	PRICE	Wt. (lb)	ITEM	PRICE	Wt. (lb)	ITEM	PRICE
1/4"	0.1	5710175	1.29	0.1	5710327	1.29	0.1	5713011	1.49	0.1	5713045	0.79
3/8"	0.1	5713839	1.29	0.1	5710324	1.49	0.1	5714399	1.59	-	-	-
1/2"	0.1	5714407	1.29	0.1	5714415	1.49	0.2	5714431	1.59	-	-	-
3/4"	0.1	5714449	1.29	0.1	5714464	1.49	0.2	5714480	1.59	-	-	-
1"	0.1	5714670	1.39	0.2	5714696	1.49	0.3	5714704	1.69	-	-	-
1-1/4"	0.2	5714688	1.59	0.3	5714712	1.79	0.4	5714720	1.99	-	-	-
1-1/2"	0.3	5714167	1.99	0.3	5714183	1.99	0.5	5714209	2.39	-	-	-
2"	0.4	5714175	2.49	0.6	5714191	2.69	0.7	5714217	2.79	-	-	-

Hose Accessories



Aluminum Cam-Lock Fittings

Type	2"			3"		
	Wt. (lb)	ITEM	PRICE	Wt. (lb)	ITEM	PRICE
A Female NPT thread	0.9	5700013	11.99	1.7	8129447	18.99
B Male NPT thread	0.8	5700017	11.99	1.4	8129454	17.99
C Hose barb	1.0	5700014	11.99	2.0	8129462	17.99
D Female NPT adapter	0.3	5700016	6.99	0.6	8129470	8.99
E Male NPT adapter	0.5	5700019	7.99	1.1	8129496	12.99
F Hose barb adapter	0.6	5700015	6.99	1.3	8129512	11.99
G Female 90°	1.3	8164220	21.99	-	-	-



Poly Couplers

Size	H) Male NPT Thread			I) Hose Barb			J) Female NPT Thread		
	Wt. (lb)	ITEM	PRICE	Wt. (lb)	ITEM	PRICE	Wt. (lb)	ITEM	PRICE
3/4"	0.1	8154163	8.99	0.2	8154213	7.99	0.1	8154288	7.99
1"	0.2	8154171	8.99	0.2	8154221	8.99	0.2	8154296	8.49
1-1/2"	0.4	8154189	10.99	0.5	8154239	10.99	0.5	8154304	9.99
2"	0.5	8154197	12.99	0.6	8154247	12.99	0.6	8154312	11.99
3"	0.9	8154205	16.99	1.1	8154270	17.99	1.0	8154320	15.99

Water Hoses



Water Hoses

• 5/8" x 50 ft

• Machined brass connections, heavy duty crush-proof ends

S) Commercial Grade

• Dual reinforced rubber/vinyl, bend restrictor, machined brass connection

• Max. temp.: 49°C (120°F)

• Max. pressure: 450 PSI

• Abrasion resistant

• Not for hot water use

5710136 – Wt. 5.9 lb **24⁹⁹**

T) Farm & Ranch

• Professional grade reinforcing for maximum strength

• Heavy duty flexibility, highly kink resistant

8203796 – Wt. 7.4 lb **29⁹⁹**

U) Heavy Duty Hot Water Hose

• Oil, chemical and abrasion resistant

• Abrasion resistant rubber cover, inner rubber tube for hot water use, machined brass connections

• 3/4" hose is recommended for use with pressure washers to ensure full flow to the pump

5710056 – Wt. 11.1 lb **44⁹⁹**



90° Male Thread

2" NPT male thread

K) 90° Cam-Lock Adapter

5700364 – Wt. 0.4 lb **11⁹⁹**

L) 90° Cam-Lock Coupling

5700372 – Wt. 0.9 lb **27⁹⁹**



Garden Hose Quick Couplers

Heavy duty coupler and nipple is made of brass and stainless steel

Wt. 0.2 lb

M) 5710050 – Female Coupler **6⁹⁹**

N) 5710049 – Male Nipple **3⁹⁹**

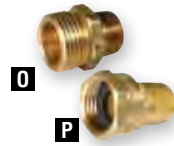

Garden Hose Connectors

Wt. 0.2 lb

O) 5710131 – 1/2" NPT male x male **2⁹⁹**

P) 5790290 – 1/2" NPT male x female **3⁴⁹**

Self-Closing Drum Faucet

• Zinc alloy die-cast body with steel lever

• Lever can be locked with a padlock

• 3/4" NPT male thread

• For non-flammable liquid only

8266348 – Wt. 0.4 lb **9⁹⁹**



Garden Hose Couplers

Size	Q) Female			R) Male		
	Wt. (lb)	ITEM	PRICE	Wt. (lb)	ITEM	PRICE
3/8"	0.1	8021188	3.99	0.1	8021259	3.99
1/2"	0.1	8021197	3.99	0.1	8021268	3.99
5/8"	0.1	8021213	3.99	0.1	8021277	3.99
3/4"	0.1	8021231	3.99	0.2	8021286	3.99

Poly Adapters



Size	V) Male NPT Thread			W) Hose Barb			X) Female NPT Thread		
	Wt. (lb)	ITEM	PRICE	Wt. (lb)	ITEM	PRICE	Wt. (lb)	ITEM	PRICE
3/4"	0.1	8154338	2.99	0.1	8154395	2.99	0.1	8154452	2.99
1"	0.1	8154346	3.49	0.1	8154403	3.49	0.1	8154460	3.49
1-1/2"	0.2	8154361	4.49	0.2	8154411	4.49	0.1	8154486	4.49
2"	0.2	8154379	4.99	0.3	8154429	4.99	0.2	8154494	4.99
3"	0.4	8154387	9.99	0.6	8154445	8.49	0.4	8154502	7.99



40 ft PVC Thermo Hose

• Quality double walled PVC hose

• Solid brass couplings

• Turns itself off during warmer weather

8340010 – Wt. 12.4 lb **119⁹⁹**

GARDEN HOSE NOZZLES

A garden hose spray nozzle can be pistol-shaped, round or cylindrical. Nozzles are made of plastic or brass, or they can be constructed of aluminum or can be made up of multiple materials. The shape and construction material you choose for your nozzle depends on your taste and on how often you use it and where.

Water Filtration



Whole House Water Filter

- Filters sediment, rust, algae, loose scale
- Protects plumbing fixtures & appliances
- 3/4" inlet & outlet
- Uses 8323826 connector kit
- Uses 8323867 filter head seal

8323776 – Wt. 2.6 lb

29⁹⁹



Whole House Water Filter with On / Off Valve

- Filters sediment, rust, algae, loose scale
- Protects plumbing fixtures & appliances
- 3/4" inlet & outlet
- Uses 8323834 connector kit
- Uses 8323842 mounting bracket kit

8323792 – Wt. 2.9 lb

44⁹⁹

Water Filter Mounting Bracket Kit

For filters 8323776 & 8323792

8323842 – Wt. 0.3 lb

5⁹⁹

Replacement Filters

- For sediment, rust, algae, loose scale
- For filters 8323776, 8323792

Wt. 0.2 lb

8323966 – 30 micron

8323958 – 5 Micron

8323941 – 1 Micron

4⁹⁹
/ea
5⁹⁹



High Flow Whole House Water Filter

8323750 – Wt. 6.2 lb

79⁹⁹

Mounting Bracket

For filter 8323750

8323818 – Wt. 2.7 lb

19⁹⁹

Replacement Filters

- High flow rate; high dirt holding capacity
- For sediment, rust, algae, loose scale
- For filter 8323750

25 Micron

8324006 – Wt. 0.8 lb

17⁹⁹

5 Micron

8323990 – Wt. 0.8 lb

17⁹⁹

1 Micron

8323982 – Wt. 1.7 lb

19⁹⁹



Drinking Water Filtration System

- Traps & kills harmful bacteria, protozoan cysts
- Reduces chlorine, lindane, offensive tastes, odours & colour
- Filters sediment, rust, algae, silt and other suspended solids as small as 0.3 microns
- Includes faucet, connection hardware, filters

8323800 – Wt. 8.1 lb

159⁹⁹



A) Chlorine, Taste & Odour Filter Cartridge

- 5 Micron
- For filter 8323800

8323974 – Wt. 1.0 lb

9⁹⁹

B) Ceramic Cartridge

- For filter 8323800
- Traps & kills harmful bacteria
- Traps protozoan cysts
- Filters sediment as small as 0.3 microns
- Reduces chlorine, bad taste & odours

8323909 – Wt. 0.8 lb

29⁹⁹

C) Heavy Duty Filter Cartridge

- 5 Micron
- Dual duty - Extended reduction of chlorine, taste, odour, colour, sediment, & rust
- For filter 8323750

8324014 – Wt. 1.3 lb

39⁹⁹

Filter Head Seal

For filters 8323776 & 8323792

8323867 – Wt. 0.1 lb

5⁹⁹

Whole House Water Filter Connector Kit

For filter 8323792

8323834 – Wt. 0.2 lb

9⁹⁹

For filter 8323776

8323826 – Wt. 0.9 lb

19⁹⁹



Head O Ring Seal

For filter 8323800

8323875 – Wt. 0.1 lb

5⁹⁹

RAINFRESH WATER FILTERS

From removing chlorine and taste/odour to reducing chemical contaminants such as lead, pesticides & herbicides, to bacteria & viruses, Rainfresh has the solution for you. With these systems you can enjoy cleaner, healthier, great tasting water at a fraction of the cost of bottled water. Eliminate the waste of bottled water and reduce your carbon footprint.

Lawn Accessories



Looking for the perfect gift?

GIFT CARDS

are available at any Princess Auto location



D) Multiuse Garden Bag

Holds 10 cu ft

8196909 – Wt. 1.1 lb

7⁹⁹



E

E) 20 Garbage Bags

8235624 – Wt. 5.8 lb

11⁹⁹



Gardening Coil Tie

Used for tying together trees and shrubs

8323552 – Wt. 0.3 lb



4⁹⁹

Pressure Washers



A) 1.8 GPM @ 1,200 PSI Electric Pressure Washer

- Comet 3-piston axial style pump with built-in unloader valve and fixed rate chemical injector
 - 30 ft x 3/8" hose
 - Thermal relief valve to help prevent pump from overheating
 - Wall mounted frame for stationary use
 - 1.5 HP, 115V, 13A
- 8364036** – Wt. 81.7 lb **749⁹⁹**

B) 2.9 GPM @ 2,500 PSI Electric Wall-Mount Pressure Washer

- 5 HP AO Smith motor, Comet LWD 3025 pump
 - Wall-mount frame (suited for stationary use), 16" mounting hole spacing accommodates standard wall studs
 - Hose reel, connection hose, bottle tray, gun / wand, 30 ft pressure hose and 5 nozzles
- 8242273** – Wt. 121.6 lb **1099⁹⁹**



C) 1.8 GPM @ 1,200 PSI Electric Pressure Washer

- 13A
 - Comet 3-piston axial style pump with ceramic coated plungers, built-in unloader valve and fixed rate chemical injector
 - 30 ft x 3/8" hose, 18" insulated wand with quick coupler, 25° quick change cleaning nozzle and one soap nozzle
 - Thermal relief valve to help prevent pump from overheating
 - Downstream soap injection
- 5790114** – Wt. 81.7 lb **729⁹⁹**

D) 2.9 GPM @ 2,500 PSI Electric Pressure Washer

- 5 HP, 230V, 21A electric motor
 - Comet triplex plunger pump with industrial grade ball bearings, extra wide connecting rods, abrasion proof solid ceramic pistons, oversized die-cast aluminum crankcase to help dissipate heat, thermal relief valve to help prevent pump from overheating
 - 30 ft x 3/8" hose, 28" insulated wand, 25° quick change cleaning and soap nozzles included
 - Built-in unloader valve with fixed rate chemical injector
- 8093296** – Wt. 111.6 lb **1199⁹⁹**



E) 1.6 GPM @ 1,800 PSI Electric Pressure Washer

- 13A motor
 - Pistol grip with adjustable spray wand
 - 35 ft cord
 - Automatic soap injector and brass hose connector
- 8255499** – Wt. 21.1 lb **199⁹⁹**

Pressure Washer Detergent



F) General Purpose Powerwash Detergent

- Safe on all surfaces including paint, plastic, concrete and wood
 - A concentrated high foaming detergent for use in cleaning and degreasing
 - Biodegradeable
- 8195430** – 1 Litre **2⁹⁹**
 Wt. 2.4 lb **9⁹⁹**
- 8203093** – 4 Litres **9⁹⁹**
 Wt. 8.5 lb **9⁹⁹**



G) Phosphate Free Pressure Washer Detergent, 4 Litres

- Phosphate-free, environmentally safe, biodegradable
 - Can be diluted 1:40
- 8230542** – Wt. 8.7 lb **13⁹⁹**



H) Premium Citrus Powerwash, 4 Litres

- Powerwash Detergent formula, fortified with a non-corrosive, citrus solvent water based degreaser
 - Removes oil and grease from the toughest jobs
 - Can be diluted up to 1:80
- 8154262** – Wt. 9.0 lb **19⁹⁹**



I) Pressure Washer Detergent

- Concentrated biodegradable detergent for use with hot or cold water pressure washers
 - Can be diluted 1:80
- 8195463** – 4 Litres **13⁹⁹**
 Wt. 9.2 lb **59⁹⁹**
- 8195489** – 20 Litres **59⁹⁹**
 Wt. 47.8 lb **59⁹⁹**



J) Degreaser, 4 Litres

- Contains corrosion inhibitors
 - Can be diluted 40:1
- 8195455** – Wt. 8.7 lb **9⁹⁹**



K) Industrial Degreaser

- 100% water soluble, non-flammable industrial strength degreaser requires no solvent and contains corrosion inhibitors
 - Can be diluted up to 1:80
- 8195497** – 4 Litres **12⁹⁹**
 Wt. 9.1 lb **59⁹⁹**
- 8195513** – 20 Litres **59⁹⁹**
 Wt. 44.8 lb **59⁹⁹**

PEAK VS NET HORSEPOWER RATINGS

Princess Auto advertises our engines in peak or gross horsepower which is different than actual net HP ratings. The net horsepower is defined as the measured output of the engine at the crankshaft end which would also be defined as the true horsepower of the engine.

The peak or gross horsepower would be the horsepower the engine would produce working at peak efficiency in relatively idealistic atmospheric conditions.

In all cases the net horsepower should be less than the peak / gross horsepower.



Pressure Washer Pump Saver, 16 oz

- Helps to protect and prolong the life of your pressure washer pump
- Prevents harmful buildup of hard water mineral deposits
- Preserves seals and pistons

8394447 – Wt. 1.1 lb.....



Synthetic Blend Pressure Washer Pump Oil, 1 Litre

Non-detergent, 30 weight formula with anti-oxidizing and rust inhibiting additives
8026156 – Wt. 2.1 lb.....



Pressure Washer Chemicals

9⁹⁹



A

A) Synthetic Axial Pump Oil, 4.5 oz

- This is a specially formulated synthetic oil with additives to handle the high demands of axial pumps
- Non-detergent, 30 weight formula with anti-oxidizing and rust inhibiting additives

8162901 – Wt. 0.3 lb..... 6⁹⁹



B

B) Mineral Base Pump Oil, 16 oz

8182123 – Wt. 1.0 lb..... 6⁹⁹

11⁹⁹

Pressure Washer Pumps



Unloader / Injector Valves

- Bolt-on OEM replacement for most washer pumps
- Adjustable; not factory preset
- Inlet: 1/2" NPT female, outlet: 3/8" NPT male
- Requires garden hose inlet adapter sold separately (5790290 or 8194557)

C) PSI Unloader Max 2,600 PSI

8149684 – Wt. 1.9 lb..... 69⁹⁹

D) PSI Unloader Max 3,650 PSI

8149692 – Wt. 2.1 lb..... 119⁹⁹



In-Line Unloader Valve

- Must be mounted vertically
- 3/8" FNPT inlet/outlet, 1/4" FNPT bypass port
- 2,900 PSI max. pressure

8195638 – Wt. 1.0 lb..... 64⁹⁹



E

E) 2.5 GPM @ 2,500 PSI Pump Assembly

- Fits gas engines from 1.1 HP to 6.5 HP with 3/4" shaft
- Requires 6.5 HP gas engine at maximum output
- Includes a built-in pressure control valve and chemical injection system
- RMV series axial pump assembly

8149635 – Wt. 8.7 lb..... 199⁹⁹

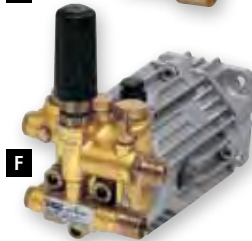

F

F) 2.5 GPM @ 2,700 PSI Pump Assembly

- Fits gas engines from 3.5 HP to 6.5 HP with 3/4" shaft
- Includes a built-in pressure control valve and chemical injection system
- SJV series axial pump assembly

8149676 – Wt. 11.2 lb..... 269⁹⁹



G

G) 3.0 GPM @ 2,500 PSI Pump Assembly

- Fits 3.5 to 6.5 HP gas engine with 3/4" shaft
- Requires a 6.5 HP gas engine at maximum output
- Use with unloader valve: 8149684
- XMV series piston pump assembly
- The oil seals act as triple lip under load
- Support guides are machined brass construction that assures proper plunger alignment and maximizes seal packing and lifespan

8149643 – Wt. 16.9 lb..... 349⁹⁹



H

H) 3.5 GPM @ 2,000 PSI Pump Assembly

- Fits NEMA "C" face electric motor with 5/8" shaft
- Requires 5 HP electric motor
- Use with unloader 8149684
- XMV series piston pump assembly

8149650 – Wt. 17.2 lb..... 369⁹⁹



I

I) 4 GPM @ 3,000 PSI Pump Assembly

- Fits 8 to 20 HP gas engine with 1" shaft
- Requires a 11 HP gas engine at maximum output
- Use with unloader valve 8149692
- RKV series piston pump assembly

8149668 – Wt. 21.9 lb..... 399⁹⁹

AXIAL STYLE PUMPS

Axial style pumps are best suited for our Consumer Class or Light Duty Commercial/Agricultural Class pressure washers. This pump style has an economical design that uses an angled plate driven directly by the motor shaft to compress the 3 spring loaded pistons in series and creates the flow of water.

TRIPLEX PISTON PUMPS

AR plunger pumps feature die-cast aluminum bodies, oversized bearings, extra thick ceramic plungers, stainless steel plunger rods, and forged brass manifolds for maximum performance and life. Connecting rods are oversized for strength and load disbursement. High pressure "V" style Buna-N seals are strong and tighten under load, while low pressure "U" cup double lips Buna-N. The oil seals act as triple lip with load. Support guides are machined brass construction that assures proper plunger alignment and maximizes seal packing and lifespan.

Pressure Washer Wands & Guns



Pressure Washer Guns

	Flow GPM	Max. PSI	Inlet (NPT)	Outlet (NPT)	Wt. (lb)	ITEM	PRICE
A	7.0	3,200	3/8"	1/4"	1.0	8057473	24.99
B	7.0	4,000	3/8"	1/4"	1.2	8194474	34.99
C	7.0	5,000	3/8"	1/4"	1.7	8057481	34.99
D	10.5	5,000	3/8"	1/4"	1.6	8194482	44.99



1,850 PSI Electric Pressure Washer Gun and Hose

- 1/4" x 25 ft plastic hose with M22 connections
- 2 piece moulded lance with rear entry spray gun

8187817 – Wt. 5.3 lb **59⁹⁹**



Pressure Washer Gun Kit

- 2 pc steel lance with front entry spray gun
- Four #3.0 orifice quick connect tips

8187825 – Wt. 3.7 lb **69⁹⁹**

Telescoping Wand Belt Kit

- Support belt for 18 ft and 24 ft extension wands

8116550 – Wt. 1.0 lb **14⁹⁹**



Valley Vantage PowerFist

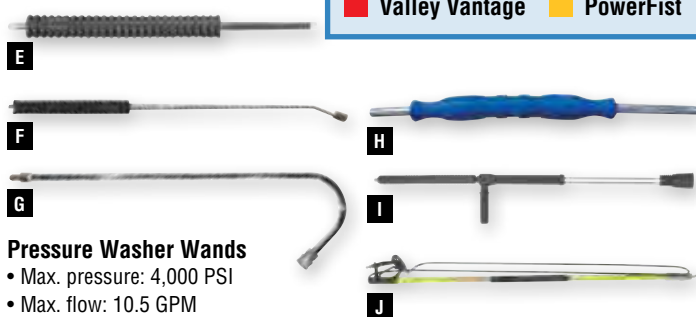

Pressure Washer Wands

- Max. pressure: 4,000 PSI
- Max. flow: 10.5 GPM
- Max. temp: 150°C (300°F)
- 1/4" QCF body outlet (excluding #8057101)

	Lance Style	Length	Wt. (lb)	ITEM	PRICE
E	Straight	18"	0.7	8057101	7.99
	Straight	47"	1.9	8057135	19.99
F	Bent tip	28"	1.1	8052136	12.99
	Bent tip	36"	1.4	8057168	14.99
	Bent tip	59"	2.2	8057184	19.99
	Bent tip	79"	2.7	8057192	24.99

G) 30" Gutter Cleaner Lance

- Max. pressure: 4,000 PSI
- Max. flow: 10.5 GPM

8116949 – Wt. 1.2 lb **14⁹⁹**

I) Double Insulated Lance

- 41" long with low/high pressure switching handle for soap applications

8194524 – Wt. 3.5 lb **89⁹⁹**

H) 18-1/2" Flexible Wand

- 2,250 PSI, 1/4" NPT male ends
- Flex action to access hard to reach areas

8116956 – Wt. 1.0 lb **19⁹⁹**

J) 18 ft Telescoping Pressure Washer Wand

- Max. pressure: 4,000 PSI
- Max. flow: 8 GPM

8006835 – Wt. 9.7 lb **119⁹⁹**

Pressure Washer Hose & Reels



Pressure Washer Hose Reels

- Holds up to 100 ft of 3/8" or 60 ft of 1/2" hose
- 3/8" NPT hose connections
- All steel construction with brass swivel

K) 3,000 PSI
5790142 – Wt. 16.2 lb **79⁹⁹**

L) 4,000 PSI
8055908 – Wt. 11.5 lb **119⁹⁹**



Pressure Washer Hose

- 4,000 PSI
- 3/8" NPT male ends with bend guards
- Working temp. 4°C to 121°C (40°F to 250°F) allows use with either hot or cold water units

Feet	Wt. (lb)	ITEM	PRICE
30 ft	7.1	8258881	54.99
50 ft	9.2	8258899	79.99
75 ft	14.1	8258907	109.99
100 ft	18.3	8258915	139.99

Quick Couplers

Wt. 0.3 lb



Thread	PSI	GPM	ITEM	PRICE
1/4" Female	4,000	6	8390973	6.99
1/4" Male	4,000	6	8032498	6.99
3/8" Female	4,000	10	8032522	6.99
3/8" Male	4,000	10	8032531	6.99

1/4" Quick Coupler Set

- 1 female brass socket and 1 male steel plug

8006987 – Wt. 0.2 lb **7⁹⁹**

5 pc Quick Coupler Set

- Rated for up to 10 GPM and 4,000 PSI
- Two 3/8" female coupler bodies, two 3/8" female steel plugs and one 3/8" male steel plug

8056590 – Wt. 0.7 lb **17⁹⁹**

Steel Plugs

Wt. 0.1 lb



Thread	PSI	GPM	ITEM	PRICE
1/4" Male	4,000	6	8032513	2.99
3/8" Female	4,000	10	8032540	2.99
3/8" Male	4,000	10	8032559	2.99

Quick Coupler

- 3/8" MNPT x M22-1.5

8194441 – Wt. 0.2 lb **8⁹⁹**

Pressure Washer Connectors

4,000 PSI max.

Quick Change Nipple

- 8032434 – 1/4" FNPT x M22-1/5
- 8032443 – 3/8" FNPT x M22-1/5

Wt. 0.1 lb **4⁹⁹**/ea

Quick Change Connector Body

- 8194425 – 1/4" FNPT x M22-1.5
- 8194433 – 3/8" FNPT x M22-1.5

Wt. 0.3 lb **8⁹⁹**/ea



Pressure Washer Nozzles

- Max. pressure: 3,000 PSI
- Max. temp: 100°C (210°F)
- Push/pull for high to low pressure



Orifice	Flow Range	Wt. (lb)	ITEM	PRICE
3.0	1.5 - 2.6 GPM	0.4	8032452	29.99
4.0	2.9 - 3.9 GPM	0.3	8201287	29.99
4.5	4.2 - 5.5 GPM	0.4	8201295	29.99

Rotating Pressure Washer Nozzles

- Max. temp: 80°C (176°F)
- Reduces the time needed to do a job by providing all the impact of a regular 0° nozzle, but with 15° of coverage



Orifice	Max. Pressure	Wt. (lb)	ITEM	PRICE
4.0	3,000	0.5	8194607	39.99
4.5	3,700	0.7	8194615	69.99
4.5	5,100	1.0	8195620	99.99



Pressure Washer Nozzle Sets

- 0°, 15°, 40° and soap
- 4,000 PSI max. 3.0 orifice

3.0 Orifice
8211724 – Wt. 0.2 lb

4.0 Orifice
8211732 – Wt. 0.2 lb **14⁹⁹**/set

Low Pressure Soap Nozzle

- #40 orifice
 - 65° (black)
- 8118846 – Wt. 0.1 lb **7⁹⁹**



Drain Cleaning Nozzle

- Uses the power of your pressure washer to blow apart clogs in pipes, tubes, etc.
 - 1/4" FNPT inlet
- 8195612 – Wt. 0.1 lb **12⁹⁹**



Pressure Washer Nozzles



High Pressure Spray Nozzles

- Quick change nozzles give you the flexibility to change tips for different spray angles quickly from a high impact 0° stream to a flat 40° fan
 - Colour coded nozzle guards identify the nozzle type and help protect the nozzle and the surface being sprayed from contact damage
 - Hardened stainless steel construction for increased durability
 - 4,000 PSI max.
- Wt. 0.1 lb **7⁹⁹**/ea

	0° (Red)	15° (Yellow)	25° (Green)	40° (White)	Orifice Size
	–	8118457	8118507	8118556	3.0
	8118416	8118465	8118515	8118564	3.5
	8118424	8118473	8118523	8118572	4.0
	8118432	8118481	8118531	8118598	4.5
	8118440	8118499	8118549	8118606	5.0

Approximate Gallons Per Minute (GPM)

Orifice Size	800 PSI	1000 PSI	1200 PSI	1500 PSI	2000 PSI	2500 PSI	3000 PSI	3500 PSI	4000 PSI
3.0	1.4	1.5	1.6	1.8	2.1	2.4	2.6	2.7	2.8
3.5	1.6	1.8	1.9	2.1	2.3	2.8	3.1	3.3	3.5
4.0	1.8	2.0	2.2	2.5	2.5	3.1	3.5	3.8	4.0
4.5	2.0	2.2	2.4	2.8	3.0	3.6	3.9	4.3	4.5
5.0	2.2	2.5	2.8	3.1	3.6	4.0	4.4	4.7	5.0

Pressure Washer Accessories

PRESSURE GAUGES

Pressure gauges allow the operator to monitor the system for peak performance. A gradual decrease in system pressure usually indicates a worn nozzle. High pressure may indicate a partially plugged spray tip or other restriction, or a defect in the unloader valve. Important factors in gauge selection are:

- 1) Use liquid filled gauges to absorb pressure fluctuations in the system;
- 2) Select a gauge so that normal system operating pressure is in the middle of the gauges range.



Replacement Soap Injector
OEM replacement for unloader valve 8149684
8151078 – Wt. 0.2 lb **29⁹⁹**



Pressure Washer Cart

- 20" x 13-1/2" base
 - 13 / 5.00 x 6 pneumatic tires
 - Handle angle can be adjusted
 - Pre-drilled for nozzles and engine mounting
- 5790094 – Wt. 40.6 lb **99⁹⁹**



Soap Injector Pickup Hose & Filter

- 3 ft of clear vinyl tubing with mesh filter
 - For use with chemical injectors on pressure washers
- 8121550 – Wt. 0.2 lb **3⁹⁹**

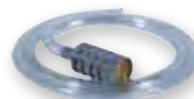

High Pressure Rotary Brush

- 1/4" QCM plug attaches to standard pressure washer lance
 - 2.0 GPM min., 10.5 GPM max. @ 870 PSI
- 8195604 – Wt. 2.0 lb **29⁹⁹**



12" 3-Nozzle Water Broom

- Max. flow: 4 GPM
 - Max. pressure: 4,000 PSI
 - Max. temp: 82.2°C (180°F)
 - Three 65° nozzles with 12" coverage
 - 1/4" QCM plug attaches to standard pressure washer lance
- 8006841 – Wt. 2.7 lb **54⁹⁹**



A) Garden Hose Adapter
Female garden hose x 1/2" FNPT
8051207 – Wt. 0.2 lb **5⁹⁹**

B) Brass Swivel Fitting
• 3/8 MNPT x 3/8 FNPT
• 4,000 PSI max.
8032470 – Wt. 0.3 lb **14⁹⁹**

C) 75 Mesh Inlet Water Strainer
1/2" NPT fittings
8194557 – Wt. 0.6 lb **19⁹⁹**

D) 2-1/2" Stainless Steel Gauge
• Pressure: 0 to 4,000 PSI (28,000 kPa)
• Scale shows PSI and kPa (kilopascal)
8006831 – Wt. 0.5 lb **14⁹⁹**

E) 2-1/2" Gauge
0 to 5,000 PSI
8006843 – Wt. 0.8 lb **19⁹⁹**

Farm

Transfer Pumps

FILL-RITE

Oil & Fuel Transfer Pumps

- Thermally protected, explosion-proof 1/4 HP motor
- Cast iron body construction
- Positive displacement, rotary vane configuration
- 30-minute duty cycle
- Ball bearing construction, no lubrication required
- Each accessory added represents a 10% decrease in flow

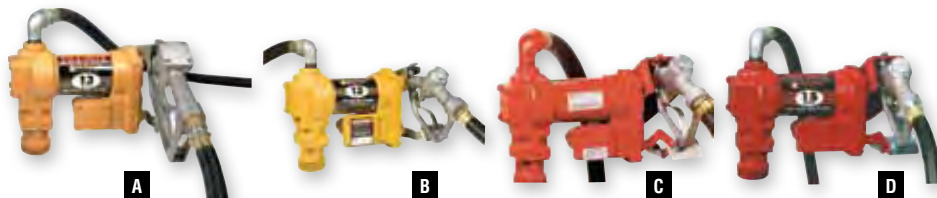

	Description	Volts	Hose	Applications	US GPM	Wt. (lb)	ITEM	PRICE
A	Standard Duty Electric	12 DC	10 ft	Diesel Fuel, Gasoline, Kerosene, Heptane, Mineral Spirits, Solvents	13	29.8	2460069	329.99
B	Standard Duty Electric Auto Nozzle	12 DC	10 ft	Diesel Fuel, Gasoline, Kerosene, Mineral Spirits	13	30.7	2460071	399.99
C	Heavy Duty Electric	12 DC	12 ft	Diesel Fuel, Gasoline, Kerosene, Heptane, Mineral Spirits, Stoddard Solvent	15	33.7	2460028	449.99
	Heavy Duty Electric	12 DC	12 ft	Diesel Fuel, Gasoline, Kerosene, Heptane, Mineral Spirits, Stoddard Solvent	20	35.4	2460029	499.99
D	Heavy Duty Electric	115 AC	12 ft	Diesel Fuel, Gasoline, Kerosene, Heptane, Mineral Spirits, Stoddard Solvent	15	30.8	8066565	449.99

12V In-Line Fuel Pump

- Suitable for carbureted 6 to 8 cylinder engines
- Pressure: 5 to 9 PSI, flow: 20 to 30 GPH
- Install with or without present mechanical fuel pump

8144354 - Wt. 1.4 lb **79⁹⁹**



Diesel Pumps

- Up to 10 GPM
- 1/5 HP, 20A, 12V DC
- 3/4" NPT inlet/outlet
- Cast iron pump
- 30 minute duty cycle
- Power cable, 30 amp fuse and battery clips

8266074 - Wt. 9.2 lb **179⁹⁹**



12V Diesel Pump Kit

Plastic 3/4" barb, 3/4" x 8" inlet/outlet, power cable, 30 amp fuse and battery clips
8266058 - Wt. 13.9 lb **229⁹⁹**

Fuel Transfer Pump Body

- 1/4 HP motor
- 30 min. duty cycle
- Transfers diesel fuel, gasoline, kerosene, heptane, mineral spirits, and Stoddard solvent
- Cast iron body construction

15 GPM Body (57 LPM), 12V DC
8003917 - Wt. 21.4 lb **349⁹⁹**

15 GPM (57 LPM), 115V AC
8237596 - Wt. 21.3 lb **389⁹⁹**

20 GPM (76 LPM), 12V DC
8234858 - Wt. 22.4 lb **419⁹⁹**



24V Diesel Fuel Pump

- Solenoid type
- 10 PSI to 14 PSI, 35 GPH
- 3/8" hose
- For 24V large diesel applications

8270100 - Wt. 1.5 lb **89⁹⁹**



FILL-RITE

Ultra Hi-Flow 115V AC Fuel Transfer Pump

- Cast iron body construction
- 30-minute duty cycle
- Thermally protected, explosion-proof 1/3 HP motor
- Ball bearing construction, no lubrication required
- 19 GPM (75 LPM)
- Includes Fill Rite 900 series meter, 1" Ultra Hi-Flow Nozzle, 1" x 18 ft hose

8334062 - Wt. 73.9 lb **999⁹⁹**



12V Fuel Injected Fuel Pump

- 100 to 125 PSI, 38 GPH
- 5/16" hose
- MPI universal replacement

8270084 - Wt. 1.7 lb **139⁹⁹**



Non Aerosol Spot Sprayer

- For use with oil & lubricants
- Refillable
- Eco friendly
- Eliminates dangerous or harmful propellants
- Operating pressure: 80 to 150 PSI
- Not for use with paint, or flammable products

8311334 - Wt. 2.6 lb **34⁹⁹**



Air Oil Barrel Pump

- Fits drum with 1-1/2" or 2" NPT bung diameter
- Handles hydraulic oil
- Maximum working air pressure: 10 PSI
- Air inlet size: 1-1/4" - 18 NPT with quick disconnect
- Pump capacity: oil at 12 GPM
- 1-1/4" dia. x 44" suction tube, pressure gauge and regulator

8205494 - Wt. 6.7 lb **89⁹⁹**

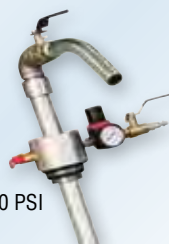

Pneumatic Fluid Pump

- 4 GPM
- Aluminum housing
- Operating pressure: 30 to 100 PSI
- Piston action design for low noise
- For oil & grease
- Includes regulator, 1/2" x 6-1/2 ft braided hose and fluid control valve

8326555 - Wt. 9.5 lb **169⁹⁹**





FILL-RITE

Air Operated Piston Pump

- Max. transfer rate: 6.5 GPM (25 LPM)
 - Air operating pressure: 30 to 100 PSI
 - Telescoping suction pipe for drums up to 36-1/2" in depth
 - Applications include: water, gear oils, engine oils, paraffin, fertilizers, mild acids, anti-freeze, hydraulic oils, diesel, degreasers, herbicides, pesticides
- 8334088** – Wt. 4.4 lb **299⁹⁹**



PROPER LUBRICATION

Proper lubrication ensures long engine life. Change your oil every 50 to 100 hours, depending on working environment (i.e. dust, high heat, etc) to keep your engine running at optimum efficiency.

Air Grease Pump

- Pressure rating: 50:1
 - Oil consumption: 0 to 0.72 LPM
 - Air pressure: 5,000 PSI
 - Steel grease gun, pipe, wheels and stand
- 8254534** – Wt. 32.6 lb **199⁹⁹**



Manual Fuel Transfer Pumps

	A) 2460057	B) 8167595	C) 8167561	D) 2460027
Material/Construction				
Housing	Cast Iron	Polypropylene	Polypropylene	Cast Iron
Pipe	Steel	Polypropylene	Polypropylene	Steel
Spout	Steel	Polypropylene	Polypropylene	Steel
Impeller	Cast Iron	Polypropylene	Rayton	Polypropylene
Bung Nut	Cast Iron	Polypropylene	Polypropylene	Aluminum
Handle	Cast Iron	Polypropylene	Rayton	Steel
Pipe Style	2 pc telescopic	3 pc	3 pc	Telescoping
Pipe Length	43"	45"	45"	22" - 40"
Bung Nut	2" NPT	2" NPT	2" NPT	2" NPT
Flow Rate	300 ml/stroke	250 ml/stroke	250 ml/stroke	20 gallons (76 litres) per 100 strokes
Uses	Gasoline, gear oil, diesel, light oil, kerosene	Oil based medium	Petroleum products, water based fluid and anti-freeze, chemicals, acids	Gasoline or oil
Not for use with	Water, water based solutions, corrosive solutions	Antifreeze, acids, water based medium, lacquer, gasoline, solvents	Acetone, lacquer, mineral oils, solvents, turpentine	Water, water based solutions, corrosive solutions
Wt. (lb)	11.2	4.7	4.8	14.1
PRICE	39.99	49.99	79.99	199.99

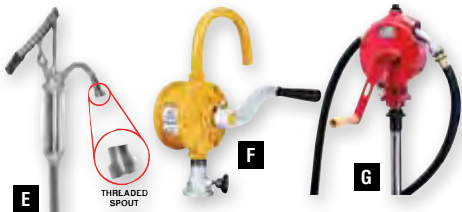

FILL-RITE

E) Barrel Pump

- Delivers 11 oz per stroke
 - Die-cast and steel design
 - Standard 2" bung
 - For use with most oil based fluids
 - Includes telescoping steel suction pipe
- 8066599** – Wt. 6.0 lb **44⁹⁹**

F) Rotary Barrel Pump

- Delivers 6 gallons (23 litres) per 100 revolutions
 - Lightweight die-cast aluminum body
 - 2" NPT threaded bung adapter
 - Smoothly pumps medium-viscosity oils, diesel fuel and non-corrosive fluids
- 8334070** – Wt. 11.6 lb **54⁹⁹**

G) Rotary Hand Pump

- Delivers 10 gallons (37.9 litres) per 100 revolutions
 - Lightweight cast aluminum body
 - 2" Bung Adapter (1" inlet)
 - Built-in check valve and strainer
 - Corrosion-proof adjustable suction pipe
 - Can be padlocked
- 8334104** – Wt. 17.2 lb **219⁹⁹**



Suction Guns

- For oil-based fluids
 - 500 ml (16 oz) capacity
 - Single action - each stroke draws in fluid
 - Needs no priming
 - With 12" flexible vinyl hose
- NOT FOR USE WITH GREASE OR GAS*

H) Plastic Suction Gun

8025521 – Wt. 1.0 lb **7⁹⁹**

I) Metal Suction Gun

4270073 – Wt. 1.6 lb **11⁹⁹**

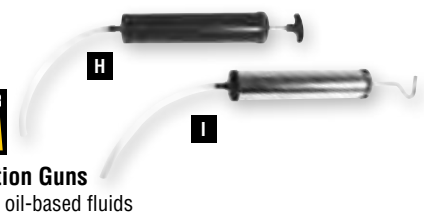



A) Manual Transfer Pump Kit

- 30 ml per stroke
 - Use to siphon fluids including diesel, oil and pesticides
 - Two 4 ft transfer hoses, 31" narrow bore hose, 17" hose with clip-on connector (for tire inflation)
- 8006283** – Wt. 1.2 lb **11⁹⁹**

B) Manual Transfer Pump

- 473 ml (1 pint) per stroke
 - Two 3/8" x 48" hoses
 - Not suitable for gasoline, water based fluids, anti-freeze, solvents or acids
- 4270185** – Wt. 2.1 lb **14⁹⁹**



C) Oil Pump

- Dispenses 500 ml (17 oz) per stroke
 - For use with 20 litre (5 gal.) pails (pail not included)
 - 4 ft outlet hose with steel discharge outlet
 - Suitable for transmission, differential, and heavier oils
- 8057425** – Wt. 6.8 lb **39⁹⁹**



Metal Oil Cans

- Brass pump
- Flexible hose



2 Cycle Oil Mix Tool

- Distributes precise amounts of 2-cycle oil to fuel
 - Includes: 4" extension tube
- 8182941** – Wt. 0.1 lb **5⁹⁹**

Brass "Jiggler" Siphon

- 3/4" x 6-1/2 ft anti-static hose
 - Not to be used for siphoning fuel
- 2460065** – Wt. 1.0 lb **8⁹⁹**

500 ml Oiler

- Steel spout
 - Pistol style trigger
- 4270232** – Wt. 0.7 lb **8⁹⁹**



Hand Lever Piston Pump

- Delivers 11 fl. oz (325 mL) per stroke
 - Telescoping suction pipes for drums up to 36-1/2" in depth
- 8334096** – Wt. 3.1 lb **79⁹⁹**

Hand Operated Piston Pump

- Fits 5 and 6 gal. pails as well as 15, 30, and 55 gal. drums
 - Dispenses 8 oz per stroke
 - Can be adjusted to pump 2, 4, or 6 oz per stroke
 - Sturdy plastic construction
- 2461325** – Wt. 0.6 lb **13⁹⁹**

Size	Wt. (lb)	ITEM	PRICE
6 oz (200 ml)	0.4	4270014	5.99
16 oz (500 ml)	0.7	8035495	7.99
34 oz (1,000 ml)	1.0	8224883	11.99

Fuel Meters

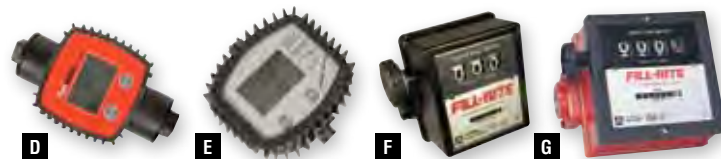

Fuel Meters

Type	Housing	Max Flow Rate	Max Reading	Applications	Ports	Wt. (lb)	ITEM	PRICE
D	Digital	Polypropylene	9 GPM (34 LPM)	99,999	Oil	1/2"	1.2	8257826 99.99
E	Digital	Metal	25 GPM (94 LPM)	99,999	Diesel fuel, kerosene	1"	0.9	8276099 119.99
F	Analog	Metal	20 GPM (76 LPM)	999.9 litres	Gasoline, Diesel fuel	3/4"	5.9	2460026 199.99
G	Analog	Metal	40 GPM (151 LPM)	999.9 litres	Gasoline, Diesel Fuel, Kerosene	1"	9.6	8099160 289.99

FOR GASOLINE & DIESEL FUEL



Fuel Filters

- 150 PSI working pressure
- 5 GPM gravity flow, 14 GPM max. flow
- Can be used with fuel containing alcohol
- Alcohol and impact resistant plastic "see-thru" bowl with drain valve

10 Micron Fuel Filter

- Removes dirt particles
- Wt. 2.4 lb
- 2460035** – 3/4" NPT ports
- 2460277** – 1" NPT ports **39⁹⁹** /ea

Replacement Filter

- For filters 2460035 and 2450277
- 2460285** – Wt. 0.4 lb **7⁹⁹**

Assembly with Water Absorbing Filter

- Wt. 2.5 lb
- 2460036** – 3/4" NPT ports
- 2461226** – 1" NPT ports **44⁹⁹** /ea

Replacement Water Absorbing Filter

- For filters 2460036 and 2450226
- 2461234** – Wt. 0.4 lb **16⁹⁹**

Spin-On Fuel Filter

- 10 micron
- 50 PSI working pressure
- 12 GPM max. flow
- Water block filter
- 2460039** – Wt. 1.1 lb **21⁹⁹**



In-Line Fuel Filters

- Wt. 0.1 lb

	Size	Inlet	ITEM	PRICE
H	Plastic	1/4" to 5/16"	8180069	1.49
I	Nylon	1/4" to 5/16"	8180051	1.99
J	Steel	1/4"	8180028	2.49



K) Filter Heads

- Heavy duty zinc die-cast housing
- 3/4" NPT Ports
- 2460040** – Wt. 1.6 lb **19⁹⁹**

1" NPT Ports

- 2460041** – Wt. 1.4 lb **21⁹⁹**



L) Filler Cap

- Vented filler cap with a 2" base for fuel tanks
- 8192395** – Wt. 1.6 lb **39⁹⁹**

FILL-RITE

Fuel Hose

- Reinforced with static wire
- Ideal for use with electric pumps
- Agriculture type hose used for dispensing gasoline, grease, kerosene, and petroleum



Size	Wt. (lb)	ITEM	PRICE
3/4" x 12 ft	4.4	8001836	34.99
3/4" x 14 ft	5.0	8001837	39.99
3/4" x 20 ft	6.4	8066623	49.99
1" x 20 ft	9.4	8066631	69.99

FILL-RITE

Arctic Fuel Hose

- Engineered with special cold weather seals, spring mechanism
- Provides assured fuel delivery start-up and shut-off
- Tested to -40°F/C



3/4" x 15 ft
8295826 – Wt. 6.2 lb..... **99⁹⁹**

1" x 20 ft
8295834 – Wt. 9.9 lb..... **169⁹⁹**

Lid Opener

- Black nylon body
- Rust proof
- Quickly and easily opens pails without damaging the lid



8061913 – Wt. 0.3 lb **3⁹⁹**



F) Bung Nut

- Fits 1-1/4" O.D. pipe
- 2" NPT threaded end

2460030 – Wt. 0.8 lb **4⁹⁹**

G) Bung Nut Wrench

- Used for opening 2" and 3/4" bung nuts and caps for barrel drums
- Bronze alloy
- Offset handle design reduces user stress and minimizes injuries
- Stronger than aluminum for tough jobs

8281859 – Wt. 1.8 lb **34⁹⁹**



FILL-RITE

O) 3 pc Fuel Drum Pipe

8110009 – Wt. 1.5 lb **24⁹⁹**

P) Telescoping Steel Suction Pipe

8286908 – Wt. 2.2 lb **34⁹⁹**

Fuel Nozzles

FILL-RITE

Fuel Nozzles

- Engineered with special cold weather seals spring mechanism
- Provides assured fuel delivery start-up and shut-off
- Tested to -40F/C

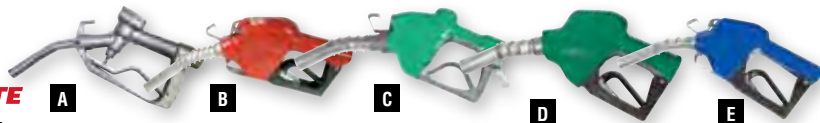

	Type	Inlet/Outlet	Features	Wt. (lb)	ITEM	PRICE
A	Manual	3/4"	-	1.7	8373078	29.99
	Manual	1"	-	1.8	8373086	29.99
B	Automatic	3/4"	-	2.5	2460015	74.99
C	Automatic	1"	-	3.1	8050130	99.99
D	Automatic	1"	High Flow	3.4	8099152	139.99
E	Automatic	3/4"	Arctic	0.3	8295842	34.99
	Automatic	1"	Arctic Diesel	0.6	8295859	49.99

NOZZLES

These are the devices through which the fuel is poured out, into the fuel tank of vehicles.

Gas pump repairs related to the nozzle include mending of the hose that connects the gas pump to the nozzle. The hoses are built to withstand a lot of mishandling but they tend to get worn-out with time.

FILL-RITE

3/4" Arctic Hose Swivel Adapter

- Enhances the overall operation of Arctic Hose/Nozzles in extreme cold environments
- Straight through swivel prevents fuel transfer hose from binding and kinking



3/4"
8295867 – Wt. 0.3 lb..... **34⁹⁹**

1"
8295875 – Wt. 0.6 lb..... **49⁹⁹**

Fuel Containers



H) Gas Cans

5 Litre
8324394 – Wt. 1.2 lb **5⁴⁹**

10 Litre
8237869 – Wt. 1.7 lb **7⁴⁹**

20 Litre
8237877 – Wt. 2.9 lb **10⁹⁹**

I) Yellow 20 Litre Diesel Can

Self Venting
8324790 – Wt. 3.0 lb **13⁹⁹**

J) 20 Litre Jeep Style Gas Can

8324386 – Wt. 3.5 lb **14⁹⁹**

K) 18.8 L Kerosene Can

- Eco spill proof system comes complete with Scepter Eco fuel can and Eco spout
- Designed to minimize fuel spills and the emission of harmful vapours into the environment
- Meets EPA and CARB regulations
- Designed to work with most fuel tanks

8347825 – Wt. 2.5 lb..... **16⁹⁹**

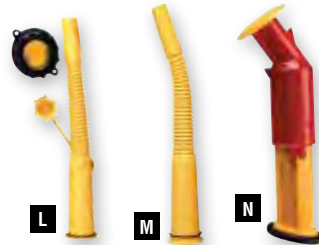

L) 4 pc Fuel Can Accessory Kit

Kit includes screw cap, stopper, vent cap, and flexible spout
8345340 – Wt. 0.1 lb..... **4⁹⁹**

M) Fuel Can Spout

Replacement flexible spout for Scepter fuel cans
8347809 – Wt. 0.1 lb..... **1⁹⁹**

N) Scepter Stop Flow Spout

Replacement stop flow spout for Scepter fuel cans
8347817 – Wt. 0.1 lb..... **4⁹⁹**

Grease Guns

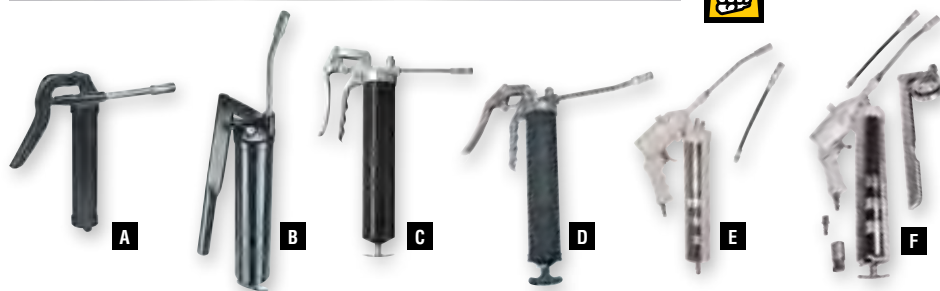

A) Mini Pistol Grip Grease Gun

- A compact 'tool box' sized grease gun, perfect for hard-to-reach jobs
- Provides up to 3,600 PSI
- Includes zinc die-cast head cap and pistol grip for easy one handed operation
- Uses 3 oz cartridge

8264871 – Wt. 1.3 lb **11⁹⁹**

B) Lever-Type Grease Gun

- Ideal for household and do-it-yourself automotive use
- Uses standard 14 oz cartridge
- Provides up to 6,000 PSI

8264939 – Wt. 3.3 lb **14⁹⁹**

C) Pistol-Type Grease Gun

- Easy one-hand operation
- 14 oz cartridge or bulk load
- Head cap port for adding air bleeder or bulk loader fitting
- Delivers up to 5,000 PSI
- 3-1/2" grease pipe and coupler

8264962 – Wt. 2.9 lb **19⁹⁹**

D) Pistol Grip Grease Gun

- Pressure: 6,000 PSI
- 15 oz capacity or 14 oz cartridge
- Die-cast head with hardened and ground piston

8084063 – Wt. 2.9 lb **29⁹⁹**

E) Air Operated Grease Gun

- Delivers 1,500 to 6,000 PSI each time (when attached to a compressed air supply of 30 to 150 lb)
- 3-way load: 14 oz cartridge, bulk, or dispenser
- Equipped with both a metal and flexible spout
- Handle threaded for 1/4" NPT fitting

4270328 – Wt. 3.5 lb **29⁹⁹**

F) Combination Grease Gun

- 3-way load: 14 oz cartridge, bulk (400 cc), or dispenser
- Air operated grease gun, lever action gun head, flexible and metal spouts
- 1/4" NPT air coupler, plug, and barb adapter

8003180 – Wt. 4.6 lb **39⁹⁹**

18V Cordless Grease Gun

- Heavy duty motor delivers over 7,500 PSI
- 110V one hour quick charger with two 18V 1,500 mAh Ni-Cd batteries
- 42" flex hose
- Completely cordless – no more tangling or tugging air hoses or cords
- Coupler with durable bend restrictors on both ends for extended hose life
- Ergonomically balanced to minimize operator strain
- Cartridge and bulk loading options
- Shoulder strap to reduce user fatigue

8265001 – Wt. 17.6 lb **219⁹⁹**



Flexible Grease Gun Hoses

Length	Max Pressure (PSI)	End	Features	Wt (lb)	ITEM	PRICE
9"	4,500	1/8" NPT	Grease fitting coupler at one end	0.2	4270039	4.99
18"	4,500	1/8" NPT	Grease fitting coupler at one end	0.2	4270047	6.99
18"	3,500	1/8" NPT	-	0.2	4270089	6.99
12"	8,000	1/8" NPT	Heavy duty construction for air operated systems	0.3	8264608	7.99
24"	3,500	1/8" NPT	-	0.3	4270090	7.99
18"	8,000	1/8" NPT	Heavy duty construction for air operated systems	0.3	8264806	8.99
12"	4,500	1/8" NPT	Right angle grease coupler	0.3	8182560	11.99



G) Multipurpose BioGrease

- Multipurpose lithium grease
- Biobased / Biodegradable
- 14 oz

8311136 – Wt. 1.0 lb **4⁹⁹**

H) White Lithium BioGrease

- Resists heat, water, & oxidation
- Biobased / Biodegradable
- 14 oz

8311144 – Wt. 1.0 lb **5⁹⁹**

I) Blue Max Lithium Grease

- Multi-purpose lithium complex
- Extreme pressure and anti-wear properties
- For chassis lubrication, high and low speed wheel bearings, universal joints, and general industrial and automotive applications

8001938 – Wt. 1.0 lb **4⁹⁹**

J) Red Max Aluminum Grease

- Extreme pressure multi-purpose aluminum complex grease for high temp. applications
- For 5th wheels, U-joints, king pin and ball joints, torque arms, logging and transport trucks, and earth moving equipment

8001936 – Wt. 1.0 lb **4⁹⁹**

K) Silver Max Moly / Lithium Grease

- 3% molybdenum/lithium complex grease
- For equipment subjected to heavy shock loading, on slow oscillating or reciprocating bearings
- For on and off-road equipment, construction and mining equipment, 5th wheels, and general industrial applications

8001937 – Wt. 1.0 lb **5⁴⁹**



Lithium Grease

Fits mini grease guns
8007270 – Wt. 0.3 lb **1⁹⁹**

GREASE GUNS

A grease gun is a common workshop and garage tool used for lubrication. The purpose of the grease gun is to apply lubricant through an aperture to a specific point, usually on a grease fitting. The channels behind the grease nipple lead to where the lubrication is needed. The aperture may be of a type that fits closely with a receiving aperture on any number of mechanical devices. The close fitting of the apertures ensures that lubricant is applied only where needed.



A) 100 pc SAE Grease Fitting Kit

- Steel with nickel plating
- 6 varieties include: 1/8" NPT straight, 1/8" NPT 45° angle, 1/8" NPT 90° angle, 1/4" x 28 UNF straight, 1/4" x 28 UNF 45° angle, 1/4" x 28 UNF 90° angle

8089831 – Wt. 1.3 lb **19⁹⁹**

B) 100 pc Grease Fitting Kits

- 8 size varieties: straight, 45°, and 90° angles.

Wt. 1.4 lb
4270294 – SAE
8262602 – Metric **24⁹⁹/set**

5 pk Grease Fittings

	Description	Wt. (lb)	ITEM	PRICE
Straight	1/4" 28	0.1	4270017	2.99
	5/16" Drive-In	0.1	4270022	2.99
	3/16" Drive-In	0.1	4270024	2.99
	1/4" Drive-In	0.1	4270025	2.99
	1/8" Pipe	0.1	4270027	2.99
Angle	1/4" 28 45°	0.1	4270018	3.99
	1/4" 28 90°	0.1	4270019	3.99
	1/4" 28 67-1/2°	0.1	4270020	3.99
	1/8" Pipe 67-1/2°	0.1	4270030	3.99
	1/8" Pipe 90°	0.1	4270031	3.99

Grease Gun Holder

Drip tray to keep storage area clean
8041543 – Wt. 1.1 lb **16⁹⁹**

Grease Gun Holder

Designed for wall mounting with 2 screws (not included)
8264996 – Wt. 0.3 lb **5⁹⁹**

8 pc Grease Gun Accessory Kit

Converts any grease gun fitted with a jaw type coupler, into a special applicator, providing effective lubrication of; grease, plugs, sealed bearings, recessed fittings, fittings in shoulders and low height areas
8258600 – Wt. 1.8 lb **39⁹⁹**



Grease Gun Accessories

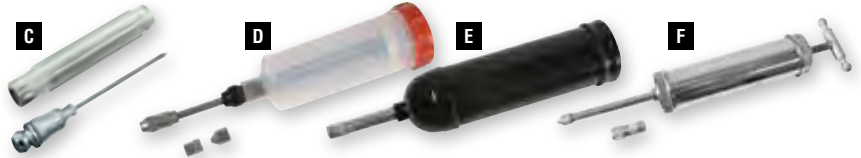

Grease Injectors

C) Grease Injectors

- Lubricates in very tight places such as universal joints and sealed bearings
- For hand operated grease guns only

8264889 – Wt. 0.1 lb **2⁹⁹**

D) Grease Injectors

- With 3 tips: D-type pointed tip with M10x1 thread
D-type pointed tip with 1/8" NPT thread
universal tip with 1/8" NPT thread

• 150 cc capacity
8225138 – Wt. 0.3 lb **5⁹⁹**

- Universal connector used with grease nipples
- Pointed nozzle used for funnel head grease nipples or inaccessible areas to grease.

E) Grease Injectors

- Heavy constructed steel body with glossy finish
- 150 cc capacity

8225161 – Wt. 0.9 lb **11⁹⁹**

F) Grease Injectors

- High pressure metal push gun for oil and grease
- 2,000 PSI

• 8 oz / 200cc capacity
8225179 – Wt. 1.1 lb **13⁹⁹**



G) Heavy Duty Grease Fitting Coupler

- For hand operated grease guns only
- Fits all 1/8" NPT threads
- 6,000 PSI recommended working pressure

8264830 – Wt. 0.1 lb **2⁹⁹**

H) Grease Gun Couplers

- 1/8" F NPT
- Oil and grease resistant rubber tip
- For hand operated grease guns only

8264905 – Wt. 0.1 lb **2⁹⁹**



I) Grease Fitting Coupler

- Fits all 1/8" NPT threads
- For hand operated lube equipment only
- 4,500 PSI recommended working pressure

8264822 – Wt. 0.1 lb **3⁴⁹**

J) 90° Grease Coupler Adapter

- Complete with both small and large sleeves to fit all standard couplers
- For hand operated grease guns only
- 4,500 PSI recommended working pressure

8264855 – Wt. 0.2 lb **5⁹⁹**

K) Grease Tip Needle Adapter

- Use for chain saws, universal joints, bicycles etc.
- For hand operated grease guns only

8264913 – Wt. 0.1 lb **2⁹⁹**

L) Grease Gun Extension

- 6" steel tube with coupler
- Threaded at both ends
- 10,000 PSI max. pressure

8128522 – Wt. 0.2 lb **4⁹⁹**



M) Grease Fitting Tools

- Removes and installs grease fittings
- Small**
Tap repairs 1/4"-28 UNF threads, wrench removes 5/16", 3/8" hex fittings and plugs

4270093 – Wt. 0.1 lb
Large
4270094 – Wt. 0.2 lb **6⁹⁹/ea**

N) Precision Oiler

- For the exact placement of oil or any other lubricant
- Pocket clip
- Overall length: 5-5/8"

8001660 – Wt. 0.1 lb **6⁹⁹**

O) Zerk Cleaning Tool

- Clears grease fittings of hardened matter
- Fits both straight and angled zerk style fittings
- Fill with oil or grease, hold against zerk fitting, and strike with hammer to clear fitting

4270160 – Wt. 0.4 lb **13⁹⁹**

Fans



Industrial Blower Fan

- 1/2 HP
- 2,500 CFM
- 3-speed rotary switch to control air flow
- Heavy duty 30 ft cord

8257776 – Wt. 38.5 lb **279⁹⁹**



High Velocity Drum Fans

Ideal for shops, assembly lines, patios, porches, or anywhere air movement is required

30" 8105041 – Wt. 52.0 lb **249⁹⁹**

42" 8105058 – Wt. 82.0 lb **399⁹⁹**



Heavy Duty 30" Pedestal Fan

- 1/6 HP motor
- 7,957 CFM max.
- Chrome grill

8109134 – Wt. 63.4 lb **219⁹⁹**



Portable Blower Fan

- Capacity: 300 CFM
- 8-1/2 ft 14 ga cord
- Resettable circuit breaker, motor overload protection
- 120V, 60 Hz
- Two 15A grounded outlets

8052599 – Wt. 8.8 lb **59⁹⁹**



Industrial Ceiling Fans

- Improves performance of forced air heating or cooling system
- Use as an exhaust fan in restaurants, poultry houses, or attics
- All metal construction finished in white baked enamel
- Operates forward and reverse



Blade Dia.	Down Rod	CFM	Coverage (sq. ft)	RPM	Amps	Wt. (lb)	ITEM	PRICE
36"	12"	7,100	600	380	0.7	11.2	0771113	59.99
56"	10"	20,500	1,200 - 1,500	310	0.95	15.9	0771733	69.99

Rheostat Speed Controls

Wt. 0.3 lb

0771444 – Regulates 1 fan **19⁹⁹**

0770149 – Regulates up to 4 fans **29⁹⁹**

Fan Blades

- Aluminum blades
- Steel spider and hubs, cadmium plated, socket setscrews
- Clockwise rotation



Dia.	Blades	Bore	Wt. (lb)	ITEM	PRICE
8"	5	5/16"	0.2	0770035	9.99
10"	5	5/16"	0.2	0770036	11.99
16"	3	1/2"	1.1	0770271	24.99
18"	3	1/2"	1.9	0770289	27.99



Automatic Shutters

- Aluminum construction
- Gravity closes shutters when fan is stopped
- Automatically opens when fan starts
- Ideal for use in shops, barns, greenhouses, garages, and sheds



Fan Size	Shutters	Frame	Wt. (lb)	ITEM	PRICE
10"	10" x 10"	13"	2.0	8094559	49.99
12"	12" x 12"	15"	2.6	8094567	54.99
16"	16" x 16"	19"	3.8	8094575	74.99
20"	20" x 20"	23"	7.6	8094591	89.99

10" Utility Fan

- Single speed, 350 CFM
- 14" chrome ON / OFF pull chain
- Easy installation, can be hardwired
- 10 ft cord plugs into 120V outlet
- Can be used for work shop or garage ventilation
- Grey and black finish



8092025 – Wt. 6.8 lb **49⁹⁹**

Duct Booster Fans

- Improves performance of forced air heating or cooling system
- Use as an exhaust fan in restaurants, poultry houses, or attics
- For mounting in a section of ducting

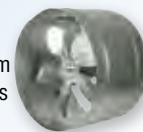

Size	Speed	Max. CFM	Wt. (lb)	ITEM	PRICE
4"	1	80	1.3	0770134	34.99
5"	1	80	1.8	0770145	34.99
6"	1	225	2.4	0772871	39.99
6"	2	250	2.2	0770071	44.99
8"	1	300	3.2	0772889	49.99
10"	1	650	4.5	0772897	59.99
12"	1	800	5.6	0772905	69.99

Single Stage Thermostat

- Single stage, 30-110°F, 120V/16A
- Moisture proof box
- Stainless steel coil and flip open hanger
- Can be used with ceiling and barn fans



8092041 – Wt. 1.2 lb **64⁹⁹**

Plug-In Thermostat

- Duct fan plugs into thermostat and thermostat is plugged into a 110V grounded household outlet (5A rating)
- Mounts between duct fan and register
- Adjustable temperature: 7°C to 43°C
- 6 ft cord



0770061 – Wt. 1.0 lb **39⁹⁹**

Adjustable Duct Booster Fan

- Fits 6" to 8" pipe
- 120V, 40W
- 250 CFM



0772822 – Wt. 1.6 lb **37⁹⁹**

2-Speed Switch

- For use with 8", 10", and 18" 2-speed fans



0772632 – Wt. 0.2 lb **19⁹⁹**



- Ideal for barns, shops, garages, and greenhouses
- Provides moisture, temperature control and continuous ventilation
- MOTOR: totally enclosed, ball bearing with thermal overload protection
- FAN BLADE: heavy gauge galvanized steel, well balanced
- HOUSING BOX: rugged steel welded construction with enamel finish
- MOTOR MOUNT: heavy welded steel rod
- SHUTTER: aluminum louvers supported by long life nylon bearings



	Blade Dia.	HP	Free Air CFM	Opening Needed	Wt. (lb)	ITEM	PRICE
Single Speed	12"	1/4	1,640	15" x 15"	28.0	0772301	229.99
	16"	1/4	2,370	19" x 19"	31.2	0772202	249.99
	18"	1/3	3,200	21" x 21"	37.3	0772343	269.99
	20"	1/3	3,420	23" x 23"	41.3	0772210	284.99
	24"	1/3	4,255	27" x 27"	45.7	0772541	379.99
2-Speed	8"	1/20	360/300	11" x 11"	11.4	0771253	154.99
	10"	1/20	690/580	13" x 13"	13.2	0772384	159.99
	18"	1/3	3,200/2,100	21" x 21"	36.4	0772657	349.99

HeathCo



A) Motion-Sensitive Security Light

- Up to 60 ft detection range
- Uses two 120W PAR38 flood bulbs (not included)
- 110° detection zone
- Energy Star rated

Wt. 1.0 lb
8289415 – White (Shown) **21⁹⁹**
8324345 – Grey **21⁹⁹** /ea

B) Driveway Flood Security Light

- Up to 70 ft detection range
- Uses two 120W PAR38 flood bulbs (not included)
- 180° detection zone

8288425 – Wt. 1.9 lb **29⁹⁹**

C) Yard Security Light

- Up to 100 ft detection range
- Uses two 120W PAR38 flood bulbs (not included)
- 240° detection zone

Wt. 1.9 lb
8288433 – Bronze (shown) **39⁹⁹**
8288441 – White **39⁹⁹** /ea

D) Halogen Security Light

- Up to 70 ft detection range
- Uses one 250W halogen bulb (included)
- 180° detection zone

8288458 – Wt. 2.0 lb **39⁹⁹**

E) Motion Controlled Socket Set

- Motion sensor activates socket to turn ON light when motion is detected
- Controls up to 150W incandescent lighting
- Motion sensor uses 2 AA batteries (not included)

8324410 – Wt. 1.0 lb **49⁹⁹**

F) Solar-Powered LED Security Light

- Up to 70 ft detection range
- Solar powered LED
- 180° detection zone

8288466 – Wt. 1.2 lb **54⁹⁹**

Security Lights



G) Industrial Outdoor Light

- Clear glass with metal guard
- 4 1/2"H x 7 1/4"W
- Uses A19 type bulb, 100W max.

8259814 – Wt. 1.9 lb **14⁹⁹**

H) Wall Mount Light

- 4-3/4"H x 14"W
- Constructed of a corrosion resistant metal that can withstand wet or dry locations

8259822 – Wt. 3.6 lb **29⁹⁹**

I) Motion Light

- Set to "Auto" light operates only when dark, does not turn on in the light
- 6 LED lamp for long life and low energy consumption
- Mounting bracket included
- Uses 4 "AA" batteries (included)

8170458 – Wt. 0.7 lb **19⁹⁹**

J) Solar Powered Outdoor Security Light

- 180° sensor
- Efficient panel for maximum charging energy in varying sunlight conditions
- Brackets and hardware included

8324428 – Wt. 5.3 lb **89⁹⁹**

BRINKS



K) 13W Dusk to Dawn Security Light

- Up to 300 sq. ft lighting coverage
- Great for lighting medium size areas such as walkways, side yards, gardens, and patios
- Includes mounting hardware
- Energy Star rated

8346421 – Wt. 1.6 lb **16⁹⁹**

L) Triple Head Motion Activated Halogen Floodlight

- Uses three 150W T3 Halogen bulbs
- 240° motion sensor
- Includes EZ-N-Stall System for hookup

8346447 – Wt. 4.7 lb **39⁹⁹**

M) Commercial Grade Motion Activated Security Floodlight

- 2 sensor adjustable 300° coverage
- Caged lamps for lens protection
- Uses energy efficient, ultra bright 100W halogen bulbs (included)
- Includes EZ-N-Stall System for hookup

8346439 – Wt. 4.6 lb **69⁹⁹**

SECURITY LIGHTS

Energy efficiency is a major concern for security lighting. Some lights are solar powered, which makes them very efficient, while others will pull power from the structure they are attached to. Using high-efficiency lights with good bulbs can cut down on operating expenses. So can correct placement, to ensure that the light is not wasted.

Light pollution should also be a concern when evaluating lighting options. A bright, badly-aimed light can cause a lot of glare, making it hard for people to see, and contributing to overall levels of light pollution. Choosing a light with a shielded housing will make security lighting less annoying for the neighbors, and also more functional, as criminals can easily hide behind a glaring light.

Sodium & Mercury Vapour Lights

Higher initial cost is offset by low power consumption and much longer life

High Pressure Sodium Lights

- Energy efficient
- 24,000 hour average bulb life

70W

- Lighting coverage of 135 ft
- Dusk / dawn photoelectric cell included

0701367 – Wt. 6.5 lb **69⁹⁹**

150W
0701375 – Wt. 10.4 lb **89⁹⁹**

70W Replacement Sodium Bulb

- 115V with medium base
- For light 0701367

0700849 – Wt. 0.3 lb **26⁹⁹**

150W Replacement Sodium Bulb

- 115V with medium base
- For light 0701375

0700856 – Wt. 0.4 lb **26⁹⁹**



175W Mercury Vapour Light

- 24,000 hour average bulb life
- Dusk / dawn photoelectric cell
- Lighting coverage of 135 ft

0700187 – Wt. 7.8 lb **59⁹⁹**

175W Replacement Mercury Vapour Bulb

- 115V with medium base
- For light 0700187

0700633 – Wt. 0.4 lb **14⁹⁹**

Replacement Photo Electric Control

- For 0701367, 0700187, and 0701375

0702738 – Wt. 0.2 lb **15⁹⁹**

Batteries



F) Alkaline Batteries

Type	Pack Size	Wt. (lb)	ITEM	PRICE
AAA	4	0.1	8195273	3.99
	8	0.2	8269417	6.99
	24	0.6	8260051	12.99
AA	48	1.3	8269433	24.99
	4	0.2	8195281	3.99
	8	0.4	8269425	6.99
C	24	1.2	8260036	12.99
	48	2.6	8259996	24.99
	2	0.3	8195299	3.99
D	8	1.3	8260002	12.99
	2	0.6	8195323	3.99
	8	2.5	8260010	12.99
9V	1	0.1	8195349	3.99
	2	0.2	8269409	7.99
	4	0.4	8260028	11.99

G) Alkaline Batteries

Type	Pack Size	Wt. (lb)	ITEM	PRICE
AA	4	0.2	8006450	2.49
AAA	4	0.1	8007038	2.49
C	2	0.3	8089054	2.79
9V	1	0.1	8007047	2.49



Pocket Battery Tester

Quick power reading of alkaline batteries

8123713 – Wt. 0.1 lb **2⁹⁹**



Flashlights



LED Flashlights

- Aluminum construction
- Requires 3AAA batteries (not included)

A) 1W
8378838 – Wt. 0.1 lb **5⁹⁹**

B) 1W with Adjustable Beam
8378788 – Wt. 0.1 lb **6⁹⁹**

C) 1W with Built-in Laser
8378812 – Wt. 0.1 lb **9⁹⁹**

D) 3W
8378846 – Wt. 0.1 lb **11⁹⁹**

E) 5W (shown)

- Two modes: high/low
- Requires 2 x CR123A or 18650 lithium battery (included)

8378853 – Wt. 0.1 lb **19⁹⁹**

8W
8378861 – Wt. 0.1 lb **29⁹⁹**



LED Solar Keylight

3 diodes

8266702 – Wt. 0.1 lb **4⁹⁹**



LED Flex Light with Clip

Aluminum housing with 9-1/2" shaft

8045117 – Wt. 0.2 lb **9⁹⁹**



3 LED Touch Light

Adhesive backing with built-in magnet can be attached and re-attached to a variety of surfaces

8208993 – Wt. 0.2 lb **5⁹⁹**



6 LED Flashlight / Magnetic Pick-Up Tool

Centre shaft extends from 7" to 27" with flexible magnetic head

8266710 – Wt. 0.3 lb **9⁹⁹**



Security Locks



H) Long Shackle Padlock

- 40 mm non-ratchet padlock with 2 keys
- Hard plastic body cover with vinyl shackle cover

8060019 – Wt. 0.7 lb **4⁹⁹**

H



I) Spare Key Padlock Box

- Zinc alloy body with enamel 10 mm dia. steel shackle with chrome-plated PVC sleeve
- 4 digit resettable combination

8263436 – Wt. 1.2 lb **17⁹⁹**

I



J



Padlocks

- Heavy duty steel construction
- Zinc plated to resist rust
- Screws concealed when installed
- All hardware included

J) 7-3/4" Double Flex
8093809 – Wt. 1.5 lb

K) 7-1/2" Straight Bar
8093817 – Wt. 1.5 lb

12⁹⁹_{ea}



Padlocks

- 6 ft x 3/8" double loop end steel cable with PVC coating
- With 2 keys

L) 6 ft Locking Double Loop Cable
U-bar lock shackle dia: 9/16"
8103947 – Wt. 2.0 lb

M) Steel Cable with Built-in Lock

- Steel / chrome plated lock housing and pin
- 5/8" pin diameter

8103939 – Wt. 2.0 lb **19⁹⁹**_{ea}

BRINKS™
A TRUSTED NAME IN SECURITY SINCE 1859™



Contractor Security

Available at:
PRINCESS AUTO

BRINKS™ **LIFETIME WARRANTY**



NEW

A) Brinks Weather-Resistant Padlock
8376675 – Wt. 0.7 lb..... **6⁹⁹**

B) 2" Adjustable Solid Brass Padlock
• Case hardened chrome plated steel shackle
• Double locking device for added security
• Spool pins for pick resistance protection
8093833 – Wt. 0.8 lb **16⁹⁹**

C) Brass Plated Combination Padlock
1-7/8" resettable combination lock
8190670 – Wt. 0.6 lb **19⁹⁹**

D) Solid Steel Shrouded Padlock
• Hardened chrome plated solid steel alloy shackle
• Double ball locking
8093841 – Wt. 0.8 lb **24⁹⁹**

E) U-Bar Lock
• Double locking shackle
• 7 pin tubular key way prevents picking
• Resists prying, sawing and hammer impact
8026584 – Wt. 1.2 lb **24⁹⁹**

F) 7 ft Steel Lock Cable
• 5/8" dia.
• Weather proof
8026575 – Wt. 2.9 lb **24⁹⁹**

G) 2" Weatherproof Steel Padlock
• Solid brass cylinder for long life
• Double locking device for added security
• Case-hardened steel shackle
• Keyway cover seals out moisture and dirt
• Weather proof
8026593 – Wt. 0.6 lb **11⁹⁹**
3 pk - Keyed Alike
8026600 – Wt. 1.7 lb **29⁹⁹**

H) 3 Pack Steel Camo Padlock Set
• 3 pc weather resistant padlocks, keyed alike
• 2" outside
• Precision "O" rings seal out moisture and dirt from shackleway
• Thermoplastic encased steel shackle & body
• Double locking
8258576 – Wt. 1.6 lb **34⁹⁹**

POWER FIRST
2 Pack Keyed-Alike Padlocks
2" wide laminated steel case
8007863 – Wt. 1.5 lb..... **9⁹⁹**

4 Pack Keyed-Alike Padlocks
3810072 – Wt. 3.0 lb..... **18⁹⁹**

8 Pack Keyed-Alike Padlock Set
• 2" wide laminated steel case
• 1-5/16" dia. hardened steel shackle
• 4-pin tamper and weather resistant tumbler
8007872 – Wt. 5.9 lb..... **36⁹⁹**

Livestock Supplies



A) 12 Litre All Purpose Rubber Pail
8007195 – Wt. 4.9 lb **11⁹⁹**



B) Rubber Tubs
10 litre
8131880 – Wt. 3.9 lb **9⁹⁹**

20 litre
8132037 – Wt. 7.2 lb **15⁹⁹**

30 litre
8132045 – Wt. 8.9 lb **21⁹⁹**

Galvanized Float Bowl

- Non-siphoning
 - Single plastic float and arm with brass valve for setting water level
 - Hinged cover for easy maintenance
 - Water line entry on both sides of bowl with 1/2" brass fitting
 - Bowls can be fitted back to back
- 2470105 – Wt. 6.8 lb **44⁹⁹**



TYPES OF ELECTRIC FENCE ENERGIZERS

There are three main types of electric fence energizers, or chargers: AC-Powered, Battery-Operated and Solar-Powered. The source of power for the charger to function determines the type of charger you will be using. Specific situations require different types of electric fence energizers.



C) Heat Lamp Bulbs
Wt. 0.4 lb
0700268 – Clear **5⁴⁹**
0700269 – Red **7⁹⁹**



D) Infra-Red Brooder Lamp

- Strong triple corrosion protected steel cap and reflector
 - Deep reflector is designed for improved bulb protection
 - 10 ft grounded cord
- Without Switch**
2470016 – Wt. 3.0 lb **24⁹⁹**
- With Switch**
Energy saving Hi / Low / Off switch
8041353 – Wt. 2.7 lb **34⁹⁹**



6 lb Poultry Feeder
8372443 – Wt. 1.2 lb **14⁹⁹**



24" Poultry Feeder
8372427 – Wt. 0.6 lb **6⁹⁹**



E) Cowbells

Produces a sharp tone which can be heard from long distances
8 LD Long Distance Cowbell
8269862 – Wt. 0.2 lb **3⁹⁹**

10 LD Long Distance Cowbell
8269847 – Wt. 0.3 lb **4⁹⁹**

12 LD Long Distance Cowbell
8269839 – Wt. 0.8 lb **8⁹⁹**

F) Kentucky Cowbell

Produces a dull tone which can be heard from far away
8269821 – Wt. 0.8 lb **9⁹⁹**



Solid State Cattle Prod

- Requires 2 "C" cell batteries (included)
- 29" long

2470301 – Wt. 1.1 lb **49⁹⁹**



3 Gallon Poultry Fountain
8372435 – Wt. 2.3 lb **22⁹⁹**



Fence Energizers



Low Impedance Fence Energizers

- Laser trimmed computer precision, solid-state circuitry provides a powerful low impedance shock through wet weeds and bush
- Built-in performance meter
- Ideal for high tensile single or multi wire fence
- Fuse protection

G) Horse Surround Electric Fencer
• Safe, effective, shock designed for animals that are sensitive to electric shock like horses, dogs, and short haired animals
• Charges up to 5 miles of clean fence
• 1.6 joule rating
• Dual flashing operation light control horses
• Ideal for small to medium pastures
2430084 – Wt. 2.3 lb **89⁹⁹**

H) 12V DC Magnum 12 Fence Energizer
• Charges up to 30 miles of clean fence
• 0.87 to 2.7 joule rating
• Use with 12V battery
• Performance meter shows fence condition
• Shocks through wet weeds and brush
2430083 – Wt. 4.5 lb **124⁹⁹**

I) Mark 7 – 115V Fence Energizer

- Charges up to 30 miles of clean fence
- Rated for up to 6 joules
- Ideal for short and medium fence lengths

2430020 – Wt. 6.8 lb **169⁹⁹**

J) Super Energizer-4 – 115V

- Charges over 50 miles of clean fence
- Rated for up to 9 joules
- Has built-in digital performance meter
- Ideal for large pastures

2430021 – Wt. 7.1 lb **189⁹⁹**

K) 6V DC Solar-Pak Fence Energizer

- Charges up to 25 miles of clean fence
- 0.169 to 1.4 joule rating
- Will operate 21 days in total darkness
- Includes sealed rechargeable battery
- Performance meter shows fence condition
- Shocks through wet weeds and brush

2430082 – Wt. 17.8 lb **239⁹⁹**

L) 12V Solar Powered Fence Energizer

- Charges up to 30 miles of fence
- Low impedance for maximum power and longer life
- Performance meter shows condition of fence
- Sealed 12V rechargeable battery included
- Weather proof, outdoor model

8027208 – Wt. 26.0 lb **359⁹⁹**

Electric Fence Insulators



A) "Old Faithful" Gate Handle

- High-impact styrene ensures long and trouble-free life
- Measures 4-3/4" between flanges
- All metal parts plated, heavy stamped steel hook
- Enclosed spring stretches 3-1/2" to keep wire taut

2430032 – Wt. 0.2 lb **2⁹⁹**

B) Dare Rub'rgate®

- Soft pliable rubber outer case internally reinforced with semi-rigid, non-conductive vinyl inner tube
- Large, heavy stamped steel plated safety hook
- Enclosed spring stretches 3-1/2" to keep wire taut

2430031 – Wt. 0.3 lb **5⁹⁹**

C) Electrical Tape Connector

- For tape up to 1-1/2"
- Use to connect charger to polytape or polywire may also be used as an end clamp or to fasten tape to gate handle

8087694 – Wt. 0.2 lb **5⁹⁹**

D) 2 Way Gate Anchor

- Gate for electric fencing
- Allows electric fence shock to transfer through the anchor

2430017 – Wt. 0.1 lb **5⁹⁹**

E) Insulated Fence Cable

- 50 ft/15 m spool
- Rated to 20,000V
- For use underground to connect fence wire between gate openings

2430013 – Wt. 1.6 lb **19⁹⁹**

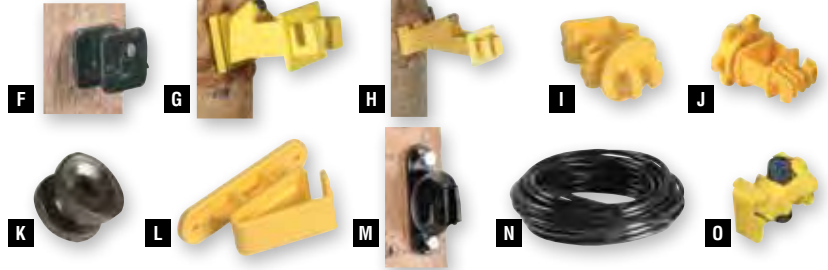

F) 25 pk Black Widow Insulator

- High density black linear polyethylene with UV inhibitors
- 45° slot easily accepts any fence wire and holds it in place
- Includes nails for wood posts

2430038 – Wt. 0.4 lb **2⁹⁹**

G) 25 pk Snug Wood Post Insulator

- Moulded of high density polyethylene with UV inhibitors
- Extends wire 2-1/8" from post
- Includes nails for wood posts

2430034 – Wt. 1.0 lb **4⁷⁹**

H) 10 pk Dare Woodex Insulator

- Moulded of high density polyethylene with UV inhibitors
- Extends wire 5" from post
- Includes nails for wood posts

2430035 – Wt. 0.9 lb **6⁹⁹**

I) 25 pk "T" Post Insulators

- Fits 1.25 and 1.33 lb/ft T posts
- Holds wire 1" from post

2430036 – Wt. 1.0 lb **6⁹⁹**

J) 25 pk Dare Western Screw-Tight Insulator

- High density polyethylene with UV inhibitors
- Extends wire 1" from post
- For round posts
- Fits 1/4" to 9/16" diameter posts and 5/8" fibreglass T posts
- Installs without tools
- Adjustable while current is on

2430033 – Wt. 1.2 lb **7⁹⁹**

K) 10 pk Dare High Strain Insulator

- Moulded of high strength engineering grade polymer
- Able to withstand the constant pressure of high tensile fence wire
- Use for corners, ends, dips and rises

2430039 – Wt. 0.4 lb **8⁹⁹**

L) 25 pk Equine Insulator

- Moulded of all-weather high density polyethylene
- For any poly tape up to 1-1/2" wide
- Insulators grip tape tightly to prevent whipping and sawing
- Heavy tape holder unlocks to aid installation
- Includes nails for wood posts

2430040 – Wt. 1.3 lb **11⁹⁹**

M) 25 pk Snug Ht Insulator

- Moulded of high density polyethylene with carbon black for superior UV resistance
- Heavy fingers carry wire 3/4" from post
- Large diameter flange prevents arcing
- Complete with galvanized ring shank nails

2430045 – Wt. 1.2 lb **11⁹⁹**

N) Insulator Tubing

- 50 ft roll
- Black polyethylene tubing fits up to 12-1/2" gauge fence wire

8005455 – Wt. 0.9 lb **14⁹⁹**

O) 25 pk Dare Large Western Insulator

- Fits 1/4"-7/8" dia. and 5/8" fibreglass T-posts
- Holds all wire, polywire, polyrope, and polytape up to 1-1/2"

8014249 – Wt. 1.5 lb **19⁹⁹**



Poly Electric Fence Wire

- PVC coated fibreglass construction for greater strength, less stretch
- Highly conductive/low resistance aluminum conductors
- Fire and UV resistant

	Description	Length	Colour	Spool	Wt. (lb)	ITEM	PRICE
P	Poly-wire	656 ft (200 m)	Yellow / Black	Cardboard	2.6	2430079	29.99
	Poly-wire	656 ft (200 m)	White	Cardboard	2.5	2430023	34.99
	Poly-wire	1,312 ft (400 m)	Yellow / Black	Cardboard	5.8	2430080	54.99
	Poly-wire	1,312 ft (400 m)	Yellow / Black	Reel Easy	6.6	2430024	64.99
Q	1/2" High Visibility Tape	656 ft (200 m)	Yellow / Black	Reel Easy	5.8	2430026	69.99
	7/8" Equi-tape	492 ft (150 m)	Yellow / Black	Reel Easy	8.2	2430027	89.99
	1-1/2" Equi-tape	200 ft (61 m)	White	Reel Easy	3.1	2430028	59.99

R) Aluminum Electric Fence Wire

Lightweight, and rust free

Gauge	Length	Wt. (lb)	ITEM	PRICE
16	1,312 ft (400 m)	5.9	2430029	39.99
17	1,312 ft (400 m)	4.1	2430030	39.99

S) Galvanized Electric Fence Wire

200,000 lb tensile strength, 1,417 lb breaking strength

Gauge	Length	Wt. (lb)	ITEM	PRICE
16	1,312 ft (400 m)	14.3	2430066	33.99
14	1,312 ft (400 m)	23.6	2430065	49.99

Fencing Accessories

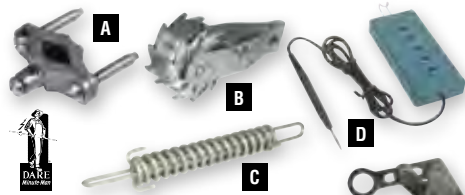

A) Die Cast Zinc Ground Clamp
Fits 1/2" to 1" dia. ground rods
2430056 - Wt. 0.2 lb **4⁹⁹**

B) Wire Strainer
For high tensile fence wire
8034035 - Wt. 0.6 lb **5⁹⁹**

C) Tension Measuring Spring
• Install in each fence line together with strainer
• Necessary to keep wires taut during temperature changes
• Use to determine tension on wires
• All parts are hot dip galvanized and exceed type III specifications
2430054 - Wt. 1.5 lb **8⁹⁹**

Baygard[®]
by Permak
D) Standard 5 Light Fence Tester
• For use with fence energizers with peak voltage of up to 5000 V
• Lights glow in sequence to indicate approximate voltage
• 1000V to 5000V readings
2430016 - Wt. 0.2 lb **19⁹⁹**

E) Fencing Wire Clamp
• Designed to use with a puller to stretch wire
• Works with barbed, smooth or insulated wire
1580117 - Wt. 0.8 lb **22⁹⁹**



F) Wire Strainer Handle
• Use to tighten strainers no. 8034035
• Tension measuring scale on handle
• Heavy riveted construction, zinc plated
2430053 - Wt. 1.0 lb **8⁹⁹**

G) Wire Cutter
Specially designed jaws made to cut 12-1/2 ga high tensile wire
2430055 - Wt. 0.8 lb **31⁹⁹**

H) Fence Stretcher and Splicer
• Comes with a ratchet control for easy release of wire tension
• Heavy duty design with strong "hooks" securely hold wire in place while splicing or repairing
• Comes with large tube handle and rubber grip for easy and comfortable use
8212979 - Wt. 8.4 lb **39⁹⁹**

I) 8" Multi-Groove Crimper
For use with 3 mm and 4 mm aluminum and copper sleeves
8304602 - Wt. 0.7 lb **9⁹⁹**

J) 20" Multi-Groove Crimper
For use with 3/16", 1/8", 3/32" and 1/16" sleeves
8002154 - Wt. 5.6 lb **44⁹⁹**



K) 4" Gate Caster
• 4" hard rubber wheel does not develop flat spots
• Supports gate weights up to 125 lb
• Universal spring loaded bracket for use on wood or chain link fences
8073314 - Wt. 1.9 lb **14⁹⁹**

L) 8" Pneumatic Gate Caster
• 8" pneumatic wheel
• Supports gate weights up to 200 lb
• Universal spring loaded bracket for use on wood or chain link fences
• Spring acts as a shock absorber when rolling on uneven terrain
8113086 - Wt. 7.8 lb **44⁹⁹**

SpeeCo
M) Gate Wheel
• Prevents gate sagging and allows gate to open with ease
• Fits round tube gates 1-5/8" to 2" O.D.
8212896 - Wt. 5.0 lb **19⁹⁹**



15 M 14 Gauge Tie Wire
8176539 - Wt. 0.7 lb **2⁹⁹**



N) 1-5/8" to 1-3/4" Gate Hinge
• Fits round tube gate 1-5/8" to 1-3/4"
• Kit includes upper & lower hinges and mounting hardware
8212912 - Wt. 2.5 lb **9⁹⁹**

O) 2" Gate Hinge
• Fits 2" round tube gate
• Kit includes upper and lower hinges and mounting hardware
8212920 - Wt. 6.0 lb **18⁹⁹**

P) Gate Anchor
• Holds livestock gate open in any position
• Helps prevent gate end from swinging and sagging
• Round tube gates 1-5/8" to 2" O.D.
8212870 - Wt. 3.9 lb **17⁹⁹**

Q) 2-Way Lockable Gate Latch
• Latch will release to allow gate to swing in either direction
• Designed to accept padlock and opens easily with one hand
• Fits round tube gates 1-1/4" to 1-1/2" O.D.
8212904 - Wt. 4.8 lb **18⁹⁹**

R) Adjustable Gate Closer
• Makes opening and closing barbed wire and other types of fence gates quick, easy and safe
• Adjustable cable will fit up to 5" posts and can hold a pad lock
• Powder coated corrosion resistant finish to protect against the elements
8212946 - Wt. 5.0 lb **21⁹⁹**



S) 2-Way Lockable Gate Latch
• Latch will release to allow gate to swing in either direction
• Designed to accept padlock and opens easily with one hand
• Fits round tube gates 1-5/8" to 2" O.D.
8212854 - Wt. 4.8 lb **24⁹⁹**

MORE FEATURES

COMING SOON!

www.princessauto.com

Look for the official launch



A) 48" Poly Step-in Post
 • Non-conductive construction
 • 9 insulators handle wire or tape up to 1-1/2" wide
 • 10" steel spike
2430008 – Wt. 0.7 lb **3⁴⁹**

B) 44" Fibreglass Step-in Post
 • Non-conductive
 • Includes 3 insulators
2430009 – Wt. 0.3 lb **3⁹⁹**

SpecCo
T-Post Puller
 Easy, one man operation pulls the post straight out of the ground without bending or twisting
8212987 – Wt. 16.6 lb **49⁹⁹**

Splicing Sleeves

Wire Size	Qty.	Wt. (lb)	ITEM	PRICE
10 x 11 ga. smooth and 14-1/2 x 15-1/2 ga. barbed	10	0.2	2430049	6.99
14-1/2 x 15-1/2 ga. smooth	20	0.1	2430050	6.99
12-1/2 ga smooth	25	0.1	2430048	6.99

Steel Scoop
 • Hardwood handle
 • 28" long shaft handle
 • 14" x 14" powder coated carbon steel blade
 • 44" overall length
8024871 – Wt. 6.6 lb **27⁹⁹**



HANDLE TYPES
 1) **Powerfist** - Light duty homeowner grade tools (8298986, 8299018).
 2) **Seymour** - Homeowner grade tools (8167389, 8167397, 8167348, 8167363).
 3) **Seymour** - Consumer grade tools (8365405, 8365413, 8318206).
 4) **Seymour** - Structron grade tools



SEYMOUR
 QUALITY TOOLS SINCE 1872

Round Blade "D" Handle Shovel
 • Hardwood handle
 • Heat treated steel heads with clear lacquer finish
 • 26" long shaft handle
 • Rear rolled steps on shovel head
C) Round 8.2" x 11.5" Blade
8218570 – Wt. 3.3 lb
D) Square 9.2" x 11.5" Blade
8218588 – Wt. 3.8 lb **12⁹⁹** /ea

Shovels
 • Fibreglass handle with solid hardwood core inserts
 • Heat treated steel heads with clear lacquer finish
 • 42" long shaft
 • PermaGrip steel collar
E) Round 8" x 11" Blade
8167389 – Wt. 3.3 lb
F) Square 8" x 10" Blade
8167397 – Wt. 3.8 lb **19⁹⁹** /ea



POWER FIST
Fibreglass Long Handle Shovels
 • Hollow fibreglass shaft with rubber grip
 • 63.5" overall length

Blade	Size	Wt. (lb)	ITEM	PRICE
K Round Point Steel	8.5" x 11"	4.0	8298986	12.99
L Square Steel	9" x 11.5"	4.8	8299018	12.99

16" Steering Wheel
 • With three spokes
 • Polypropylene material
 • Use for go karts, play structures etc.
8286502 – Wt. 4.5 lb **24⁹⁹**

Shovels

Long Handle Shovels
 • Fibreglass handle with solid hardwood core insert
 • Heat treated steel heads with clear lacquer finish
 • PermaGrip steel collar
G) Round 8.8" x 11.5" Blade
 43" long shaft handle
8167348 – Wt. 3.5 lb
H) Square 8" x 10" Blade
 58" long shaft for long handle
8167363 – Wt. 3.7 lb **19⁹⁹** /ea

Shovels
 • Fibreglass handle with fibreglass core insert
 • Heat treated steel heads with clear lacquer finish
 • 46" long shaft handle
 • PermaGrip steel collar
I) Round 8.8" x 11.5" Blade
8365405 – Wt. 3.8 lb
J) Square 9.7" x 11.5" Blade
8365413 – Wt. 4.0 lb **29⁹⁹** /ea



SEYMOUR
 QUALITY TOOLS SINCE 1872
M) Fibreglass Manure Fork
 • Fibreglass handle with fibreglass core insert
 • Forged head provides added strength
 • 48" long shaft handle with vinyl grip
 • 8.75" x 12" head with 5 tines
8318206 – Wt. 3.6 lb **49⁹⁹**

N) Pitch Fork
 • Ashwood handle
 • 48" long shaft handle
 • 4 tines
 • 64" overall length
8286551 – Wt. 3.9 lb **24⁹⁹**

POWER FIST
Bale Hook
 • "D" style handle
 • Overall length: 13"
8007202 – Wt. 1.1 lb **5⁹⁹**

Brooms



atlas
graham



Broom Heads & Handles

A) Window / Auto Brush

- 10" structural foam block densely filled with synthetic horse hair fibre
 - Use with any standard or fountain handle
- 3810019** – Wt. 0.8 lb **11⁹⁹**

B) Brooms

- For parking lots, driveways, snow, mud, and grain
- Oil and solvent resistant
- Head use threaded handles with pre-drilled holes to add a brace

18" Wide
3810090 – Wt. 1.4 lb **7⁹⁹**

24" Wide
3810108 – Wt. 2.0 lb **9⁹⁹**

C) Brooms

- Soft tip around a stiff fibre centre
- For both debris and fine dust
- Head uses threaded handles with pre-drilled holes to add a brace

18" Wide
3810116 – Wt. 1.4 lb **8⁹⁹**

24" Wide
3810124 – Wt. 1.8 lb **12⁹⁹**



atlas
graham



Professional Quality Brooms

D) 14" Counter / Bench Brush

- Filled with feather tip synthetic fibre
 - 9" brush face, 2-3/4" trim
- 3810010** – Wt. 0.5 lb **4⁹⁹**

E) Wooden Handle Corn Broom

- Medium weight with 5 rows of stitching
 - For indoor and outdoor use
 - 55" long
- 8240582** – Wt. 1.4 lb **9⁹⁹**

F) 24" Medium Sweep Broom

- Heavy duty 1-1/8" x 60" hardwood handle with brace
 - 2-3/4" long bristles
 - For general clean up
- 3810065** – Wt. 4.4 lb **29⁹⁹**

G) 24" Wide Broom

- Fine sweep broom for general use on smooth floor surfaces
 - Heavy duty 1-1/8" x 60" (5 ft) hardwood handle with brace
- 8005140** – Wt. 4.4 lb **29⁹⁹**

H) 24" Rough Surface Broom

- Heavy duty 1-1/8" x 60" (5 ft) hardwood handle with brace
- 3810064** – Wt. 5.2 lb **34⁹⁹**



Long Handle Scraper

- Blade: 5-1/2" x 7"
 - Total length: 52-1/2"
 - Wood handle
- 8084477** – Wt. 4.6 lb **14⁹⁹**

Shingle Removers

- Superior design makes it easier to remove asphalt shingles and nails
 - 9" notched steel blade
 - Steel brace and carbon steel skid plate for longer life
 - Fulcrum head for extra leverage
 - Replacement blades - 8305062
- I) 27-1/2" Powder Coated Steel Handle**
8305047 – Wt. 4.9 lb **24⁹⁹**
- J) 47-1/2" Solid Fibreglass Handle**
8218596 – Wt. 5.8 lb **69⁹⁹**



Industrial Mop

- Easy to load 24 oz cotton yarn mop head for super absorbency
 - Narrow band with 2 rows of stitching
 - Deluxe 54" handle with neoprene sponge comfort grip
- 8206856** – Wt. 3.2 lb **19⁹⁹**



24" Push Broom / Squeegee Combo

- Suitable for smooth to rough surfaces
 - Removes gravel, dust and dirt
 - Great for wet, dry or oily surfaces
- 8180044** – Wt. 4.0 lb **29⁹⁹**



18" Push Broom

- All purpose for indoor/ outdoor use
 - 54" metal thread handle
 - Dual fibre sweeps fine and medium dirt
- 8171365** – Wt. 2.2 lb **11⁹⁹**



Sher Lock Lid Garbage Can

- Self-lock cover
 - Riveted handles are pull tested to 600 lb
 - 30 ga coated galvanized steel
 - 75 litre capacity
- 8281990** – Wt. 8.6 lb **23⁹⁹**

Squeegees



10" Window Squeegee

- 10" head, 20" handle
 - Sponge with non-abrasive protective cover
- 8177768** – Wt. 0.9 lb **4⁹⁹**



Squeegees

Oil resistant red rubber blade

	Type	Width	Wt. (lb)	ITEM	PRICE
K	Straight	24"	3.0	3811007	24.99
	Straight	36"	4.2	3811015	29.99
L	Curved	24"	3.1	3811023	28.99
	Curved	36"	3.2	3811031	35.99

Handles sold separately

10" Telescoping Window Squeegee

- Handle extends from 4 to 7 ft
 - Sponge with non-abrasive protective cover
- 3810052** – Wt. 1.4 lb **19⁹⁹**



Floor Squeegees

M) 24" Straight
8123853 – Wt. 2.7 lb **14⁹⁹**

M) 36" Straight
8133076 – Wt. 3.6 lb **19⁹⁹**

N) 24" Curved
8123861 – Wt. 2.5 lb **14⁹⁹**

N) 36" Curved
8133084 – Wt. 3.6 lb **19⁹⁹**

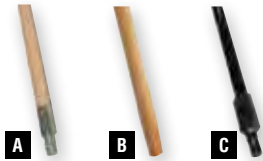

Broom Handles

	Handle Type	Size	Wt. (lb)	ITEM	PRICE
A	Threaded Tip	15/16" x 54"	1.2	3810157	4.99
B	Tapered Handle	1-1/8" x 54"	1.0	3810165	4.99
C	Metal Handle	1-1/8" x 54"	0.8	8005128	4.99



Jumbo Brace for Push Brooms
3810012 – Wt. 0.4 lb **279**



Assist Handle

- Plastic grip
 - For use with shovels, brooms, rakes, etc.
- 8061905 – Wt. 0.6 lb **399**



G) 50 lb Dual Pulley Lift
8093650 – Wt. 3.7 lb **1999**



WORK with us!



We are always looking for team-oriented people with a passion for delivering Royal Service.

Visit www.princessauto.com/careers to apply for any of our positions across Canada

Part-Time • Full-Time • Benefits • Opportunities • Fun

Pest Control



Victor®

D) 2 pk Wood & Metal Traps

For Mice
2470113 – Wt. 0.1 lb **199**

For Rats
2470115 – Wt. 0.4 lb **299**

E) Rodent Trap
Overall dim.: 9" x 5" x 5".
8159246 – Wt. 0.6 lb **999**

F) Gopher Trap
Safe and non-toxic, no poisons or gases
8006912 – Wt. 0.9 lb **1299**

G) Metal Mouse Trap
2470114 – Wt. 1.3 lb **1799**

Tarp Repair

Propane Tank Fitting

- 9/16"-18 LHT x POL
 - Use to connect torch hose to propane tank
- 8005552 – Wt. 0.2 lb **579**



Propane Hose

- 1/4" propane hose with female thread swivel ends, 9/16" x 18 LHT
- 10 ft
8005534 – Wt. 1.3 lb ... **1999**
- 20 ft
8005543 – Wt. 2.4 lb .. **3999**



Mr. Heater

- 500,000 BTU Propane Torch Kit**
 - Ideal for melting ice and thawing pipes
 - 10 ft neoprene hose, POL fitting, striker and replacement flints
- 8133936 – Wt. 4.3 lb .. **7999**

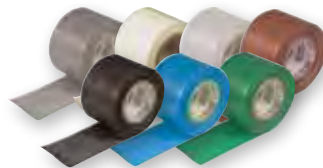

2" x 35 ft Tarp Tape

- 2" wide x 35 ft long
- Sets in sunlight or heat
- Fix rips and tears, reinforce stress points, join tarps

Wt. 0.3 lb

- 2480024 – White
- 2480013 – Green
- 2480014 – Silver
- 8012848 – Clear
- 2480005 – Blue
- 8392078 – Brown
- 2480023 – Black **699** /ea



Sewing Awl

- Sew any heavy material
 - Comes with #8S and #8C needles and 1 refillable bobbin of coarse nylon thread
 - Includes 30 yards of replacement thread
- 8068660 – Wt. 0.5 lb **999**

Coarse Stitching Thread
8109357 – Wt. 0.2 lb **299**



1/2" Grommets Only

Pkg of 50
2480903 – Wt. 0.2 lb **499**



10 pk Tarp Eyelets

- Self sealing eyelets for plastic or canvas sheeting
 - Snap together for easy installation
 - 7/16" I.D. 1-1/8" O.D.
- 8026218 – Wt. 0.1 lb **299**



Tarp Repair Kit With Grommets

- Repair or install new grommets
 - Punch, grommet installing tool, and fifty 1/2" brass plated grommets
- 2480663 – Wt. 0.8 lb **999**



4 pc Tarp Grabber Set

- Easy to install
 - 4 times stronger than brass grommets
- 8006271 – Wt. 0.2 lb **499**



7" Sewing Needles

- 2 pk
 - Bent ends and large eyes for sewing jute and other twines
- 8321317 – Wt. 0.1 lb **199**



Extra "S" Hooks

10 per package
8012786 – Wt. 0.3 lb **199**

Tarps

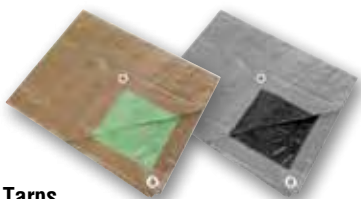

Poly Tarps

- Reinforced corners for greater strength
- Tear-resistant
- Poly rope in hem

Green / Brown

- 10 x 10 mesh, 1,000 denier
- 40 micron coating both sides
- Grommets: 3 ft spacing, aluminum construction
- 2.9 oz/sq. yd. UV treated polyethylene

Black / Silver

- 14 x 14 mesh, 1,000 denier
- 50 micron coating both sides
- Grommets: 2 ft spacing, aluminum construction
- 5.4 oz/sq. yd. UV treated polyethylene

Cut Size	Approx. Finished Size	Green / Brown			Black / Silver		
		Wt. (lb)	ITEM	PRICE	Wt. (lb)	ITEM	PRICE
6 x 8	5 ft 6" x 7 ft 6"	0.9	2480309	4.99	1.6	2480038	7.49
8 x 10	7 ft 4" x 9 ft 6"	1.7	2480291	7.99	2.9	2481018	12.99
10 x 12	9 ft 4" x 11 ft 6"	2.6	2480325	11.99	3.8	2481026	18.99
12 x 16	11 ft 4" x 15 ft 6"	4.0	2480341	18.99	6.2	2481034	29.99
12 x 20	11 ft 6" x 19 ft 3"	4.9	2480048	22.99	7.7	2480040	37.99
12 x 24	11 ft 4" x 23 ft 6"	5.5	2480861	27.99	8.8	2481042	44.99
12 x 36	11 ft 6" x 34 ft 6"	7.9	2480049	41.99	13.2	2480041	59.99
15 x 20	14 ft 3" x 19 ft 6"	6.4	2480042	29.99	9.3	2481059	44.99
18 x 24	17 ft 3" x 23 ft 6"	8.9	2480043	39.99	13.4	2481067	59.99
20 x 30	19 ft 1" x 29 ft 4"	13.1	2480366	57.99	19.9	2481075	89.99
30 x 40	29 ft x 39 ft 3"	26.6	2480046	99.99	41.2	2481091	169.99
30 x 50	29 ft x 49 ft 2"	34.6	2480655	129.99	49.2	2481109	199.99
30 x 60	29 ft x 59 ft	40.2	2480047	159.99	57.3	2481117	239.99



Canvas Tarps

- Reinforced triangular patches 4 layers thick at each eyelet with double stitched seams
- Nylon rope in perimeter hem in sizes 12 ft x 16 ft and up
- Grommets every 3 ft around perimeter
- Weight before treatment: 12 oz/sq yd, after: 18 oz/sq yd
- Ideal for uses that require breathable fabrics to prevent rot or rust on objects
- Tan in colour

Cut Size	Approx. Finished Size	Wt. (lb)	ITEM	PRICE
6 ft x 8 ft	5 ft 6" x 7 ft 6"	5.7	8016489	34.99
9 ft x 10 ft	8 ft 6" x 9 ft 6"	9.6	8016522	64.99
10 ft x 12 ft	9 ft 6" x 11 ft 6"	11.7	8016531	84.99
10 ft x 16 ft	9 ft 6" x 15 ft 6"	15.5	8074627	99.99
10 ft x 20 ft	9 ft 6" x 19 ft 6"	22.0	8074643	129.99
12 ft x 16 ft	11 ft 6" x 15 ft 6"	23.0	8056916	129.99
12 ft x 20 ft	11 ft 6" x 19 ft 6"	26.0	8056925	169.99
15 ft x 20 ft	14 ft 6" x 19 ft 6"	31.4	8056943	199.99
18 ft x 24 ft	17 ft 6" x 23 ft 6"	43.7	8056952	269.99



Haystack Tarps

- Silver on the outside to prevent light, black on the inside to prevent green housing
- Super tough 6.2 oz/sq. yd. UV treated coated fabric
- Eyelets and webbing set into 5 layers of fabric
- 500 lb of pull strength
- Special treatment for long outdoor life

18 ft x 48 ft 8004790 – Wt. 38.2 lb	209⁹⁹
25 ft x 48 ft 8004793 – Wt. 52.4 lb	279⁹⁹
33 ft x 48 ft 8004788 – Wt. 72.2 lb	349⁹⁹



Multi-Purpose Tarps

- 12 x 12 UV treated mesh poly fabric
- 1/4" polypropylene rope drawstring and handles
- Ideal for yard clean-up, equipment covers, and more

6 ft x 6 ft Finished size approx. 5 ft 4" x 5 ft 4"	9⁹⁹
2480062 – Wt. 1.4 lb	
9 ft x 9 ft Finished size approx. 8 ft 2" x 8 ft 2"	18⁹⁹
2480058 – Wt. 2.6 lb	



Oak Leaf Camo Tarp

- 10 x 10 weave
- Polyethylene coating
- Aluminum grommets on outer edge
- 4.9 oz
- 40 micron coating

6 ft x 8 ft 8303513 – Wt. 1.0 lb	9⁹⁹
9 ft x 12 ft 8196917 – Wt. 3.0 lb	19⁹⁹
12 ft x 16 ft 8303430 – Wt. 5.0 lb	29⁹⁹

TARPS - For a protective material, a tarp is often used. Polyethylene, the most common material for tarps, is for waterproof and UV resistant properties, while mesh tarps are used when some breathability and sunlight are needed.



Rubber Tie-Down Straps

- Stretch to 1-1/2 times their original size
- Made of weather resistant EPDM rubber
- 1/2" thick reinforced eyelets

Size	Wt. (lb)	ITEM	PRICE
9"	0.2	8060607	1.19
15"	0.2	8060616	1.49
20"	0.3	8060643	1.69
30"	0.3	8060652	2.19

Rubber Tie-Down Straps

- Made from weather resistant EPDM rubber
- Includes "S" hooks
- Approx. 1/4" thick with 5/8" thick end blocks
- Sizes listed are for strap only (add 4" for hooks)

Size	Max. Safe Stretch	Wt. (lb)	ITEM	PRICE
10"	15"	0.9	3800317	3.49
15"	22"	1.2	3800318	3.99
21"	32"	1.4	3800319	4.99
31"	46"	1.8	3800320	5.99
41"	61"	2.3	3800321	8.99

Adjustable Strap with Hooks

20"
Holes every 5"
8057498 - Wt. 0.3 lb **2⁴⁹**

30"
Holes approximately every 7"
8008372 - Wt. 0.3 lb **2⁹⁹**

Rubber Tie-Down Strap Set

- Steel hooks at both ends
 - Made from weather-resistant EPDM rubber
- Four 10", Three 15", & Three 21" Straps**
8085391 - Wt. 2.3 lb

Two 10", Three 15", Three 21", & Two 31" Straps
3809985 - Wt. 2.7 lb **9⁹⁹/set**



6 pc Bungee Cord Kit

A) 1/4"
2 each of 12", 18", and 24" cords x 1/4" dia.
3808722 - Wt. 0.4 lb **4⁴⁹**

B) 3/8"
18", 24", 32", 48", 64", and 72" cords x 3/8" dia.
3800695 - Wt. 2.4 lb **12⁹⁹**



25 pc Bungee Cord

Long 7-1/2" length is ideal for use with portable garage
8204661 - Wt. 0.8 lb **5⁹⁹**



12 pc Bungee Tarp Ties

- 4 each of 12", 18", and 24" long
 - Fixed ball on one end and adjustable hook on the other
 - Design allows hook removal for quick installation, and can be tightened to easily remove slack
- 3800479 - Wt. 1.0 lb **7⁹⁹**



30 pc Bungee Cord Kit

- 10 pcs of ea. size: 12", 18" and 24"
 - Max. length: 24", 36", 48"
 - Comes in handy storage bucket
- 8191561 - Wt. 4.7 lb **19⁹⁹**



4 pc Aluminum Tarp Clip Set

- Aluminum alloy extruded with spring device
 - With yellow plastic loop
- 8268021 - Wt. 0.7 lb **11⁹⁹**



Tarp Accessories



13" Industrial Bungee Strap

- 10 mm thickness
- Made from high quality black cord with polyester fabric
- Ends are made from heavy gauge wire with a yellow dichromate finish for a longer life than non finished hooks

Length	Wt. (lb)	ITEM	PRICE
13"	0.3	8078354	1.19
18"	0.3	8078388	1.29
24"	0.3	8078396	1.49
36"	0.4	8078412	1.99



Plastic Hooks for Bungee Cord

Wt. 0.1 lb
3809811..... **49¢**

5/16" Bulk Bungee Cord

Wt. 0.1 lb
3809803..... **49¢/ft**



C) 20" Camouflage Rubber Strap

- 20" adjustable strap
 - 2-1/2 times original length safe stretch length
 - Hooks add 4" to length
 - Made with weather resistant EPDM rubber
 - 1/2" thick reinforced eyelets
- 8098030 - Wt. 0.3 lb **3⁴⁹**

D) 10 pk Camouflage Bungee Cords

24" high quality bungee cords with heat treated wire hooks and black vinyl coating
8078438 - Wt. 1.7 lb **11⁹⁹**



4 pc Hook Loop Set

- 5-1/2" long
 - Vinyl covered metal hook
- 3800050 - Wt. 0.2 lb .. **1⁹⁹**



4 pc Ball Loop Set

- 5-1/2" long
 - Stretch cord
- 3800051 - Wt. 0.1 lb .. **2⁹⁹**



E) Dippers

1/2 Litre Cap.
8016372 - Wt. 0.3 lb **4⁹⁹**

1.2 Litre Cap.
8202798 - Wt. 0.5 lb **7⁹⁹**

F) Canning Funnel with Screen

- Opening dia.: 5-1/2"
 - Bottom spout: 2"
- 8137101 - Wt. 0.3 lb **9⁹⁹**



Non-Skid Feed Dishes

Size	Type	Wt. (lb)	ITEM	PRICE
16 oz	Single	0.4	8127300	5.99
64 oz	Single	0.9	8016363	9.99
H	Dual	2.4	8119950	19.99



Stainless Steel Plate

1/2" deep, 9-1/2" dia.
8116329 - Wt. 0.3 lb **4⁹⁹**



Stainless Steel



Stainless Steel Bowls

Size	Type	Wt. (lb)	ITEM	PRICE
I	1/2 L Ribbed	0.2	8202707	2.99
J	1/3 L Plain	0.2	8202715	2.99
K	2.7 L Non-Skid	0.7	8127326	9.99
L	7 L Flat	1.0	8016381	11.99
L	14.2 L Flat	2.5	8001608	21.99

Stainless Steel Pail

Non-magnetic, anti-rust

Size	Wt. (lb)	ITEM	PRICE
4 L	0.9	2470318	9.99
9 L	1.9	2470305	19.99
16 L	2.4	2470306	24.99



250 g Scoop

8127649 - Wt. 0.4 lb **9⁹⁹**



350 ml Mug

8002634 - Wt. 0.2 lb **3⁹⁹**



Casters

General Duty Casters

Rubber wheel



Wheel Size	Load Cap.	Overall Height	Swivel			Rigid		
			Wt. (lb)	ITEM	PRICE	Wt. (lb)	ITEM	PRICE
1-1/4"	30 lb	-	0.1	8001841	1.99	0.1	8001832	1.69
1-1/2"	40 lb	-	0.2	8001869	2.49	0.2	8001850	1.99
2" x 1"	90 lb	2-1/2"	0.4	8001840	2.99	0.3	8002046	2.49
3" x 13/16"	110 lb	3-3/4"	1.0	8037199	5.99	-	-	-
4" x 15/16"	115 lb	4-13/16"	1.4	8037215	7.99	1.5	8037224	7.49
4" x 1-1/4"	115 lb	5"	1.8	2041150	14.99	1.1	2041168	10.99



3" Threaded Stem Caster with Brake

- 3" wheel size
- 4" overall height
- Load capacity: 270 lb
- Hard rubber wheel
- Easy swivelling under heavy loads



8073462 – Wt. 1.4 lb **12⁹⁹**

Light / Medium Duty Casters



Wheel Size	Load Cap.	Overall Height	Swivel		Rigid		Wheel Only		
			ITEM	PRICE	ITEM	PRICE	Bore	ITEM	PRICE
2-1/2" x 1-1/8"	100 lb	3-1/4"	2040008	4.99	2041143	3.99	-	-	-
2-1/2" x 1-1/8"	100 lb	3-1/4"	8037144	6.99	-	-	-	-	-
3" x 1-1/4"	210 lb	3-13/16"	8037153	7.99	8037162	6.99	3/8"	8039836	2.99
4" x 1-5/8"	255 lb	5"	8037171	13.99	8037180	10.99	7/16"	8006683	4.99

*w/ brake

Precision Bearing Threaded Stem Casters

- 3" polyurethane wheel
- Overall height: 3-13/16"
- Load capacity: 225 lb
- -40°F to 180°F
- Protects floor and resists chemicals, acids, and oil

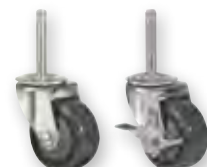

8073231 – Wt. 1.1 lb **12⁹⁹**

With Brake
8073306 – Wt. 1.2 lb **14⁹⁹**

Medium / Heavy Duty Casters



Wheel Size	Load Cap.	Swivel		Swivel w/Brake		Rigid	
		ITEM	PRICE	ITEM	PRICE	ITEM	PRICE
3"	130 lb	8073470	12.99	8073496	14.99	8073488	9.99

Heavy Duty Casters

- Corrosion-resistant grey metallic finish
- Double ball bearing raceway, roller bearing



Wheel Size	Load Cap.	Swivel			Wheel Only			
		Wt. (lb)	ITEM	PRICE	Bore	Wt. (lb)	ITEM	PRICE
5" x 2"	1,000 lb	4.3	8005900	25.99	-	-	-	-
6" x 2"	1100 lb	4.7	8005898	27.99	3/4"	1.4	8005903	12.99

3" Thermoplastic Rubber Casters

- Unique thermoplastic rubber construction resists chemicals, caustics, oils, acids, and wear
- Rugged polypropylene hub won't dent, mar, fade, or stain
- Non-marking, soft cushioned wheels



Wheel Size	Load Cap.	Overall Height	Swivel		Rigid		w/Brake	
			ITEM	PRICE	ITEM	PRICE	ITEM	PRICE
3"	180 lb	4"	8113144	12.99	8113151	9.99	8113169	14.99
4"	250 lb	5"	8039869	14.99	8005921	12.99	8005917	16.99
5"	300 lb	6"	8039885	16.99	8039893	14.99	8005888	18.99
6"	550 lb	7"	8115248	22.99	8041147	21.99	8041121	24.99

CASTER CAPACITY RATINGS

Capacity ratings are based on intermittent use at a speed not exceeding 3 mph over smooth floors in a manual operation under ideal conditions. Since conditions are never ideal, select a caster with a much higher capacity than the weight you require.

Polyamide Casters

- Reduces noise and vibration in distribution applications, without high rolling resistance
- Non-marking wheel
- Roller bearings protected by thread guards



Wheel Size	Load Cap.	Swivel		Rigid		Swivel w/Brake	
		ITEM	PRICE	ITEM	PRICE	ITEM	PRICE
5"	440 lb	8161564	19.99	8161572	16.99	8161580	22.99

Phenolic Casters

- High impact, high strength wheels resistant to oil, gasoline, even dilute acids
- Top plate is made with 1/4" forged cold steel
- Wheel bearings are straight roller 3/4" with spanner bushings



Wheel Size	Load Cap.	Swivel		Rigid		Swivel w/Brake	
		ITEM	PRICE	ITEM	PRICE	ITEM	PRICE
4"	500 lb	8161440	19.99	8161457	17.99	8161465	21.99
6"	840 lb	8161473	24.99	8161481	22.99	8161499	26.99

White Nylon Casters

- Unbreakable under heavy loads and runs easy on smooth floors
- Precision bearings contribute to easy and quiet roll
- Non-marking, resistant to oils, alkalis, soaps and detergents
- Works in wet environments
- Dust-sealed



Dyna-tred Casters



Wheel Size	Load Cap.	Overall Height	Swivel		Rigid		Swivel w/Brake	
			ITEM	PRICE	ITEM	PRICE	ITEM	PRICE
5"	330 lb	6-1/4"	8005895	17.99	8005889	13.99	8005897	19.99

Wheel Size	Load Cap.	Swivel		Rigid		Swivel w/Brake	
		ITEM	PRICE	ITEM	PRICE	ITEM	PRICE
4"	700 lb	8161788	29.99	8161812	24.99	8161804	34.99



Stem Casters

- Soft and smooth rolling thermoplastic wheel on polypropylene hub
- Resists oil, acid, caustics, and chemicals
- Won't dent, mar, fade, stain



Wheel Size	Load Cap.	Swivel			Swivel w/Brake		
		Wt. (lb)	ITEM	PRICE	Wt. (lb)	ITEM	PRICE
2" x 13/16"	125 lb	0.4	8039901	4.49	0.3	8005919	4.99
3" x 13/16"	175 lb	0.5	8039919	5.49	0.5	8005920	5.99

Threaded Stem Swivel Casters

- 1-1/2" long stem
- Self-lubricating bearing
- Soft rubber wheels for heavy loads on smooth hard surfaces and finished concrete floors for quiet movement and floor protection



Wheel Size	Stem Size	Load Cap.	Swivel		Swivel w/Brake			
			Wt. (lb)	ITEM	PRICE	Wt. (lb)	ITEM	PRICE
2"	3/8" x 16	80 lb	0.4	2041176	3.49	0.4	8161507	5.49
3" x 13/16"	3/8" x 16	90 lb	0.6	2041184	4.49	0.6	8161515	6.49
4" x 15/16"	1/2" x 13	115 lb	1.2	2041192	7.99	1.3	8161523	9.99

Precision Bearing Casters

- Thermoplastic polyurethane wheel for high load capacity and extended wear
- Heavy gauge steel top plate
- Corrosion resistant
- Protects floors and resists chemicals, caustics, acids and oils



Wheel Size	Overall Height	Load Cap.	Swivel		Rigid		Swivel w/Brake	
			ITEM	PRICE	ITEM	PRICE	ITEM	PRICE
3"	3-13/16"	225 lb	8074197	14.99	8074213	12.99	8074205	15.99
4"	5"	300 lb	8161531	16.99	-	-	8161549	17.99

Sintered Iron Casters

- Cast-Iron wheels have an exceptionally long wear life and can withstand temperature extremes
- Recommended for infrequently moved objects on rough wood and concrete floors



Wheel Size	Overall Height	Load Cap.	Swivel		Rigid			
			Wt. (lb)	ITEM	PRICE	Wt. (lb)	ITEM	PRICE
2" x 7/8"	2-1/2"	125 lb	0.7	2040151	4.99	0.6	2040155	3.99
2-1/2" x 1"	3-1/4"	175 lb	1.2	2040153	7.99	1.2	2040156	6.99
3" x 1-1/8"	3-3/4"	250 lb	1.8	2040154	9.99	1.6	2040157	8.99

Semi Steel Casters

- Mould-on polyurethane on steel hub
- Polyurethane wheels are durable, protect floors and resist oils and chemicals



Wheel Size	Overall Height	Load Cap.	Swivel		Rigid		Swivel w/Brake	
			ITEM	PRICE	ITEM	PRICE	ITEM	PRICE
6"	7"	2,000 lb	2040289	33.99	2040290	31.99	2040288	35.99
8"	9"	3,000 lb	2040292	42.99	2040294	39.99	2040291	44.99



2" Twin Wheel Swivel Caster

- Combines compact size and high load capacity
 - Load capacity: 200 lb
- 8067860 – Wt. 1.0 lb **8⁹⁹**



8" Pneumatic Casters

- 4" x 4-1/2" top plate
- 4-ply tire



Wheel Size	Overall Height	Load Cap.	Swivel		Rigid	
			ITEM	PRICE	ITEM	PRICE
2.50-4	8"	300 lb	2040115	24.99	2040116	22.99
3.50-4	10"	350 lb	2040113	29.99	2040114	27.99
4.10/3.50-4	12"	350 lb	2041291	54.99	2040063	49.99

Steel Casters



	Wheel Size	Overall Height	Load Cap.	Swivel		Rigid	
				ITEM	PRICE	ITEM	PRICE
A	2"	3"	300 lb	2040295	4.49	2040296	3.99
B	4"	5-1/2"	660 lb	2040255	19.99	2040256	17.99
C	6"	7"	1,100 lb	2040258	26.99	2040257	24.99
D	8"	9-1/2"	1,320 lb	2040260	29.99	2040259	27.99

Dyna-tred Casters

Thermoplastic rubber wheel



Wheel Size	Overall Height	Swivel		Rigid		Swivel w/Brake	
		ITEM	PRICE	ITEM	PRICE	ITEM	PRICE
4"	5-1/4"	2040297	9.99	2040298	8.99	8165144	12.99

500 lb Scaffolding Caster

- 8" dia. x 2" wheel
 - 1-3/8" dia. x 4" stem
 - 9-1/2" overall height from floor to base of stem
 - 500 lb safe rolling capacity
 - Long lasting vulcanized rubber wheel
 - Hand or foot operated brake locks swivel and wheel
- 2040254 – Wt. 13.0 lb **39⁹⁹**



6" Tri-Dolly

- Load capacity: 200 lb
- Polyolefin swivel casters
- Steel ball bearings



6" Dia.
8026520 – Wt. 0.7 lb **10⁹⁹**

12" Dia.
8073330 – Wt. 2.3 lb **21⁹⁹**

NEVER MISS ANOTHER DEAL!



At princessauto.com, you can always flip through our current sales flyer. Sign up for our E-flyer so that you're among the first to hear about our latest offers

Hardware

Heavy Duty Eyebolts



Thread Size	Length	Safe Working Load	Ultimate Load	Wt. (lb)	ITEM	PRICE
1/4"-20	3-3/8"	400 lb	3,000 lb	0.1	8271462	2.49
5/16" - 18	2-1/8"	1,000 lb	4,000 lb	0.1	8271470	2.69
3/8 - 16	2-1/4"	1,400 lb	6,000 lb	0.2	8271488	3.49
1/2" - 13	2-1/2"	2,000 lb	7,800 lb	0.4	8271496	4.99
5/8" - 11	2-3/4"	2,600 lb	10,000 lb	0.8	8271504	6.99
3/4" - 10	3"	6,000 lb	24,000 lb	1.2	8271512	8.99

Threaded Rods

Grade 2 metal 1/4" - 20 Thread Size



Thread Size	Length	Wt. (lb)	ITEM	PRICE
1/4" - 20	36"	0.4	8001852	1.99
5/16" - 18	36"	0.6	8001853	2.39
3/8" - 16	36"	0.9	8001855	2.69
3/8" - 16	120"	2.9	8001856	5.79
7/16" - 14	36"	1.0	8001857	3.39
1/2" - 13	36"	1.6	8001858	3.99
1/2" - 13	120"	5.3	8001859	9.99
5/8" - 11	36"	2.3	8001860	6.49
5/8" - 11	120"	8.3	8001861	16.99
3/4" - 10	36"	3.7	8001862	8.99
1" - 8	36"	6.5	8001863	13.99



Hinges

- 6" hinges are 3.0 mm steel
- 8" and 10" are 3.4 mm steel Zinc plated T style 3.0 mm steel



Size	J) Zinc Plated			K) Black Powder Coating			
	Wt. (lb)	ITEM	PRICE	Wt. (lb)	ITEM	PRICE	
Hinge	6"	0.8	8075624	3.99	0.8	8116733	7.99
	8"	1.4	8075632	4.99	1.4	8116741	8.99
	10"	1.9	8075640	7.99	1.9	8116758	11.99
Strap	6"	0.8	8075673	3.99	-	-	-
	8"	1.3	8075681	4.99	-	-	-
	10"	1.8	8075699	7.99	-	-	-

Permalign Gate Hinges

- Hinges feature 3-sided and 2-sided designs which wrap around points of attachment allowing hinges to withstand greater loads than conventional hinges
- 13 gauge steel (2.3 mm) Butt with Strap style



Hinge Style	Wt. (lb)	ITEM	PRICE	
V	Butt with Strap	0.7	8075541	4.79
W	3-Sided Post with Strap	1.0	8075533	5.79
X	3-Sided Leaf Post	1.2	8075525	6.79



Stainless Steel Hardware Kits



Pieces	Kits	Wt. (lb)	ITEM	PRICE
A	250 Flat & Lock Washers	0.5	8160558	14.99
B	225 Snap Rings	0.5	8160590	24.99
C	475 Nut & Bolt	1.4	8160616	39.99
D	300 Nut	1.1	8160574	14.99

Hardware Kits



Pcs	Kits	Wt. (lb)	ITEM	PRICE
E	150 Nylon Insert	2.0	8002548	6.99
F	240 Washers	2.3	8092207	9.99
	347 SAE	1.0	8092181	9.99
G	347 Metric	1.1	8092199	9.99
	146 Assorted	1.3	8092231	12.99

O-Ring Kits



Pcs	Kits	Wt. (lb)	ITEM	PRICE
H	54 Automotive	0.5	3801032	11.99
	225 -	0.4	3801073	11.99
I	407 -	2.0	8025353	19.99

Washer Sets

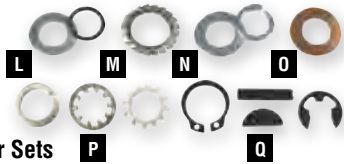

Pcs	Kits	Wt (lb)	ITEM	PRICE
L	54 Assorted	0.1	8127763	2.99
M	200 Anti-vibration	0.5	8002542	9.99
N	250 Flat & Lock	0.6	8002541	9.99
O	110 Copper	0.9	8092215	19.99
P	720 Lock	0.7	8002540	11.99
Q	460 Shop Kit	1.5	8002543	16.99

Snap Ring & E-Clip Kits



Pcs	Kits	Wt. (lb)	ITEM	PRICE
R	100 Internal Snap Rings	0.3	3800502	4.99
S	300 External Snap Rings	0.7	3801024	11.99
T	150 E-Clips	0.7	8059065	7.99
	300 E-Clips	1.3	3801016	11.99
U	225 Snap Rings	0.6	8002539	11.99



Y) 360 pc Household Hardware Assortment
Includes cup hooks, picture hangers, push pins, thumb tacks, brads, plastic anchors, screws and nails
8319402 - Wt. 0.9 lb **6⁹⁹**

Z) 172 pc Hex Bolt Kit
• 1/4", 5/16" and 3/8" sizes
• Includes nuts, bolts and washers
8319360 - Wt. 2.5 lb **9⁹⁹**



1001 pc Assorted Nut and Bolt Kit with Cabinet
8092249 - Wt. 4.2 lb **24⁹⁹**



1) 151 pc Eye Bolt & Hook Set
8002547 - Wt. 1.5 lb **11⁹⁹**

2) 106 pc Allen Cap Screw Kit
8092223 - Wt. 1.5 lb **12⁹⁹**



Cotter Pin Kits
144 Cotter Pin Kit with Spreader / Remover Tool
 3800893 - Wt. 0.4 lb **2⁹⁹**

144 Stainless Steel Cotter Pin Kit with Spreader / Remover Tool
 8117814 - Wt. 0.3 lb **5⁹⁹**

144 Large Cotter Pin Kit
 3800535 - Wt. 2.8 lb **14⁹⁹**

555 Cotter Pin Kit
 3801065 - Wt. 2.1 lb **9⁹⁹**

1,000 pc Cotter Pin Kit
 8002535 - Wt. 3.0 lb **14⁹⁹**

555 pc Stainless Steel Cotter Pin Kit
 8117830 - Wt. 1.9 lb **24⁹⁹**

144 pc Large Stainless Steel Cotter Pin Kit
 8117848 - Wt. 2.9 lb **24⁹⁹**

Roll Pin Kits
120 pc Roll Pin Kit
 3802238 - Wt. 0.9 lb **9⁹⁹**

315 pc Roll Pin Kit
 3801040 - Wt. 2.0 lb **19⁹⁹**



Pin Kits
A) 20 pc Clevis Pin Kit
 8002544 - Wt. 1.1 lb **9⁹⁹**

B) 71 pc Universal Clevis Pin Kit
 8059032 - Wt. 2.4 lb **16⁹⁹**

C) 150 pc Hair Pin Kit
 8002536 - Wt. 1.2 lb **12⁹⁹**

200 pc Spring Kit
 3801008 - Wt. 1.0 lb **11⁹⁹**

150 pc Wing Nut Kit
 8092140 - Wt. 1.3 lb **14⁹⁹**

158 pc Wire Connector Kit
 8068785 - Wt. 0.6 lb **15⁹⁹**

80 pc Picture Hanging Kit
 8319345 - Wt. 0.4 lb **3⁴⁹**

Twin Clevises

- Yellow zinc coated alloy steel
- Grade 70, heat treated



Size	Safe Working Load	Wt. (lb)	ITEM	PRICE
1/4"-5/16"	4,700 lb	0.4	3804580	4.99
3/8"	6,600 lb	0.5	3804598	5.99
7/16"-1/2"	11,300 lb	1.2	3804572	7.99

Eye Hooks

- Forged carbon steel, quenched and tempered
- Complete with spring latch



	Working Load (Metric tons)	Eye Dia.	O'all Length	Wt. (lb)	ITEM	PRICE
H) Solid	3/4	3/4"	4-1/2"	0.5	3800283	3.99
	1	29/32"	5"	0.8	3800284	4.99
	1-1/2	1-1/8"	5-1/2"	1.4	3800285	6.99
	2	1-3/16"	6-3/8"	2.1	3800286	8.49
	3	1-1/2"	8"	3.8	3800287	13.99
I) Swivel	3/4	15/16" x 1-1/4"	5-7/8"	0.8	3800330	5.99
	1	1-5/16" x 1-1/2"	6-1/2"	1.4	3800332	7.99
	1-1/2	1-5/8" x 1-3/4"	7-1/2"	2.4	3800333	11.49
	2	1-9/16" x 1-3/4"	8-1/2"	2.8	3800335	12.99
	3	1-3/4" x 2"	9-1/2"	5.4	3800336	19.99

5/8" Grade 70 Tractor Tow Hook

- Working load: 1,200 lb
- Breaking strength: 4,500 lb
- Pin dia.: 3/4"
- Hook throat: 5/8"

8017852 - Wt. 3.0 lb **19⁹⁹**



Chains & Hooks



Grade 30 Self-Coloured Chain
 3/16" Safe working load: 800 lb

Size	Safe Working Load	Wt. (lb)	ITEM	PRICE /ft
3/16"	800 lb	0.4	3805876	1.19
1/4"	1,300 lb	0.2	3805884	1.99
5/16"	1,900 lb	1.1	3805892	3.49
3/8"	2,650 lb	1.4	3805900	3.99

Grade 30 Electric Galvanized Chain
 Bright finish with increased rust resistance

Size	Safe Working Load	Wt. (lb)	ITEM	PRICE /ft
3/16"	800 lb	0.4	3804770	1.29
1/4"	1,300 lb	0.7	3804788	1.99
5/16"	1,900 lb	1.1	3800495	2.99
3/8"	2,650 lb	1.5	3800496	3.99

Grade 30 Hot Dipped Galvanized Chain
 High quality rust resistant coating

Size	Safe Working Load	Wt. (lb)	ITEM	PRICE /ft
3/16"	800 lb	0.4	3800498	1.49
1/4"	1,300 lb	0.7	3800499	2.39
5/16"	1,900 lb	1.1	3800500	3.49
3/8"	2,650 lb	1.3	3800501	4.49



Grade 70 Transport Chain

Size	Safe Working Load	Wt. (lb)	ITEM	PRICE /ft
1/4"	3,150 lb	0.6	8259459	2.99
5/16"	4,700 lb	1.0	8259467	3.49
3/8"	6,600 lb	1.4	8259475	4.99

Loadbinders

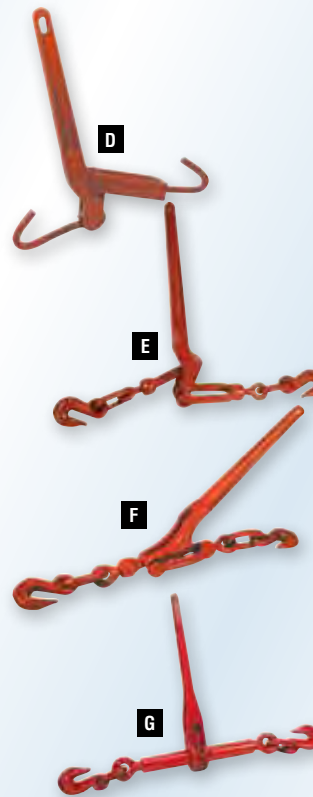

D) 3/16" to 1/4" Loadbinder

- Safe working load: 375 lb
 - Breaking strength: 1,250 lb
- 3800752 - Wt. 1.5 lb **9⁹⁹**

E) 1/4" to 5/16" Loadbinder

- Safe working load: 2,600 lb
 - Breaking strength: 7,800 lb
- 3800030 - Wt. 3.4 lb **19⁹⁹**

F) 5/16" or 3/8" Heavy Duty Loadbinder

- Safe working load: 5,400 lb
 - Breaking strength: 19,000 lb
- 3800778 - Wt. 7.9 lb **29⁹⁹**

G) 5/16" or 3/8" Ratchet Loadbinder

- Safe working load: 5,400 lb
 - Breaking strength: 19,000 lb
- 3800031 - Wt. 10.0 lb **39⁹⁹**

Chain Accessories



Quick Links

- Time saving connector for chain connections, sling chains, tire chains
- Bright finish electro-galvanized

Safe Working Load	Size	L x W (in.)	Wt. (lb)	ITEM	PRICE
660 lb	3/16"	2 x 1	0.1	3800289	1.59
880 lb	1/4"	2-1/4 x 1-1/8	0.1	3800290	1.69
1,760 lb	5/16"	3 x 1-1/2	0.2	3800291	2.29
2,200 lb	3/8"	3-5/8 x 1-3/4	0.3	3800292	2.79
2,460 lb	7/16"	3-7/8 x 1-7/8	0.4	3800293	3.29

High Tensile Anchor Shackles

- Body C 1045 forged carbon steel
- Breaking load 6 times safe working load
- Alloy steel pins
- Heavy duty galvanized body
- Load rated

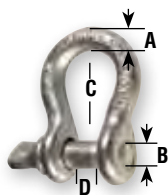

(A) Shackle Size	(B) Pin Dia.	(C) Depth	(D) Throat	Working Load (Metric Tons)	Wt. (lb)	ITEM	PRICE
3/16"	1/4"	7/8"	5/16"	1/3	0.1	3800347	1.99
1/4"	5/16"	1-1/8"	1/2"	1/2	0.1	3800386	2.29
5/16"	3/8"	1-1/4"	1/2"	3/4	0.2	3800387	2.49
3/8"	7/16"	1-1/2"	5/8"	1	0.3	3800388	2.99
7/16"	1/2"	1-3/4"	3/4"	1-1/2	0.4	3800389	3.29
1/2"	5/8"	1-7/8"	3/4"	2	0.7	3800390	3.99
5/8"	3/4"	2-1/4"	1"	3-1/4	1.2	3800391	6.99
3/4"	7/8"	2-3/4"	1-3/16"	4-3/4	2.4	3800392	9.99
7/8"	1"	3-1/2"	1-1/2"	6-1/3	3.7	3800393	13.99
1"	1-1/8"	3-3/4"	1-3/4"	8-1/2	5.2	3800394	18.99



Galvanized Cable by the Foot

- Excellent for winching and towing
- Flexible pre-formed 7 x 7 construction
- Electro galvanized finish

3800378 – (7 x 7) 1/8"	19¢
3800379 – (7 x 19) 3/16"	29¢
3800381 – (7 x 19) 3/18" PVC coated to 1/4"	39¢
3800382 – (7 x 19) 1/4"	39¢

Galvanized Cable

- Excellent for winching & towing
- Flexible pre-formed 7 x 7 construction

Dia.	Breaking Strength	50 ft Coil			100 ft Coil			150 ft Coil		
		Wt. (lb)	ITEM	PRICE	Wt. (lb)	ITEM	PRICE	Wt. (lb)	ITEM	PRICE
1/8**	2,000 lb	1.3	3820049	9.99	2.6	3820048	18.99	4.0	3820050	26.99
5/32"	2,800 lb	2.1	3821048	11.99	3.8	3821055	23.99	6.3	3820051	29.99
3/16"	4,200 lb	3.0	3821063	14.99	6.2	3821071	24.99	9.3	3820052	39.99
1/4"	7,000 lb	5.9	3821089	19.99	10.9	3821097	34.99	15.9	3821105	49.99
5/16"	9,800 lb	8.3	3821113	26.99	16.7	3821121	49.99	–	–	–
3/8"	14,400 lb	12.5	3821147	34.99	24.8	3821154	59.99	–	–	–
1/2**	23,600 lb	20.8	3821170	49.99	–	–	–	–	–	–

**1/8" cable is 7 x 7 construction

Grab & Slip Hooks

Grade 30

Galvanized, forged carbon steel

A) Slip Hook



Size	Safe Working Load	Wt. (lb)	ITEM	PRICE
1/4"	1,950 lb	0.5	3800059	2.79
5/16"	2,875 lb	0.8	3800067	2.99
3/8"	4,000 lb	1.3	3800075	4.99

C) Slip Hook with Latch

Size	Safe Working Load	Wt. (lb)	ITEM	PRICE
1/4"	1,950 lb	0.5	3800337	4.49
5/16"	2,875 lb	0.9	3800338	5.49
3/8"	4,000 lb	1.4	3800339	7.49
1/2"	6,500 lb	3.1	3800340	14.99

Grade 43 & 70

- Yellow zinc coated alloy steel
- Heat treated

B) Grade 43 Grab Hook

Size	Safe Working Load	Wt. (lb)	ITEM	PRICE
1/4"	2,600 lb	0.4	3800000	2.79
5/16"	3,900 lb	0.7	3800018	3.49
3/8"	5,400 lb	1.0	3800026	3.99

C) Grade 70 Slip Hook

Size	Safe Working Load	Wt. (lb)	ITEM	PRICE
1/4"	2,750 lb	0.6	3800344	4.29
5/16"	4,300 lb	0.8	3800345	5.29
3/8"	5,250 lb	1.3	3800346	6.49

B) Grade 70 Grab Hook

Size	Safe Working Load	Wt. (lb)	ITEM	PRICE
1/4"	3,600 lb	0.4	3800343	3.99
5/16"	5,400 lb	0.8	3805371	4.49
3/8"	7,500 lb	1.1	3805389	5.99

D) Grade 70 Grab Hook with Latch

Size	Safe Working Load	Wt. (lb)	ITEM	PRICE
1/4"	3,600 lb	0.6	3800631	4.99
5/16"	5,400 lb	1.0	3800632	6.49
3/8"	7,500 lb	1.4	3800633	7.99

WIRE ROPE CLIPS

Wire rope clips are ideal for forming a loop. When properly attached, they could reach an efficiency of 85%. Some things to remember when attaching rope clips are: 1) All clip bases must rest against the "live" part of the rope, the U-bolt against the "dead" part. 2) Do not over tighten first and last clips. 3) Both nuts on each clip should be tightened to the same degree. 4) For 1/8" to 1/2" cable – a minimum of 3 clips is recommended.

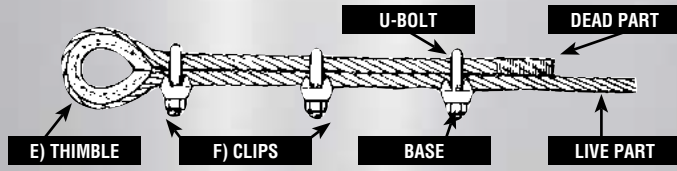

E) 2 pk Wire Rope Thimbles

Size	Wt. (lb)	ITEM	PRICE
1/8"	0.1	8009177	1.29
3/16"	0.1	8009201	1.39
1/4"	0.1	8009227	1.49
5/16"	0.1	8009235	1.59
3/8"	0.1	8009243	1.69
7/16-1/2"	0.2	8009250	1.99

F) 2 pk Wire Rope Clips

Size	Wt. (lb)	ITEM	PRICE
1/8"	0.1	8009268	1.79
3/16"	0.1	8009276	1.99
1/4"	0.2	8032831	1.99
5/16"	0.3	8032849	2.29
3/8"	0.4	8032856	2.79
7/16 to 1/2"	0.7	8032864	3.99

Wire Rope Sleeves

Aluminum sleeves can be used to make eyes or lap stitches in wire rope

Rope Size	# of Pieces	Wt. (lb)	ITEM	PRICE
3/32"	10	0.1	8009060	2.99
1/8"	6	0.1	8009094	2.99
5/32"	6	0.1	8009136	3.99
3/16"	4	0.1	8009151	3.99
1/4"	2	0.1	8009169	3.49

Heavy duty galvanized Turnbuckles

- Forged steel quenched and tempered
- U.S. specification 77-T-791

Safe Working Load	Dia. x Take-up	Wt. (lb)	ITEM	PRICE
3,500 lb	5/8" x 6"	2.1	3800370	9.99
5,200 lb	3/4" x 6"	3.3	3800371	16.99

Rigging Screws

Used to connect and tighten wire rope

Dia. x Take-up	Safe Working Load	Wt. (lb)	ITEM	PRICE
1/4" x 3"	440 lb	0.3	8298481	3.49
5/16" x 2.8"	550 lb	0.6	8298515	3.99
3/8" x 3.4"	660 lb	1.0	8298531	5.99
1/2" x 6.1"	1,300 lb	1.8	8298556	8.99
5/8" x 6.9"	1,700 lb	3.4	8298564	17.99
3/4" x 8.2"	2,400 lb	5.8	8298580	27.99
7/8" x 8.5"	4,400 lb	8.8	8298598	32.99
1" x 9.4"	6,600 lb	11.4	8298614	42.99

12 ft x 1-1/16"

Ratchet Strap Hoist

- 4,000 lb pulling cap.
- Polyester web strap
- Not recommended for lifting

1580869 – Wt. 7.4 lb

39⁹⁹



2 Ton Heavy Duty Ratcheting Cable Hoist

3-hook style 8006441 – Wt. 9.3 lb

29⁹⁹



Aircraft Cable Accessories



Turnbuckles

Forged alloy steel, hot dipped galvanized

Type	Dia. x Take-up	Safe Working Load	Wt. (lb)	ITEM	PRICE
Hook x Hook	5/16" x 4"	700 lb	0.5	8302861	4.99
Hook x Hook	1/4" x 4"	400 lb	0.3	8302853	3.99
A Hook x Hook	3/8" x 6"	1,000 lb	0.8	3800357	7.99
Hook x Hook	1/2" x 6"	1,500 lb	1.6	3800360	9.99
Hook x Hook	1/2" x 9"	1,500 lb	1.9	3800351	11.99
Hook x Eye	5/16" x 4"	700 lb	0.5	8302820	4.99
B Hook x Eye	1/4" x 4"	400 lb	0.3	8302762	3.99
Eye x Eye	1/4" x 4"	500 lb	0.3	8302838	3.99
Eye x Eye	5/16" x 4"	800 lb	0.4	8302846	4.99
C Eye x Eye	3/8" x 6"	1,200 lb	0.7	3800358	7.99
Eye x Eye	1/2" x 6"	2,200 lb	1.5	3800361	9.99
Eye x Eye	1/2" x 9"	2,200 lb	1.9	3800363	12.99
Jaw x Jaw	1/4" x 4"	500 lb	0.4	8302879	3.99
Jaw x Jaw	5/16" x 4"	800 lb	0.5	8302887	4.99
D Jaw x Jaw	3/8" x 6"	1,200 lb	0.8	3800359	9.99
Jaw x Jaw	1/2" x 6"	2,200 lb	1.5	3800362	10.99
Jaw x Jaw	1/2" x 9"	2,200 lb	1.9	3800365	14.99

Packaged Rope

Poly Rope

- 3/8" x 75 ft



- Diamond braid

- Wt. 1.8 lb

8268609 – Orange

8268591 – Black

9⁹⁹ /ea



Polypropylene Twisted Rope

Thread Size	Wt. (lb)	ITEM	PRICE
1/4" x 50 ft	0.5	8268922	3.49
1/4" x 100 ft	1.0	8268971	6.99
3/8" x 50 ft	1.3	8268989	7.49
3/8" x 100 ft	2.3	8268997	13.99



Camo Poly Rope

- 1/8" x 50 ft

8268583 – Wt. 0.2 lb

1/4" x 50 ft

8268476 – Wt. 0.5 lb

3/8" x 100 ft

8268567 – Wt. 0.5 lb

3⁹⁹

7⁹⁹

19⁹⁹



Nylon Rope

Thread Size	Wt. (lb)	ITEM	PRICE
1/4" x 100 ft	1.1	8269052	13.99
3/8" x 50 ft	1.4	8269094	13.99
3/8" x 100 ft	2.7	8269102	21.99

2 mm x 1,800 ft Split Film Twine

8268625 – Wt. 2.5 lb



9⁹⁹

Pulleys



Pulley Blocks

- All steel, bright zinc plated for maximum corrosion resistance
- Oil impregnated bronze bushings
- "Hairpin" clip allows the sheave to be removed easily for rigging

Sheave Dia.	Max. Cable Size	Cap. (lb)	A) Fixed Gable			B) Swivel Eye		
			Wt. (lb)	ITEM	PRICE	Wt. (lb)	ITEM	PRICE
1-1/2"	3/16"	420	0.5	3801479	9.99	0.5	3801420	13.99
2"	3/16"	480	0.7	3801487	13.99	0.8	3801438	16.99
2-1/2"	1/4"	550	1.0	3801495	17.99	1.1	3801446	19.99
3"	1/4"	650	1.2	3801503	22.99	1.2	3801453	22.99
3-1/2"	1/4"	1,250	1.8	3801511	28.99	1.9	3801461	32.99

Sheave Dia.	Max. Cable Size	Cap. (lb)	C) Fixed Flange			D) Sheaves with Bushings*		
			Wt. (lb)	ITEM	PRICE	Wt. (lb)	ITEM	PRICE
1-1/2"	3/16"	420	0.3	3801529	9.99	0.2	3801578	5.99
2"	3/16"	480	0.6	3801537	11.99	0.4	3801586	7.99
2-1/2"	1/4"	550	0.9	3801545	13.99	0.6	3801594	11.99
3"	1/4"	650	-	-	-	0.6	3801602	13.99
3-1/2"	1/4"	1,250	-	-	-	0.8	3801610	16.99

*5/16" bore



Snatch Blocks

Cap. (tons)	Size	Max. Cable Dia.	Wt. (lb)	ITEM	PRICE
1	1/2"	12-1/3"	6.8	3800109	39.99
3	3/4"	19-1/4"	23.4	3801958	59.99

Replacement Sheaves

Cap. (tons)	Size	Max. Cable Dia.	Wt. (lb)	ITEM	PRICE
1	4"	1/2"	2.7	3850781	18.99
2	5"	5/8"	5.2	3850799	24.99
3	6"	3/4"	7.6	3850807	29.99



F - DOUBLE RIGID



E - SINGLE RIGID

G - SINGLE SWIVEL

Pulleys

Type	Sheave Dia.	Max. Cable Dia.	Wt. (lb)	ITEM	PRICE
E	2 pack	1/2"	5/32"	0.1	8003206 2.79
	2 pack	3/4"	5/32"	0.1	8003215 2.99
	2 pack	1"	5/16"	0.2	8003224 4.49
	Single pack	1-1/4"	3/8"	0.2	8003233 3.49
	Single pack	1-1/2"	3/8"	0.2	8003242 3.79
F	Single pack	2"	3/8"	0.5	8003251 6.49
	Single pack	1-1/4"	3/8"	0.4	8003297 5.49
	Single pack	1-1/2"	3/8"	0.4	8003313 5.99
	Single pack	2"	3/8"	0.7	8003322 8.49
	2 pack	1/2"	5/32"	0.1	8003331 2.99
G	2 pack	3/4"	5/32"	0.1	8003340 3.39
	2 pack	1"	5/16"	0.2	8003359 4.79
	Single pack	1-1/4"	3/8"	0.3	8003368 3.29
	Single pack	1-1/2"	3/8"	0.3	8003377 3.49
	Single pack	2"	3/8"	0.5	8003386 4.99

Pulley Blocks

- Ball bearing construction with grease fittings
- Shell construction prevents rope lodging between sheave and shell
- All connections of quality drop forged steel
- Wire rope will not lose position in block even when slack



Outdoor Equipment

Generators



Gasoline Generators

- 389 cc engine with OHV & low oil shutdown
- Recoil start
- Receptacles: four 120V AC outlets; one 120/240V AC twist lock
- 25 litre (6.6 gallon) fuel tank

H) 6,250W
Output: 6,250W max; 5,000W continuous
8348112 – Wt. 167.0 lb... **799⁹⁹**

I) 8,000W
Output: 8,000W max; 6,500W continuous
8348120 – Wt. 173.0 lb... **999⁹⁹**

10,000W Gasoline Generator

- 410 cc engine with OHV & low oil shutdown
 - Output: 10,000W max; 8,000W continuous
 - Electric or recoil start
 - Receptacles: four 120V AC outlets; one 120/240V AC twist lock
 - 34 litre (9 gallon) fuel tank
 - GFCI outlet protection
- 8348138** – Wt. 250.0 lb... **1599⁹⁹**





A) 3,500W Generator

- 6.5 HP OHV engine with low oil shutdown
- Output: 3,500W max., 2,500W continuous
- Receptacles: two 120V AC outlets
- 15 litre (3.96 US gallon) fuel tank capacity runs 11.8 hrs @ 50% load
- Recoil start
- Operating noise: 67 dB

8169260 – Wt. 114.5 lb **449⁹⁹**

B) 6,500W Generator

- 13 HP OHV engine
- Receptacles: four 120V AC; one 120/240V AC; one 12V DC
- 25 litre (6.6 gal.) fuel tank with gauge
- Keyed electric start with remote
- Circuit breaker and low oil shutdown
- Operating noise: 74 dB
- (Battery not included)

8254187 – Wt. 199.4 lb **849⁹⁹**

C) 9,000W Generator

- 15 HP engine with recoil/electric start
- Output: 9,000W max., 7,500W continuous
- Receptacles: Four 120V outlets, one 120V and one 120/240V twist lock outlet, and one 12V (8.3A)
- 8 hours @ 1/2 load on a 7.7 gallon tank
- Hour meter for scheduled maintenance

8255101 – Wt. 244.0 lb **1299⁹⁹**



CLASSIC ACCESSORIES
Generator Covers
 Heavy duty fabric with water resistant coating protects outdoor equipment

Medium
 24" x 16.5" x 16"
8182412 – Wt. 1.1 lb **24⁹⁹**

Large
 32-3/4" x 24-1/2" x 21-1/4"
8182420 – Wt. 1.4 lb **32⁹⁹**

X-Large
 37" x 25" x 27"
8182438 – Wt. 1.8 lb **42⁹⁹**

POWER FIRST
Generator Cover
 • 33"L x 25"W x 25"H
 • 300 denier black polyester construction with elastic cinch band

8244022 – Wt. 0.5 lb **21⁹⁹**

50 ft Generator Extension Cord

- 125V, 20A twist lock male end
- 125V, 15A triple female lighted end
- Remains flexible down to -40°C (-40°F)

8212052 – Wt. 11.9 lb **89⁹⁹**

CLASSIC ACCESSORIES
Snow Blower Cover

- All season protection for your equipment against rust, dirt, and sun damage
- Heavy duty fabric with water resistant coating won't shrink or stretch
- Fits 2-stage snowblowers

8182388 – Wt. 1.7 lb **39⁹⁹**



D) Subaru 4900W Generator

- 9.5 HP OHC engine with low oil shutdown
- Output: 4900W max., 4500 rated
- Recoil start
- Receptacles: 2 GFCI, 2 twist lock
- 26.5 litre (7 gallon) fuel tank capacity
- Run time: 12.7 hours @ 50% rated load, 9.4 hours @ rated load
- Operating noise: 76 dB

8370579 – Wt. 158.0 lb **1099⁹⁹**

E) 1,800W Inverter / Generator

- 3 HP OHC 4-stroke engine
- Output: 1,800W max, 1,600W continuous
- Receptacles: two 120V AC outlets, one 12V DC outlet
- Runs approximately 7 to 8 hrs @ 50% load on one tank of fuel
- Operating noise: 54 dB

8318917 – Wt. 57.2 lb **749⁹⁹**

PEAK VS NET HORSEPOWER RATINGS

Princess Auto advertises our engines in peak or gross horsepower which is different than actual net HP ratings.

The net horsepower is defined as the measured output of the engine at the crankshaft end which would also be defined as the true horsepower of the engine.

The peak or gross horsepower would be the horsepower the engine would produce working at peak efficiency in relatively idealistic atmospheric conditions.

In all cases the net horsepower should be less than the peak / gross horsepower.

Solar Panels

LES PRODUITS
SUNFORCE
PRODUCTS INC.

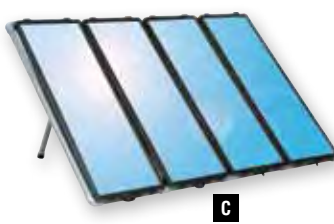
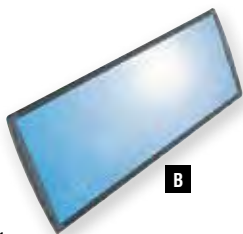
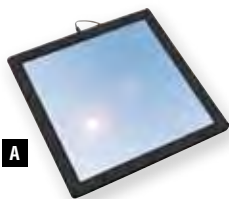

A) 5W 350 mAh Amorphous Solar Battery Trickle Charger

- Maintain automobiles, RVs, tractors, ATVs, electric fences, deer feeders, boats
- Built-in overcharge / discharge protection
- Plug into 12V DC power outlet or attach to battery
- Pre-cut holes for easy installation

8235285 – Wt. 4.6 lb **69⁹⁹**

B) 15W Amorphous Solar Panel with 7A Charge Controller

- For automobiles, RVs, boats, tractors, ATVs, electric fences, deer feeders
- Installs with ease and maintenance free with complete kit
- Blocking diode protects battery discharge

8125155 – Wt. 14.9 lb **149⁹⁹**



Charge Controllers

- Protect battery from overcharge and discharge
- Maintenance free protection of your solar panel and batteries
- Maintains battery voltage
- Maintain 12V batteries in a fully charged state
- For use with 12V solar panels and batteries only

D) 7A Solar Charge Controller

Handles up to 7 amps of current or up to 105 watts of solar power

8332181 – Wt. 0.3 lb **29⁹⁹**

E) 30A Digital Charge Controller

Handles up to 30A of current or up to 450W of solar power

8357030 – Wt. 1.2 lb **139⁹⁹**



110V to 12V Wall Adapter

Great for powering 12V vehicle accessories at home

8030640 – Wt. 1.1 lb **14⁹⁹**

AC/DC Power Converter

- Extends operation of 12V DC devices to 110V AC wall outlet
- For coolers, spotlights, air compressors, TVs, fans, cell phones

8260689 – Wt. 1.3 lb **29⁹⁹**

C) 60W Solar Back Up Kit

- Excellent for power failures, cabins, remote power, back up power, RVs & boats
- Maintenance free, easy installation
- Built-in blocking diodes prevents battery discharge at night
- Works with 12V & 110V appliances
- Weatherproof, shatterproof tempered glass - works in all weather conditions
- Four 15W solar panels, PVC frame for mounting panels, 12V DC plug, alligator battery clamps, mounting screws, extra wiring, 4-in-1 wire connector, 12V DC socket, 200 modified sine wave inverter, 7A solar charge controller

8355141 – Wt. 59.8 lb **449⁹⁹**

12V Solar Power Sports Charger

- Works with motorcycles, personal water crafts, ATV's, snowmobiles, and tractors
- Built-in overcharge / discharge protection
- 1W max. power output

8355117 – Wt. 1.5 lb **24⁹⁹**



Schumacher



Power Inverters

- Built-in, high-speed cooling fan
- ON / OFF switch and LED indicator
- Heavy duty cables – connect directly to vehicle battery
- Ideal for running computers, faxes, cell phones, lights, power tools, TVs, VCRs, stereos, radios, CD players, blenders and portable vacuums in cars, trucks, boats, SUVs and RVs

F) 1,000W Power Inverter

Dual GFCI 120V outlets & 5V USB port
8370959 – Wt. 5.5 lb **159⁹⁹**

G) 2,000W Pro Series Power Inverter

• High-grade thermal protection
• Three GFCI 120V outlets & 5V USB port
8370967 – Wt. 10.3 lb **329⁹⁹**

NEW

Schumacher

2.4W Solar Panel

- 12V battery trickle charger and maintainer
- Comes with wiring adaptors for cigarette lighter, 50 amp battery terminal clips, stainless steel mounting hardware
- Charges in cloudy conditions

8374050 – Wt. 2.6 lb **39⁹⁹**



1,000W Pro Series Pure Sine Wave Inverter

- Provides household power anywhere, converts DC power stored in 12V batteries to AC power
- Delivers 1,000W continuous power and 2,000W peak power
- Pure Sine Wave inverters provide clean power with very low harmonic distortion, no static or humming noise
- Includes remote control

8357089 – Wt. 11.6 lb **299⁹⁹**



Solar Battery Maintainer

For car, SUV, boat, ATV, PWC batteries

8235244 – Wt. 1.6 lb **24⁹⁹**



Digital Power Inverter

- Power inverter digital display indicates voltage in, voltage out, power out
- Connect with 12V plug or clamps
- Two, 110V AC household outlets
- Built-in, high speed cooling fan
- Thermal protection
- Surge protection
- Low battery alarm

410W

8370934 – Wt. 2.2 lb **54⁹⁹**

760W

8370942 – Wt. 3.3 lb **79⁹⁹**

140W Power Inverter with 5V USB Port

- 280 peak watts
- Single 110V AC household outlet
- LED correct-connection indicator
- Surge protection-protects against damaging current fluctuations
- Built-in, high speed cooling fan
- Ideal for laptop computers, video games, radios, etc.

8370926 – Wt. 0.6 lb **34⁹⁹**



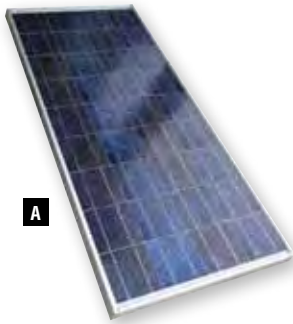

A

A) Solar Panels

- Designed for RVs, homes, boats, back-up & remote power use, 12V battery charging and solar power stations
- High efficiency polycrystalline cells
- Maintenance free, easy installation
- Shatterproof tempered glass
- Rugged aluminum frame
- Includes mounting hardware, bracket, wiring, and Sharp solar module

**Not available at all locations, see www.princessauto.com for special order.*

80W
8355158 – Wt. 26.5 lb **699⁹⁹**

130W
8355166 – Wt. 36.8 lb **999⁹⁹**

PEAK VS NET HORSEPOWER RATINGS

Princess Auto advertises our engines in peak or gross horsepower which is different than actual net HP ratings.

The net horsepower is defined as the measured output of the engine at the crankshaft end which would also be defined as the true horsepower of the engine.

The peak or gross horsepower would be the horsepower the engine would produce working at peak efficiency in relatively idealistic atmospheric conditions.

In all cases the net horsepower should be less than the peak / gross horsepower.

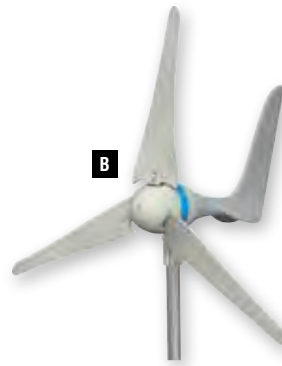

B

B) 600W Wind Turbine

- Charges both 12V and 24V battery banks
- Low noise aerodynamic fiberglass blades
- Safe and efficient charging with Maximum Power Point Tracking Charge Controller
- Weatherproof industrial strength design
- Designed to perform in low wind speeds
- Great for power failures, remote locations, and backup power
- Includes accessory kit, 30A panel meter, and MPPT charge controller

**Not available at all locations, see www.princessauto.com for special order.*
8357147 – Wt. 32.9 lb **899⁹⁹**

NEW

C



C) 30' Wind Turbine Tower Kit

- Easy to install 30 foot wind tower kit for the 600W wind turbine
- Guy wire supported tower uses lightweight tubing while providing plenty of strength
- Lightweight design does not require the use of winches or vehicles to erect this tower

**Not available at all locations, see www.princessauto.com for special order.*

8357188 – Wt. 63.0 lb **649⁹⁹**

Power Equipment

NEW



13 HP Chipper / Shredder

- 13 HP 4-stroke engine
- 5" x 3" chipping capacity
- Recoil start
- 6.5 litre tank
- With hitch attachment
- Displacement: 389cc

8243800 – Wt. 242.0 lb... **999⁹⁹**

Buyers

D) 12V ATV Spreader

- 15 gallon capacity
- Ideal for spreading seed, feed, and fertilizer
- Adjustable shut off gate regulates amount dispersed
- Quick detachable mounting bracket
- Spreads dry product up to 30 feet

8262776 – Wt. 36.7 lb **299⁹⁹**



D

E) 12V ATV Spreader

- 80 lb capacity, rust-resistant hopper
- Spread grass seed, fertilizer, ice melt, and sand
- Controls can be mounted on either side of frame for easy operation with front or rear mounted hopper
- Rain cover and wiring harness with On / Off switch included
- Fits on ATV front or rear racks

8162950 – Wt. 14.4 lb **129⁹⁹**



E

SpeeCo

Post Hole Digger

- Heavy duty drive lines and gear box
- High strength 2-7/8" overall diameter tubing
- Shear bolt protection
- Auger control handle
- Category 1 or 2 hookup
- PTO driveline with plastic safety shield

8314122 – Wt. 179.0 lb **599⁹⁹**



POWER FAST

Muffler Clamps

Fits Pipe Dia.	Wt. (lb)	ITEM	PRICE
1-1/2"	0.2	8059206	2.29
1-5/8"	0.2	8059214	2.29
1-7/8"	0.3	8059230	2.39
2"	0.3	8059248	2.39
2-1/4"	0.3	8059255	2.49
2-1/2"	0.3	8059271	2.79
2-3/4"	0.4	8059289	3.19
3"	0.5	8059297	3.99
3-1/2"	0.5	8059305	4.49
4"	0.6	8059313	5.49



SpeeCo

Auger Blades

- For use with 8314122
- Replaceable cutting edges and screw point

9"
8314130 – Wt. 34.0 lb . **149⁹⁹**

12"
8314148 – Wt. 51.1 lb . **199⁹⁹**

Exhaust Pipe Clamps

8113094 – Wt. 0.8 lb **749**



Tractor Seats

See www.princessauto.com for additional details



A) Black Pan Seat

- Rigid seat
 - 3 drain holes
 - 2 fixed mounting bolts
- 8002694** – Wt. 7.0 lb **39⁹⁹**

B) Economy Tractor Seat

- Moulded cushion, drawn steel pan with protective edge trim
 - Black vinyl cover
- 2060366** – Wt. 10.6 lb **79⁹⁹**

C) Deluxe High Back Steel Pan Seat

- Features air circulation design, water drainage and safety switch cavity
 - Waterproof with drain hole
- Wt. 14.1 lb
8002695 – Black **109⁹⁹** /ea
8062457 – Yellow

D) Deluxe Fold-Down Back Seat

- Heavy duty vinyl cover
 - Horizontal slides
- 8356784** – Wt. 32.1 lb **149⁹⁹**

E) Universal Tractor Seat with Suspension

- Suspension includes hydraulic shock absorber
 - Vinyl-covered moulded cushion
 - Adjustable weight suspension, and base angle
 - Multi-purpose application: agriculture, forklift, and construction
 - Horizontal slide travel: 8-3/4"
- 8032915** – Wt. 44.0 lb **149⁹⁹**

F) Contoured High-Back Seat

- Black vinyl seamless moulded cushion with drawn steel pan and protective edge trim
 - Contoured foam for air flow and drainage
 - Overall dim.: 18-1/2" w x 17-7/16" h x 21-3/4" l
- 8001993** – Wt. 20.0 lb **159⁹⁹**

G) Deluxe High-Back Tractor Seat

- 1-piece, seamless moulded cushion with drawn steel pan, protective edge trim and drain hole
- 2060333** – Wt. 17.0 lb **169⁹⁹**

3-Point Hitch Hardware

3-Point Cat. 1 Quick Hitch

- Fits most Category 1 tractors, for use with Category 1 equipment
- 7/8" mounting pins and adapter bushings
- Maximum Horse Power: 50 HP
- Adjustable top link ball bracket
- Allows quick attachment and release of 3 point hitch implements

8212995 – Wt. 78.0 lb **279⁹⁹**

Adapter Bushing

8224230 – Wt. 3.2 lb **21⁹⁹**



Clevis End Ratchet Jack

- Includes handle and 1" pins
 - 8" travel; adjusts from 20" to 28"
 - Replaces 8" stroke hydraulic cylinders
 - 10,000 lb push, 15,000 lb pull
- 3800013** – Wt. 14.7 lb **59⁹⁹**



Top Links

Heavy duty forged ends with full 1/8" threads ensure maximum strength



Top Link Pins

Cat.	Dia.	Usable	Wt. (lb)	ITEM	PRICE
1	3/4"	2-3/4"	0.5	8215915	2.99
	3/4"	3-7/8"	0.6	8215923	3.49
2	1"	3-9/16"	1.1	8215964	4.99
	1"	4-5/16"	1.3	8215972	5.99



Presto Pins

Dia.	O'all Length	Pin Dia.	Qty.	Wt. (lb)	ITEM	PRICE
3/32"	1-3/4"	3/8"-5/8"	9	0.1	3800241	3.49
1/8"	2-1/16"	1/2"-7/8"	6	0.1	3800242	2.49
5/32"	3"	5/8"-1"	5	0.1	3800243	2.49
3/16"	4-3/16"	3/4"-1-1/4"	2	0.1	3800245	1.49
1/4"	4-1/4"	7/8"-1-1/2"	2	0.3	3800246	1.99
5/16"	3-7/8"	3/4"-1-1/4"	1	0.3	3800247	1.49

PIN DIA.

DIA.



Hitch Pins

- Grade 2 steel
- 1/4" lynch pin on chain
- Swivel handle



Size	Wt. (lb)	ITEM	PRICE
1/2" x 3-1/2"	0.5	8051216	3.49
5/8" x 4-1/2"	0.8	8051234	3.99
5/8" x 6-1/4"	0.9	8051243	4.99
3/4" x 4-1/4"	1.0	8051252	5.49
3/4" x 6-1/4"	1.2	3806817	5.99
7/8" x 6-1/4"	1.6	3806825	7.49
1" x 6-1/4"	2.0	3806833	8.99
1-1/8" x 6-1/4"	2.5	3806841	10.99

H

I

Double Ring Presto Pins

	Pin Dia.	Wt. (lb)	ITEM	PRICE
	3/32"	0.1	3800460	2.49
	5/32"	0.3	3800461	2.99
H	3/16"	0.6	3800462	3.99
	7/32" (2 pk)	0.2	8090425	1.99
I	7/32" (5 pk)	0.6	8123259	3.49



Red Head Hitch Pins

- Grade 5 steel
- 1/8" presto pin
- Solid, welded, plastic dipped handle



	Size	Wt. (lb)	ITEM	PRICE
	3/4" x 4"	1.0	8215998	6.99
	3/4" x 6-1/2"	1.4	8216004	6.99
	7/8" x 6-1/2"	1.7	8216012	7.99
	1" x 7-1/2"	2.4	8216020	9.99



4 pk Linch Pins

	Pin Dia.	Pin Length	Wt. (lb)	ITEM	PRICE
STANDARD	3/16"	1-7/8"	0.1	3800236	1.79
	1/4"	2"	0.2	3800233	1.99
	5/16"	2"	0.3	3800234	1.99
	7/16"	2"	0.4	3800235	2.49
** LONG	7/16"*	2"	0.2	8090466	1.89
	3/8"	2-3/4"	0.2	8090458	1.89
	7/16"	2-1/2"	0.5	3800239	2.99
**	7/16" H.D.	2-1/2"	0.5	3800237	3.49

*7/16" (2 pk) **Heavy Duty

2 pc Linch Pins

	Pin Dia.	Pin Length	Wt. (lb)	ITEM	PRICE
A) Pear	1/4"	2"	0.1	8090482	1.29
	5/16"	2-1/4"	0.1	8090490	1.59
	7/16"	2"	0.2	8090508	1.89
B) Tube	1/4"	2"	0.1	8090516	1.49
	5/16"	2"	0.2	8090524	1.79
	3/8"	2-3/8"	0.3	8090532	2.29



PTO Lock Pins

	Pin Dia.	Usable Length	Overall Length	Wt. (lb)	ITEM	PRICE
C	5/16"	2-1/4"	3"	0.1	3806759	1.59
	1/4"	2-1/4"	3"	0.1	8002034	1.59
D	1/4"	2-1/2"	3"	0.1	8002035	1.89
	5/16"	2-1/2"	3"	0.1	3890478	1.59
E	5/8"	2-1/2"	3"	0.3	8202657	1.99



Lift Arm Pins

Cat.	Shaft Dia.	Thread Size	F) Type A				G) Type B			
			Length	Usable Length	ITEM	PRICE	Length	Usable Length	ITEM	PRICE
1	7/8"	7/8"-14	5-1/2"	1-3/4"	8216244	4.99	1	1	8216228	4.99
1	7/8"	7/8"-14	5-1/2"	2-1/4"	8216145	6.99	1	1	8216236	6.99
1 to 2	1-1/8"	7/8"-14	5-1/4"	1-3/4"	8216194	8.99	1	1 to 2	8216152	8.99
2	1-1/8"	1-1/8"-12	6-5/16"	2"	8216210	9.99	1	2	8216202	9.99



Ball Ends

Cat.	H	I	J	K	L	M	Wt. (lb)	ITEM	PRICE
1	2"	3/4"	1-1/8"	1/2"	1-3/4"	2-1/4"	0.9	8216103	14.99
2	2-3/8"	1"	1-1/8"	5/8"	2"	2-5/8"	1.5	8216111	16.99

Stabilizer Pin

- 5/8"-18 NF thread
 - Shank 7/8" dia. x 2-5/8" long
- 8215980 – Wt. 0.4 lb **3.49**



2 pk Safety Pins

- Wt. 0.1 lb
- 8090433 – 1/8" x 4-1/8" **1.49**
- 8090441 – 5/32" x 4-1/8" **1.79**



Universal Yoke Pin Kit

- Fits most American PTO yokes
- 8087413 – Wt. 0.2 lb **2.99**



Stay Straps

- Stabilizes 3-point hitch to prevent swaying
- Fits all Ferguson, Ford 2N, 8, 9N, NA A, 600, 700, 800, 900
- Loiver 3-point conversion; MF 35 and 50 wgt.

Lower

8216061 – Wt. 2.1 lb

Upper

8216079 – Wt. 2.5 lb **9.99** /ea



Draw Bar

- 11 holes x 3/4" diameter
 - 26" lift arm spacing
 - 1" thick x 2-1/2" wide
 - 7/8" diameter pins Category 1
- 8215907 – Wt. 15.8 lb **31.99**



Flat Bars

- Fits all Ferguson, MF 35 and 50, Ford 2N, 8N, 9N, 600 and 800



Centre dia.	Overall dim.	Wt. (lb)	ITEM	PRICE
31-9/16"	3/8" x 1-3/4"	7.0	8216087	16.99
33-1/8"	3/8" x 1-3/4"	7.1	8216095	16.99



Deluxe Wheel Spinner

- Split base design allows for quick and easy mounting
 - Attaches securely to all steering wheels up to 1-1/4" thick
- 8337024 – Wt. 0.7 lb **14.99**



Tractor Seat Cover

- Protect your seat against weather and UV damage
 - Cover is coated for maximum water resistance and repellency
 - Elastic shock cord in bottom hem
 - 3 handy back tool and gear
- Wt. 1.2 lb



8223018 – 12" **39.99** /ea

8223026 – 15" **39.99** /ea



Tractor Toolboxes

- Heavy gauge steel
 - Hardware and brackets included
 - 20" L x 7" W x 6" H
- 8213043 – Wt. 9.4 lb **29.99**



Snap Hitch Splined Adapters

- 7" long
 - 1-3/8" x 21 female spline, 1-3/8" x 6 male spline
- Wt. 3.1 lb **39.99**
- 3852753 **39.99**



Splined Adapter Sleeves

- 1-1/8" x 6-spline interior
 - 1-3/8" x 6-spline exterior
- Wt. 0.2 lb **9.99**
- 8087405 **9.99**



Conversion Bushings

	Cat.	I.D.	O.D.	Length	Wt. (lb)	ITEM	PRICE
Top link	2-1	3/4"	1"	1"	0.2	8266918	2.99
	2-1	3/4"	1"	2"	0.4	3800248	4.49
	3-2	1"	1-1/4"	2"	0.5	3800249	5.99
Lift arm	2-1	7/8"	1-1/8"	1-3/8"	0.3	8064867	4.49
	2-1	7/8"	1-1/8"	1-3/4"	0.4	3800250	4.49

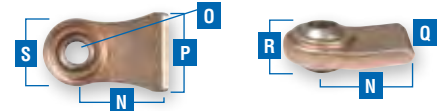
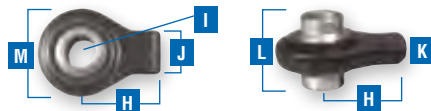

Lift Arm Ball End

Cat.	N	O	P	Q	R	S	Wt. (lb)	ITEM	PRICE
1	2-3/4"	7/8"	2-3/8"	5/8"	1-3/8"	2-5/8"	1.9	8216129	19.99
2	3-1/8"	1-1/8"	2-3/4"	3/4"	1-3/4"	3-1/8"	3.2	8216137	24.99



LOG SPLITTERS, CONSIDER THE JOB DONE!

Log Splitter Models



3-POINT LOG SPLITTER

- Powered by the tractor's hydraulic system
- Vertical or horizontal operation



15 TON LOG SPLITTER

- Horizontal operation
- 8 second cycle time (no load)
- Easy to move around
- Splits logs up to 19"



25 TON LOG SPLITTER

- Honda GC190 engine
- Log catcher comes standard
- Built-in log cradle

35 TON SPLIT MASTER

Plenty of power
for even the
toughest wood!



- Up to 35 tons of splitting force*
- 305cc Briggs & Stratton engine
- Built-in log cradle makes splitting wood quicker, easier and safer
- 7" high wedge
- 4.80 x 8" road type tires

* Tonnage and cycle times may vary dependent upon mechanical and environmental conditions

Accessories



LOG JACK

- Holds logs up to 8" off the ground for clean and safe cutting
- Handles logs from 3" to 15" in diameter



SLIP ON 4-WAY WEDGE

- Fits 22-25 ton log splitters

Available at: **PRINCESS AUTO**



www.princessauto.com



24 second cycle time at no load

Log Splitters



A) 25 Ton Horizontal / Vertical Log Splitter

- Split logs up to 26" in length
- Honda GC 190 gas engine directly coupled to a 2-stage pump
- 7-3/4 gal (29 litre) reservoir capacity
- 2" trailer ball coupler and 4.80 x 8" tires with bearings
- Hydraulic filter for component protection
- Cutting wedge removes for sharpening
- Easily changes from horizontal to vertical splitting
- Hands-free knife return and kick-off for more efficient splitting

8203929 – Wt. 590.0 lb **1699⁹⁹**



In-store assembly included!
(8203929, 8191660 and 8301285)

B) 15 Ton Log Splitter

- Split logs up to 19" long
- 6-1/2 HP OHV engine with low oil shutdown
- 2.5 gallon (9.5 litre) reservoir capacity
- 2" trailer ball coupler and 4.80 x 8" tires with bearings
- Hydraulic filter for component protection
- Hands-free knife return and kick-off for more efficient splitting

8191660 – Wt. 355.0 lb **1149⁹⁹**

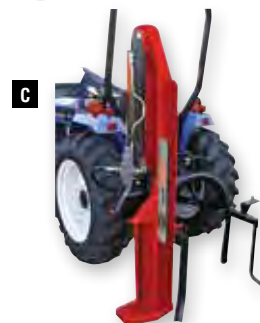

C) 18 Ton 3-Point Hitch Log Splitter

- Splits logs up to 26" in length
- The cycle time is determined by the tractors pump flow rate
- Will produce 18 tons splitting force with a cylinder pressure of 3,000 PSI
- Kick-off valve pressure relief is set at 3,100 PSI
- Works with Category 1 and 2 tractors by hooking directly into the tractor's hydraulic system
- Features include stripper plates to prevent wood from jamming, built-in log cradle, sturdy ground stand and removable cutting wedge

8301285 – Wt. 365.0 lb **899⁹⁹**



Steel Log Jack

- For logs 3" to 15" in dia.
- Hold logs up to 8" off the ground for clean and safe cutting
- Converts into a cant hook to remove logs

8217283 – Wt. 14.5 lb **59⁹⁹**



Log Splitter Covers

- Protects log splitter from the elements
- Made of heavy PVC coated polyester
- UV and mildew resistant

For 22 to 35 Ton Log Splitter
8217259 – Wt. 7.1 lb **69⁹⁹**

NEW

35 Ton 342cc Log Splitter

- Horizontal or vertical splitting
- Engine: Briggs & Stratton 1450 Series
- Pump: two-stage 16 gpm
- Max log length: 26"
- Cycle time: 14 Seconds

8377400 – Wt. 675.0 lb **1999⁹⁹**

NEW

15 Ton Log Catcher

- Holds half the log while the other half is being split
- Attaches to the end of the 15 ton log splitter beam

8267890 – Wt. 20.5 lb **69⁹⁹**



4-Way Log Splitter Knife
8364903 – Wt. 6.6 lb **79⁹⁹**

NEW



- Splits logs up to 20" in length
- Two hand safe splitting operation, hands-free retraction
- 12 second cycle time
- 120V AC, 2 HP electric motor
- Recommended extension cord if needed: 14/3 ga up to 25 ft

D) 4 Ton Electric Log Splitter with Stand
3/4 gallon (3 litre) reservoir capacity
8197824 – Wt. 120.0 lb **329⁹⁹**

E) 5 Ton Electric Log Splitter
• 0.6 gallon (2.25 litre) reservoir capacity
• Adjustable stroke length for shorter cycle times
8142606 – Wt. 110.2 lb **369⁹⁹**

F) 5 Ton Electric Log Splitter Stand
Raises the log splitter to reduce bending and back strain
8222879 – Wt. 13.4 lb **39⁹⁹**



NEW

6.5 HP Gas Powered Sweeper

- Recoil start
- 5 forward speeds
- 40" sweep width

8304131 – Wt. 304.0 lb **1199⁹⁹**

17-1/2" Log Tongs

- Designed to grab hold of logs and poles for dragging operations
- Shaped to increase the tip penetration and provide a better hold
- Max. holding capacity: 750 lb
- Jaw opening width: 2-1/2" to 17-1/2"

8239139 – Wt. 9.2 lb **39⁹⁹**

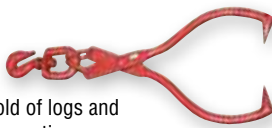

37" Red Solar Driveway Marker

- Bright LED lasts up to 8 hours
- 37" pole and spike

Wt. 0.6 lb

8291049 – Red

8291056 – Orange **9⁹⁹** /ea

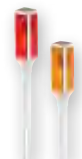

4 ft Driveway Markers

- 5/16" solid steel rod
- 3-1/2" diamond shape steel head

Wt. 1.5 lb

8228116 – Lime

8228132 – Yellow **9⁹⁹** /ea

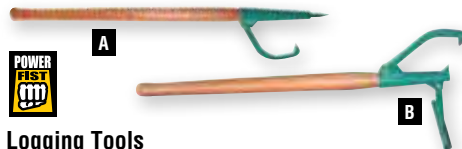

Logging Tools

- Eucalyptus wood handle
- Powder-coated finish

Wt. 9.9 lb

A) 8321515 – 48" Industrial Peavey

B) 8321531 – 36" Timber Jack **59⁹⁹** /ea

PEAK VS NET HORSEPOWER RATINGS

Princess Auto advertises our engines in peak or gross horsepower which is different than actual net HP ratings. The net horsepower is defined as the measured output of the engine at the crankshaft end which would also be defined as the true horsepower of the engine.

The peak or gross horsepower would be the horsepower the engine would produce working at peak efficiency in relatively idealistic atmospheric conditions.

In all cases the net horsepower should be less than the peak/gross horsepower.

35" Red Driveway Marker

- 3" dia. reflector
- 35" galvanized post

4200187 – Wt. 0.3 lb

2⁹⁹



14" x 16" Reflective Slow Moving Signs

	Type	Wt.(lb)	ITEM	PRICE
C	Adhesive decal	0.2	5040170	6.99
D	ABS	0.5	5040449	8.99
	Metal	1.7	5040079	9.99

POWER FAST

Engine Cover

- Fits most standard grain auger motors and log splitters
- Heavy 1/4" rope drawstring holds cover secure
- Silver exterior reflects heat and sunlight
- O'all dim.: 23" x 19" x 24" high

2480016 – Wt. 0.5 lb **10⁹⁹**



POWER FAST

36" Timber Jack

- Steel Handle : Q235 A steel tub (32 x 2 mm) with Plastic Grip
- Surface Finishing : Powder-coating

8321507 – Wt. 9.5 lb **49⁹⁹**



Original Brush Grubber

- Easy and effective way to clear brush
- Handles small tree stumps & brush 1/2" up to 3" in size
- Strong jaws that open wide to handle bigger brush
- Use with lawn tractor, ATV, and light utility tractors
- 16 gripping teeth
- Great for clearing fence lines

8240681 – Wt. 6.6 lb **79⁹⁹**



Princess Auto
Foundation



Together we are making a difference

for our future customers. By providing bursaries to Canadian Colleges throughout Canada we demonstrate our support for the trades.

Work with the hands-give from the heart.

For more information visit us at

www.theprincessautofoundation.com

PAF PARTNERS

MONDETTA



Charitable # 833179369 RR00041

Recreational

Recreational Equipment



Portable Butane Gas Stove

- 8,000 BTU
- Fuel: Direct pressure butane gas (not included)
- With adjustable flame
- Ignition: Auto-Ignition, can be used at least 30,000 times
- Safety device: double sealed valve, overpressure protection, gas leakage prevention, incorrect placement prevention
- Replacement butane cannister item #8265894

8254658 – Wt. 4.5 lb **29⁹⁹**

Cast Iron Frying Pans

6" 8267882 – Wt. 2.2 lb **8⁹⁹**

8" 8267916 – Wt. 4.3 lb **10⁹⁹**

10" 8267924 – Wt. 5.9 lb **14⁹⁹**



18" Rebar Stake With Loop

Ideal for anchoring tents & canopies

8354573 – Wt. 0.9 lb **1⁹⁹**

Tent Stakes

11" 8334914 – Wt. 0.1 lb **1⁹⁹**

16" 8334922 – Wt. 0.3 lb **3⁹⁹**



RV Extension Cords

- 10/3 ga STW
- 30A, 125V
- Lighted end with pull handle

25 ft 8193799 – Wt. 7.3 lb **59⁹⁹**

50 ft 8193245 – Wt. 13.9 lb **99⁹⁹**



Tasco 5MP Trail Camera

- Flat grey blends with outdoor & indoor colours for total concealment
- Set up in seconds with locking clasp belt
- Lockable case protects SD card & personal settings
- Video & still photo modes
- Infrared Nightvision LED takes crystal clear photos in the dark with no flash
- 180 day battery life (4 AA)
- SD card & batteries not included

8346348 – Wt. 0.9 lb **119⁹⁹**



D



E



F



G



D) Back Track GPS

- Stores up to 3 locations & provides distance and direction back
- Self-calibrating digital compass
- Weather-resistant
- Lanyard included
- Runs on 2 AAA batteries

8346355 – Wt. 0.5 lb **79⁹⁹**

E) Backtrack 5 Point GPS 8386567 – Wt. 0.5 lb **89⁹⁹**

F) Velocity Gun 8386617 – Wt. 1.4 lb **109⁹⁹**

G) Sport 850 Laser Range Finder 8386583 – Wt. 0.7 lb **239⁹⁹**



Binoculars

A) 10 x 25 mm Binoculars

- Fully coated optics 10 x 25 mm magnification
- Folds away for compact storage
- Includes carrying pouch

8193781 – Wt. 0.5 lb **9⁹⁹**

B) 10 x 25 mm Camo Binoculars

- Portable design for easy storage and transportation
- Outdoors camouflage pattern
- Perfect for the outdoors enthusiast
- Includes case

8193807 – Wt. 0.5 lb **9⁹⁹**

C) 7 x 50 mm Binoculars

- Coated optics
- Perfect for the outdoor enthusiast

8184384 – Wt. 2.1 lb **19⁹⁹**



Wood Burning Stove

- Ideal for outdoor or camp cooking and heating
- 18" depth x 15" height x 13-5/8" width
- 6" flue size
- 28-gauge steel construction with high heat black paint Overall height: 22-3/4"

8282303 – Wt. 10.8 lb **99⁹⁹**



Air-Tight Heater Installation Kit

- Complete kit includes everything required for safe installation of air-tight heaters or camp stoves
- For use with 8282303

8341919 – Wt. 40.2 lb **89⁹⁹**



Fireplace Tongs

Wrought iron construction with powder coat finish

H) Fireplace Tongs

8259251 – Wt. 4.4 lb

I) Fireplace Log Poker

8259285 – Wt. 1.9 lb **15⁹⁹** /ea





Looking for the perfect gift?

GIFT CARDS

are available at any Princess Auto location

Power Sports Accessories



Off-road Helmets

- DOT and SNELL M2005 approved
- Dynamic ventilation design for better air flow and cooling
- Removable / washable comfort liner
- Gloss finish



Size M
8317166 – Wt. 4.4 lb

Size L
8317232 – Wt. 4.4 lb

Size XL
8303422 – Wt. 4.4 lb

Size XXL
8317257 – Wt. 4.4 lb

99⁹⁹
/ea

Helmet Bag

- Fleece lining protects helmet from scuffs and scratches
- 420D tear resistant shell



24⁹⁹



ATV / Snowmobile Mitts

- Help keep hands warm and dry
- Fits over ATV and snowmobile handlebars
- Weather-resistant shell with insulated lining



12⁹⁹



1" x 10 ft Snowmobile Tow Strap

- 750 lb capacity
- Cast hook for pulling source
- Two scissor hook ends for snowmobile skis



12⁹⁹

8087629 – Wt. 1.1 lb



3 pc Snowmobile Dolly Set

- Simplify repairs and storage
- 990 lb capacity



49⁹⁹

8177040 – Wt. 11.4 lb



750 lb Snowmobile Service Lift

- New improved model
- Support bars with rubber padding to secure load
- Main frame base: 2-3/4" tubing
- 3" steel casters with brakes and heavy duty mounts
- Folds for storage



219⁹⁹

8328270 – Wt. 103.0 lb



Adjustable Superclamp II™ Snowmobile Rear Tie-Down System

- Effectively secure snowmobile to your trailer or truck deck with no tie-downs and one easy pull to release
- Fibre filled composite with ribbed silicon pads protect rail and skis
- Strong, durable construction withstands the most adverse elements Screw style deck hook Theft deterrent when used with a standard padlock



Rear
8282279 – Wt. 4.6 lb **149⁹⁹**

Front
8282261 – Wt. 8.0 lb **199⁹⁹**



T-Style Deck Hook

Specifically designed for trailers that have a channel mounting system in the floor

8340077 – Wt. 0.5 lb **14⁹⁹**



Regular Deck Hook

Designed for use in conjunction with Superclamp tie down system, but can also be used for other tie down applications

8340069 – Wt. 0.5 lb **14⁹⁹**



Sled / ATV Super-Glides™

- Provide traction for snowmobiles, ATVs and yourself when loading up onto ramp and into trailer or truck bed
- Moisture minimizing venting prevents premature wood rot
- For all sled / ATV widths and types
- 8 pc 30"L x 8-1/2"W glides
- 48 pc custom shoulder screws



8282287 – Wt. 11.7 lb **114⁹⁹**



Snowmobile Dolly

- Long handle provides increased leverage
- Pneumatic tires for easy movement



1500006
Wt. 53.6 lb **229⁹⁹**

Adjustable Snowmobile Lift

- 7 height adjustments from 20" to 29" with a lift of 7-1/2"
- Prevents track from freezing to the ground
- Protective plate stops flying debris
- Wide hook for greater stability



1500002
Wt. 15.8 lb **59⁹⁹**



Snowmobile Storage Covers

- Water repellent, UV resistant
- Lightweight, durable, non-abrasive fabric
- Double stitched construction, adjustable hem and seam straps
- 100% polyester, will not rot, mildew, stretch, or freeze
- Breathable - allows heat and moisture to escape
- Not recommended for trailering

Black

Size M
8006941 – Wt. 1.9 lb **19⁹⁹**

Size L
8231904 – Wt. 2.2 lb **24⁹⁹**

Size XL
8231912 – Wt. 2.4 lb **29⁹⁹**

Camo

Size M
8220600 – Wt. 2.1 lb **24⁹⁹**

Size L
8231870 – Wt. 2.2 lb **29⁹⁹**

Size XL
8231896 – Wt. 2.4 lb **34⁹⁹**



Deluxe Snowmobile Travel Covers

- Elastic hem cord for a secure fit
- Built-in quick adjusting strap and tension panels secure cover for highway travel
- Heavy duty UV and mildew resistant
- Weather-resistant ProtekX Extreme fabric
- Fabric backing and hood liner protects snowmobile from scratches
- "Never-lose-it" attached storage bag
- Fuel tank access door



Size M
8271207 – Wt. 6.4 lb **114⁹⁹**

Size L
8271215 – Wt. 6.6 lb **124⁹⁹**

Size XL
8271231 – Wt. 6.9 lb **137⁹⁹**



Motorcycle / Off-Road Neck Mask
Wind resistant and breathable
8320814 – Wt. 0.1 lb **9⁹⁹**



Motorcycle / Off-Road Gloves
• Keep your hands especially warm and protected
• Fleece lined for extra comfort
• 420D polyester covering
8320798 – Wt. 1.0 lb **19⁹⁹**



Motorcycle Saddle Bag
• Adjustable hook and loop attachment
• Two zippered storage compartments
8265175 – Wt. 3.3 lb **34⁹⁹**



Motorcycle Covers
• Protection from harsh weather, dirt and harmful UV rays
• Storage bag

G) Standard
Water repellent 200D nylon

H) Deluxe
• Upper panel: scratch resistant 300D nylon with waterproof treatment
• Lower panel: reinforced silver canvas

	Size	Dimensions	Wt.(lb)	ITEM	PRICE
Standard	M	80" x 47" x 36"	1.7	8169617	24.99
	L	90" x 49" x 39"	1.9	8169633	27.99
	XL	97" x 50" x 41"	2.1	8169658	29.99
Deluxe	M	84-1/4" x 47-1/4" x 32-1/2"	3.1	8169609	44.99
	L	105-1/2" x 42" x 40-1/2"	4.1	8169625	54.99
	XL	108-1/2" x 44-1/2" x 43-3/4"	4.4	8169641	64.99
	XXL	112" x 55" x 55"	5.3	8179681	74.99



Sport Goggles
• Soft brow and nose guard ensures comfort and snug fit
• Side vents to increase air flow
• UV lenses

Medium
8215576 – Wt. 0.2 lb **9⁹⁹**
Large
8213217 – Wt. 0.3 lb **16⁹⁹**



A) ATV Tow Ring
• For tow hooks or winch cables
• Off-Road Use Only
8077547 – Wt. 1.6 lb **12⁹⁹**



B) ATV Receiver Hitch
• Mount to your ATV hitch for a range of uses with 4 easy to change attachment options
• For Off-Road Use Only
8251704 – Wt. 12.7 lb **39⁹⁹**

ATV Bag Features
• Durable water resistant construction
• Universal designs fits most ATVs
• Temp range: - 20°C to 60°C

C) ATV Side Tank Bag
2 zippered compartments
8166712 – Wt. 0.9 lb **12⁹⁹**

D) Deluxe ATV Saddle Bag
• 2 large compartments with small zippered pouch in each
• 2 small compartments
8286585 – Wt. 3.0 lb **24⁹⁹**

E) Deluxe ATV Fender Bag
• 2 zippered compartments and insulated bottle holder
• For front or rear fender
8006412 – Wt. 1.3 lb **24⁹⁹**

F) 3/4 cu ft ATV Cooler Side Pack
Weather resistant 600D polyester construction with PVC backing and foam lining for added protection of contents
8166720 – Wt. 1.9 lb **19⁹⁹**



12" x 6-7/8" ATV Gas Can Holder
8005849 – Wt. 5.0 lb **19⁹⁹**



ATV Wheel Chocks
• Secure an ATV / UTV to a truck or trailer during transportation
• Powder coated steel construction
8360364 – Wt. 11.8 lb **29⁹⁹**



ATV Storage Covers
• Weather resistant, breathable material allow heat and moisture to escape
• Will not freeze or stretch
• Not recommended for trailering

	Dimensions	Colour	Wt. (lb)	ITEM	PRICE
L	75" x 50" x 40"	Olive	2.3	8228447	29.99
	75" x 50" x 40"	Black	2.4	8221152	29.99
	75" x 50" x 40"	Camo	2.1	8221228	34.99
XL	85" x 50" x 40"	Olive	2.6	8228496	39.99
	85" x 50" x 40"	Black	2.5	8221160	39.99
XXL	85" x 50" x 40"	Camo	2.5	8221236	44.99
	95" x 50" x 45"	Olive	3.0	8228520	49.99
	95" x 50" x 45"	Black	3.1	8221178	49.99
	95" x 50" x 45"	Camo	3.4	8221244	54.99

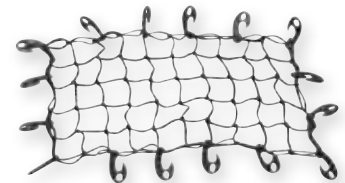

1-1/4 ft x 2-1/2 ft Stretch Cargo Net
Ideal for securing belongings on your ATV, motorcycle or snowmobile
8073991 – Wt. 0.9 lb **7⁹⁹**



Multipurpose ATV / Boat Cushion
Use as a back rest or extra seat cushion for ATVs, boats and at sporting events
8006767 – Wt. 1.8 lb **12⁹⁹**

Food Processing

Meat Hooks

Small - 7"
Max. cap. 175 lb
8113037 - Wt. 0.5 lb **3⁹⁹**

Large - 9"
Max. cap. 220 lb
8113045 - Wt. 0.5 lb **4⁹⁹**

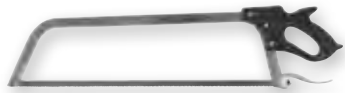

25" Meat Saw

- For use on any cut of meat
- Trigger mechanism for blade tension control
- Blades are dishwasher safe and resist bacterial contamination
- Plastic handle for comfortable cutting

8113276 - Wt. 3.6 lb **24⁹⁹**

Replacement Blade for 8113276
8113326 - Wt. 0.3 lb **4⁹⁹**



Stainless Steel Meat Mixer

- 4.2 gal. container holds 17 lb of meat
- Easy to clean rust resistant stainless steel construction
- Includes plastic cover

8376394 - Wt. 15.4 lb **99⁹⁹**



Aluminum Hamburger Press

- Creates uniform patties to go from freezer to grill
- Adjustable thickness range up to 1"
- Non-stick food grade coating
- 4-1/4" dia.

8207391 - Wt. 1.4 lb **19⁹⁹**

Smoke Cans

- Place on hot area of grill for best results
- Will infuse meat or vegetable with flavor in can

F) Alder Orange Peel
8390114 - Wt. 0.2 lb **4⁹⁹**

G) Mesquite Coffee Bean
8390122 - Wt. 0.2 lb **4⁹⁹**

H) Lemon Basil
8390148 - Wt. 0.2 lb **4⁹⁹**

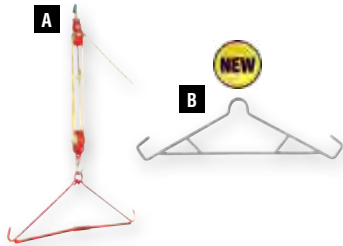

A) 440 lb Gambrel Game Hoist

- Includes everything needed to hoist deer and other large game up to 400 lb for easy cleaning
- Powder coated finished steel gambrel resists rust and corrosion
- 40 ft of strong poly rope resists rot and mildew

8176380 - Wt. 4.2 lb **14⁹⁹**

B) 800 lb Gambrel Hoist Hook
8379927 - Wt. 1.6 lb **19⁹⁹**



Spring Scale

- Aluminum housing with red anodizing stain
- 320 lb max. cap.

8105496 - Wt. 3.6 lb **49⁹⁹**



Stainless Steel Scale

- Easy to read dial measures from 0 to 22 lb with 4 oz graduations
- 9" x 7" x 2" removable tray

8195927 - Wt. 3.9 lb **49⁹⁹**



Digital Cooking Thermometer

Measures: -50°C to 125°C and -58°F to 257°F
8197808 - Wt. 0.1 lb **8⁹⁹**



Meat Grinders

C) #10 Manual Meat Grinder with Sausage Stuffer

- Cast iron cutting knife
- Includes 3/16" & 3/8" diameter grinding plates
- Comes with 1/2", 3/4" & 7/8" tip diameter stuffing tubes

8379919 - Wt. 7.2 lb **24⁹⁹**

D) Meat Grinder

- #32 plate size
- Mounts on table, bench or counter
- Cast iron construction with sanitary electro double tin plating
- Easy to assemble, use and clean
- Large hopper opening for loading of food
- Includes 2 grinding plates, cutting knife, and sausage making tube

8078719 - Wt. 20.8 lb **69⁹⁹**

E) 1/2 HP Electric Meat Grinder

- #12 neck size
- Powerful 400W motor with a forward and reverse switch
- Grinds up to 4.4 lbs of meat per minute
- Includes 3 stainless steel grinding plates: fine (1/8"), medium (3/16") and coarse (3/8")
- Comes with set of 3 stuffing tubes: 1/2", 3/4", and 7/8"

8379901 - Wt. 16.0 lb **129⁹⁹**

4 Rack Digital Meat Smoker

- Bradley Smoker makes it simple for the expert or novice smoker to create gourmet quality smoked food
- Temperature, time, and smoke are completely controllable so you can decide how much smoke you want, how long your food is going to be smoked for, and at what temperature
- Internal cooking vol: 2,288 cu in
- Max. temperature: controllable up to 320°F

8269359 - Wt. 56.3 lb **399⁹⁹**



48 pc Smoker Bisquettes

I) Maple
8269367 - Wt. 1.6 lb

J) Special Blend
8269391 - Wt. 1.6 lb

K) Hickory
8269383 - Wt. 1.6 lb

L) Mesquite
8269375 - Wt. 1.6 lb **19⁹⁹** /ea





Meat Processing

A) Table Top Sausage Stuffer

- Cylinder, canister and base plate made of heavy gauge stainless steel
- Dual speed gears
- Includes 3 durable plastic stuffing tubes
- Overall dim: cylinder 8"h x 4-7/8"w

8180077 – Wt. 10.0 lb **119⁹⁹**

B) Stainless Steel Vertical Sausage Stuffer

- Dual speed gear box
- Constructed of heavy duty stainless steel
- Includes 4 pc stainless steel stuffing tubes

11 lb
8376345 – Wt. 29.7 lb **199⁹⁹**

15 lb
8376352 – Wt. 33.0 lb **249⁹⁹**



Meat Slicer

- 7-1/2" stainless steel blade
- Adjustable cutting thickness up to 13 mm
- Blade speed: 100 to 110 RPM
- Aluminium die-cast body construction with non-slip feet
- 110V

8210536 – Wt. 11.7 lb **79⁹⁹**



Aluminum Jerky Cannon

- Food-grade aluminum tube ensures lasting reliability and easy cleanup
- Includes 2 stainless steel nozzles: round and flat
- Capacity: 1.5 lbs (0.7kg)

8383663 – Wt. 3.2 lb **29⁹⁹**



French Fry Cutters

C) Heavy Duty

- Includes stainless steel cutting blade
- Aluminum base and handle
- Can be permanently mounted on a table or wall

8376378 – Wt. 8.8 lb **49⁹⁹**

D) Deluxe

- Includes 4 stainless steel blades (7, 9, 13 mm and one for wedges)
- Cast iron handle
- Can be permanently mounted on a table or wall

8376360 – Wt. 11.0 lb **99⁹⁹**

Meat Processing Accessories

For #32 manual meat grinders and sausage stuffers

E) 3 pc Sausage Stuffing Tube Kit

9/16", 3/4" and 7/8"
8144529 – Wt. 0.2 lb **1⁹⁹**

F) Carbon Steel Cutting Knife

8144495 – Wt. 0.2 lb **1⁹⁹**

G) Grinding Plates

Carbon steel
8 mm x #32
8144503 – Wt. 0.7 lb
10 mm x #32
8144511 – Wt. 0.8 lb **3⁹⁹** /ea



Jerky Making Accessories

H) Jerky Cure & Seasoning Variety Pack

Includes 5 delicious flavors: original blend, mesquite blend, hickory blend, cracked pepper & garlic, and cajun blend
8351397 – Wt. 0.9 lb **12⁹⁹**

I) Jerky Cure & Seasoning Variety Pack

Includes 5 delicious flavors: inferno, sweet n' spicy, pepper, mandarin teriyaki, and pepperoni
8389967 – Wt. 0.9 lb **12⁹⁹**



Jerky Cure & Seasoning

Each kit comes with seasoning and cure for up to 15 pounds of meat

	Type	Wt (lb)	SKU	Price
J	Original	1.0	8389975	7.99
K	Mesquite	1.0	8389983	7.99
L	Hickory	1.0	8389991	7.99
M	Teriyaki	1.0	8390007	7.99
N	Cracked Pepper N' Garlic	1.0	8390015	7.99



Sausage Making Kits

- For use with any meat. Includes cure, seasonings, and casings
- Kits season 30 pounds of meat (except Bratwurst which seasons 24 pounds)

	Type	Wt (lb)	SKU	Price
O	Cracked Pepper N' Garlic	2.8	8390023	19.99
P	Summer Sausage	2.8	8390031	19.99
Q	Old Fashioned Bologna	2.3	8390049	19.99
R	Polish Sausage	2.8	8390064	19.99
S	Bratwurst Sausage	2.0	8390056	19.99



Snackin' Stick Kits

- For use with any ground meat.
- Each kit includes seasoning, cure, and collagen casings for 20 pounds of meat

	Type	Wt (lb)	SKU	Price
T	Original	1.3	8390072	22.99
U	Hickory	1.3	8390080	22.99
V	Cracked Pepper N' Garlic	1.3	8390098	22.99
W	Pepperoni	1.3	8390106	22.99

TRAILER



Trailer62 - 84
Axles & Components	63 - 65
Ball Mounts	72
Brake Controllers	66
Clearance / Marker Lights	81-84
Couplers & Actuators	74
Fasteners & Cable Ties	80
Hitches	73-74
Pintle Hooks	75
Tire Maintenance	69 - 70
Tire Tools & Repair	68
Tires	66 - 68
Trailer Fenders	65
Tailer Jacks	71
Trailer Steps	76
Trailer Security	75
Trailer Connectors	76 - 77
Wiring	78
Wiring Kits & Terminals	78 - 79

Truck84 - 93
Automotive Lighting	84
Battery Accessories	86 - 87
Fuses	86
Gauges	89
Heating	93
Switches	87
Truck Ramps	92
Utility Lights & Kits	85
Vehicle Accessories	87 - 89
Winch Centre93 - 96
Hand Winches	95
Winch Accessories	96
Winches	93 - 95
Cargo Control96 - 100
Tie-Downs	96 - 100



- Turf Tires
- High Speed Trailer Tires
- Utility Tires
- ATV Tires

Special Tires for Special Purposes



www.princessauto.com

Trailer

AXIS PRODUCTS, INC. 

Axis Products, Inc **Quality Trailer Products**

MEASURING AXLES

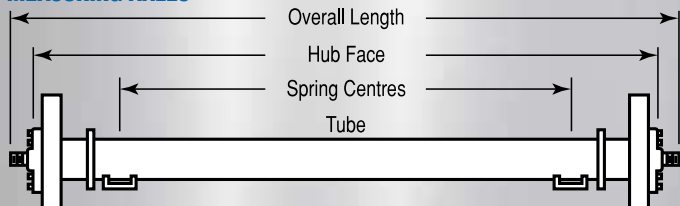

The industry standard for measuring axles is Hub Face to Hub Face.

Proper axle placement will ensure a trailer is neither tongue heavy, nor rear heavy. Trailer weight will be properly placed on the axle of the trailer instead of the tow vehicle.

Starting from the front of the trailer cargo area, the centre of the axle should be at 60% of the cargo decks length not including the trailer tongue. For tandem axles this should be the centre of the two axles.

Torsion Axle Ends

- Axle arms flex independently with built-in rubber cushioning, absorbing road shock for a smoother ride
- Mounts directly to frame with 4 bolts
- No springs, u-bolts or hangers required
- 0° start angle



Capacity	Left/Right	Hub	Wt. (lb)	ITEM	PRICE
2,000 lb	Right	4-bolt	31.9	8277980	149.99
2,000 lb	Left	4-bolt	32.9	8277998	149.99
3,500 lb	Right	5-bolt	41.5	8278020	179.99
3,500 lb	Left	5-bolt	43.5	8278012	179.99

Trailer Axle Idler Hubs

Hub Capacity	Bolt Pattern	Bearings	Races	Wt. (lb)	ITEM	PRICE
1,000 lb	4 on 4"	L44649/L44649	L44610	7.5	8211674	39.99
1,000 lb	5 on 4-1/2"	L44649/L44649	L44610	7.8	8211682	44.99
1,750 lb	5 on 4-1/2"	L44649/L68149	L68111/L44610	9.4	8211708	49.99

Posi-Lube Stub-Axles

3-1/2" stub length

Bolt	Bolt Circle	Capacity	Wt. (lb)	ITEM	PRICE
4	4"	1,000 lb	8.2	8217242	79.99
5	4-1/2"	1,000 lb	9.2	8219222	79.99
5	4-1/2"	1,750 lb	12.7	8219263	79.99

Axles



Trailer Axle Assemblies

Max. Load Capacity	Hub Face	Spring Centre	Hubs	Tube Diam.	Wt. (lb)	ITEM	PRICE
2,000 lb	48"	36"	5-bolt idler	1-3/4"	30.2	8249096	119.99
2,000 lb	60"	48"	4-bolt idler	1-3/4"	32.0	8277840	149.99
2,000 lb	60"	48"	5-bolt idler	1-3/4"	31.5	8186694	179.99
2,000 lb	89"	74"	5-bolt idler	1-3/4"	38.0	8186702	189.99
3,500 lb	72"	58"	5 on 4.5" bolt idler	2-3/8"	50.0	8186710	209.99
3,500 lb	80"	62"	5-bolt idler	2-3/8"	58.0	8277865	189.99
3,500 lb	94"	80"	5-bolt idler	2-3/8"	57.5	8212300	219.99

4" Drop

Max. Load Capacity	Hub Face	Spring Centre	Hubs	Tube Diam.	Wt. (lb)	ITEM	PRICE
3,500 lb	85"	69"	5-bolt idler	2-3/8"	65.0	8189912	234.99

Max. Load Capacity	Hub Face	Spring Centre	Hubs	Tube Diam.	Wt. (lb)	ITEM	PRICE
3,500 lb	72"	58"	5-bolt brake	2-3/8"	105.0	8277873	399.99
6,000 lb	85"	69"	6-bolt brake	3"	165.0	8277907	599.99



Stub-Axles

A) High Speed Trailer

B) Low Speed Agricultural

	Bolt	Bolt Circle	Capacity	Pilot Diam.	Spindle	Stub Length	Wt. (lb)	ITEM	PRICE
	4-bolt	4.00"	1,250 lb	2.50"	1-1/4" x 9-1/2"	4.65"	7.8	2080000	59.99
	5-bolt	4.50"	1,250 lb	2.50"	1-1/4" x 9-1/2"	4.65"	8.6	2080067	64.99
A	5-bolt FORD/DODGE	4.50"	2,000 lb	2.50"	1-3/4" x 8-1/4"	4.00"	12.1	2080026	69.99
	5-bolt CHEVY	4.75"	2,000 lb	2.50"	1-3/4" x 8-1/4"	4.00"	12.0	2080018	69.99
	6-bolt	6.00"	3,600 lb	4.62"	1-3/4" x 14"	9.75"	19.4	2080075	79.99
B*	6-bolt	6.00"	6,000 lb	4.62"	2-1/2" x 14"	7.80"	30.8	2080059	114.99

* Low speed applications only. Not intended for highway use.

Axle Components

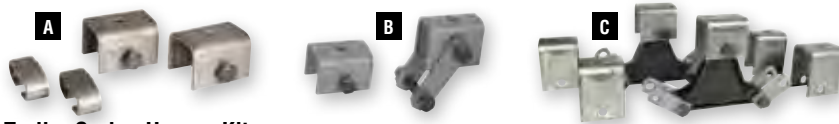

Trailer Spring Hanger Kits

	Axle	Spring	Capacity	Spring Size	Wt. (lb)	ITEM	PRICE
A	Single	Slipper	2,000 to 3,500 lb	1-3/4"	3.5	2080068	19.99
B	Single	Leaf	2,000 to 3,500 lb	1-3/4" double-eye	6.7	2080025	24.99
C	Tandem	Leaf	2,000 to 7,000 lb	1-3/4" double-eye	19.4	8211666	69.99



Trailer Axle Mounting Kits

	Axle Size & Type	Capacity	Wt. (lb)	ITEM	PRICE
D	1-3/4" Round	2,000 lb	2.8	2080028	14.99
E	2-3/8" Round	3,500 lb	5.8	2080027	19.99
D	3" Round	5,200 to 7,000 lb	8.1	8190985	34.99
F	2" Square	2,000 to 3,500 lb	7.2	2080076	29.99

1.980" ID Wheel Bearing Sets

Spindle O.D.	Bearings (2)	Races (2)	Wt. (lb)	ITEM	PRICE
1"	L44643	L44610	0.6	8281503	14.99
1-1/16"	L44649	L44610	0.6	8281529	14.99
1-3/8" x 1-1/16"	L44649/L68149	L44610/L68111	0.7	8281537	14.99



Wheel Bearing Kits

Capacity	Bearings	Races	Wt. (lb)	ITEM	PRICE
3,500 lb	L68149/L46649	L68111/L46610	0.7	2080055	29.99
6,000 lb 6-blit	25580/15123	25520/15245	2.1	8008823	29.99



Stub Axle Dust Caps

Outer Diam.	Axle Cap. (lb)	Wt. (lb)	ITEM	PRICE
1.98"	2,000 to 3,500	0.2	8227969	7.99
2.44"	5,200 to 6,000	0.3	8227993	8.99



Posi-Lube Grease Caps

Qty	Contents	Wt. (lb)	ITEM	PRICE
4	Plugs	0.1	8281552	6.99
2	Plugs & Caps	0.3	8281602	11.99



4 pk 1/2" Drive-in Wheel Studs

Idler Hub Cap.	Wt. (lb)	ITEM	PRICE
2,000 lb	0.5	8281610	6.99
3,500 to 7,000 lb	0.5	8212151	6.99

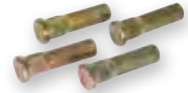

10 pc 1/2"-20 Wheel Lug Nuts
8191009 - Wt. 0.6 lb **6⁹⁹**

1" Spindle Nut & Washer Set
8212169 - Wt. 0.5 lb **7⁹⁹**



2 pc Wheel Bearing Protectors

ID	Wt. (lb)	ITEM	PRICE
1.98" covers	0.1	8227670	2.99
1.98"	0.9	8186967	14.99
1.78"	1.0	8263972	14.99
2.04"	1.2	8264053	14.99
2.44"	1.7	8263857	16.99



Grease/Dust/Hub Cap Tool

- Tapered jaws for grease and dust caps
 - Handle end for hub caps
- 2990281 - Wt. 1.2 lb **19⁹⁹**

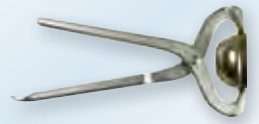

Stub-Axle Accessories

Stub Axles	G) Hub Bearing Kits			H) Stub Axle Dust Caps			I) Stub Axle Wheel Bolts		
	Wt. (lb)	Item	Price	Wt. (lb)	Item	Price	Wt. (lb)	Item	Price
2080000 & 2080067	0.6	8329518	16.99	0.1	8043280	1.99	0.2	2081180	99¢
2080026 & 2080018	1.1	8329526	27.99	0.1	8043299	2.49	0.2	2081180	99¢
2080075	0.9	8329534	26.99	0.1	8043306	2.99	0.2	2081180	99¢
2080059	1.9	8329542	29.99	0.2	8043315	3.49	0.1	2081198	99¢

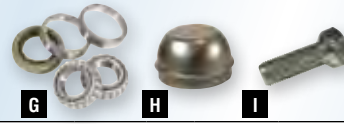

2 pc Press-in Flange Bearings

Bore	O.D.	Wt. (lb)	ITEM	PRICE
3/8"	1-1/8"	0.2	8066946	1.99
1/2"	1-3/8"	0.2	8066953	2.99
5/8"	1-3/8"	0.2	8066912	2.99
3/4"	1-3/8"	0.2	8066920	2.99
1"	2"	0.5	8066938	3.99





Trailer Spring Shackles

For 1-3/4" double-eye



Type	Qty	Size	Wt. (lb)	ITEM	PRICE
Straps	4	2.25"	1.0	8281586	8.99
Straps	4	2.625"	1.1	8281578	8.99
Straps	4	3.125"	1.2	8281560	8.99
Bolts & Nuts	4	2.25"	1.3	8281594	9.99
Single Kit	2	3"	1.2	8008849	9.99
Tandem Kit	4	2"	2.2	8008872	14.99

Leaf Spring Pads

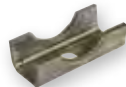

Axle Cap.	Wt. (lb)	ITEM	PRICE
2,000 lb	0.4	8212268	3.99
3,500 lb	0.8	8212276	4.99
6,000 lb	0.8	8212284	5.99

4 pk Leaf Spring Bushings



8212144 - Wt. 0.1 lb **6⁹⁹**

Curved Equalizer Bar



2,000 to 7,000 lb **13⁹⁹**



Spring Components



Trailer Leaf Springs

Style	No. of Leaves	Cap. per Spring	Centre Eye to Eye	Spring Width	Wt. (lb)	ITEM	PRICE
Double-Eye	3	1,250 lb	25-1/4"	1-3/4"	9.9	2080096	28.99
A Double-Eye	3	1,300 lb	23-1/4"	1-3/4"	11.1	2080031	34.99
Double-Eye	4	1,750 lb	25-1/4"	1-3/4"	10.9	2080032	34.99
Slipper	4	1,000 lb	24"	1-3/4"	9.1	2080065	29.99
B Slipper	4	1,750 lb	29"	1-3/4"	15.2	2080066	49.99
Slipper	5	3,500 lb	27"	2"	19.5	8190951	59.99

Trailer Fenders



Trailer Fenders

Style	Tire Size	L x W	Material	Features	Wt. (lb)	ITEM	PRICE
C	Single	up to 12"	23-1/2" x 7-1/2"	16 ga steel	-	5.6	2080216 24.99
D	Single ABS	up to 12"	20-1/2" x 6-3/4"	ABS	With skirt	0.9	2080097 19.99
E	Single	up to 15"	31" x 9"	16 ga steel	-	7.2	2080224 29.99
F	Single with 90°	up to 15"	32" x 9"	16 ga steel	90° flanged back	7.7	2080021 29.99
G	Single	up to 15"	32" x 9"	16 ga steel	Jeep Style	8.2	2080078 29.99
H	Tandem	up to 15"	72" x 9"	16 ga steel	90° flanged back	17.3	2080095 49.99



3,500 lb Trailer Axle Brake Drum Kit

- 5-bolt
- 4-1/2" bolt circle

8211716 - Wt. 20.9 lb **89⁹⁹**



Brake Shoe Kits

Axle Capacity	Axle Diameter	Wt. (lb)	ITEM	PRICE
3,500 lb	10" x 2-1/2"	3.4	8008518	34.99
6,000 lb	12" x 2"	4.2	8008799	39.99



Trailer Brakes



Electric Brake Assemblies

Axle Capacity	Side	Wt. (lb)	ITEM	PRICE
3,500 lb	Left	10.3	8212078	79.99
3,500 lb	Right	10.5	8212086	79.99
6,000 lb	Left	15.8	8212243	89.99
6,000 lb	Right	15.8	8212250	89.99



3" Drum Brake Actuator

- Provides higher braking pressure for a fast and smooth stop
- Max. gross tongue weight: 600 lb
- Max. gross trailer weight: 6,000 lb



4200066 – Wt. 18.0 lb **199⁹⁹**

Brake Drum Adjuster and Springs

8212292 – Wt. 0.5 lb



7⁹⁹

Brake Magnet Kits

Brake Axle Capacity	Brake Axle Hub Diam.	Wt. (lb)	ITEM	PRICE
3,500 lb	10"	0.9	8212094	29.99
6,000 lb	12"	1.0	8006858	39.99

HOW TO MEASURE BOLT HOLES

4 Lug

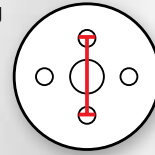

5 Lug

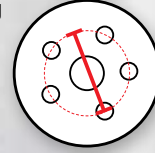

6 Lug

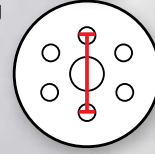

Brake Controllers



Trailer Brake Controllers

Type	Wt. (lb)	ITEM	PRICE
A Engager® Single/Dual Axle	4.4	8002177	64.99
B Brake Force® LED 4-Brake	0.8	8023523	84.99
B Impulse® Digital 6-Brake	0.8	8023532	99.99
C Agility® Proportional 8-Brake	0.7	8214371	129.99



Trailer Brake Control Adapters

Type	Wt. (lb)	ITEM	PRICE
Ford/Mercury/Landrover/Lincoln	0.2	8181174	16.99
Chevy/GMC/Cadillac/Hummer	0.3	8181208	18.99
Dodge/Chrysler/Jeep	0.3	8181216	18.99



Sealed 12V DC Rechargeable Battery

Multiple uses as well as for Engager Trailer Breakaway System - 8002177

8224834 – Wt. 3.2 lb **34⁹⁹**



Replacement Components for Engager® Trailer Breakaway System

Cable & Pin
8264640 – Wt. 0.1 lb **9⁹⁹**

LED Switch
8264590 – Wt. 0.2 lb **14⁹⁹**

Tires



Carlisle **Quality Trailer Products**

Radial Trailer Tire Assemblies

	Size	Capacity	PSI	Load Range	Bolt	Bolt Circle	Rim	Finish	Recommended Axle Capacity	Wt. (lb)	ITEM	PRICE
D	ST145/R12	1,220 lb	65	C	5	4-1/2"	Supreme mod	White	2,200 lb	25.0	2020143	164.99
	ST175/80 R13	1,360 lb	50	C	5	4-1/2"	Spoked	White	2,000 lb	29.3	8341745	164.99
	ST175/80 R13	1,360 lb	50	C	5	4-1/2"	Spoked	Galvanized	2,200 lb	30.0	8128308	174.99
E	ST205/75 R14	1,760 lb	50	C	5	4-1/2"	Spoked	White	3,500 lb	40.4	2020081	219.99
	ST205/75 R14	1,760 lb	50	C	5	4-1/2"	Spoked	Galvanized	3,500 lb	40.4	8128316	229.99
	ST205/75 D15*	1,820 lb	50	C	5	4-1/2"	Spoked	White	3,500 lb	39.8	8265233	174.99
	ST235/80 R16	3,500 lb	80	E	6	6-1/2"	Spoked	White	7,000 lb	68.6	8350399	249.99

*Bias-ply



ST205/75 R15 Trailer Tire Assembly

Lugs and wheel caps available through special order
Wt. 41.5 lb

8353666 **289⁹⁹**

Tire featured with trailer fender - 2080078, available separately



Tire Traction Plates

Gets your car or truck out of snow, mud or sand

8263667 – Wt. 3.4 lb **19⁹⁹**

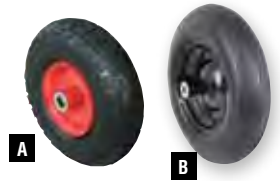

High Speed Trailer Tire Assemblies

Size	Capacity	PSI	Load Range	Bolt	Bolt Circle	Rim	Wt. (lb)	ITEM	PRICE
4.80 x 4.00-8	585 lb	60	B	4	4"	Standard	9.7	2026755	49.99
4.80 x 4.00-8	585 lb	60	B	5	4-1/2"	Standard	9.0	2026888	49.99
4.80 x 4.00-8	585 lb	60	B	-	-	Tire only	5.6	2020576	34.99
4.80 x 4.00-12	785 lb	60	B	4	4"	Standard	20.1	8353021	99.99
4.80 x 4.00-12	785 lb	60	B	5	4"	Standard	20.1	8353054	99.99
5.70-8	715 lb	50	B	4	4"	Standard	12.0	2026763	69.99
5.70-8	715 lb	50	B	5	4"	Standard	13.5	2026896	69.99
5.70-8	715 lb	50	B	-	-	Tire only	7.6	2020584	44.99
5.30-12	855 lb	55	B	4	4"	Spoked	20.4	2026771	114.99
5.30-12	855 lb	55	B	5	4-1/2"	Spoked	20.5	2020964	114.99
5.30-12	855 lb	55	B	-	-	Tire only	9.3	2026805	64.99
5.30-12	840 lb	55	B	5	4"	Spoked	19.4	8002533	89.99
16.5 x 6.50-8	615 lb	45	B	4	4"	Standard	14.4	8227175	79.99
16.5 x 6.50-8	615 lb	45	B	5	4-1/2"	Standard	14.1	8227183	79.99
16.5 x 6.50-8	615 lb	40	B	-	-	Tire only	8.8	8227167	49.99
18.5 x 8.50-8	760 lb	35	B	4	-	Standard	18.6	8227191	114.99
18.5 x 8.50-8	760 lb	35	B	5	4-1/2"	Standard	18.5	8227209	114.99
20.5 x 8.00-10	1,100 lb	50	C	4	4"	Standard	27.5	8227217	124.99
20.5 x 8.00-10	1,100 lb	50	C	5	4-1/2"	Standard	28.6	8227225	124.99

4.80 x 4.00-8 Wheelbarrow Wheels

A) Tube Type - Assembly

- 300 lb capacity
- 2020062 – Wt. 5.8 lb **19⁹⁹**
- Tube Type - Tire Only
- 2024685 – Wt. 2.1 lb **9⁹⁹**

B) Non-Flat Assembly

- 3/4" bore
- 270 lb capacity
- Foam-filled wheel retains its shape and capacity even if punctured
- 8399230 – Wt. 9.9 lb **42⁹⁹**

4.80 x 4.00-8 Non-Flat Wheel Assembly

- 270 lb capacity
- Foam-filled wheel retains its shape and capacity even if punctured
- Great for go-carts and other applications that use a 5/8" shaft
- 8278038 – Wt. 9.9 lb **42⁹⁹**

Diamond Rubber Tread Wheels

Size	Wt. (lb)	ITEM	PRICE
6" x 1-1/2"	0.9	8039943	4.99
7" x 1-1/2"	1.2	8039976	5.99
8" x 1-3/4"	1.7	8005916	6.99

30 PSI Wheel Assemblies



	Size	Diam.	Cap.	Type	Bore	Rim	Ply	Wt. (lb)	ITEM	PRICE
	2.80 x 2.50-4	8"	220 lb	Tube	5/8"	2 pc	2	3.0	2020059	14.99
C	4.10 x 3.50-4	10"	300 lb	Tube	5/8"	1 pc (ABS)	2	2.7	2020107	14.99
	4.10 x 3.50-5	11"	330 lb	Tube	3/4"	1 pc	4	5.0	2020061	19.99
D	4.10 x 3.50-4	10"	300 lb	Tube	5/8"	2 pc	2	3.5	2020060	17.99
E	6" x 2"	6"	200 lb	Tube	5/8"	2 pc	4	1.6	8064768	15.99



4.10 x 3.50-4 Flat Free Wheel Assembly

- 300 lb capacity
- Foam-filled wheel retains its shape and capacity even if punctured
- 5/8" bore
- Ideal for shop carts and dollies
- 8309825 – Wt. 3.7 lb **29⁹⁹**

Turf Tire Assemblies

Not for highway use



	Size	Capacity	PSI	Ply	Bore	Wt. (lb)	ITEM	PRICE
F	13 x 5.00-6	370 lb	30	4	3/4"	6.5	2021806	32.99
	16 x 6.50-8	550 lb	35	2	3/4"	4.8	8043789	49.99
G	16 x 6.50-8	440 lb	30	2	Tire only	5.1	2021558	29.99

ATV Tires



	Tire Size	Type	Wt. (lb)	ITEM	PRICE
H	25 x 8.00-12	Mud Wolf®	23.0	8362741	124.99
I	25 x 8.00-12	Black Rock®	17.2	8362733	124.99



Solid Rubber Wheel Assemblies



	Duty	Size	Cap.	Bore	Hub	Wt. (lb)	ITEM	PRICE
A	Light	6" x 1-1/2"	60 lb	1/2"	Steel	1.8	2026201	6.99
	Light	7" x 1-1/2"	60 lb	1/2"	Steel	3.0	2021368	7.99
	Light	8" x 2"	100 lb	1/2"	Steel	4.3	2020295	9.99
	Light	10" x 2-1/2"	140 lb	1/2"	Steel	8.8	2020088	14.99
B	Medium	8" x 2-1/2"	175 lb	5/8"	Steel	5.9	8139644	12.99
	Medium	10" x 2-3/4"	200 lb	5/8"	Steel	8.8	8139651	15.99
C	Heavy	8" x 2-1/2"	250 lb	3/4"	Poly flex	4.3	2020091	14.99
	Heavy	10" x 2-3/4"	300 lb	3/4"	Poly flex	8.6	2020092	16.99



Tire Rims



	Size	Bolt	Bolt Circle	Cap.	Pilot Diam.	Style	Wt. (lb)	ITEM	PRICE
D	8" x 3-3/4"	4	4"	910 lb	2.50"	Standard	4.2	8280794	19.99
	8" x 7"	4	4"	940 lb	2.50"	Standard	5.6	8280711	24.99
	8" x 7"	5	4-1/2"	940 lb	2.82"	Standard	5.9	8280729	24.99
	12" x 4"	4	4"	1,040 lb	2.82"	Spoked	9.7	8280802	29.99
E	13" x 4-1/2"	4	4"	1,060 lb	2.82"	Spoked	12.6	8280745	44.99
	13" x 4-1/2"	5	4-1/2"	1,360 lb	3.19"	Spoked	12.3	8280752	44.99
	14" x 5-1/2"	5	4-1/2"	1,870 lb	3.19"	Spoked	17.5	8280760	59.99
	15" x 6"	5	4-1/2"	2,150 lb	3.30"	Spoked	20.0	8280778	64.99
	16" x 6"	6	5-1/2"	3,040 lb	4.24"	Spoked	29.1	8280810	79.99

Tire Repair

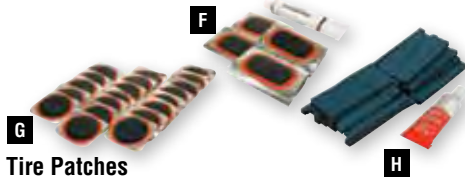

Tire Patches

	Qty	Size	Wt. (lb)	ITEM	PRICE
F*	24	2" x 1-1/4"	0.2	2021418	4.99
G	30	2"	0.3	2021384	7.99
G	20	3"	0.2	2021392	9.99
H*	50	1-1/4" x 2-1/4"	0.2	2020036	9.99

* Include rubber cement

2 pc 2" Tire Plug Patch Kit

8107708 - Wt. 0.1 lb **4.99**

Tire Tubes

Size	Wt. (lb)	ITEM	PRICE
2.80 x 2.50-4	0.3	8244626	3.29
4.10 x 3.50-4	0.5	8244592	3.49
4.00-6	0.6	8244600	3.89
4.80 x 4.00-8	0.9	8244618	3.99
4.80 x 4.00-12	1.5	8396566	9.99
5.30 x 4.50-6	0.8	8244634	4.99
5.30-2	1.6	8396574	12.99
5.70-8	1.4	8244642	6.99
13 x 5.00-6	0.3	8005297	5.49
15 x 6.00-6	0.8	8005298	5.99
18 x 9.50-8	1.8	8244584	10.99

Tire Tools

I) Tire Tread Depth Gauge

Increments of 1/32" or 1 mm
8107740 - Wt. 0.1 lb **4.99**

J) Tire Stitcher Tool

Roll out bubbles and creases in new tire patches
8006257 - Wt. 0.3 lb **4.99**

K) Wheel Weight Tire Tool

- ABS coated hammer head for mar-free use
- Installs, removes, trims and tightens clip-on wheel weights

8262479 - Wt. 1.0 lb **17.99**

L) 3 pc Bead Breaker Set

- 12" driving iron
- 33" bead breaker
- 23-1/4" lock ring iron

8313835 - Wt. 12.7 lb **39.99**

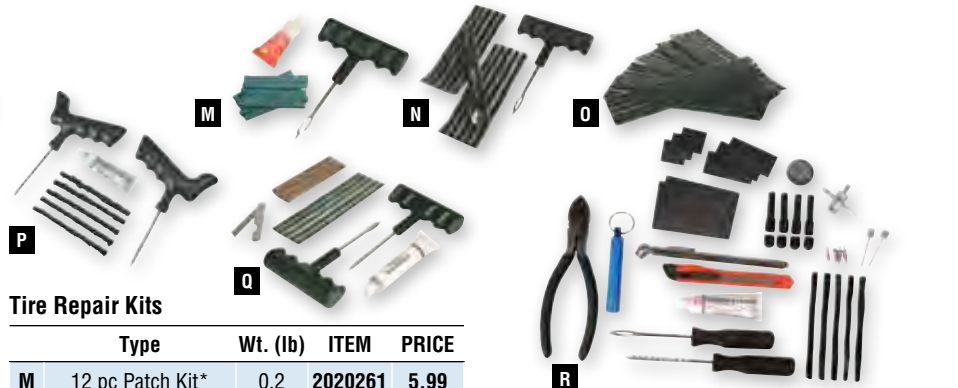

Tire Repair Kits

Type	Wt. (lb)	ITEM	PRICE
M 12 pc Patch Kit*	0.2	2020261	5.99
N 13 pc Cord Kit	0.2	2020253	6.99
O 30 pc Cords	0.2	2020035	9.99
P 8 pc Cord Kit*	0.5	8107922	9.99
Q 12 pc Radial Kit*	0.4	2020626	17.99
R 36 pc Service & Repair Kit*	1.3	8107682	19.99

*Include rubber cement



1 oz Rubber Cement

For all rubber repairs
8198293 - Wt. 0.1 lb..... **1.99**

4 pc Snap-in Tubeless Tire Valves

For use up to 65 PSI working pressure



Type	Rim Hole Diam.	Effective Length	Wt. (lb)	ITEM	PRICE
TR413	.453"	1-1/4"	0.1	8341513	2.49
TR413*	.453"	1-1/4"	0.1	8253767	3.99
TR415	.625"	1-1/4"	0.1	8341521	2.69
TR418	.453"	2"	0.1	8341539	2.89
TR425	.625"	2"	0.2	8341547	3.29

*Chrome

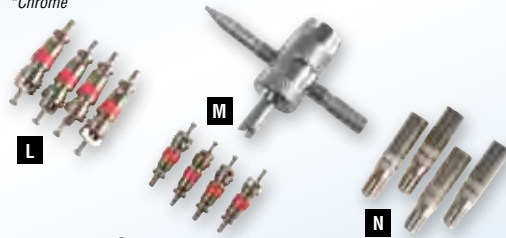

Tire Valve Cores / Extensions

L) 4 pc Cores

8253692 – Wt. 0.1 lb **89¢**

M) Repair Tool with Valve Cores

- Re-thread valve stems inside and out
- Insert and remove valve cores

8253684 – Wt. 0.1 lb **1.49**

N) 4 pc 1-1/4" Extensions

Allows easier access to tire valve for inflation

8253742 – Wt. 0.1 lb **2.99**



Tire Valve Tools

O) Tire Valve Fishing Tool

2020125 – Wt. 0.1 lb **1.99**

P) 'Snap-in' Tire Valve Installer

For use on 8253767, 8341513, 8341521, 8341539, 8341547

2020126 – Wt. 0.6 lb **3.99**

Q) Tire Valve Core Tool Set

Remove and insert valve cores

2020029 – Wt. 0.1 lb **5.99**

R) 4 pc Tire Valve Tool Set

Insert and remove cores, tap inner stems, and chase outside threads

8103491 – Wt. 0.4 lb **16.99**

S) TPMS Valve Core Tools

Prevent over torque on Tire Pressure Monitoring System valve cores

8243057 – Wt. 0.2 lb **18.99**

Tire Maintenance



Tire Changers

	Tire Size	Shaft Size	Wt. (lb)	ITEM	PRICE
A	4" to 12"	14 mm	14.1	8157364	64.99
B	7-1/2" x 16**	40 mm	35.4	2050002	79.99
C	16" to 20"	50 mm	60.0	2050003	139.99

*Also 12-1/2" x 16" floatation tires

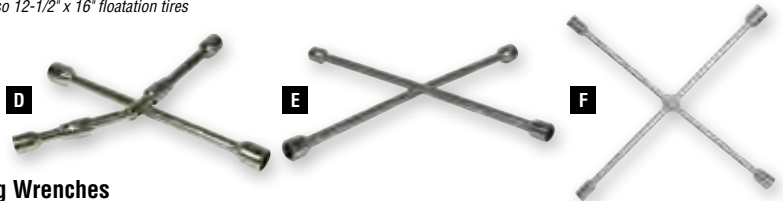

Lug Wrenches

	Type / Size	Ends	Wt. (lb)	ITEM	PRICE
D	14" Fold-Down	7/8", 13/16", 3/4", 11/16"	2.9	4272282	11.99
E	20"	7/8", 13/16", 3/4", 11/16"	3.6	4272514	11.99
E	25" Truck	7/8", 15/16", 1", 1-1/16"	6.1	4272589	17.99
F	20" Locking	7/8", 13/16", 3/4", 11/16**	4.3	8315756	24.99

*Chrome vanadium ends



Tire Gauges

Milton precision engineered service gauges provide accurate, long life trouble free performance

	Type	PSI	Other	Wt. (lb)	ITEM	PRICE
G	Truck / RV / Bicycle	20 to 120 PSI	120 to 820 kPa	0.1	4252235	9.99
H	Passenger Car	5 to 50 PSI / 1 lb	40 to 350 kPa / 10 kPa	0.1	4270542	9.99
I	Dual Chuck Truck	20 to 120 PSI	120 to 820 kPa	0.2	4252243	14.99
J	Tractor	5 to 50 PSI / 1 lb	40 to 350 kPa / 10 kPa	0.1	4271995	12.99
K	Dual Chuck Extension	10 to 160 PSI / 2 lb	80 to 1,100 kPa / 20 kPa	0.6	4272381	24.99



16 oz Tire-Slick™ Bead Lube

For all car, truck, motorcycle and off-road vehicles

8223208 – Wt. 1.2 lb **9.99**



Tire Crayon

8107724 – Wt. 0.1 lb ... **2.99**

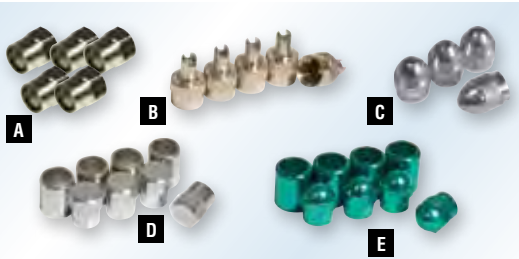

Tire Valve Caps

Type	Qty.	Wt. (lb)	ITEM	PRICE
A Chrome Hex Head	5 pc	0.1	2020128	0.99
B Threaded	5 pc	0.1	2020127	1.49
C Dome	4 pc	0.1	8107849	1.49
D Sleeved Chrome	4 pc	0.1	8107914	1.79
E* Sleeved Chrome - Green	4 pc	0.1	8253718	1.89

*Designate nitrogen filled tires



Tire Gauges

Type	PSI	Other	Wt. (lb)	ITEM	PRICE
E Pocket Pencil	0 to 50 PSI	-	0.1	8248635	0.99
F Pocket Pencil	10 to 120 PSI	Kg/cm , kPa , bar	0.2	8158875	1.99
G Dual Chuck	10 to 120 PSI	100 to 800 kPa	0.2	8158826	3.99
H Dial	20 to 100 PSI	1 to 7 kg/cm2	0.2	8158883	5.99
I Digital	0 to 100 PSI	-	0.1	8242471	6.99
J Dual Chuck Extension	10 to 150 PSI	-	0.3	8158859	7.99

3-In-1 Digital Tire Gauge

All-in-one gauge for tire pressure, tread depth and flashlight
8241085 - Wt. 0.2 lb.....

9.99



Wheel Chocks

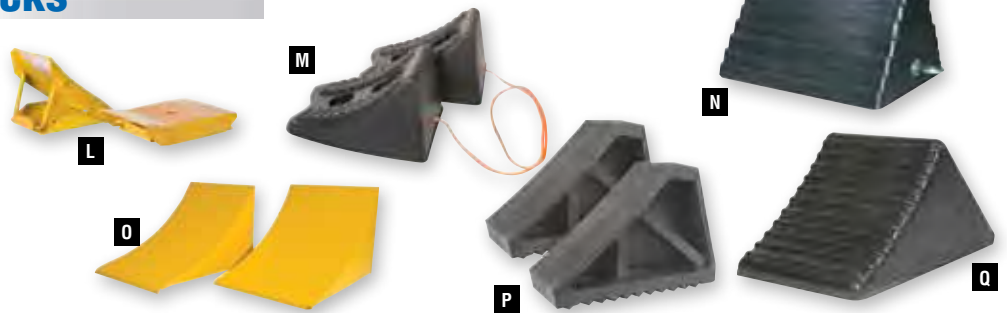

Wheel Chocks

	Dim.	Qty	Material	Features	Wt. (lb)	ITEM	PRICE
L	4-1/2" x 3-1/2"	2 pc	Steel	Foldable	1.7	8204141	6.99
M	8-1/4" x 5-3/4" x 4"	2 pc	Moulded hardened plastic	3 ft connecting rope	0.9	8096760	8.99
N	10" x 8" x 6"	1 pc	Heavy duty rubber surface	Eye bolt, ribbed surface	8.8	8095887	19.99
O	9" x 6-3/4" x 6"	2 pc	Steel	Teeth on bottom edge	5.5	2020171	27.99
P	8" x 6" x 4"	2 pc	Rubber	Ribbed bottom	9.4	8095879	29.99
Q	8-1/4" x 5" x 4"	1 pc	Reinforced rubber	Ribbed surface	2.6	8192114	9.99



**Princess Auto
Foundation**



Together we are making a difference

for our future customers. By providing bursaries to Canadian Colleges throughout Canada we demonstrate our support for the trades. Work with the hands-give from the heart.

For more information visit us at: www.theprincessautofoundation.com



Charitable # 833179369 RR00041



**Welcome to our
Unique World!**



**Home of an outstanding
shopping experience, every time!**

*Heights are measured from ground to centre of mounting point



1,500 lb 12V DC Bolt-Mount Trailer Jack

- 20A fuse protected motor will withstand the most adverse weather conditions
 - Manual over-ride
 - Retracted height: 14"
 - Extended height: 28"
- 8277386** – Wt. 27.9 lb **149⁹⁹**



3,500 lb 12V DC A-Frame Trailer Jack

- Full 18" lift (12" power plus 6" manual drop leg extension)
 - Pre-wired with 48" lead and 7-way connector
 - Manual crank over-ride
 - Built-in leveling gauge and lighting to hitch-up in the dark
- 8235350** – Wt. 19.0 lb **249⁹⁹**

Trailer Components



E

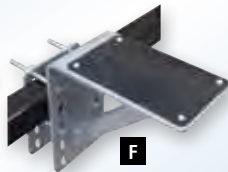

F

Trailer Steps

- Makes it easy to get ON / OFF the trailer
- Fits up to 3" x 5" trailer frame

E) Steel
8360513 – Wt. 8.3 lb **24⁹⁹**

F) Aluminum
8360562 – Wt. 4.8 lb **29⁹⁹**



Adjustable Steel Trailer Step

- Quick and convenient access to boat while on trailer
- Preset angles: 22°, 45°, 67° and 90°

8360570 – Wt. 17.8 lb ... **39⁹⁹**



G

H



2 pc Adhesive Trailer Levels

H) 5" Decorative

Popular eagle design with 5" wing span
8224818 – Wt. 0.1 lb

G) 2" Standard
4200105 – Wt. 0.1 lb **4⁹⁹** /pr

Trailer Jacks



PowerFist



Ironworks Industries Inc.



A) Bolt-On Swivel Trailer Jacks

Capacity	Handle	Retracted Height*	Extended Height*	End	Wt. (lb)	ITEM	PRICE
1,000 lb	Fold-Away Topwind	11"	21"	Round Foot Plate	15.2	8004520	49.99
1,000 lb	Sidewind	12-3/4"	22-5/8"	6" Polypropylene Wheel	14.9	8283467	54.99
1,200 lb	Sidewind	26"	39"	6" Dual Wheel	18.5	1070022	54.99
*500 lb	Topwind	17-3/4"	26-3/4"	10" Pneumatic Wheel	19.8	8007019	69.99
1,500 lb	Sidewind	13"	23"	8" Wheel	18.8	8153637	69.99
1,500 lb	Sidewind Ergonomic	29-1/2"	43-1/2"	8" Wheel	23.9	8153652	84.99

*Featured

B) A-Frame Trailer Jacks

Capacity	Handle	Retracted Height*	Extended Height*	Wt. (lb)	ITEM	PRICE
2,250 lb	Topwind	8"	23"	13.3	8003557	39.99
5,000 lb	Topwind	22-1/2"	37-1/2"	10.9	8146508	29.99

C) Mechanical Implement Trailer Jacks

Capacity	Mount	Handle	Retracted Height*	Extended Height*	Wt. (lb)	ITEM	PRICE
2,000 lb	Ring	Topwind	12-3/4"	22-3/4"	12.6	8004522	39.99
2,000 lb	Flange	Topwind	10"	20"	12.7	8004523	39.99
2,000 lb	Flange	Topwind	14-7/8"	29-7/8"	14.8	8004524	47.99
2,000 lb	Ring	Sidewind	11-1/2"	26-1/2"	16.5	8004689	44.99
5,000 lb	Flange	Topwind	11-7/8"	21-7/8"	15.0	1050244	44.99
5,000 lb	Flange	Topwind	14-7/8"	29-7/8"	18.2	1050269	49.99
5,000 lb	Ring	Topwind	11-7/8"	21-7/8"	12.1	1050251	44.99
5,000 lb	Ring	Topwind	14-7/8"	29-7/8"	16.8	8051013	49.99
5,000 lb	Ring	Sidewind	11-1/2"	21-1/2"	14.3	8004687	46.99
5,000 lb	Flange	Sidewind	14-7/8"	29-7/8"	19.4	1050400	54.99

D) Weld-On Drop Leg Trailer Jacks

Capacity	Handle	Retracted Height*	Extended Height*	Wt. (lb)	ITEM	PRICE
5,000 lb	Topwind	23-1/2"	52-1/2"	22.1	8055055	69.99
5,000 lb	Sidewind	23-1/2"	52-1/2"	22.9	8055139	69.99
7,000 lb	Topwind	22-1/4"	50"	22.9	1050035	74.99
7,000 lb	Sidewind	23"	51-1/2"	27.2	8002257	99.99
12,000 lb static / 10,000 lb lift	Sidewind	25"	47-1/2"	65.2	8002256	149.99
12,000 lb	Sidewind	27-1/2"	54-1/2"	63.9	8146490	169.99

Ball Mounts



Ball Mounts

Class	Max. Gross Tongue Weight	Max. Gross Trailer Weight	Drop	Rise	Hitch Receiver	Bolt Hole	Wt. (lb)	ITEM	PRICE
CLII	300 lb	3,500 lb	1-1/4"	5/8"	1-1/4"	3/4"	5.2	8002960	19.99
CLII	300 lb	3,500 lb	3-1/4"	2-5/8"	1-1/4"	3/4"	6.5	8002962	24.99
CLIII	500 lb	5,000 lb	2"	3/4"	2"	1"	6.6	8049328	24.99
CLIII	500 lb	5,000 lb	3-1/4"	2"	2"	1"	7.4	8049346	26.99
CLIII	500 lb	5,000 lb	6"	4-3/4"	2"	1"	9.2	8049364	29.99
CLIII*	500 lb	5,000 lb	2"	3/4"	2"	1"	6.5	8049499	29.99
CLV	1,200 lb	12,000 lb	2"	3/4"	2"	1-1/4"	12.7	8159717	39.99
CLV	1,200 lb	12,000 lb	4"	2-3/4"	2"	1-1/4"	13.3	8159733	44.99
CLV	1,200 lb	12,000 lb	6"	4-3/4"	2"	1-1/4"	15.7	8159766	49.99
CLIII	500 lb	5,000 lb	8"	6-3/4"	2"	1"	15.4	8187452	39.99
CLIII	500 lb	5,000 lb	10"	8-3/4"	2"	1"	16.7	8187460	49.99

* Chrome

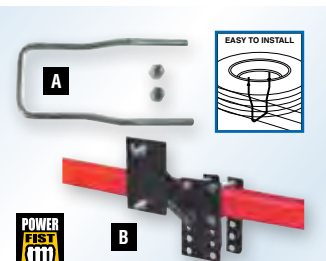

Spare Trailer Tire Mounts

A) 8" to 15"
8007005 - Wt. 1.0 lb..... **8⁹⁹**

B) Heavy Duty
8112575 - Wt. 6.0 lb... **19⁹⁹**



ERICKSON
THE TOWING SOURCE SINCE 1958

Universal

Works on all tire sizes and rim combinations

8051880 - Wt. 0.8 lb **9⁹⁹**

See page 76 for Spare Tire Lock 8290413



CLIII Ball Mount Sets

5/8" pin & clip
2" x 3/4"

- Max. gross tongue weight: 600 lb
- Max. gross trailer weight: 6,000 lb

8390361 - Wt. 8.5 lb

3-1/4" x 2"

- Max. gross tongue weight: 500 lb
- Max. gross trailer weight: 5,000 lb

8390379 - Wt. 9.1 lb..... **29⁹⁹**/set



CLIII/IV Ball Mounts

- Hex shaped mount for easy one wrench mounting with Reese Towpower™ 'Interlock' trailer hitch balls
- Max. gross tongue weight: 500 lb
- Max. gross trailer weight: 5,000 lb

Drop	Rise	Wt. (lb)	ITEM	PRICE
2"	3/4"	5.7	8210114	34.99
3-1/4"	2"	6.6	8210122	34.99
5-1/4"	4"	7.9	8210130	39.99

Compatible with trailer hitch balls on Page 74



CLIII Step Bumper Receiver

Fits many factory and aftermarket step bumpers
8004694 - Wt. 14.3 lb **49⁹⁹**



CLIII Adjustable Ball Mount / Hitch Receiver

- Ideal for towing a trailer and carrying a hitch accessory combined
 - Max. gross tongue weight: 500 lb
 - Max. gross trailer weight: 5,000 lb
 - Drop range: 1-5/8", 3-1/8", 4-5/8", 6-1/8", 7-5/8" & 9-1/8"
 - Rise range: 3/8", 1-7/8", 3-3/8", 4-7/8", 6-3/8" & 7-7/8"
- 8245698 - Wt. 20.1 lb **89⁹⁹**



CLIII 2" x 3/4" Ball Mount Kit

- Storage bag and hitch cap cover
 - 5/8" bent locking hitch pin
- 8390387 - Wt. 10.3 lb **44⁹⁹**



CLIII 2" x 3/4" Ball Mount Kit

- Durable blow mould storage case
 - 5/8" dogbone locking hitch pin
- 8308777 - Wt. 11.3 lb **34⁹⁹**



2" Adjustable Dual Ball Mount

- Special rotating design covers a range of towing needs
 - 1-7/8" 2,000 lb hitch ball
 - 2" 5,000 lb hitch ball
 - 5,000 lb hook
- 8326282 - Wt. 28.6 lb **139⁹⁹**



CLIII Adjustable Ball Mount

- Max. gross tongue weight: 500 lb
 - Max. gross trailer weight: 5,000 lb
 - Drop range: 3", 4-1/2", 6", 7-1/2"
 - Rise range: 1-3/4", 3-1/4", 4-3/4", 6-1/4"
- 8210056 - Wt. 13.4 lb **49⁹⁹**



CLIII Dual Welded Ball Mount

- 2" drop with 2" ball for 5,000 lb max. gross trailer capacity
 - 3/4" rise with 1-7/8" ball for 2,000 lb max. gross trailer capacity
- 8048571 - Wt. 10.1 lb **44⁹⁹**



Retractable Gooseneck Truck Bed Ball Mount

- Max. vertical load: 5,000 lb
 - Max. gross trailer weight: 25,000 lb
 - 2-5/16" hitch ball
- 4200125 - Wt. 35.5 lb **169⁹⁹**





CLII Rotating Ball Hitches

Type	Trailer Hitch Ball Sizes	Rated Cap.	Wt. (lb)	ITEM	PRICE
Dual Ball	1-7/8", 2"	2,000, 5,000 lb	6.9	8114936	49.99
Tri-Ball	1-7/8", 2", 2-5/16"	2,000, 5,000, 7,500 lb	9.4	8114944	59.99



Tri-Ball Hitch with Hook

Attachment	Gross Tongue Weight	Gross Trailer Weight	Wt (lb)	ITEM	PRICE
1-7/8" Ball	200 lb	2,000 lb	11.1	8182222	79.99
2" Ball	500 lb	5,000 lb			
2-5/16" Ball	750 lb	7,500 lb			
Hook	750 lb	7,500 lb			



500 lb Hitch Mount Cargo Carriers

For 2" hitch receivers

	Dimensions	Material	Features	Wt (lb)	ITEM	PRICE
A	4-1/2 ft x 1-5/8 ft	Steel	-	32.5	8265134	99.99
B	4 ft x 1-1/2 ft	Steel	Reversible Z-mount	33.0	8137986	99.99
C	4 ft x 1-7/8 ft	Aluminum	-	32.9	8265126	159.99
D	4 ft x 2-1/2 ft	Steel	Detachable/fold-up ramp	83.8	8304974	189.99
E	4 ft x 2-1/2 ft	Aluminum	Detachable 3 pc ramp	61.5	8265092	299.99

Adjustable Hitch Bed Extender

- Extend truck bed for carrying longer payloads
 - Side arms fold down supporting a portable work area
 - Fits 2" hitch
 - Fits 1-1/4" hitch with adapter - 8159683
 - Requires 4 pc clevis pins
- 8318156** – Wt. 41.2 lb **129⁹⁹**



CLIII 20" Hitch Extender with Step

- Allows for easy access to truck beds and roof racks
 - Max. gross tongue weight: 350 lb
 - Max. gross trailer weight: 3,500 lb
- 8304982** – Wt. 12.0 lb **29⁹⁹**



CLIII/IV Dual Receiver Hitch Extension

- Splits standard 2" receiver - lower for towing, upper for hitch accessories
- 8353211** – Wt. 17.3 lb **69⁹⁹**



Hitches



Hitch Receiver Tubes

Make your own hitch



Hitch Receiver Size	Tube Length	Pin Hole	Wt. (lb)	ITEM	PRICE
1-1/4"	6"	1/2"	1.6	8205171	12.99
2"	6"	5/8"	4.1	8283426	12.99
2"	12"	5/8"	7.5	8157307	20.99
2"	18"	5/8"	10.8	8283434	26.99
2"	24"	5/8"	15.2	8283442	32.99



Hitch Receivers

Type	Application	Wt. (lb)	ITEM	PRICE
F Reducer*	2" to 1-1/4"	4.1	8159683	16.99
G Adapter**	1-1/4" to 2"	8.3	8159691	39.99
H Extender*	Adds 14" of Clearance	11.8	8159709	44.99

*reduces towing capacity by 50%
**Not for towing, accy use only



16,000 lb Fifth Wheel Hitch
8328221 – Wt. 108.0 lb **399⁹⁹**

Couplers



Trailer Couplers

Class	Ball Size	Coupler Width	Gross Tongue Wt.	Gross Vehicle Wt.	Wt. (lb)	ITEM	PRICE
CLI	1-7/8"	2"	300 lb	2,000 lb	2.9	8096935	10.99
CLI	1-7/8"	2"	200 lb	2,000 lb	2.4	4200045	14.99
CLI	1-7/8"	2-1/2"	300 lb	2,000 lb	2.9	8096943	11.99
CLI	1-7/8"	3"	300 lb	2,000 lb	3.0	8096950	12.99
CLII	2"	2"	500 lb	3,500 lb	4.1	8157323	14.99
CLII	2"	2"	500 lb	3,500 lb	3.9	4200048	16.99
CLII	2"	2-1/2"	500 lb	3,500 lb	4.2	8157349	16.99
CLII	2"	2-1/2"	500 lb	3,500 lb	4.1	4200049	16.99
CLII	2"	3"	500 lb	3,500 lb	4.7	8096968	14.99
CLIII	2"	3"	750 lb	5,000 lb	5.1	8144875	19.99
CLIII	2"	3"	700 lb	5,000 lb	5.2	4200052	24.99

See page 76 for Coupler Locks



PowerFist



Shelby

A-Frame Trailer Couplers

Class	Ball Size	Gross Tongue Wt.	Gross Trailer Wt.	Wt. (lb)	ITEM	PRICE
CLIII	2"	700 lb	5,000 lb	6.7	8096984	24.99
CLIV	2-5/16"	1,500 lb	10,000 lb	8.2	8097008	29.99
CLIV	2-5/16"	1,500 lb	13,000 lb	8.7	4200010	34.99



CLI to IV Trailer Coupler Guard

Helps prevent damage to towed vehicle

8208126 - Wt. 0.4 lb **14.99**



Hitch Locating Device

Magnetic, telescoping LED lights assist in guiding hitch ball to coupler

8258188 - Wt. 0.4 lb **24.99**



Trailer Hitch Balls

TRAILER HITCH CLASS RATINGS

Class	Gross Trailer Weight	Gross Tongue Weight
I	2,000	200
II	3,500	350
III	5,000	500
IV	10,000	1,200
V	+ 10,000	+1,200



Trailer Hitch Ball Covers

Style	Size	Wt. (lb)	ITEM	PRICE
A	Standard	1-7/8" & 2"	8103566	2.49
	Standard	2-5/16"	8103574	2.49
B	4-Wire Flat	1-7/8" & 2"	8151342	2.99
	4-Wire Flat	2-5/16"	8151359	2.99



Trailer Hitch Balls

2-1/2" bolt length

Ball Size	Bolt Size	Capacity	Wt. (lb)	ITEM	PRICE
1-7/8"	3/4"	2,000 lb	1.8	8194169	7.49
1-7/8"	1"	2,000 lb	2.2	8194201	8.99
2"	3/4"	3,500 lb	2.1	8194243	8.99
2"	1"	5,000 lb	2.5	8194276	9.99
2"	1-1/4"	10,000 lb	4.0	4200172	14.99
2-5/16"	1-1/4"	12,000 lb	4.0	8251225	16.99



2" Hitch Receiver Covers

Colour	Wt. (lb)	ITEM	PRICE	
-	Black	0.2	8236044 4.49	
-	Chrome	0.2	8236051 5.49	
D	Flip Front	Black	0.2	8104218 4.99
	Flip front	Chrome	0.6	8104226 5.99



Hitch Balls

- 1" bolt dia.
- 2" bolt length

Ball	Capacity	Wt. (lb)	ITEM	PRICE
1-7/8"	2,000 lb	2.4	8210155	11.99
2"	6,000 lb	2.7	8210163	11.99
2-5/16"	6,000 lb	3.4	8210171	12.99



3/4" ID x 1" OD Steel Bushing Reducer

Allows use of 3/4" shank trailer ball in 1" shank ball mount
8182214 - Wt. 0.1 lb **2.49**



WORK WITH US!



Visit www.princessauto.com/careers to apply for any of our positions across Canada



Part-Time • Full-Time • Benefits • Opportunities • Fun



18" Trailer Hitch Ball Wrench

Extended length provides added torque 1-1/8" and 1-1/2" ends fits most popular hitch ball nuts

8150328 - Wt. 1.8 lb **14.99**

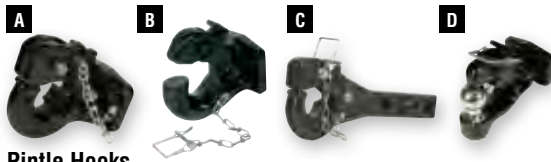

Pintle Hooks

	Cap.	Max. Vehicle Load	Gross Trailer Weight	Wt. (lb)	ITEM	PRICE
A	5 Ton	2,000 lb	10,000 lb	8.8	4200129	49.99
B	15 Ton	6,000 lb	30,000 lb	10.2	4200128	89.99
	20 Ton	8,000 lb	40,000 lb	13.0	4200139	99.99
C	5 Ton	2,000 lb	10,000 lb	14.9	4200147	99.99
D	8 Ton*	3,000 lb	16,000 lb	13.1	4200126	99.99

*With trailer ball

Tow Rings

Ring ID	Type	Max. Vertical Load	Max. Gross Trailer Weight	Wt. (lb)	ITEM	PRICE
3"	3 Position	2,000 lb	12,000 lb	15.4	4200130	49.99



Pintle Hooks



Tow Rings

For 2" hitch receiver

Ring ID	Capacity	Wt. (lb)	ITEM	PRICE
E	2"	10,000 lb	8063745	37.99
F	2-1/2"	12,000 lb	8173676	49.99



10,000 lb Tow Hook Kit
8002273 - Wt. 2.1 lb



12⁹⁹



3/4" CLIV Tow Shackle

- Towing capacity: 5,000 lb
- Max. gross vehicle weight. 10,000 lb

8386088 - Wt. 7.8 lb



38⁹⁹



12,000 lb Tow Hook
For 2" hitch receiver
8173742 - Wt. 8.7 lb



49⁹⁹



10,000 lb Pintle Mount
Mount in high or low position
4200124 - Wt. 15.1 lb



69⁹⁹

Sway Control & Tow Bars



5,000 lb Adjustable A-Frame Tow Bar

- A convenient way to tow your vehicle
- Removes with ease at quick-release pins
- 37-1/2" max. width
- USE WITH SAFETY CHAINS or CABLE

8041550 - Wt. 36.6 lb

129⁹⁹



Trailer Friction Sway Control Bar Kit

- Reduce lateral movement of trailer
- Left or right hand mount

8007029 - Wt. 14.9 lb

59⁹⁹

Replacement Sway Control Ball

For trailer sway control unit 8007029
8190126 - Wt. 0.7 lb

4⁹⁹



Adjustable Weight Distributing Hitch

Evenly distribute weight over the entire length of tow vehicle and trailer, resulting in a more level ride with more control and stability, better braking, less strain on vehicle and increased towing capacity

8371593 - Wt. 70.1 lb

349⁹⁹



Safety Chains & Security



2 pc 6,500 lb 3/8" x 3 ft Trailer Safety Cables

8103608 - Wt. 2.8 lb

16⁹⁹



5,200 lb 1/4" x 4 ft Trailer Safety Chain

8002889 - Wt. 3.0 lb

19⁹⁹



Hitch Pins

Type	Style	Diameter	Wt. (lb)	ITEM	PRICE
G	-	Standard	1/2"	4200041	2.99
	-	Standard	5/8"	4205217	4.99
H	CLI/II	Bent Locking	1/2"	8043814	11.99
	CLIII/IV	Bent Locking	5/8"	8043823	14.99
I	CLI/II	Swivel Head Locking	1/2"	8159485	14.99
	CLIII/IV	Swivel Head Locking	5/8"	8159667	14.99
J	CLIII/IV	Dogbone Locking	5/8"	8290371	14.99
	CLIII/IV	Dogbone Locking	5/8"	8290389	19.99



Anti-Theft Towing Lock Set

- Deter theft of your trailer
- Universal coupler lock and brass coupler lock
- Interchangeable pin lock with 1/2" and 5/8" bent pins

8206732 - Wt. 3.6 lb

59⁹⁹



Connectors / Adapters

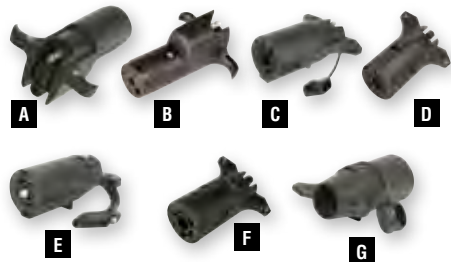

Trailer Adapters

	Pins	Wt. (lb)	ITEM	PRICE
A	6:4	0.1	8211906	8.99
B	6:4	0.1	8277220	9.99
C*	7RV:4	0.2	8305534	8.99
D	7RV:4	0.2	8277238	9.99
E	7RV:5	0.3	8381097	7.99
F	7RV:6	0.3	8211955	12.99
G	7RV:6	0.3	8277246	12.99

*Dust cover



7:4 Nite-Glow Flex Coil Trailer Adapter

8141616 – Wt. 0.8 lb **39⁹⁹**



6 & 7RV Connector Holder

Mount to trailer frame and store connectors when not in use
8381071 – Wt. 0.1 lb..... **2⁹⁹**



4-Way Vehicle Tail Light Converter

Convert vehicles with separate turn and stop lights to standard trailer tail light wiring
8201881 – Wt. 0.5 lb **17⁹⁹**



7, 6-Way Trailer Wiring Junction Box

Quick and easy hook-up from trailer connector to trailer wiring
8215741 – Wt. 0.7 lb **12⁹⁹**



Trailer Connectors

	Pins	End	Wt. (lb)	ITEM	PRICE
H	4-Way	Trailer	0.2	8211963	6.99
I	4-Way	Vehicle	0.4	8211971	6.99
J	4-way	Trailer	0.2	8277147	7.99
K	4-way	Vehicle	0.4	8277154	7.99
L	6-Way*	Trailer	0.5	8211989	7.99
M	6-Way	Vehicle	0.4	8212003	7.99
N	7RV	Trailer	0.2	8212011	8.99
O	7RV	Trailer	0.2	8277204	12.99
P	7RV	Vehicle	0.3	8212029	8.99
Q	7RV	Vehicle	0.3	8277188	12.99
R	7RV	Vehicle	0.5	8384968	12.99

*Cable protector



Trailer Harnesses

	Pins	Length	Wt. (lb)	ITEM	PRICE
U	4-way	12"	0.1	8198129	3.99
V	2-way	12"	0.1	8198137	5.99
W	4-way	4 ft	0.2	8241408	5.99
X	4-way	2-1/2 ft	0.3	4210429	9.99
Y	4-way	25 ft	0.9	4200186	12.99
Z	7:4	4 ft	0.8	8005746	19.99



Looking for the perfect gift?
GIFT CARDS
are available at any Princess Auto location



S) Spare Trailer Tire Lock
8290413 – Wt. 0.5 lb **7⁹⁹**

T) Trailer Coupler Lock
8104259 – Wt. 0.4 lb **9⁹⁹**



Swivel Head Locking Coupler Pins

- Nylon cap keeps dirt out
- Locks without key

Size	Wt. (lb)	ITEM	PRICE
1"	0.7	8159451	14.99
3-1/2"	0.7	8159436	14.99



5/8" CLIII Locking Hitch Pin
8026708 – Wt. 1.2 lb **14⁹⁹**

SEE PAGE 72 FOR SPARE TRAILER TIRE MOUNTS



WORK with us!



We are always looking for team-oriented people with a passion for delivering Royal Service.

Visit www.princessauto.com/careers to apply for any of our positions across Canada

Part-Time • Full-Time • Benefits • Opportunities • Fun



The Hopkins Standard

Unmatched new product solutions for more than a quarter century



Meets or exceeds SAE standards for best quality performance



Dedicated team of Technical Specialists for after sale support



Endurance™ Professional Wiring Series Multi-Tow® Trailer Adapters



Impulse® Digital Trailer Brake Controllers



Juice® Ultimate Power™ Booster Cables



Endurance™ Professional Wiring Series

	Pin	End	Wt. (lb)	ITEM	PRICE
A	7RV	Vehicle	0.6	8268898	19.99
B	7RV	Trailer	0.3	8268955	19.99
C	4 ft 5-way & 1-1/2 ft	Vehicle & Trailer	0.5	8337503	24.99
D	20 ft 4-way Y-harness	Trailer	0.9	8337495	29.99
E	7:6, 5 & 4	Trailer	0.5	8361164	34.99
F	7:5 & 4	Trailer	0.7	8337487	39.99
G	1-1/2 ft 5-way	Trailer	0.2	8384877	9.99
H	4 ft 5-way	Vehicle	0.3	8384901	16.99
I	6-way	Vehicle	0.4	8384919	16.99

7:4 OEM Multi-Tow Replacement Connector

- Provides 7-way RV blade and 4-way flat towing
- 2-door connection protection
- Snap-fit mounting bracket



8249112 – Wt. 0.8 lb **39.99**



Multi-Tow® Trailer Adapters

	Pins	Wt. (lb)	ITEM	PRICE
J	7RV:5 & 4*	0.4	8180101	24.99
K	7RV:6 & 4	0.4	8173213	24.99
L	7RV:5 & 4	0.3	8173270	24.99
M	7RV:4	1.0	8119505	34.99

* 12 V socket

Plug-In-Simple® T-Connectors

- No cutting, no splicing...saves time
- Plug into tail light harness of vehicle
- Detachable 4-way flat harness



Vehicle Make	Vehicle Models	Wt. (lb)	ITEM	PRICE
Ford	F150 '87-96, F250 light duty/ F350 '87-98	0.5	4210422	24.99
Chev/GMC	Full size pickup '88-98, Suburban '92-99, Tahoe/Yukon '95-99	0.4	4210426	24.99
Chev/GMC	Silverado, Sierra '99-02	0.9	8003743	34.99
Dodge Pick-Up	Ram Pickup '95-03 (except 2002 1500), Dakota '95-03	0.8	4210438	34.99

Wiring



Primary Wire

- Meets SAE J1128-GPT
- PVC insulation
- Resists heat up to 85°C, cold down to -40°C



Ga	Length	Red	Black	Green	White	Blue	Yellow	Brown	Wt. (lb)	PRICE
18	25 ft	8210809	8210817	8216343	8216368	8216376	8216384	8216392	0.3	5.49
18	100 ft	8216400	8216418	8216426	8216434	8216442	8216459	8216467	1.0	12.99
16	25 ft	8211039	8211047	8216475	8216483	8216491	8216509	8216517	0.4	6.49
16	100 ft	8216525	8216533	8216541	8216558	8216566	8216574	8216582	1.3	14.99
14	25 ft	8211062	8211070	8216590	8216608	8216616	8216624	8216632	0.5	6.99
14	100 ft	8216640	8216657	8216665	8220451	8216673	8216681	8216699	1.7	24.99
12	25 ft	8211088	8211096	8216707	8216723	8216731	8216749	8216756	0.8	9.99
12	100 ft	8216764	8216772	-	8216798	8216806	-	-	2.7	32.99
10	25 ft	8211104	8211112	-	8216830	8216848	-	-	1.2	14.99
8	25 ft	8216871	8216889	-	-	-	-	-	1.7	21.99

TRAILER WIRING DIAGRAM

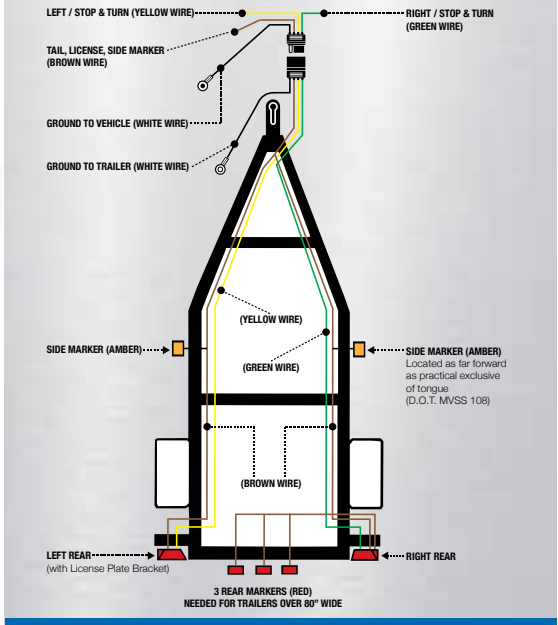

PVC Insulated Trailer Wire

Length	Wt. (lb)	ITEM	PRICE
Price per foot	0.1	4211355	0.99
25 ft Spool	1.9	4214219	19.99



PVC Insulated Trailer Wire by the Foot

Gauge	Strands	Wt. (lb)	ITEM	PRICE/ft
14	2	0.1	4210624	0.59
14	4	0.1	4210625	1.49
14	6	0.2	4210626	1.99
12	7	0.1	4210627	3.49



25 ft Split Flex Wire Loom

Dia.	Wt. (lb)	ITEM	PRICE
1/4"	0.2	8209249	4.99
3/8"	0.3	8209256	5.99
1/2"	0.4	8209264	6.99
3/4"	0.8	8218828	8.99
1"	1.0	8218844	11.99



4 oz Corrosion Preventive Wiring Connector Sealant

- Operating range: -40°C to 150°C
 - Added tackifiers improve adhesion and resistance to washout
- 8039562 - Wt. 0.2 lb ... **5.49**



Wiring Kits & Terminals



284 pc Automotive Electrical Repair Kit

8065682 - Wt. 2.8 lb

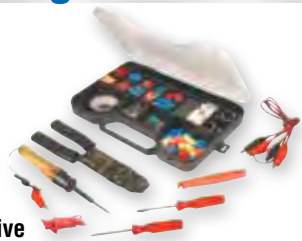

19.99

1,000 pc Insulated/Non-Insulated Terminal & Connector Kit

- The most complete wiring end set you'll need
- Crimper with two sets of interchangeable jaws

8324071 - Wt. 4.4 lb



84.99

A) 100 pc Terminal & Connector Kit

Assorted ring and spade terminals, blade and butt connectors

4210799 - Wt. 0.3 lb

8.99

B) 400 pc Terminal & Connector Kit

Assorted spade & ring terminals, blade & tap-in splice & butt connectors

4210401 - Wt. 1.8 lb

39.99

C) 120 pc Heat Shrink Terminal & Connector Kit

- Assorted spade and 1/4" ring terminals, quick and butt connectors
- Heat shrink provides added insulation and protection against moisture, dirt, corrosion and vibration

8228025 - Wt. 0.7 lb

69.99





Catseye

	Bulb	Dimensions	Lens Colour	Wt. (lb)	ITEM	PRICE
A	Incandescent	4" x 3-1/2"	Red	0.1	8186397	3.99
	Incandescent	4" x 3-1/2"	Amber	0.1	8186389	3.99
B	LED	4" x 2-1/16"	Red	0.1	8006324	9.99
	LED	4" x 2-1/16"	Amber	0.1	8006325	9.99

6 pc Mini Kits

	Bulb	Lens Colour	Wt. (lb)	ITEM	PRICE
E	Incandescent	Red	0.6	8186330	17.99
	Incandescent	Amber	0.6	4200183	17.99
F	3 Superflux LEDs	Red	0.6	8186355	34.99
	3 Superflux LEDs	Amber	0.6	8186348	34.99

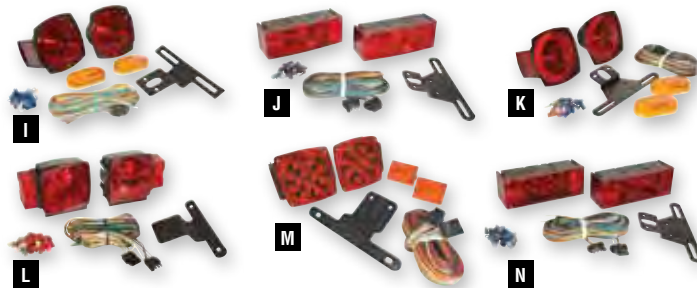

Trailer Light Kits

Complete kit for trailer and vehicle

	Details	Wt. (lb)	ITEM	PRICE
I	Standard	2.5	4200110	29.99
J*	Submersible Low Profile	2.9	8062705	32.99
K	Submersible	2.4	4200174	34.99
L	Submersible	2.6	8039877	39.99
M	Submersible LED	2.9	8006317	74.99
N*	Submersible Superflux LED	3.1	8059545	79.99

*For trailers over 80" wide

Trailer Utility Lights



6-3/8" x 4" LED Safety Light with Dual Magnet

- 18 diodes
- Super bright LEDs with 2 km visibility
- Flash or solid settings

	Lens Colour	Wt. (lb)	ITEM	PRICE
	Red	0.5	8091316	24.99
	Amber	0.5	8092173	24.99

Fender Signal Lights

	Type	Bulb	Size	Lens Colour	Wt. (lb)	ITEM	PRICE
O	Stop/turn/tail	Incandescent - #2057	4-5/16"	Red/Amber	0.5	8186504	7.99
	Turn/tail	Incandescent - #1156	4-5/16"	Amber/Amber	0.5	8186520	8.99
P	Stop/turn/tail	Incandescent - #2057	4-1/8"	Red	0.8	8186512	12.99
Q	Stop/turn/tail	21 LEDs/side	4-1/4"	Red/Amber	0.9	8059552	44.99

Beehive

	Bulb	Dim.	Lens Colour	Features	Wt. (lb)	ITEM	PRICE
C	Incandescent	2-1/2"	Red	Bracket	0.1	4200016	2.49
	Incandescent	2-1/2"	Amber	Bracket	0.1	4200017	2.49
D	Superflux LED	2"	Red	Grommet	0.2	8249195	5.99
	Superflux LED	2"	Amber	Grommet	0.2	8249203	5.99

Bullseye

	Bulb	Dimensions	Lens Colour	Wt. (lb)	ITEM	PRICE
G	Incandescent	4" x 1"	Red	0.1	4216859	4.99
	Replacement lens	-	Red	0.1	4216867	1.99
H	Incandescent	4" x 1"	Amber	0.1	4216842	4.99
	Replacement lens	-	Amber	0.1	4216875	1.99
H	10 LEDs	4-1/16" x 2-1/8"	Red	0.2	8119695	11.99
	10 LEDs	4-1/16" x 2-1/8"	Amber	0.2	8119687	11.99

Wiring Pigtails

Application	Wt. (lb)	ITEM	PRICE
Clearance/Marker	0.1	8187411	1.99
Stop/Turn/Tail Lights	0.1	8186496	1.99

17" 8-14V DC Sealed Trailer Light Bars

Required on trailers over 6 ft wide

Bulb	Wt. (lb)	ITEM	PRICE
Incandescent	0.3	8186595	14.99
LED	0.4	8186603	24.99

12V Top Mount Clearance / Marker Light

Two sided with red and amber lenses

8314023 - Wt. 0.5 lb **6⁹⁹**

2-3/4" x 2" Wedge Type Clearance/Marker Light

8258972 - Wt. 0.1 lb **2²⁹**

4-1/8" x 1-1/4" Fender Clearance/Marker Lights

Red/amber - commonly used on cargo and recreational trailers

Bulb	Wt. (lb)	ITEM	PRICE
Incandescent	0.1	8186454	6.99
LED	0.2	8186462	12.99

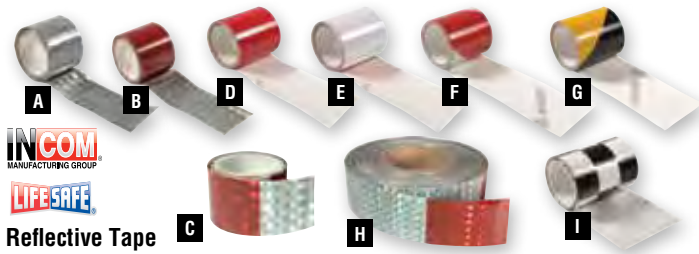

Reflective Tape

	Width	Length	Colour	Wt. (lb)	ITEM	PRICE
A	1-1/2"	4 ft	Red	0.1	8268807	9.99
B	1-1/2"	4 ft	Silver	0.1	8268773	9.99
C	1-1/2"	4 ft	Red/Silver	0.1	5040199	9.99
D	2"	4 ft	Red	0.1	8268732	8.99
E	2"	4 ft	Silver	0.1	8268740	8.99
F	2"	4 ft	Red/Silver	0.1	8268708	9.99
G	2"	4 ft	Yellow/Black	0.1	8268724	9.99
	2"	By the foot	Red/Silver	0.1	8226821	1.99
H	2"	10 ft	Red/Silver	0.3	8226789	19.99
	2"	25 ft	Red/Silver	0.4	8226730	39.99
I	3"	15 ft	Black/White Checkered	0.2	8268757	9.99



12" Sealed Adhesive Reflective Strip
Adhesive or screw on

Colour	Wt. (lb)	ITEM	PRICE
Red	0.1	4210540	4.99
Clear	0.1	4210539	4.99

MORE FEATURES

COMING SOON!

www.princessauto.com

Look for the official launch



Princess Auto Foundation



Together we are making a difference

For more information visit us at: www.theprincessautofoundation.com

PAF PARTNERS Charitable # 833179369 RR00041

Truck

Automotive Lighting



Warning Lights

	FPM	Type	Size	Wt. (lb)	ITEM	PRICE
J	80	12V 55W	4-3/4" x 5-1/2"	1.5	8286619	39.99
K	130	12V 20W	5-1/2" x 7-1/16"	1.8	4250026	39.99
L	72	12 to 72V DC	3-1/2" x 5"	0.7	4250028	69.99
M	66	12V LED	5" x 6-1/4"	1.5	8139271	99.99

9" LED Interior/ Exterior Vehicle Strip Lights
Waterproof PVC

Colour	Wt. (lb)	ITEM	PRICE
Amber	0.2	8240434	16.99
Red	0.2	8059495	16.99
Blue	0.2	8059503	19.99

2 pc 12V 6" Sonic Sealed Utility Lighting
Back-up lighting for trucks, cars, RVs or trailers
8229981 - Wt. 1.1 lb **19⁹⁹**

Interior LED Vehicle Lights

	LED	Size	Wt. (lb)	ITEM	PRICE
R	10	5" x 2-3/16"	0.2	8381063	19.99
S	9	9-1/2" x 1"	0.1	8380974	19.99
T	18	13" x 1"	0.2	8381022	29.99

2 pc Blue LED Accent Lighting
8063877 - Wt. 0.1 lb **11⁹⁹**



Towing Light Kits

Scratch resistant magnets for quick hook-up and removal

	Style	Wt. (lb)	ITEM	PRICE
N	EZ Mount* ‡	2.2	8056122	39.99
O	Standard ‡	3.2	8002382	46.99
P	Red/Amber ‡	3.3	8002381	49.99
Q	Heavy Duty §	5.8	8056113	99.99
	Heavy Duty LED §	7.0	8175812	124.99

*EZ Mount kit not magnetic
‡ w/ 4-way flat connector for general applications
§ w/ 4-way round connector for tow truck or commercial applications



Interior Vehicle Lights

	Size	Wt. (lb)	ITEM	PRICE
U	4" x 2"	0.1	8119653	4.99
V	4-1/2" x 2-1/2"	0.3	8063885	7.99
W	4-1/2" x 2-1/2"	0.3	8063893	8.49

*Exterior use as well



RV Ceiling Lights
Bright white with optic lens

	Lens	Wt. (lb)	ITEM	PRICE
A	Single	0.4	8316341	5.99
B	Dual	0.6	8316333	6.99



2 pc 12V Automotive Bulbs

Type	Wt. (lb)	ITEM	PRICE
#57	0.1	8230781	1.49
#67	0.1	8230740	1.49
#194	0.1	8230757	1.49
#1003	0.1	8230823	1.49
#1156	0.1	8230831	1.49
#1157	0.1	8230849	1.49
#1893	0.1	8230815	1.49
#1895	0.1	8230765	1.49
#2057	0.1	8230773	1.49
#3057	0.1	8230807	3.49
#3157	0.1	8230799	3.49



LED Automotive Bulbs

Colour	Wt. (lb)	#1156 BASE	#1157 BASE	PRICE
Amber	0.1	8063828	8063851	9.99
Red	0.1	8063836	8063869	9.99
Clear	0.1	8063810	8063844	14.99



9" x 6" Snowplow Light
8258618 – Wt. 2.4 lb **21⁹⁹**



4" 1W Utility LED Spot Light
• Ultra low power consumption
• Waterproof
8340960 – Wt. 1.1 lb **79⁹⁹**



3 ft Truck Roof Light
8335069 – Wt. 15.4 lb **99⁹⁹**

Utility Lights & Kits



12V 55W Utility Lighting

Size	Beam Pattern	Wt. (lb)	ITEM	PRICE
C	5" Spot w/grill	1.1	8337594	9.99
D	5" Spot w/cover	1.3	8338105	11.99
E	4" Fog	1.1	8258626	12.99
F	7" Spot	2.0	8258725	12.99
G	5" Fog	1.9	8334997	17.99
H	5" Spot	1.9	8335077	19.99

55W Utility / Auxiliary Halogen Bulb
8005402 – Wt. 0.1 lb **2⁹⁹**



12V 55W Utility Lighting

Size	Beam Pattern	Wt. (lb)	ITEM	PRICE
O	3" x 5" Flood	1.1	4250161	17.99
O	3" x 5" Spot	1.1	4250162	17.99
P	4-1/4" x 3-1/4" Flood	1.5	8340945	24.99
Q	4-1/4" x 3-1/4" Spot	1.5	8341406	24.99
R	6" x 4" Trapezoidal Dual Flood	1.9	8340895	29.99
S	6-1/4" x 4-3/4" Flood/Spot	1.6	8024853	34.99

55W Utility / Auxiliary Halogen Bulb
8005402 – Wt. 0.1 lb **2⁹⁹**



2 pc Auxiliary Lighting

Size	Beam Pattern	Wattage	Wt. (lb)	ITEM	PRICE
T	3-1/2" Fog	3W	1.2	8340978	49.99
U	4-1/2" Flood	100W	1.6	8201568	24.99
V	4-1/2" Spot	100W	1.7	8200164	24.99
W	5" x 3" Spot w/stone guard	55W	2.1	4250151	34.99
X	5" Spot w/stone guard	55W	4.4	8006319	59.99

*Wiring kits included (4250151 & 8006319)
*LED (8340978)

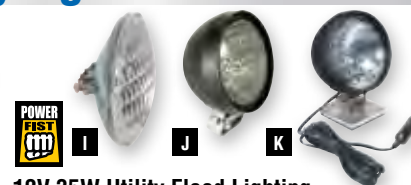

12V 35W Utility Flood Lighting

Size	Wt. (lb)	ITEM	PRICE
I	5"	4254025	8.99
I	6"	4254033	9.99
J	6"*	4251815	19.99
K	5" Trapezoidal*†	8067415	24.99

* High impact rubber housing
† Magnetic base with adapter

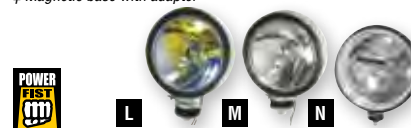

12V 100W Auxiliary Driving Fog Lights

Style	Wt. (lb)	ITEM	PRICE
L	6" Neon Blue*	8063695	29.99
M	6" Clear	8063679	29.99
N	7" PVC Protected	8063760	39.99

*Amber when on



Battery Accessories

A) 2 pc Anti-Corrosion Post Washers
4213062 – Wt. 0.1 lb **1.99**

B) Side Post Terminal
4270102 – Wt. 0.3 lb **1.99**

C) Top Post Terminal
4270101 – Wt. 0.3 lb **1.99**

D) 2 pc Post Shims
8064453 – Wt. 0.1 lb **3.49**

E) 2 pc Terminal Protectors
8064420 – Wt. 0.1 lb **3.49**

F) 2 pc Marine Terminals
8064412 – Wt. 0.7 lb **5.99**



Battery Master Cut-Off Switches
Disconnects battery to prevent drain and helps deter vehicle theft

G) Keyed
8105033 – Wt. 0.3 lb **6.99**

H) Top Post
Low amperage bypass wire maintains vehicle's interior pre-set functions
4210962 – Wt. 0.3 lb **9.99**

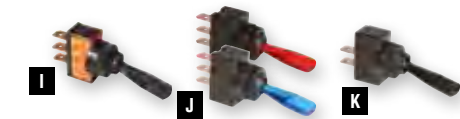
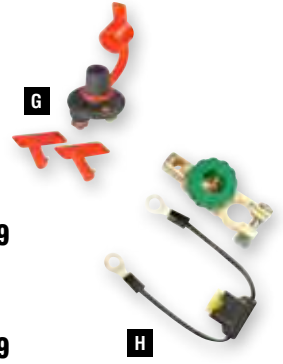

Paddle Toggle

Function	Colour	Wt. (lb)	ITEM	PRICE
I ON/OFF/ON	-	0.1	8171787	2.99
J ON/OFF	Red	0.1	8171837	3.49
J ON/OFF	Blue	0.1	8171852	3.49
K ON/OFF	-	0.1	8171779	4.49



Illuminated Rocker Switches

- 16A @ 12V DC
- Lights up in 'ON' position

Colour	Wt. (lb)	ITEM	PRICE
Amber	0.1	8171969	3.49
Green	0.1	8171977	3.49
Blue	0.1	8206971	3.49
Red	0.1	8171951	3.49

60A Push Button Starter Switch
Ideal for industrial and motorsport vehicles
8271090 – Wt. 0.1 lb **8.99**

3-Speed Auxiliary Heater Fan Switch
8003273 – Wt. 0.1 lb **9.99**

12V Push Button Switch Kit
Replace broken horn buttons, operate auxiliary and vehicle horns, suitable for a range of other uses
8237810 – Wt. 0.3 lb **9.99**



Push Button Skull Switch
8306359 – Wt. 0.1 lb **9.99**

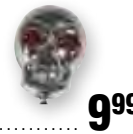

35A 4-Position Ignition Switch
ACC-OFF-IGN/ACC-IGN/START
8205452 – Wt. 0.4 lb **12.99**



Switches

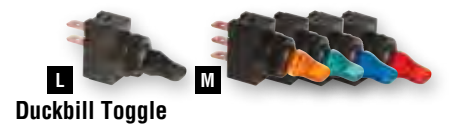

Duckbill Toggle

Amps	Colour	Wt. (lb)	ITEM	PRICE
L 16	-	0.1	8171829	3.99
L 20	Amber	0.1	8171910	3.99
M 20	Green	0.1	8171936	3.99
M 20	Blue	0.1	8171902	3.99
M 20	Red	0.1	8171894	3.99



Bat-Type Toggle

Amps	Volts	Features	Wt. (lb)	ITEM	PRICE
N 20	12	Red Tip	0.1	8171860	4.49
O 25	12	-	0.1	8171944	4.49
P 10	12	-	0.1	8172769	4.49
Q 35	6-12	-	0.1	8172777	4.99



Truck Mirrors

Dimensions	Material	Wt. (lb)	ITEM	PRICE
R 16" x 6"	Aluminum	2.9	8119620	14.99
S 16" x 7"	Stainless Steel with Marker Light	4.4	8119612	29.99
T 6"	Stainless steel	1.0	8119638	9.99
T 8-1/2"	Stainless steel	1.4	8119646	13.99



6" x 4" Side View Mirror
14" arm
8335093 – Wt. 2.0 lb **14.99**



Dual Positioning Towing Mirror
• Fully adjustable 7-1/2" x 5-1/2" dual mirrors maximize visibility
• Attach to existing mirror with non-marring adjustable security straps
• Aerodynamic design
8311284 – Wt. 1.5 lb **19.99**



Emergency Warning Triangles

Qty	Wt. (lb)	ITEM	PRICE
1 pc	2.8	8275208	9.99
3 pc*	10.9	8180119	29.99

*With case



2 pc Grab Bar Set
Use on pick-ups, vans, SUVs, RVs and boats
4220020 – Wt. 0.7 lb **11.99**



FIAMM

**Be equipped with the power of communication.
Inform those that need to be warned -
with safety in mind.**



FIAMM - the world's leading supplier of warning devices



12V 5A Horns

Universal mounting bracket



Tone	Hz	dB @ 4"	Wt. (lb)	ITEM	PRICE
High	485 Hz	125	0.6	8237752	14.99
Low	405 Hz	125	0.6	8237760	14.99
'Freeway Blaster' High	485 Hz	130	0.6	8237778	19.99
'Freeway Blaster' Low	405 Hz	130	0.6	8237786	19.99

8 oz Air Horn

- Great for marine use, sporting events, job sites, camping
- Non flammable and ozone friendly
- Can be heard up to 1.6 km (1 mile)



8200396 - Wt. 0.9 lb **19⁹⁹**



15A Dual Trumpet Air Horn Kit

"European" sound
8237794 - Wt. 1.8 lb **39⁹⁹**



12V DC Oogah Horn

Classic oogah sound
8237802 - Wt. 1.7 lb **39⁹⁹**



Chrome Trumpet Air Horn Kit

125 dB @ 12 PSI
8240657 - Wt. 1.8 lb **39⁹⁹**

PowerFist **Buyers**



12V DC Power Outlet Adapters

Features	Wt. (lb)	ITEM	PRICE
A Dual	0.4	8257768	9.99
B Triple	0.3	8260382	9.99
C -	0.5	4220012	11.99
D Battery clamps	0.5	4220011	12.99



Power Door Lock Kits

8008425 - Wt. 0.4 lb **9⁹⁹**

4-Door with Remote

Equip your vehicle with remote keyless entry
8204414 - Wt. 2.6 lb **69⁹⁹**



12V DC Wireless Remote Kit

- 180 ft range
- Four independent channels for multiple vehicle accessories

8003441 - Wt. 0.6 lb **44⁹⁹**



12 to 80V DC Industrial Back-Up Alarm

- 97± 4 dB
- Reverse polarity protected
- Voltage spike and surge protected

8104135 - Wt. 0.7 lb **29⁹⁹**



12V DC Adhesive Power Socket

- Mounts anywhere 12V DC power is required on vehicle or trailer
- Great for tailgating, camping, hunting, boating, emergency use

8223380 - Wt. 0.3 lb **14⁹⁹**



Bluetooth Car Kit

- Hands-free cell phone use during operation of motor vehicle
- Supports headset and handsfree profiles
- Rechargeable lithium DC 3.7V, 650 maH battery
- 10 hrs talk time
- Car charger, back clip and USB charger line

8307522 - Wt. 0.4 lb **49⁹⁹**



Back-Up Sensors

	Size	Wt. (lb)	ITEM	PRICE
E	Wireless	0.9	8384984	129.99
F	Camera System	2.0	8301970	179.99



Hitches



■ Reese ■ Buyers



RV Bumper Accessory Hitch

For cargo and bike carriers
8268575 – Wt. 11.9 lb

44⁹⁹



500 lb Hitch Mount Motorcycle/Dirtbike Hauler

- For 2" hitch receiver
- 6 ft x 5" platform
- 13" clearance between receiver and frame

8169781 – Wt. 54.9 lb

149⁹⁹

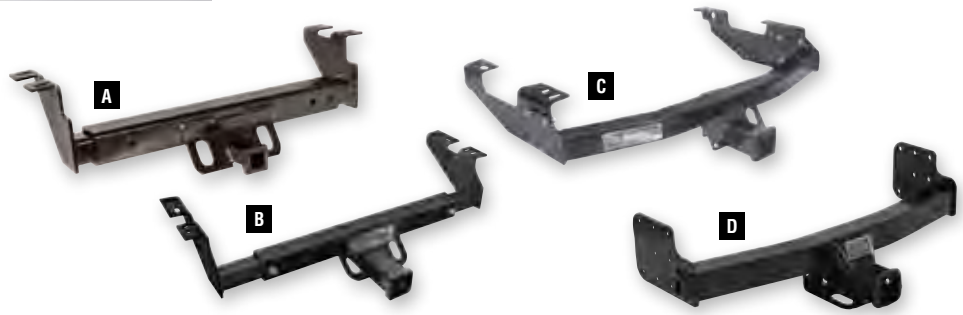

Multi-Fit Hitches

	Vehicle Make	Class	Max. Gross Tongue Weight	Max. Gross Trailer Weight	Tube Design	Wt. (lb)	ITEM	PRICE
A	Chevy/GMC, Dodge, Ford, Nissan & Toyota pickups, minivans	CLII	350 lb	3,500 lb	Square	31.6	8193690	139.99
B	Chev trucks/minivans, Ford pickups, Dodge trucks, GMC pickups & SUVs, Toyota trucks	CLIII	500 lb	5,000 lb	Square	43.5	8161606	159.99
C	Chev/GMC, Dodge, Ford & Toyota pickups	CLIV Hide-Away	600 lb	6,000 lb	Square	52.5	8047605	169.99
D	**	CLIII	500 lb	5,000 lb	Square	69.6	8164758	249.99
	**	CLIII/IV	700 lb	7,000 lb	Round	59.5	4200028	279.99

Truck Accessories



8 ft Hydraulic Steel Truck Bed Dump Insert

6,000 lb max. payload (2 cu yd cap.)

8275174 – Wt. 1080.0 lb

Available through special order - visit princessauto.com

2999⁹⁹



Underbody Truck Boxes

6-3/4 cu ft

4280035 – Wt. 95.0 lb

349⁹⁹

9 cu ft

4280036 – Wt. 122.0 lb

439⁹⁹



18 ft Foam Weather Strip

8225716 – Wt. 0.2 lb

149



300 lb Truck Tire Service Step

Perfect for loading and servicing pick-ups, SUVs, RVs, semis

8268617 – Wt. 12.7 lb

34⁹⁹



500 lb Cargo Truck Rack

Removes with ease when not required

8291528 – Wt. 50.1 lb

139⁹⁹



250 lb Pickup Truck Ladder Rack

8292179 – Wt. 46.9 lb

119⁹⁹

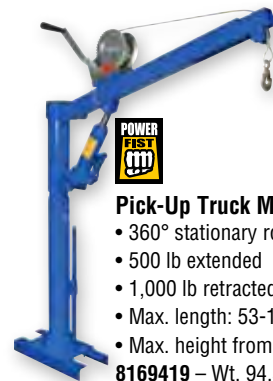

Pick-Up Truck Mount Crane

- 360° stationary rotating swivel boom
- 500 lb extended
- 1,000 lb retracted
- Max. length: 53-1/2"
- Max. height from base: 80"

8169419 – Wt. 94.5 lb

209⁹⁹



FOLDING RAMPS



Galvanized Steel

Economically priced, with lots of features. Arched design allows for loading of low clearance equipment. Galvanized steel construction for corrosion protection.

* Sold as pairs and include 2 cargo / safety straps.

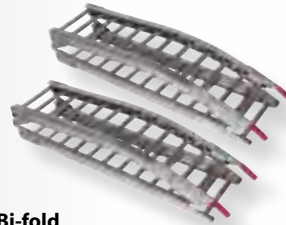

Arched Bi-fold

1200 lb capacity
38 lb/ramp

8ft

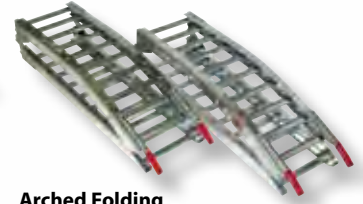

Arched Folding

1400 lb capacity
32 lb/ramp

7ft

Utility Ramp Kit

Requires 2 pieces of 3/4" plywood cut to the width you need

(max. 48" width)



8ft



STORAGE CONTAINERS

Secure Storage on Demand

West storage units are constructed using corrosion resistant galvanized steel, providing better durability and longevity over conventional wood, vinyl clad, and painted steel structures. Plus your valuable items are protected! Our storage units come standard with a high security door bar lock and lever mechanism that is designed to accept any standard lock. Heavy-duty hinges and tamper proof hardware provide additional security. All our containers are man portable, durable and weather tight, making them the perfect choice for a multitude of storage applications.

Visit your nearest Princess Auto for full details.



Full Container (shown)

81 x 86 x 87.5
W x L x H

Half Container

81 x 44.5 x 87.5
W x L x H



Skid Container

Mount on floor or pallet

40 x 48 x 78.5
W x L x H



Storage Locker

Shelves included

24.25 x 21 x 70
W x L x H



⚠️ DANGER

IMPROPER USE WILL RESULT IN SERIOUS INJURY OR DEATH

- MUST** remove tailgate before loading onto a pick-up truck
- ALWAYS** use straps or cables to firmly attach loading ramp to a loading surface, preventing them from slipping or moving during loading
- DO NOT** ride or drive equipment up or down ramp
- USE** a winch or push unit up with assistance



8 ft Foldable Utility Ramp Hardware

- For wheelchairs, motorized scooters, hand carts, wheelbarrows
- 600 lb capacity
- Corrosion resistant galvanized steel
- Rubber coated supports
- Minimum 3/4" plywood required
- Must remove tailgate before loading onto a pick-up truck
- Use a winch or push unit up with assistance

8118234 – Wt. 25.6 lb **99⁹⁹**



6 ft x 6-1/2 ft Utility Blanket

High quality quilted cotton pad for various applications
8229031 – Wt. 6.9 lb **24⁹⁹**



4 ft x 6 ft x 5/8" Truck Bed Mat

- Endless uses and applications
- Lightweight - easier to handle

8350175 – Wt. 82.0 lb **69⁹⁹**



Universal Truck Bedliner Rake End

- Easily outperforms hoses and brooms to remove any type of hard-to-reach materials from bedliner grooves
- Accepts standard broom handles or telescopic painter handles

8196016 – Wt. 0.4 lb **8⁹⁹**



2,200 lb Universal Full Size Unloader

- Unload your truck bed in no time!
- Crank handle to unload truck bed with belt sheeting

8381170 – Wt. 20.7 lb **129⁹⁹**



150W 12V 2-in-1 Ceramic Heater / Fan

- Defrost windows in any location
- Instant heat
- 360° swivel mount
- Hidden foldable handle for mobile use

8237190 – Wt. 1.1 lb **24⁹⁹**

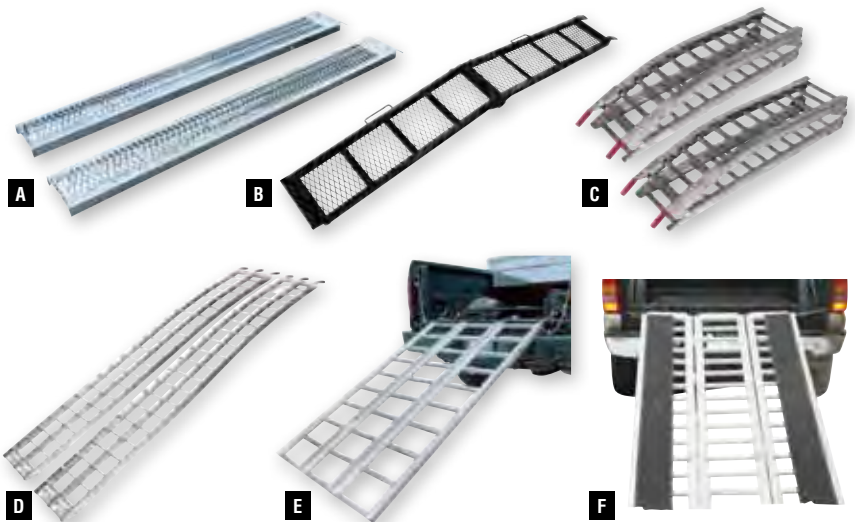

Truck Ramps

	Style	Material	Dimensions	Max. Load Capacity	Qty	Wt. (lb)	ITEM	PRICE
A	Rugged tread	Steel	72" x 8-1/2"	1,000 lb/pr	2 pc	36.1	8338089	89.99
	Rugged Tread	Steel	84" x 9"	1,000 lb/pr	2 pc	48.3	8291155	99.99
B	Bi-fold	Steel	80" x 11"	800 lb	1 pc	27.5	8291148	89.99
C	Arched Bi-fold	Aluminum	90" x 11"	750 lb	1 pc	14.8	8291080	119.99
	Arched Bi-fold	Steel	84" x 12"	1,400 lb/pr	2 pc	70.2	8006098	179.99
D	Arched Bi-fold	Steel	100" x 12"	1,200 lb/pr	2 pc	77.1	8287336	209.99
	Arched	Aluminum	90" x 12"	1,500 lb/pr	2 pc	26.6	8291106	199.99
E	Tri-fold	Aluminum	69" x 45"	1,500 lb	-	34.2	8002666	179.99
	Tri-fold	Aluminum	69" x 44-1/2"	1,500 lb	-	29.9	8291114	199.99
	Tri-fold	Aluminum	77" x 50"	1,500 lb	-	39.9	8002597	229.99
	Tri-fold	Aluminum	77" x 50"	1,500 lb	-	35.0	8291122	279.99
F	All-Season Tri-fold	Aluminum	84" x 54"	1,500 lb	-	51.8	8329989	349.99

Ramps may not be exactly as shown. Please visit www.princessauto.com for more information.

8" Ramp Plate Ends

Requires 2" x 8" or 12" boards

	Material	Capacity	Deck	Qty	Wt. (lb)	ITEM	PRICE
L	Steel*	1,500 lb/set	5/32"	2 pc	9.8	8272874	14.99
	Aluminum	350 lb/pc	1/8"	1 pc	0.8	8021393	12.99
M	Aluminum	750 lb/pc	1/4"	1 pc	1.4	8005828	18.99

*Anti-slip traction on underside for optimal gripping to truck bed. Complete with carriage bolts.



Stake Pocket and Stake Rack Hardware

	Type	Wt. (lb)	ITEM	PRICE
N	Straight weld-on	0.6	8240855	3.99
O	Tapered bolt-on	0.9	8240863	4.99
P	Straight connectors	2.1	8240897	9.99
Q	Straight latch	1.6	8240905	9.99
R	Corner connectors	2.1	8240871	9.99
S	Corner latch	1.6	8240889	9.99

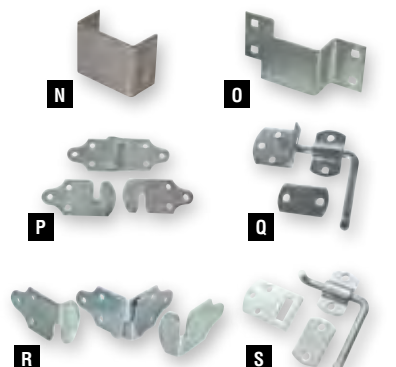



120V AC Battery Blankets

Oil and acid resistant



Watts	Wt. (lb)	ITEM	PRICE
60W	0.7	4270191	36.99
80W	0.8	8278657	39.99
160W	1.3	8278665	59.99



Magnetic Engine / Oil Heaters

- Produces up to 300 to 400°C surface temp.
- 115V AC, 60 Hz



Watts	Wt. (lb)	ITEM	PRICE
200W 2A	1.1	4270099	56.99
300W 2.5A	1.7	4270100	89.99



Heater Hose by the Foot

- Heat, and mild-chemical resistant EPDM rubber tubing, reinforced with two spirals of synthetic spiralled yarn
- -40°C (-40°F) to 121°C (250°F) operating temperature range
- 80 PSI working pressure



Hose Size	Wt. (lb)	ITEM	PRICE /ft
1/2"	0.2	4240206	0.99
5/8"	0.2	4240222	1.09
3/4"	0.2	4240255	1.19



6" 2-speed 12V DC Oscillating Fan

- Cools and ventilates
- In-line switch
- Bracket mount

8258097 – Wt. 1.4 lb **21⁹⁹**

Heating



12V Auxiliary Heaters

- Connects directly to any vehicle cooling system
- 3-speed switch (8003273) available separately



BTU's	CFM Output	Motor Speed	Wt. (lb)	ITEM	PRICE
3,425	60	1	2.8	4240007	129.99
13,500	185	3	8.8	4240003	229.99
18,500	175	3	11.1	4240005	289.99
21,000	265	3	11.0	4240004	229.99
24,700	295	3	9.7	4240028	229.99
36,000	400	3	13.3	4240006	279.99

Winch Centre



Designed with the toughest terrains in mind, the all new Superwinch line of ATV and Side by Side winches feature a full three-stage planetary gear train and new sealed motor switching system.



12V DC SUPERWINCH TERRA Series High Performance Winches

- Weather sealed permanent magnet motor
- Heavy duty, all metal 3-stage planetary gear train
- Steel drum (compatible with synthetic rope)
- Ergonomic freespool control
- Mechanical and dynamic brake
- Sealed solenoid for all-weather protection
- Sealed handlebar mounted switch and hand held remote

	Single Rated Line Pull	Line Speed	Cable Size	Wt. (lb)	ITEM	PRICE
A	3,500 lb	7.75 FPM	7/32" x 50 ft	33.6	8302176	349.99
B	4,500 lb	5.5 FPM	1/4" x 50 ft	37.1	8302192	399.99



6 ft Tree / ATV Winch Straps

	Width	Capacity	Wt. (lb)	ITEM	PRICE
	2"	10,000 lb	0.7	8273617	11.99
	4"	15,000 lb	1.2	8021419	14.99

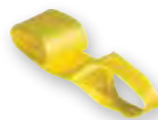

2,500 lb "Winch-In-A-Bag" Plus

- Ready to go, right out of the bag. Ideal for rescuing yourself from danger, loading/unloading your boat, off-roading with your 4-wheel drive vehicle or ATV, on the job site, or pulling a load closer to your vehicle.
- Complete kit, easy to engage and disengage

8300865 – Wt. 26.9 lb **249⁹⁹**



C) 1,000 lb 115V AC Winch

Operates on standard house current
1530044 – Wt. 28.4 lb

599⁹⁹

D) 1,500 lb 115V AC Winch

Operates on standard house current
8094930 – Wt. 22.0 lb

649⁹⁹

E) 10,000 lb 12V DC Off-road Winch

8289399 – Wt. 89.4 lb

649⁹⁹



1,000 lb 110V AC WARN Pullzall

- Lifts and pulls at maximum capacity
- Replaces old fashioned come-a-longs and chainfalls
- Move heavy machinery, hoist an engine block, lift a load precisely into place
- Forward/reverse with variable speed

8295057 – Wt. 20.0 lb **299⁹⁹**



KEEPER WINCHES

PERFORMANCE ENGINEERED

COMING SOON!



PORTABLE Class III System

KW7.5RM 7,500 lb
Rapid Mount • Fits Any Class III 2" Hitch Receiver
8400483

Wireless Remote Included

Automatic Full Load Brake



KW9.5 9,500 lb
8400509



KW13.5 13,500 lb
8400525



KW17.5 17,500 lb
8400533

Car Trailers / Rolling Weight Chart

Slope by % of grade (10%= rise of 1 foot over distance of 10') and degree of incline (angle)

MODEL	Rated Line Pull*	0% (0°)	5% (3°)	10% (5.1°)	20% (9°)	30% (13°)	40% (18°)	50% (22°)	60% (27°)	70% (32°)	80% (36°)	100% (45°)
KT2000	2,000	20,000	13,200	10,050	6,803	5,200	4,309	3,720	3,311	3,060	2,845	2,580
KWSL-2000RM	2,000	20,000	13,200	10,050	6,803	5,200	4,309	3,720	3,311	3,060	2,845	2,580
KT2500	2,500	25,000	12,563	12,563	8,503	6,500	5,388	4,650	4,160	3,825	3,555	3,225
KT3000	3,000	30,000	15,075	15,075	10,25	7,800	6,428	5,580	4,991	4,590	4,268	3,870
KT4000	4,000	40,000	20,100	20,100	13,597	10,400	8,643	7,400	6,665	6,120	5,690	5,160
KW7.5RM	7,500	75,000	37,688	37,688	25,508	19,500	16,163	13,950	12,480	11,475	10,65	9,675
KW9.5	9,500	95,000	47,738	47,738	32,310	24,700	20,473	17,670	15,808	14,535	13,509	12,255
KW13.5	13,500	135,000	67,838	57,838	46,130	35,100	28,926	25,110	22,110	20,655	19,206	17,415
KW17.5	17,500	175,000	87,938	87,938	59,487	45,500	37,813	32,550	29,116	26,775	24,894	22,575

*RATED LINE PULL = RLP – The resistance or weight the winch can pull on a single line at a right angle to the ground on the first layer of wire rope on the drum

**PLEASE NOTE: Your pulling capacity will lessen 10% to 13% with each layer of rope



CANADA'S ONE-STOP SHOP FOR ALL OF YOUR WINCHING NEEDS



12V DC Winches

- Circuit breaker protected and completely sealed high duty cycle solenoid (except 8244220)
- Weather sealed, high efficiency, low amp draw permanent series wound magnet motor
- Power in and out with freespooling clutch
- Colour coded wiring for easy do-it-yourself install
- Drum centric
- 8244386 50 ft wireless winch remote kit and mounting plate 8371189 available through special order

Single Rated Line Pull	Application	Gear Train	Braking	Gear Ratio	Cable Size	Switch	Wt. (lb)	ITEM	PRICE
2,000 lb	Light duty with ATV, trailer, utility	Differential	Dynamic	153:1	5/32" x 50 ft	Hand held w/ 6 ft lead	13.9	8244220	124.99
3,000 lb*	Rugged duty with ATV & UTVs, light trailers	3-stage	Mechanical and dynamic	136:1	3/16" x 50 ft	Handle bar w/ 15 ft lead	27.0	8244279	309.99
4,000 lb*	All-purpose duty with UTV, car or utility trailer, flat decks	3-stage	Mechanical and dynamic	136:1	7/32" x 55 ft	Hand held w/ LED worklight plus handle bar ea. w/ 15ft lead	34.5	8244345	389.99

* 4-way roller fairlead



Hand Winches

- Freewheeling positioning
- Zinc plated



Load Cap.	Reel Cap.	Type	Wt. (lb)	ITEM	PRICE
800 lb	3/16" x 40 ft	Single speed	4.2	8004698	24.99
1,200 lb	3/16" x 33 ft	Single speed/reversible*	8.5	8004709	29.99
1,200 lb	5/16" x 30 ft	Single speed/reversible	5.9	8004700	29.99
1,400 lb	5/16" x 30 ft	Single speed/reversible	7.7	8004702	34.99
1,800 lb	5/16" x 58 ft	2-speed/reversible	9.5	8004703	39.99
2,500 lb	7/16" x 30 ft	2-speed/reversible	9.5	8004705	44.99

* Equipped with 3/16" x 33 ft cable



2" Hand Winch Straps



Length	Safe Working Load	Breaking Strength	Duty	Wt. (lb)	ITEM	PRICE
15 ft	1,100 lb	3,300 lb	Light to medium	0.9	8273609	9.99
20 ft	3,300 lb	10,000 lb	Heavy	2.1	8271165	19.99
25 ft	1,100 lb	3,300 lb	Light to medium	1.2	8271140	14.99



Winch Roller Fairleads

- Prevent cable damage on angled pulls
- Reduce cable friction and winch load

Capacity	Wt. (lb)	ITEM	PRICE
2,000 lb	1.8	8002721	29.99
5,000 lb	7.0	8005300	44.99
8,000 lb	7.5	8001393	49.99



3/16" Winch Cables with Hook

- Safe working load: 2,000 lb
- Breaking strength: 4,000 lb

Length	Wt. (lb)	ITEM	PRICE
25 ft	2.1	3820028	19.99
50 ft	3.7	3820029	24.99
100 ft	7.0	3820030	34.99



Hand Winches

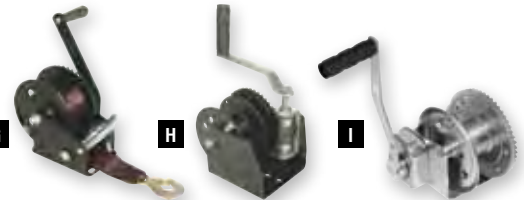

G) Reversible Hand Winches

2" x 23 ft strap with hook

Type	Wt. (lb)	ITEM	PRICE
1,000 lb single speed	7.1	8004714	34.99
2,000 lb 2-speed	11.8	8004715	49.99



Posi-Lock Hand Winches

Capacity	Type	Reel Capacity	Gear Ratio	Wt. (lb)	ITEM	PRICE
H 2,000 lb	Worm Gear	1/8" x 140 ft, 3/16" x 64 ft, 1/4" x 34 ft	41:1	9.4	1510155	99.99
I 1,500 lb	Auto Brake	1/4" x 88 ft	5:1:1	13.2	1510080	119.99

Winch Accessories

Universal ATV Winch Covers

- Help maintain the durability of your winch
- For all major brands including our Keeper® and Superwinch™ lines



Size	Dimensions	Wt. (lb)	ITEM	PRICE
Medium	14" x 7" x 7"	0.2	8261380	9.99
Large	17" x 7" x 7"	0.2	8261422	12.99

Pulley Blocks

- Doubles the capacity of any winch
- Redirect pull without cable damage



	Vert. Cap.	Horiz. Cap.	Pulley Dia.	Max Cable Size	Overall Dim.	Wt. (lb)	ITEM	PRICE
A	1,760 lb	4,000 lb	2-1/4"	3/16"	7" x 2-1/2" x 1-1/2"	1.7	8058539	9.99
B	4,000 lb	8,000 lb	2-1/4"	7/32"	7" x 3" x 1-1/4"	1.1	3800047	14.99
C	8,000 lb	16,000 lb	4"	5/16"	9" x 4" x 1-3/4"	4.3	3800046	29.99

1/4" Winch Cables with Hook

- Safe working load: 3,450 lb
- Breaking strength: 6,900 lb

	Length	Wt. (lb)	ITEM	PRICE
	25 ft	2.9	8256141	19.99
	50 ft	5.4	3820033	29.99
	100 ft	9.4	8256174	39.99

Cargo Control

Tie Downs



Stake Pocket Anchors

Type	Capacity	Quantity	Wt. (lb)	ITEM	PRICE
D Loop-around	2,000 lb	1 pc	0.9	8164105	7.99
E Toggle bolt	2,000 lb	2 pc	1.0	8040305	8.99
F Rubber block	2,000 lb	2 pc	1.6	4200121	9.99
G Retractable	1,000 lb	2 pc	0.7	8255804	34.99
G Retractable*	1,000 lb	2 pc	0.8	8255812	38.99

* Stainless Steel

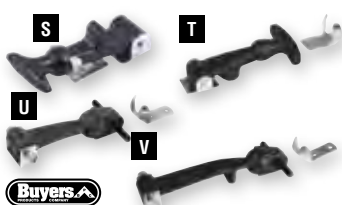

ERICKSON
Pick-Up Truck Cap Mounting Clamps
 No drilling required
2-3/4" x 2-1/2"
 8036899 - Wt. 0.3 lb **8⁹⁹**
3-3/4" x 3"
 8036907 - Wt. 0.6 lb **12⁹⁹**

Rubber Safety Hooks

- Rubber tie-down system with metal brackets
- Great for hoods, tool boxes

Length	Wt. (lb)	ITEM	PRICE
S 4-1/2"	0.6	4200165	8.99
T 4-7/8"	0.7	4200358	11.99
U 6"	0.6	4200366	9.99
V 7-7/8"	0.6	4200374	9.99



Ratcheting Cargo Bars

Prevent cargo movement in pick-up truck bed or trailer

Length	Diam.	Wt. (lb)	ITEM	PRICE
46" to 61"	1-1/2"	8.3	8247504	27.99
40" to 70"	1"	4.0	8247884	32.99



Tie-Down Anchor Rings NOT FOR LIFTING

Type	Cap.	Safe Working Load	Breaking Strength	Wt. (lb)	ITEM	PRICE
H Surface mount	7/8"	400 lb	1,200 lb	0.1	8020759	6.99
I Surface mount	1"	400 lb	1,200 lb	0.1	8021598	2.99
J Surface mount	1-1/2"	1,666 lb	5,000 lb	0.5	8348047	2.99
K Surface mount	2"	666 lb	2,000 lb	0.2	8020937	4.99
L Surface mount	2-1/2"	3,650 lb	11,000 lb	0.9	8021623	6.99
M Recessed	1-1/4"	400 lb	1,200 lb	0.9	8020811	7.99
N Recessed	1-1/2"	400 lb	1,200 lb	0.3	8021614	3.99
O Bolted mount	1-1/8"	1,650 lb	5,000 lb	0.5	8020722	9.99
P Countersink	1-1/2"	400 lb	1,200 lb	0.4	8278319	3.99
Q HD weld-on	3"	6,650 lb	20,000 lb	2.5	8074254	12.99
R Countersink swivel	3-3/4"	1,650 lb	5,000 lb	2.2	8278293	12.99



1-3/8" Heavy Duty Countersink Tie-Down Anchor Ring

NOT FOR LIFTING
 3/8"-16 x 2-1/4" carriage bolts
 8163065 - Wt. 1.2 lb **6⁹⁹**



Spring Latch Assembly

3893187 - Wt. 0.9 lb **11⁹⁹**



Adjustable Vehicle Cargo / Pet Divider

Non-skid rubber feet
 8063646 - Wt. 7.1 lb **49⁹⁹**



6 ft x 5 ft Adjustable Spider Truck Bed Cargo Net

• Ideal for larger light loads that could otherwise get tossed from truck bed
 • 12 pc nylon hooks with latch prevent release of adjustable cords
 8291999 - Wt. 2.1 lb **19⁹⁹**



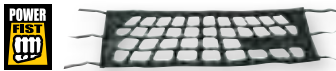

Full-Size Truck Tailgate Net
8064255 – Wt. 1.3 lb **24⁹⁹**



8 ft x 6 ft HD Mesh Truck Bed Net

- Great for hauling loads that need to be kept contained but not weather proofed
 - Helps maintain gas mileage by keeping air from getting trapped
- 8330144 – Wt. 2.8 lb **29⁹⁹**



L x W	Hook Qty	Wt. (lb)	ITEM	PRICE
5 ft x 4 ft	18	4.6	8286676	17.99
7 ft x 5 ft	24	6.4	8286726	29.99



E-Tracking Components

- E-Tracks are slotted fixtures (tracks) allowing for varied or adjustable anchor points to accommodate a range of contents
- E-Tracking can be used on open or enclosed trailers either on the floor or walls
- Once installed, use E-Track straps with E-Track fittings or install E-Track tie-off rings

6,000 lb E-Tracks

2 ft Horizontal

8247694

Wt. 2.9 lb **9⁹⁹**

5 ft Horizontal

8247686

Wt. 7.2 lb **18⁹⁹**

4 ft Vertical

8247678

Wt. 4.3 lb **13⁹⁹**

8 ft Horizontal

8347965

Wt. 15.7 lb **32⁹⁹**



E-Track Fittings

	Description	Cap. (lb)	Wt. (lb)	ITEM	PRICE
D	Tie-Off Ring	1,330	0.3	8247728	4.99
E	Wood Beam Socket	-	0.9	8247710	4.99
F	2" x 8" Tie-Off Strap	1,160	0.4	8247660	4.99
G	2" x 16 ft Ratchet Strap	1,160	2.9	8247645	17.99
H	Adjustable Tire Strap	1,160	4.9	8247744	39.99



30 ft Cargo Winch Straps

- Resin-coated polyester for minimum stretch and maximum wear resistance
- Edge guard designed to prevent tears or cuts

A) With Flat Hook

Width	Working Load	Breaking Strength		Wt. (lb)	ITEM	PRICE
		Webbing	Assembly			
2"	3,335 lb	12,000 lb	10,000 lb	2.8	8282501	19.99
3"	5,400 lb	18,000 lb	16,200 lb	4.3	8282519	21.99
4"	5,400 lb	20,000 lb	16,200 lb	4.9	8282527	24.99

B) With Chain Anchor

Width	Working Load	Breaking Strength		Wt. (lb)	ITEM	PRICE
		Webbing	Assembly			
3"	5,400 lb	18,000 lb	16,200 lb	6.5	8282535	29.99
4"	5,400 lb	20,000 lb	16,200 lb	7.1	8282543	32.99

C) Gr 70 Transport Chain with Grab Hooks

Chain and chain accessories are not to be used for lifting or towing

Width	Length	Safe Working Load	Breaking Strength	Wt. (lb)	ITEM	PRICE
5/16"	16 ft	4,700 lb	18,800 lb	17.2	8259483	49.99
5/16"	20 ft	4,700 lb	18,800 lb	20.0	8259509	59.99
3/8"	16 ft	6,600 lb	26,400 lb	24.1	8259525	69.99
3/8"	20 ft	6,600 lb	26,400 lb	29.3	8259533	79.99

Combination Cargo Winch Bar

- Knurled non-slip handle with tapered, carbon steel nose piece for strength and ease of operation
- Modified handle can also be used to release lever chain binders

8282436 – Wt. 6.6 lb **24⁹⁹**

Lashing Cargo Winch

- Safe working load: 3,335 lb
- Breaking strength: 10,000 lb
- Use with up to 2" winch strap
- Weld or bolt in place similar to a standard winch
- Offers quick release and ease of operation of a ratchet buckle

8282493 – Wt. 3.7 lb **14⁹⁹**

Heavy Duty Cargo Winches

- Safe working load: 5,500 lb
- Breaking strength: 16,500 lb
- Use with 2", 3" or 4" winch straps
- E-coated to adapt to Canadian environment

I) Low Profile Side Mount Weld-On

8282477 – Wt. 7.8 lb **24⁹⁹**

J) Standard Bottom Mount Weld-On

8282485 – Wt. 8.3 lb **24⁹⁹**

K) Standard Sliding

- Moves easily in both directions for positioning in the track
- Locks firmly in place when tension is applied to webbing

8282568 – Wt. 9.1 lb **29⁹⁹**



Looking for the perfect gift?
GIFT CARDS
are available at any Princess Auto location



No sale is final until you're satisfied!
We guarantee to make it right. We will repair, replace or refund any product to your satisfaction.

Tie Downs

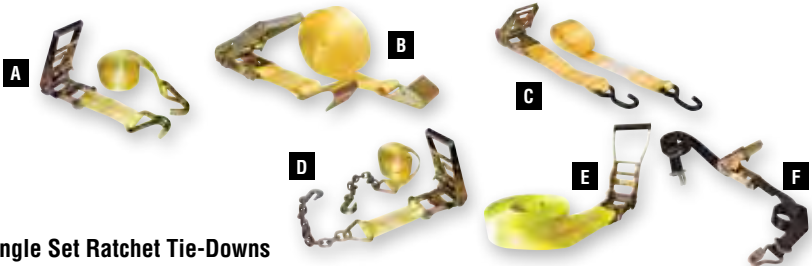

Single Set Ratchet Tie-Downs

	End	Width	Length	Safe Working Load	Breaking Strength	Wt. (lb)	ITEM	PRICE
A	Double J-hook	1"	15 ft	1,000 lb	3,000 lb	1.5	8236929	14.99
	Double J-hook §	1-1/2"	15 ft	1,330 lb	4,000 lb	2.0	8237042	17.99
	Double J-hook	2"	15 ft	1,665 lb	5,000 lb	3.1	8204232	24.99
	Double J-hook	2"	25 ft	1,665 lb	5,000 lb	4.3	8021473	27.99
	Double J-hook	2"	27 ft	3,300 lb	10,000 lb	4.8	8184889	29.99
	Double J-hook	3"	30 ft	5,000 lb	15,000 lb	14.0	8276057	59.99
B	Flat hook	2"	27 ft	3,300 lb	10,000 lb	6.2	8021534	29.99
	Flat hook	2"	40 ft	3,300 lb	10,000 lb	6.3	8348021	39.99
	Flat hook	3"	30 ft	5,000 lb	15,000 lb	12.4	8276065	54.99
C	PVC J-hook ‡	1"	15 ft	166 lb	500 lb	0.9	8239261	7.99
	PVC J-hook §	1"	15 ft	400 lb	1,200 lb	1.0	8238099	9.99
	PVC J-hook	2"	15 ft	830 lb	2,500 lb	2.4	8239295	16.99
	PVC J-hook*	2"	27 ft	3,300 lb	10,000 lb	5.3	8278210	34.99
D	Gr 70 chain w/hook*	2"	27 ft	3,300 lb	10,000 lb	8.6	8348039	49.99
E	Lashing	2"	25 ft	3,300 lb	10,000 lb	3.5	8281917	17.99
F	Double J-hook w/D-rings	1"	15 ft	1,000 lb	3,000 lb	1.5	8252561	14.99

* Camo ‡ Red § Black

1" Utility Straps



	Type	Length	Safe Working Load	Breaking Strength	Wt. (lb)	ITEM	PRICE
G	Loop-end	6 ft	-	-	0.1	8251977	1.99
H	Cambuckle	13 ft	100 lb	300 lb	0.2	8251985	4.99
I	Ratchet	15 ft	165 lb	500 lb	0.6	8251993	6.99

2 pc 2" Tie-Downs

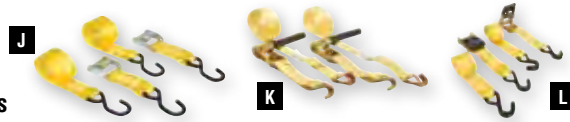

	Type	Length	Safe Working Load	Breaking Strength	Ends	Wt. (lb)	ITEM	PRICE
J	Cambuckle	8 ft	730 lb	2,200 lb	PVC J-Hook	3.6	8348005	19.99
K*	Ratchet	27 ft	3,300 lb	10,000 lb	Double J-hook	10.5	8249047	59.99
L*	Ratchet	10 ft	1,330 lb	4,000 lb	PVC double J-hook	5.1	8252066	32.99

*Moulded rubber handle



2" x 15 ft Ratchet Tie-Down
8040081 – Wt. 2.4 lb **15⁹⁹**



2 pc 2" x 5 ft Quick-Release Tie-Downs
• Safe working load: 400 lb
• Breaking strength: 1,200 lb
3809712 – Wt. 1.8 lb **16⁹⁹**



2 pc 1" x 6 ft Ratchet Strap
• Safe working load: 400 lb
• Breaking strength: 1,200 lb
• PVC coated J-hook ends
• Safety latched for added security
8369415 – Wt. 2.2 lb..... **14⁹⁹**

2" PVC Handled Ratchet Buckles

Handle Size	Wt. (lb)	ITEM	PRICE
6-1/2"	2.0	8040487	9.99
7-3/4"	2.2	8040479	9.99
9"	2.3	8040453	9.99



Ratchet Strap Ends

	Type	Strap Size	Safe Working Load	Breaking Strength	Wt. (lb)	ITEM	PRICE
M	Buckle	1"	580 lb	1,750 lb	0.4	8040537	1.99
	Buckle	1-1/16"	1,000 lb	3,000 lb	0.8	8040529	3.49
	Buckle	2"	1,600 lb	5,000 lb	2.0	8021721	15.99
N	PVC J-Hook	1"	250 lb	750 lb	0.2	8021696	1.99
O	Double J-Hook	1"	1,000 lb	3,000 lb	0.2	8021767	2.99
	Double J-Hook	2"	1,600 lb	5,000 lb	0.4	8021730	3.99
P	Double J-Hook	4"	3,660 lb	11,000 lb	0.7	8040545	2.99
	Flat Hook End Strap	2" x 1-1/2 ft	3,300 lb	10,000 lb	0.9	8021810	7.99



1" 4 pc Tie-Downs

	Type	Length	Safe Working Load	Breaking Strength	Wt. (lb)	ITEM	PRICE
A	Cambuckle	5-1/2 ft	300 lb	900 lb	2.9	8020492	16.99
B	Ratchet	6 ft	666 lb	2,000 lb	5.0	8087595	29.99
C	Ratchet	10 ft	300 lb	900 lb	3.9	8204240	19.99
D	Ratchet *	10 ft	400 lb	1,200 lb	3.6	8214488	24.99
E	Ratchet ‡	10 ft	300 lb	900 lb	3.8	8236937	24.99
F	TCS Buckle §	6 ft	666 lb	2,000 lb	3.7	8237059	24.99

* Moulded Handle ‡ Camo § Hunter Orange

Pro Series Retractable Ratchet Tie-Downs

- PVC coated J-hook ends
- Excess webbing retracts into centre housing

Dim.	Qty/Set	Safe Working Load	Breaking Strength	Wt. (lb)	ITEM	PRICE
1" x 6 ft	2 pc	500 lb	1,500 lb	3.2	8241945	24.99
1" x 6 ft	4 pc	500 lb	1,500 lb	6.0	8301723	49.99
1" x 10 ft	1 pc	500 lb	1,500 lb	1.7	8292625	14.99
2" x 10 ft	2 pc	1,100 lb	3,300 lb	7.3	8390478	49.99

Recovery Straps

Nylon webbing with reinforced holds to reduce wear and abrasion

Width	Length	Max. Vehicle Weight	Breaking Strength	Wt. (lb)	ITEM	PRICE
1"	15 ft	3,750 lb	7,500 lb	1.1	8020946	19.99
2"	20 ft	9,000 lb	18,000 lb	2.5	8020973	34.99
2"	30 ft	9,000 lb	18,000 lb	3.5	8021847	49.99
3"	20 ft	13,500 lb	27,000 lb	3.9	8021026	54.99
3"	30 ft	13,500 lb	27,000 lb	5.4	8021865	69.99
4"	30 ft	17,500 lb	35,000 lb	8.2	8021874	89.99
6"	30 ft	27,500 lb	55,000 lb	14.3	8021892	124.99



3" x 25 ft Recovery Strap with Chain Leads

- Max. vehicle weight: 9,000 lb
- Breaking strength: 18,000 lb
- Gr 70 chain with 5/16" grab hooks

8020982 – Wt. 11.6 lb **84⁹⁹**



6" Tie-Down Storage Rack

- Convenient storage for tie-down straps
- Mount to garage / basement wall or inside truck box or trailer

8282881 – Wt. 1.0 lb **9⁹⁹**



4 pc Combo Tie-Downs

- 2 pc 1" x 10 ft ratchet tie-downs
Safe working load: 400 lb / Breaking strength: 1,200 lb
- 2 pc 1" x 6 ft cambuckle tie-downs
Safe working load: 300 lb / Breaking strength: 900 lb
- PVC coated J-hook ends

8252082 – Wt. 3.3 lb **18⁹⁹**



Tie-Down Rope

1/4" x 8 ft 150 lb
8257123 – Wt. 0.4 lb **19⁹⁹**

3/8" x 10 ft 275 lb
8257016 – Wt. 1.0 lb **24⁹⁹**

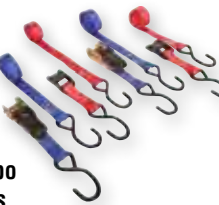

2" x 27 ft Tamer® Self-Storing Ratchet Tie-Downs

- Safe working load: 3,300 lb
- Breaking strength: 10,000 lb
- Built-in storage reel for excess webbing

	Ends	Wt. (lb)	ITEM	PRICE
G	Double-J	6.2	8252033	29.99
H	Flat	7.2	8252041	29.99



2 pc 1" x 8 ft 'Web Clamp' Ratchet Tie-Downs

- Safe working load: 500 lb
- Breaking strength: 1,500 lb
- Secure excess webbing with spring loaded clamp
- PVC coated J-hook ends

8328908 – Wt. 2.3 lb **19⁹⁹**

2 pc 1" x 9 ft Pro Series Retractable Truck Rack Tie-Downs

- Safe working load: 400 lb
- Breaking strength: 1,200 lb
- PVC coated J-hook ends
- Excess webbing retracts into centre housing
- Bolt-on design for permanent mounting on trailers and truck racks

8362857 – Wt. 3.5 lb **24⁹⁹**

5/16" x 14 ft Gr 43 Utility Chain with Grab Hooks

8346785 – Wt. 12.9 lb **34⁹⁹**

2" x 7 ft Vehicle Ratchet Tie-Downs

Application	Safe Working Load	Breaking Strength	End	Wt. (lb)	ITEM	PRICE
Car	1,665 lb	5,000 lb	Flat grab	2.9	8020679	24.99
Machinery	3,300 lb	10,000 lb	Twisted flat snap	3.8	8252058	34.99



PowerFist Erickson



Adjustable Tire Strap Assemblies

Type	Safe Working Load	Breaking Strength	Ends	Ends	Wt. (lb)	ITEM	PRICE
A Cam buckle	3,300 lb	10,000 lb	Double J-hook	-	2.8	8005423	29.99
B Ratcheting	3,300 lb	10,000 lb	Strap end/ double J-hook	Ratchet end/HD J-hook	4.8	8282048	39.99

Tow Ropes

Ratings are based on vehicle rolling weight and are not intended for marine use or lifting purposes



	Width	Length	Max. Vehicle Weight	Breaking Strength	Wt. (lb)	ITEM	PRICE
A	3/4" §	14 ft	3,000 lb	6,000 lb	1.8	8258212	12.99
	7/8" ‡	14 ft	4,250 lb	8,500 lb	2.8	8020429	15.99
B	5/8"	20 ft	1,750 lb	3,500 lb	1.7	1740703	9.99
	7/8"	20 ft	3,000 lb	6,000 lb	1.7	1740711	12.99

‡ Blue

§ Yellow



2" x 2 ft Axle Straps



Safe Working Load	Breaking Strength	Ring Type	Wt. (lb)	ITEM	PRICE
1,650 lb	5,000 lb	Welded wire	0.4	8020704	6.99
3,300 lb	10,000 lb	Flat stamped	0.8	8020697	8.99

2" Tow Straps

	Length	Max. Vehicle Weight	Breaking Strength	Wt. (lb)	ITEM	PRICE
C	15 ft	2,500 lb	5,000 lb	1.5	8258220	17.99
D	15 ft ‡	4,250 lb	8,500 lb	2.2	8258238	19.99
E	20 ft	3,300 lb	10,000 lb	3.1	1740001	24.99

‡ Blue

pro.point

hard.working.tools.



EXCLUSIVELY AT: **PRINCESS AUTO**

Shop & Garage	101 - 130
Battery Chargers & Testers	110 - 111
Carts & Dollies	109
Creepers & Roller Seats	107 - 108
Electrical Cords & Components	112 - 114
Jacks	102 - 104
Knee Pads & Safety	119 - 123
Lifting Equipment	104 - 107
Oil & Lubricants	124 - 125
Paint & Chemicals	126 - 128
Parts Washers	123
Shop Clean-Up	129
Shop Presses	116 - 117
Steel & Aluminum	130
Tool Storage & Benches	118 - 119
Air Compressors & Tools	131 - 149
Blow Guns & Inflators	148
Air Compressors & Accessories	131 - 136
Air Hose & Reels	137 - 138
Air Tools & Accessories	142 - 147
Painting	141
Sandblasting	138 - 140
Power Tools	150 - 165
Chainsaw Sharpening & Accessories	158

Cutting & Grinding Tools & Accessories	150 - 152
Die Grinders & Accessories	161
Heat Guns	161
Metal Working	164 - 165
Power Drills & Accessories	153 - 157
Sanding & Polishing	162 - 163
Saws & Blades	159 - 160

Welding	166 - 176
Butane & Propane Torches	178
Soldering	177
Welders & Accessories	167 - 176
Welding Safety	175 - 176

Hand Tools	179 - 241
Automotive Diagnostic & Repair Tools	226 - 240
Clamping & Pliers	201 - 205
Cutting Tools	193 - 201
Driving Tools	179 - 189
Electrical Tools	219 - 220
Levels & Measuring Tools	205 - 208
Plumbing Tools	221 - 223
Striking Tools	192 - 193
Tool Boxes & Organization	216 - 219
Wrenches	189 - 192



PRINCESS AUTO

Makita[®]

makita.ca

When SERVICE Counts - Choose Makita

Shop & Garage

Bottle Jacks



pro.point

Double Ram Bottle Jack

- 2 stage cylinder bottle jack
- Double seals in the pump to prevent oil leaks
- Powerful construction due to cylinder base tank be welded together
- Safety valve prevents ram from over extension
- Arc surface bottom of the steel base to make load center of piston
- Electro nickel plating (ENP) prevents rust and makes a smooth and bright piston



5 Ton

Lift range: 8.9 to 19.7"

8382467 – Wt. 17.2 lb **69⁹⁹**

10 Ton

Lift range: 8.3 to 20.5"

8382475 – Wt. 24.2 lb **89⁹⁹**



Horizontal / Vertical Bottle Jacks

Can operate in any position: vertical, angle, or horizontal



Capacity (tons)	Retracted Height	Lift	Screw Extension	Extended Height	Wt. (lb)	ITEM	PRICE
12	9-1/2"	6"	3-1/2"	19"	15.8	8158297	59.99
12 Low	7"	3-3/4"	2-3/4"	13-1/2"	14.0	8158313	59.99
20	10-3/4"	6-1/2"	2-3/8"	17-1/4"	25.4	8158321	74.99
20 Low	8-1/4"	4"	3"	15-1/4"	22.3	8158339	74.99



Bottle Jacks

- Automatic oil bypass prevents overextension of ram
- Handle included



Capacity (tons)	Retracted Height	Lift	Screw Extension	Extended Height	Wt. (lb)	ITEM	PRICE
2	6-3/4"	4-1/2"	1-3/4"	13"	5.7	1010004	14.99
4	7-3/4"	5"	2-1/4"	15"	8.5	1010005	19.99
6	8-1/2"	5-1/4"	3-1/4"	17"	10.9	1010006	24.99
8	8-3/4"	5-1/2"	3"	17-1/4"	13.5	1010007	29.99
12	9-1/4"	5-1/4"	3"	17-1/2"	15.7	1010008	39.99
12 Low	7-1/2"	3-1/2"	3"	14"	16.2	1010010	39.99
20	10-1/2"	5-1/2"	2-1/2"	18-1/2"	25.5	1010009	64.99
20 Low	8"	2-3/4"	2-1/2"	13-1/4"	22.8	1010011	64.99
3 Longstroke	24-1/2"	19-1/2"	–	44"	23.0	1010019	79.99
5 Longstroke	24-1/2"	19-1/2"	–	44"	27.8	8035896	89.99
8 Longstroke*	24"	19"	–	43"	35.6	8186264	99.99
8 Long Ram	24-3/4"	–	–	42"	35.6	8338048	129.99

* Clevis Bottom

Air Operated Bottle Jacks

- For use with an air compressor or as a manual jack
- Operating pressure: 90 to 120 PSI



Capacity (tons)	Retracted Height	Lift	Screw Extension	Extended Height	Wt. (lb)	ITEM	PRICE
12	10-1/2"	6-3/4"	3"	20-1/4"	27.1	8003605	129.99
20	10-1/4"	6-1/2"	3-1/4"	20"	37.0	8003606	149.99

Floor Jacks



A) 1-1/2 Ton Aluminum Floor Jack

- Lifting range: 3-1/2" to 14-3/4"
- Speed lift reaches full service height in 8 to 9 strokes
- Lightweight allows for quick and easy handling

8074668 – Wt. 27.5 lb **199⁹⁹**

B) 2-1/2 Ton Aluminum / Steel Floor Jack

- Lift range: 4" to 19"
- Speed lift reaches full service height in 10 strokes under load (3 strokes with no load)
- Light weight allows for quick and easy handling

8003252 – Wt. 58.7 lb **229⁹⁹**

C) 3 Ton All Steel Floor Jack

- Lift: min. 5", max. 19-1/2"
 - Lifts to 11-1/2" on first stroke (no load)
- 1030052 – Wt. 82.7 lb **179⁹⁹**

D) 3-1/2 Ton Shop Duty Floor Jack

- Lifting range: 4" to 21"
- Speed lift reaches full service height in 8 to 9 strokes
- Steel construction

8002093 – Wt. 101.4 lb **199⁹⁹**

E) 2-1/4 Ton Extended Floor Jack

- Lift range: 5-1/2" min., 31-1/2" max.
- O'all size: 47" long, 17" wide

8274243 – Wt. 138.9 lb **299⁹⁹**

F) 3 Ton Low Profile Floor Jack

- Lifting range: 4" to 19"
- Speed lift reaches full service height in 8 to 9 strokes
- Lightweight, all aluminum design
- Dual pump design for quick and easy lifting

8160996 – Wt. 58.5 lb **299⁹⁹**

FLOOR JACKS

Do not use floor jacks to position vehicles or as a jack stand. Use only on firm, level surfaces.



2 Ton Trolley Jack
Lift range: 5-1/4" to 13"
8036709 – Wt. 19.5 lb **34⁹⁹**

2 pc Heavy Duty RV Scissor Jacks
• 5,000 lb capacity per jack Lift range: 4" to 24"
• Includes socket handle for easy operation
• Top bracket can be mounted to RV
8180580 – Wt. 31.8 lb **99⁹⁹**

2 Ton Scissor Jack
Lift range: 4" to 13-1/2"
8047598 – Wt. 7.0 lb **29⁹⁹**



1.5 Ton Aluminum Jack
• Lift range: 4.9" to 13.4"
• Aircraft grade lightweight jack
• Heat treated aluminum
• Built-in safety overload system that prevents use beyond capacity
• Rear swivel casters
• Rubber padded saddle protects vehicle frame
8392128 – Wt. 20.3 lb **129⁹⁹**



Floor Jack Saddle
• Rubber pad prevents damage on vehicles requiring side lift
• Use on 2-1/4 to 3-1/2 ton service jacks
1090014 – Wt. 3.1 lb **12⁹⁹**



2 Ton Low Profile Garage Jack
• Lift range: 3" to 20"
• Built-in safety valve
• Low profile to get under low riding vehicles
• Foot pedal for faster lifting
• Rubber saddle pad protects vehicle from damage
• Large magnetic tool tray
• Slow lowering feature for better control & safer operation
8382293 – Wt. 103.5 lb **349⁹⁹**



Jack Stands
Sold in pairs

Capacity (tons)	Height (min, max)	Wt. (lb)	ITEM	PRICE
2	10.3", 16.3"	11.7	8369464	24.99
3	11-5/8", 16-3/4"	19.1	8369472	34.99
6	15-3/4", 23-7/8"	29.4	8369506	59.99
12	18-1/8", 28"	64.8	8382442	99.99



1/2 Ton 2 Stage Transmission Jack
• Lift range: 36" to 75"
• Saddle tilt front and back 53° by 30°
• Saddle tilt left and right +10° and -30°
• Safety chain
• 3" swivel casters easy maneuverability
• Base 21.25" x 35"
• Foot pedal for easier lifting
• Slow release feature and wide base for stability
• First stage 55.9"
• Second stage 74.8"
8382806 – Wt. 145.2 lb **499⁹⁹**



5 Ton Jack Support
• Lift range: 9-3/8 to 13-3/8"
• Base 4-3/4" x 4-3/4"
• Lifts with a mechanical gear so each height is positively locked and supported
• Jack also functions as a jack stand for load support
8382459 – Wt. 10.1 lb **49⁹⁹**



A) 22 Ton Air / Hydraulic Jack

• Lift range: 9.1" to 16.9"
• 4 individual saddles for versatility in lifting applications
• 8" wheels for portability
8319931 – Wt. 94.4 lb **329⁹⁹**



B) 2 or 3 Ton Hybrid Jack

• 2 ton normal lifting range: 3.8" to 23"
• 3 ton folded arm lifting range: 11.5" to 23"
8320020 – Wt. 93.8 lb **349⁹⁹**



Hydraulic Jack Oil
• Specially formulated with rust inhibitors, anti-wear agents, and anti-foam agents
• 946 ml bottle
6420077 – Wt. 2.1 lb **7⁹⁹**
SORRY, OIL CANNOT BE SHIPPED

Farm Jacks

Farm Jacks

- Lift, hoist, pull, or push up to 4,660 lb rated capacity
- Multi-purpose jack for off-road, winching, pulling / clamping and agricultural applications
- Lift range: 4.5" to 48.25"
- Top winch connector allowing attachment of accessories
- Durable powder-coated finish
- Test load: 7,000 lb
- 5,000 lb winching capacity

36" Cast & Steel Jack
C) 8000713 – Wt. 25.4 lb **89⁹⁹**

48" Hi-Lift Farm Jack
C) 8000714 – Wt. 27.7 lb **99⁹⁹**

60" Hi-Lift Jack
2 pc handle and socket for extra durability
C) 8000715 – Wt. 30.1 lb **109⁹⁹**

X-Treme Jack

- 48" heavy duty multi-purpose jack
 - All cast construction
 - 4,660 lb rated load capacity
 - 5,000 lb winching and clamping capacity
 - Load tested to 7,000 lb at which point safety bolt will shear
 - Winch-Clamp-Spreader bracket has 7/8" shackle holes and 3/8" chain slot
 - Attaches at any point on the jack I-Beam
 - All hardware and winch-clamp-spreader bracket are zinc coated for rust resistance
 - Charcoal metallic powder-coat finish
- D) 8128167 – Wt. 31.6 lb **149⁹⁹**

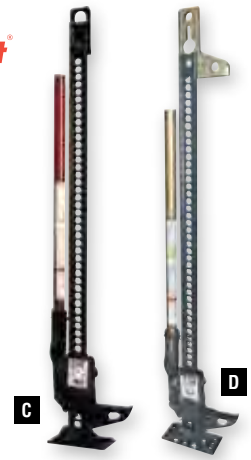



2 Ton Farm Jacks

- Handle length: 30" Base size: 4-3/8" x 7"
- Lifting saddle: 1-1/2" x 4"

36" **1050036** – Wt. 30.4 lb **69⁹⁹**

48" **1050034** – Wt. 32.9 lb **79⁹⁹**

Farm Jack Maintenance Kit
8007177 – Wt. 1.0 lb **9⁹⁹**



Base

Alleviates jack sinkage on soft surfaces

8287096 – Wt. 3.8 lb **49⁹⁹**



Loc-Rac® Mounting System

Conveniently mounts and locks your Hi-Lift jack

8287054 – Wt. 1.6 lb **34⁹⁹**



Jack Cover

Neoprene jack cover offers a level of mud and dirt protection for the main lifting mechanism of the Hi-Lift jack while stored

8287104 – Wt. 0.2 lb **34⁹⁹**



Handle Keeper

Designed to slip over the Hi-Lift handle and the I-beam to keep them both parallel and secured together when not in use

8287039 – Wt. 0.5 lb **19⁹⁹**



Transmission Jacks



800 lb Adjustable Transmission Jack

- Lift range: 8" to 23"
- Universal saddle, brackets and chain are fully adjustable
- Four 2" swivel casters allow easy positioning
- Pump handle rotates 360°
- Ideal for installation and removal of automotive and light truck transmissions and differentials

8141764 – Wt. 83.6 lb **199⁹⁹**

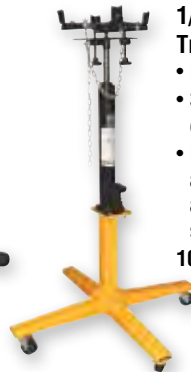

1/2 Ton Single Stage Transmission Jack

- Lift range: 50" to 66"
- 38" wide base with 3" steel swivel casters for stability
- Universal saddle tilts for ease of alignment and includes adjustable brackets and safety chain

1030042 – Wt. 88.0 lb **219⁹⁹**

Engine Leveller

- Max. cap.: 1,500 lb
- For use between overhead lifting equipment and an unevenly weighted load like an auto engine with transmission intact
- Balance point adjusts 12" side to side

1580009 – Wt. 12.9 lb **49⁹⁹**



1,100 lb Engine Support Bar

- Centre bolt adjustment: 14"
- Width adjusts from 40" to 63"
- Use on FWD vehicles to support powertrain when front sub-frame is removed
- Allows for unobstructed access to FWD components, transmission, and bottom of engine

1090009 – Wt. 32.8 lb **99⁹⁹**



Shop Cranes & Engine Stands



Shop Cranes

A) 2 Ton Low Profile Shop Crane

- Lifting range: 8" to 47"
- Quick lift ram, handle for easy movement and retracting legs for easy storage
- Low profile base ideal for compact cars, small trucks or lower vehicles

8002097 – Wt. 231.5 lb **349⁹⁹**

B) 2 Ton Quick Lift Shop Crane

- 4 position boom extends from 37-1/2" to 56"
- Max. boom height: 1/2 ton - 93", 1 ton - 89", 1-1/2 ton - 85", 2 ton - 81-1/4"
- Ram reaches full extension with only 30 pumps
- Includes 8 ton quick lift ram with handle
- Folding legs for easy storage

8210072 – Wt. 202.8 lb **319⁹⁹**

Reinforced 5/16" wall



Engine Stands

- Simplifies engine overhauls, holds engine at a convenient height
- Head swivels 360° for easy access to any part of the engine

	Model	Cap. (lb)	Base	Height	Wt. (lb)	ITEM	PRICE
C	4 Wheel H-Style	1,000	34" x 30"	36"	49.8	4270666	79.99
D	4 Wheel U-Style	1,250	34" x 33"	35"	72.6	4279964	99.99
E	5 Wheel U-Style Folding	2,000	35" x 34"	35"	101.5	4270198	149.99



1,000 lb Engine Dolly

- For storing, transporting and engine maintenance
- Universal design works with most automotive engines
- 4 swivel casters for ease of mobility
- O'all dim.: 39" x 4.7" x 4.7"

8127821 – Wt. 26.5 lb **59⁹⁹**

Small Block 1,000 lb Cap. Chevy Engine Cradle

- Bolts to motor mount and bell housing holes
- All steel construction
- 4 swivel casters

8165722 – Wt. 20.2 lb **59⁹⁹**



1,500 lb Vehicle Dolly

- Working range: 13.4" to 24.4"
- Fit tires up to 11" width
- Simple and efficient method of moving a vehicle around the shop or home
- Foot pedal moves the vehicle tire between the rollers until the tire lifts off the floor

8382772 – Wt. 40.1 lb **129⁹⁹**



WONDERING HOW MUCH EFFORT IT WILL TAKE TO LIFT A LOAD?

Divide the weight of the load by the number of pulleys in your hoist. For example: To lift a 1,000 lb load using a hoist containing 7 pulleys, you would have to exert enough effort to move 142.9 lb.

Lifting Equipment



Not to be used for pulling

Triple Geared Chain Hoists

- Ideal for shop, garage, farm, and home use
- Compact
- Swivel hooks with safety latch
- 8 ft lift

Cap.	Wt. (lb)	ITEM	PRICE
1/2 ton	22.1	1580091	69.99
1 ton	22.0	1580240	79.99
2 ton	30.4	1580216	119.99



Lever Chain Hoists

- 180° chain guide
- Safety brake
- Swivel hooks and safety latch
- Freewheel to position chain
- Steel handle rotates 360°
- Raise or lower load by ratchet action of the handle

Ton	Max. lift	Min. dist. between hooks	Wt. (lb)	ITEM	PRICE
A 1/4	5 ft	10"	4.7	8051699	79.99
A 3/4	5 ft	12"	18.1	1580016	119.99
B 1	10 ft	10"	17.9	8143901	129.99
A 1-1/2	5 ft	26"	28.9	1580017	149.99
B 2	10 ft	26"	29.4	8143919	159.99



Rope Hoist

- 1,000 lb capacity
- 10 ft lift
- Poly rope included
- Nylon rollers

Wt. 1.8 lb
1550005 **12⁹⁹**

Trolleys

- Ideal for shop, garage, farm and home use
- Adjustable to fit various widths of I-beams



Capacity	Beam Widths	Wt. (lb)	ITEM	PRICE
1/2 ton	2-1/2" / 6"	15.8	8203648	79.99
1 ton	2-1/2" / 8"	27.3	8203655	119.99
2 ton	3-1/2" / 8"	43.1	8203663	149.99

1 Ton Lifting Clamp

- For lifting sheet steel
- 3/4" gap opening

2910217 – Wt. 8.4 lb **59⁹⁹**

2 Ton Lifting Clamp

- 1" gap opening

2910218 – Wt. 15.0 lb **79⁹⁹**

1" x 8 ft Lift Sling

- 2,100 lb cap. (vertical hitch)
- 1,680 lb cap. (choker hitch)
- 4,200 lb cap. (basket hitch)

Erickson
8021561 – Wt. 0.7 lb **19⁹⁹**

Powerfast
8166134 – Wt. 0.3 lb **9⁹⁹**



1 Ton Drum Lift

- For use with overhead hoist or crane
- Provides quick loading and unloading of steel drums

8270753 – Wt. 7.6 lb **49⁹⁹**

Adjustable Chain Sling

- For lifting motors from cars, trucks, tractors and boats
- Cap.: 2,350 lb

Adjustable long and short legs to hold a motor at proper angle for installation or removal
1580133 – Wt. 2.7 lb **14⁹⁹**

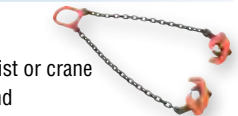

2 Ton Beam Clamp

- Clamped jaws reduce beam stress by applying the load inside the flanged edge
- Fits beam widths: 3" to 8-5/8"

8006070 – Wt. 11.0 lb **69⁹⁹**



2" x 6 ft Lift Sling

- Safe working load: 532 lb
- Breaking strength: 1,580 lb

8040248 – Wt. 0.4 lb **7⁹⁹**



Cable Hoists

- Perfect for engine repair or loading and unloading heavy items from trucks and trailers
- Power up and down
- Includes: 5 ft 5" remote
- 110 VAC
- Includes: pulley block to increase capacity



Hoist (lb)	Cable Length	Lifting Wt. (lb)		Lifting speed (FPM)		Lifting height (ft)		Wt. (lb)	ITEM	PRICE
		Single Line	Double Line	Single Line	Double Line	Single Line	Double Line			
440	40 ft	220	440	33	16.5	38	18	24.5	8041840	129.99
880	40 ft	440	880	33	16.5	38	18	37.6	8041857	199.99
1,320	40 ft	660	1,320	33	16.5	38	18	40.5	8107674	229.99

Lifts & Accessories

VEHICLE HOISTS

These hoists are intended for home use only. They are not designed for commercial applications.

Special order, please allow 7-8 weeks for delivery.



4-Post Vehicle Lift (D-7)

- Perfect for home garage or shop
 - Allows you to park more than 1 vehicle in a parking spot
 - Spring loaded safety locks on each column
 - 110VAC electric/hydraulic power system and detachable drive up ramps
 - Lifting capacity: 7,000 lb
 - Max. lifting height: 75"
 - Width between columns: 92-1/2"
 - D7X kit includes 4 casters, jack platform and set of 3 drip trays
- 8275620** – Wt. 1635.0 lb **2849⁹⁹**



Dannmar[®]
EQUIPMENT

www.dannmar.com

Dannmar Equipment is committed to engineering high-quality, innovative products, offering automotive equipment solutions at a remarkable value.

Above: Known for his work with Boyd Coddington on TV's American Hot Rod, Duane Mayer trusts Danmar equipment on all of his luxury vehicle builds.



is the National Canadian Retailer for Danmar.



2-Post Asymmetric Hydraulic Vehicle Hoist (D10-ACX)

- Wider version for wider vehicles providing more drive-thru clearance
 - Asymmetric design with posts that are rotated in 30° allows vehicle to be off-set back far enough to give you greater access when moving in and out of vehicle
 - 230VAC electric / hydraulic power pack
 - Lifting capacity: 10,000 lb
 - Max. lifting height (pad only): 73"
 - Width between columns: 112"
- 8318198** – Wt. 1650.0 lb **2849⁹⁹**



2-Post Low Ceiling Hydraulic Vehicle Lift (D9-2X)

- Extra-wide for larger vehicles; extended arm reach will cover most vehicle lifting points
 - Low column height accommodates low-ceiling installations while still providing up to 6 feet of under-car clearance
 - Dual hydraulic cylinders combined with "Chain Over" lifting system provides 2-to-1 lifting speed
 - 230VAC electric / hydraulic power pack
 - Lifting capacity: 9,000 lb
 - Max. lifting height (pad only): 76"
 - Width between columns: 118"
 - O'all width (outside of columns): 137"
- 8275638** – Wt. 1435.0 lb **2849⁹⁹**



2-Post Portable Hydraulic Vehicle Lift

- The MaxJax™ is designed for garages with 8 ft ceilings
 - Built-in wheels allows you to use the lift when you need it, then conveniently store it out of the way
 - Fully adjustable lifting arms with stackable adapters - increases overall arm positioning for lifting a variety of different vehicles
 - Lifting capacity: 6,000 lb
 - O'all height: 89"
 - Arm reach (min.): 24"
 - Arm reach (max.): 44"
 - Time of full rise: 30 sec.
 - Portable power pack motor: 110/220 VAC
 - Available in select locations
- 8275612** – Wt. 880.0 lb **2399⁹⁹**



1/2 Ton Gantry Crane

- Operating range: 94-1/2" to 141-3/4"
- Width between uprights is 94-1/2"
- Gantry crane is designed for transporting and positioning materials
- Gantry crane is NOT to be moved while loaded

8385957 – Wt. 220.0 lb **399⁹⁹**

1 Ton Gantry Crane

- Like having a portable I-beam: just add a trolley or hoist for level moving of heavy loads
- Operating height: 94.5" to 141.7"
- Width between uprights: 94.5"

8303091 – Wt. 323.4 lb **499⁹⁹**



pro.point

1,500 lb Heavy Duty ATV Lift

- Designed for easy lifting of ATVs, motorcycles, lawn tractors and dirt bikes
- Lift range: 5.1" to 16.9"
- Foot pedal for faster lifting
- 3" casters
- Rugged all-metal construction

8382723 – Wt. 73.7 lb **149⁹⁹**



1,000 lb Capacity Air / Hydraulic Motorcycle Lift

- Operates using compressed air or built-in manual hydraulic lift
- Air operating pressure: 120 to 200 PSI
- Lifting range: 7" to 29-1/2"
- Platform size: 86-1/2" x 26-3/4"
- Ramp size: 25-1/2" x 26-3/4"

8133860 – Wt. 365.2 lb **599⁹⁹**

Motorcycle Wheel Stands

- Facilitates tire changing, chain tightening and brake servicing
- Smooth rolling wheels and extended grab handle for extra leverage allows stand to be easily used by one person
- Ideal for motorcycle storage to prevent flat spots on tires

Wt. 6.5 lb

8321473 – Front

8321440 – Rear **69⁹⁹/ea**



Motorcycle Wheel Chock

- For front or rear tires from 14" to 21" wide
- Locking cradle securely supports your motorcycle in an upright position

8240145 – Wt. 22.4 lb **79⁹⁹**



Stands

A) 500 lb Capacity Motorcycle Wheel Cleaning Stand

- Aluminum ramp guides motorcycle onto rollers for cleaning wheels or lubing chains
- 6 non slip rubber feet and 2 rollers

8245409 – Wt. 4.4 lb **59⁹⁹**



B) 500 lb Capacity Portable Motorcycle Stand

- All aluminum construction weighs only 6-1/2 lb
- Hole in top for easy oil changes
- Designed for 500 cc and smaller motorcycles

8131773 – Wt. 6.2 lb **74⁹⁹**



1,500 lb Capacity ATV Lift

- Designed for easy lifting of motorcycles, ATVs, lawn tractors and dirt bikes
- Easy roll high load steel casters
- Six locking positions

8319956 – Wt. 73.3 lb **129⁹⁹**

1,100 lb Capacity Motorcycle / ATV Lift

- Lifts front, rear or entire motorcycle or ATV
- Can be used on the floor or with motorcycle lift table
- Rubber padded frame saddles adjust from 2" to 15" on centre
- Min. height without frame saddles: 3-1/2", max. height: 16"
- Min. height with frame saddles: 6", max. height: 18"

8133910 – Wt. 32.3 lb **99⁹⁹**



Creepers & Roller Seats



C

C) Low Profile Creeper

- 300 lb cap.
- Low profile design to allow more clearance under vehicles

8039008 – Wt. 13.4 lb **59⁹⁹**



D

D) Mechanics' Folding Creeper

- 300 lb capacity
- Use as a flat creeper or raised as a seat
- Frame supported by 7 casters
- O'all dim.: 48" x 18-1/2" x 4"

4270116 – Wt. 26.4 lb **69⁹⁹**



Creepers Replacement Caster

For 4270116
8003401 – Wt. 0.4 lb **5⁹⁹**



40" Adjustable Creeper

- 6 caster tubular steel frame with padded cushion
- 3-position headrest

4270209 – Wt. 17.9 lb **59⁹⁹**



1,500 lb ATV Lift
8319956

Hydraulic Rams



20 Ton
8382525
30 Ton
8382533

Turn to page 247 for full selection

Producing quality hydraulic products for over 30 years

available at:



40" Creeper
8320079



Creepers

A) 40" Creeper

- Adjustable headrest design
- 360° smooth running casters

8320079 – Wt. 12.3 lb **49⁹⁹**

B) 40" Foldaway Creeper

- Foldaway design for easy storage
- 360° smooth running casters

8320087 – Wt. 18.9 lb **59⁹⁹**



Anti-Fatigue Mat

48" x 24" x 1.5"
8374803 – Wt. 10.9 lb **49⁹⁹**

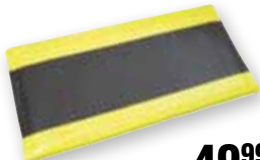

C) Creeper Seat

- Heavy duty, tubular steel design for maximum strength and minimum weight
- Convenient 11-1/2" X 12-1/2" tool tray

8320046 – Wt. 11.0 lb **34⁹⁹**

D) Adjustable Pneumatic Seat

- Max weight 220 lbs.
- Adjustable to 4.7"
- Tool tray for that extra storage

8319972 – Wt. 13.7 lb **49⁹⁹**



G

H

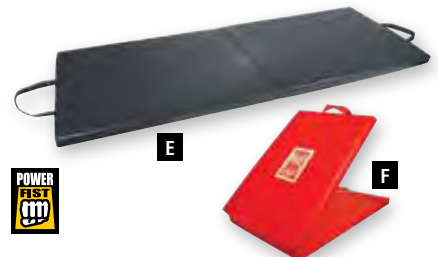

E

F

E) Padded Work Mat

- Durable vinyl cover resists stains and fluids
- Can be used on gravel, dirt or under low vehicles where a normal creeper cannot go
- Folds in half for storage, carrying loops on both ends
- Opens to 17-1/4" x 47-1/4"

8121899 – Wt. 2.2 lb **24⁹⁹**

F) Folding Work Mat

- Use on gravel, dirt or under low vehicles where a normal creeper cannot go
- Durable, industrial grade vinyl

8168817 – Wt. 2.5 lb **39⁹⁹**

G) Adjustable Roller Seat

- 300 lb cap.
- Min. height: 15"
- Max. height: 20"

4270215 – Wt. 14.4 lb

H) Pneumatic Roller Seat

- 350 lb capacity
- Divided base tool tray

8151557 – Wt. 13.3 lb **39⁹⁹** /ea

Carts & Dollies



Hand Carts

Style	Cap (lb)	Height	Toe Plate	Wheels	Wt. (lb)	ITEM	PRICE
A Flip Down Toe	440	50"	14" x 8"	10" x 2-3/4"	40.0	8095911	59.99
B Dual Handle	440	49"	17-1/4" x 10"	10" x 3.5"*	28.9	8095929	79.99
C Convertible	440	60"	8.1"	10" x 3-1/2"	35.9	8150229	89.99
D Stair Climbing	600	43"	20" x 8"	6"	33.9	8288037	99.99
E Appliance	550	60"	24-3/4" x 3-1/2"	8" x 2"	46.0	8095937	119.99
F Wide Load	600	52"	26" x 7-1/2"	10" x 3.50-4	36.5	8224719	129.99

* Pneumatic



130 lb Folding Hand Cart

- Steel powder coated frame
- Folds for compact storage
- Folded size: 28" x 15" x 2.2"
- Extended size: 37.4" x 15.2" x 14.8"
- Steel toe plate: 9.4" x 15.2"

39⁹⁹

Platform Dollies

O'all dim.: 30" x 18"

660 lb

8182347 - Wt. 9.9 lb **34⁹⁹**

1,000 lb

8182461 - Wt. 14.1 lb **39⁹⁹**



Folding

Aluminum Platform

- 300 lb capacity
- Use for washing RVs or SUVs, cleaning windows or home maintenance
- Lightweight aluminum space saving design, folds for easy storage
- 27"l x 11-3/4"w x 19-3/4" h

8201659 - Wt. 7.7 lb **49⁹⁹**



Plastic Moving Dolly

- Holds up to 1,000 lb
- Steel reinforced high impact polypropylene construction
- Rubber pads with diamond tread to prevent marring and slippage

8352155 - Wt. 16.8 lb **49⁹⁹**



2 pc Corner Dolly

- 250 lb capacity
- 10-1/2" x 10-1/2" x 3-1/2" high

8097032 - Wt. 9.2 lb **49⁹⁹**



2,000 lb Vehicle Dollies

- Ideal for moving disabled vehicles
- Max. cap.: 1,000 lb each

8129363 - Wt. 40.6 lb **89⁹⁹**



2-1/2 Ton Pallet Puller

4230078 - Wt. 17.2 lb **59⁹⁹**



G) Platform Carts

Rigid front casters, swivel rear casters

330 lb Capacity Fold-Up

Platform: 29" x 19"
8095945 - Wt. 21.9 lb **59⁹⁹**

660 lb Capacity Fold-Down

Platform: 35" x 24"
8095952 - Wt. 38.8 lb **99⁹⁹**



H) 660 lb Scissor Lift Cart

- Lift range: 11-1/4" to 35"
- Platform measures: 19-1/2" x 32"
- 5" Casters, rear locking swivel.
- Foot activated pump
- Handle folds flat for easier storage

8017549 - Wt. 186.0 lb **329⁹⁹**

I) 660 lb Capacity Table Lift

- Lift range: 13" to 48"
- Platform: 32.3" x 20.5"
- Foot actived pump

8143307 - Wt. 222.2 lb **399⁹⁹**



2-1/4 Ton Pallet Jack

- Max. fork height: 7-7/8"
- Fork length: 48"

8056228 - Wt. 177.8 lb **399⁹⁹**



Barrel Dollies

Cap (lb)	Barrel Volume	Barrel Dia.	Wt. (lb)	ITEM	PRICE
728	60 litres	16"	13.7	8182297	44.99
880	205 litres	24"	19.5	8143216	49.99





BATTERY CHARGERS

From the reliable 1.5 Amp Charger/Maintainer and multi-stage SpeedCharge products to the heavy-duty Wheel Chargers, we offer the broadest, most versatile series of battery chargers available.

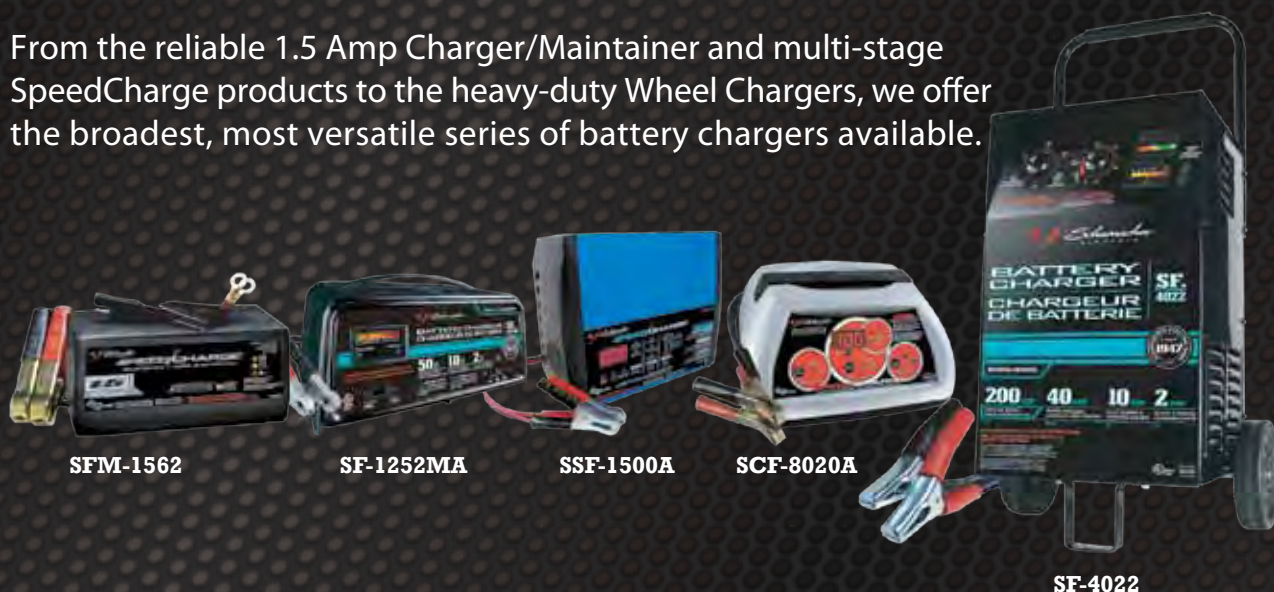

SFM-1562

SF-1252MA

SSF-1500A

SCF-8020A

SF-4022

POWER INVERTERS

From the convenient 140 watt pocket-sized travel inverter to the workhorse 2000 watt model, we offer the features and performance to meet nearly any demand.



PI-140

PID-410

PID-760

PIF-1000

PIF-2000

Schumacher. Quality Products Since 1947.

Find a Full Line of Quality Schumacher Products at www.princessauto.com

Battery Chargers & Testers



Visit princessauto.com for complete details

	Title	Style	Engine Start	Fast / Medium / Slow Charge	Feature	Wt (lb)	SKU	Price
A	2/10/40/200A Wheel-Style Manual Starter / Charger	Charger / Starter	200A/100A	40A/10A/2A	Voltmeter for battery testing	36.6	4270245	229.99
B	200/80/60/44/30A Wheel Style Starter / Charger	Charger / Starter	200A/180A	80-30A/-/-	6, 12, 18 & 24V	54.9	8133928	399.99
C	300/60/30A Wheel Style Manual Starter / Charger	Charger / Starter	300A/200A	30A/-/-	6 & 12V	50.6	4270077	399.99
D	1.5A Battery Companion® Charger / Maintainer	Charger / Maintainer	-	-/-/1.5A	6 & 12V	2.7	8206492	39.99
E	4/2A Charger / Maintainer	Charger / Maintainer	-	-/-/2A	6 & 12V	1.7	8303273	49.99
F	50/10/2A Fully Automatic 12V Starter / Charger	Charger / Starter	50A	10A/-/2A	12 ft total reach	10.6	4270252	79.99
G	12/8/2A Charger / Maintainer / Tester	Charger / Maintainer	-	12A/8A/2A	Deep cycle batteries	3.4	8303299	89.99
H	15/10/2A Charger / Maintainer / Tester	Charger / Maintainer	-	15A/10A/2A	Deep cycle batteries	3.7	8303364	99.99
I	10/6/2A Ship 'N Shore® Speedcharge® Electronic Battery Charger	Charger / Maintainer	-	10A/6A/2A	Designed especially for marine applications	3.5	8223802	89.99
J	Hybrid Charger / Maintainer / Starter /Tester	Charger / Maintainer	80A	20-10A/-/2A	Deep cycle batteries	12.2	8303307	139.99
K	200/30/10A Bench Style Manual Charger / Starter	Charger / Starter	200A	30A/10A/-	12 ft total reach	24.9	4270076	199.99



Automotive Power Alert

- Detects charging input voltage - within 1.0V variance
- Detects problems in advance of irregularities with the alternator
- Alerts you if your battery drops below 12V, giving you approximately 1 more hour of run time (depending on the system's wattage)
- Plugs into a 12V automotive receptacle (cigarette lighter)

8303315 – Wt. 0.2 lb **24⁹⁹**



I) Battery Tester

- Tests batteries, starters and charging systems
- Suitable for 6 or 12V systems

4230019 – Wt. 2.8 lb **49⁹⁹**

J) Digital Battery Tester

- Starter test feature and charging system tester
- Make a complete evaluation of any 12V battery in 30 seconds
- Performs present V test, puts 10 sec. load on battery, checks charge and tests charging circuit while engine is running

8104903 – Wt. 3.5 lb **69⁹⁹**



100A Battery Load Tester

- Tests load, battery condition, starter motor draw and complete charging system diagnosis
- 100A load test - for 6V batteries up to 1000 CCA
- 50A load test - for 12V batteries up to 1000 CCA

8016416 – Wt. 3.7 lb **89⁹⁹**

Booster Cables



Booster Cables

- Remains flexible to -70°C (-95°F)
- All copper wiring

400 &

500 AMP: Heavy duty sidekick clamp with extended jaw to easily grab side post terminals as well as top post

600 AMP: Parrot jaw clamps with heavy duty spring to ensure a tight grip on battery terminals

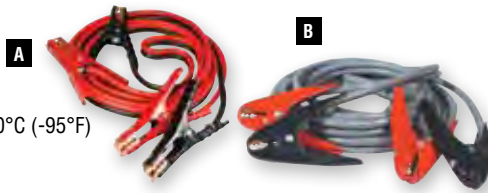

	Gauge	Length	Amps	Wt. (lb)	ITEM	PRICE
A	6	12 ft	400	4.6	8007071	39.99
	4	16 ft	500	7.3	8036873	79.99
B	2	20 ft	600	12.3	8036881	149.99
	1	25 ft	600	17.6	8040214	229.99

10A Replacement Clamps

	Amp	Colour	Wt. (lb)	ITEM	PRICE
E	10	Red & Black	0.1	8000756	0.99
F	500	Red	0.4	4272621	3.99
	500	Black	0.4	4272639	3.99



Extension Cords



Century

Powerfist

Woods

Power Pro™ Contractor Grade Extension Cords

- 3-wire cord features exclusive high gloss SJTW super flexible wire
- Extra heavy, clear moulded plug
- Stays flexible at low temperatures
- Full lifetime guarantee



Length	Wire	Plug	Type	Wt. (lb)	ITEM	PRICE
26 ft	14/3	Single	SJTW	2.4	0708438	34.99
23 ft	12/3	Single	SJTW	3.5	8257420	39.99
26 ft	14/3	Triple	SJTW	3.0	0708404	39.99
50 ft	14/3	Triple	SJTW	5.1	8257412	49.99
50 ft	12/3	Triple	SJTW	7.3	0708412	79.99
98 ft	12/3	Triple	SJTW	13.3	0708420	119.99

3 ft Extension Cord

- High gloss SJTW cord remains flexible in cold temperatures
- Triple plug inlet glows when cord has power
- Heavy duty, clear moulded plug and outlet

14/3 wire
8068819 – Wt. 0.9 lb **7⁹⁹**

12/3 wire
8068835 – Wt. 1.0 lb **10⁹⁹**



Battery Chargers

- Detects current battery charge level and automatically adjusts output
- Output of battery charger will decrease as charge level of battery increases
- Will not over charge battery or spark when clamps touch

C) 10A Battery Charger

2A/6.5A/10A charger, (2A slow, 6.5A fast, 10A peak)

8155525 – Wt. 8.8 lb **49⁹⁹**

D) 75A Charger / Booster

- 2A/6A/12A/75A charger/booster
- 2A trickle, 6A and 12A medium charge, 12V boost
- Charge status indicator lights

8091704 – Wt. 13.7 lb **99⁹⁹**



Ultra Power™ Booster Cables

16 ft / 6 gauge
8290660 – Wt. 4.9 lb **39⁹⁹**

Ultimate Power™ Booster Cables

20 ft / 4 ga
8290678 – Wt. 6.4 lb **59⁹⁹**

Industrial Cord Connector

- Water tight design with outlet gasket
- Clamshell design
- Tapered ends ensures it pulls smoothly without getting caught



8286494 – Wt. 0.2 lb **8⁹⁹**

Cord Lock

- Works with 16 and 14 gauge cords
- Durable plastic construction for heavy duty use
- Does not put a strain on the plug



8091944 – Wt. 0.1 lb **2⁹⁹**

WIRING & CABLE CODES/ABBREVIATIONS

S	J	O	T	P	E
Service	Junior	Oil Resistant	Thermoplastic/ Vinyl	Parallel	Elastomer

Code	Description	Volts	Temp.
S	Standard Service	600V	60°C
SJ	Service Junior	300V	60°C
ST	Extra Hard Usage	600V	60°C to 105°C
SJT	Hard Usage Thermoplastic	300V	60°C to 105°C
SJO	Service Junior Oil Resistant	300V	60°C, 75°C, 90°C
SJOO	Service Junior Oil Resistant	300V	60°C, 75°C, 90°C
STW	Extra Hard Usage	600V	60°C to 105°C
SJTW	Hard Usage	300V	60°C to 105°C

Electrical Cord Components

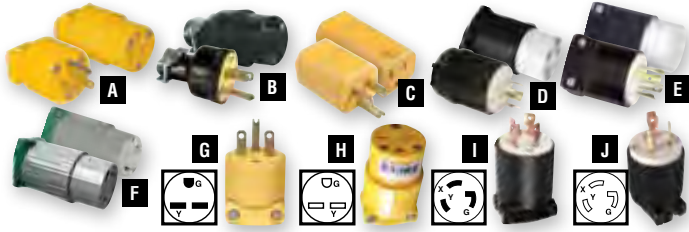

Plugs & Connectors

	Feature	Receptacle	Volts	Amps	Wt (lb)	ITEM	PRICE
A	Plastic	Male	125	15	0.1	0704353	3.29
	Plastic	Female	125	15	0.1	0704361	3.99
B	Rubber	Male	125	15	0.1	0700146	3.49
	Rubber	Female	125	15	0.2	0700138	3.99
C	Snap Open	Male	125	15	0.1	8019930	6.49
	Snap Open	Female	125	15	0.1	8020045	10.99
D	Twist Lock	Male	115/250	20	0.4	8213605	19.99
	Twist Lock	Female	115/250	20	0.2	8256489	24.99
E	Twist Lock	Male	115/250	30	0.4	8005780	32.99
	Twist Lock	Female	115/250	30	0.5	8005774	39.99
F	Twist Lock	Female	125	30	0.3	8256703	21.99
	Twist Lock	Female	250	30	0.3	8256745	28.99
G	Plastic	Male	250	15	0.1	8310351	7.99
H	Plastic	Female	250	15	0.1	8310369	8.99
I	Rubber	Male	125	30	0.2	0704502	21.99
J	Rubber	Male	250	30	0.2	0704528	24.99

COOPER Tools
Plug Receptacle
 250V, 3-wire grounding
 surface receptacle
 0705012 - Wt. 0.7 lb **11⁹⁹**



30A Terminal Block
 • 10 sections
 • 13.2 mm pitch
 0700339 - Wt. 0.2 lb **5⁴⁹**



Shop / Work Lights

Bulk Electrical Cord

- PVC coated
- Outdoor, weatherproof

Volt Rating	Size	Type	Amp. Rating	Wt. (ft)	ITEM	PRICE
300	16/3	SJTW	10	0.1	8229346	0.59
	14/3	SJTW	15	0.1	8229338	0.69
	14/3	SOW	15	0.2	8229320	0.89
600	12/3	SOOW	20	0.2	8229312	1.39
	10/3	SOOW	25	0.3	8229254	1.89

AC Receptacle Tester
 Test 110 to 125V AC circuits with
 light code indicators
 8003373 - Wt. 0.1 lb **6⁹⁹**



GFI Receptacle Tester
 8003374 - Wt. 0.1 lb **8⁹⁹**

RV Adapters
30 to 15A Adapter
 • Provides convenient
 reduction of RV 30A service to 15A
 • For use with 125V, 30A equipped RVs
 • Adapter limited to 15 amps
 8213688 - Wt. 0.2 lb **9⁹⁹**
15 to 30A Adapter
 8213696 - Wt. 0.3 lb **11⁹⁹**



K) Weatherbox Complete
 • Weatherproof cover
 • Duplex outlet
 8257784 - Wt. 0.8 lb **8⁹⁹**

L) Weather Box with Cover
 • Seals out moisture, sheds water,
 ice and snow
 • For use with 12 ga or
 lighter cords
 8036550 - Wt. 0.6 lb **14⁹⁹**

M) 15A 125V GFCI Receptacle
 • 2-pole 3 wire grounding
 • 20 amp feed-through rating
 8256786 - Wt. 0.4 lb **16⁹⁹**

GFCI Protective Weather Cover
 • Cover for GFCI plug
 (8256786)
 • Non-metallic,
 non-corrosive and
 non-conductive
 8256802 - Wt. 0.2 lb **4⁹⁹**



Magic Wrap Tape
 • Bonds to itself, forming
 a solid rubber wrap
 that is air and water
 tight to 100 PSI
 • Ideal for plumbing,
 automotive, electrical
 0700353 - Wt. 0.1 lb **6⁹⁹**



N) 4 ft Halogen Shop Light
 • 300W / 600W output
 • 4-position switch
 • Protective safety grills
 • Dims with standard dimmer switches
 • Mounting chain
 and "S" hooks included
 • Includes two 150W, one 300W
 halogen bulbs and
 three safety grills
 8288508 - Wt. 4.7 lb **34⁹⁹**

P) 4 ft Shop Light
 • Commercial grade 4-lamp fixture
 • T5 shoplight with electronic ballast
 • Pull chain ON / OFF switch
 • Heavy duty safety grill
 • Includes energy saving
 T5 bulbs
 8288474 - Wt. 9.4 lb **99⁹⁹**

Woods®
Heavy Duty Construction Outdoor Timer
 • 24 hour cycle
 • Multiple ON / OFF settings
 • Max. 1,875W
 8180143 - Wt. 1.0 lb **19⁹⁹**



Outdoor Timer with Remote Control
 • 24 hour cycle
 • 2 hour to 8 hour settings
 • Max. 1,800W
 • Dual outlets
 8180168 - Wt. 0.8 lb **24⁹⁹**



BRINKS
2 Event Mechanical Timer
 • Grounded outlet
 • Setting dial faces wall
 outlet for added safety
 • Has storage compartment
 for setting pins
 8302465 - Wt. 0.4 lb **12⁹⁹**



globe
PVC Electrical Tape
 3/4" x 60 ft



Colour	Wt (lb)	ITEM	PRICE
Black	0.2	0701003	0.79
White	0.2	0700257	1.29
Yellow	0.2	0700258	1.29
Green	0.2	0700259	1.29
Red	0.2	0700261	1.29



Work Lights

A) 250W Halogen Lamp
 • 110V
 • Powder coated iron clamp and handle
 • With 5 ft cable
 • Halogen bulb included
8293847 – Wt. 2.5 lb **14⁹⁹**

B) 3 Million Candlepower Spotlight
 • Rechargeable battery
 • ABS body with soft touch finishing
 • Includes AC/DC CUL adapter, car charger, belt, 12V DC car adapter
8208118 – Wt. 4.0 lb **29⁹⁹**

C) 78 LED Work Light
 • Convenient swivel hanging hook and magnetic holder for hands-free use
 • 120V, 60 Hz
8106023 – Wt. 2.9 lb **49⁹⁹**

D) 52W Fluorescent Work Light
 • Wall mountable
 • Durable shatter-resistant housing
 • 8 ft cord, 360° rotation
8000869 – Wt. 2.9 lb **59⁹⁹**

E) 50 ft String Light
 • Provides quick or temporary lighting in barns, work sites
 • 14/3 SJTW wire for outdoor applications
 • 5 cages in 10 ft intervals
8196628 – Wt. 8.6 lb **89⁹⁹**

4-in-1 Work Light Lamp
 • Max. 60W bulb (not included)
 • Clamp it, stick it (magnetic), stand it and hang it
 • Stick it - rotates 360°
 • Clamp it - grasps objects up to 2" thick
 • Aluminum reflector shade
 • Non scratch magnetic base and clamp
 • 18/2 SJTW cord
8250706 – Wt. 2.2 lb **24⁹⁹**

NEW
LED Worklight for Drill Press
 • 14 LED white worklight
 • Installs tool free
 • No shadow under annular illumination
 • Holding capacity: 1.7" to 3.9"
 • Very strong magnet permits application to any steel or iron surface
 AC/DC adaptor
 • AC 120V, DC 4.5V 500mA
8381113 – Wt. 1.7 lb..... **29⁹⁹**

Replacement Bulbs

Watts	Wt (lb)	ITEM	PRICE
25	0.1	0704866	1.49
50	0.1	0700020	1.49
50	0.1	0700018	1.49

Replacement Bulbs

Type	For Work light #	Wt (lb)	ITEM	PRICE
Halogen	8293847	0.1	8294878	1.99
Halogen	8208118	0.1	8242778	1.99
Flourescent	8286288	0.1	8286338	2.99
Halogen	8306847	0.1	8307647	4.99

6 Pack Rough Service Bulbs

Watts	Wt (lb)	ITEM	PRICE
50	0.8	8024498	6.99
100	0.8	8008461	6.99

F) Trouble Light

- 16/3 SJT wire
- Metal cage and reflector
- Grounded plug in handle

Length	Wt. (lb)	ITEM	PRICE
25 ft	2.5	8003829	19.99
50 ft	4.5	8003832	34.99

G) 60 LED Cordless Work Light
 • 2,000 mAh 3.7 Lithium-ion battery
 • Lighting time: up to 3 hours
 • Charging time: 6 hours
 • Over-recharge safeguard
 • 3 LED charge indicator
8246118 – Wt. 1.1 lb **69⁹⁹**

H) Trouble Light with Cord Reel
 • 20 ft 18/3 SVT wire
 • Grounded outlet in handle
 • Galvanized metal lamp shield
 • Plastic case housing
8003827 – Wt. 3.9 lb **49⁹⁹**

I) Fluorescent Trouble Light
 • 12 m (40 ft) cord
 • Grounded outlet in handle
 • Metal retractable reel
 • 13W fluorescent light
 • Galvanized metal lamp shield
8003824 – Wt. 9.6 lb **69⁹⁹**

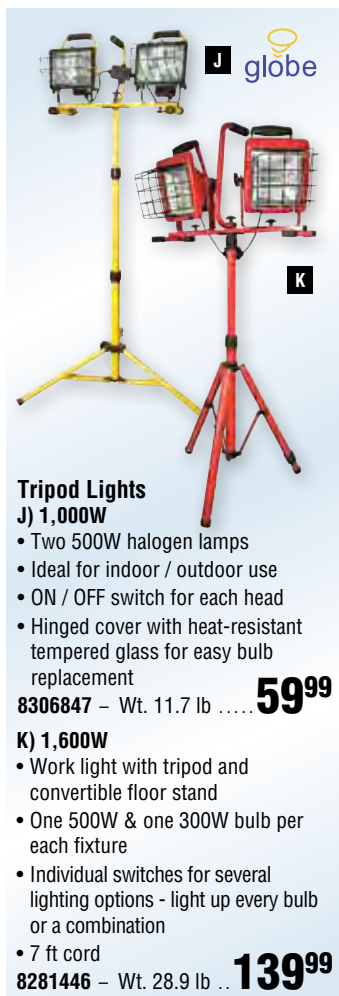

Tripod Lights

J) 1,000W
 • Two 500W halogen lamps
 • Ideal for indoor / outdoor use
 • ON / OFF switch for each head
 • Hinged cover with heat-resistant tempered glass for easy bulb replacement
8306847 – Wt. 11.7 lb **59⁹⁹**

K) 1,600W
 • Work light with tripod and convertible floor stand
 • One 500W & one 300W bulb per each fixture
 • Individual switches for several lighting options - light up every bulb or a combination
 • 7 ft cord
8281446 – Wt. 28.9 lb .. **139⁹⁹**



Fluorescent Work Lights

	Watts	For Work light #	Wt (lb)	ITEM	PRICE
L	13	6 ft	1.7	8286288	19.99
M	13	26-1/2 ft	3.6	8003828	34.99
N	15	25 ft	4.1	8007077	39.99



CFL Bulbs

Watts	Equivalent to	Bulb Life (hrs)	Feature	Wt (lb)	ITEM	PRICE
40	150	6,000	Enersaver	0.5	8313678	12.99
45	200	10,000	Cool White	0.7	8313686	19.99
45	200	10,000	Shatterproof	0.7	8313694	21.99

Shop Presses

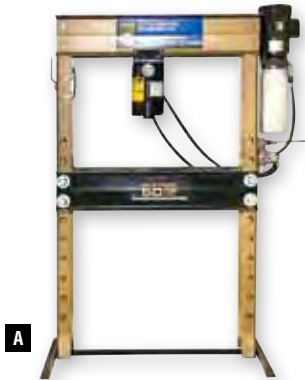

A

A) 50 Ton Industrial Hydraulic Shop Press

- Control valve can be mounted on right or left side of the frame
 - Self-contained power pack easily detaches for use in other applications
 - Easy to read hydraulic pressure gauge
 - Max. working pressure: 3,600 PSI
 - Ram stroke: 5-1/2", bore: 6"
 - Ram to bed distance: 5-3/4" to 37-3/4" at 4" increments
 - Bed width: 11-3/4"
 - Ram horizontal travel: 26-1/2"
 - Ram speed: 32" per min. (no load), 8" per min. at working pressure
 - 2 HP, 3,450 RPM, 208/230V continuous duty motor
 - O'all dim.: 72"h x 53"w
- 3460068** – Wt. 525.0 lb **2499⁹⁹**



B

B) 20 Ton Shop Press

- Working range: 0" to 36"
 - Remove and install bearings, U-joints and ball joints
 - Table raises and lowers easily for best working distance
 - All steel frame with bottle jack
- 8150948** – Wt. 181.1 lb **349⁹⁹**



C

C) 12 Ton Shop Press

- Working range 0 to 27"
 - Remove and install bearings, U-joints and ball joints
 - Steel frame with bottle jack
- 8150930** – Wt. 105.6 lb **199⁹⁹**

Shop Press

Replacement Spring

- 1-3/4" dia. x 8-3/4" long
- 3461449** – Wt. 1.6 lb **19⁹⁹**

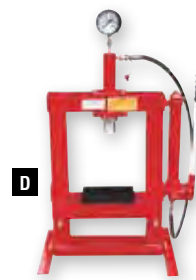

D

D) 10 Ton Hydraulic Floor Press

- Working range: 0" to 13"
 - Stroke: 7"
 - Bed width: 13"
 - O'all dim.: 27" x 18" x 42"
- 8382756** – Wt. 115.5 lb **269⁹⁹**



E

E) 12 Ton Hydraulic Shop Press

- Working range: 0" to 36"
 - Stroke: 7"
 - Bed width: 20"
 - Foot pump operated
- 8382764** – Wt. 166.0 lb **349⁹⁹**

1 Ton Arbor Press

- For heavy duty production and assembly work
 - Presses and removes precision bearings
 - Cast iron body, large base, slotted table plate
- 3460011** – Wt. 34.0 lb **79⁹⁹**



Pipe & Metal Benders



12 Ton Pipe Bender

- Includes dies for: 1/2", 3/4", 1", 1-1/4", 1-1/2" and 2" pipe
 - Max. pipe thickness: 12 ga
 - Makes up to 90° bends
 - O'all dim.: 21-1/2" h x 24" w x 6" d
- 8068017** – Wt. 87.2 lb **169⁹⁹**

16 Ton Pipe Bender

- Includes dies for: 1/2", 3/4", 1", 1-1/4", 1-1/2", 2", 2-1/2", and 3" pipe
 - Max. pipe thickness: 8 ga
 - Makes up to 90° bends
 - O'all dim.: 23-1/4" h x 30" w x 7" d
- 8068033** – Wt. 142.0 lb **269⁹⁹**



12 Ton Pneumatic Pipe Bender

- Working pressure: 113 to 170 PSI
 - Length of air hose: 3 ft
 - Ram stroke: 13" to 23"
 - Includes dies for 1/2", 3/4", 1", 1-1/4", 1-1/2", 2" pipe
 - Can be operated manually or pneumatically with an air source
- 8185506** – Wt. 91.4 lb **199⁹⁹**

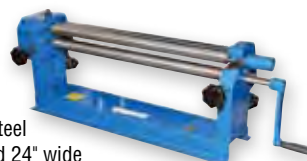

24" Slip Roll

- Accepts mild steel up to 22 ga and 24" wide
 - Forms cylinders 1-1/2" minimum
 - Wire forming grooves: 3/16", 1/4", 5/16"
 - 1-1/2" diameter steel pressing roll
- 8183196** – Wt. 88.2 lb **249⁹⁹**

Universal Metal Bender

- Makes a variety of bends on flat or solid, round or square steel
 - Capacity for hot rolled mild steel: 3/8" x 2" flat stock, 3/8" solid, square, or round
 - Includes: 7 different round dies; (1" to 3" in dia.)
 - Depth control rod for quick bend replication
 - Designed for portability; can be mounted in any bench vise or attached to your own custom base using included brackets
- 8000447** – Wt. 19.8 lb **89⁹⁹**



Metal Bender DVD

- Instructional video for 8000447
- 8089468** – Wt. 0.2 lb **9⁹⁹**

12" Metal Hand Shear

- Cut metal plate, rod and flat steel
 - Can be bolted to workbench
 - Steel frame with high carbon steel blade
 - Max. cut thickness: 1/4"
 - Max. cut flat steel: 2-3/4" x 1/4"
- 8096000** – Wt. 60.0 lb **149⁹⁹**





Universal Pedestal Mount Metal Bender

- Designed to make a variety of bends on flat, round or square steel
- Includes 7 dies: 1" to 3" for making different radius curved bends
- Capacity for hot rolled mild steel: 5/16" x 2" flat stock and 5/8" solid square or round

149⁹⁹



Cross Slide Vises

Use with milling machines or drill presses

Size	Jaw Width	Long Travel	Cross Travel	Wt. (lb)	ITEM	PRICE
3"	3-1/4"	3-1/4"	3-1/4"	15.3	8128134	49.99
4"	4"	4"	4"	17.9	8128142	59.99
6"	6"	6"	6"	35.1	8128159	79.99



330 lb Capacity Portable Work Stand

- Ideal support for windshields, fenders, body panels and doors
- Ideal support for windshields, fenders, body panels and doors for painting and installation

39⁹⁹



Drywall Hoist

- Max. load: 150 lb
- Max. sheet size: 4 ft x 16 ft
- Load height: 34"
- Max. height: 11 ft

249⁹⁹



36" Metal Brake with Stand

- Sheet metal cap.: 1/16" /16 ga
- Max. beam lift: 3/4"
- O'all dim.: 44" x 40" x 24"
- Performs up to 120° bend angles

349⁹⁹



English Wheel

- For shaping smooth and compound curves in sheet metal
- Height: 60"
- Throat: 28"
- 2", 3", 4", 6", 8", 10" radius & flat dies

499⁹⁹

Anvils & Vises

Table Vise

- Swivel vise can be attached to a table or bench with built-in clamp
- Jaw width: 2-3/8"
- Jaw opening: 2-3/4"

17⁹⁹



Bench Top Metal Brakes

- Makes up to 90° bends
- 18" Bench Top Metal Brake**
- Bend sheet metal up to 18 ga and 18" wide
- Lightweight aluminum construction

29⁹⁹



24 lb Cast Iron Anvil

- O'all dim.: 11-1/4" x 3-3/4" w x 6" h

39⁹⁹



6" Carpenter's Vise with Clamp

- Vise can be clamped anywhere, permanently mounted or moved to a free standing item
- "Toe In" jaw holds tighter at tip edge to prevent slipping

34⁹⁹

30" Bench Top Metal Brake

- Bends material up to 17-gauge (0.050") and 30" wide
- O'all dim.: 31-1/2" x 6" x 2-7/8"

69⁹⁹

5" Swivel Base Quick Release Vise

- 3" throat depth

89⁹⁹



Mechanic's Vises

With anvil
Fixed Base

Size	Wt. (lb)	ITEM	PRICE
5"	29.5	8077562	69.99
6"	44.5	8085748	99.99
8"	70.0	8085755	159.99

Swivel Base

Size	Wt. (lb)	ITEM	PRICE
4"	24.5	8085672	64.99
5"	34.0	8085698	79.99
6"	51.1	8085706	119.99

Drill Press Vises

- Will also fit standard power tool tables and bases
- Hardened steel jaw faces
- Cold-rolled steel screw
- Flanged base

Size	Jaw Width	Max Jaw Opening	Base Length	Base Width	Wt. (lb)	ITEM	PRICE
2"	2-1/2"	2-1/4"	5-1/4"	5-1/4"	2.6	3431814	11.99
3"	3"	2-3/4"	6-3/4"	5-3/4"	4.4	3430204	14.99
4"	4"	3-5/8"	7-1/2"	6-1/2"	5.4	3430212	19.99
5"	5"	5-1/4"	9-3/4"	8"	8.2	3430220	24.99
6"	6"	5-3/4"	10-3/8"	8-3/4"	12.0	3430238	29.99



Tool Boxes



Tool Boxes

Unique electrostatic powder coating, piano hinge and internal locking mechanism for greater security, 1-piece drawer slides, double walled construction, hemmed edges on all sides, full length drawer pulls, and heavy duty casters

A) 16" Flat Top Tool Box

- 16" w x 6" d x 6-1/2" h
- Durable steel construction
- High gloss powder coat finish
- Heavy plated latches

3480018 – Wt. 4.4 lb **19⁹⁹**

A) 21" Flat Top Tool Box

- O'all dim.: 21" w x 8-3/4" d x 9" h
- Removable tray

8214876 – Wt. 12.4 lb **34⁹⁹**

B) 20" Hip Roof Tool Box

- 20" w x 7" d x 8" h
- Durable steel construction
- High gloss powder coat finish
- Heavy plated latches

3480017 – Wt. 7.9 lb **28⁹⁹**

C) 14" Saw Box

- 13-1/2" w x 10" d x 10" h
- Heavy plated latches

3480014 – Wt. 6.5 lb **27⁹⁹**

D) 6 Drawer Classic Series Tool Chest

- 26" w x 12" d x 14-1/2" h
- Heavy duty double wall construction for added strength
- Full extension drawers with smooth action compound drawer slides
- High gloss powder coat scratch resistant paint

8093916 – Wt. 51.2 lb **179⁹⁹**

E) 10 Drawer Mechanic's Tool Chest

- O'all dim.: 26" w x 12" d x 18-7/8" h
- Storage capacity: 4,000 cu in
- Drawer: 7" w x 10-1/2" d x 6" h
- Drawer: 23" w x 10-1/2" d x 2-1/2" h
- 2 drawers: 23" w x 10-1/2" d x 2" h

8093924 – Wt. 66.9 lb **269⁹⁹**

F) 5 Drawer Roller Cabinet

- Storage capacity: 13,364 cu in
- Drawers: four 23" w x 16" d x 4-1/4" h, and one 23" w x 16" d x 2" h
- Bottom storage: 26-3/4" w x 16-3/4" d x 11-1/2" h
- Load rating: 575 lb

8093940 – Wt. 129.0 lb **369⁹⁹**

G) 7 Drawer Hang-On Cabinet

- O'all dim: 15" w x 18-3/4" d x 30-1/2" h
- Storage capacity: 3,921 cu in
- 4 drawers: 11" w x 16-3/8" d x 2" h
- 2 drawers: 11" w x 16-3/8" d x 4" h

8093932 – Wt. 61.0 lb **259⁹⁹**

H) 11 Drawer Roller Cabinet

- O'all dim.: 41-3/4" x 18-1/4" x 41-5/8"
- Storage capacity: 12,328 cu in
- 1 drawer: 36-1/2" width
- 6 drawers: 22-1/8" width
- Load rating per drawer: 50 lb
- 4 drawers: 12" width

8098667 – Wt. 193.4 lb **699⁹⁹**

Shop Organization



I) 24 Bin Storage Rack

100 lb load capacity
8257750 – Wt. 20.9 lb **69⁹⁹**

K



J) Double Sided Storage Rack

- Keep small parts and hardware organized in garage or work area
- 64 small bins, 30 large bins

8170607 – Wt. 83.8 lb **199⁹⁹**

K) Paper Towel / Chemical Holder

8314759 – Wt. 3.1 lb **19⁹⁹**

L) 3 Drawer Metal Organizer

8314767 – Wt. 2.8 lb **9⁹⁹**

L



Wall Mount Bike Bracket

- Convenient space saving storage for bikes
- Hardware included for mounting to garage wall

8320756 – Wt. 2.2 lb **6⁹⁹**



Wall Mount Bike Hook

- Convenient space saving storage for bikes

8320723 – Wt. 2.1 lb **7⁹⁹**



Tool Carts & Work Benches



A) Service Cart

- 300 lb capacity
- O'all dim.: 30.4" x 16.2" x 34.7"
- 8096745 – Wt. 44.2 lb **99⁹⁹**

B) 3-Tier Service Cart

- 200 lb capacity
- 3 shelves: 23.5" x 16" x 2.5"
- One drawer with ball bearing: 19" x 14" x 2.5"
- O'all dim.: 32"L x 31.5"H x 18"W
- 8158925 – Wt. 46.3 lb **119⁹⁹**

C) 3 Drawer Utility Cart

- Trays 28" x 16" x 2"
- O'all dim.: 37-1/2" x 17" x 34-1/4"
- 8043681 – Wt. 59.4 lb **159⁹⁹**

D) Multi-Purpose Cart

- Canvas basket
- O'all dim.: 24" x 24-1/2" x 38" tall
- 8321481 – Wt. 29.0 lb **99⁹⁹**



E) Adjustable High Rise Tool Tray

- Lift range: 35" to 48"
- 24" x 17" tool tray with non-slip mat
- Keep tools directly beside vehicle or equipment being repaired
- 8008489 – Wt. 35.2 lb **74⁹⁹**

F) 440 lb Capacity Heavy Duty Work Bench

- Top plate dimensions: 60"L x 30.7W (2.0 mm thickness)
- 3.5" leg adjustment
- Overall height 34"
- Powder coat finish
- 8338220 – Wt. 158.0 lb **249⁹⁹**



Heavy Duty Folding Work Bench

- Steel construction
- Powder coat finish
- 500 lb capacity
- Top peg board for hanging tools
- Powerful gas struts to expand top surface board
- Telescopic legs can be opened to support bench board
- 8338097 – Wt. 100.0 lb **299⁹⁹**

Hobby / Visitor Safety Glasses

- Features a polycarbonate lens, tether cord, and are SEI certified to meet CSA standards
- Fits over most prescription glasses
- Clear lens
- 8173494 – Wt. 0.2 lb **4⁷⁹**

Anti-Fog Safety Glasses

- Impact resistant polycarbonate lens
 - Comfortable, soft padded nose piece
- | Lens | Wt. (lb) | ITEM | PRICE |
|-------|----------|---------|-------|
| Clear | 0.1 | 8173551 | 9.99 |
| Amber | 0.1 | 8173577 | 9.99 |
| Smoke | 0.1 | 8173585 | 9.99 |



Bifocal Safety Glasses

- Lightweight design combines safety features with bifocal lenses
- | Magnification | Lens | Wt. (lb) | ITEM | PRICE |
|---------------|-------|----------|---------|-------|
| 1.5x | Clear | 0.2 | 8098675 | 14.99 |
| 2.0x | Clear | 0.1 | 8098691 | 14.99 |
| 1.5x | Grey | 0.2 | 8184632 | 16.99 |
| 2.0x | Grey | 0.1 | 8185936 | 16.99 |
| 1.5x | Clear | 0.1 | 8319808 | 6.99 |
| 1.5x | Grey | 0.1 | 8319832 | 6.99 |
| 2.0x | Clear | 0.1 | 8319717 | 6.99 |
| 2.0x | Grey | 0.1 | 8319766 | 6.99 |

Acrylic Reading Glasses

- Frameless, 1/2 lens design for magnified reading below eye level
- | Magnification | Wt. (lb) | ITEM | PRICE |
|---------------|----------|---------|-------|
| +1.00 | 0.1 | 8010378 | 3.99 |
| +1.50 | 0.1 | 8010387 | 3.99 |
| +2.00 | 0.1 | 8010396 | 3.99 |
| +2.50 | 0.1 | 8010403 | 3.99 |
| +3.00 | 0.1 | 8010412 | 3.99 |

- Safety Glasses with LED Light**
8243628 – Wt. 0.1 lb **4⁹⁹**

Safety Glasses

Safety Glasses

Polycarbonate lens

Lens	Wt. (lb)	ITEM	PRICE
Yellow	0.1	8160194	2.99
Clear	0.1	8160202	2.99

Safety Glasses

Features a scratch resistant polycarbonate lens, tether cord, and are SEI certified to meet CSA standards

Lens	Wt. (lb)	ITEM	PRICE
Clear	0.1	8173544	3.49
Smoked	0.1	8173452	3.49

Bi-Focal Safety Glasses

Impact and scratch resistant

Magnification	Wt. (lb)	ITEM	PRICE
1.5x	0.1	8243669	4.99
2.0x	0.1	8243677	4.99

Metal Frame Safety Glasses

Impact resistant lens with anti-fog and UV protection

Lens	Wt. (lb)	ITEM	PRICE
Clear	0.1	8173601	11.99
Grey	0.1	8173619	11.99

Goggles & Face Shields



- A) Face Shield with Flip-Up Clear Visor**
Black head gear with 8" x 13-1/2" shield
5040647 - Wt. 0.5 lb **9⁹⁹**
Clear Replacement Visor
For face shield 5040647 **3⁹⁹**
5040621 - Wt. 0.2 lb **3⁹⁹**
Grey Replacement Visor
• Shade #3
• For face shield 5040647
8203754 - Wt. 0.2 lb **4⁹⁹**
- B) Face Shield with Clear Visor**
• Floating snap-lock suspension
• Sponge-cushioned headband
8059164 - Wt. 0.9 lb **16⁹⁹**

- C) Face Screen with Hearing Protectors**
• Front head shield, wire mesh face screen and hearing protectors
• Ideal when operating a wood chipper, weed eater, chainsaw or other shop and yard equipment
• Hearing protectors have a NRR rating of 28 dB
8231334 - Wt. 1.2 lb **19⁹⁹**
Replacement Visor
Polycarbonate replacement visor for 8059164
8181745 - Wt. 0.2 lb **6⁹⁹**

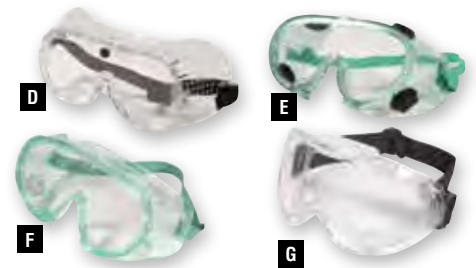

- D) Safety Goggles with Dustproof Vents**
8193021 - Wt. 0.2 lb **3⁴⁹**
- E) Safety Goggles with Indirect Vents**
8193039 - Wt. 0.2 lb **3⁹⁹**
- F) Anti-Fog Goggles**
Provides protection against liquid and flying particles
8173627 - Wt. 0.3 lb **5⁹⁹**
- G) Wide View Safety Goggles**
Scratch-resistant curved polycarbonate lens for good visibility
8175697 - Wt. 0.3 lb **7⁹⁹**

Dust Masks & Respirators

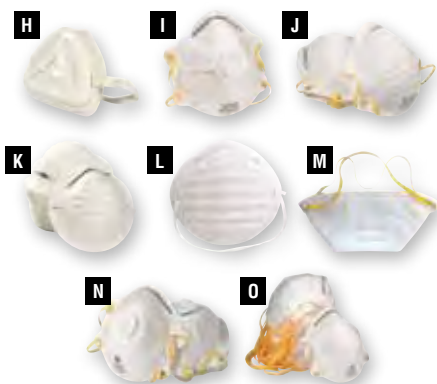

- Dust Masks**
- H) Dust Mask with Replaceable Filter**
8013936 - Wt. 0.1 lb **1⁹⁹**
- I) N95 Dust Respirator with Exhale Valve**
Exhalation valve reduces heat and humidity build-up
8173650 - Wt. 0.2 lb **6⁹⁹**
- J) 3 pk Disposable Dust Masks**
N95 rated
8173643 - Wt. 0.2 lb **5⁹⁹**
- K) 50 pk Disposable Dust Masks**
5041025 - Wt. 0.4 lb **6⁹⁹**
- L) 50 Disposable Dust Masks**
8304255 - Wt. 0.6 lb **7⁹⁹**
- M) N95 5 pc Foldable Dust Mask**
8304263 - Wt. 0.1 lb **9⁹⁹**
- N) 5 pc Dust Mask Set**
N95 rated
8193047 - Wt. 0.2 lb **12⁹⁹**
- O) 20 pk Disposable Dust Masks**
N95 rated
8047516 - Wt. 0.6 lb **18⁹⁹**



- Respirators**
- P) P100 Asbestos / Lead Respirator**
• Protects against 99.97% of toxic dust, mists, fumes, lead dust, asbestos, and oil mist
• Low profile for better vision
8173718 - Wt. 0.6 lb **34⁹⁹**
- Q) Paint & Pesticide Respirator**
• Comfortable lightweight design with P95/organic vapour cartridges
• Protects against 95% of contaminants when working with solvent, glue, pesticides, fertilizer, and spray painting of lacquers and enamels
8173668 - Wt. 0.9 lb **34⁹⁹**
- R) R95/OV Full Face Respirator**
• NIOSH approved for protection against paints, pesticides, organic vapours, lacquers, dusts and fibreglass
• Nose cup design helps prevent fogging
• Flexible face piece for better seal and fit
• Two R95 filters and carrying case
• Interchangeable with P100 filters (8045510)
8046021 - Wt. 3.9 lb **199⁹⁹**



- Replacement Filters**
- S) 5 pk Replacement Filters**
For item 8013936
8013927 - Wt. 0.1 lb **99[¢]**
- T) 4 pc Replacement Prefilters**
For: 8045486
8068942 - Wt. 0.1 lb **11⁹⁹**
- U) 2 pc Replacement P95 Filter Cartridges**
For respirator 8173668
8173692 - Wt. 0.6 lb **19⁹⁹**
- V) 6 pc Replacement Prefilters for Filter Cartridge**
For respirator 8173668
8173684 - Wt. 0.1 lb **12⁹⁹**
- W) 2 pc R95 / Organic Vapour Replacement Filter**
8045494 - Wt. 0.6 lb **22⁹⁹**
- X) 2 pc P100 Replacement Filter Cartridges**
For respirator 8173718
8173726 - Wt. 0.3 lb **24⁹⁹**
- Y) 2 pc P100 / Organic Vapour Replacement Filters**
8045510 - Wt. 0.7 lb **29⁹⁹**

Hearing Protection & Helmets



- A) Hearing Protectors**
NRR of 26 dB
5040514 – Wt. 0.4 lb **5⁹⁹**
- B) Hearing Protectors**
• NRR of 28 dB
• 3-position padded headband
5060004 – Wt. 0.4 lb **7⁹⁹**
- C) Folding Hearing Protector**
NRR: 27 dB
5060003 – Wt. 0.5 lb **9⁹⁹**
- D) Hard Hat Hearing Protectors**
• NRR of 22 dB
• Fits standard slotted hard hats
8192080 – Wt. 0.6 lb **12⁹⁹**

- E) Hearing Protectors**
• Plastic band suitable for use around electrical hazards
• NRR: 20 dB
8045528 – Wt. 0.7 lb **16⁹⁹**
- F) Electronic Hearing Protectors**
• Protects hearing from harmful noise with ability to hear normal conversations
• NRR of 26 dB
• Protection automatically activated by noises above 85 dB
• ON / OFF switch with volume control
8266561 – Wt. 0.8 lb **39⁹⁹**

- Ear Plugs**
• Low pressure plugs
• NRR of 29 dB
- G) 10 Pr Foam Ear Plugs**
8173734 – Wt. 0.1 lb **2⁷⁹**
- H) 100 pair Foam Earplugs**
8173783 – Wt. 0.3 lb **19⁹⁹**
- I) 4 pc Rubber Earplugs**
NRR of 27 dB
8159915 – Wt. 0.1 lb **99¢**
- J) Rubber Earplugs with Cord**
NRR of 27 dB
8159899 – Wt. 0.1 lb **99¢**
- K) Banded Ear Plugs**
NRR: 26 dB
8159907 – Wt. 0.1 lb **2⁹⁹**

- Soft Bump Cap**
• Provides protection where hard hats are not required
• Lightweight, durable ABS plastic liner
8175242 – Wt. 0.4 lb **9⁹⁹**

- 3-in-1 Hard Hat**
Hard hat includes mounted hearing protectors and flip-up face shield
8190597 – Wt. 2.3 lb **24⁹⁹**

- Hard hat with Red Maple Leaf**
• Ratchet suspension and total shell coverage
• CSA (class E)
8377434 – Black
8377442 – White
Wt. 1.0 lb **29⁹⁹/ea**

DEGIL
MADE IN CANADA

Hard Hats
• CSA type 2, class E
• 4-point nylon suspension
• Ratchet style sizing adjustment
• Lightest weight available in the industry
• Low profile with improved rain trough design draws rain away from back of hat
• Moulded foam liner
Wt. 1.0 lb
8003912 – White
8004314 – Yellow **32⁹⁹/ea**

Hard Hats
• Sliding pin lock head band
• Top, impact and penetration protection
• 4 point nylon suspension
Wt. 0.8 lb
8184640 – White
8185951 – Yellow **9⁹⁹/ea**

Hard Hats
• Easy to adjust size with ratchet adjustment
• 4-point nylon suspension
Wt. 0.9 lb
8223588 – White
8223596 – Yellow **14⁹⁹/ea**

- "Caution" Barricade Tape**
5040089 – Wt. 0.6 lb **5⁹⁹**
3" x 1,000 ft "Caution" Barricade Tape
8241556 – Wt. 1.8 lb **13⁹⁹**

TASK

PVC Flagging Tape
• Durable PVC for outdoor use
• Highly visible colour
• Non-adhesive for use in landscaping, construction, hazard alerts renovations and more

Size	Wt (lb)	ITEM	PRICE
Pink	0.3	8114118	2.99
Orange	0.3	8114134	2.99
Red	0.3	8114126	2.99
Green	0.3	8324287	2.99
Yellow	0.3	8114142	2.99

- TASK**
- Bundle of Marking Flags**
• 30 pc value bundle for marking positions in various building sites
• Fluorescent colours provide high visibility in all weather conditions
• Flags made of durable PVC material
• Solid cut flexible steel wire will not bend
8324295 – Wt. 0.6 lb **4⁸⁹**

Anti-Slip Safety Grit Tape

Use on steps, ramps, trailers, farm equipment, or anywhere a potentially hazardous slip may occur

Size	Wt. (lb)	ITEM	PRICE
1" x 16 ft	0.2	8160509	2.99
2" x 16 ft	0.4	8160491	4.99
1" x 60 ft	0.6	8176307	9.99
2" x 60 ft	1.1	8176299	14.99

6" x 21" Anti-Slip Grip Strip
8040834 – Wt. 0.2 lb **11⁹⁹**

Safety Tape

Reflective Safety Tape
1" x 24"
Wt. 0.1 lb

Colour	ITEM	PRICE
Flourescent Orange	5040151	6.99
Flourescent Lime	5040152	6.99
Silver	5040153	6.99
Yellow	8242752	6.99
Blue	8242828	6.99

Knee Pads & Safety Wear



A) Foam / Hard Cap Knee Pads

Foam knee pads with hard cap
8154510 – Wt. 0.4 lb

5⁹⁹

B) Foam Knee Pads with Fabric Cover

Foam knee pads with fabric cover
 • Ideal for working on delicate surfaces
8154528 – Wt. 0.3 lb

9⁹⁹

C) Gel Knee Pads

• Gel padding for extra comfort
 • Non-marking, non-skid PVC cap is oversized for extended protection
8154536 – Wt. 1.5 lb

19⁹⁹

D) Gel Knee Pads

• Non-slip PVC outer cap
 • Gel padding provides extra comfort
8104408 – Wt. 1.3 lb

17⁹⁹

E) Gel Knee Pads

Non-marring surface
8199911 – Wt. 1.2 lb

32⁹⁹

F) Gel All-Terrain Knee Pads

Made with GELite™ padding; a unique blend of GEL and polyurethane foam
8199895 – Wt. 1.3 lb

39⁹⁹

Reflective Belt

Nylon belt with reflective strip
8265183 – Wt. 0.6 lb

9⁹⁹



Safety harness green

• 2" heavy duty elastic with clip
 • 3M scotchlite reflective tape
 • 4 point tear away
 • One size fits all
8377459 – Green
8377467 – Orange
 Wt. 0.6 lb

14⁹⁹ /ea

Visibility Kit

Includes foldable pylon, safety vest and flashing LED beacon
8154114 – Wt. 0.9 lb

14⁹⁹

Back Support Belt

• Adjustable panels for extra lower back support
 • Adjustable to fit waist sizes 38" to 47"
8167462 – Wt. 0.7 lb

14⁹⁹

Fender Protector

Hi-grain heavy duty vinyl
8287617 – Wt. 0.6 lb

24⁹⁹



4" x 17-1/2" Safety Step®

• Peel and stick adhesive backing
 • Adheres to any surface
8359630 – Wt. 0.6 lb

3⁹⁹



Precision Parking Guide

• Unique tongue design holds mat in place
 • Lay on garage floor to find that perfect spot every time
 • Only one mat needed per car
8320780 – Wt. 2.6 lb

14⁹⁹



5 Point Safety Vests

• 3M Scotchlite™ reflective tape
 • D ring access slot
 • Tricot polyester interlock
 • Adjustable 1 size up at sides
 • Radio phone clip strap
 • CSA Z96-09 Class 2 Level 2

Size	Colour	Wt. (lb)	SKU	Price
L / XL	Lime Green	0.6	8377475	19.99
L / XL	Orange	0.7	8377483	19.99
2XL / 3XL	Lime Green	0.7	8380719	19.99
2XL / 3XL	Orange	0.7	8380743	19.99



Safety Vests

• Hi viz traffic vest
 • Polyester mesh
 • Reflective tape
 • CSA Z96-09,
 • One size fits all
8377509 – Orange
8377491 – Lime
 Wt. 0.6 lb

12⁹⁹ /ea



Safety Vest

• High visibility orange mesh
 • Reflective front and back stripes
8265191 – 5 point velcro tear-away design
 4 front pockets
 Wt. 0.3 lb

7⁹⁹

8093643 – Adjustable sides and velcro front closure
 Wt. 0.3 lb

9⁹⁹



Roofers kit

• Basic harness
 • "Shock Pack" shock absorbing lanyard with rope adjuster
 • Karabiners
 • Roofer's bracket with D-ring & ardox spiral nails

8377525 – 25 ft Vertical Lifeline
 Wt. 11.4 lb

199⁹⁹

8377533 – 50 ft Vertical Lifeline
 Wt. 13.5 lb

249⁹⁹



Harness Kit

• Full body harness and lanyard combination sewn together
 • Lightweight combination made of polyester webbing
 • especially designed for aerial lift applications
 • Harness has 3-point adjustment for one size fits most. 6 ft Shock-absorbing lanyard end integrated directly to harness, with self-locking 3/4 in
 • Complies with ANSI Z359. 1, CSAZ259.10 & CE Standards

8377749 – Wt. 3.3 lb

99⁹⁹



Wrist Wrap

• Fits left or right hand
 • Protects against repetitive impact and vibration
 • Protective palm cushion with breathable mesh lining
5040088 – Wt. 0.2 lb

9⁹⁹

Safety Cones

- Multi-use including traffic direction and sports use
- With reflective stripe for increased visibility at night

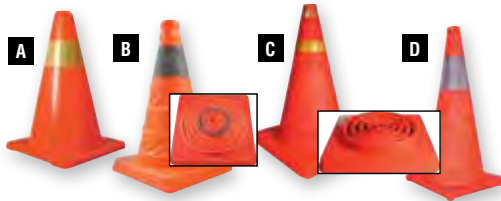

	Size	Reflective Strip	Collapsible	Wt. (lb)	ITEM	PRICE
A	9"	Yes	No	0.3	8154106	3.99
B	12"	Yes	Yes	0.8	8154080	7.99
C	15"	Yes	Yes	1.1	8003400	9.99
D	24"	Yes	Yes	1.9	8154098	16.99

E) Kneeling Pad

- Rugged outer layer to withstand rough surfaces, soft density inner padding for added comfort

• 14-1/2" x 13-1/2"
8199937 – Wt. 0.3 lb **9⁹⁹**

F) Kneeling Pad

O'all dim.: 15" x 18"
8262420 – Wt. 0.7 lb **8⁹⁹**

G) Kneeling Pad

O'all dim.: 15" x 20"
8099442 – Wt. 1.0 lb **9⁹⁹**



Deluxe Roadside Kit

Snow shovel, blanket, tow rope, flashlight, hand warmers, gloves, candles with matches, whistle and siphon pump all in a convenient carry bag

8299604 – Wt. 4.9 lb **34⁹⁹**



Roadside Emergency Kit

- Contains essentials like tire sealer/inflator, booster cables, first aid kit and more, all in a convenient carry bag

• With 1 year of 24/7 roadside assistance
• 24 HR EMERGENCY ROADSIDE ASSISTANCE (valid for 1 year from date of purchase)
8299638 – Wt. 6.8 lb **39⁹⁹**

Parts Washers



20 Gallon Parts Washer

- 20 gallon tub with 12 gallon working cap.
- 120V pump, max. cap.: 132 GPH (2.2 GPM)
- Safety link in lid hinge releases and automatically closes lid if fire starts

8022392 – Wt. 57.0 lb **189⁹⁹**

24" Replacement Flexible Parts Washer Nozzle

4218731 – Wt. 1.1 lb **14⁹⁹**

Replacement Parts Washer Pump

- Replacement pump for 8022392
- Max. capacity: 132 GPH (2.2 GPM)

8022891 – Wt. 1.2 lb **34⁹⁹**



8-1/2" Parts Washing Brush Set

2 flow through brushes fit 1/2" I.D. hose
4273488 – Wt. 0.2 lb **6⁹⁹**

Hub Cleaning Brush

Ideal for cleaning hubs when repacking bearings, inside tubes, and other hard-to-reach places
8044699 – Wt. 0.1 lb **3⁹⁹**

8" Parts Washing Brush

• 1" dia.
• 100% pure nylon bristles
2917151 – Wt. 0.1 lb **2⁹⁹**

Parts Washer Pump

• 120V epoxy encapsulated submersible pump
• Pumps 240 GPH (4 GPM)
• O'all dim.: 3" x 4-1/2" x 4"
4216107 – Wt. 2.5 lb **49⁹⁹**

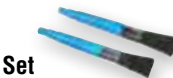

5 Gallon Parts Washer

• 5 gallon tub with 3.5 gallon working capacity
• Pump, tray, and steel flex nozzle
• Safety link in lid hinge releases and automatically closes lid if fire starts
• O'all dim.: 17" x 13" x 8-3/4"
8003630 – Wt. 16.7 lb **99⁹⁹**



Round Magnetic Strainer

• Stainless steel strainer
• Antirust and durable
• Perfect for washing dirty tools
• Rubber coated magnet prevents scuffing and scratching
8381774 – Wt. 1.0 lb **9⁹⁹**



Not recommended for parts washer cleaning

Spray Nine® Power Kleen Parts Wash Cleaner

• Powerful non-solvent, aqueous cleaning fluid ideal for parts washing
• Works in traditional and heated parts washers, pressure washers and other automated equipment
8098055 – Wt. 8.8 lb **24⁹⁹**



Solvents

Excellent automotive/agricultural / industrial parts cleaner
4 Litre 8057143 – Wt. 7.3 lb **11⁹⁹**
20 Litre 8047490 – Wt. 37.8 lb **49⁹⁹**



Oil Draining



A) 65 Litre Portable Oil Drain

- Swivel front wheel casters with grab handle for easy under vehicle positioning
- 2 baffles, metal grating, and continuous side splash guards prevent oil spillage
- Ideal for trucks, RVs, and heavy equipment

8035529 – Wt. 39.9 lb **179⁹⁹**

B) 64 Litre Low Profile Oil Drain

- Manual pump, pipeline, push handle and four 4" casters

8338022 – Wt. 47.4 lb **249⁹⁹**



Oil Pans

C) 8 Litre Capacity Round Pan

14" round drain pan
8058117 – Wt. 0.7 lb **3⁹⁹**

D) 9 Litre Capacity Triangular Pan

Heavy duty drain pan
8058125 – Wt. 0.8 lb **4⁹⁹**

E) 15 Litre Oil Drain Pan

- Black polyethylene material
 - Splash guard rim and top mounted pour spout minimizes spillage
- 8006588 – Wt. 2.4 lb **17⁹⁹**

Funnels



Funnel Multi-Purpose

J) Multi-Purpose Funnel

- No-mess splash guard
- Extended filler neck opens gas tank trap door
- For transmission fluid, power steering fluid and gas / oil additives and oil

8270118 – Wt. 0.1 lb **2⁴⁹**

K) Locking Oil Funnel

Lock-in oil filler hole
8254435 – Wt. 0.2 lb **2⁹⁹**

L) Heavy Duty Transmission Funnel

Designed for hard to reach applications
8260341 – Wt. 0.2 lb **2⁹⁹**

M) Super Quickfill® Funnel

Large diameter and extra wide neck allows for high velocity pouring
8257560 – Wt. 0.1 lb **3⁴⁹**

N) 3 pc Heavy Duty Multi-Purpose Funnel Trio

Includes 1/2 pint (yellow), 1 pint (blue) and 2 quart (red)
8260333 – Wt. 0.4 lb **3⁹⁹**



O) Gas Gauge Funnel™

Floating indicator signals when gas tank is full
8071029 – Wt. 0.1 lb **4⁹⁹**

P) Giant Funnel

Snap in screen
8257552 – Wt. 0.5 lb **5⁹⁹**

Q) 6" Plastic Funnel with Handle

- 1-1/2 qt. capacity
- Flexible 13" spout and 24" tubing

4270167 – Wt. 0.5 lb **6⁹⁹**

R) Measu-Funnel

- Measures and pours
- Pouring tube with cap

8099673 – Wt. 0.3 lb **7⁹⁹**

S) 6" Metal Funnel

12" long flexible spout
8035501 – Wt. 0.7 lb **9⁹⁹**

T) Galvanized Funnel

6 litre
8213969 – Wt. 2.2 lb **21⁹⁹**



F) Fluid Evacuator

- Provides a clean, fast and simple way to evacuate a wide range of fluids
 - Use to remove engine oil, transmission fluid, gear oil, coolant and brake fluid
 - 2 gallon (7.3L) capacity
- 8051633 – Wt. 7.1 lb **79⁹⁹**

G) 2-1/2 Gallon (9.5L) Manual Fluid Extractor

- Nylon tube dia.: 3.5 mm, 5.3 mm, 7.8 mm
 - Super strong suction power with 3 sizes of extraction tubes
 - With decompression valve
- 8319667 – Wt. 10.1 lb **89⁹⁹**

H) 2-1/2 Gallon Pneumatic / Manual Fluid Extractor

- Operating pressure 40-170 PSI
 - 3 nylon tubes, 5ft silicone hose with control valve and universal rubber adapter, valve and safety cup for auto cut-off extracting
 - 3 air outlets for quick and easy release of air from the extractor
 - Decompression valve easily releases negative pressure
 - Use to remove engine oil, transmission fluid, gear oil, coolant and brake fluid
- 8355752 – Wt. 10.7 lb **129⁹⁹**

I) 1-1/2 Gallon (6L) Pneumatic / Manual Fluid Extractor

- Operating pressure: 40 to 170 PSI
 - 3 nylon tubes for all non-corrosive fluids
 - 3 air outlets and check valve
 - 5 ft silicone hose
 - One touch controller and universal rubber adapter
 - Fixing valve and safety cup for auto cut-off extracting
- 8381725 – Wt. 10.0 lb **109⁹⁹**

Spill Free™ Funnel

- Eliminates trapped air pockets which usually cause erratic cooling system and heater performance
 - Three adapters fit most domestic and import cars and light trucks
 - Angled neck allows use on radiator caps that are placed at an angle
- 8225880 – Wt. 1.2 lb **29⁹⁹**



Oils & Lubricants



- A) SAE 30 Motor Oil**
Recommended for 4 stroke lawn mowers and gas powered engines where single grades are specified
8003010 – Wt. 2.1 lb **3⁹⁹**
- B) 2 Cycle Smokeless Oil**
Formulated for snowblowers, lawnmowers, string trimmers and chainsaws also is good for motorcycles
8181810 – Wt. 0.5 lb **3⁹⁹**
- C) 1 Litre All Season Chain Oil**
• Prolongs the life of your chain, bar and sprockets
• Designed for year round use
8003023 – Wt. 2.1 lb **3⁹⁹**
- D) 1 Litre SD 5W30 Motor Oil**
• For gasoline fueled cars and light duty trucks
• Makes cold starting easier
8003025 – Wt. 2.1 lb **4⁴⁹**
- E) 1 Litre 5W30 Synthetic Motor Oil**
8247801 – Wt. 2.1 lb **8⁹⁹**
- F) 1 Litre 80W90 Multi Gear Oil**
• Recommended for limited slip differentials
• For hypoid axles, gear and steering boxes of car and trucks
8003027 – Wt. 2.1 lb **5⁴⁹**



- G) 4 Litre 15W40 Diesel Oil**
Recommended for 4-stroke diesel engines
8284838 – Wt. 7.8 lb **19⁹⁹**
- H) 4 Litre Snowmobile Injection Oil**
• Two stroke motor oil
• Suitable for premix
• Service TC-W3
8247819 – Wt. 8.3 lb **19⁹⁹**

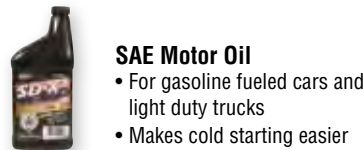

- SAE Motor Oil**
• For gasoline fueled cars and light duty trucks
• Makes cold starting easier

Weight	Volume (litre)	Wt. (lb)	ITEM	PRICE
10W30	1	2.2	8003024	4.49
10W30 SD	4	8.8	8003014	15.99



- 3-IN-ONE**
3-In-One® Motor Oil
• Special blend of high-grade oils that's equivalent to SAE 20
• Ideal for lubricating the moving parts of electrical motors
• 88.7 ml (3 oz)
6410001 – Wt. 0.2 lb **3⁶⁹**
6410027 – Wt. 0.3 lb **3⁹⁹**



- Penetrant Spray**
Helps prevent rust and corrosion
8003446 – Wt. 1.0 lb **5⁹⁹**
- Silicone Spray**
Stops squeaks, eliminates sticking, waterproofs, and prevents rust and corrosion
8003463 – Wt. 0.9 lb **5⁹⁹**
- White Lithium Grease**
Provides long-lasting lubrication for all metal-to-metal applications
8003464 – Wt. 0.9 lb **6⁹⁹**



Shell Motor Oil

	Weight	Volume (litre)	Wt. (lb)	ITEM	PRICE
I	10W30	1	1.9	8333940	4.89
	5W30	1	1.9	8333965	4.89
	5W20	1	1.9	8333973	4.89
J	10W30	5	8.0	8360828	22.99
	5W30	5	8.0	8360836	22.99
K	5W20	5	7.9	8360844	22.99
	T15W40	5	8.1	8360851	26.99
	T10W30	5	8.1	8360869	26.99



- L) Fuel Injector Gas Line Antifreeze "Supreme"**
Prevents frozen gas lines during the winter and vapour lock during the summer
8050452 – Wt. 0.3 lb **99¢**
- M) Lock De-Icer**
Instantly de-freezes all types of locks and lubricates internal lock mechanism
8108524 – Wt. 0.1 lb **1⁹⁹**
- N) Diesel Lubricant**
All season diesel lubricant (low sulphur formula) provides superior lubricity and anti-wear protection for diesel engines
8050460 – Wt. 3.8 lb **17⁹⁹**



WD-40

	Type	Wt. (lb)	ITEM	PRICE
O	Spray Can	0.9	6420152	4.99
P	Spray Bottle	0.2	6420210	5.49
Q	Bulk Refill	8.0	6420145	29.99



- R) 2 Cycle Oil**
Superior "low wash" lubrication for 2-cycle engines requiring (up to and including) 50:1 gas / oil mixtures
8294555 – Wt. 1.1 lb **4⁹⁹**
- S) Liquid Wrench® Dry-Lube with Cerflon®**
Superior lubricity with no oily residue
8032278 – Wt. 1.0 lb **7⁹⁹**



- Silver Grade Anti-Seize Compound**
For easy assembly and disassembly of metal parts, even parts exposed to high temperatures
6440143 – Wt. 1.1 lb **17⁹⁹**

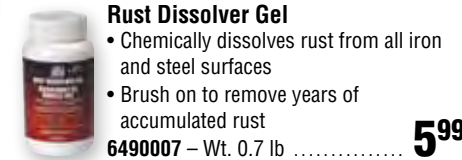

- Rust Dissolver Gel**
• Chemically dissolves rust from all iron and steel surfaces
• Brush on to remove years of accumulated rust
6490007 – Wt. 0.7 lb **5⁹⁹**



- Meltz All Ice Melter**
8143281 – Wt. 12.6 lb **7⁹⁹**

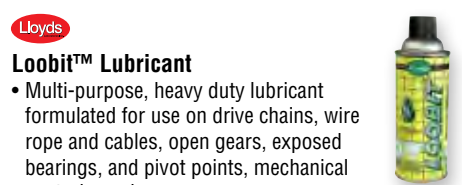

- Loobit™ Lubricant**
• Multi-purpose, heavy duty lubricant formulated for use on drive chains, wire rope and cables, open gears, exposed bearings, and pivot points, mechanical controls, and more
• Leaves a clear protective film impervious to moisture, salt water, most chemicals and gases
6420014 – Wt. 1.0 lb **9⁹⁹**

Paint



3.8 Litre Tractor & Implement Paint

Colour	Wt. (lb)	ITEM	PRICE
Flat Black	9.2	8306383	49.99
Harvester Red	9.2	8306441	49.99
Gloss Black	9.2	8306391	49.99
Deere Yellow	9.2	8306417	49.99

- Fast drying enamel spray paint suitable for interior or exterior applications
- Use on metal or wood, recoat anytime
- Non-fading



All Purpose Spray Paint

Colour	Grams	Wt. (lb)	ITEM	PRICE
Clear	1.0	1.0	8057242	5.99
Clear	1.0	1.0	8057259	5.99

Sandable Spray Primer

Colour	Grams	Wt. (lb)	ITEM	PRICE
Red Oxide	1.0	1.0	8057267	5.99
Grey	1.0	1.0	8057275	5.99

Anti-Rust Spray Paint

- Interior and exterior rust protection
- Can be applied to metal or wood
- Ideal for shop equipment such as ramps, stands and jacks, as well as outdoor furniture plus lawn and garden equipment
- Gasoline and oil resistant
- Quick drying and can be recoated anytime



Colour	Grams	Wt. (lb)	ITEM	PRICE
Gloss Black	340	1.0	8057374	5.99
Flat Black	340	1.0	8057382	5.99
Gloss White	340	1.0	8057408	5.99
Red	340	1.0	8057424	5.99
Aluminum	340	1.0	8057432	5.99

High Heat Paint

- Formulated to resist temperatures up to 800°C (1,500°F)
- Properly cured, Hi-Temp paint forms a hard lasting finish that resists salt spray and humid conditions
- Use on headers, exhaust manifolds, BBQs, wood stoves and other surfaces exposed to high heat



Colour	Grams	Wt. (lb)	ITEM	PRICE
Black	312	0.9	8057325	5.99
White	312	0.9	8112567	5.99
Aluminum	312	1.0	8112559	5.99

Fluorescent Orange Spray Paint

- Fast drying paint that can be used on wood, metal and paper
- Ideal for safety markings and warning signs or anywhere high visibility intense colour is needed
- 312 g

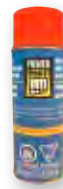

8072597 – Wt. 1.0 lb **6.99**

Tractor & Implement Enamel

- Matched to the factory colours of leading farm and industrial equipment manufacturers
- Durable weather resistant gloss finish is also formulated to protect against rust
- Gasoline and oil resistant



Colour	Grams	Wt. (lb)	ITEM	PRICE
New Equipment Yellow	340	1.0	8057333	6.99
Harvester Red	340	1.0	8057341	6.99
John Deere® Green	340	1.0	8057358	6.99
Ford® Tractor Blue	340	1.0	8057366	6.99
John Deere® Yellow	340	1.0	8108250	6.99
Old Equipment Yellow	340	1.0	8108268	6.99

Industrial Chemicals



Graffiti Remover

Effective in removing vandalism marks while leaving the original surface intact
8180499 – Wt. 1.0 lb **8.99**



Stainless Steel Cleaner

- Protects against stains, wear and abrasions on stainless steel, aluminum and plastic laminate
- Provides an invisible glove to keep surfaces shiny and impervious to fingerprints and scuff marks

8180481 – Wt. 1.0 lb **7.99**



Brush On Electrical Tape

Waterproofs connections, seals out moisture and corrosion
8037103 – Red
8037095 – Black
 Wt. 0.3 lb **7.99** /ea



Contact Electrical Cleaner

- For use in servicing, rebuilding and maintaining electrical equipment
 - Ideal for switches, relays, shafts, bearings, armatures and brushes
 - Safe for all metals and most plastics
 - 500g
- 8180507** – Wt. 1.4 lb **7.99**



Moovit Hi-Performance Penetrating Lubricant

Can be used as: air tool lubricant, lock lubricant, threading or tapping oil, chain and open gear lube, corrosion inhibitor, white grease
6420008 – Wt. 1.2 lb **9.99**



Fluid Film

Protects against corrosion caused by salt, calcium chloride, fertilizers, herbicides, and pesticides
6420392 – Wt. 1.0 lb **14.99**



Chain Lube

- Specially formulated to lubricate and protect all types of roller chains operating in exposed conditions
 - High lubricity and foaming action penetrates into rollers and displaces water
 - Will not be thrown off at high speeds
 - Non-tacky formula reduces accumulation of road dust and sand Applications: motorcycle, bicycles, chain saws and any chain-driven vehicle or equipment
- 6440016** – Wt. 1.0 lb **9.99**



Belt Dressing

- Stops belt slippage and squeal
 - Excellent for fan, alternator, power steering and air conditioner drives
 - 450g aerosol can
- 8131179** – Wt. 1.1 lb **9.99**



Gasket Makers & Sealants



Thread Lockers

Red Permanent Strength

Prevents vibration loosening and protects threads from corrosion
6440127 – Wt. 0.1 lb **7⁹⁹**



Blue Removable Strength

Protects threads from corrosion and vibration loosening
6440007 – Wt. 0.1 lb **7⁹⁹**



Medium Strength Blue Gel

Allows fasteners to be removed with hand tools and normal effort
8051567 – Wt. 0.1 lb **12⁹⁹**



Red High Temp / High Strength

For heavy duty applications
6440008 – Wt. 0.1 lb **12⁹⁹**



Gasket Makers & Sealants

Superior adhesion to oily surfaces with long term durability

	Description	Wt. (lb)	ITEM	PRICE
A	Ultra Black® RTV	0.3	6400002	8.99
B	Ultra Copper® RTV High-Temperature	0.2	6400004	8.99
C	300 ml Ultra Black	1.0	8116816	17.99

Resists auto and shop fluids

	Description	Wt. (lb)	ITEM	PRICE
D	Blue RTV	0.2	6400006	4.99
E	Black	0.2	8116857	5.99
F	Hi Temp Red	0.2	8116865	5.99



Gasket Makers & Sealants

Use for sealing, bonding, insulating and caulking

	Description	Wt. (lb)	ITEM	PRICE
G	Black RTV Silicone	0.2	8116832	5.99
H	Clear RTV Silicone	0.2	8116840	5.99
I	Red High Temp RTV	0.2	6400030	6.99

High Temperature Thread Sealant

Designed to provide an extremely reliable seal on any metal pipe thread fittings and plugs
6400048 – Wt. 0.2 lb **16⁹⁹**



AD3000 Corrosion Barrier Film

Helps protect vehicle door panels, hood and trunk lids, machinery and tools from condensation and salt
6420013 – Wt. 1.0 lb **10⁹⁹**



Gasket Material

- 1/16" x 2 ft x 3 ft roll
- Oil, fuel and antifreeze resistant

8019636 – Wt. 3.1 lb **14⁹⁹**

AD2000 Corrosion Inhibitor

Prevents and deactivates corrosion on metals, alloys, plastic and rubber
6420010 – Wt. 1.0 lb **11⁹⁹**



Thread Sealant with Teflon®

Resists pressure in air, oil, diesel, fuel and hydraulic systems
6400055 – Wt. 0.4 lb **8⁹⁹**



Adhesives



J) One-Use Clear Epoxy Syringe

Adheres to wood, metal, tile, ceramics, glass, and plastic
8298846 – Wt. 0.1 lb **4⁹⁹**

K) Ultra Bond™ Super Glue

Fast setting, strong adhesive for bonding most materials
6440119 – Wt. 0.1 lb **4⁹⁹**

L) Pit Crew's Sealant/Adhesive

Repairs tears in seats and floor mats, secures loose trim, seals small tears in hoses
8193260 – Wt. 0.2 lb **5⁹⁹**

M) Cold Weld Bonding Compound

Fast setting 2-part adhesive and filler system used as an alternative to welding or brazing cracked or broken metal parts
6440010 – Wt. 0.1 lb **6⁹⁹**

N) Cold Weld

Convenient and inexpensive alternative to welding, soldering and brazing
8298861 – Wt. 0.2 lb **7⁹⁹**

O) Cold Weld Putty Stick

Plugs holes and make repairs on wet and dry surfaces; will cure under water and gasoline
8298994 – Wt. 0.2 lb **7⁹⁹**

P) Kwik Weld

Quick-setting formula ideal for household maintenance and repairs
8298937 – Wt. 0.2 lb **7⁹⁹**



Automotive Chemicals



Automotive Chemicals

A) Power Steering Fluid
Non-corrosive, non-foaming formula for most domestic and foreign vehicles
8295024 - Wt. 1.1 lb 4.99

B) Injector Plus™ Super Concentrated Fuel Injector Cleaner
One treatment cleans fuel injector and intake valves Restores lost power Increases fuel economy
8153512 - Wt. 0.8 lb 4.99

C) Stop Leak Radiator Sealer
Repairs cooling system leaks
8295016 - Wt. 0.9 lb 3.49

D) Chlorinated Brake Cleaner
• Cleans and degreases disk and drum brakes
• Dissolves and removes brake fluid, oil, grease, and other contaminants
• Environmental formula - No VOCs
6420083 - Wt. 1.4 lb 4.99

E) Engine Brite® Heavy Duty Engine Degreaser
Heavy duty cleaning formula is packed with powerful degreasing solvents that quickly and easily remove the toughest grease, dirt and grime
8005026 - Wt. 1.3 lb 4.49



F) Ace Starting Fluid
Priming fluid formulated to spray at sub-zero temperatures
8223893 - Wt. 0.6 lb 3.29

G) Emission Klean
Reduces carbon monoxide, nitrous oxide and hydrocarbon emissions
8201501 - Wt. 0.8 lb 4.99

H) Brake Klean
Instantly removes brake fluid, oil and dust from drum and disc brake parts
8095507 - Wt. 1.6 lb 4.99

I) Radiator Flush
Contains corrosion inhibitor complex that remains in the radiator to prevent future corrosion and an antioxidant to counteract pitting
8294894 - Wt. 1.2 lb 3.49

J) Diesel Fuel Conditioner
Prevents stalling and frozen fuel lines
8050445 - Wt. 2.0 lb 5.99

K) Choke & Carb Klean
Concentrated carburetor cleaner that rapidly removes fuel gum and varnish to maximize gasoline economy and performance
8050528 - Wt. 1.2 lb 5.99

L) Brake Fluid
For drum, disc, ABS braking systems and clutch systems requiring a Department of Transportation 3 type fluid (DOT 3)
8294563 - Wt. 1.3 lb 5.99

M) Tumbler Paintable Rubberized Undercoating
Fast-drying, paintable and exceptionally resistant to abrasions
8050544 - Wt. 1.6 lb 8.99

N) Armashine™ Tire Foam
Cleans, shines and protects tires in minutes
8242810 - Wt. 1.7 lb 6.99



4 Litre Windshield Washer Fluid
Good to -35°C
8249211 - Wt. 8.4 lb 2.49



O) Breeze Sicle Odour Neutralizer
Quickly eliminates odours in residential, commercial and industrial areas
8150583 - Wt. 1.2 lb 4.99

P) Glass Klean
Ideal for auto, marine, fleet and home use
8172348 - Wt. 1.7 lb 4.99

Q) Headlight Lens Restorer
Restores optical clarity
8239543 - Wt. 0.7 lb 7.99

R) Liquid Metal Polish
For use on chrome, aluminum, copper, brass, gold, silver etc.
8237711 - Wt. 0.7 lb 6.99

S) Multi-Kleen Plus Cleaner
Advanced formula is super concentrated, non-abrasive and readily biodegradable
8229361 - Wt. 2.3 lb 5.99

Antifreeze / Coolant
U) RV Plumbing Antifreeze
8354847 - Wt. 8.7 lb 4.99

V) Extended Life Diesel Antifreeze / Coolant
Recommended for use in heavy duty diesel on-road truck, off-road, marine, farm and stationary machines
8294423 - Wt. 9.9 lb 14.99

W) Universal Antifreeze / Coolant
Suitable for all vehicles, including older model domestic & foreign cars and light duty trucks
8294399 - Wt. 9.7 lb 13.99

X) Universal 50/50 Premixed Antifreeze / Coolant
Suitable for all vehicles, including older model domestic & foreign cars and light duty trucks
8294415 - Wt. 9.3 lb 9.99



Y) Fuel Stabilizer
• Formulated to keep fuel fresh during storage
• Prevents formation of gum, tarnish, rust and corrosion
8210585 - Wt. 0.7 lb 4.99

Z) Engine Fogger
Protects engines against rust and corrosion during storage
8210577 - Wt. 1.0 lb 7.49

WHMIS
WHMIS, short form for Workplace Hazardous Materials Information System, is a nation wide system that was developed to provide a standardized classification system for the control, safe handling, storage, and disposal procedures of hazardous materials in the workplace. The product label is your first source of information about the hazards of a product and how to protect yourself. Controlled (hazardous) products from suppliers must display a WHMIS label with a hatched border.

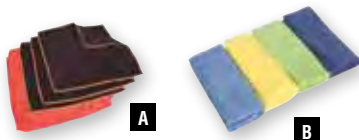

Microfibre Cloths

- Traps dust and leaves a streak free shine
- Use damp for chemical free window cleaning
- Reusable, machine washable

A) 5 pk
8153595 – Wt. 0.4 lb **4⁹⁹**

B) 4 pk
8293730 – Wt. 0.3 lb **5⁹⁹**



Shop Supplies

C) Shop Max Towel Rolls

Ideal for the shop or garage; strong enough for oil, grease and solvents
8297905 – Wt. 0.7 lb **2⁹⁹**

D) 10 Pack Red Shop Towels
8226490 – Wt. 0.6 lb **4⁹⁹**

E) 30 Microfuse 10" Towels
Lasts 5 times longer than paper towels
8290215 – Wt. 0.6 lb **6⁹⁹**

F) 10 lb Shop Rags
Prewashed cotton material
3890892 – Wt. 10.2 lb **13⁹⁹**

G) 50 pk Shop Towels
Heavy duty lint free cotton for polishing, paint clean-up, general shop, and household use
3890581 – Wt. 3.0 lb **19⁹⁹**



Gojo Natural Orange Hand Cleaner

- For medium to heavy duty soils including resins, oil, grease, tar, grime, soil, printer's ink, epoxies, paint, rubber cement, gasket, and tile epoxies
- Also works great on laundry stains, scuff marks, tile floors, pet odours and other household cleaning need

	Size	Wt. (lb)	ITEM	PRICE
H	414 ml	1.1	6420285	3.99
I	1.89 litre	4.7	6420293	9.99
	3.78 litre	9.1	8024407	14.99
J	3.78 litre (Non-pumice)	8.6	8144867	14.99

Gojo Hand Cleaner

For medium soils including resins, oil, grease, tar, grime, soil, printer's ink, epoxies, paint, rubber cement, gasket and tile cements
6420251 – Wt. 1.2 lb **3⁹⁹**

25 Pack Gojo Hand Towels

Textured, non-scratching weave on one side is ideal for cleaning heavy duty soils from hands, tools and work areas, reverse side is smooth for general purpose cleaning
8001933 – Wt. 0.5 lb **5⁹⁹**



Fastorange Handsoap with Pumice

Removes oil, grease grime, paint and everyday soils
8072084 – Wt. 0.4 lb **2⁹⁹**

Permatex Blue Label Hand Cleaner

For oil, grime, soil, resins, ink, paint, cement, gasket and tile adhesives
8070831 – Wt. 4.8 lb **14⁹⁹**

Trounce® Hand Cleaner

For oil, grease, tar, grime, soil, resins, printer's ink, epoxies, paint, tiles, cement and stains
8070849 – Wt. 5.0 lb **14⁹⁹**



Ultrasorb All Purpose Absorbent

- Absorbs oil, grease, water, coolant, and more
 - Can also be used as an animal litter, potting soil, traction aid, and odour control material
- 6490011 – Wt. 33.7 lb **14⁹⁹**

12" Silicone Squeegee

Special silicone blade reduces friction compared to conventional towel or chamois
8304230 – Wt. 0.6 lb **7⁹⁹**

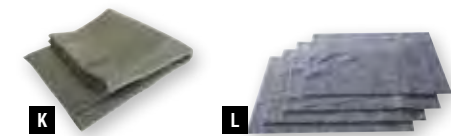

Drawer Liners

Prevents tools from shifting and sliding
K) Anti-Slip Drawer Liner
2 ft x 4 ft
8058424 – Wt. 1.0 lb **8⁹⁹**

L) 4 pc PVC Tool Chest Drawer Liners
22" x 16"
8006682 – Wt. 1.2 lb **11⁹⁹**



M) Rear View Mirror Repair Kit

Permanently bonds rear view mirror button to windshield adhesive kit in minutes
8161275 – Wt. 0.1 lb **7⁴⁹**

N) Windshield Repair Kit

- Repairs most types of damaged laminated windshield glass
- Repairs bullseyes, star damage and cracks up to 12" in length

8161242 – Wt. 0.1 lb **14⁹⁹**

O) Vinyl & Leather Repair Kit

Repairs tears, holes, burns and gouges
8193252 – Wt. 0.3 lb **11⁹⁹**

Repair Kits

P) Lens Restoration Kit

Restores clarity to clouded, pitted and yellowed lenses improving light output and appearance
8087280 – Wt. 0.2 lb **16⁹⁹**

Q) Plastic Tank Repair Kit

For quick, permanent repairs to plastic tanks (not for use on plastic fuel tanks)
8161176 – Wt. 0.2 lb **16⁹⁹**

R) Metal Fuel Tank Repair Kit

For quick, permanent repairs to metal fuel tanks (not for use on plastic tanks) in 30 minutes
8161184 – Wt. 0.2 lb **14⁹⁹**

Air Compressors & Tools

pro.point
hard.working.tools.



EXCLUSIVELY AT: **PRINCESS AUTO**



P/N: 8275158

EMPOWERING

Rotate Car Tires, Sharpen Lawnmower Blades, Inflate Bike Tires, Free the Stubborn Engine Block Bolts. Metalwork on that old Tractor. Trim Gutters to Size, Repair, Refinish, Rebuild Furniture, Build Bird Feeder...

Powermate



P/N: 8275158

P/N: 8275133

P/N: 8281453

P/N: 8275141

Powermate® compressors available at Princess Auto



Air Compressors



Portable Air Compressors

	Description	Tank Cap. (gal.)	CFM @ PSI	HP (Running)	Max. Pressure (PSI)	Motor (volt)	Wt. (lb)	ITEM	PRICE
A	Hot Dog Style	1.6	1.7 / 1.1 CFM @ 40 / 90 PSI	1.3	115	110	37.6	8260671	149.99
B	Horizontal Style	5.7	4.9 / 3.6 CFM @ 40 / 90 PSI	2	125	110	57.0	8260697	199.99
C	Twin Stack	3.14	4.9 / 3.6 CFM @ 40 / 90 PSI	2	125	110	56.4	8260705	189.99
D	Pancake Style	3.4	4.9 / 3.6 CFM @ 40 / 90 PSI	2	125	110	55.1	8260713	179.99
E	Oil Free Compressor	11	6.0 / 4.0 CFM @ 40 / 90 PSI	1.5	125	120	56.0	8275133	349.99
F	Cast Iron Oil Lubricated Belt Drive	20	7.0 / 5.7 CFM @ 40 / 90 PSI	1.9	155	120/140	166.0	8275141	699.99
G	Oil Free Direct Drive	27	7.7 / 6.0 CFM @ 40 / 90 PSI	1.9	155	120	116.0	8281453	499.99



Stationary Air Compressors

Cast iron pump

	Tank Cap (gal.)	CFM @ PSI	HP	# of Cylinders	# of Stages	Max. Pressure (PSI)	Motor (volt)	Wt. (lb)	ITEM	PRICE
A	60	13.4/11.5 CFM @ 40 / 90 PSI	3.7	2	1	155	240	130	8275158	749.99
B	60	18.5 CFM @ 100 PSI	5	3	1	140	208 / 230	300	8355182	999.99
C	80	18.0/16.9 CFM @ 100 /175 PSI	5	2	2	175	230	554	8346645	1799.99
D	120	35/31 CFM @ 100 /175 PSI	10	4	2	175	208 / 230	935	8346652	2499.99
D*	120	35/31 CFM @ 100/175 PSI	10	4	2	175	575	935	8347783	2599.99
D*	120	35/31 CFM @ 100/175 PSI	10	4	2	175	230	935	8347767	2999.99

*Special order. See your nearest Princess Auto location or call 1-800-665-8685 for details.



Gas Powered Air Compressors

- Cast iron pump
- Honda engine



	Tank Cap. (gal.)	HP (Running)	CFM @ PSI	# of Cylinders	# of Stages	Max. Pressure (PSI)	Wt. (lb)	ITEM	PRICE
E	10	5.5	13.8 / 11.7 CFM @ 40 / 90 PSI	2	1	125	208.0	8356677	1199.99
F	10	9	18.5 / 16 CFM @ 100 / 140 PSI	3	1	140	235.0	8356669	1599.99
G	30	11	18.0 / 16.9 CFM @ 100 / 175 PSI	2	2	175	440.0	8356685	2199.99

Compressor Pumps & Tanks



Air Compressor Tanks

Comes with wheel mounts

H) 20 Gallon

- Max. pressure: 125 PSI
- Tank size: 14" x 33"

0430603 – Wt. 66.9 lb **319⁹⁹**

I) 60 Gallon

- Max. pressure: 150 PSI
- Tank size: 20" x 48"

8068876 – Wt. 135.0 lb **479⁹⁹**



Portable Air Tanks

- Includes gauge, 4 ft hose and tire chuck
- Max. pressure: 125 PSI

Cap. (US)	Size	Wt. (lb)	ITEM	PRICE
5 Gal.	10-1/4"w x 14-5/8"l x 13"h	15.7	8155459	49.99
7 Gal.	10-1/2"w x 22"l x 13"h	18.8	8155467	59.99
11 Gal.	12-1/4"w x 25"l x 14-3/4"h	27.7	8155491	74.99



Air Compressor Oil

- ISO 68, SAE 25 weight oil
- For single or 2-stage compressors

1 Litre 8002412 – Wt. 2.1 lb **5⁹⁹**

4 Litre 8039268 – Wt. 8.1 lb **19⁹⁹**



New Rolair Compressor Pumps

Coming Soon!



See princessauto.com for more details!

Magnetic Starters & Heaters

PEAK VS NET HORSEPOWER RATINGS

Princess Auto advertises our engines in peak or gross horsepower which is different than actual net HP ratings.

The net horsepower is defined as the measured output of the engine at the crankshaft end which would also be defined as the true horsepower of the engine.

The peak or gross horsepower would be the horsepower the engine would produce working at peak efficiency in relatively idealistic atmospheric conditions.

In all cases the net horsepower should be less than the peak/gross horsepower.

Magnetic Heaters

HP	Phase	Volts	Amps	Heater Rating (Amps)	# of Heaters Required	Use with Starter	Use with Compressor	Wt. (lb)	ITEM	PRICE
5	1	230	22	20.9-23.1	1	8050775	8346645 8048381	0.1	8050940	12.99
10	3	230	26.8	23.4-27.9	3	8050775 8050783	8346652 8064198	0.1	8050957	12.99
10	3	460	13.4	12.3-14.4	3	8050783	8346652 8064198	0.1	8051054	12.99
10	3	575	10.3	9.75-10.7	3	8050783	8347783	0.1	8050726	12.99



Pressure Switches

- Diaphragm actuated, suitable for air compressor applications
- Pressure switches have CEMA 1 enclosures, 1/4" female NPT ports

Adjustable Pressure Range (PSI)	Factory Off Setting (PSI)	Pressure Differential (non-adjust.)	Cut-Out Lever	Bleeder Valve	Single Phase HP Rating		Wt. (lb)	ITEM	PRICE
					115 VAC	230 VAC			
40-100	100	20	Auto-off	Yes	1.5 HP	2 HP	0.9	8054454	34.99
70-150	125	30	Auto-off	No	1.5 HP	2 HP	0.9	8054447	24.99
70-150	125	30	Auto-off	Yes	1.5 HP	2 HP	0.9	8050742	34.99
100-200	175	40	No	No	1.5 HP	2 HP	0.9	8050759	24.99
80-250	150	*24-45	No	Yes	2 HP	3 HP	2.0	8067209	79.99

*Adjustable



Pressure Switches

- 1/4" NPT female ports
- 4-way valve
- On / Off switch and bleeder valve
- Single-phase rating: 1.5 HP @ 115 VAC, 3 HP @ 230 VAC

Adjustable Pressure Range (PSI)	Factory Setting (PSI)	Wt. (lb)	ITEM	PRICE
20-135	80-115	1.0	8131351	24.99
65-175	100-140	1.0	8131377	24.99
105-175	135-175	1.0	8131385	24.99



Air Filters, Regulators & Lubricators

- Max. pressure: 150 PSI
- Temperature range: 5°C to 60°C
- 20 micron filters
- Acetate filter and lubricator bowls, 4 oz cap.
- Diaphragm type regulators

Type	Port Size	Flow Rating	Wt. (lb)	ITEM	PRICE	
A	Filter*	1/4" NPT	60 CFM	0.8	8185068	24.99
	Filter*	3/8" NPT	70 CFM	0.8	8185076	24.99
	Filter*	1/2" NPT	100 CFM	0.8	8185092	24.99
B	Regulator	1/4" NPT	60 CFM	1.2	8185035	29.99
	Regulator	3/8" NPT	80 CFM	1.2	8185043	29.99
C	Regulator	1/2" NPT	100 CFM	1.2	8185050	29.99
	Lubricator	3/8" NPT	65 CFM	0.8	8185126	19.99

Replacement Air Filter Element

For air filters 8185068, 8185076, and 8185092

0470682 - Wt. 0.1 lb **4⁹⁹**



Combination Air Filter & Regulator

- Air inlet: 1/2" NPT (female)
- Air outlet: 1/4" NPT (male)
- Max. air flow: 50 CFM
- Max. pressure: 150 PSI
- Max. temp.: 65°C

8006307 - Wt. 6.5 lb **89⁹⁹**

Air Filtration



Industrial Air Filter, Regulator & Lubricator

- Lightweight aluminum housing
- 1/2" NPT ports

Type	Flow Rating	Pressure	Operating Temperature	Wt. (lb)	ITEM	PRICE
D	Filter	100 CFM	0 to 250 PSI (40 to 160°F)	1.9	8138869	59.99
E	Regulator	100 CFM	10 to 250 PSI (40 to 120°F)	1.1	8139107	69.99
F	Lubricator*	142 CFM	0 to 200 PSI (40 to 160°F)	1.7	8139081	69.99

*Metal bowl with sight glass



Air Pressure Regulators

- Operates from 0 to 130 PSI
- 60 CFM @ 100 PSI
- Reads 0 to 230 PSI
- 1/4" NPT ports

G) Regulator with Gauge **29⁹⁹**

0470006 - Wt. 0.4 lb

H) Regulator with Gauge & Shut-Off Valve **34⁹⁹**

0450022 - Wt. 0.3 lb



Desiccant Air Dryer

- Max. air flow: 17 CFM
- Max pressure: 175 PSI
- 1/2" NPT ports
- The only maintenance required is replacement of drying pellets every six months (pellets sold separately 0470011)
- Eliminates moisture from air supply for sandblasting and air tools
- Recommended for quality spray painting
- NOT DESIGNED FOR USE WITH BREATHING AIR
- NOT FOR COMMERCIAL APPLICATIONS

8055757 – Wt. 14.0 lb **89⁹⁹**



Air Dryer Pellets

For use with desiccant air dryers
 0470011 – Wt. 2.2 lb **34⁹⁹**



In-Line Desiccant Air Dryer

- Removes nearly all traces of dirt, dust, water vapour and oil vapour from compressed air
- Disposable and replaceable silica gel desiccant changes from blue to dark pink when the filter needs to be replaced
- Maximum: 5 CFM @ 125PSI
- Ideal for use with spray guns, blow guns or any tool where dry air is critical
- Temperature range: 5° to 54°C
- 1/4" NPT inlet
- WARNING: This filter will collect moisture which could freeze and rupture if used below 0°C (32° F)

8105470 – Wt. 0.4 lb **14⁹⁹**

2 pc Replacement Desiccant

For desiccant air dryer 8105470
 8122236 – Wt. 0.1 lb **4⁹⁹**



Air Filtration

1/4" NPT ports



In-Line Oiler

Prevents air line contamination, tool burn out and rust
 8038777 – Wt. 0.3 lb **9⁹⁹**



Air Line Filter

Lightweight, can be installed on airtools
 0470012 – Wt. 0.1 lb **4⁹⁹**



In-Line Filter

Max. pressure: 150 PSI
 0470035 – Wt. 0.4 lb **9⁹⁹**



In-Line Air Regulator

8159493 – Wt. 0.2 lb **8⁹⁹**

Oil & Water Separator

- Max. pressure: 125 PSI
 - Attaches in the airline between air supply and tool
- 0433359 – Wt. 0.3 lb **9⁹⁹**

Gauges



2" Air Pressure Gauges

A) BACK MOUNT

Metal back
 Wt. 0.2 lb

B) BOTTOM MOUNT

	Reading (PSI, kg/cm2)	Thread Size (NPT)	ITEM	PRICE
A	0-160, 0-11	1/8"	8070344	5.99
	0-160, 0-11	1/4"	8070310	5.99
	0-200, 0-14	1/4"	8070328	5.99
B	0-100, 0-7	1/4"	8070336	5.99
	0-160, 0-11	1/4"	8070351	5.99
	0-200, 0-14	1/4"	8070369	5.99
	0-300, 0-21	1/4"	8070377	5.99

Fittings & Couplers

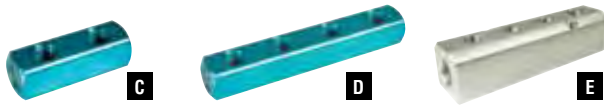

Air Manifolds

All outlet ports are 1/4" NPT

	Manifold Size	Working Pressure 2:1 Safety Ratio	Inlet Port	# of Outlet Ports	Wt. (lb)	ITEM	PRICE
C	1/2"	120 PSI	1/4" NPT	2	0.1	0430424	4.49
D	1/2"	120 PSI	1/4" NPT	4	0.3	0430426	6.99
E	1"	200 PSI	1/2" NPT	4	1.1	0430429	19.99

Air Tank Manifold

- 1/2" NPT male tank mount
 - 125 PSI safety relief valve
- 8043663 – Wt. 0.3 lb **12⁹⁹**



Auto / Manual Air Tank Drain

Max. pressure: 300 PSI
 8062622 – Wt. 0.4 lb **22⁹⁹**

Air Compressor Governor / Unloader

- For gas engine compressors
- Releases unused air for continuous running applications
- Idles engine down when tank is full

0430471 – 5 HP
 0430469 – 10 HP
 Wt. 1.1 lb **79⁹⁹/ea**



Swivel Quick Couplers

- Convenient all in one design eliminates need for separate swivel fitting and quick coupler
- 1/4" NPT in both male and female thread types

8064552 – A Style Male
 8061806 – M Style Male
 Wt. 0.1 lb **5⁹⁹/ea**



Swivel Adapter

- 1/4" NPT connections
 - Max. pressure 150 PSI
 - Steel construction
- 0434019 – Wt. 0.2 lb **9⁹⁹**



Air Restrictor Valve with Gauge

Gauge reads: 0 to 160 PSI and 0 to 11 kg/cm2
 0430074 – Wt. 0.3 lb **9⁹⁹**



2" Vacuum Gauge

- Dial reads 0 to 30 in-Hg
 - 1/4" NPT bottom connection
- 8070385 – Wt. 0.2 lb **7⁹⁹**



Got a question

about one of our products?



Post a customer review at princessauto.com! We'll answer the question for your benefit and for other guests.



Coiled Polyurethane Air Hose

- Max. pressure: 200 PSI
- Softer and more pliable than nylon
- Superior retention quality and will not lose its "recoilability"
- Stays soft and will not kink
- 1/4" NPT fittings

1/4" x 25 ft
0431205 – Wt. 1.0 lb **13⁹⁹**

3/8" x 25 ft
8041479 – Wt. 1.4 lb **14⁹⁹**



Coiled Nylon Air Hose

- Max. working pressure: 200 PSI
- Operating temperature: -40°C to 82°C
- Spring guards
- Resists oil, grease, corrosion, and abrasion
- 1/4" NPT male fittings



I.D.	Length	Wt. (lb)	ITEM	PRICE
1/4"	12-1/2 ft	0.4	0430275	12.99
1/4"	25 ft	0.6	0430276	17.99
1/4"	50 ft	1.0	0430277	24.99
3/8"	25 ft	1.2	0430281	29.99



Coiled Polyurethane Air Hose

- Max. pressure: 160 PSI
- Operating Temperature: -40° to 82°C
- Flexible in a wide range of weather conditions
- Canadian made, industrial quality
- Lightweight and compact
- 1/4" NPT fittings



I.D.	Length	Wt. (lb)	ITEM	PRICE
1/4"	15 ft	0.9	8134504	19.99
1/4"	25 ft	1.2	8134538	25.99
1/4"	50 ft	2.0	8134553	39.99
3/8"	25 ft	2.6	8134603	39.99



2-1/2 ft x 3/8" Swivel End Whip Hose

- Max. pressure: 300 PSI
 - 1/4" NPT female fixed connection on one end and 1/4" NPT male swivel connection on other
- 0430018 – Wt. 0.4 lb **9⁹⁹**



Industrial PVC Whip Hose

- Max. pressure: 300 PSI
- Ideal when you need a short length of ready made hose
- 1/4" NPT male fittings on both ends



Length	Wt. (lb)	ITEM	PRICE
25"	0.3	0430333	5.99
60"	0.6	0430334	6.99
75"	0.7	0430335	7.99

Air Hose

TRADEFLEX™

Kurl Tec Industrial PVC Air Hose

- Max. pressure: 300 PSI
- Lighter than rubber
- Silicone free, oil resistant
- Non-marking



I.D.	Inlet	Length	Wt. (lb)	ITEM	PRICE
1/4"	1/4" NPT	15 ft	1.1	0430450	9.99
1/4"	1/4" NPT	25 ft	1.8	0430204	13.99
1/4"	1/4" NPT	50 ft	3.5	0430208	24.99
3/8"	1/4" NPT	15 ft	1.5	0430452	9.99
3/8"	1/4" NPT	25 ft	2.7	0430058	14.99
3/8"	1/4" NPT	50 ft	4.5	0430066	24.99
3/8"	1/4" NPT	100 ft	9.6	8004456	49.99
3/8"	3/8" NPT	25 ft	2.5	0430210	16.99
3/8"	3/8" NPT	50 ft	5.1	0430209	26.99
1/2"	1/2" NPT	25 ft	3.6	0430212	23.99
1/2"	1/2" NPT	50 ft	7.0	0430213	39.99

GOOD YEAR

Industrial Rubber Air Hose

- Max. pressure: 300 PSI
- Operating temperature: -40°C to 88°C
- Abrasion and kink resistant synthetic rubber construction with spiral yarn reinforcement
- Remains flexible at low temperature
- 1/4" NPT male fittings



I.D.	Length	Wt. (lb)	ITEM	PRICE
1/4"	25 ft	3.1	8003885	27.99
1/4"	50 ft	5.7	8003894	44.99
3/8"	25 ft	4.8	8003910	29.99
3/8"	50 ft	9.5	8003929	49.99
3/8"	100 ft	19.9	8003938	79.99
1/2"	25 ft	6.6	8039552	39.99
1/2"	50 ft	12.1	8039543	79.99



Tundra PVC Air Hose

- Max. pressure: 300 PSI
- Temperature range: -40° to 65°C
- Tough and flexible at very low temperatures
- Abrasion and oil resistant, non-marking
- 1/4" NPT threaded male fittings



I.D.	Length	Wt. (lb)	ITEM	PRICE
1/4"	25 ft	2.0	8351041	19.99
1/4"	50 ft	4.0	8351058	29.99
3/8"	25 ft	2.7	8351066	24.99
3/8"	50 ft	5.4	8351082	39.99
3/8"	100 ft	10.0	8351090	69.99

Air Hose Reels

23 ft x 5/16" Retractable Air Hose Reel

- Max. pressure: 180 PSI
 - Polyurethane hose
 - Wall or ceiling mount with 180° bracket
 - Positive latching mechanism which automatically locks hose at desired length
- 8298044** – Wt. 6.3 lb **49⁹⁹**



40 ft x 3/8" Retractable Air Hose Reel

- Max. pressure: 150 PSI
 - Rubber hose
 - 1/4" male NPT fittings
- 8000916** – Wt. 17.2 lb **99⁹⁹**



50 ft x 3/8" Industrial Retractable Air Hose Reel

- Max. pressure: 300 PSI
 - PVC hose
 - Closed style impact resistant polypropylene housing
 - 3/8" NPT inlet
- 8001538** – Wt. 23.6 lb **139⁹⁹**



50 ft x 3/8" Retractable Air Hose Reel

- Max. working pressure 300 PSI
 - Rubber hose
 - Can mount on ceiling, wall, bench, or truck
 - 4 direction non-sag rollers reduce hose wear
 - Open style corrosion resistant powder coated steel housing
- 8025291** Wt. 40.2 lb **149⁹⁹**



Hand Crank Air Hose Reel

- Max. pressure: 300 PSI
 - Holds 100 ft of 3/8" I.D. or 50 ft of 1/2" I.D. hose
 - Durable steel construction
 - 1/4" NPT brass swivel inlet
- 8000539** – Wt. 9.0 lb **19⁹⁹**



Hand Crank Air Hose Reel

- Max. pressure: 300 PSI
 - Spring tension brake
 - Steel construction with corrosion resistant powder coating
- Holds 50 ft of 3/8" I.D. Hose**
8002145 – Wt. 8.9 lb **49⁹⁹**



- Holds 100 ft of 3/8" I.D. Hose**
0430377 – Wt. 10.9 lb **59⁹⁹**

25 ft x 3/8" Open Industrial Retractable Air Hose Reel

- Max. working pressure 300 PSI
 - PVC hose
 - Steel construction, corrosion resistant powder coating
 - Can be mounted on ceiling, wall, bench, or truck
 - 4 direction non-sag rollers reduce hose wear
- 8000520** – Wt. 22.2 lb **99⁹⁹**



PRINCESS AUTO

Welcome to our Unique World!

Home of an outstanding shopping experience, every time!

Sandblasting



100 lb Pressure Sandblaster

- Pressure blasters use 1/3 the sand and considerably less air than a siphon fed sandblaster
 - When the shut-off valve on the nozzle is opened, the air / sand mixture comes out under tremendous force
 - Quick-release deadman valve stops immediately if the operator's grip slips or the unit is dropped
 - "Lift-up" sand filler valve, air inlet valve, pressure gauge, mixing control, relief valve, fixed reinforced sand/air hose, and 2 ceramic 1/8" nozzles
 - 8 ft sand/air hose
 - ASME approved and CRN registered
- 8003897** – Wt. 55.0 lb **549⁹⁹**



Accessories for 100 lb Pressure Sandblaster

- Steel Pivot Seal Block**
6320011 – Wt. 0.1 lb **2⁹⁹**
- 1/2" Ball Valve**
Max pressure - Water, oil, and gas 600 PSI,
Steam 150 PSI
8137044 – Wt. 0.5 lb **7⁹⁹**
- Quick-Release Deadman Valve**
6320005 – Wt. 1.3 lb **23⁹⁹**

Nozzle Selection Chart

Nozzle I.D.	Recommended Compressor Specs			Blasting Area (sq. ft/min.)	Abrasive Usage/Hour	Size	Wt. (lb)	ITEM	PRICE
	HP	CFM	PSI						
3/32"	2 to 3	10	100	3/4	100 lb	3/32"	0.3	6320246	11.99
1/8"	3 to 5	20	100	1-1/2 to 2	175 lb	1/8"	0.3	6320253	11.99
5/32"	5 to 10	30	100	2 to 2-1/2	225 lb	5/32"	0.3	6320261	11.99
3/16"	10 to 15	45	100	3-1/2 to 4	350 lb	3/16"	0.3	8088932	11.99
1/4"	20	80	100	4-1/2 to 5	500 lb	1/4"	0.3	6320543	11.99

WARNING

Always use proper safety equipment.

A) 10 Gallon Pressure Sandblaster

- 6 to 25 CFM @ 65 to 125 PSI
- Pressurized design gives 30% more blasting power than siphon blasters
- Deadman style sandblasting gun, 8 ft heavy duty hose (3/8" I.D.) and 4 interchangeable nozzles

8003841 – Wt. 47.7 lb **249⁹⁹**

B) 5 Gallon Siphon Sandblaster

- 5.8 CFM @ 90 PSI
- Removes paint, scale, rust, or graffiti quickly and easily
- Can be used with most types of sandblasting abrasives

8012660 – Wt. 12.7 lb **79⁹⁹**

3 pk Replacement Sandblasting Nozzles

For siphon sandblaster 8012660
8085839 – Wt. 0.1 lb **8⁹⁹**



C) Replacement Deadman Valve

For sandblaster 8003841
8084923 – Wt. 1.2 lb **17⁹⁹**

D) Replacement Pivot Block

- Rubber attached to an alloy block
- For the replacement deadman valve

8232472 – Wt. 0.1 lb **4⁹⁹**



E) 5 pk Replacement Nozzles

For pressure sandblasters 8089310, 8089302 and 8003841

Size	Wt.(lb)	ITEM	PRICE
2.4 mm (0.095")	0.1	8086290	5.99
2.7 mm (0.110")	0.1	8086274	5.99
2.7 mm (0.110")	0.2	8086258	5.99
3.6 mm (0.142")	0.1	8086308	5.99

3/8" Steel Shut-Off Valve
8232047 – Wt. 0.5 lb **4⁹⁹**



Sandblasting Abrasives

F) Aluminum Oxide – 80 grit
8200578 – Wt. 48.6 lb **44⁹⁹**

G) Bainite Steel Shot
8275414 – Wt. 52.0 lb **39⁹⁹**

H) Glass Beads
8200560 – Wt. 55.3 lb **39⁹⁹**



I) Greengrit Crushed Glass

Wt. 52.0 lb
8200552 – 30-60 Grit **9⁹⁹**
8223794 – 20-35 Grit **/ea**

J) Ebony Grit Abrasive
8200594 – Wt. 55.4 lb **12⁹⁹**

K) Walnut Shells – 18-40 Grit
8275398 – Wt. 50.3 lb **29⁹⁹**



L) 8 pk Window Shields

- Easy peel and stick design
 - Can be cut to fit any size sandblaster cabinet
- 11" x 17" **29⁹⁹**
8055515 – Wt. 0.4 lb **29⁹⁹**
12" x 36" **39⁹⁹**
8006652 – Wt. 1.1 lb **39⁹⁹**



M) Sandblast Cabinet Light

Fits 8046492 and 8014659
8012802 – Wt. 0.6 lb **11⁹⁹**



N) 12V Light Adapter

For use with sandblasting cabinet light 8012802
8012795 – Wt. 1.0 lb **11⁹⁹**



O) 2 pc Replacement Ceramic Nozzles

For sandblasting cabinet 8046492
8026717 – Wt. 0.1 lb **9⁹⁹**

P) Replacement Sandblasting Gloves

For sandblasting cabinet 8046492
8133043 – Wt. 0.8 lb **17⁹⁹**



Pneumatic Spark Plug Cleaner

- Uses your compressed air to clean spark plugs for re-use
 - Operating pressure: 90 PSI
 - Includes abrasive material (36 grit carborundum)
 - 1/4" NPT M-type fitting
- 8261562 – Wt. 1.5 lb **29⁹⁹**



Q) Floor Model Sandblasting Cabinet

- 5 to 15 CFM @ 80 to 120 PSI
 - Heavy steel construction, heavy duty blast gun, plexiglass viewing window
 - Blast rust, corrosion, and paint in an enclosed cabinet to keep dust off the floor and out of the air
 - Interior dimensions: 33.5"L x 22"W x 18"H
- 8046492 – Wt. 92.4 lb **349⁹⁹**

R) Bench Model Sandblasting Cabinet

- 5 to 15 CFM @ 120 PSI
 - For use with glass beads, silica sand, aluminum oxide, and most other abrasives
- 8014659 – Wt. 40.3 lb **249⁹⁹**

Air Brush Kits



6 pc Air Brush Kit

Air brush, air hose, plus 2 glass jars sized 22 ml (3/4 oz) and 60 ml (2 oz)
0470526 – Wt. 0.6 lb **14⁹⁹**



Metal Air Brush Kit

Fine head air brush, 6 ft hose, two 22 ml (3/4 oz) jars with covers, adapter, wrench, 5 ml (1/8 oz) metal cup, and metal hanger
8006582 – Wt. 0.8 lb **39⁹⁹**



Professional Aluminum Air Brush Kit

- 0.5 CFM @ 30 PSI
- 5 ft x 5/32" I.D. polyurethane hose with 1/8" NPT
- Female adapters

8257354 – Wt. 0.6 lb **69⁹⁹**

Digital Spray Gun Air Flow Regulator

- Zinc alloy housing
- Air inlet: 1/4" NPSF x 1/4" NPTM
- Working pressure: 160 PSI (max.)

8243362 – Wt. 0.5 lb **23⁹⁹**

1/4" Air Adjusting Valve with Gauge

- Adjustable from 0 to 160 PSI max.
- Measures and adjusts air pressure at the tool for convenient and accurate pressure regulation
- 1/4" NPTM x 1/4" NPSF fittings

8108847 – Wt. 0.4 lb **16⁹⁹**

ECOTIP

The green way to clean! Crushed glass comes from your curb side recycling box, goes to the processing plant for sorting, crushing, cleaning, screening and packaging. When you blast with crushed glass you are helping preserve our planet.

Feature - The silica in crushed glass is inert. This means when you blast with crushed glass, you will not breathe harmful silica dust

*Taken from Opta Minerals Inc.



A) Gravity Feed Sandblasting Gun

- 7 CFM @ 90 PSI
- Hopper capacity: 18 oz
- 5.0 mm dia. steel nozzle
- Air inlet with 20 mesh screen

8140709 – Wt. 1.3 lb **24⁹⁹**

2 pc Steel Nozzles for 8140709

8367179 – Wt. 0.3 lb **4⁹⁹**



B) Sandblasting Gun

- Use with an air compressor and your own container
- Gun with ceramic nozzle, steel pickup tube, 10 ft abrasive hose, air jets, and hex key wrench

6320360 – Wt. 2.6 lb **15⁹⁹**

Replacement Ceramic Sandblasting Nozzle

For sandblaster 6320360
6320006 – Wt. 0.1 lb **2⁹⁹**



Spot-Type Sandblaster

- Automatic sand recovery reduces dust
- Gun, 4 nozzles for different shaped surfaces and 2 lbs. of sand
- Requires min. 6 CFM @ 80 to 120 PSI

6320642 – Wt. 4.8 lb **49⁹⁹**

Replacement Nozzle

6320691 – Wt. 0.2 lb **2⁴⁹**

Replacement 46 Grit Aluminum Oxide Sand

6320019 – Wt. 2.1 lb **7⁹⁹**



Sandblasting Gloves

- Textured surface grip on hands and fingers
- Alkali and acid resistant

5050085 – Wt. 0.9 lb **11⁹⁹**

Sandblasting Hose

- Industrial quality hose
- 1/2" I.D.

8039945 – Wt. 0.4 lb **4⁹⁹** /ft

C) Comfort Grip Gravity Feed Sandblaster

- 4 CFM @ 90 PSI
- 5.2 mm steel nozzle
- Gravity feed design holds 260 ml of sandblasting media
- Use with 2 HP or larger air compressor

8059966 – Wt. 1.0 lb **29⁹⁹**

D) Comfort Grip Sandblaster

- 4.5 CFM @ 90 PSI
- Comfortable grip with easy squeeze trigger
- Siphon style sandblaster includes 10 ft long 3/8" I.D. siphon hose and steel pick up tube
- Use with 3 HP or larger air compressor

8059974 – Wt. 2.9 lb **24⁹⁹**

2 pk Replacement Sandblasting Nozzles

For sandblaster 8059974
8085847 – Wt. 0.1 lb **6⁹⁹**



Sandblasting Hood

Acrylic 6" x 9" viewing area
8181273 – Wt. 0.8 lb **19⁹⁹**





Princess Auto Foundation



Together we are making a difference
 for our future customers. By providing bursaries to Canadian Colleges throughout Canada we demonstrate our support for the trades. Work with the hands-give from the heart.

For more information visit us at
www.theprincessautofoundation.com

PAF PARTNERS 

MONDETTA 

Charitable # 833179369 RR00041

Painting



A) Mini Spray Gun

- 0.5 mm nozzle
- 200 ml paint cup
- 2.5 CFM @ 30 PSI

8006022 – Wt. 1.0 lb **24⁹⁹**

B) Touch-Up Spray Gun

- Ideal for touch up spraying, edging, shading, and precision detail spraying
- 7 oz cup

1.5 mm nozzle – 6.5 CFM @ 60 PSI
8059879 – Wt. 1.1 lb **19⁹⁹**

1.8 mm nozzle – 7.3 CFM @ 60 PSI
8079923 – Wt. 1.3 lb **24⁹⁹**

C) Paint Spray Gun

- 1.8 mm nozzle
- 9.5 to 13.5 CFM @ 50 to 70 PSI
- 32 oz (1 litre) canister
- Non-bleeder type gun with siphon feed

8142366 – Wt. 2.1 lb **49⁹⁹**

D) Gravity Feed Spray Gun

- 1.5 mm nozzle
- 16 oz cup
- 15 CFM @ 60 PSI
- Factory tested and fine tuned before being packaged

0450024 – Wt. 1.9 lb **99⁹⁹**

E) 2 Litre Paint Tank

- 2 to 5 CFM for 1.0 mm nozzle, 6 to 8.8 CFM for 2.0 mm nozzle
- Operating pressure: 25 to 45 PSI
- Regulator and 5 ft paint hose

8140600 – Wt. 6.8 lb **99⁹⁹**

F) 2-1/2 Gallon Paint Tank

- All metal construction
- Tank will hold a standard 1 gallon (4 litre) paint can or can be bulk filled
- Regulator, 10 ft paint hose, air hose and fittings

8006581 – Wt. 25.6 lb **139⁹⁹**



G) Spray Gun

- 2.0 mm nozzle
- 8.0 CFM @ 90 PSI
- For use with item # 8006581 (2-1/2 gallon paint tank)

8006583 – Wt. 1.9 lb **39⁹⁹**

H) Air Operated Texturing Gun

- Spray most liquid dry wall materials from joint cement to ceiling acoustics, wall texture, spatter, semi-fog, or any other sprayable material that will feed through the hopper by gravity

• 2.7 CFM @ 50 PSI
3400603 – Wt. 4.2 lb **59⁹⁹**

Spray Gun Cleaning Kit

- Ideal for cleaning all types of spray guns
- Includes a specially formulated lubricant for spray gun needles

0450001 – Wt. 0.2 lb **9⁹⁹**



HVLP

Produces a gentle, easy-to-control spray, reducing paint waste.

HVLP Paint Guns



I) Mini HVLP Spray Gun

- 0.8 mm stainless steel nozzle
- 120 ml plastic cup
- 3.5 CFM @ 45 PSI

8155582 – Wt. 1.1 lb **24⁹⁹**

J) HVLP Gravity Feed Spray Gun

- Gravity feed design
- 1.4 mm stainless steel nozzle
- 7 to 9 CFM @ 20 to 50 PSI
- Does not include regulator

8059833 – Wt. 2.1 lb **49⁹⁹**

K) HVLP Paint Gun

- 1.4 mm stainless steel nozzle
- 600 ml gravity feed nylon paint cup
- 4 CFM @ 90 PSI
- Anodized aluminum gun body

8160657 – Wt. 2.8 lb **69⁹⁹**

L) HVLP Paint Spray Gun

- 1.4 mm nozzle
- 1 litre canister
- 7.1 CFM @ 50 PSI
- Pattern width: 5.9" to 7"
- Operating pressure: 30 to 50 PSI

8006578 – Wt. 3.3 lb **59⁹⁹**

Plastic Paint Can

- 1 litre capacity
- Fits standard paint guns

0452151 – Wt. 0.3 lb **3⁹⁹**



8 Pc Plastic Paint Strainers

- Fits the suction tube on most paint spray cups

0450030 – Wt. 0.1 lb **11⁹⁹**



M) Professional HVLP Paint Gun

- 3.5 CFM @ 43 PSI
- 1.9 litre pressure tank, pressure gauge and two 5 ft hoses
- This item is suitable for lacquer, stain & oil based paints, not suitable for water based coating & latex

0450071 – Wt. 5.8 lb **169⁹⁹**

N) 120V Turbine HVLP Spray System

- 1,000W HVLP turbine compressor
- HVLP spray gun
- 1 quart paint canister
- 15 ft air hose and portable gun stand

0450070 – Wt. 13.1 lb **169⁹⁹**

Paint Spray Gun Stand

- Holds paint spray guns upright for storage and refilling
- Universal design fits most gravity feed and touch up air paint spray guns

8061962 – Wt. 0.2 lb **9⁹⁹**



Air Sanders



1/4" NPT Inlet

	Description	Paper Size	Avg. Air Consumption @ 90 PSI	No Load Speed	Wt. (lb)	ITEM	PRICE
A	Dual Action Orbital	6"	4.0 CFM	10,000 RPM	4.6	8064685	39.99
B	Dual Action	6"	17.0 CFM	12,000 RPM	4.7	8264673	99.99
C	Gear Driven	6"	3.0 CFM	1,000 RPM	4.4	8344533	129.99
D	Jitterbug	3-3/4" x 9"	6.0 CFM	8,000 RPM	4.3	3407277	49.99
E	Straight Line	2-3/4" x 17-1/2"	7.0 CFM	2,100 RPM	6.0	3408192	69.99
F	Straight Line	2-3/4" x 17-1/2"	5.0 CFM	3,000 RPM	6.6	8349821	99.99
G	Straight Line	2-3/4" x 17-1/2"	8.0 CFM	3,000 RPM	6.9	8348468	149.99
H	Palm Sander	6"	2.8 CFM	10,000 RPM	3.1	8145385	69.99
I	Random Orbital Sander	6"	2.0 CFM	11,000 RPM	2.6	8344541	99.99
J	Vacuum Ready Orbital	6"	17.0 CFM	10,000 RPM	3.0	8264681	149.99

Sandpaper

For D: 3-2/3" x 9"		For A, B, C - H, I, J: 6" peel/stick sanding discs				For E, F, G: 2-3/4" x 17-1/2"	
3410983	80 grit	3410967	50/60 grit	3410968	80 grit	3410977	40 grit
3410984	150 grit	3410536	100\120 grit	3411032	180 grit	3410978	80 grit
3410985	180 grit	3410538	220 grit	3410539	280/320 grit	3410979	100 grit
3410986	240 grit	3410540	400 grit	-	-	3410980	150 grit
3410987	320 grit	-	-	-	-	3410981	180 grit
3.99/pk		7.99/pk		7.99/pk		5.99/pk	



6" Replacement Backing Pad

For sander 8064685
3414141 - Wt. 0.3 lb **6⁹⁹**



No sale is final until you're satisfied! We guarantee to make it right. We will repair, replace or refund any product to your satisfaction.

Air Angle Grinders



Air Angle Grinders

	Wheel Size	Avg. Air Consumption @ 90 PSI	No Load Speed	HP	Wt. (lb)	ITEM	PRICE
K	4"	5.0 CFM	10,000 RPM	0.6	3.5	8146946	49.99
L	5"	6.0 CFM	11,000 RPM	0.8	4.7	3400160	89.99
M	5"	4.2 CFM	11,000 RPM	1.3	55.0	8354649	129.99
N	5"	6.0 CFM	12,000 RPM	1	5.2	8342735	159.99





Micro Air Die Grinder

- 2 CFM @ 90 PSI
- No load speed: 54,000 RPM



3" Air Cut Off Saw

- 4 CFM @ 90 PSI
- No load speed: 18,000 RPM

pro.point

3" Air Cut Off Saw

- 4 CFM @ 90 PSI
- No load speed: 18,000 RPM

You think
THIS catalogue
has a lot of
information?

You should check out
princessauto.com

for our newest products, additional
product info and customer reviews.



Professional Quick-Change Chisel Changer

- Change chisels quickly and easily
- High quality chrome finish

3411005 - Wt. 0.8 lb **19⁹⁹**

Panel Crimper

- Forms a step in sheet metal
allowing patch panel to set flush

3410255 - Wt. 2.1 lb **24⁹⁹**

Needle Scaler Attachment

- Chips away rust and welding flux

3416393 - Wt. 2.2 lb **29⁹⁹**

2 pc Spring Retainer Set

8293748 - Wt. 0.3 lb **3⁹⁹**

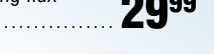
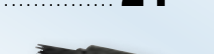
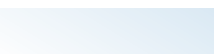
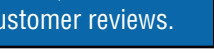

Air Die Grinders



	Description	No Load Speed	Avg. Air Consumption @ 90 PSI	Wt. (lb)	ITEM	PRICE
A	1/4" Mini Composite	25,000 RPM	3.0 CFM	1.3	8344053	29.99
B	1/4" Composite	18,000 RPM	4.0 CFM	1.6	8344087	49.99
C	1/4" Variable Speed Professional	21,000 RPM	3.0 CFM	1.6	3400217	39.99
D	1/4" Angle Composite	18,000 RPM	3.0 CFM	1.5	8344095	59.99
E	1/4" Composite Angled	22,000 RPM	3.0 CFM	1.5	8348690	69.99
F	1/4" Composite with Pad	15,000 RPM	3.0 CFM	1.2	8348708	79.99
G	1/4" Composite	22,000 RPM	3.0 CFM	0.9	8348682	59.99
H	1/4" Composite	27,000 RPM	3.0 CFM	1.8	8264715	79.99
I	1/4" Angle	20,000 RPM	3.0 CFM	2.0	8264699	99.99

Air Hammers



	Description	Stroke	No Load Speed	Avg. Air Consumption @ 90 PSI	Wt. (lb)	ITEM	PRICE
J	6 pc	1-5/8"	4,500 BPM	4.0 CFM	3.5	8091001	24.99
K	8 pc	2-5/8"	3,000 BPM	4.0 CFM	4.9	3405420	29.99
L	5 pc	2-5/16"	3,000 BPM	3.0 CFM	5.2	8344558	49.99
M	5 pc	3"	2,100 BPM	3.0 CFM	5.9	8344566	59.99
N	4 pc	2-5/8"	3,500 BPM	3.0 CFM	5.7	8264665	69.99



- O) Angled Weld Breaker**
3416534 - Wt. 0.3 lb **3⁹⁹**
- P) Sheet Metal Trimmer**
3416583 - Wt. 0.3 lb **3⁹⁹**
- Q) 4 pc Short Shank Chisel Set**
8091019 - Wt. 0.9 lb **6⁹⁹**
- R) 6 pc Long Shank Chisel Set**
3410277 - Wt. 1.9 lb **14⁹⁹**
- S) 5 pc Chisel Set**
• 7" in length with a .401 shank
• For use with 8264665
8275372 - Wt. 1.8 lb **29⁹⁹**

Sheet Metal Tools



pro.point

IR Ingersoll Rand

Powerfirst pro.point Ingersoll Rand

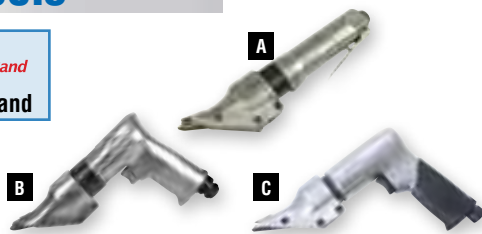

Air Shears

	No Load Speed	Gauge	Avg. Air Consumption @ 90 PSI	Wt. (lb)	ITEM	PRICE
A	2,600 RPM	17	4.0 CFM	2.4	8015872	69.99
B	2,600 RPM	17	4.0 CFM	3.1	8015845	69.99
C	5,500 RPM	20	4.0 CFM	3.1	8342784	149.99

Replacement Blade Kit for A & B

8025816 – Wt. 0.3 lb **23⁹⁹**



Air Reciprocating Saws

	Avg. Air Consumption @ 90 PSI	No Load Speed	Max Cutting Cap.		# of Blades Included	Wt. (lb)	ITEM	PRICE
			Sheet Metal	Plywood				
G	2.2 CFM	9,000 RPM	1/16"	1/2"	2	1.8	8045849	69.99
H	6.0 CFM	5,000 RPM	5/64"	1/2"	2	2.5	8344129	99.99
I	8.0 CFM	10,000 RPM	20 gauge	-	6	1.8	8348716	139.99

5 pk Replacement Reciprocating Saw Blades– For use with 8045849

3410060 – Wt. 0.1 lb **8⁹⁹**

Pistol Grip Air Operated Punch / Flange Tool

- 4 CFM @ 90 PSI
- Max. Punch cap.: 1.6 mm mild steel

8012768 – Wt. 2.5 lb **79⁹⁹**



J) Air Nibbler

- 4 CFM @ 90 PSI
- 3,200 SPM
- Max. cutting capacity: 17 gauge

8036216 – Wt. 2.0 lb **49⁹⁹**

Straight Grip Air Operated Punch / Flange Tool

- 2-in-1 metal working tool
- 4 CFM @ 90 PSI
- Crimps up to 14 gauge sheet steel
- Punch diameter: 5 mm

8181406 – Wt. 3.0 lb **79⁹⁹**



K) Air Nibbler Die & Cutter

8004206 – Wt. 0.1 lb **11⁹⁹**

L) Air Nibbler Punch

8004207 – Wt. 0.1 lb **3⁹⁹**



D) Air Needle Scaler

- 4 CFM @ 90 PSI
- No load speed: 2,800 BPM

8234387 – Wt. 2.6 lb **39⁹⁹**

pro.point

E) Air Needle Scaler

- 2.5 CFM @ 90 PSI
- No load speed: 4,600 BPM

8348674 – Wt. 5.9 lb **99⁹⁹**

pro.point

F) Flux Chipper and Needle Scaler Kit

- 2 tools in 1: Chisel tips for flux chipping or needle scaler attachment for lighter material removal
- 10 CFM @ 90 PSI
- No load speed: 4,600 BPM
- 3 chisels, needle scaler attachment, connector and hex wrench

8345381 – Wt. 8.6 lb **149⁹⁹**

Replacement Chisels for 8345381

- Wt. 0.5 lb
- 8348641 – 20 mm
- 8348666 – 35 mm
- 8348658 – Pin **12⁹⁹** /ea



6 pc Air Scraper Kit

- 4 CFM @ 90 PSI
- No load speed: 3,500 BPM

8265415 – Wt. 3.0 lb **59⁹⁹**



Air Riveter

- Can use up to 3/16" steel rivets
- 4 nose pieces: 3/16", 5/32", 1/8", 3/32"
- 4.0 CFM @ 90 PSI

8230450 – Wt. 4.0 lb **69⁹⁹**

Replacement Jaw Kit – For air riveter 8230450
8230468 – Wt. 0.1 lb **8⁹⁹**

Air Ratchets



	Description	Max. Torque (ft-lb)	Avg. Air Consumption @ 90 PSI	No Load Speed	Adjustable Exhaust	Wt. (lb)	ITEM	PRICE
M	3/8" Composite	50	3.0 CFM	175 RPM	Swivel	3.0	8344103	59.99
N	1/2" Composite	50	3.0 CFM	175 RPM	Swivel	3.0	8344111	69.99
O	1/4"	20	3.0 CFM	270 RPM	-	1.2	8349839	49.99
P	3/8"	50	5.5 CFM	170 RPM	360°	3.0	8264723	119.99
Q	1/2"	55	3.0 CFM	170 RPM	-	3.0	8342743	139.99



Air Impact Wrenches

	Description	Avg. Air Consumption @ 90 PSI	Max. Torque (ft-lb)	No Load Speed	Air Inlet (NPT)	Twin Hammer	Maintenance Free	Wt. (lb)	ITEM	PRICE
A	3/8"	4.5 CFM	350	6,500 RPM	1/4"	Yes	No	3.7	8345225	89.99
B	3/8" Butterfly	4.0 CFM	75	11,000 RPM	1/4"	No	No	2.2	8344137	39.99
C	3/8" Composite	4.0 CFM	280	10,000 RPM	1/4"	Yes	No	2.7	8345274	149.99
A	1/2"	4.5 CFM	830	5,500 RPM	1/4"	Yes	No	5.8	8344160	99.99
C	1/2"	4.2 CFM	500	7,000 RPM	1/4"	Yes	Yes	6.0	8306052	119.99
D	1/2"	5.0 CFM	500	8,000 RPM	1/4"	Yes	No	6.4	8264749	199.99
C	1/2" Composite	4.4 CFM	600	8,000 RPM	1/4"	Yes	No	5.2	8327827	179.99
D	1/2" Composite	5.0 CFM	550	9,500 RPM	1/4"	Yes	No	4.9	8264731	219.99
A	3/4"	4.5 CFM	830	5,500 RPM	1/4"	Yes	No	5.9	8344145	129.99
C	3/4"	9.0 CFM	1,200	4,600 RPM	3/8"	Yes	Yes	12.4	8306060	199.99
C	3/4" Composite	6.7 CFM	1,200	6,500 RPM	3/8"	Yes	No	8.6	8345266	399.99
D	3/4"	8.0 CFM	1,050	6,500 RPM	3/8"	No	No	9.6	8348724	449.99
C	1" Composite	6.7 CFM	1,400	6,500 RPM	3/8"	Yes	No	9.0	8345233	449.99
E	1" D-Handle	10* at 100 PSI	2,500	3,000 RPM	1/2"	Yes	Yes	39.9	8306078	499.99



10 pc 1/2" Dr Torque Limiting Extension Bar Set

- Helps prevent over-tightening of wheel lug nuts and reduces the risk of breaking studs or damaging alloy wheels
- Heavy duty chrome-moly construction
- Includes (in ft-lb): 65, 75, 80, 90, 100, 110, 120, 130, 140, and 150



8090037 – Wt. 6.6 lb **119⁹⁹**

1/2" Dr Torque Limiting Extension Bars

80 ft-lb	90 ft-lb	100 ft-lb	110 ft-lb	120 ft-lb	140 ft-lb	150 ft-lb
8090144	8090151	8090169	8090177	8090185	8090201	8090219

Wt. 0.8 lb **19⁹⁹**/ea

Shallow & Deep Combination Impact Socket Sets ^{1 item shown}

Drive	Qty.	Sizes	Points	Material	Wt. (lb)	ITEM	PRICE
3/8"	32 ⁺	8 to 19 mm & 5/16" to 3/4"	6	Chrome Vanadium	7.2	8001125	39.99
3/8" & 1/2"	59	7 to 32 mm & 5/16" to 1-1/4"	6	Chrome Vanadium	20.5	3410186	99.99
1/2"	40	11 to 24 mm & 7/16" to 1"	6	Heat Treated Steel	16.0	8036902	69.99



MORE FEATURES

COMING SOON!

www.princessauto.com

Look for the official launch

pro.point

4 pc Impact Flip Socket Set

- 3 pc socket 17 x 19 mm, 13/16" x 3/4", 21 mm x 7/8"
- 3" extension bar

8345753 – Wt. 1.8 lb **19⁹⁹**



Specialty Impact Socket Sets

Drive	Qty.	Type	Sizes	Points	Material	Wt. (lb)	ITEM	PRICE
1/4" & 3/8"	7	E-Torx	E-6 to E-16	Female Torx	Chrome vanadium	0.5	3415288	9.99
3/8"	7	Universal joint	3/8" - 3/4"	6	Chrome vanadium	2.3	3410318	39.99
3/8"	7	Universal joint	10 to 17 mm	6	Chrome Vanadium	2.3	3410320	39.99
1/2"	8	Hex	6 to 19 mm	Hex	Chrome-moly	2.9	8159428	39.99
1/2"	8 ⁺	Hex	1/4" to 3/4"	Hex	Chrome-moly	2.9	8159469	39.99
1/2"	7	Deep Impact wheel sockets	17, 19, 21 mm & 13/16", 7/8", 1" and 1-1/6"	6	Chrome-moly	5.0	8003720	59.99

Impact Sockets



Deep Impact Socket Sets ^{*item shown}

Drive	Qty.	Sizes	Points	Material	Wt. (lb)	ITEM	PRICE
3/8"	8	5/16" to 3/4"	6	Chrome Vanadium	1.9	3408390	14.99
3/8"	8	8 to 19 mm	6	Chrome Vanadium	2.2	3409331	14.99
1/2"	10†	7/16" to 1"	6	Chrome Vanadium	5.5	3408408	24.99
1/2"	10†	11 to 24 mm	6	Chrome Vanadium	4.7	3408416	24.99
1/2"	14	10 to 32 mm	12	Chrome Vanadium	3.9	8262743	39.99
1/2"	11	3/8" to 1"	6	Chrome-moly	6.1	8329690	49.99
1/2"	11	10 to 24 mm	6	Chrome-moly	5.7	8329724	49.99
1/2"	13	7/16" to 1-1/4"	6	Chrome-moly	10.9	8264780	99.99
1/2"	14	10 to 27 mm	6	Chrome-moly	9.5	8264798	99.99
3/4"	8	26 to 38 mm	6	Chrome Vanadium	11.7	3411020	79.99
3/4"	8	1" to 1-1/2"	6	Chrome Vanadium	12.1	3414778	79.99
3/4"	8	1" to 1-1/2"	6	Chrome-moly	12.8	8329732	79.99
3/4"	8	26 to 38 mm	6	Chrome-moly	12.6	8329823	79.99



1/2" Dr Impact Sockets

Chrome Vanadium steel

	Size	Wt. (lb)	ITEM	PRICE/ea.
Shallow	1/2"	0.2	3410921	2.29
Shallow	9/16"	0.2	3415809	2.29
Shallow	3/4"	0.2	3415825	3.49
Deep	1/2"	0.4	3410926	4.49
Deep	3/4"	0.5	3415858	4.99
Shallow	15 mm	0.2	3410943	2.29
Shallow	18 mm	0.2	3410944	2.29
Deep	15 mm	0.4	3410945	3.49
Deep	18 mm	0.5	3410946	3.99

Shallow Impact Socket Sets ^{*item shown}

Drive	Qty	Sizes	Points	Material	Wt. (lb)	ITEM	PRICE
3/8"	8	5/16" to 3/4"	6	Chrome vanadium	1.2	3409513	11.99
3/8"	8	8 to 19 mm	6	Chrome vanadium	1.1	3409323	11.99
1/2"	10†	7/16" to 1"	6	Chrome-moly	2.9	3401155	14.99
1/2"	10†	11 to 24 mm	6	Chrome-moly	2.5	3407798	14.99
1/2"	14	3/8" to 1-1/4"	12	Chrome vanadium	4.0	8262735	39.99
1/2"	10	7/16" to 1"	6	Chrome-moly	2.9	8329674	24.99
1/2"	10	10 to 24 mm	6	Chrome-moly	2.9	8329708	24.99
1/2"	14	10 to 27 mm	6	Chrome-moly	5.9	8264772	59.99
1/2"	13	7/16" to 1-1/4"	6	Chrome-moly	7.0	8264764	59.99
3/4"	8	1" to 1-1/2"	6	Chrome vanadium	8.1	3414760	49.99
3/4"	8	26 to 38 mm	6	Chrome vanadium	9.1	3411019	49.99
3/4"	8†	1" to 1-1/2"	6	Chrome-moly	9.1	8329666	49.99
3/4"	8	26 to 38mm	6	Chrome-moly	9.3	8329815	49.99
1"	9	1" to 2"	6	Chrome vandadium	16.9	3414828	119.99



Impact Socket Adapters

1/2" F x 3/8" M 3417771 – Wt. 0.1 lb	1.99
3/8" F x 1/2" M 3417789 – Wt. 0.1 lb	1.99
1/2" F x 3/4" M 3417797 – Wt. 0.3 lb	3.49
8 pc Impact Adapter Set 8044671 – Wt. 2.6 lb	24.99



3 pc Impact Extension Bar Sets

Type	Drive	Sizes	Wt. (lb)	ITEM	PRICE
Impact	3/8"	3", 5", 10"	1.0	8024318	12.99
Impact	1/2"	3", 5", 10"	1.8	8036234	14.99
Impact	3/4"	4", 6", 10"	5.1	8044662	29.99
Wobble	3/8"	3", 6", 8"	0.8	8040531	11.99
Wobble	1/2"	3", 6", 8"	1.4	8020795	16.99



2 pc Impact Universal Joints

3/8" (8039240)
1/2" (8038018)
8036287 – Wt. 0.6 lb **14.99**



Impact Universal Joints

High strength chrome-moly steel

Drive	Wt. (lb)	ITEM	PRICE
3/8"	0.2	8039240	7.99
1/2"	0.4	8038018	9.99
3/4"	1.5	8038027	29.99

Impact Extension Bars

1/2" dr

Size	Wt. (lb)	ITEM	PRICE
3"	0.3	3412202	2.49
5"	0.5	3412210	3.49
10"	0.9	3412228	4.99



2-In-1 1/2" Dr Impact Flip Socket & Extension Kit

Includes 3" extension and double ended flip socket (3/4" and 13/16")
3409521 – Wt. 0.9 lb **5.99**



POWER FIRST **pro.point** **IR Ingersoll Rand**
Powerlist pro.point Ingersoll Rand

pro.point
 Chucks are precision machined to high tolerances.

Air Drills

	Description	Avg. Air Consumption @ 90 PSI	Reversible	No Load Speed	Wt. (lb)	ITEM	PRICE
A	3/8" Angle Composite	3.7 CFM	No	1,800 RPM	2.7	8011796	59.99
B	3/8" Composite	4.0 CFM	Yes	1,800 / 1,000 RPM	2.4	8344525	49.99
C	1/2" Composite	4.0 CFM	Yes	450 / 250 RPM	3.1	8344517	69.99
D	3/8" Keyless	4.8 CFM	-	2,800 RPM	3.2	8349763	129.99
E	1/2" Keyed	3.9 CFM	-	1,300 RPM	4.1	8349797	179.99
F	1/2" Keyless	3.9 CFM	-	1,300 RPM	4.5	8349789	199.99
G	3/8" Keyless	4.0 CFM	Yes	1,700 RPM	3.4	8349904	139.99



Air Drills

PRINCESS AUTO **WORK with us!**

We are always looking for team-oriented people with a passion for delivering Royal Service.

Visit www.princessauto.com/careers to apply for any of our positions across Canada

Part-Time • Full-Time • Benefits • Opportunities • Fun



18 Gauge Brad Nails

Qty	Size	Wt. (lb)	ITEM	PRICE
1,000	1"	0.6	8078131	3.99
1,000	1-1/4"	0.6	8078149	4.99
1,000	1-1/2"	0.8	8078156	5.99
1,000	2"	1.0	8078164	6.99
5,000	3/4"	1.8	8078057	8.99
5,000	1"	2.5	8078099	9.99
5,000	1-1/4"	3.1	8078107	11.99
5,000	1-1/2"	3.7	8078115	12.99
5,000	2"	4.9	8078123	15.99



2" 18 Gauge Brad Nailer

- Lightweight aluminum alloy body reduces user fatigue
- Drives 3/8" to 2", 18 ga brad nails
- Nail capacity: 100 pieces
- Max pressure: 110 PSI

8352411 – Wt. 3.2 lb **39⁹⁹**



3-1/2", 28° Framing Nailer

- Drives 2" to 3-1/2", 28° clipped head nails
- Nail capacity: 90 pieces
- Max pressure: 120 PSI

8314106 – Wt. 10.7 lb **129⁹⁹**

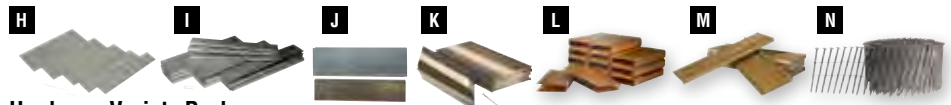

Hardware Variety Packs

Type	Qty	Sizes	Wt. (lb)	ITEM	PRICE
H 18 Gauge Brad Nails	2,500	3/4" to 2"	1.8	8295370	9.99
I 1/4" Narrow Crown Staples	2,000	5/8" to 1-1/2"	2.3	8295362	9.99
J Brad Nails & Staples	5,000	13/16" to 2" Brad nails, 5/8" & 1-5/8" staples	4.1	8047839	14.99
K Paper Tape Nails	1,000	2-3/8" & 3-1/4"	9.5	8295354	22.99
L Leg Flooring Staples	1,000	1-3/4"	4.2	8117574	11.99
L Leg Flooring Staples	1,000	2"	4.7	8117558	11.99
M Head Flooring Cleats	1,000	2"	3.9	8117582	17.99
N 15° Roofing Coil Nails	7,200	1-1/4" x .120	33.0	8117509	34.99

2,000 pc 28° Framing Nails – For use with 8314106

8168221 – 2-3/8" x 0.113
 Wt. 14.4 lb **24⁹⁹**

8077935 – 3-1/4" x 0.120
 Wt. 21.5 lb **29⁹⁹**



Air Duster
 1ft aluminum extension tube with rubber tip
 8306045 – Wt. 0.4 lb **7⁹⁹**

Short Nose Air Duster

- High volume air duster has triple the air volume of regular blow guns
 - All metal construction
- 0430023 – Wt. 0.4 lb **13⁹⁹**



4 pc Duster Kit

- Handle with quick change 4-1/4" and 11" long extension tubes and brass nozzle
- 0430370 – Wt. 0.5 lb **14⁹⁹**



Blow Guns

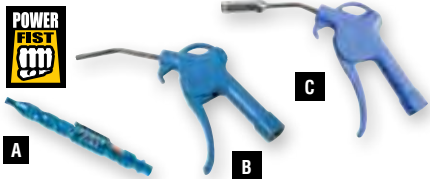

A) Pocket Blow Gun
8247215 – Wt. 0.1 lb **4⁹⁹**

B) Blow Gun
4-1/2" metal nozzle
8232860 – Wt. 0.3 lb **6⁹⁹**

C) 2-in-1 Blow Gun
• Blow gun & tire inflator
• Safety nozzle reduces risk of injury if tip contacts skin
8263618 – Wt. 0.4 lb **8⁹⁹**

Telescoping Blow Gun
3-section tube extends to 12-3/4"
0430391 – Wt. 0.5 lb **9⁹⁹**

Telescoping Blow Gun
• 3-section tube extends from 5-1/4" to 12"
• Pistol grip
0430441 – Wt. 0.5 lb **11⁹⁹**

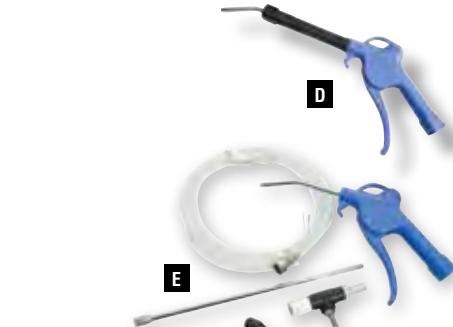

D) Telescoping Swivel Blow Gun
Adjustable length: 6-1/2" to 11"
8263642 – Wt. 0.6 lb **13⁹⁹**

E) Siphon Nozzle Blow Gun
Blow gun, 7-7/8" steel extension tube, siphon nozzle and 6 ft clear hose
8263576 – Wt. 0.9 lb **19⁹⁹**

Blow Guns
• Ideal for blowing dust from hard to reach areas
• 1 safety and 1 rubber tip nozzle
2 ft Blow Gun
0432351 – Wt. 0.6 lb **9⁹⁹**
4 ft Blow Gun
0432369 – Wt. 0.8 lb **12⁹⁹**

Air Dryer Gun
• In-line air regulator to adjust air flow
• 7 CFM @ 90 PSI
8159592 – Wt. 0.7 lb **29⁹⁹**



Pistol Grip Blow Gun
• Nickel plated aluminum body
• Non slip rubber covered grip
8300410 – Wt. 0.5 lb **14⁹⁹**



Industrial Rubber Nozzle Blow Gun
• Leakproof connection when blowing out air lines & automatic transmissions
• Rubber tip protects delicate finishes on moulds or fresh paint
0432591 – Wt. 0.6 lb **18⁹⁹**
Replacement Tip
0432609 – Wt. 0.1 lb **6⁴⁹**

Blow Gun with Rotating Nozzle
Nozzle rotates 360°
0430444 – Wt. 0.4 lb **9⁹⁹**

Safety Lever Short Nose Blow Gun
Complete with extra nozzle
0432518 – Wt. 0.3 lb **4⁹⁹**

Short Nose Cleaning/Blow Gun
• Useful for spraying, degreasing & rust proofing
• Aluminum nozzle
• 8 ft vinyl siphon hose
0430216 – Wt. 0.8 lb **9⁹⁹**

Blow Gun Rubber Nozzle
Brass plug, rubber nozzle
8247207 – Wt. 0.1 lb **4⁹⁹**

Blow Gun Safety Nozzle
Zinc alloy construction, chrome plated finish, brass tube and nozzle
8247223 – Wt. 0.6 lb **14⁹⁹**



Looking for the perfect gift?
GIFT CARDS
are available at any Princess Auto location

Engine Cleaning

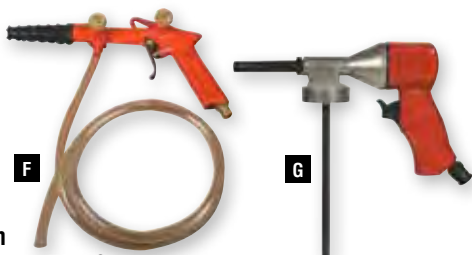

F) Engine Cleaning Gun
Requires 0.5 to 3.1 CFM @ 40 to 60 PSI
0430850 – Wt. 1.1 lb **17⁹⁹**

G) Undercoating Gun
Nozzle: 7/32" I.D.
0432377 – Wt. 1.6 lb **24⁹⁹**

H) Water Washing Gun
• Attaches to air compressor and water supply
• Adjustable air and water flow
• Nickel plated aluminum construction
0434795 – Wt. 1.1 lb **34⁹⁹**



I) Engine Cleaners
Engine and machinery cleaner with 4 ft suction hose
0430026 – Wt. 0.7 lb **12⁹⁹**
0430071 – Wt. 0.9 lb **14⁹⁹**

J) Engine Cleaning & Undercoating Gun
• 11 CFM @ 70 PSI
• 3 interchangeable nozzles
• Can be assembled to use as either an engine cleaner or an undercoating gun
0432344 – Wt. 2.1 lb **34⁹⁹**

Air Care



Air Tool Oil

- Synthetic blend specially formulated for air tools subject to extreme temperatures ranging from -55°C to 250°C
- Prevents rust formation, gum and sludge build up
- Engineered for all air tools
- Seal conditioner

- A) 8005089** – 4 oz
Wt. 0.3 lb **2⁹⁹**
- B) 8015266** – 500 ml
Wt. 1.1 lb **6⁹⁹**



17 pc Air Accessory Kit

- Blow gun, couplers, connectors, inflation needles, dual head air chuck, tire gauge
8164626 – Wt. 1.2 lb **17⁹⁹**

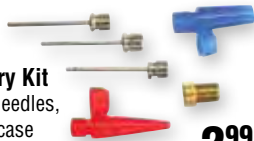

6 pc Inflator Accessory Kit

- 2 air nozzles, 3 inflator needles, 1 brass adapter, plastic case
8249864 – Wt. 0.1 lb **2⁹⁹**



L) Lock On Levered Tire Chuck

- 1/4" NPT female inlet
 - Max air pressure: 120 PSI
- 0434365** – Wt. 0.2 lb **4⁹⁹**

M) Dual Head Air Chuck

- 1/4" NPT female inlet
8037714 – Wt. 0.2 lb **4⁹⁹**



Air Chucks

- 1/4" NPT female inlet
- N) Standard**
0430165 – Wt. 0.1 lb **4⁴⁹**
- O) Dual Head**
0432625 – Wt. 0.2 lb **9⁹⁹**



Air Powered Caulking Gun

- 4.5 CFM @ 90 PSI
 - All metal barrel and handle
- 8205742** – Wt. 1.8 lb **14⁹⁹**

C) Impact Wrench Care Kit

- Kit includes 4 oz heavy duty impact wrench grease
 - 4 oz air tool lubricant
 - 105-4 grease can be used for external greasing of Ingersoll Rand impact tools with composite (non-metallic) housings
- 8274458** – 105-4T Grease
Wt. 0.8 lb
- 8275380** – 105-4 Grease
Wt. 0.8 lb **39⁹⁹** /ea



Air Chucks & Inflators

D) Pistol Grip Air Inflator

- Gauge reads: 0 to 220 PSI
 - Deflation knob allows for quick adjustment of air pressure without disconnecting inflator
- 0433797** – Wt. 0.9 lb **14⁹⁹**

E) Tire Inflator with Compass

- Gauge reads: 100 PSI
 - Deflating knob
 - "M" style plug included
- 8159543** – Wt. 0.8 lb **19⁹⁹**

F) Comfort Grip Tire Inflator with Gauge

- Gauge reads: 100 PSI
 - Lock-on tire inflator with swivel hose connector
- 8059537** – Wt. 1.0 lb **29⁹⁹**

G) Tire Inflator with Gauge and 36" Hose

- Gauge reads: 0 to 140 PSI
 - Pressure release button
- 8300402** – Wt. 1.2 lb **39⁹⁹**

H) Digital Tire Inflator

- Gauge reads: 5 to 200 PSI
 - 6" steel dual chuck
 - Zinc alloy housing with quick release button
 - Selectable scales: PSI, bar, kgf, cm.sq, kPa
- 8255119** – Wt. 1.4 lb **59⁹⁹**

I) Tire Inflator

- Gauge reads: 10 to 120 PSI
 - Automatic gauge
 - Zinc die-cast construction with 15" air hose
- 0432245** – Wt. 1.5 lb **59⁹⁹**

J) Heavy Duty Tire Inflator

- Large valve core bore
 - Dual foot
- 8263170** – Wt. 1.6 lb **69⁹⁹**

K) Glad Hand Air Inflator Set

- Inflate tires using your truck's air
 - Glad hand connection, blow gun, air chuck, 50 ft hose, carrying case
- 8239444** – Wt. 6.5 lb **49⁹⁹**



AIR TOOL OIL

It is important to use "Air Tool Oil" to help clean away the packing grease while protecting the internal components such as o-rings, seals, pistons, fins, etc.

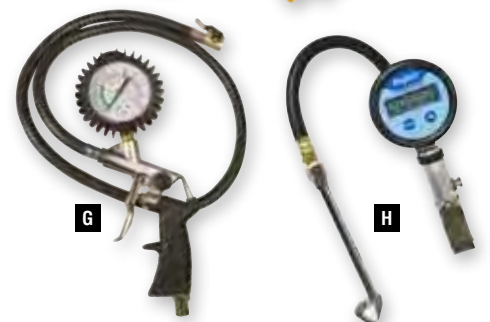

Power Tools

Abrasive Wheels



Masonry Cutting Wheels

C46 material: suitable for masonry, stone, brick, concrete, etc.

Size (dia. x width x arbor)	Max. RPM	ITEM	PRICE
4" x 1/16" x 5/8"	15,200	8135006	1.79
4-1/2" x 1/16" x 7/8"	13,300	8135014	1.99
5" x 1/16" x 7/8"	12,200	8135022	2.39
7" x 1/16" x 7/8"	8,600	8135030	2.99

Super Thin Cutting Wheels

A46 material: suitable for ferrous metals (iron, steel, welds, etc.)

Size (dia. x width x arbor)	Max. RPM	ITEM	PRICE
4" x 1/16" x 5/8"	15,200	8133589	1.39
4-1/2" x 1/16" x 7/8"	13,300	8133605	1.59
5" x 1/16" x 7/8"	12,200	8133613	1.89
7" x 1/16" x 7/8"	8,600	8133621	2.49

Masonry Grinding Wheels

C24 material: suitable for masonry, stone, brick, concrete, etc.

Size (dia. x width x arbor)	Max. RPM	ITEM	PRICE
4" x 1/4" x 5/8"	15,200	8135188	1.99
4-1/2" x 1/4" x 7/8"	13,300	8135196	2.59
5" x 1/4" x 7/8"	12,200	8135204	2.99
7" x 1/4" x 7/8"	8,600	8135212	3.49

Depressed Centre Cutting Wheels

A30 material: suitable for ferrous metals (iron, steel, welds, etc.)

Size (dia. x width x arbor)	Max. RPM	ITEM	PRICE
4" x 1/8" x 5/8"	15,200	8133480	1.49
4-1/2" x 1/8" x 7/8"	13,300	8133548	1.79
5" x 1/8" x 7/8"	12,200	8133555	1.99
7" x 1/8" x 7/8"	8,600	8133563	2.59

Wire Cup Brushes

- 5/8" x 11 arbor
- Cup brushes are used on angle grinders for weld cleaning, rust removal and surface preparation



Size	Trim Length	Max. RPM	ITEM	PRICE
Knotted				
3"	7/8"	14,000	8170441	9.99
4"	1-1/8"	8,500	8170466	15.99
6"	1-3/8"	6,500	8170508	22.99
Crimped				
3"	13/16"	12,500	8170482	7.99
5"	1-3/8"	6,500	8170474	19.99

General Purpose Metal Grinding Wheels

A24 material: suitable for ferrous metals (iron, steel, welds, etc.)

Size (dia. x width x arbor)	Max. RPM	ITEM	PRICE
4" x 1/4" x 5/8"	15,200	8133829	1.79
4-1/2" x 1/4" x 7/8"	13,300	8133837	1.99
5" x 1/4" x 7/8"	12,200	8133845	2.39
7" x 1/4" x 7/8"	8,600	8133852	2.99

Cutting Blades

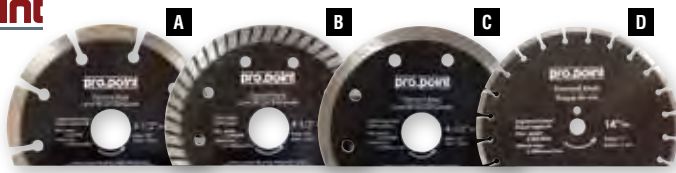

Diamond Cutting Blades

	Style	Size (dia. x arbor)	Max. RPM	Wt. (lb)	ITEM	PRICE
A	Segmented	4-1/2" x 7/8"	13,200	0.1	8336703	14.99
	Segmented	7" x 7/8"	8,600	0.1	8336760	24.99
B	Turbo	4-1/2" x 7/8"	13,200	0.1	8336711	14.99
	Turbo	7" x 7/8"	8,500	0.1	8336778	24.99
C	Continuous Rim	4-1/2" x 7/8"	13,200	0.1	8336729	14.99
	Continuous Rim	7" x 7/8"	8,600	0.1	8336786	24.99
D	Segmented	14" x 1"	4,300	0.2	8336794	79.99

CONTINUOUS RIM

Designed to provide the smoothest cut of all 3 styles. The outer rim is best suited for wet cutting or any application where a smooth cut is required. For cutting concrete, masonry, tile, granite, marble, asphalt and brick.

TURBO STYLE

These blades are designed to cut faster and give a smoother cut than segmented style. They are also designed to give exceptionally long life. Used wet or dry for cutting concrete, masonry, tile, granite, marble, asphalt and brick.

TASK

7" Cutting Wheel

- 10,000 RPM max.
- 7/8" bore, double reinforced
- For ferrous metals such as iron, steel, welds, etc.

8035431 - Wt. 0.3 lb..... **5⁹⁹**



Metal Cutting Wheel

Size (dia. x width x arbor)	Type	Max. RPM	Wt. (lb)	ITEM	PRICE
12" x 9/64" x 1"	A24	5,100	1.1	8164014	4.49
14" x 9/64" x 1"	A24	4,400	1.5	8164022	5.49
14" x 3/32" x 1"	A30P	3,900	1.3	8086563	6.99



Chop Saws

PRINCESS AUTO

WORK with us!



We are always looking for team-oriented people with a passion for delivering Royal Service.



Visit www.princessauto.com/careers to apply for any of our positions across Canada

Part-Time • Full-Time • Benefits • Opportunities • Fun

A) 6" Portable Chop Saw

- 6.5A
- No load speed: 7,400 RPM
- Max. cutting capacity: 1-3/8" at 90° and 5/8" at 45°

8292138 – Wt. 11.2 lb **79⁹⁹**

6" Super thin Type 1 Cutting Wheel

8292070 – Wt. 0.1 lb **4⁹⁹**

B) 14" Chop Saw

- 15A
- No load speed: 3,500 RPM

8287864 – Wt. 38.2 lb **129⁹⁹**

14" Metal Cutting Blade

8141756 – Wt. 4.0 lb **79⁹⁹**

C) 14" Chop Saw

- 15A
- No load speed: 3,800 RPM
- Mitre angle: 45° right/left

8262198 – Wt. 43.4 lb **189⁹⁹**



	Wheel Size	Amps	No Load Speed	Handle Positions	Switch Style	Wt. (lb)	ITEM	PRICE
D	4"	4.2A	11,000 RPM	1	Slide	4.2	8007854	29.99
E	4.5"	5.4A	11,000 RPM	2	Slide	4.7	8336166	39.99
F	4.5"	6.0A	11,000 RPM	2	Slide	8.8	8307639	89.99
G	4.5"	7.5A	10,000 RPM	2	Paddle	6.4	8262404	109.99
H	5"	7.3A	11,000 RPM	3	Trigger	5.5	8336174	49.99
I	5"	10.5A	11,000 RPM	2	Trigger	7.7	8262446	149.99
J	7"	15A	8,500 RPM	3	Trigger	16.4	8262453	219.99

Angle Grinders



Adjustable Angle Grinder Wrench – Fits all angle grinder centre nuts
3410859 – Wt. 0.4 lb **4⁹⁹**

CHOOSING AN ANGLE GRINDER

Angle grinders can be used for cutting or grinding materials such as ferrous metals and masonry, stone, brick, and concrete. There are several types of wheels, discs, brushes and backing pads. Be sure to choose the right one for your application.

Sanding Discs

- Fibre back
- Double resin bonded aluminum oxide
- For sanding fibreglass, wood, metal and plastic

Size	Grit	Max. RPM	ITEM	PRICE
4"	24	15,200	8146243	0.99
4"	36	15,200	8146250	0.99
4"	50	15,200	8146268	0.99
4"	80	15,200	8146276	0.99
4-1/2"	24	13,200	8146284	1.19
4-1/2"	36	13,200	8146292	1.19
4-1/2"	50	13,200	8146300	1.19
4-1/2"	80	13,200	8146318	1.19



Size	Grit	Max. RPM	ITEM	PRICE
5"	24	12,200	8146326	1.39
5"	36	12,200	8146334	1.39
5"	50	12,200	8146342	1.39
5"	80	12,200	8146359	1.39
7"	24	8,500	8146367	1.99
7"	36	8,500	8146375	1.99
7"	50	8,500	8146383	1.99
7"	80	8,500	8146391	1.99

TASK

Backing Pads

Size	Max. RPM	Wt. (lb)	ITEM	PRICE
4"	13,000	0.2	3410441	10.99
4-1/2"	12,000	0.2	3410442	12.99
5"	12,000	0.2	3410443	14.99
7"	12,000	0.3	3410444	19.99

TASK

Centre Locking Nut

For attaching backing pad to grinders with 5/8" x 11 NC thread.

3410509 – Wt. 0.1 lb **4⁹⁹**

Bench Grinders



Bench Grinder Stand

- 32" in height
- For use with 5" to 10" bench grinders



8343030 – Wt. 28.7 lb **69⁹⁹**



Belt Sander / Bench Grinder

- 1/2 HP
- No load speed: 3,600 RPM
- Wheel size: 8" x 3/4"
- Belt size: 2" x 28"

8359697 – Wt. 40.1 lb **129⁹⁹**

Grinding Wheel Dresser

- 6" cast iron handle

3410745 – Wt. 0.7 lb **5⁹⁹**

Diamond Grinding Wheel Dresser

- 36 grit

8049017 – Wt. 0.2 lb **9⁹⁹**

*2 pc Replacement Bulbs for

8300139/8300147
8342628 – Wt. 0.1 lb **1²⁹**

	Wheel Size	HP	Amps	No Load Speed	Arbor	Wheel Width	Variable Speed RPM	Lighting	Wt. (lb)	ITEM	PRICE
A	3"	1/3	0.4A	3,450 RPM	3/8"	1/2" & 3/4"	No	No	4.8	8335390	49.99
B	6"	1/3	2.1A	3,450 RPM	1/2"	3/4"	No	No	25.3	8359713	59.99
C	6"	1/2	1.0A	3,450 RPM	1/2"	3/4"	No	No	18.7	8340879	49.99
D	6"	1/3	3.5A	3,450 RPM	1/2"	3/4"	2,000 to 3,300	Yes*	29.5	8300139	119.99
E	8"	1/2	5.0A	3,450 RPM	5/8"	3/4"	No	No	26.6	8296568	69.99
F	8"	1/2	3.0A	3,450 RPM	5/8"	1"	No	Yes	38.8	8359754	89.99
G	8"	1/2	5.0A	3,450 RPM	5/8"	3/4"	2,000 to 3,300	Yes*	37.4	8300147	139.99

Wire Wheels

For use on bench grinders



	Type	Size	Arbor	Max. RPM	Wt. (lb)	ITEM	PRICE
H	Coarse	6"	1/2" and 5/8"	3,750	0.6	3410500	7.99
H	Fine	6"	1/2" and 5/8"	3,750	0.6	3410501	7.99
I	Heavy Duty	6"	-	6,000	0.8	3410505	11.99
I	Heavy Duty	8"	-	4,500	1.1	3410506	13.99
J	Knot-type	6"	7/8"	9,000	1.3	3410645	14.99

Al – Aluminum oxide abrasive for use on steel including HSS cutting tools
Si – Silicone Carbide abrasive for harder material such as carbide tipped cutting tools

Bench Grinder Wheels

- Fast cut rate
- 1" bore with bushings for 7/8", 3/4", 5/8", or 1/2" arbor



Material	Size	Grit	Max. RPM	Wt. (lb)	ITEM	PRICE
Al	6" x 3/4"	36	4,450 RPM	2.0	8037186	10.99
Al	6" x 3/4"	80	4,450 RPM	1.9	8037194	10.99
Al	6" x 1"	36	4,450 RPM	2.5	8037202	11.99
Al	6" x 1"	80	4,450 RPM	2.4	8037210	11.99
Al	8" x 1"	36	3,660 RPM	4.5	8037269	16.99
Al	8" x 1"	80	3,660 RPM	4.3	8037277	16.99
Si	6" x 1"	80	4,450 RPM	2.1	8037228	21.99
Si	8" x 1"	80	3,660 RPM	3.7	8037285	29.99

Metal Shears



Electric Shears

	Cutting Cap.	Amps	Radius	Wt. (lb)	ITEM	PRICE
K	14 Gauge	3.0A	1-1/2"	5.9	8083115	89.99
L	16 Gauge	4.0A	-	5.9	8343055	79.99

Replacement Blades – For use with 8083115

8106064 – Wt. 0.1 lb **3⁹⁹**

Nylon Brush Wheels

For use on bench grinders



Size	Max. RPM	Wt. (lb)	ITEM	PRICE
4"	1/2" & 5/8"	0.3	3410882	11.49
6"	1/2" & 5/8"	0.6	3410621	16.99





Power Drills & Wrenches



Electric Drills

	Description	Chuck	Amps	No Load Speed	Reversible	Wt. (lb)	ITEM	PRICE
A	Corded Drill	3/8" Keyless	6.0A	0 to 2,500 RPM	Yes	6.4	8262370	84.99
B	Corded Drill	3/8" Keyless	4.0A	0 to 2,700 RPM	Yes	4.0	8336224	34.99
C	Spade Handle Drill	1/2" Keyed	9.0A	0 to 850 RPM	No	9.1	8338626	79.99
D	Angle Drill	3/8" Keyless	3.2A	0 to 1,500 RPM	No	4.6	8356008	59.99
E	Corded Drill	1/2" Keyed	6.6A	0 to 2,900 high / 0 to 1,200 RPM low	Yes	6.8	8310146	139.99
F	Hammer Drill	5/8" Keyed	6.0A	0 to 2,900 RPM	Yes	7.1	8262347	119.99
G	SDS Plus Rotary Hammer Drill	7/8" Keyed	5.4A	0 to 1,500 RPM	Yes	9.3	8311961	149.99
H	Drywall Screwgun	1/4" Keyless	6.0A	0 to 4,000 RPM	Yes	3.9	8336372	119.99

Impact Wrenches

	Description	Amps	Max. Torque (ft-lb)	No Load Speed	Wt. (lb)	ITEM	PRICE
I	1/2" Electric Impact Wrench	7.5A	185	2,100 RPM	8.0	8130288	89.99
J	1/2" Electric Impact Wrench	6.0A	360	2,800 RPM	8.0	8340507	159.99



Cordless Drills

	Description	Chuck	Battery	# of Batteries	Amp Hours	VSR	# of Torque Settings	Wt. (lb)	ITEM	PRICE
K	18V Drill Driver	3/8" Keyless	Ni-Cad	2	1.2	0 to 400, 0 to 1,150 RPM	21	9.4	8340515	79.99
L	14.4V Drill Driver	3/8" Keyless	Ni-Cad	2	1.3	0 to 400, 0 to 1,300 RPM	16	10.3	8337909	139.99
M	18V Drill Driver	1/2" Keyless	Ni-Cad	2	1.3	0 to 400, 0 to 1,300 RPM	16	13.3	8337925	189.99



Drill Bit Sets

	# of Pc.	Material	Size Range	Wt. (lb)	ITEM	PRICE
A	6	HSS	1/16"	0.1	8314460	2.99
B	6	Cobalt	1/16"	0.1	8314486	3.99
A	6	HSS	5/64"	0.1	8314536	3.19
B	6	Cobalt	5/64"	0.1	8314544	4.19
A	6	HSS	3/32"	0.1	8314551	3.49
B	6	Cobalt	3/32"	0.1	8314569	4.49
A	6	HSS	7/64"	0.1	8314577	3.69
B	6	Cobalt	7/64"	0.1	8314585	4.69
A	6	HSS	1/8"	0.1	8314593	3.99
B	6	Cobalt	1/8"	0.1	8314601	4.99
C	6	Titanium	1/8" to 5/16"	0.4	8042520	12.99
D	7	Titanium	1/6" to 1/4" hex	0.3	8002108	13.99
E	8	HSS	1/16", 3/32", 5/32", and 1/8"	0.1	8314437	4.99
E	8	Cobalt	1/16", 3/32", 5/32", and 1/8"	0.1	8314452	6.49
F	12	HSS	1/8"	0.1	3410678	7.99
G	12	Titanium	1/8"	0.1	3410720	9.99
H	13	HSS	1/16" to 1/4"	0.3	8314411	6.99
H	13	Titanium	1/16" to 1/4"	0.3	8314742	9.99
I	13	Cobalt	1/16" to 1/4"	0.7	8314429	19.99
D	13	Titanium	1/16" to 1/4" hex	0.5	8002114	19.99
J	20	HSS	#61 to 80	0.1	3410147	4.99
K	29	HSS	1/16" to 1/2"	2.6	8314395	24.99
L	29	Titanium	1/16" to 1/2"	2.5	8314403	29.99
M	29	Cobalt	1/16" to 1/2"	3.4	8314890	79.99
M	115	HSS	1/16" to 1/2", 60 number, 26 letter	7.3	3409364	39.99
N	115	Titanium Coated HSS	1/16" to 1/2", 60 number, 26 letter	8.0	3400073	49.99
O	115	Cobalt	1/16" to 1/2", 60 number, 26 letter	7.4	8314882	159.99

Drill Bits

TASK

Industrial HSS Drill Bits

Size	ITEM	PRICE (ea.)
1/16" *	3404845	1.99
5/64" *	3404852	2.29
3/32" *	3404860	2.59
7/64" *	3404878	2.79
1/8" *	3404886	2.99
9/64"	3404894	1.49
5/32"	3400003	1.59
11/64"	3400004	1.69
3/16"	3404928	1.99
13/64"	3404936	2.39

Size	ITEM	PRICE (ea.)
7/32"	3404944	2.59
15/64"	8276255	2.79
1/4"	3404969	2.99
9/32"	8276289	3.49
5/16"	3405008	3.99
11/32"	8276297	4.49
3/8"	3405040	4.99
13/32"	8276305	6.49
7/16"	8276313	7.49
15/32"	8276404	8.49
1/2"	3400095	9.99

* 2 bits per package

Titanium Drill Bits

Size	ITEM	PRICE (ea.)
1/16"	8276412	1.69
5/64"	8276438	1.89
3/32"	8276446	2.19
7/64"	8276453	2.29
1/8"	8276461	2.39
9/64"	8276479	2.69
5/32"	8276487	2.89
11/64"	8276495	3.19
3/16"	8276503	3.39
13/64"	8276511	3.69
7/32"	8276529	3.89
15/64"	8276537	4.19
1/4"	8276545	4.39
9/32"	8276552	5.89
5/16"	8276560	6.89
11/32"	8276578	7.89
3/8"	8276586	9.89
13/32"	8276594	11.99
7/16"	8276602	12.89
15/32"	8276610	13.99
1/2"	8276628	14.89

Cobalt Drill Bits

Size	ITEM	PRICE (ea.)
1/16"	3413945	2.39
5/64"	8276636	2.49
3/32"	8276644	2.69
7/64"	8276651	2.79
1/8"	3413986	3.29
9/64"	8276677	3.89
5/32"	8276685	3.99
11/64"	8276693	4.39
3/16"	3414026	4.79
13/64"	8276701	4.99
7/32"	8276719	5.49
15/64"	8276727	5.79
1/4"	3414034	5.99
9/32"	8276735	7.99
5/16"	3414042	8.99
11/32"	8276743	9.99
3/8"	3414059	11.99
13/32"	8276750	14.99
7/16"	8276768	16.99
15/32"	8276776	18.99
1/2"	8276784	19.99

Masonry Drill Bits

Size	ITEM	PRICE (ea.)
5/32"	8276800	4.49
3/16"	8276826	4.79
1/4"	8276834	5.99
5/16"	8276875	6.99

Size	ITEM	PRICE (ea.)
3/8"	8276883	7.99
1/2"	8276891	9.99
5/8"	8276909	16.99
3/4"	8276917	24.99

Countersink Bits

- For metal surfaces
- 1/4" shank
- Wt. 0.1 lb



Size	ITEM	PRICE/ea.
3/8"	8031015	5.99
1/2"	8031006	6.99
5/8"	8030980	7.99
3/4"	8030962	8.99

5 pc Metal HSS Countersink Bit Set (shown)

- 5/16", 3/8", 1/2", 5/8", 3/4"
- For use on metal, wood, or plastic
- 8000044 – Wt. 0.3 lb

24⁹⁹



15 pc Router Bit Set

- 1/4" shank
- 22,000 RPM max.
- Heavy duty tungsten carbide cutting edge
- 8126518 – Wt. 1.9 lb

29⁹⁹



3 pc Power Extension Bar Set

- Turns your drill into a nut driver
- 1/4", 3/8" and 1/2" drive
- 1/4" hex shank
- 3410174 – Wt. 0.2 lb

6⁹⁹

Power Bits

Type	Size	ITEM	PRICE
#1 Phillips	3"	8085276	1.99
#2 Phillips	3"	8085284	1.99
#1 Square	3"	8085292	1.99
#2 Square	3"	8085300	1.99
#3 Square	3"	8085318	1.99
#2 Phillips	6"	8085342	4.99
#1 Square	6"	8085359	4.99
#2 Square	6"	8085367	4.99



2 pc Power Bits

- 1/4" hex drive
- Cold forged for 3 times longer bit life
- S2 Alloy Steel



Type	Size	ITEM	PRICE
Phillips #2	2"	8255929	4.99
Phillips #2	6"	8255952	9.99
Square #2	2"	8255937	4.99
Square #2	6"	8255960	9.99
Slotted #2	2"	8255945	4.99
Phillips*	2-1/2"	8255986	4.99

* Magnetized

Step Drill Bits

	Description	Steps	Size Range	Wt. (lb)	ITEM	PRICE
A	Titanium Coated	9	1/4" to 3/4"	0.1	8256455	17.99
B	Titanium Coated	12	3/16" to 7/8"	0.2	8256471	19.99
C	Titanium Coated	13	1/8" to 1/2"	0.1	8256430	14.99
D	Spiral	12	3/16" to 7/8"	0.2	8263212	29.99
E	Spiral	13	1/8" to 1/2"	0.1	8263246	19.99

3 pc Titanium Coated Step Drill Bit Set

Set includes A, B and C
8256505 – Wt. 0.3 lb

39⁹⁹

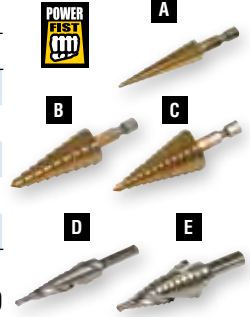

F) Tile Cutting Bit
1/8" shank
8005971 – Wt. 0.1 lb

G) Masonry Drill Bit Sets
• For percussion and rotary drilling
• Carbide tipped and chrome plated

5 pc
3/16", 1/4", 5/16", 3/8", and 1/2"
3410355 – Wt. 0.3 lb

8 pc
1/8", 5/32", 7/32", 1/4", 19/64", 21/64", 3/8", and 27/64"
8091233 – Wt. 0.4 lb

H) Wood Spade Bit Sets
• Cuts smooth holes in wood and particle board
• 1/4" hex shank

6 pc
3/8" to 1"
8285819 – Wt. 0.6 lb

13 pc
1/4" to 1"
8285827 – Wt. 1.4 lb

Power Nut Driver Sets

	# of pc	Sizes	Wt. (lb)	ITEM	PRICE
I	3 pc Long Magnetic	1/4", 5/16" and 3/8"	0.5	8288847	9.99
J	4 pc Magnetized	1/4", 5/16", 3/8", and 7/16"	0.3	3410778	8.99
K	7 pc Long	1/4" to 1/2"	1.2	8175127	19.99
L	7 pc	3/16" to 7/16"	0.2	8023676	13.99
M	8 pc	3/16" to 7/16"	0.3	8235962	9.99
N	8 pc Metric	5 to 11 mm	0.3	8305674	9.99
O	12 pc SAE	1/4" to 9/16"	1.5	8305955	19.99
P	12 pc Metric	8 to 14 mm	1.5	8305963	19.99

2 pc Drywall Screw Adapter

- Changes your power drill into an automatic screwdriver
- Ensures a proper countersink of screw
- 1/4" hex shank

2921633 – Wt. 0.1 lb **1⁹⁹**



12" Drill Extension

- 7/16" hex shank

8018833 – Wt. 0.9 lb **6⁹⁹**



Bit Extension Set

- 6" and 12" long
- Features dual setscrews for secure bit attachment

3410836 – Wt. 0.5 lb **6⁹⁹**



20 pc Driver Set

- 6", 12" and 18" extension drivers, screw guide and 16 pc bit holder set

8246985 – Wt. 1.8 lb **49⁹⁹**



A) 29 pc Drill Bit Holder
3411543 – Wt. 0.2 lb **4⁹⁹**

B) Drill Gauge

- Made of heavy gauge carbon steel
- 1/16" to 1/2" in 1/64" increments

3410362 – Wt. 0.2 lb **3⁹⁹**

C) 29 pc Metal Indexed Drill Bit Case

- Holds bit sizes 1/16" to 1/2"

8037812 – Wt. 0.9 lb **7⁹⁹**



Drill Bit Sharpening Jig

- 100 grit grinding stone quickly and easily sharpens drill bits from 5/64" to 1/2"
- Requires a power drill operating between 2,000 and 3,500 RPM

8089591 – Wt. 0.3 lb **8⁹⁹**

Drill Bit Sharpener Replacement Stone

8199481 – Wt. 0.3 lb **5⁹⁹**



7 pc Stop Collar Set

- Sizes: 1/8", 3/16", 1/4", 5/16", 3/8", 7/16", 1/2", and 2 hex keys

3400033 – Wt. 0.2 lb **4⁹⁹**



Bit Holders

- Extended driver for hard-to-reach areas
- Locking, magnetic, low profile, quick release



	Size	Flexible	Wt. (lb)	ITEM	PRICE
D	6"	No	0.2	8319964	5.99
E	12"	No	0.3	8319980	7.99
F	18"	No	0.5	8319915	9.99
G	8"	Yes	0.5	8319857	14.99
H	15-3/4"	Yes	1.0	8319899	19.99

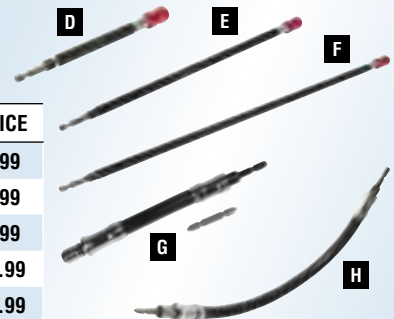

Nylon Abrasive Brushes

- Abrasive grit is impregnated throughout each bristle
- All brushes have a coarse grit
- Will not rust and maintains shape
- 1/4" shank
- Ideal for paint removal, corrosion, weld scale, surface rust and preparing metal surfaces for primers and paint

I) 1" Nylon End Brush
8170342 – Wt. 0.1 lb **5⁹⁹**

J) Nylon Abrasive Brushes

Size	Wt. (lb)	ITEM	PRICE
2"	0.1	8170359	5.99
3"	0.2	8170367	8.99
4"	0.3	8170375	9.99

K) 2" Nylon Cup Brush
8188054 – Wt. 0.1 lb **10⁹⁹**

L) 4" Flap Wheel Brush
8170391 – Wt. 0.3 lb **10⁹⁹**



Wire Brushes & Wheels

Ideal for paint removal, corrosion, weld scale, surface rust, and preparing metal surfaces for primers and paint

	Type	Size	Shank	Max. RPM	Wt. (lb)	ITEM	PRICE
M	Brass Coated Wheel	2"	1/4"	4,500	0.1	3410630	1.99
	Brass Coated Wheel	3"	1/4"	4,500	0.2	3410631	2.99
	Brass Coated Wheel	4"	1/4"	4,500	0.3	3410632	3.99
N	Twisted Stainless Steel Wire Wheel	3"	5/16"	12,500	0.3	3410646	4.99
O	Brass Cup	2"	1/4"	4,500	0.2	3410634	2.99
	Brass Cup	3"	1/4"	4,500	0.3	3410635	3.99
	Brass Cup	4"	5/16"	4,500	0.7	3410636	4.99
P	Twisted Stainless Steel Wire Cup	3"	5/16"	12,500	0.5	3410647	5.99
Q	1" Wire Tube Brush	1"	1/4"	-	0.1	8170417	4.99

Brushes



No sale is final until you're satisfied! We guarantee to make it right. We will repair, replace or refund any product to your satisfaction.

3 pc Brass Coated Brush Set

3410502 – Wt. 0.4 lb **6⁹⁹**

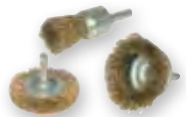

Chainsaw Sharpening



A) Chainsaw Sharpener with Work Light

- 2A
- No load speed: 3,600 RPM
- Bench or wall mount
- Includes 3 wheels

8279366 – Wt. 16.9 lb **189⁹⁹**

B) 12V Bar Mount Chainsaw Sharpener

- No load speed: 5,200 RPM
- Saves time by keeping the chain on the bar while sharpening
- Cord clamps to any 12V battery making this great for sharpening in the field
- Includes 1/8" and 3/16" stones

8310138 – Wt. 5.3 lb **149⁹⁹**



C) Chainsaw Sharpener

- 1.5A
- No load speed: 6,300 RPM
- 4" grinding disc

8252165 – Wt. 6.4 lb **59⁹⁹**

D) 9.6V Cordless Chainsaw Sharpener

- Rechargeable battery
- Variable speed up to 20,000 RPM

8301053 – Wt. 2.5 lb **49⁹⁹**



TECH TIP

Clean your chain with degreasing detergent before sharpening your chain. Also inspect for damaged or worn links which may cause the chain to break.

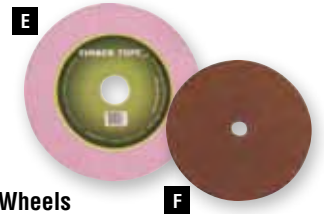

E) Chainsaw Sharpening Wheels

- 8279416 – 1/8" 19⁹⁹
- 8279432 – 3/16" 19⁹⁹
- 8279440 – 1/4" 19⁹⁹
- Wt. 0.5 lb

Replacement Grinding Wheels

- For 12V sharpener 8310138
- 1/8" 14⁹⁹
- 8310500 – Wt. 0.2 lb.

- 3/16" 14⁹⁹
- 8310518 – Wt. 0.2 lb.

- F) Chainsaw Wheel Replacement 3/16"** 5⁹⁹
- 8302721 – Wt. 0.3 lb

- Replacement Grinding Disc**
- For electric chain saw sharpener 8252165
- 8283269 – Wt. 0.2 lb **4⁹⁹**

Woodworking



DREMEL

M) Multi-Purpose Oscillating Tool

- 1.5A
- 21,000 OPM

8299869 – Wt. 3.5 lb **59⁹⁹**



N) Multi-Purpose Oscillating Tool Kit

- 1.5A
- Variable speed: 10,000 to 21,000 OPM

8341349 – Wt. 5.2 lb **159⁹⁹**



O) 5" Random Orbital Sander

- 3A
- No load speed: 12,000 OPM

8337883 – Wt. 3.8 lb **99⁹⁹**



P) Palm Detail Sander

- No load speed: 12,000 RPM
- Pad size: 5-1/2" x 5-1/2" x 3-1/8"
- 3 pc sandpaper (80, 100 and 120 grit)

8337446 – Wt. 2.3 lb **29⁹⁹**

10 pk Replacement Sandpaper

80, 120, 180 grit
8086407 – Wt. 0.1 lb **4⁹⁹**

G) Flush Cut Blade Assortment Pack

8302218 – Wt. 0.2 lb **11⁹⁹**

H) 2 Pack Scraper Blades

8302242 – Wt. 0.2 lb **7⁹⁹**

I) Flush Cut Blade for Wood/Metal

8302267 – Wt. 0.1 lb **8⁹⁹**

J) 3" Wood & Drywall Blade

8302226 – Wt. 0.2 lb **7⁹⁹**

K) 1/8" Grout Removal Blade

8302234 – Wt. 0.1 lb **12⁹⁹**

L) Assorted Sandpaper

8302259 – Wt. 0.3 lb **4⁹⁹**



freud

50 PC Wood Biscuits

Compressed hardwood biscuits for wood joining



Type	Size	ITEM	PRICE
#0	1-7/8" x 5/8"	8303026	4.99
#10	2-1/8" x 3/4"	8303034	4.99
#20	2-3/8" x 7/8"	8303042	4.99

Saws & Blades

TASK

Reciprocating Saw Blades

- Heavy duty bi-metal
- Wood cutting blades are made to cut asbestos, plastics, hard, soft and nail embedded woods
- High speed steel edge with alloy steel back for heavy duty, longer life performance

Blade Length	TPI	Type of Cut	ITEM	PRICE
*6"	10	Nail Cutting	3413184	4.49
*12"	6	Rough	3413200	9.49
†6"	14	Smooth	3413242	4.49
†6"	18	Extra Smooth	3413259	4.49
†6"	24	Fine	3413267	4.49

* Wood Cutting

†Metal Cutting

3 pc Heavy Duty Bi-Metal Demolition Saw Blades

- 9" long x 7/8" extra wide x 0.062" extra thick
- Long lasting, fast cutting for demolition work
- Cuts metal and pipe, heavy metal, plate contoured shapes and tubing

3410711 – Wt. 0.4 lb **29⁹⁹**



5 pk Jigsaw Blades

Type	TPI	Style	Wt. (lb)	ITEM	PRICE
Wood	6	Fine	0.1	8305096	9.99
Wood	9	Smooth Cut	0.1	8305088	10.99
Wood	12	Clean Cut	0.1	8305203	12.99
Wood	12	Fine Cut	0.1	8316366	14.99
Metal	24	Extra Fine	0.1	8305104	8.99
Metal	9	Coarse	0.1	8305070	9.99



3 pk Wood Cutting Blades

Type	TPI	Style	Wt. (lb)	ITEM	PRICE
Wood	10	Smooth	0.1	8180614	1.99
Metal	24	Extra Fine	0.1	8180622	3.99



A) Reciprocating Saw

- 9.5A
- Variable speed: 0 to 2,500 SPM
- Stroke: 1-1/8"

8271199 – Wt. 12.8 lb **99⁹⁹**

B) Reciprocating Saw

- 9A
- Variable speed: 0 to 2,800 SPM
- Stroke: 1-1/8"

8262461 – Wt. 8.9 lb **119⁹⁹**

3 pc 9" Reciprocating Saw Blade Sets

Type	Wt. (lb)	ITEM	PRICE
10	0.1	8258824	13.99
14	0.1	8258832	13.99
18	0.4	8258840	13.99
24	0.4	8258857	13.99

5 pc 6" Reciprocating Saw Blade Sets

Type	Wt. (lb)	ITEM	PRICE
10	0.2	8258774	11.99
14	0.2	8258790	11.99
18	0.2	8258808	11.99
24	0.2	8258816	11.99



5 pc 12" Reciprocating Saw Blade Sets

Type	Wt. (lb)	ITEM	PRICE
6	0.6	8258758	24.99

10 pc Reciprocating Saw Blade Set

1/2" universal shank

Type	Wt. (lb)	ITEM	PRICE
6-18 TPI	0.6	8155749	9.99

14 pc Reciprocating Saw Blade Set

1/4" universal shank

Type	Wt. (lb)	ITEM	PRICE
6-24 TPI	0.9	8155665	14.99



Jig Saws

	Amps	No Load Speed (RPM)	Stroke	Cutting Cap.		Quick Change	Bevels	Orbital	Laser	Wt. (lb)	ITEM	PRICE
				Wood	Steel							
C	6A	500 to 3,000	5/64"	3-15/16"	15/64"	Yes	Yes	Yes	Yes	6.7	8336125	69.99
D	3.9A	500 to 3,100	11/16"	2-9/16"	1/4"	No	Yes	Yes	No	7.6	8285272	99.99

Dust Collectors

Collects airborne dust and debris from your work area

E) 1 HP Mini Dust Collector

- 914 CFM
 - Fan diameter: 6"
- 8353229 – Wt. 17.7 lb **149⁹⁹**

F) 1 HP Dust Collector

- 600 CFM
 - Fan diameter: 9"
- 8353237 – Wt. 59.5 lb **199⁹⁹**



G) 2 HP Dust Collector

- 1790 CFM
 - Fan diameter: 11.8"
- 8359622 – Wt. 95.0 lb **299⁹⁹**



NEED A NEW BLADE?

Princess Auto carries a variety of blades and cutting wheels for our assortment of circular saws, chop saws and tile saws. Please see page 150 for a full selection.



Circular Saws

	Description	Amps	No Load Speed	Max. Cutting Capacity			Lights/Laser	Bevel	Magnesium Housing	Wt. (lb)	ITEM	PRICE
				45°	90°	56°						
A	7-14"	15A	5,000 RPM	1-11/16"	2-7/16"	-	Laser	No	Yes	14.1	8340481	89.99
B	7-1/4" Worm Gear	14A	4,600 RPM	1-3/4"	2-1/4"	-	No	No	No	18.2	8340499	119.99
C	7-1/4"	15A	5,800 RPM	0° - 2-1/2"	1-3/4"	1-3/8"	Twin lights	Yes	No	14.6	8336380	139.99



D) Wood Cutting Saw Blades

- 7-1/4"
8,200 RPM max.
24 Teeth
8121154 – Wt. 0.6 lb..... **4⁹⁹**
- 40 Teeth
8121162 – Wt. 0.6 lb..... **6⁹⁹**
- 10"
5,300 RPM max.
28 Teeth
8121170 – Wt. 1.6 lb..... **19⁹⁹**
- 40 Teeth
5,300 RPM max.
8121188 – Wt. 1.6 lb..... **24⁹⁹**



- E) 7-1/4" Metal Cutting Saw Blade
• Carbide tipped
• 6,000 RPM max.
8058885 – Wt. 0.8 lb..... **34⁹⁹**

- F) 7-1/4" Circular Saw Blade
• 24 teeth
• 8,300 RPM max.
8270639 – Wt. 0.5 lb..... **12⁹⁹**
Ultra Coated (shown)
8270647 – Wt. 0.5 lb..... **14⁹⁹**



4-1/2" Hand Held Diamond Saw

- 10A
- No load speed: 11,800 RPM
- Max. cutting depth: 1-1/4"
- Water attachment for wet cutting
3400249 – Wt. 8.0 lb..... **89⁹⁹**

- 4-1/2" Replacement Diamond Blade
8292013 – Wt. 0.2 lb..... **6⁹⁹**



50" Aluminum Cutting Guide

- 3 position cam lock action
- Powerful jaws with rubber insert
8309783 – Wt. 5.0 lb..... **29⁹⁹**



7" Bench Mount Diamond Saw

- 3.75A
- 3,600 RPM
- Built-in reservoir for wet cutting
- Suitable for cutting granite, tile, marble, brick, concrete, and other non-metal material
- Tilting table 0° to 45°
8000365 – Wt. 29.6 lb..... **79⁹⁹**



Electric Planer

- 6.5 A
- No load speed: 16,000 RPM
8301251 – Wt. 9.8 lb..... **79⁹⁹**



Circular Saw Bag

- 8265837 – Wt. 2.6 lb..... **24⁹⁹**



10" Wet Tile Saw with Stand

- 2.5 HP
- 3,450 RPM motor
- No load speed: 2,700 RPM
- 10" continuous rim, thin cut kerf
- Submersible water pump with filter
- 45° miter block and 90° rip guide
8130239 – Wt. 110.0 lb..... **399⁹⁹**



10" Diamond Cutting Blade

- 8053373 – Wt. 1.7 lb..... **24⁹⁹**

Replacement Pump

- 8116808 – Wt. 1.1 lb..... **24⁹⁹**



G) Paint Mixer

- 3"W x 16"L
- Designed to be used with a variable speed drill
8003399 – Wt. 0.5 lb..... **4⁹⁹**



H) Electric Paint Spray Gun

- 1.0A
- Flow rate: 4.1 GPH
- 30 oz (1 litre) polypropylene canister
- Great for small to medium projects, such as decks, fences and furniture
8144297 – Wt. 4.2 lb..... **34⁹⁹**

Got a question

about one of our products?



Post a customer review at princessauto.com! We'll answer the question for your benefit and for other guests.

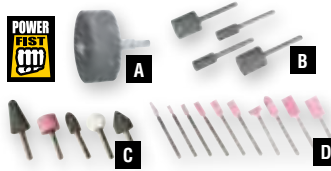

A) 2-1/2" x 1" Grinding Stone
 • 1/4" shank
 • Aluminum oxide
 • 25,000 RPM max.
8121360 – Wt. 0.4 lb **2⁹⁹**

B) 4 pc Mounted Bit Set
 • 1/8" shank
 • 30,000 RPM max.
8121527 – Wt. 0.1 lb **2⁹⁹**

C) 5 pc Grinding Stone Sets
 • 25,000 RPM max.

Type	ITEM	PRICE
Small	3410225	3.99
Medium	3415387	5.99

D) 10 pc Grinding Stone Set
 • 1/8" shank
 • 2" long
 • 25,000 RPM max.
3410187 – Wt. 0.1 lb **6⁹⁹**

5 pc Shaping/Cutting Set
 • For rounding, shaping and patterning woods, soft non-ferrous metals, plastics and rubber
 • 1/4" shank
 • 20,000 RPM max.
3410297 – Wt. 0.4 lb **5⁹⁹**

3 pc Collet Set
 1/8", 3/32", and 1/4"
3410313 – Wt. 0.1 lb **8⁹⁹**

6 pc Collet Set
 0.8 to 1.0 mm, 1.3 to 1.5 mm, 1.8 to 2.0 mm, 2.2 to 2.4 mm, 2.8 to 3.0 mm, and 3.0 to 3.2 mm collets
8112211 – Wt. 0.1 lb **2⁹⁹**



158 pc Die Grinder and Cutting Kit
 • 1/8" shank dia.
8005851 – Wt. 0.8 lb **19⁹⁹**

E) 3 pc HSS Rotary File Set
 1/4" shank
 25,000 RPM max.
8121352 – Wt. 0.2 lb **19⁹⁹**

F) 6 pc HSS Rotary File Set
 For drilling, shaping and deburring metal, wood and plastic
8121345 – Wt. 0.4 lb **39⁹⁹**

Rotary Tool Accessories
 • For cutting hard and soft metal
 • High speed tool steel
 • 1/4" shank
 • 6,000 RPM max.
1/2" x 1-1/4" Rotary Files
 Wt. 0.1 lb
2990018 – Cylindrical
2990034 – Tapered Round **10⁹⁹/ea**

3 pc Rotary File Set (not shown)
 1/2" x 1-1/4" cylinder, 1/2" x 3/4" ball, 1/2" x 1-1/4" cone
2990307 – Wt. 0.2 lb **28⁹⁹**

8 pc Rotary Steel Cutter Set
 • Contains various sizes and shapes of rotary cutters
 • Use on metal, wood, or plastic
3410125 – Wt. 0.1 lb **9⁹⁹**

Diamond Point Bit Sets
 • 1/8" shank
 • Assorted diamond point grinding bits
 • 25,000 RPM max.
 • 150 grit
20 pc
8139917 – Wt. 0.2 lb **6⁹⁹**
10 pc (Shown)
8111890 – Wt. 0.4 lb **7⁹⁹**
30 pc
8048993 – Wt. 0.3 lb **9⁹⁹**

5/8" Stainless Steel Mini Wire Brush
 • 25,000 RPM max.
8053900 – Wt. 0.1 lb **1⁹⁹**

5 Pc Mini Bristle & Wire Brush Set
 • Use for cleaning and polishing metal
 • 1/8" and 3/32" shanks
8053189 – Wt. 0.1 lb **4⁹⁹**



Die Grinders & Accessories



Electric Die Grinder
 • 4.5A
 • No load speed: 25,000 RPM
 • 1/4" collet
8336844 – Wt. 4.7 lb **69⁹⁹**



DREMEL
13 pc Dremel Rotary Tool Kit
 • 1.15A
 • No load speed: 35,000 RPM
 • 12 accessories including EZ-Lock mandrel and 2 EZ-Lock cutting wheels)
8341372 – Wt. 1.8 lb **49⁹⁹**



Rotary Tool
8352965 – Wt. 2.2 lb **19⁹⁹**



Rotary Tool Accessories
 • Carbide burr with a 1/8" shank
 • Designed for drilling and shaping all ferrous metals and stainless steel
 Wt. 0.1 lb



G) Mandrel
 1/4" shank
 • Designed for drilling and shaping all ferrous metals and stainless steel
3414562 – Wt. 0.2 lb **6⁴⁹**

H) Mandrel
 • 1/4" and 3/8" arbor, 1/4" shank
 • 18,000 RPM max.
2970002 – Wt. 0.1 lb **3⁹⁹**

C) Mandrel with Backing Pad
 • 1/4" dia. mandrel with nickel plating
 • 2" dia. roll on type backing pad
8235970 – Wt. 0.2 lb **5⁹⁹**

8144057 – Cylinder Carbide Burr
8144073 – Ball Carbide Burr
8144081 – Pear Carbide Burr
8144107 – Tampered Ball Nose Carbide Burr (shown)
8144065 – Ball Nose Carbide Burr
8144115 – Flame Carbide Burr
8144123 – Tapered Carbide Burr **5⁹⁹/ea**

Heat Guns

Heat Gun
 • Up to 500°C
 • 2 temperature settings
8259210 – Wt. 1.8 lb **19⁹⁹**



Dial Control Heat Gun
 • Infinitely variable temperature setting gives you greater precision and flexibility
 • Up to 500°C
 • 2 speed/flow settings up to 17.5 CFM
8290850 – Wt. 2.0 lb **29⁹⁹**



Digital Control Heat Gun
 • Infinitely variable temperature settings using digital control
 • Up to 500°C
 • 2 speed/flow settings up to 17.5 CFM
8327835 – Wt. 2.0 lb **49⁹⁹**

pro.point



Sanding & Polishing



A) Orbital Sander/Polisher

- 6" pad size
 - No load speed: 4,000 RPM
- 8336877 – Wt. 3.2 lb. **29⁹⁹**

B) Orbital Sander/Polisher

- 10" pad size
 - No load speed: 3,200 RPM
 - Includes terry cloth bonnet and synthetic wool bonnet
- 8336885 – Wt. 7.0 lb. **34⁹⁹**



7" Sander/Polisher

- No load speed: 0 to 3,000 RPM
 - 1 rubber pad, hook and loop pad, wool bonnet and 10 pc sandpaper
- 8336349 – Wt. 9.8 lb. **89⁹⁹**

2 pc Bonnets

- Fits 8336349 7" sander/polisher
- 8090896 – Wt. 0.1 lb. **4⁹⁹**

Wool

- 8090888 – Wt. 0.2 lb. **9⁹⁹**

3 pc Polishing Bonnet Set

- Includes terry applicator pad, terry polishing pad, and wool buffing pad
 - Fits 8005931 - 10" buffer / polisher
- 8084907 – Wt. 0.3 lb. **5⁹⁹**

7" Sanding Discs with Hook and Loop

- Wt. 0.2 lb
- 8090771 – 60 grit
 - 8090813 – 80 grit
 - 8090821 – 100 grit
 - 8090839 – 120 grit
 - 8090854 – 180 grit
- **4⁹⁹**

8" Wool Buffing Pad

- Hook and loop backing pad
- 8342354 – Wt. 0.4 lb. **9⁹⁹**



1/4" shank, 12,000 RPM max. (no load)

Style	Size	Wt. (lb)	ITEM	PRICE
Cylinder	Small	0.1	8125932	3.49
Cylinder	Large	0.3	8125957	4.99
Mushroom	Small	0.1	8125262	3.49
Mushroom	Large	0.3	8125288	4.99
Taper	Small	0.2	8125874	3.49
Taper	Large	0.2	8125908	4.99

Buffing Wheel

- 4" buffing wheel with 1/4" shank
 - 2,500 RPM max.
- 3411050 – Wt. 0.2 lb. **4⁹⁹**



3 pc Felt Bob Set

- 1/4" shank
 - 25,000 RPM max.
- 8145930 – Wt. 0.1 lb. **7⁹⁹**



C) Treated Buffing Wheels

- 6", 1/2" Bore
- 8066607 – Wt. 0.4 lb. **6⁹⁹**
- 8", 5/8" Bore
- 8066656 – Wt. 0.7 lb. **11⁹⁹**

D) 80 ply Loose Sewn Buffing Wheels

- 6", 1/2" Bore
- 8066490 – Wt. 0.5 lb. **7⁹⁹**
- 8", 5/8" Bore
- 8066482 – Wt. 0.8 lb. **11⁹⁹**

E) 80 ply Treated Cloth Buffing Wheels

- 6", 1/2" Bore
- 8066615 – Wt. 0.5 lb. **9⁹⁹**
- 8", 5/8" Bore
- 8066649 – Wt. 0.8 lb. **11⁹⁹**
- 10", 5/8" Bore
- 8066573 – Wt. 0.9 lb. **14⁹⁹**

F) 6" Buffing Wheel

- Perfect for polishing metal, plastic and hard rubber
 - 1/2" bore, 1/2" thick
- 3414844 – Wt. 0.3 lb. **7⁹⁹**

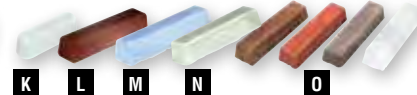

Polishing Compounds

- For use on buffing wheels
- Polishes brass, copper, gold, and stainless steel

- K) 1 oz White Jewellers Rouge**
3410095 – Wt. 0.1 lb. **1⁹⁹** /ea

- L) 4 oz Red Jewellers Rouge**
2944494 – Wt. 0.4 lb. **2⁹⁹**

- M) 4 oz Blue Polishing Compound**
For polishing plastic and metal
8066466 – Wt. 0.4 lb. **4⁹⁹**

- N) 4 oz Green Polishing Compound**
For polishing hard metal and stainless steel
8066474 – Wt. 0.4 lb. **4⁹⁹**

- O) 4 pc Polishing Compound**
Black emery, red rouge, brown tripoli, and white diamond
2940427 – Wt. 1.4 lb. **9⁹⁹**



Polishing/Buffering Kits

- G) 2 pc Mini**
- For polishing metal and plastic
 - 30,000 RPM max.
 - 1" wool wheel, 1-1/2" cloth wheel and 1/8" mandrel
- 8125965 – Wt. 0.1 lb. **1⁹⁹**

H) Mini Jewelry Set

- Contains 3 polishing wheels, 1/8" mandrel, and stick of polishing compound
- 3410132 – Wt. 0.1 lb. **4⁹⁹**

I) 14 pc Aluminum

- Polishing compounds, buffing wheels, buffs, felt bobs
 - 15,000 RPM max.
- 8263014 – Wt. 1.8 lb. **24⁹⁹**

J) 18 pc Deluxe

- Polishing compounds, buffing wheels, buffs, felt bobs
 - 15,000 RPM max.
- 8263022 – Wt. 2.6 lb. **34⁹⁹**



hard.working.tools.



EXCLUSIVELY AT: PRINCESS AUTO



METAL WORKING



Metal Lathe

- 1/3 HP variable speed motor
- 7" x 12" mini metal lathe
- Swing over bed: 7"
- Distance between centres: 12"
- Spindle taper: MT#3
- 100 to 2,500 RPM variable spindle speed
- Tailstock taper: MT#2
- Threading range: SAE 12 to 52 TPI in 18 steps, metric 0.4 to 2.0 mm in 10 steps
- 3" chuck with reversible jaws



8120974 – Wt. 88.2 lb **599⁹⁹**

Quick Change Cutter Rest

For use with 8120974

8144636 – Wt. 2.6 lb **59⁹⁹**

1/2 HP Milling Machine

- Heavy duty cast iron body and base for added stability
- Includes drill and chuck key, shaft and chuck key assembly, and wrenches
- Bed dimensions: 15-3/8" x 3-5/8"
- Two speed ranges: 0 to 1,100 RPM (low), 0 to 2,500 RPM (high)
- Spindle taper: MT#3 with JT33 chuck taper
- End mill capacity: 1/2"
- Face mill capacity: 1"
- Table slot width 1/2"

8145096 – Wt. 151.8 lb **799⁹⁹**



8 pc End Mill

- For use with milling machine 8145096
- 1/8", 3/16", 1/4", 3/8", 5/16", 1/2", 9/16", and 5/8"

8145112 – Wt. 0.8 lb **49⁹⁹**



Silver & Deming Drill Bit Sets

- 1/2" shank
- 9/16" to 1"

8 pc
3400215 – Wt. 4.1 lb **59⁹⁹**

Titanium Coated Silver & Deming Drill Bit Sets
5 pc
3410934 – Wt. 2.7 lb **29⁹⁹**

8 pc
3410935 – Wt. 4.2 lb **69⁹⁹**



Sulfo™ Dark Cutting Oil

- For high-speed machines
- Speeds work by more than 50%
- Superior lubricity and anti-weld properties
- Increases tool life by reducing heat due to friction
- **NOT FOR USE AS A BANDSAW COOLANT**

6420084 – Wt. 8.1 lb **34⁹⁹**



4 Litre Cutting Oil/Coolant

- Water soluble
- Protects material from rust and corrosion
- Suitable for machining, cutting, tapping, and as a coolant for bandsaws

8034012 – Wt. 8.4 lb **19⁹⁹**



16-Speed Drill Press

- 3/4 HP
- 6.6A
- 16 speeds
- Speeds: 210 to 3,340 RPM
- Swing: 13"
- Chuck size: 5/8" (16 mm)
- Spindle taper: MT 2
- Table size: 11-1/2" (Round)

3462090 – Wt. 133.8 lb **299⁹⁹**



Metal Working Accessories

Drill Press Vises

- Will also fit standard power tool tables and bases
- Hardened steel jaw faces
- Cold-rolled steel screw
- Flanged base



Size	Jaw Width	Max. Jaw Opening	Base Length	Base Width	Wt.(lb)	ITEM	PRICE
2"	2-1/2"	2-1/4"	5-1/4"	5-1/4"	2.6	3431814	11.99
3"	3"	2-3/4"	6-3/4"	5-3/4"	4.4	3430204	14.99
4"	4"	3-5/8"	7-1/2"	6-1/2"	5.7	3430212	19.99
5"	5"	5-1/4"	9-3/4"	8"	8.2	3430220	24.99
6"	6"	5-3/4"	10-3/8"	8-3/4"	12.0	3430238	29.99

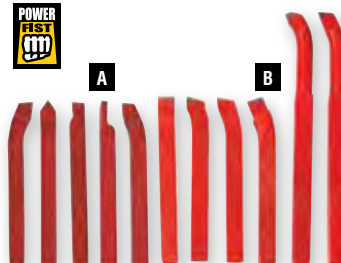

Lathe Cutting Bit Set

- A) 5 pc
- Carbide tips
 - Bar turning tool
 - Straight finishing tool
 - Right and left hand cranked knife tool
 - Parting tool

8120982 – Wt. 0.4 lb **29⁹⁹**

- B) 6 pc
- Carbide tips
 - Cranked turning/facing tool
 - Cranked facing tool
 - Cranked knife tool
 - Rough boring tool
 - Inside corner tool
 - Recessing tool
- 8120990 – Wt. 0.6 lb **39⁹⁹**

Drill Bits

- 1/2" shank

Size	Wt. (lb)	ITEM	PRICE
9/16"	0.3	3410867	6.99
5/8"	0.4	3410883	7.99
11/16"	0.4	3410990	8.99
3/4"	0.4	3411030	9.99
13/16"	0.5	3411063	12.99
7/8"	0.5	3411253	14.99
1"	0.6	3411303	16.99



Chucks

Key for 5/8" Chuck
3460073 – Wt. 0.1 lb **1⁹⁹**

1/2" Capacity, JT-33 Taper
3460034 – Wt. 0.9 lb **14⁹⁹**

5/8" Capacity, JT-33 Taper
3460035 – Wt. 1.4 lb **19⁹⁹**

Bandsaws



Portable Bandsaw

- 6.5A
- Variable speed: 0 to 240 FPM max.
- Wheel blade guide for precise cuts

8106783 – Wt. 13.5 lb **119⁹⁹**



pro.point

3-1/2" Band Saw

- Lightweight aluminum body is ideal for handheld as well as bench mounted cutting
- 4A
- No load speed: 2,700 to 6,300 RPM
- Blade size: 52-9/16" x 1/2" x 0.025" x 10 TPI
- Blade speed: 115 to 262 FPM

8354789 – Wt. 52.3 lb **349⁹⁹**



Heavy Duty 7" Metal Cutting Band Saw

- 3/4 HP
- Volts: 115 or 230V AC
- No load speed: 1,720 RPM
- Blade size: 3/4" x 93" x 0.032" x 8 TPI
- Blade speeds: 86, 132, 178, and 260 FPM

3460015 – Wt. 330.0 lb **1199⁹⁹**



Carbon Steel Flexback Bandsaw Blades

- Reduces operating expense in mild steels
- Good for pipe, tubing, solids, and all mild steels
- 14 teeth/in

Size	Wt. (lb)	ITEM	PRICE
68" x 1/2" x 0.025"	0.2	3460024	19.99
93" x 3/4" x 0.032"	0.6	3460022	24.99



Carbon steel Bandsaw Blade

- Reduces operating expense in mild steels
- Good for pipe, tubing, solids, and all mild steels
- 14 teeth/in

Size	Wt. (lb)	ITEM	PRICE
64-1/2" x 1/2" x 0.025"	0.2	3460748	10.99



Heavy Duty Matrix Bimetal Bandsaw Blades

- High resistance to heat and wear
- High shock resistance
- Variable pitch reduces vibration
- Long life and faster cutting
- Good for cutting any machinable metal, conduit, angle iron, rebar and stainless steel
- Bimetal blades provide longer life than carbon steel blades

Size	TPI	Wt. (lb)	ITEM	PRICE
64-1/2" x 1/2" x 0.025"	14	0.2	3462280	24.99
68" x 1/2" x 0.025"	10/14	0.2	3460048	39.99
93" x 3/4" x 0.035"	10/14	0.7	3460047	49.99
97-1/2" x 1" x 0.035"	8/12	1.0	8002192	59.99



*Variable pitch



Bandsaw Blades

- For bandsaw 8106783
8008039 – Wt. 0.2 lb **9⁹⁹**
- For bandsaw 8106783
8004754 – Wt. 0.2 lb **15⁹⁹**
- For bandsaw 8045518
8130536 – Wt. 1.0 lb **59⁹⁹**



Roller Stands

pro.point

3-Way Roller Stand

- Three functions: ball stand, roller stand & firm stand
- Adjustable height: 28" to 44"
- Max. capacity: 440 lb

8359598 – Wt. 6.0 lb **59⁹⁹**

F) Adjustable Roller Stand

- Ideal for use with pipe or other round stock
- 6" x 1-3/8" dual rollers
- Adjustable height: 28" to 49"
- Max. capacity: 100 lb

8049202 – Wt. 6.0 lb **24⁹⁹**

G) Folding Roller Stand

- 2" x 11-3/4" polished steel roller
- Folds flat for easy storage
- Adjustable height: 27-1/2" to 43"
- Max. capacity: 130 lb

8044653 – Wt. 8.9 lb **29⁹⁹**

6 pc Roller Ball Set

- Max. cap.: 55 lb/ball
- 5/8" dia. ball with mounting screws

8006882 – Wt. 0.6 lb **14⁹⁹**



12" Bench Mount Roller

- 2" x 11-3/4" roller
- 130 lb cap.

8003466 – Wt. 2.7 lb **14⁹⁹**



Welcome to our Unique World!



Home of an outstanding shopping experience, every time!

**LINCOLN[®]
ELECTRIC**
THE WELDING EXPERTS[®]

CENTURY
[®]

PRINCESS AUTO



**PRINCESS AUTO CARRIES A FULL
SELECTION OF WELDING PRODUCTS**

SPECIAL ORDERS AVAILABLE

www.lincolnelectric.ca

Welding



MIG Welders

- Includes gas regulator and 52' hose for use with CO2 or argon blend gases, spool of 0.025" MIG wire and 0.035" flux-cored wire, contact tips, nozzles, work clamp and 10 ft cable
- Also comes with instructional manual, how to use DVD, and learn to weld manual
- Optional Magnum®100SG spool gun for aluminum welding sold separately (#8201261)

Lincoln Easy MIG 140 Welder

- 120V, 20A input
- DC output: 30 to 140A
- Duty cycle: 20% @ 90A
- Wire feed speed: 50 to 500 inches per minute
- Welding capacity: 24 gauge to 5/16"

8193724 – Wt. 72.5 lb **649⁹⁹**

Lincoln Easy MIG 180 Welder

- 208/230V, 20A input
- DC output: 30 to 180A
- Duty cycle: 30% @ 130A
- Wire feed speed: 50 to 500 inches per minute
- Welding capacity: 24 gauge to 1/2"

8193740 – Wt. 80.3 lb **779⁹⁹**



Lincoln Electric Welders

LINCOLN ELECTRIC ARC WELDERS

are ideal for farm, shop, and home use where improved arc welding performance is desired. Useful stick welding power source for maintenance, repair, fabrication, cutting and piercing holes in steel, construction and hardfacing applications.

Lincoln AC225 Stick Welder

- 230V, 50A input
- AC output: 40 to 225A
- Duty cycle: 20% @ 225A
- Maximum rod size: 3/16" diameter general purpose mild steel electrodes and 5/32" sizes of other electrodes
- Produces a smooth AC arc for welding a variety of materials including carbon, low alloy, cast iron & stainless steels

8148660 – Wt. 109.0 lb **369⁹⁹**



Lincoln AC/DC 225/125 Stick Arc Welder

- 230V, 50A input
- AC output: 40 to 225A
- AC duty cycle: 20% @ 225A
- DC output: 30 to 125A
- DC duty cycle: 20% @ 125A
- The AC/DC 225/125 is the deluxe version of the AC225 model, featuring a smoother, more stable DC welding arc

8241911 – Wt. 124.0 lb **699⁹⁹**



Lincoln Magnum 100SG Spool Gun Kit

- Lightweight, semi-automatic spool gun designed for reliable aluminum wire feeding
- Attaches to Easy MIG 140 and Easy MIG 180 welders
- Duty cycle: 30% @ 130A
- Wire feed speed: 50 to 650 inches per minute
- 1 lb, 4" diameter wire spool capacity, and capable of feeding 0.030" or 0.035" diameter wire size
- Included: 3 contact tips, 1 spool of 0.035" (0.9 mm) aluminum alloy 4043 wire, electrical harness with toggle switch, operating manual, carrying case
- For use with aluminum alloy: 4043 and 5356

8201261 – Wt. 10.1 lb **299⁹⁹**



Lincoln P20 Plasma Cutter

- 120V, 20A input
- DC output: 10 to 20A
- Duty cycle: 50% @ 15A
- Duty cycle: 40% @ 20A
- Open circuit voltage: 310V DC
- Severs (metal) up to 1/4", rated cut up to 1/8"
- Plugs into standard 15A receptacle; however, a 20A circuit is recommended to get the most power out of the machine

8257487 – Wt. 23.7 lb **1199⁹⁹**



WHY CHOOSE PLASMA?

While oxyfuel was the most common method of cutting carbon steel in the past, plasma cutting is gaining favour for the following reasons:

- Plasma cuts faster than oxyfuel, and the kerf (width of cut) is small
- A preheat cycle is not required, and a smaller heat-affected zone prevents or minimizes warping and paint damage to surrounding areas
- Plasma cutting can be used on any type of electricity-conducting material (oxyfuel cannot cut stainless steel or aluminum)
- Plasma cutting is cleaner and less expensive. Clean, dry air is used for most applications.

Welders



A) Flux-Cored Welder

- 120V, 20A input
 - AC output: 90A
 - AC duty cycle: 20% @ 65A
 - Wire feed speed: 70 to 300 inches per minute
 - Variable wire speed, and live wire trigger
 - Welding capacity: 20 gauge up to 1/8"
- 8209686** – Wt. 38.1 lb **199⁹⁹**

B) MIG Welder

- 120V, 20A input
 - DC output : 75A
 - AC duty cycle: 20% @ 75A
 - Wire feed speed: 98 to 750 inches per minute
 - Variable wire speed, and cold wire trigger
 - Welding capacity (metal): 22 gauge up to 1/8"
- 8154700** – Wt. 55.3 lb **249⁹⁹**

C) MIG Welder

- 230V, 20A input
 - DC output: 105A
 - AC duty cycle: 20% @ 105A
 - Wire feed speed: 98 to 800 inches per minute
 - Variable wire speed, cold wire trigger
 - Welding capacity: 20 gauge up to 3/16"
- 8154718** – Wt. 61.5 lb **299⁹⁹**



Century 90A Arc / TIG Inverter Welder

- 120V, 15A input
 - DC output (arc welder): 10 to 90A
 - Duty cycle: 20% @ 70A
 - DC welding capacity: 18 gauge to 1/4"
 - 10 ft work cable with small Dinse® connector and clamp, 10 ft electrode holder with small Dinse® connector
 - Can be used with optional TIG kit, item #8236812 (sold separately)
- 8261877** – Wt. 15.9 lb **399⁹⁹**

70A Arc Welder

- 120V, 20A input
 - AC output: 80A
 - Duty cycle: 20% @ 55A (low heat setting for 1/16" electrodes)
 - Duty cycle: 10% @ 70A (high heat setting for 5/64" electrodes)
 - Welding capacity: up to 10 gauge
 - Includes 3 x E6013 1.6 mm electrodes
 - Automatic thermal shut down
- 8169385** – Wt. 28.9 lb **129⁹⁹**



Wire Feed / MIG Accessories

MIG WELDING TECH TIP

Torch position affects the quality and appearance of the welding head.

Backhand Welding: The wire is kept in the molten pool

Forehand Welding: The wire is pushed out of the molten pool



Upright MIG Welding Cart

- Allows for easy access to welder controls and occupies less floorspace
 - Holds small to medium size arc and MIG welders with single gas cylinder
 - Hangers for holding MIG gun and ground clamp
- 8069213** – Wt. 33.0 lb **99⁹⁹**

Welding Contact Tips

These tips fit most brands of welding guns including Century/Solar, Lincoln, and Deca



Qty	0.023"	0.030"	0.035"	PRICE/pk
6	8221947	8221954	8221962	5.99
10	0142554	0142562	0142570	12.99



MIG Torch Stand with 4" Magnetic Base

For holding MIG welding torches
8162851 – Wt. 1.6 lb **13⁹⁹**

MIG Welding Video

Instructional DVDs for hobby and intermediate welders alike
8132193 – Wt. 0.2 lb **29⁹⁹**



Multi-Use Welder's Tool

Use to clean spatter from nozzles, remove and install tips, or cut wire
8088593 – Wt. 0.8 lb **9⁹⁹**



A) 16 oz Anti-Spatter Nozzle Shield Spray

- Acts as a plating agent on sprayed surfaces for welding nozzles, contact tips, and electrode holders
 - Brush or wipe residual spatter away and requires no cleaning prior to spraying
- 0142497** – Wt. 1.2 lb **5⁹⁹**



B) 16 oz MIG Nozzle Dip

Prevents spatter build up on MIG tips and nozzles
0140172 – Wt. 1.0 lb **6⁴⁹**



Welding Accessories



Air Cooled 150A TIG Torch

- Air cooled torch with 12-1/2 ft cable and 12-1/2" gas hose with Dinse® style 25 mm connector
- Comes "ready to weld" equipped with 1/16" (1.6 mm) collet, collet body, 2% thoriated tungsten electrode and # 6 alumina cup
- DC duty cycle: 60% @ 150A
- AC duty cycle: 60% @125A
- Electrode range: 0.020"– 1/8"

8236812 – Wt. 3.5 lb **99⁹⁹**



Magnetic TIG Gun Holder

- For holding TIG welding torches
- Protect your gun from drops and damage to the nozzle, tip, or trigger

8162869 – Wt. 1.6 lb **13⁹⁹**



10 pk TIG Electrodes

1 lb Mild Steel TIG Filler Rods

1/16" x 36" long
8067738 – Wt. 1.0 lb **7⁹⁹**

Lanthanated Tungsten TIG Electrodes

1/16" x 7" long
8067787 – Wt. 0.2 lb **15⁹⁹**

1/16" x 36" long
8067761 – Wt. 1.1 lb **16⁹⁹**

Ceriated Tungsten TIG Electrodes

- 1/16" x 7" long
- Tungsten steel with 2% ceriate

8215766 – Wt. 0.2 lb **19⁹⁹**



2 pk Nickel Silver Brazing Rods

- Ideal for stainless steel, cast iron, nickel, and brass
- Widely used to repair bicycles, metal furniture, railing, and radiators
- 85,000 PSI tensile strength with an 816°C (1,500°F) working temperature
- Flux coated

0141127 – Wt. 0.1 lb **4⁹⁹**

Welding Extension Cords

- 8/3 gauge STW cord
- NEMA 6-50 ends
- 250V, 40A rating
- Lighted ends

25 ft
8249336 – Wt. 11.5 **89⁹⁹**

50 ft
8249344 – Wt. 22.0 **149⁹⁹**



Canvas Welder Cover

- Made from flame retardant, mildew resistant and water repellent canvas
- Made to cover small wire feed welders

8292062 – Wt. 0.7 lb **29⁹⁹**



Welding Wire Lube Pads

- Remove dust and dirt from the wire prior to wire entry into the liner
- Use of wire feed pads can decrease the friction in the liner by as much as 60%, reducing erratic wire feeding and burn backs

8162877 – Wt. 0.1 lb **9⁹⁹**



Leather Welding Rod Pouch

8056160 – Wt. 0.5 lb **9⁹⁹**



8089732 – Wt. 0.5 lb **8⁹⁹**

4 pk Low Fuming Bronze Brazing Rods

- Easy to apply, general purpose brazing rod
- Recommended for repair of steel, cast iron, copper base metals, galvanized and malleable irons
- 60,000 PSI tensile strength with an 871°C (1,600°F) working temperature
- Flux coated

0141119 – Wt. 0.1 lb **4⁹⁹**

2 pk Aluminum Soldering Rods

- Ideal for soldering aluminum windows, doors, and joints on boats, gutters & siding
- Brinell hardness rating of 100 with a 399°C (750°F) working temperature

0141135 – Wt. 0.1 lb **4⁹⁹**



Gas Regulators & Flow Meters

Argon / CO2 Regulator

- Control argon gases up to 30 CFH (15 L/min.) and 3,000 PSI
- 1/4" MNPT outlet, includes 1/4" hose barb adapter
- CGA580 inlet tank connection

8082471 – Wt. 2.1 lb **79⁹⁹**



Argon / CO2 Adapter

- Allows argon gas regulator (CGA580 connection) to be used on standard CO2 tank (CGA320 connection)
- Fits Powerfist regulator 8082471 and flowmeter 8082497

8095325 – Wt. 0.4 lb **9⁹⁹**



Argon / CO2 Flowmeter Kit

- Provides more accurate flow information than standard regulators
- Control argon gases up to 60 SCFH and 4,000 PSI
- Includes 10 ft hose
- Inlet: CGA580, outlet: 5/8"-18RH

8082497 – Wt. 3.3 lb **109⁹⁹**



Argon Hose

10 ft
8307118 – Wt. 1.4 lb **12⁹⁹**

25 ft
8307126 – Wt. 3.2 lb **24⁹⁹**



Surface Mount Welder Receptacle

- Accepts up to #4 gauge wire
- 250V, 50A
- NEMA 6-50 receptacle
- 2-pole 3-wire for surface mounting

0141200 – Wt. 0.7 lb **14⁹⁹**



Male Welder Plug

- Accepts up to #4 gauge wire
- 250V, 30A or 50A Convertible to NEMA 6-30 or 6-50 applications

0141218 – Wt. 0.5 lb **16⁹⁹**



Oxy-Acetylene / Cutting Kits

pro.point

Harris Style Welding & Cutting Kit

- Kit will cut up to 6" and weld up to 3/8"
- Includes 1 set of flashback arrestors and check valves
- Kit includes: torch handle, oxygen and acetylene regulators, cutting attachment with cutting tip, welding tip, 15 ft twin hose, goggles, flint lighter and tip cleaner

8345076 – Wt. 20.9 lb **299⁹⁹**



Victor Style Welding & Cutting Kit

- Kit will cut up to 8" and weld up to 1/2"
- Includes 1 set of flashback arrestors and check valves
- Kit includes: torch handle, oxygen and acetylene regulators, cutting attachment with cutting tip, welding tip, 15 ft twin hose, goggles, flint lighter and tip cleaner

8345084 – Wt. 22.0 lb **299⁹⁹**



A



B



Cutting Kits

A) Harris Style Welding & Cutting Kit

- Kit will cut up to 1" and weld up to 3/16"
- Kit includes: torch handle, oxygen and acetylene regulators, cutting attachment with #1 cutting tip, #3, #5 and #7 welding tips, 15 ft twin hose, goggles, flint lighter and tip cleaner

0110742 – Wt. 16.1 lb **229⁹⁹**

B) Victor Style Welding & Cutting Kit

- Kit will cut up to 1/2" and weld up to 3/16"
- Kit Includes: torch handle, oxygen and acetylene regulators, cutting attachment with #0 cutting tip, #0, #2 and #4 welding tips, #6 heating tip, 15 ft twin hose, goggles, flint lighter and tip cleaner

0110239 – Wt. 15.9 lb **229⁹⁹**

Oxy-Acetylene Accessories

C



C) Oxy-Acetylene Welding Hose

- "B" type ends
- Fits all standard oxy-acetylene kits
- Max. pressure: 200 PSI
- Grade R

25 ft Long
0140213 – Wt. 6.0 lb **29⁹⁹**

50 ft Long
0140212 – Wt. 11.8 lb **39⁹⁹**

D) Oxy-Acetylene Welding Hose Reel

- 1/4" x 50 ft grade "T" hose, for use with all fuel gases

• Max pressure: 200 PSI
8201055 – Wt. 39.8 lb **149⁹⁹**

E) Flashback Arrestor Set

- Prevents flame flashbacks into hose
- Max. pressure (acetylene): 21 PSI
- Max. pressure (oxygen): 210 PSI

0140274 – Wt. 0.5 lb **29⁹⁹**

D



E



F



F) Hose to Regulator Quick Connector Sets

Wt. 0.5 lb
8010261 – Hose to Regulator
8059940 – Hose to Torch Head **34⁹⁹** /ea

G



G) Torch Circle Cutting Guide

- Cuts straight lines and circles (max. 30" dia.).
- For medium duty torches

Wt. 1.2 lb
0140006 – Harris Style
8076705 – Victor Style **19⁹⁹** /ea

Oxy-Acetylene Welding Cart

- 12" wheels roll smoothly over rough terrain
- Supplies can be contained in the 4-5/8" x 21-1/4" x 3-1/2" deep tool tray
- Base: 9-1/2" x 20-1/2"

8006521 – Wt. 41.8 lb **99⁹⁹**



Tip Cleaners

- 12 cleaners and a small file
- For cleaning small orifices on oxy-acetylene torch tips

0141002 – Wt. 0.1 lb **3⁹⁹**



2" Regulator Gauges

1/4" NPT
Wt. 0.3 lb
0110053 – 0 to 30 PSI Acetylene Gauge
0110054 – 0 to 200 PSI Oxygen Gauge
0110056 – 0 to 4,000 PSI Oxygen Gauge **9⁹⁹** /ea



Oxy-Acetylene Harris Style Cutting Tip



Tip Size	Cutting Cap.	Wt. (lb)	ITEM	PRICE
6290-1	5/8" to 1"	0.2	8006483	9.99
6290-2	1" to 2"	0.2	8006485	9.99
6290-3	2" to 3"	0.1	8006487	9.99

Propane & Natural Gas Harris Style Cutting Tip



Tip Size	Cutting Cap.	Wt. (lb)	ITEM	PRICE
6290-1-NX	5/8" to 1"	0.2	8006488	9.99
6290-2-NX	1" to 2"	0.1	8006489	9.99

Propane & Natural Gas Victor Style Cutting Tip



Tip Size	Cutting Cap.	Wt. (lb)	ITEM	PRICE
0-3GPN	1/2"	0.1	8006479	9.99
1-3GPN	3/4"	0.1	8006482	9.99

Propane & Natural Gas Victor Style Heavy Duty Cutting Tip



Tip Size	Cutting Cap.	Wt. (lb)	ITEM	PRICE
0-GPN	1/2"	0.2	8006471	9.99
1-GPN	3/4"	0.2	8006473	9.99

Victor Style Welding Tip with Mixer



Tip Size	Welding Cap.	Wt. (lb)	ITEM	PRICE
#0	1/32" to 5/64"	0.2	8078909	12.99
#2	5/64" to 1/8"	0.2	8078917	12.99

Oxy-Acetylene Victor Style Cutting Tip



Tip Size	Cutting Cap.	Wt. (lb)	ITEM	PRICE
0-3-101	1/2"	0.1	8006475	9.99
1-3-101	3/4"	0.1	8006477	9.99
2-3-101	1-1/2"	0.1	8006478	9.99

Oxy-Acetylene Victor Style Heavy Duty Cutting Tip



Tip Size	Cutting Cap.	Wt. (lb)	ITEM	PRICE
0-1-101	1/2"	0.2	8006466	9.99
1-1-101	3/4"	0.2	8006468	9.99
2-1-101	1-1/2"	0.2	8006469	9.99

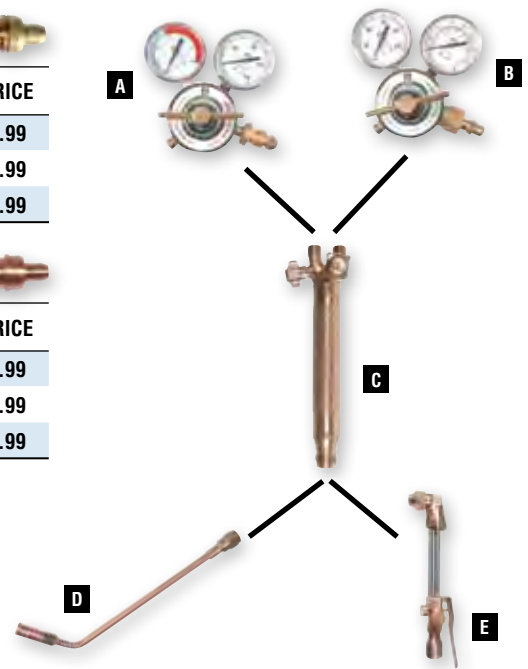

Oxy-Acetylene Welding Accessories

	Description	Specifications	Wt. (lb)	ITEM	PRICE
A	Acetylene Regulator	Recommended working pressure: 20 PSI Max pressure: 30 PSI Max. flow: 530 SCFH	3.4	8079006	79.99
B	Oxygen Regulator	Recommended working pressure: 145 PSI Max. pressure: 200 PSI Max. flow: 3,000 SCFH	3.5	8078982	79.99
C	Harris Style Torch Handle	Forged brass body	1.2	8078958	49.99
	Victor Style Torch Handle	Forged brass body	0.9	8078842	49.99
D	Harris Style Torch Handle	Forged brass body, Stainless steel tubes	1.9	8078966	69.99
	Victor Style Torch Handle	Forged brass body, Stainless steel tubes	1.0	8078867	69.99
E	Harris Style Heating Tip	#1 tip size	0.7	8176372	19.99
	Victor Style Heating Tip	#6 tip size	0.4	8078933	19.99

Wire Brushes



F) 10" Carbon Steel Wire Brush

4 x 16 row
0140715 – Wt. 0.2 lb **99¢**



G) 10" Brass Brush

0140129 – Wt. 0.2 lb **1.99**



H) 10" Carbon Steel Brush

• 4 x 17 row
• Solvent proof
8252876 – Wt. 0.4 lb **2.99**



I) 14" Carbon Steel Wire Brush

• 3 x 19 row
• With hardened and ground steel scraper
• Solvent proof
8252819 – Wt. 0.4 lb **2.49**



J) 14" Stainless Steel Brush

8252827 – Wt. 0.4 lb **3.49**



K) 14" Brass Brush

8252835 – Wt. 0.4 lb **3.99**



L) 7" x 2-1/2" Carbon Steel Brush

• 6 x 19 row
• Threaded hole for broom handle (sold separately)
8252843 – Wt. 0.6 lb **3.49**



M) 10" Tempered Steel Wire Brush

5 x 31 row
8005946 – Wt. 0.7 lb **5.99**



Brushes Sets

A) 3 pc Mini

Bristle material: nylon, brass, stainless steel

8252801 – Wt. 0.3 lb **1⁹⁹**

B) Nylon, Brass & Steel Bristle

0140491 – Wt. 0.4 lb **3⁹⁹**

C) 3 pc Wire

- Solvent proof brushes
- Bristle material: Nylon, brass, and stainless steel

8252868 – Wt. 0.4 lb **4⁹⁹**

B



C



Heavy Duty Wire Brushes

11" Tempered Steel Wire Brush
0140098 – Wt. 0.4 lb **3⁴⁹**

4 x 18 Row Wire Brush
Wt. 0.4

0140101 – Stainless steel bristles
0140099 – Brass bristles **4⁹⁹** /ea



Stainless Steel Round Brush

14" long
2940029 – Stainless steel bristles

17" long
2940015 – Brass bristles
Wt. 0.1 lb **1⁹⁹** /ea

Welding Accessories



Welding Ground Clamps

D) 200A
0140228 – Wt. 0.4 lb **8⁹⁹**

E) 500A
0140798 – Wt. 1.2 lb **16⁹⁹**

F) 300A
8134207 – Wt. 0.6 lb **5⁹⁹**

F) 500A
0140699 – Wt. 1.3 lb **9⁹⁹**

G) 300A Alerco Style
0140264 – Wt. 1.4 lb **17⁹⁹**

G) 500A Alerco Style
0140265 – Wt. 1.5 lb **19⁹⁹**

Electrode Holders

H) 300A Tweeco Style
8134231 – Wt. 1.3 lb **9⁹⁹**

I) 400A Bernard Style
0140681 – Wt. 1.2 lb **14⁹⁹**

F

G

H

I

J

K

L

M

Flint Lighters

J) Single Flint Lighter
8068587 – Wt. 0.1 lb **2⁹⁹**

K) 5 pk Replacement Flints
For single flint lighter 8068587
0140142 – Wt. 0.1 lb **1⁵⁹**

L) Triple Flint Lighter
8001746 – Wt. 0.3 lb **4⁴⁹**

M) 4 pk Replacement Flints
For triple flint lighter 8001746
0140140 – Wt. 0.1 lb **3⁹⁹**

Arrow Style Welding Magnets

- Ideal for holding metal while tack welding, soldering and pipe installation
- Holds metal at 45°, 90°, and 135° angles

N) Medium (15 lb cap)
8089351 – Wt. 0.8 lb **3⁹⁹**

O) Large (35 lb cap)
8089369 – Wt. 1.4 lb **5⁹⁹**

P) X-large (60 lb cap)
8089377 – Wt. 2.5 lb **8⁹⁹**

Q) Welding Magnets
Holds metal at 45°, 90°, and 135° angles
8178790 – Wt. 0.6 lb **5⁹⁹**

R) 50 lb Swivel Welding Magnet
Magnets swivel 360°
8244873 – Wt. 3.5 lb **9⁹⁹**

S) 45° x 90°, 25 lb Cap Arrow Style
Welding Magnet
• With quick release switch
• Ideal for any metalworking, welding, or fabrications
• For angle, square, or round stock
• 45° x 90° MAGNET
8136244 – Wt. 1.1 lb **16⁹⁹**

T) Multi-Angle Welding Magnet (15 lb Cap)
Holds metal at 30°, 45°, 60°, 75°, and 90° angles
8178808 – Wt. 0.6 lb **3⁹⁹**

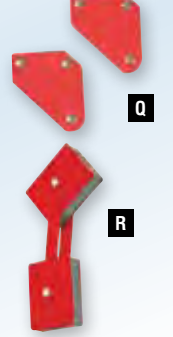
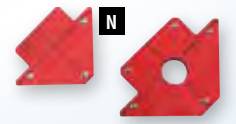

Lugs

1/2" mounting hole
Solder On Welding Lug
Fits 1/0 and 2/0 cables
8009282 – Wt. 0.1 lb **3⁹⁹**

2 pc Lugs
Fits #2 and #4 cables
0140250 – Wt. 0.1 lb **4⁹⁹**



2 pc Hammer On
Copper Welding Plugs
• No crimping required
• 1/2" mounting hole
8072571 – Fits 1 & #2 cables
8072563 – Fits 1/0 & 2/0 cables
Wt. 0.4 lb **9⁹⁹** /ea

9" Chipping Hammer

Forged steel head, shaft, and spring handle
0140806 – Wt. 1.1 lb **4⁹⁹**



12" Chipping Hammer

5-1/2" head
0140229 – Wt. 1.8 lb **6⁹⁹**



Welding Cable



- Flex-a-prene, a tough EPDM jacket
- Extra flexibility for extreme temperatures -50° to 105°C (-58° to 220°F)
- Great for welders and heavy duty booster cables



#	Strands	Max. Amps	Wt. (lb)	ITEM	PRICE
4	406	140	0.2	8228041	1.59
2	648	190	0.3	8227548	2.49
1	804	220	0.3	8228058	2.99
1/0	1026	260	0.4	8228066	3.49
2/0	1273	300	0.5	8228074	4.29

* Rated @ 100 Ft / 240V



Welding Wire Crimper

Used to crimp on battery and welding cable lugs

8167926 – Wt. 7.1 lb **79⁹⁹**

25 ft Welding Cable



#	Strands	Max. Amps	Wt. (lb)	ITEM	PRICE
4	406	150	3.7	8257966	44.99
2	648	250	6.0	8257990	64.99
1	804	300	8.0	8258006	74.99

Welding Cable Connectors

- 2 genderless housings and 4 electrical contacts supplied
- Used for reliable high amperage connections such as on generators, winches, inverters, and battery connections

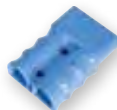

Style	Max. Current	#	Wt. (lb)	ITEM	PRICE
Anderson SB175	600V, 175A	2	0.6	8201915	29.99
		4	0.6	8201899	29.99
		1/0	0.5	8201923	29.99

Welding Cable Connectors

Dinse® International style



Size	Jack Dia. (mm)	Wt. (lb)	ITEM	PRICE
#4 Cable Female	9	0.1	8222721	5.99
#4 Cable Male	9	0.1	8222697	5.99
#2 Cable Pair	9	0.2	0140013	9.99
#2 Cable Female	12	0.7	0140014	12.99
#2/0 Cable Female	12	0.7	0140016	12.99

Welding Extension Cable Connector

- Lenco style
- Suitable for multiple sizes of welding cable
- Comes complete with shivs and allen wrench



For #6 to #1 cable
0140202 – Wt. 0.7 lb

For 1/0 & 2/0 cable
0140267 – Wt. 1.0 lb **12⁹⁹**

Welding Markers



Thermomelt® Heat-Stik®

Ideal for applications such as annealing, forging, welding, bending, forming and any place where temperature measuring is necessary

Temp	Wt. (lb)	ITEM	PRICE
65.5°C	0.1	8340523	12.99
93°C	0.1	8340549	12.99
120°C	0.1	8340572	12.99
150°C	0.1	8340580	12.99
175°C	0.1	8340598	12.99
204°C	0.1	8340606	12.99

24 oz Fibreglass Welding Blanket

- Max. temp: 538°C
- 6 ft x 6 ft
- Resists general purpose welding, sparks, splatter and abrasion

8162836 – Wt. 5.5 lb **99⁹⁹**

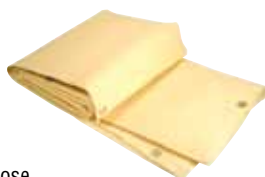

Arc Welding Video 1

Includes all you need to know to get started using your arc welder through narrative and excellent video

8132185 – Wt. 0.2 lb **29⁹⁹**

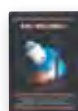

6 ft x 6 ft Portable Welding Screen

Welding screens offer optical safety, spark containment

0192775 – Wt. 18.6 lb **129⁹⁹**



Welding Helmets & Goggles



Solar Powered Auto Darkening Welding Helmets

- 1/25,000 second switching speed with variable sensitivity, delay, and shade
- Variable shade: #9 to 13
- 3-13/16" x 1-5/8" lens
- UV/IR protection up to shade 16 (DIN)
- Automatic powerON / OFF with adjustable delay time
- Replaceable lens covers (8093601 - external; 8113623 - internal)
- High impact-resistant nylon shell

Wt. 1.8 lb

A) 8078172 – Black 89⁹⁹

B) 8111437 – Flames 99⁹⁹

5 pc Replacement Internal Lenses

3-13/16" x 1-13/16" 8113623 – Wt. 0.1 lb 4⁹⁹

5 pc Replacement External Poly Clear Lenses

4-5/8" x 3-3/4" 8093601 – Wt. 0.2 lb 8⁹⁹

C) Shade #11 Flip Front Helmet

- Constructed of a lightweight but durable vulcanized fibre material
- Flip-front lens retainer and ratchet-adjustable headgear
- 2" x 4-1/4" lens

0140083 – Wt. 1.1 lb 12⁹⁹

D) Shade #10 Wide View Welding Helmets

Wt. 1.4 lb 8116881 – Black 19⁹⁹

8116899 – Flames 27⁹⁹

E) Shade #11 Wide View Flip Front Welding Helmet

0140005 – Wt. 1.4 lb 29⁹⁹

Replacement Welding Helmet Headgear

- Ratchet adjustable headgear with padded headband
- Fits 0140083 and other non-autodarkening helmets

8070138 – Wt. 0.3 lb 4⁹⁹



Replacement Lenses



Suggested Amperage Range					Shade	Tinted Glass			Gold Poly			Tinted Glass		
(MMA) Arc	(FCAW) Flux MIG	(GMAW) Gas MIG	(GTAW) TIG	2" x 4-1/4"		Wt. (lb)	PRICE /ea	2" x 4-1/4"	Wt. (lb)	PRICE /ea	4-1/2" x 5-1/4"	Wt. (lb)	PRICE /ea	
< 20	< 75	-	< 5	8	-	-	-	-	-	0140020	0.2	3.99		
20-40	75-125	< 40	5-7	9	0141382	0.1	1.99	0140143	0.1	8.99	0140038	0.3	3.99	
40-80	125-175	40-80	17-35	10	0140186	0.1	1.99	0140144	0.1	8.99	0140046	0.3	3.99	
80-175	175-225	80-125	35-100	11	8175952	0.1	1.99	12	12	12	8175960	0.3	3.99	
175-300	225-280	125-175	100-150	12	8176018	0.1	1.99	-	-	-	8175986	0.3	3.99	

2" X 4-1/4" Poly Magnifying Lenses

Power	Wt. (lb)	ITEM	PRICE
1.5x	0.1	0140147	6.99
2.0x	0.1	0140148	6.99
2.5x	0.1	0140149	6.99

Clear Replacement Lenses
Wt. 0.1 lb
0140023 – 2" x 4-1/4" 59[¢]
8000745 – 4-1/2" x 5-1/2" 1⁴⁹



G) Shade #5 Oxy-Acetylene Welding Goggles

- Soft vented vinyl covering provides snug fit and fits over glasses
- Flip up front lenses and use clear lenses underneath for use while chipping or grinding
- 2" x 4-1/4" lens

0140939 – Wt. 0.4 lb 6⁹⁹

H) Shade #5 Oxy-Acetylene Welding Goggles

- Fitted goggles with soft brow and nose guard ensures comfort and snug fit
- Side vents to increase airflow

8002530 – Wt. 0.1 lb 9⁹⁹

I) Metalworking Goggles

- Clear PVC lens with vented frame
- Blocks both UVA and UVB rays

8102568 – Wt. 0.1 lb 9⁹⁹

F) Shade #5 Oxy-Acetylene Welding Goggles

- Soft vented vinyl covering provides snug fit and fits over glasses
- Flip up front lenses and use clear lenses underneath for use while chipping or grinding

0140947 – Wt. 0.3 lb 6⁹⁹

Welding Gear & Helmet Bag

- Large capacity main compartment with drawstring closure
- Front pocket with hook and loop closure
- Two mesh side pockets can hold welding gloves up to 14" or water bottle
- Fits all sizes of welding helmets and safety shields

8165458 – Wt. 0.8 lb 24⁹⁹



J) Canada Welding Beanie

8057443 – Wt. 0.1 lb 1⁹⁹



K) Welding Beanie

8041113 – Wt. 0.1 lb 4⁹⁹

Welding Wear



A) Split Leg Leather Welding Apron

Kevlar sewn
8308165 – Wt. 1.6 lb **34⁹⁹**

B) Leather Welding Apron

- Split leather apron
- Kevlar sewn

8308132 – Wt. 1.6 lb **39⁹⁹**

C) Welding Jacket

- Split cowhide
- Kevlar sewn

8308173 – Wt. 4.9 lb **89⁹⁹**

Welder's Heat Shield

- Reflective aluminum shield over leather pad
- 2 elastic straps hold it in place
- Reflects excess heat away from glove during welding applications
- O'all dim.: 6" x 8-1/4"

8179335 – Wt. 0.1 lb **4⁹⁹**



PROBAN™

PROBAN™ is a chemical that is used to impart a durable flame-retardant treatment to cotton and other cellulose fibres and blends.



Proban™

D) Welding Sleeves
18" long with 2-1/4" elastics at both ends
8222440 – Wt. 0.4 lb **14⁹⁹**

E) Lightweight Welding Jacket
Size: X-Large, 30" length
8222333 – Wt. 1.2 lb **39⁹⁹**

Leather Helmet Bib / Neck Protector

- Split cowhide leather
- Attaches to bottom of helmet with metal clips and is designed to protect neck form sparks and spatter
- Fits most standard welding helmets

8243032 – Wt. 0.1 lb **6⁹⁹**



Welding Gloves



Welding Gloves

Glove Name	Leather Type	O'all Length	Stitch Material	Lining	ITEM	PRICE
F The Hacker	Split Cowhide	11-1/2"	Cotton	Unlined	8268385	5.99
G The Pipeliner	Split Cowhide	13"	Cotton	Cotton Fleece Lining	8268419	7.99
H Blue welders	Split Cowhide	12-1/2"	Cotton	Cotton Fleece	8268450	8.99
I Fabricator	Cowhide Palm/ Split Cowhide back	12"	Cotton	Cotton Fleece Lined Palm	8268369	9.99
J Firebrand	Split Cowhide	13"	Kevlar®	Cotton	8268401	9.99
K Welding series	Split Cowhide	13"	Kevlar®	Fleece Lined with Foam Backing	8268443	9.99
L Tigger	Split Deerskin	12"	Kevlar®	Unlined	8268393	12.99
M Foam welder	Deerskin Grain Palm, Split Cowhide Back	13-1/2"	Kevlar®	Foam Lined Back	8271918	24.99
N Buck weld	Split Elkhide	12-1/2"	Kevlar®	Unlined	8268427	29.99



Quality since 1918



At Watson Gloves, quality materials and above-and-beyond customer service go hand-in-glove. You can count on Watson for:

- **Quality:** Every pair of gloves we sell has been hand-selected for top-of-the-line materials, design and craftsmanship.
- **Service with a Smile:** Our experienced team of specialists is committed to our customers' complete satisfaction with each and every pair of Watson gloves purchased.
- **Innovation:** We commit to staying one step ahead of our customers; anticipating their needs and bringing the most advanced gloves for just about any job imaginable.

Soldering

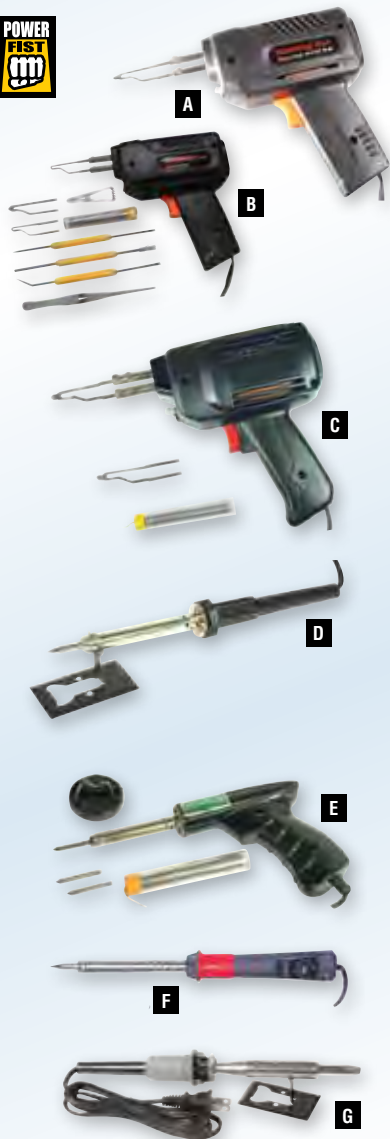

A) Pistol Grip Dual Heat Soldering Gun
 • 140/100W
 • Double insulation
 • Built-in light to illuminate work
3410938 – Wt. 2.0 lb **24⁹⁹**

B) 9 pc Solder Gun Kit
 • 100W with general purpose tip, and plastic cutting replacement tip
 • Includes heat sink, 3 accessory tools, solder, and sturdy plastic case
8241937 – Wt. 3.1 lb **34⁹⁹**

2 pc Soldering Tip Set
 For soldering kit 8241937
8004231 – Wt. 0.1 lb **5⁹⁹**

C) Professional Soldering Gun
 • 230/150W
 • Dual stage trigger: 150W – 503°C (low power), 230W – 760°C (high power)
 • Built-in light to illuminate work
 • 15 g of solder and 2 general purpose tips included
8005107 – Wt. 4.0 lb **39⁹⁹**

2 pc Soldering Tip Set
8289522 – Wt. 0.1 lb **4⁹⁹**

D) Pencil Soldering Iron with Stand
 45W
3410020 – Wt. 0.4 lb **9⁹⁹**

E) Pistol Grip Soldering Iron
 • 35W
 • Includes solder, stand, and 2 replacement tips
3412426 – Wt. 0.6 lb **14⁹⁹**

F) Soldering Iron with Adjustable Control
 • 60W
 • Adjustable heat control
8103590 – Wt. 0.6 lb **17⁹⁹**

G) Heavy Duty Soldering Iron with Stand
 • 80W
 • For stained glass and other projects
 • 3/8" wide flat tip
8175077 – Wt. 0.5 lb **19⁹⁹**

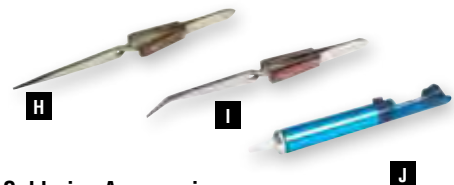

Soldering Accessories
 Wt. 0.1 lb
H) 2920065 – Straight Point **2⁹⁹** /ea
I) 2920064 – Curved Point **2⁹⁹** /ea
J) Vacuum Desoldering Tool
3410022 – Wt. 0.2 lb **7⁹⁹**

SOLDER PASTE

is a mixture of solder and flux for targeted applications. Semi-solid consistency allows for easy dispensing. Use with a lighter, torch, etc. for fast, effective repairs. Lead-free.



K) Aluminum Solder Paste
 • Flows at 200°C
 • Used to join aluminum to aluminum or aluminum to other metals
 • Tensile strength: 28,000 PSI
8141483 – Wt. 0.1 lb **8⁹⁹**

L) Silver Bearing Solder Paste
 • Flows at 220°C
 • For electrical connections, or use with copper, brass, bronze, platinum, chrome, stainless, and nickel
 • Tensile strength: 10,000 to 25,000 PSI
8127003 – Wt. 0.1 lb **7⁹⁹**

M) Auto Plastic Weld
 • Heat activated epoxy flows at 90°C
 • Provides permanent repairs for plastic ABS radiator tanks, bumper covers, fenders or virtually any plastic part
 • May be drilled, sanded, tapered and painted
8127029 – Wt. 0.1 lb **10⁹⁹**



5-in-1 Energy-Saving Multi-Function Tool Kit
 • 20W
 • Ceramic heating element
 • Heats up in 50 seconds as a 35W soldering iron
8243214 – Wt. 0.4 lb **12⁹⁹**



N) Paste Flux
 • High quality Orange Crush™ paste flux
 • For use with lead and lead free solder
 • 2 oz
8001061 – Wt. 0.2 lb **5⁹⁹**



O) Soldering Flux Paste
 • Use with all lead free solders and soft solders
 • Cleans as you solder
 • Non toxic
 • 4 oz
6440023 – Wt. 0.3 lb **6⁹⁹**

P) Pure Bond Solder
 • Lead free: 97% tin, 3% copper
 • For household plumbing
 • 4 oz
8011929 – Wt. 0.3 lb **9⁹⁹**
 • 8 oz
8011938 – Wt. 0.5 lb **19⁹⁹**

Q) Rosen Core Solder
 • CONTAINS LEAD
 • 4 oz roll
 • For electronics
8170045 – Wt. 0.3 lb **9⁹⁹**

Butane Torches



A) Piezo Start Micro Torch

- Built-in Piezo igniter
- Adjustable flame
- Butane burns at 1,300°C
- 2 hour burn time per butane fill

0141010 – Wt. 0.4 lb **14⁹⁹**

B) Soldering Iron / Butane Torch

- The multi tip kit allows this kit to be useful for many applications from soldering pipe and cutting rope to shrink wrapping wires
- Adjustable flame

• Micro torch, hot knife tip, chisel point tip, large solder tip, fine point solder tip, hot blower tip, 0.9 oz rosin core solder, cleaning sponge & stand
8257529 – Wt. 0.5 lb **29⁹⁹**

C) Tech Torch Kit

- Electronic ignition
- Large metal fuel tank
- Adjustable flame
- Included: connector / blower attachment, fine point soldering tip, chisel soldering tip, Ronson multi-fill butane refill

8239923 – Wt. 1.0 lb **39⁹⁹**

D) Butane Gas

Universal fueling tip
1.5 oz

8147423 – Wt. 0.2 lb **3⁴⁹**

6 oz

6420035 – Wt. 0.5 lb **5⁴⁹**

RONSON

Propane Torches

BERNZOMATIC  MADE IN CANADA



E) Propane Fuel

16.9 oz
8229692 – Wt. 1.9 lb **5⁴⁹**

F) Pro MAPP Gas

- Produces a much hotter flame than propane
- Ideal for brazing and welding
- 16.9 oz

8236739 – Wt. 2.0 lb **11⁹⁹**

G) Propane Torch

Includes 16.9 oz propane cylinder

8232118 – Wt. 2.4 lb **16⁹⁹**

H) Swivel Head Torch MAPP Kit

- Solid brass regulator pressure regulated to burn in any direction
- 360° rotating burn tube with trigger igniter and adjustable flame control

8260960 – Wt. 2.8 lb **49⁹⁹**

I) Instant Light Propane Torch

- Torch lights instantly with the touch of a finger
- Comfortable, easy-to-hold grip built into torch
- Includes 16.9 oz propane cylinder

8232100 – Wt. 2.6 lb **39⁹⁹**

J) Trigger Start Torch MAPP Gas Kit

- Instant ON / OFF trigger igniter with simple one-handed operation
- Lock on button
- Fracture groove for enhanced safety in case torch is dropped

8260986 – Wt. 3.3 lb **64⁹⁹**

K) Cutting, Welding and Brazing Torch Kit

- OX2550 Cutting, welding, and brazing torch
- 16.9 Fat Boy Max Power propylene fuel cylinder
- 9.1.1 cu ft oxygen cylinder

8305278 – Wt. 5.0 lb **74⁹⁹**

L) Hose & Gas Torch MAPP Kit

- 5-foot hose for maximum accessibility and mobility
- Instant ON / OFF trigger igniter for simple one-handed operation

- High intensity swirl flame targets heat output and provides a hotter, more efficient flame
- Adjustable flame control knob for ease in switching between different applications

- Solid brass regulator is pressure-regulated to burn in any direction

- Stainless steel burn tube constructed for durability and built to last

- Lock button keeps torch lit for finger-free use
- Includes cylinder holster

8261000 – Wt. 4.0 lb **99⁹⁹**

NEW 

Instant Start Torch with Hose

- Instant on/off trigger igniter for simple one-handed operation
- Burner tube and connector, 3.3 ft hose
- Use with standard and MAP propane gas cartridge
- Ideal for all soldering and brazing projects

8381592 – Wt. 1.7 lb **59⁹⁹**

Precision Burner Torch

- Use with a standard propane gas cartridge (not included)
- Ideal for electrical applications
- Self-igniting with adjustable flame control
- Operates at any angle

0140084 – Wt. 0.5 lb **19⁹⁹**
Propane not included

Swivel Tube Torch

- Black housing with stainless steel tube
- 360° swivel angle tube with easy ON / OFF valve
- Temp: 1,980°C for MAPP gases, 1,370°C for propane

8007060 – Wt. 0.5 lb **24⁹⁹**

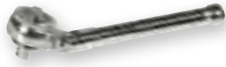

1/4" dr Flex Head Stubby Ratchet

- 7-position handle with built-in spinner flexes 90°
- 4-1/2" long

8056275 – Wt. 0.3 lb **9⁹⁹**

3-in-1 Ratchet

- Chrome vanadium steel
- 1/4", 1/2" and 3/8" dr
- 72 teeth

8159105 – Wt. 0.8 lb **16⁹⁹**



3 pc Fingertip Ratchet Set

- 1/4" dr, 42 teeth
- 3/8" dr, 38 teeth
- 1/2" dr, 45 teeth

8151656 – Wt. 0.8 lb **12⁹⁹**



Breaker Bars



pro.point

	Type	Dr	Length	Wt. (lb)	ITEM	PRICE
A	Ratcheting Breaker Bar	1/2"	18"	2.8	8364432	29.99
		1/2"	24"	3.6	8355257	34.99
B	Ratcheting Sliding T-Bar	1/2"	18"	2.2	8306516	19.99
C	Ratcheting Breaker Bar	3/4" dr	24"	5.9	8306797	49.99

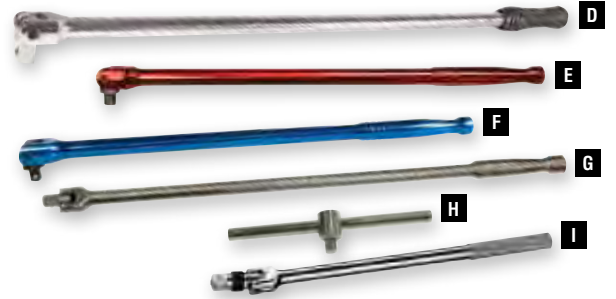

	Type	Dr	Length	Wt. (lb)	ITEM	PRICE
D	Breaker Bar	1/2"	18-3/4"	2.5	8355208	17.99
		1/2"	25"	3.1	8355174	21.99
E	Metallic Red	3/8"	18"	2.0	8224743	19.99
		1/2"	25"	2.8	8214256	24.99
F	Metallic Blue	3/4"	36"	6.8	8224750	54.99
		3/8"	18"	1.9	8254963	19.99
G	Gunmetal Grey	1/2"	25"	2.9	8254989	24.99
		3/4"	36"	7.0	8254997	54.99
H	Sliding T-Bar	3/8"	18"	2.0	8255036	21.99
		1/2"	25"	2.9	8255051	27.99
I	Quick Release	3/4"	36"	6.8	8255069	59.99
		3/8"	6-1/2"	0.3	2920347	4.99
H	Sliding T-Bar	1/2"	9-3/4"	0.8	2920349	6.99
		3/4"	17-3/4"	2.7	2920350	18.99
I	Quick Release	3/4"	21"	4.4	8263162	29.99



Breaker Bars

Heavy-duty heat-treated and hardened chrome-vanadium steel for strength and durability

3/8" dr 15"
3/8" female drive for addition of ratchet for extra torque and strength
8380453 – Wt. 2.7 lb **18⁹⁹**

1/2" dr 18"
End of handle with 1/2" female drive for addition of ratchet for extra torque and strength
8380487 – Wt. 2.7 lb **21⁹⁹**

1/2" dr Extending Breaker Bar

Heavy-duty heat-treated and hardened chrome vanadium steel for strength and durability

Mirror-chrome finish for corrosion resistance

Extends from 16" to 24" with free locking positions for added torque and increased access

Double side quick release

180° swivel head

Knurled non-slip grip handle
8380446 – Wt. 2.7 lb **39⁹⁹**



1/2" dr Extendable Breaker Bar

Extendable from 18" to 24"

8224768 – Wt. 3.1 lb **39⁹⁹**



NEW
pro.point



4 pc Free Spinning T-Handle driver Set

- 1/4", 3/8" 1/2" drives and 1/4" female hex bit driver
- Adjustable anodized sleeve with ball bearings to allow for free spinning

8384794 – Wt. 5.5 lb **79⁹⁹**



3/8" dr Wobble Foldable Extending T-Handle

Adjustable T-handle offers 7 locking positions notched in 1" increments

Simply push to extend the shaft from 9" to 15"

8380388 – Wt. 2.2 lb **24⁹⁹**



3/8" dr T-Handle Foldable Flexible driver Extension

Heavy-duty heat-treated and hardened chrome-vanadium steel for strength and durability

Adjustable flex t-handle offers 7 locking positions notched in 1" increments

Shaft extends from 9" to 15"

8380396 – Wt. 1.5 lb **29⁹⁹**

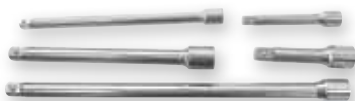

5 pc Extension Bar Sets
1/4" & 3/8" dr

- 2 pc 1/4" dr extension bars: 3", 6"
- 3 pc 3/8" dr extension bars: 3", 6", 10"

8351520 – Wt. 1.2 lb..... **12⁹⁹**

3/8" dr & 1/2" dr

- 2 pc 3/8" dr extension bars: 3", 6"
- 3 pc 1/2" dr extension bars: 3", 5", 10"

8351546 – Wt. 2.1 lb..... **16⁹⁹**



8 pc drive Adapter & U-Joint Set

- Adapters: 1/4" sq. dr x 1/4" hex, 1/4" F x 3/8" M, 3/8" F x 1/4" M, 3/8" F x 1/2" M, 1/2" F x 3/8" M
- U-Joint sizes: 1/4", 3/8" and 1/2" drives

8328700 – Wt. 1.1 lb..... **14⁹⁹**

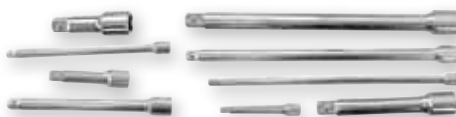

9 pc 1/4", 3/8" & 1/2" Extension Bars

- 3 pc 1/4" dr extension bars: 3", 6", 9"
- 3 pc 3/8" dr extension bars: 3", 6", 10"
- 3 pc 1/2" dr extension bars: 2", 5", 10"

8351595 – Wt. 3.2 lb..... **24⁹⁹**

3 pc drive Adapter Set
 1/4" F x 3/8" M, 3/8" F x 1/2" M, and 1/2" F x 3/4" M
8000567 – Wt. 0.5 lb..... **4⁹⁹**

Universal Joints
 Swings 90° in either direction
2919124 – 1/4" dr
 Wt. 0.1 lb..... **3⁹⁹**

2911337 – 3/8" dr
 Wt. 0.2 lb..... **4⁹⁹**

2917607 – 1/2" dr
 Wt. 0.4 lb..... **5⁹⁹**

Flexible Extension Set
 • Great for hard to reach places
 • 1/4" dr x 6" and 3/8" dr x 8"
2920483 – Wt. 0.5 lb..... **8⁹⁹**



9 pc Locking Extension Bar Set

- Spring-loaded collar locks bar in place
- 1/4" dr sizes: 4", 6" 10"
- 3/8" dr sizes: 3", 6", 10"
- 1/2" dr sizes: 3", 5", 10"

8351421 – Wt. 3.5 lb..... **49⁹⁹**

3 pc Universal Joint Set
 • Swings 90° in either direction
 • 1/4", 3/8", and 1/2" dr
2921104 – Wt. 0.6 lb..... **8⁹⁹**

Drive Adapters
 Chrome vanadium steel

Size	Wt.(lb)	ITEM	PRICE
1/4" F - 3/8" M	0.1	2917623	1.99
3/8" F - 1/4" M	0.1	2923423	1.99
3/8" F - 1/2" M	0.1	2911576	2.99
1/2" F - 3/8" M	0.1	2922417	2.99
1/2" F - 3/4" M	0.4	8000569	4.99
3/4" F - 1/2" M	0.3	2917680	4.99

pro.point

Adjustable Extensions
 Mirror polished chrome vanadium steel bar housed in chrome-moly tube

Size	Extend From	Wt. (lb)	ITEM	PRICE
1/4"	7" to 12"	0.4	8347403	7.99
3/8"	9" to 15"	0.8	8347395	12.99
1/2"	10" to 16"	1.4	8347387	14.99

2 pc Magnetic Socket Adapters

- 1/4" dr female x 3/8" dr male
- 3/8" dr female x 1/2" dr male

8363418 – Wt. 0.1 lb..... **9⁹⁹**

Adjustable Wobble Extensions
 Mirror polished chrome vanadium steel bar housed in chrome-moly tube

Size	Extend From	Wt. (lb)	ITEM	PRICE
1/4"	7" to 12"	0.4	8347437	7.99
3/8"	9" to 15"	0.7	8347429	12.99
1/2"	10" to 16"	1.4	8347411	14.99

1/4" dr Extension Handle
 Extends from 7-1/2" to 12-1/2"
8308207 – Wt. 0.6 lb..... **9⁹⁹**

T-Handle Speed drivers

- Anodized aluminum outer sleeve rotates freely to allow speed action when removing fasteners
- Quick release locking socket mechanism hold socket tight until released
- T-Handle can be set in two positions

3/8" dr
8383341 – Wt. 0.4 lb..... **16⁹⁹**

1/4" dr
8383358 – Wt. 0.8 lb..... **17⁹⁹**

1/2" dr
8383366 – Wt. 1.2 lb..... **19⁹⁹**

NEW
pro.point

Professional Screwdriver Set

- Super hard chrome molybdenum S2 steel blades, hardened, tempered with satin finish and black tips
- Hex shanks
- Molded comfort grip for better driving control
- Hard shell case doubles as a storage rack

7 pc
 Slotted, Phillips and Square
8376964 – Wt. 2.4 lb..... **24⁹⁹**

10 pc (shown)
 Slotted, Phillips and Square
8377285 – Wt. 3.2 lb..... **34⁹⁹**



NEW
pro.point

A) 2 pc Floating Screwdriver Set

- Floating handle with stainless steel blades for marine use
- 1/4" slotted and #2 Phillips heads

8320061 – Wt. 0.4 lb..... **5⁹⁹**

B) 8-Way Stubby Screwdriver

- 1 screwdriver can be used on Pozidriv #1, #2, #3, Phillips #0, #1, #2, #3 and 6 mm slotted
- Satin finish S2 steel

8348443 – Wt. 0.2 lb..... **5⁹⁹**

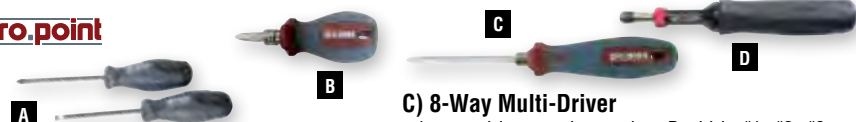

Screwdrivers

C) 8-Way Multi-Driver

- 1 screwdriver can be used on Pozidriv #1, #2, #3, Phillips #0, #1, #2, #3 and 6 mm slotted
- Satin finish S2 steel

8348435 – Wt. 0.3 lb..... **6⁹⁹**

C) 3 to 15 in-lb Adjustable Torque Screwdriver

- 1/4" dr universal bit holder tip
- Ideal for precision applications, low torque assemblies
- Dial adjustable from 3 to 15 in-lb (34-169 N*cm)

8380057 – Wt. 0.7 lb..... **79⁹⁹**

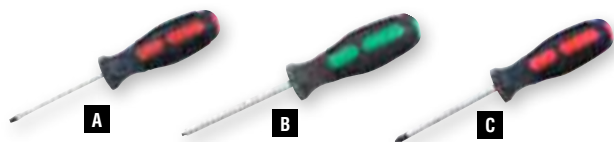

	Style	Size	Wt. (lb)	ITEM	PRICE
A	Slotted	1/8" x 3"	0.1	8149791	1.99
	Slotted	3/16" x 4"	0.1	8149809	2.99
	Slotted	1/4" x 4"	0.2	8149825	2.99
	Slotted	5/16" x 5"	0.3	8149833	3.99
B	Square	#1 x 4"	0.2	8149718	2.99
	Square	#2 x 4"	0.3	8149726	2.99
	Square	#3 x 6"	0.3	8149734	3.99
C	Phillips	#1 x 4"	0.1	8149759	2.99
	Phillips	#2 x 4"	0.2	8149767	2.99
	Phillips	#3 x 6"	0.3	8149783	3.99

FULLER



PRO 300 Screwdrivers

- FULLER PRO 300 screwdrivers are the perfect combination of rugged durability and comfort - Guaranteed
- Industrial quality and strength
- One piece shatterproof handle
- Extra large fluted handle for maximum comfort and torque
- Chrome vanadium steel blade for strength and durability
- Chrome plated to resist rust



Style	Size	Wt. (lb)	ITEM	PRICE
Pocket Slotted	1/8" x 3-1/2"	0.1	8307340	2.99
Slotted	1/4" x 4"	0.2	8307373	4.99
Slotted	5/16" x 6"	0.3	8307357	6.99
Phillips #1	3"	0.2	8307449	4.99
Phillips #2	4"	0.2	8307464	4.99
Phillips #3	6"	0.4	8307480	6.99
Robertson™ #1	4"	0.2	8307381	4.99
Robertson™ #2	5"	0.3	8307423	4.99
Robertson™ #3	5"	0.3	8307431	4.99



Screwdriver Sets

- Chrome vanadium steel blades with magnetic tips
- Comfort grip handle

2 pc
Slotted and Phillips with pocket clip
8034325 - Wt. 0.1 lb **2.49**

10 pc
3 slotted, 4 Phillips, and 3 square
8138737 - Wt. 1.7 lb **12.99**

7 pc Jumbo
2 slotted, 2 square, and 3 Phillips
8138778 - Wt. 2.1 lb **14.99**

7 pc
3 slotted, 2 square, and 2 Phillips
8138760 - Wt. 1.3 lb **10.99**

17 pc (Shown)
5 slotted, 3 Phillips, stubby Phillips, 4 square, and 3 offset (slotted, Phillips, and square)
8301749 - Wt. 3.1 **19.99**



D) 24" Slotted Screwdriver
8002944 - Wt. 1.1 lb **6.99**

E) 24" Flexible driver
Flexible shaft with rubber sleeve and 1/4" hex female bit adapter
8009623 - Wt. 0.6 lb **10.99**

pro.point

Multi-Angle Multi-Driver
• 7 adjustable angle position multi-driver
• 10 pc S2 steel bits: Phillips #2, Slotted 3/16", Hex - 2, 2.5, 3, 4, 5, 6, 8 and 10 mm
8319758 - Wt. 0.7 lb **9.99**

Precision Screwdriver Sets



Precision Screwdriver Sets

F) 6 pc
• Chrome vanadium blades
• 3 slotted and 3 Phillips
8001630 - Wt. 0.3 lb **3.49**

G) 9 pc
• 2" long nickel chrome-moly steel blades
• 3 slotted, 3 Phillips and 3 Torx®
8174963 - Wt. 0.7 lb **16.99**

H) 27 pc
• 14 pc 4 mm hex x 50 mm bit includes 3 slotted, 4 Phillips, 7 Torx®
• 6 chrome vanadium sockets
• 5 open end wrenches
8263345 - Wt. 0.6 lb **16.99**

I) 34 pc
• Nickel chrome-moly steel construction
• 8" flex tube bit holder, 4-11/16" bit holder and 5-1/4" high torque ratchet screwdriver
• 10 Torx®, 7 slotted, 3 Phillips, 8 hex and 3 square bits
8210874 - Wt. 0.6 lb **16.99**

J) 18 pc Interchangeable
• Aluminum handle with quick release chuck
• 6 pc screwdriver bits, 4 pc hooks, 6 pc files, magnetic telescoping pick-up tool
8320178 - Wt. 3.5 lb **19.99**



10-in-1 Precision Screwdriver
5 pc double ended bits store in screwdriver handle
8348088 - Wt. 0.1 lb **7.99**

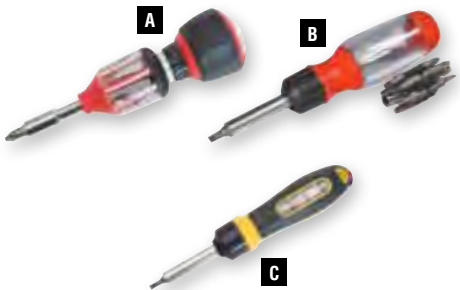

- A) 13-in-2 Dual Ratcheting Multi-Driver Set**
 • Standard size multi-driver with BONUS stubby multi-driver built into the handle
 • High torque 3 position ratcheting handle
8349755 – Wt. 0.5 lb. 12⁹⁹
- B) 12-in-1 Ratcheting Multi-Driver**
 • Impact resistant see-through handle
 • 3 ratchet settings: forward, manual, and reverse
8131401 – Wt. 0.6 lb. 12⁹⁹

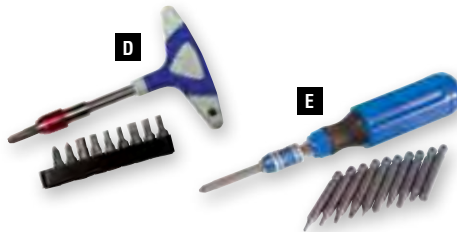

- C) 7-in-1 Ratcheting Multi-Driver**
 • Bits store in convenient flip-out handle
 • 3-position ratcheting handle
8349771 – Wt. 0.5 lb. 9⁹⁹
- D) 10-in-1 T-Handle Multi-Driver**
 S2 steel bits with quick release handle
8306722 – Wt. 0.3 lb. 9⁹⁹
- E) 12 pc Multi Screwdriver**
 2-1/2" long chrome vanadium steel bits: 1 slotted, 3 Phillips, 4 square and 2 hex and one Awl punch
8190803 – Wt. 0.8 lb. 10⁹⁹

Ratcheting Screwdrivers



- F) 13 pc Flexible Joint Ratcheting Multi-Driver Set**
 • Magnetic / auto-locking bit holder
 • Ratchet function: clockwise, neutral and counter-clockwise
8351900 – Wt. 0.7 lb. 19⁹⁹
- G) 15 pc Mini Multi-Driver Set**
 • Magnetic / auto-locking bit holder
 • Includes 10 bits (Square #0, #1, #2, #3 - Phillips #1, #2, #3 - Slotted 1/8", 3/16", 9/32"), socket adapter and 3 sockets (6, 8 and 10 mm)
8351884 – Wt. 0.6 lb. 12⁹⁹
- H) 17 pc Ratcheting Mini Multi-Driver Set**
 • Great for use in narrow spaces
 • Includes ratcheting driver, bit holder and fifteen S2 steel assorted bits
 • Bits included: Phillips #1, #2(x2), #3, Square #1, #2(x2), #3, Slotted 1/8", 3/16", 9/32"
8351850 – Wt. 0.6 lb. 19⁹⁹

WORK with us!

We are always looking for team-oriented people with a passion for delivering Royal Service.

Visit www.princessauto.com/careers to apply for any of our positions across Canada

Part-Time • Full-Time • Benefits • Opportunities • Fun



- 1/4" Hex dr T-Handle Speed driver**
 • Anodized aluminum outer sleeve rotates freely to allow speed action when removing fasteners
 • Chrome vanadium steel T-handle and socket driver
 • T-Handle can be set in two positions
8383333 – Wt. 0.4 lb. 16⁹⁹

Impact Driver & Offset Ratchet Sets



- 9 pc Impact driver Set**
 Impact driver (1/2" dr square x 8 mm hex), 2 slotted, 4 Phillips, 2 hex
8311615 – Wt. 2.2 lb. 19⁹⁹



- 7 pc 1/4" Hex Impact driver Set**
 1/4" dr hex impact driver, three 50 mm bits (Phillips and slotted), one 75 mm Phillips bit, and two 1/4" dr hex nut driver heads
8003577 – Wt. 0.7 lb. 10⁹⁹



Nut drivers SAE
 3/16" to 1/2"
8150286

Metric
 5 to 10 mm
8150294
 Wt. 1.8 lb. **12⁹⁹** /set

- Hose Clamp Screwdriver**
 • Fits 5/16" hex head
 • Flexible shank to reach difficult spots
2970198 – Wt. 0.3 lb. 7⁹⁹



- 4 pc SAE Nut driver Set**
 • 1/4", 5/16", 3/8" and 7/16"
 • Colour coded for easy identification
8314932 – Wt. 0.9 lb. 17⁹⁹

Nut Drivers



7 pc Folding Nut drivers SAE
 • 3/16" to 1/2"
 • Red colour coded handle
8341992

- Metric**
 • 5 to 12 mm
 • Blue colour coded handle
8342008 – Wt. 0.8 lb. 9⁹⁹ /set



Bit Sets

Magnetic Quick Change Bit Holders

Clear plastic tubing with aluminum tube inside

3-1/8"
8003788 – Wt. 0.1 lb **3⁴⁹**

4-3/4"
8003786 – Wt. 0.1 lb **3⁹⁹**

2-3/8" Quick Chuck

- 1/4" hex shank, chrome vanadium construction
- Non-magnetic

8021071 – Wt. 0.1 lb **4⁹⁹**

Offset Ratchet Set

Reversible quick release offset ratchet,
32 bits, 8 sockets

2920892 – Wt. 1.0 lb **9⁹⁹**

TITAN

61 pc Bit Set

Bit holder and bits in plastic storage case

8313967 – Wt. 1.0 lb **9⁹⁹**



Angled Bit Holder

- Adjustable 360° thumb flange
- 1/4" hex driver system

• Durable die-cast construction
8338519 – Wt. 0.4 lb **9⁹⁹**

Quick Release Screw Bit Holder

- 1/4" hex drive
- Magnetic

8344244 – Wt. 0.1 lb **4⁹⁹**

33 pc Combo Bit Set

3 square, 4 Phillips, 4 slotted, 12 security hex, 9 security Torx®, and metal bit holder

2920704 – Wt. 0.5 lb **12⁹⁹**

33 pc Security Bit Set

9 Torx®, 12 hex, 4 tri-wing, 4 spanner, 3 Torq, and metal bit holder

2920513 – Wt. 0.5 lb **13⁹⁹**

pro.point

Bit Sets

- Bits are colour coded for easy identification
- S2 steel construction for added durability

A) 36 pc Bit Set

35 assorted 1" screw bits with magnetic / locking bit holder

8328171 – Wt. 0.8 lb **19⁹⁹**

B) 64 pc Bit Set

51 assorted 1" screw bits, 12 assorted 3" screw bits and magnetic / locking bit holder

8328189 – Wt. 1.8 lb **29⁹⁹**

C) 100 pc Bit Set

98 assorted 1" screw bits, standard magnetic bit holder and magnetic / locking bit holder

8328197 – Wt. 2.0 lb **39⁹⁹**

14 pc Assorted Socket Bit Set

- S2 steel bits mounted on 3/8" dr black chrome nickel finished CRV sockets
- Slotted: 1/8", 5/32", 3/16", 7/32", 1/4", 9/32", 5/16"
- Phillips: #0, #1, #2, #3
- Square: #1, #2, #3

8358475 – Wt. 1.6 lb **19⁹⁹**

10 pc Screwdriver Bit Set

- 9 pc 1" screwdriver bits: Phillips #1, #2, #3; square #1, #2, #3; slotted 4, 5, 6 mm
- Quick release bit holder

• S2 steel bits with colour coding ring
8352163 – Wt. 0.5 lb **9⁹⁹**

20 pc Screw Bit Holder

Holds 1/4" screw bits

8338634 – Wt. 0.1 lb **1⁹⁹**

Offline driver

- 1/4" hex shank and bit holder
- +/- 15°

8200255 – Wt. 0.2 lb **9⁹⁹**

68 pc Ratcheting T-Handle Bit Set

- Ratcheting T-handle adjusts to 45° and 90° angles for driving bits
- Sixty-four S2 steel bits

8380800 – Wt. 1.8 lb **29⁹⁹**

pro.point

24 pc Bit Set with Pro Ratchet Wrench

72 teeth 8 x 10 mm double box end wrench

8320202 – Wt. 0.8 lb **34⁹⁹**

pro.point

33 pc Twist Ratchet Sets

- Ratchet handle twists in either direction allowing for use in tight spaces
- 15 pc colour coded 1" S2 steel bits (Square #1, #2, #3, Phillips #1, #2, #3, Slotted 1/8", 5/32", 3/16", Hex 1/8", 5/32", 3/16", Torx® T15, T20, T25)
- 6 pc colour coded 2" S2 steel bits (Phillips #1, #2, Slotted 5/32", 3/16", Torx® T10, T15)

SAE

5/32" to 1/2"

8368417 – Wt. 2.0 lb

Metric

4 to 13 mm

8368409 – Wt. 2.0 lb **49⁹⁹**
/set

pro.point

10 pc Screwdriver Bits

- S2 steel
- Convenient storage case

8361172 – #2 Square

8361180 – #2 Phillips

Wt. 0.1 lb **5⁹⁹**
/set

Eklind

Hex Key Sets

- Made with Eklind® Alloy Steel
- Heat treated for optimum strength and ductility
- Finished with Eklind® Black Finish to resist rust

	Style	Pieces	Sizes	Wt. (lb)	ITEM	PRICE
SAE Hex Key Sets						
A	Ergo-Fold™	9	5/64" to 1/4"	0.4	8005575	8.99
	Ergo-Fold™	6	5/32" to 3/8"	0.8	8005573	10.99
B	Short Series Hex-L®	13	.050" to 3/8"	0.6	8005566	9.99
	Long Series Hex-L®	13	0.050" to 3/8"	0.9	8005568	11.99
	Ball Hex-L®	13	0.050" to 3/8"	0.8	8005572	16.99
C	Hex T-Key	8	3/32" to 1/4"	0.9	8005577	20.99
Metric Hex Key Sets						
A	Ergo-Fold™	7	2 to 8 mm	0.6	8005574	9.99
	Short Series Hex-L®	9	1.5 to 10 mm	0.6	8005564	8.99
B	Long Series Hex-L®	9	1.5 to 10 mm	0.8	8005567	10.99
	Ball Hex-L®	9	1.5 to 10 mm	0.8	8005569	14.99
C	6" Hex T-Key	6	2 to 6 mm	0.6	8005576	18.99

* Ball end key turns 360° up to an angle of 35°.



9 pc Extra Long 2 Way Handle Ball Point Hex Keys

Chrome vanadium steel with nickel plating

SAE
1/16" to 3/8"
8320509

Metric
1.5 to 10 mm
8319824 – Wt. 1.2 lb..... **19⁹⁹** /set

Ergo-Fold Hex Key Sets

Chrome vanadium steel

9 pc SAE
5/64" to 1/4"
8200818

8 pc Metric
1.5 to 8 mm
8200826 – Wt. 0.4 lb..... **6⁹⁹** /set

10 pc T-Handle Hex Key Sets

6" long
SAE
3/32" to 3/8"
2921286 – Wt. 1.4 lb

Metric
2 to 10 mm
8001647 – Wt. 2.0 lb..... **11⁹⁹** /set

6 pc Jumbo Hex Key Sets

Chrome vanadium steel
SAE
3/8" to 5/8", 3/4"
8018584 – Wt. 4.0 lb

Metric
8 to 19 mm
8018619 – Wt. 3.6 lb..... **19⁹⁹** /set

9 pc Ball End Hex Key Sets

Heat treated for optimum strength and ductility

D) Metric

Style	Wt. (lb)	ITEM	PRICE
Long	0.8	8248940	13.99
Extra Long	1.0	2920732	16.99

* Magnetic ball end

E) SAE

Style	Wt. (lb)	ITEM	PRICE
Long	0.9	8248965	18.99
Extra Long	1.1	8008586	19.99

* Magnetic ball end

Hex Keys

pro.point

9 pc Extra Long Ball-End Hex Keys

Nickel chrome-moly steel with satin finish

SAE
1/16" to 3/8"
8311763

Metric
1.5 mm to 10 mm
8311755 – Wt. 1.1 lb..... **17⁹⁹** /set

Extra Long Magnetic Anti-Slip Key Sets

- Colour-coded for easy reference
- S2 steel

SAE
1/16" to 3/8"
8307019 – Wt. 0.9 lb

Metric
1.5 to 10 mm
8307001 – Wt. 1.0 lb..... **19⁹⁹** /set

8 pc Hex Key Sets

- S2 tool steel
- Ball-point on long key end allows access to fasteners at an angle
- Cushioned grip handles

SAE
5/64" to 3/8"
8385296 – Wt. 2.2 lb

Metric
2 to 10 mm
8385288 – Wt. 2.4 lb..... **19⁹⁹** /set



9 pc Heavy Duty Twisted Hex Key Sets

- Heat treated S2 tool steel
- Twisted keys for increased torque capacity

SAE
1/16" to 3/8"
8384745 – Wt. 0.8 lb

Metric
1.5 to 10 mm
8384752 – Wt. 0.8 lb..... **14⁹⁹**



5 pc Double Flex End Hex Wrench Sets

- Chrome vanadium steel handles with chrome molybdenum steel hex heads
- Pivoting heads allowing access into tight spots

SAE
1/8" x 5/32", 3/16" x 7/32",
1/4" x 5/16", 3/8" x 1/2",
9/16" x 5/8"
8381667 – Wt. 3.5 lb

Metric
2 x 2.5 mm, 3 x 4 mm, 5 x 6 mm,
8 x 10 mm, 12 x 14 mm
8381642 – Wt. 3.3 lb

Torx®
T15 x T20, T25 x T27, T30 x T50,
T45 x T50, T55 x T60
8381691 – Wt. 2.0 lb..... **39⁹⁹** /set

PRINCESS AUTO

Welcome to our Unique World!



Home of an outstanding shopping experience, every time!

Hex Sockets / Bits

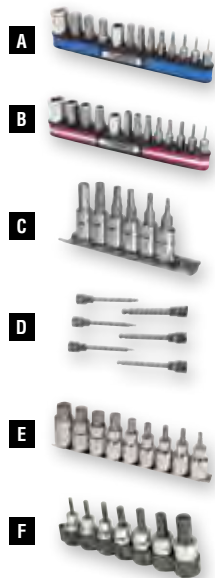

	Dr	Piece	Size	Wt.(lb)	ITEM	PRICE
Hex Bit Sets						
A	1/4" and 3/8"	13	1/16" to 7/16"	0.4	8384810	11.99
	1/4" and 3/8"	13	5 to 10 mm	0.4	8384828	11.99
B*	1/4" and 3/8"	13	1/16" to 7/16"	0.4	8384851	11.99
	1/4" and 3/8"	13	5 to 10 mm	0.4	8384869	11.99
Hex Bit Socket Sets						
C	1/4"	6	3/32" TO 1/4"	0.3	8142333	8.99
	1/4"	6	2 to 6 mm	0.3	8142341	8.99
D	3/8"	6	5/32" to 3/8"	1.1	8159212	14.99
	3/8"	6	3 to 10 mm	1.1	8159303	14.99
E	1/2"	9	3/16" to 3/4"	2.2	8045171	24.99
	1/2"	9	5 to 19 mm	2.3	8045162	24.99
F	3/8"	7	1/8" to 3/8"	0.6	2920412	29.99
	3/8"	7	3 to 10 mm	0.6	2920413	29.99

* Tamper proof

7 pc 3/8" dr Hex Bit Socket Sets

S2 tool steel bits secured in chrome vanadium steel sockets

SAE
1/8" to 1/4", 5/16" and 3/8"
8142317

Metric
3, 4, 5, 6, 7, 8 and 10 mm
8142325 – Wt. 0.7 lb. **11⁹⁹**/_{set}

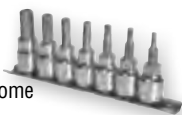

8 pc 1/4" dr Universal Hex Bit Socket Set

- 4 pc 1/4" dr universal hex bit sockets
- 4 pc 1/4" dr 4-1/2" long universal hex bit sockets

• 3, 4, 5, 6 mm
8306748 – Wt. 1.1 lb. **24⁹⁹**



Torx Sets

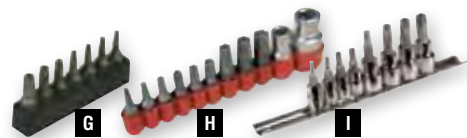

G) 8 pc Torx®

- Heavy duty S2 steel
- T-7 to T-25

• 1/4" hex shank, 1" length
8024283 – Wt. 0.1 lb. **3⁹⁹**

H) 11 pc Torx® Bit Set

- Heavy duty S2 steel
- T-10 to T-50 bits
- 1/4" and 3/8" dr bit holder

8001049 – Wt. 0.3 lb **4⁹⁹**

I) 8 pc Torx® Bit Set

- Heavy duty S2 steel
- T-10 to T-50

• 1/4" and 3/8" dr
8037019 – Wt. 0.6 lb **9⁹⁹**

9 pc Tamper Proof Magnetic Torx Key Set

- S2 steel, black finish
- T-10 to T-50

8248973 – Wt. 0.8 lb **15⁹⁹**



8 pc Ergo Folding Torx® Key Set

- Chrome vanadium with black finish
- T-9 to T-40

8300428 – Wt. 0.4 lb. **6⁹⁹**

9 pc Tamper Proof Torx® Key Set

- Chrome-moly steel keys with high visibility size markings
- T10 to T50

8175101 – Wt. 1.0 lb **19⁹⁹**



13 pc Tamper Resistant Torx® Bit Set

1/4" and 3/8" drive bit sockets

8384836 – Wt. 0.4 lb. **11⁹⁹**

9 pc E-Torx® Socket Set

Five 1/4" dr sockets (E-4 to E-8), four 3/8" dr sockets (E-10 to E-16), and socket holder

8001053 – Wt. 0.5 lb **11⁹⁹**

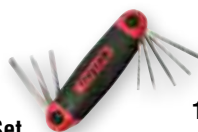

10 pc Multi-Drive T-Bar with Torx® Bit Socket Set

- Chrome vanadium steel sockets with S2 tool steel bits
- 1/4", 3/8", and 1/2" multi-drive 10" long T-handle

8159527 – Wt. 2.1 lb **29⁹⁹**

17 pc Torx® and E-Torx® Socket Bit Set

Chrome vanadium steel sockets / S2 Torx® bit set

8203432 – Wt. 1.2 lb **14⁹⁹**

12 pc 1/4" and 3/8" dr Torx® Socket Set

- T10 to T60
- Chrome vanadium steel

8306789 – Wt. 0.8 lb. **9⁹⁹**



pro.point



180° Swivel Head Hex Key Sets

- Pivoting heads allowing access into tight spots
- Anodized chrome vanadium steel arms with S2 tool steel tips

Red

Sizes: 1/8" to 3/8"
8381790 – Wt. 2.0 lb

Blue

Sizes: 3 to 10 mm
8381782 – Wt. 2.0 lb

Green

Sizes: T20 to T50
8381808 – Wt. 2.0 lb **49⁹⁹**/_{set}

14 pc Hex Bit Sockets

S2 steel bits mounted on 3/8" dr black chrome nickel finished CRV sockets

SAE

1/16" to 1/2"
8359507 – Wt. 1.7 lb

Metric

2 to 12 mm
8359077 – Wt. 1.7 lb **19⁹⁹**/_{set}

SAE / MM Ball End Hex

- SAE – 1/8" to 3/8"
- Metric – 4 to 10 mm

8359515 – Wt. 1.6 lb. **19⁹⁹**



pro.point



14 pc Torx® Socket Bit Sets

S2 steel bits mounted on 3/8" dr black chrome nickel finished CRV sockets
8358988 – T7 to T55
8359051 – T7 to T55 Tamper proof bits
 Wt. 1.6 lb..... **19⁹⁹**/set



7 pc Professional Torx® drivers

- Super hard chrome molybdenum S2 steel blades, hardened, tempered with satin finish and black tips
- T20 to T50
- Molded comfort grip for better driving control

8377244 – Wt. 2.9 lb..... **29⁹⁹**



7 pc External Torx® Socket Set

- Sizes E6 through E16 (three smaller sizes are 1/4" dr; four larger sizes are 3/8" dr)
- Set includes convenient vinyl holder

2944148 – Wt. 0.5 lb **29⁹⁹**



Torx® Bits

Size	Dr	Wt. (lb)	ITEM	PRICE
T-50	3/8" dr	0.1	2944122	5.99
T-55	3/8" dr	0.1	2944130	5.99
T-60	1/2" dr	0.2	2922342	7.99

4 pc Triple Square Bit Set

- M6, M8, M10 and M12
- 1/2" hex shank

8306813 – Wt. 0.7 lb..... **7⁹⁹**



8 pc Torx® Key Set

- S2 tool steel
- Cushioned grip handles
- Sizes: T9 to T40

8385304 – Wt. 2.3 lb..... **19⁹⁹**



9 pc Extra Long Ball-End Torx® Key Set

- T10 to T50
- S2 steel with satin finish

8306730 – Wt. 0.9 lb..... **24⁹⁹**



9 pc Extra Long Magnetic Anti-Slip Torx® Key Set

- T10 to T50
- Colour coded for easy reference
- S2 steel

8307027 – Wt. 0.9 lb..... **19⁹⁹**



6 pc Torx® Screwdriver Set

- Magnetic tip with chrome vanadium steel blade
- T10 to T40

2920902 – Wt. 1.1 lb **11⁹⁹**



8 pc Triple Square Key Set

- Sizes: M3 to M12
- Labelled sizes on holder

8384802 – Wt. 1.7 lb..... **24⁹⁹**



Adjustable Wrenches

pro.point

Ratcheting Adjustable Wrenches

Ratcheting feature eliminates the need to lift wrench off the nut after each movement

Size	Closed Length	Wt. (lb)	ITEM	PRICE
6"	3/4" (19 mm)	0.4	8306532	12.99
8"	15/16" (24 mm)	0.7	8306540	16.99
10"	1-1/8" (28 mm)	1.2	8306557	19.99



Non-Slip Adjustable Wrenches

- Thermoplastic grip handle
- Lightweight design

Size	Jaw Capacity	Wt. (lb)	ITEM	PRICE
6"	15/16" (24 mm)	0.3	8306631	12.99
8"	1-1/16" (27 mm)	0.5	8306649	14.99
10"	1-15/16" (33 mm)	0.9	8306656	19.99
12"	1-1/2" (38 mm)	1.4	8306664	21.99
15"	2" (50 mm)	2.9	8306672	39.99



Adjustable Wrenches

SAE and metric measuring scales for sizing nuts, pipe and tube diameter

Size	Jaw Capacity	Wt. (lb)	ITEM	PRICE
6"	3/4" (19 mm)	0.3	8052778	5.99
8"	15/16" (24 mm)	0.6	8052787	6.99
10"	1-1/8" (28 mm)	0.9	8052796	8.99
12"	1-3/8" (35 mm)	1.4	8052803	12.99
15"	1-3/4" (44 mm)	2.7	8052821	24.99
18"	2-1/8" (54 mm)	5.0	8052830	39.99
24"	2-3/8" (60 mm)	7.0	8052849	59.99



pro.point

Wide Opening Adjustable Wrenches

Thermoplastic grip handle

Size	Jaw Capacity	Wt. (lb)	ITEM	PRICE
6"	1-3/8" (34 mm)	0.4	8306607	12.99
8"	1-1/2" (38 mm)	0.7	8306615	16.99
10"	2" (50 mm)	1.2	8306623	19.99



4 pc Adjustable Wrench Set

6", 8", 10" and 12"
8158123 – Wt. 3.1 lb **24⁹⁹**



INDIVIDUAL WRENCHES
 Available On-Line and In-Store
www.princessauto.com

Box End Wrenches



5 pc 45° Offset Box End Wrench Sets
 Chrome vanadium construction
SAE
 3/8" to 7/8"
8343576 – Wt. 2.1 lb **19⁹⁹**
Metric
 10 to 19 mm
8343584 – Wt. 1.6 lb **16⁹⁹**



4 pc Box End Ratcheting Wrench Sets
 Polished chrome vanadium steel
SAE
 5/16" to 3/4"
8059917
Metric
 8 to 19 mm
8203697 – Wt. 1.3 lb **49⁹⁹**_{/set}



Double Box End Ratcheting Wrenches
SAE
 3/8" x 1/2" box end wrench, 1/4" socket adapter and bit adapter, 3/8" socket adapter and bit adapter
8356131
Metric
 10 x 13 mm box end wrench, 1/4" socket adapter and bit adapter, 3/8" socket adapter and bit adapter
8356123 – Wt. 0.4 lb **24⁹⁹**_{/set}

pro.point

4 pc Flexible Ratcheting Double Box End Wrench Sets
 • 72 teeth ratcheting mechanism
 • Chrome vanadium steel with satin finish



SAE
 5/16" to 3/4"
8320244
Metric
 8 to 19 mm
8320236 – Wt. 2.1 lb **64⁹⁹**_{/set}

Ratcheting Double Box End Wrench Sets



• Reversible
 • Chrome vanadium construction with satin finish
4 pc SAE
 5/16" to 3/4"
8319865 – Wt. 1.9 lb **54⁹⁹**
5 pc Metric
 8 to 19 mm
8319840 – Wt. 2.3 lb **69⁹⁹**

7 pc 1/2" dr Flexible Box End Wrench Set



• 12 pt. box wrenches
 • Chrome vanadium steel with satin finish
SAE
 9/16" to 15/16"
8319501 – Wt. 2.8 lb
Metric
 13 to 24 mm
8319568 – Wt. 3.1 lb **39⁹⁹**_{/set}

29-in-2 Ratcheting Multi Box End Wrenches



• 2 wrenches to cover 29 size applications
 • 72 teeth ratcheting ends
 • Fits sizes: 8 to 19 mm, 5/16" to 3/4", E10 to M22
8363277 – Wt. 0.7 lb **39⁹⁹**



S-Shape Ratcheting Box End Wrench Sets
 • Reversible
 • Chrome vanadium steel with satin finish

4 pc SAE
 3/8" to 7/8"
8319907 – Wt. 3.2 lb **74⁹⁹**
5 pc Metric
 10 to 22 mm
8319873 – Wt. 3.5 lb **89⁹⁹**



5 pc Ratcheting Spline Wrench Sets
 • 72 teeth ratchet mechanism
 • Chrome vanadium steel with satin finish
SAE
 5/16" to 9/16"
8320327
Metric
 8 to 14 mm
8320319
 Wt. 1.6 lb **29⁹⁹**_{/set}

Combination Wrenches



• Heavy duty chrome-moly construction
 • Dual magnetic swivel heads
SAE
 3/8" to 13/16"
8341216
Metric
 12 to 19 mm
8341240 – Wt. 1.2 lb **19⁹⁹**_{/ea}

Combination Wrenches



5 pc SAE Jumbo Combination Wrench Set
 1-1/4", 1-1/8", 1-5/16", 1-1/2", 1-7/16"
8314262 – Wt. 8.4 lb **79⁹⁹**

6 pc SAE Jumbo Combination Wrench Set
 1-3/8", 1-1/2", 1-5/8", 1-3/4", 1-7/8", 2"
2917755 – Wt. 20.0 lb **99⁹⁹**



8 pc Mini Open End Ignition Wrench Sets
 Carbon steel
SAE
 7/32" to 7/16"
8263139

Metric
 5 to 11 mm
8263121 – Wt. 0.3 lb **11⁹⁹**_{/set}

Combination Wrench Sets

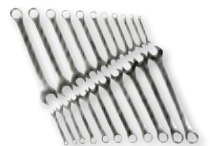

Fully polished chrome vanadium steel
22 pc SAE
 1/4" to 7/8"
22 pc Metric
 6 to 19 mm
2922854 – Wt. 4.7 lb **39⁹⁹**

25 pc SAE
 1/4", 5/16", 3/8" to 1"
25 pc Metric
 7, 8, 10, 12 to 20 mm
8202939 – Wt. 7.1 lb **69⁹⁹**



Crosspein Hammers

Fibreglass handle

Head Weight	Wt. (lb)	ITEM	PRICE
28 oz	2.5	2940081	10.99
35 oz	3.2	2940079	13.99

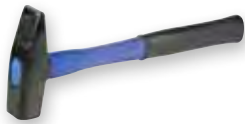

A) 8 lb Dead Blow Hammer

- Head: metal core wrapped in polyethylene
- Handle: chrome painted metal with PVC grip

8222937 – Wt. 8.7 lb **44⁹⁹**

B) 8 lb Dead Blow Hammer

- 30" PVC handle with fibreglass core
- Rubber grip

8145542 – Wt. 11.1 lb **59⁹⁹**

pro.point

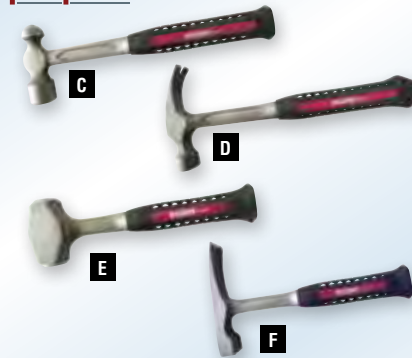

Anti Vibration Hammers

Comfortable grip designed to reduce seismic waves when striking, causing less hand pain and more control

	Style	Head Wt.	Wt. (lb)	ITEM	PRICE
C	Ball Pein	16 oz	1.7	8311672	19.99
		24 oz	2.3	8311664	21.99
D	Claw	16 oz	1.7	8311656	19.99
		20 oz	1.9	8311649	24.99
E	Club	40 oz	2.5	8384927	19.99
		64 oz	4.1	8384943	24.99
F	Bricklayer's	20 oz	1.7	8384976	24.99

FULLER



Shock-ABSorbing Hammers

- Revolutionary WAVEX™ Technology" shock ABSorbing shaft
- Shock-ABSorbing cushion grip handle
- Fully polished heat-treated face
- WAVEX™ technology is recognized by the Canadian Physiotherapy Association
- "Hard on nails, but easy on the arm"

	Style	Head Weight	Wt. (lb)	ITEM	PRICE
G	Ball Pein	16 oz	1.7	8035818	21.99
		24 oz	2.4	8035867	23.99
		32 oz	2.7	8035875	25.99
H	Claw	16 oz	1.7	8329633	16.99
		20 oz	1.8	8120545	21.99
I	Ripping	20 oz	2.3	8103178	26.99
		22 oz	2.1	8120594	27.99
		28 oz	2.6	8147522	29.99



J) 13" Hatchet with Nail Puller
8005943 – Wt. 2.0 lb **13⁹⁹**

K) 1-3/4 lb Axe
8271868 – Wt. 2.8 lb **14⁹⁹**

L) 3-1/2 lb Double Face Axe
8322398 – Wt. 5.2 lb **24⁹⁹**

M) 3-1/2 lb Firefighter's Axe
Works great for landscaping applications, cutting, clearing and trenching
8322406 – Wt. 4.9 lb **19⁹⁹**

N) 3 lb Axe
2910012 – Wt. 5.9 lb **24⁹⁹**

O) 4 lb Axe
2910013 – Wt. 6.8 lb **29⁹⁹**

P) 5 lb Pickaxe
8212433 – Wt. 7.5 lb **34⁹⁹**

Q) 5 lb Clay Pick
8212425 – Wt. 7.1 lb **34⁹⁹**

R) 8 lb Splitting Maul
2910011 – Wt. 11.0 lb **36⁹⁹**

Splitting Tools



3 lb Brass Sledge Hammer

- Non-sparking
- Head allows some give when hammering
- 14-1/2" long with fibreglass handle

8187668 – Wt. 3.2 lb **59⁹⁹**

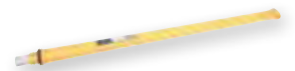

Fibreglass Sledge Handle

- 34" replacement maul / sledge handle with epoxy kit
- For 6 to 8 lb and some 8 to 24 lb sledges
- Polypropylene covering over a solid fibreglass rod
- Non-slip safety grip

8147605 – Wt. 2.2 lb **25⁹⁹**

FULLER



14 oz Shingling Axe

- For cutting and applying shingles
- Genuine American hickory wood handle with leather safety strap
- Extra-large milled face grips nail heads to minimize slipping nails

8285884 – Wt. 1.9 lb **19⁹⁹**

Replacement Handles Available On-Line
www.princessauto.com



Pry Bars



	Description	Length	Wt. (lb)	ITEM	PRICE
A	Lining Pry Bar	24" long	2.5	8277261	12.99
		36" long	4.1	8277279	16.99
		48" long	10.7	8277287	29.99
		60" long	13.1	8277295	36.99
B	Flat Pry Bar	12" long	0.9	8277303	5.99
		16" long	1.3	8277311	6.99
		24" long	1.9	8277329	9.99
C	Utility Bar	16" long	1.4	8277352	6.99
D	Hex Shaped Pry Bar	24" long	3.1	8277055	9.99
		36" long	5.1	8277063	14.99
E	Octagon Stock Stripping Bar with Polished Claw Tips and Prying Tip	48" long x 1"	11.2	2940121	34.99
F	Chisel Tip Crowbar	51" long	11.5	8277360	34.99
		61" long	14.6	8277378	39.99
G	Crowbar	60" x 2-3/8" chisel end	12.8	2970203	39.99
H	Pry Bar	18" long	1.0	2942845	4.99



12" Nail Puller
Black plastic handle
8001191 – Wt. 0.8 lb **3⁹⁹**



10" Mini Nail Puller/Pry Bar
8005942 – Wt. 0.6 lb **9⁹⁹**

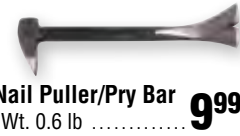

18" Nail Puller
Slide hammer ideal for removing sunken nails
8155293 – Wt. 4.7 lb **34⁹⁹**



Carpenter Pincers
• Induction hardened tips
• For pulling or cutting off nails
8167645 – Wt. 0.7 lb **4⁹⁹**



4 pc Heel Pry Bar Set
6", 12", 16" and 20" long
8277337 – Wt. 3.3 lb **19⁹⁹**



4 pc Pry Bar Set
• Comfort grip handles
• 8", 12", 18", 24"
8004720 – Wt. 3.1 lb **24⁹⁹**



pro.point

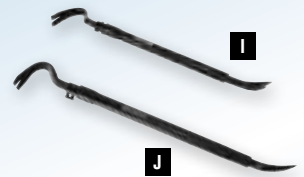

Wrecking / Pry Bar I) Extendable
23-1/4" to 32-5/8" adjustable length
8343659 – Wt. 4.4 lb... **29⁹⁹**

J) Jumbo Extendable
32-1/4" to 48" adjustable length
8343667 – Wt. 9.7 lb... **49⁹⁹**



Indexable Pry Bars
• Indexing head adjusts to 14 fixed angles
• Ideal for prying seals, bearings, manifolds, oil pans, axles, drive shafts, fuel injectors
8354003 – Wt. 0.9 lb... **18⁹⁹**
8354011 – Wt. 1.1 lb... **19⁹⁹**
8354029 – Wt. 1.3 lb... **21⁹⁹**

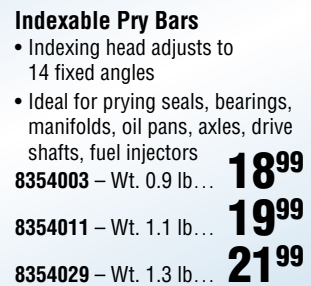

pro.point

Interchangeable Wrecking Bar Set
• Vinyl grip handle with multiple styles of pry bar tips to get any job done
• Chrome vanadium tips: standard pry bar tip, wrecking pry bar tip, small bent wrecking pry bar tip, right angle wood working and nail puller tip, 180° wood working and nail puller tip, punch down-straight type tip, jimmy bar tip
8344350 – Wt. 8.8 lb **49⁹⁹**



TITAN

2 pc Stainless Steel Pry Scraper Bar Sets
• Rigid stainless steel construction
K) Mini Stainless Steel Prybar/Scraper Set
8225195 – Wt. 0.3 lb **12⁹⁹**
L) Stainless Steel
8225187 – Wt. 0.6 lb **14⁹⁹**



3 pc Dominator Pry Bar Set
• 7", 12" and 18" pry bars
• Patented capped handle end allows user to strike handle with hammer
8000565 – Wt. 4.0 lb **74⁹⁹**



Punches & Chisels



28 pc Transfer Punch Set
• Heat-treated tempered tool steel with industrial black oxide finish
2924785 – Wt. 3.5 lb **19⁹⁹**



Metal Punch
• Pierces up to 16 ga metal
• One handed operation creates 1 ton of pressure
8019921 – Wt. 3.2 lb **34⁹⁹**

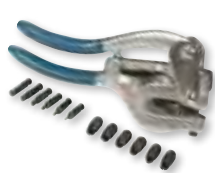

Twin Mouth Block Plane
• 2 blade seats allow use as bull nose plane or regular block plane
• Base dim. 7-3/4" x 2-1/16"
• Blade width: 1-5/8"
8222960 – Wt. 2.0 lb **19⁹⁹**





Wood Chisels

A) Long-Blade Wood Chisels

- Chrome vanadium steel
- Steel striking caps for added durability 3/4"

8262933 – 3/4" wide
Wt. 0.5 lb **10⁹⁹**

8262941 – 1" wide
Wt. 0.6 lb **11⁹⁹**

B) 3 pc Wood Chisel Set

8262891 – 1/2", 3/4" and 1" chisels
Wt. 1.8 lb **29⁹⁹**



Concave Convex Spokeshave

- Virtually unbreakable spheroidal graphite iron
- Concave blade has curvature of 2.5" radius

8319105 – Wt. 1.5 lb **21⁹⁹**



4 pc Long Taper Punch Set

2920900 – Wt. 2.7 lb **16⁹⁹**



4 pc Nail Set

- Sets nails below surface of wood
- 1/32", 1/16", 3/32", 1/8"

8178162 – Wt. 0.4 lb **5⁹⁹**



4 pc Mini Chisel Set

Stainless steel

8119794 – Wt. 0.2 lb **4⁹⁹**



5" Adjustable Automatic Centre Punch

- High and low adjustable settings
- S2 steel tip
- Heavy duty internal piano wire spring

8351272 – Wt. 0.2 lb **9⁹⁹**



3 pc Tapered Punch Set

- Chrome vanadium steel
- 3/16" x 12", 1/4" x 13", 5/16" x 15"

8380685 – Wt. 3.3 lb **24⁹⁹**

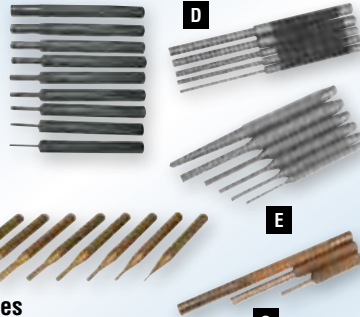

Punches

C) 9 pc 4" Pin Punch Set

1/16" to 3/8"
8139289 – Wt. 0.8 lb **6⁹⁹**

D) 5 pc 8" Pin Punch Set

1/8" to 3/8"
2970140 – Wt. 1.2 lb **11⁹⁹**

E) 6 pc Pin Punch Set

- Chrome vanadium steel
- 5 pin punches and 1 centre punch
- 3-1/2"

2920896 – Wt. 0.8 lb **11⁹⁹**

F) 8 pc Solid Brass Pin Punch Set

1/16" to 5/16"
8016906 – Wt. 0.7 lb **19⁹⁹**

G) 3 pc Solid Brass Punch Set

2 pin punches and 1 drift punch
2920202 – Wt. 1.0 lb **21.99**



Chisels with Hand Guards

1"
8006282 – Wt. 0.6 lb **7⁹⁹**

2-3/8"
8006281 – Wt. 0.7 lb **9⁹⁹**



Hollow Punch Sets

H) 6 pc
2926699 – Wt. 1.0 lb **7⁹⁹**

I) 12 pc
1/8" to 3/4"
2920169 – Wt. 2.5 lb **16⁹⁹**

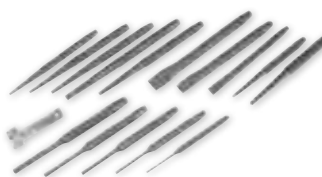

16 pc Punch & Chisel Set

- 5 taper punches, 5 pin punches, 2 centre punches, 3 cold chisels and 1 chisel punch gauge

2990711 – Wt. 2.5 lb **23⁹⁹**



6 pc Punch & Chisel Set

- 3 chisels, 2 pin punches and 1 centre punch
- Nickel chrome-moly steel with cushioned grips

8311482 – Wt. 2.2 lb **29⁹⁹**



Punch & Chisel Set

- Ergonomic handle with PVC grip
- 12 interchangeable punch and chisel heads lock in place with double locking ball detent

8344327 – Wt. 2.4 lb **29⁹⁹**



Punches

	Description	Overall Length	Wt. (lb)	ITEM	PRICE
J	5/32" Aligning	9"	0.2	2910083	10.99
	1/4" Aligning	12"	0.9	2910086	13.99
K	3/8" Centre	5"	0.2	2910087	6.99
	1/2" Centre	6"	0.4	2910088	7.99

Cold Steel Chisels

	Description	Overall Length	Wt. (lb)	ITEM	PRICE
L	1/2"	6"	0.2	2942605	7.99
	3/4"	7"	0.5	2942621	9.99
L	3/4" X-Long	12"	1.1	2910078	13.99
	1" X-Long	12"	1.5	2910079	16.99



5 pc 4" Centre Punch Set

1/16" to 1/4"
2920301 – Wt. 0.5 lb **6⁹⁹**



5 pc Taper Punch Set

3/32" x 5-1/4" to 1/4" x 6-3/4"
2920897 – Wt. 0.4 lb **12⁹⁹**

NEW pro.point



Pocket Chain Saw
High carbide steel blade with polypropylene handles
8311631 – Wt. 1.4 lb. **19⁹⁹**

2 pc TPI Bi-Metal Hacksaw Blades
High speed steel blades for long cutting life

10" x 18"
8348146 – Wt. 0.1 lb. **3⁴⁹**

10" x 24"
8348161 – Wt. 0.1 lb. **3⁴⁹**

10" x 32"
8348179 – Wt. 0.1 lb. **3⁴⁹**

12" x 18"
8348187 – Wt. 0.1 lb. **3⁶⁹**

12" x 24"
8348203 – Wt. 0.1 lb. **3⁶⁹**

12" x 32"
8348211 – Wt. 0.1 lb. **3⁶⁹**

26" Handsaw

- High carbon steel blade
- Oak wood handle
- 8 TPI

8311680 – Wt. 1.3 lb. **14⁹⁹**

12" Carbon Grit Hacksaw Blade
Makes thin straight cuts in ceramic, hardened steel, cast iron and masonry
8348237 – Wt. 0.1 lb. **3⁹⁹**



4-Sided Diamond Hone

- 4 grits in one: 600 (fine), 400 (medium), 300 (coarse), 200 (extra coarse)

8142853 – Wt. 1.3 lb. **24⁹⁹**

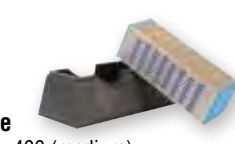

3 pc Sharpening Stone Set
120, 280, and 300 grit stones
8112435 – Wt. 0.6 lb. **9⁹⁹**

3 pc Diamond Hone Set
8025399 – Wt. 0.6 lb. **17⁹⁹**

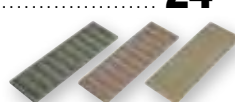

Diamond File/Hone Combo

- File: 500 grit
- Hone: 400 grit

8142846 – Wt. 0.5 lb. **9⁹⁹**



Sharpeners

Knife Sharpener

- Tungsten carbide sharpener
- Protective finger guard

8263188 – Wt. 0.2 lb. **4⁹⁹**



3-in-1 Knife / Scissor Sharpener

- 2" vacuum base, superior grip on smooth surface
- Tungsten carbide sharpening head

8243404 – Wt. 0.3 lb. **16⁹⁹**



Files

Type	Cut	Wt.(lb)	ITEM	PRICE
A	6" Tapered	Single	0.1	8148447 4.99
B	8" Smooth	Double	0.3	8148439 5.99
C	10" Second-Cut	Double	0.5	8148413 6.99



Tungsten Carbide File

H) 8" Half-Round
• One flat and one rounded side
8308363 – Wt. 0.3 lb. **7⁹⁹**

I) 8" Flat
One side coarse, other side fine
8308355 – Wt. 0.4 lb. **9⁹⁹**



Nicholson

D) 10" Aluminum File
Double cut
8148421 – Wt. 0.6 lb. **6⁹⁹**

E) 5-1/4" Tungsten Point File
2910300 – Wt. 0.1 lb. **4⁹⁹**

F) 8" Axe Sharpening File
2910298 – Wt. 0.5 lb. **9⁹⁹**

G) 10" Flat Wood Rasp
Single cut on both sides and provides rapid stock removal
8202541 – Wt. 0.7 lb. **8⁹⁹**

Filing & Sharpening

File Sets

5 pc Assorted
2 round, 2 square, and 1 flat steel file with plastic handles
2910040 – Wt. 1.1 lb. **10⁹⁹**

5 pc Titanium Coated Diamond
One round, half round, flat, square and triangle files
8049009 – Wt. 0.3 lb. **13⁹⁹**

3 pc File Set
10" flat, triangular, and half round steel files
8003169 – Wt. 2.0 lb. **14⁹⁹**

7 pc Machinist (Shown)
3 flat, 1 half round, 1 round, and 2 taper files
8004723 – Wt. 3.9 lb. **24⁹⁹**





Parrot Safety Utility Knife
Recessed blade for safety
8354425 – Wt. 0.1 lb. **3⁹⁹**

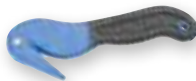

Rabbit Knife Safety Sheet Cutter
Slides easily across the surface for safe cuts
8354417 – Wt. 0.2 lb. **4⁹⁹**



10 pc Replacement Blades for Rabbit / Parrot Safety Knives
Replacement blades for Powerfist safety knives 8354417, 8354425
8360414 – Wt. 0.1 lb. **6⁹⁹**



10 pk 9 mm Utility Knife Snap-Off Replacement Blades
SK5 high carbon tool steel
9 mm
8349607 – Wt. 0.1 lb. **1⁴⁹**
18 mm
8349615 – Wt. 0.2 lb. **2⁴⁹**
25 mm
8349631 – Wt. 0.4 lb. **4⁹⁹**

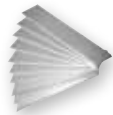

pro.point

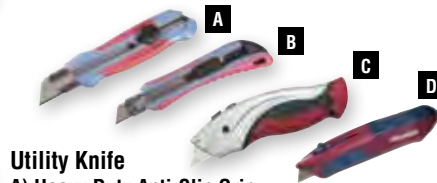

Utility Knife
A) Heavy Duty Anti-Slip Grip
• Uses 25 mm snap-off style blades
• Ratcheting blade lock mechanism
8344202 – Wt. 0.3 lb. **7⁹⁹**

B) Heavy Duty Auto-Loading Utility Knife
• Uses 18 mm snap-off style blades
• Automatic loading 6 blade capacity storage cartridge
Non-slip grip
8344210 – Wt. 0.4 lb. **9⁹⁹**

C) Heavy Duty Utility Knife
• Ergonomic design with no-slip grip
• Onboard storage for 5 spare blades
• Uses standard utility knife blades
• Quick and easy blade change
8346769 – Wt. 0.7 lb. **9⁹⁹**

D) Safety Utility Knife
• Aluminum body with non-slip TPR grip
• Spare blades store in handle
• Uses standard utility knife blades
8355067 – Wt. 0.4 lb. **9⁹⁹**



100 pc Standard Utility Knife Blades
Convenient spring loaded dispenser / used blade storage
8354441 – Wt. 1.1 lb. **19⁹⁹**



Utility Knives

E) Heavy Duty Ratchet-Lock
2970095 – Wt. 0.2 lb. **7⁹⁹**

F) Heavy Duty Auto-Lock
8139180 – Wt. 0.2 lb. **9⁹⁹**

G) Extra Heavy Duty Ratchet-Lock with Rubber Grip Insert
Comfortable rubber grip handle for the toughest jobs
2970096 – Wt. 0.3 lb. **13⁹⁹**

Replacement Snap Off Blades 10 pc OLFA Heavy Duty 18 mm blade
2970090 – Wt. 0.2 lb. **5⁹⁹**

50 pc OLFA Heavy Duty 18 mm blade
2970115 – Wt. 0.8 lb. **19⁹⁹**

5 pc OLFA Extra Heavy Duty 25 mm 25 mm blade
2970092 – Wt. 0.2 lb. **5⁹⁹**



5 pack Standard Utility Knife Blades
Fits all standard utility knives
8349649 – Wt. 0.1 lb. **1⁹⁹**



Scrapers



Scrapers
Includes one extra-heavy duty .020" razor blade - over twice as thick as a standard razor blade
H) Mini Razor Scraper
Protective safety cap
8314007 – Wt. 0.2 lb. **4⁹⁹**

I) Multi-Purpose Razor Scraper Set
Set includes: multi-purpose razor scraper, mini razor scraper and 15 extra heavy duty razor blades
8225153 – Wt. 0.6 lb. **14⁹⁹**

20 pack Replacement Razor Blades
• Extra heavy duty .020" thickness
• Over twice as thick as a standard razor blade
8313983 – Wt. 0.3 lb. **4⁹⁹**



Arc Scrapers
Blade forms an arc for precision, requiring less force and reducing surface damage or flattens for wide range scraping
J) 1-3/4" Multi-Edge
Thumb screw blade lock
8294019 – Wt. 0.2 lb. **11⁹⁹**

Replacement Blades
8294027 – Wt. 0.1 lb. **5⁹⁹**

Multi-Purpose Scrapers
High quality stainless steel: sharp, durable & rust resistant
K) 1"
8294035 – Wt. 0.1 lb. **6⁹⁹**
L) 2"
8294043 – Wt. 0.1 lb. **7⁹⁹**



Razor Blade Scraper
• Designed to reach into tight spaces
• 5 stainless steel blades for removing stickers from windshields, bumpers, etc.
8357733 – Wt. 0.4 lb. **12⁹⁹**



Scrapers

Style	Wt. (lb)	ITEM	PRICE
1-1/8" Stainless Steel	0.2	8131229	2.49
2"	0.2	8121659	2.99
5" Stainless Steel	0.3	8121642	4.99

No sale is final until you're satisfied!
We guarantee to make it right. We will repair, replace or refund any product to your satisfaction.



8 pc Multi-Scraper Set

- Scraper handle, 6 styles of scraper blades, blade storage case

- Arched handle creates proper scraping angle

8354458 – Wt. 0.7 lb **19⁹⁹**

Replacement Scraper Blades
8378069 – Wt. 0.3 lb **14⁹⁹**



Scrapers

A) All Metal Scraper with 5 Blades

2970055 – Wt. 0.2 lb **1⁹⁹**

B) Deluxe Window Scraper

Stainless steel head and blade
8004348 – Wt. 0.3 lb **5⁹⁹**

10 pc Replacement Scraper Blades
2970036 – Wt. 0.1 lb **1⁹⁹**



4 pc Stainless Steel Scraper Set

- Soft cushion grip

- 1-1/2", 2", 4", 6"

8193666 – Wt. 1.2 lb **14⁹⁹**



Straight Blade Gasket Scraper

- 1" wide x 11" long

2990122 – Wt. 0.4 lb **4⁹⁹**

Scissors



Shears

- Precision ground and hardened for long lasting sharp edge
- Wire cutting notch
- Ergonomic grip handles for both left and right hand use
- Micro-serrated cutting edges reduce slippage
- Adjustable to fit hand
- Spring loaded to reduce fatigue
- Safety lock on handle

C) 6-1/2" Cable Cutter
8378945 – Wt. 0.4 lb **14⁹⁹**

D) 5-1/2" Multi-Purpose Electrical
8378911 – Wt. 0.4 lb

E) 8" Multi-Purpose Heavy Duty
8378937 – Wt. 0.5 lb

F) 8" Angled Multi-Purpose Heavy Duty
8378929 – Wt. 0.5 lb **19⁹⁹** /ea

Super Scissors

- Stainless steel blades easily cut fabric, wire and soft metal
- Serrated cutting edges

8173106 – Wt. 0.2 lb **2⁹⁹**

2 pc Scissor Set

Stainless steel
8197501 – Wt. 0.4 lb **4⁹⁹**

Magic Cutter

Functions as fish scaler, can/bottle opener, cable cutter, screwdriver, screw-top bottle and jar opener
2970009 – Wt. 0.4 lb **11⁹⁹**



Heavy Duty Carpet Scissors
Stainless steel blades
8348617 – Wt. 0.7 lb **14⁹⁹**

Tin Snips



Aviation Snips

- Chrome-molybdenum alloy steel forged blades for greater strength and durability
- Automatic safety latch releases with squeeze of the handles for easy one handed operation



Type	Wt. (lb)	ITEM	PRICE
G Straight Cut	1.0	8386070	12.99
H Left Cut	1.0	8386054	12.99
I Right Cut	1.0	8386062	12.99

10" Tin Snips

- Cuts steel, aluminum, rubber, plastic, leather and carpets
- Cuts up to 22 ga sheet metal

8043903 – Wt. 1.3 lb **9⁹⁹**



Quick Pro Shear

- Four cutting functions: Right Angle Anvil (for 90° cutting), Double Radius Anvil (for cutting round tubular materials up to 3/4" diameter), Single Radius Anvil (for cutting round tubular materials up to 1" diameter) and Mitre Anvil (for rough mitre cuts at multiple angles)

8380545 – Wt. 1.0 lb **19⁹⁹**



Offset Aviation Snips

- Cuts cold rolled and stainless steel Includes reusable holster package

J) Straight/Left Cut Snips

8228983

K) Straight/Right Cut Snips

8229049
Wt. 1.0 lb **17⁹⁹** /ea



13" Heavy Duty Aluminum Shear

- Aluminum die casting with TPR grip handle and shear body

8380552 – Wt. 1.3 lb **21⁹⁹**



Tin Snips

- Chrome vanadium blades

Type	Wt. (lb)	ITEM	PRICE
L 10" Right Cut	0.8	2920947	4.99
M 10" Left Cut	0.8	2920948	4.99
N 10" Straight Cut	0.8	2920949	4.99

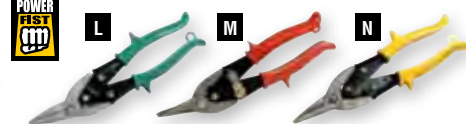



Compound Bolt Cutters

- Chrome vanadium cutting blades
- Compound cutting action
- Long handles for greater leverage

Size	Wt. (lb)	ITEM	PRICE
18"	3.6	8043878	24.99
24"	6.1	8043887	29.99
36"	12.6	8043896	49.99



Looking for the perfect gift?
GIFT CARDS
 are available at any Princess Auto location

Bolt / Cable Cutters

Bolt Cutters

A) 8" Mini Bolt Cutters

- Heat treated drop forged jaws
- General purpose for bolts, screws, wire, etc.

8044029 – Wt. 0.7 lb **8⁹⁹**

B) 9-1/2" Cable Cutter

8068686 – Wt. 1.1 lb **9⁹⁹**

C) 18" 3-In-1 Bolt Cutter

- 5/16" (8 mm) bolt cap., 3/8" (10 mm) cable cap., and 3/16" (5 mm) wire cap.

8243941 – Wt. 4.0 lb **34⁹⁹**

D) 18" Offset Bolt Cutter

- 28° offset jaw
- Chrome vanadium steel jaws
- Cutting capacity 5/16"

8243933 – Wt. 3.4 lb **24⁹⁹**

E) 18" Cable Cutter

8003749 – Wt. 4.3 lb **39⁹⁹**



Aluminum Bar Clamps

- 770 lb of clamping force
- Quick release

Clamping Capacity	Spreading Capacity	Wt. (lb)	ITEM	PRICE
6"	14"	2.1	8344269	22.99
12"	20"	2.4	8344277	24.99
18"	26"	2.6	8344285	26.99
24"	32"	2.9	8344293	29.99
36"	43"	3.4	8344301	34.99

Aluminum Bolt Cutters

14" Aluminum Bolt Cutters

- Drop-forged chrome vanadium cutting edge with teeth
- Lightweight for ease of handling

8311714 – Wt. 1.8 lb **24⁹⁹**

18" Aluminum Bolt Cutter

- Lightweight for ease of use
- Aluminum handles with chrome vanadium jaws

8312092 – Wt. 3.1 lb **34⁹⁹**



"C" Clamps

Opening 1	Opening 2	Wt. (lb)	ITEM	PRICE
2"	1"	0.4	2910503	2.99
3"	1-1/2"	1.1	2910278	4.99
4"	1-1/2"	1.3	2910511	5.99
5"	2"	1.3	2910279	6.99
6"	2-3/4"	2.0	2910529	8.99
8"	3-1/4"	3.6	2920555	11.99
10"	3-1/8"	4.7	2920556	15.99

Quick Release Bar Clamps/Spreaders

Size	Pressure	Wt. (lb)	ITEM	PRICE
6"	175 lb	0.8	8263428	7.99
12"	175 lb	1.0	8263477	11.99
24"	220 lb	2.7	8263501	18.99
32"	220 lb	3.1	8263535	21.99
48"	220 lb	3.9	8263584	24.99

Adjustable Support Rod

- Supports 99 lb vertically and 60 lb at 45°
 - Adjusts from 45" to 114"
 - Ratcheting system to extend movable shaft
- 8143208** – Wt. 5.5 lb **29⁹⁹**

Clamps

Adjustable Bar Clamps

Throat depth: 2-1/2"

Size	Wt. (lb)	ITEM	PRICE
6"	1.2	2910348	5.99
12"	1.5	2910966	6.99
18"	1.6	2910349	7.99
24"	1.9	2910982	8.99
30"	2.2	2910350	9.99
36"	2.3	2910351	10.99

Quick-Release C Clamps

- Handle can be used at 0°, 90° or 180°
- Quick release screw mechanism for fast clamping action

8264285 – 2"
Wt. 0.3 lb **2⁹⁹**

8264293 – 3"
Wt. 0.6 lb **4⁹⁹**

8006955 – 4"
Wt. 0.8 lb **5⁹⁹**

Steel Pipe Clamps

Make your own clamp length
8003389 – 1/2"
Wt. 2.7 lb **10⁹⁹**

8003390 – 3/4"
Wt. 2.8 lb **11⁹⁹**



Toggle Clamps
 • U-bar, flange base
 • A3 steel

Handle	Cap. (lb)	Wt. (lb)	ITEM	PRICE
Vert	100 lb	0.2	8252942	3.49
Vert	330 lb	0.8	8252959	12.99
Horiz	550 lb	0.5	8252967	9.99
Horiz	800 lb	1.3	8252975	11.99

4 pc Spring Clamp Set

2"
 2910068 – Wt. 0.1 lb **2⁹⁹**

4"
 1-1/2" jaw opening
 2920019 – Wt. 0.5 lb **4⁹⁹**

Spring Clamp

4"
 8264459 – Wt. 0.1 lb **1⁹⁹**

6"
 8264426 – Wt. 0.3 lb **2⁹⁹**

9"
 8264418 – Wt. 0.5 lb **3⁹⁹**

"Jorgensen"

Bar Clamps

- Load limit: 1,000 lb
- Throat depth: 3"

Size	Wt. (lb)	ITEM	PRICE
6"	2.6	8041889	17.99
12"	3.1	8041852	19.99
24"	4.1	8041825	23.99
36"	5.1	8041656	26.99

60" Deep Reach Bar Clamp

- Lightweight aluminum construction
 - 3" throat depth
- 8016844 – Wt. 2.9 lb **29⁹⁹**

'Adjustable'

3/4" Pipe Clamp
 2912459 – Wt. 2.6 lb ... **19⁹⁹**

6" Spring Clamp
 2" jaw opening
 2910750 – Wt. 0.4 lb **3⁹⁹**

Ratchet Clamps

- Swivel tips
- 6-1/4"
 8006960 – Wt. 0.2 lb **4⁹⁹**
- 9"
 8006958 – Wt. 0.5 lb **5⁹⁹**

Pliers

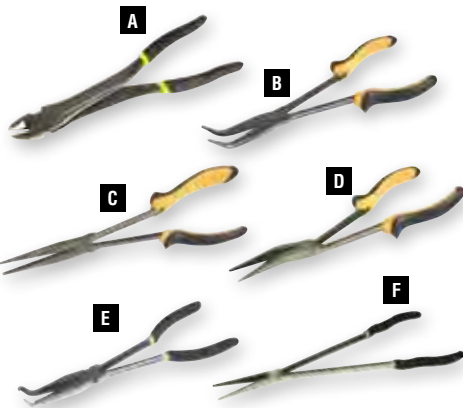

Extra Long Pliers

Type	Wt. (lb)	ITEM	PRICE
A 11" 30° Offset Diagonal Cutting	1.2	2920168	11.99
B 11" 45° Bent Nose	0.7	2925543	11.99
C 11" Long Nose	0.9	2925527	11.99
D 11" 15° Offset Nose	0.6	2925568	11.99
E 11" Hose/Cable	0.9	2990148	11.99
F 16" Straight Nose	1.1	2920270	13.99

Slip Joint Pliers

- Thermoplastic black and yellow handle
- Chrome vanadium steel
- Nickel finish

Size	Wt. (lb)	Item	Price
6"	0.8	8245177	4.99
8"	0.7	8245185	5.99
10"	0.8	8245193	6.99



Pliers

Type	Wt. (lb)	ITEM	PRICE
G 6" Diagonal Cutting	0.4	2929610	4.99
I 7-1/2" Diagonal Cutting	0.7	2929545	5.99
H 7" End Nipper	0.6	2929537	5.99
I 6" Long Nose Cutting	0.4	2929594	4.99
J 8" Long Nose	0.5	2929602	5.99



8" Lineman's Pliers

Type	Wt. (lb)	ITEM	PRICE
K 8" Linesman	0.8	2929586	5.99
L 12" Linesman	1.8	2920873	12.99

Groove Joint

- Chrome vanadium steel
- Nickel finish
- Round jaw

Size	Jaw Adj.	Wt. (lb)	ITEM	PRICE
8"	5	0.6	8245128	6.99
10"	6	1.0	8245136	8.99
12"	7	1.4	8245144	11.99
16"*	8	3.1	8245151	22.99
20"*	12	4.2	8245169	39.99

* Straight jaw

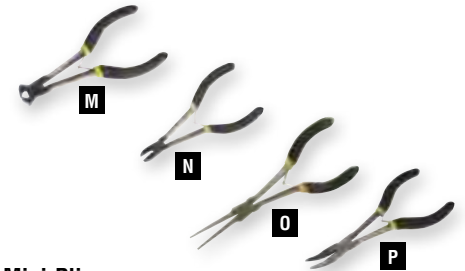

Mini-Pliers

Type	Wt. (lb)	ITEM	PRICE
M 5-1/2" End Nippers	0.2	2920192	3.99
N 5-1/2" Diagonal	0.2	2920188	3.99
O 7" Needle Nose	0.2	2920195	3.99
P 7" 45° Bent Nose	0.2	2920128	3.99

17-in-1 Stainless Steel Multi-Functional Plier

- Knife, pliers, wire cutter, can opener, mini, small, medium and large screwdrivers, bottle opener, file, hook remover, awl, LED light, wood saw and scissors
- 8265753 – Wt. 0.7 lb **24⁹⁹**

11" Fence Tool

8303711 – Wt. 1.6 lb **12⁹⁹**

Palm Nipper

8169740 – Wt. 0.1 lb **3⁹⁹**

CHANNEL LOCK

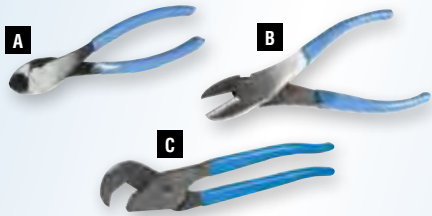

Pliers
A) 7" Cutting Pliers
 2922615 – Wt. 0.6 lb **19⁹⁹**
B) 7-3/4" Cutting Pliers
 2929107 – Wt. 0.7 lb **24⁹⁹**
C) 9-1/2" Nutbuster™
Tongue and Groove Pliers
 2929073 – Wt. 1.2 lb **19⁹⁹**

8" Long Nose with Side Cutter
 8316218 – Wt. 0.5 lb **20⁹⁹**

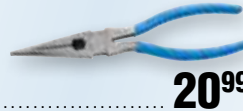

6-1/2" Slip Joint
 8316200 – Wt. 0.4 lb **12⁹⁹**



9-1/2" Linemen's
 8155244 – Wt. 1.1 lb **39⁹⁹**



Tongue & Groove

Size	Jaw Cap.	No. of Jaw Adj.	Wt. (lb)	ITEM	PRICE
9-1/2"	1-1/2"	5	0.8	2926285	16.99
10"	2"	7	1.0	2926293	17.99
12"	2-1/4"	7	1.3	2926301	18.99
16-1/2"	4-1/4"	8	2.8	2926319	34.99

Fencing
 8316226 – Wt. 1.4 lb **29⁹⁹**



pro.point



Pliers
 Chrome vanadium steel with ergonomic thermoplastic rubber grips
D) 7" Diagonal Cutting
 8332405 – Wt. 0.7 lb **14⁹⁹**

E) 8" Long Nose
 8332454 – Wt. 0.6 lb **13⁹⁹**

G) 8" Lineman's
 Serrated jaw
 8325367 – Wt. 0.8 lb **13⁹⁹**

F) 8" Bent Nose
 8332488 – Wt. 0.6 lb **13⁹⁹**

H) 10" Tongue & Groove
 8332496 – Wt. 1.0 lb **14⁹⁹**

NEW pro.point

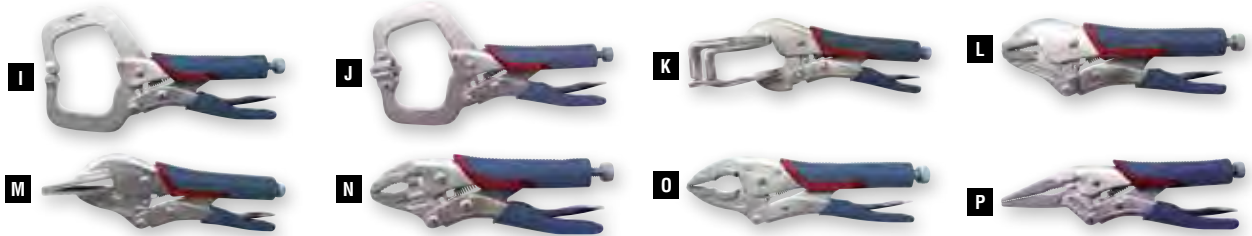

Locking Pliers

- Chrome vanadium steel jaw, chrome-moly handle
- Thermoplastic comfort grip handle

I) C-Clamp

Size	Wt. (lb)	ITEM	PRICE
6"	0.7	8347379	11.99
11"	1.9	8347262	23.99
18"	2.6	8347270	29.99

J) C-Clamp with Swivel Pads

Size	Wt. (lb)	ITEM	PRICE
6"	0.7	8347361	12.99
11"	1.9	8347312	24.99

K) Sheet Metal

Size	Wt. (lb)	ITEM	PRICE
8"	1.1	8347247	15.99
10"	1.6	8347254	17.99

L) Welders

Size	Wt. (lb)	ITEM	PRICE
9"	1.5	8347320	16.99
11"	1.9	8347346	19.99

M) Curved Jaw

With wire cutter

Size	Wt. (lb)	ITEM	PRICE
5"	0.5	8347205	9.99
7"	0.8	8347197	10.99
10"	1.3	8347189	11.99

N) Straight Jaw

Size	Wt. (lb)	ITEM	PRICE
7"	0.8	8347296	10.99
10"	1.3	8347288	12.99

O) Large Jaw

Size	Wt. (lb)	ITEM	PRICE
10"	1.4	8347353	17.99

P) Long Nose

Size	Wt. (lb)	ITEM	PRICE
6"	0.5	8347221	12.99
9"	0.9	8347213	14.99

18" Chain Clamp Locking Plier

• Chrome vanadium steel jaw, chrome-moly handle
 • Thermoplastic comfort grip
 8347304 – Wt. 1.8 lb **17⁹⁹**



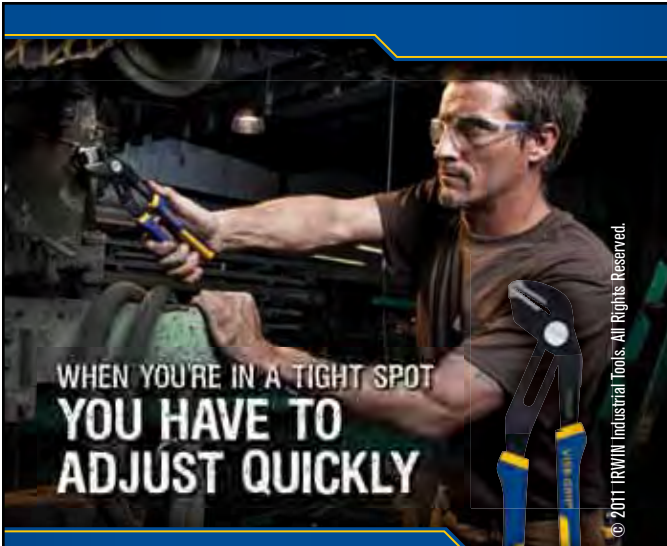

IRWIN VISE-GRIP GrooveLock Pliers: Simple Push of a Button Adjusts Jaws Two Times Faster*

IRWIN® VISE-GRIP® GrooveLock pliers get the job done fast. A simple touch of the press-n-slide button adjusts the jaw twice as fast as any other groove joint pliers in the market. The multi-groove ratcheting system provides precise jaw positioning on any type of surface. Plus, anti-pinch, non-slip ProTouch™ Grips provide comfort, control, and less hand fatigue. Now available in straight, smooth, and v-shaped jaws, GrooveLock pliers are backed by the IRWIN VISE-GRIP Lifetime Guarantee. When you need tools that help you do the job the way it was meant to be done, IRWIN Tools deliver.

* Compared to traditional groove joint pliers

www.irwin.com

IRWIN VISE-GRIP

IRWIN VISE-GRIP

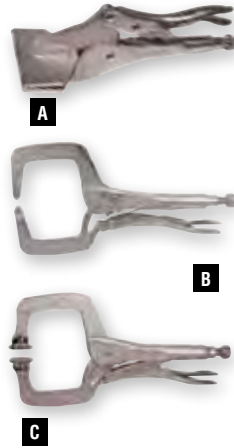

Locking Pliers

A) Locking Sheet Metal Clamp Plier

Jaw width: 3-1/8"

2911774 – Wt. 1.1 lb **21⁹⁹**

B) 11" Locking C-Clamp Plier

• Jaw adjustment: 0 to 4"

• Throat depth: 9-1/2"

2911790 – Wt. 1.7 lb **28⁹⁹**

C) 11" Locking "C" Clamp Plier with Swivel Pads

Jaw adjustment: 0 to 3-7/8"

2919298 – Wt. 1.8 lb **29⁹⁹**

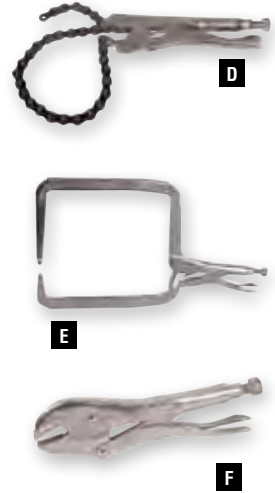

D) 9" Locking Chain Clamp

18" jaw capacity

2910023 – Wt. 1.8 lb **39⁹⁹**

E) 18" Locking "C" Clamp Plier

• Jaw adjustment: 0 to 7-1/2"

• Throat depth: 9-1/2"

2920624 – Wt. 3.4 lb **49⁹⁹**

F) 10" Straight Jaw Locking Pliers

Jaw adjustment: 0 to 1-5/8"

2911725 – Wt. 1.2 lb **16⁹⁹**



12" Large Jaw Locking Pliers

Jaw adjustment: 0 to 3-1/8"

2925451 – Wt. 1.4 lb **21⁹⁹**

V-jaw GrooveLock Pliers

• All purpose jaw grips on round, flat, square and hex shapes

• Press and slide button quickly adjusts lower jaw



10" 8250250 – Wt. 1.0 lb **17⁹⁹**

12" 8250276 – Wt. 1.4 lb **19⁹⁹**



5" Curved Jaw Locking Pliers with Wire Cutter

Cuts up to 1/4" bolt

Size	Jaw Adj.	Wt. (lb)	ITEM	PRICE
5"	0 to 1-1/4"	0.4	2911766	11.99
7"	0 to 1-5/8"	0.8	2911758	12.99
10"	0 to 1-7/8"	1.2	2911741	13.99



6" Long Nose Locking Pliers with Cutter

• Long straight nose for narrow spaces not reachable by curved or straight jaws

• Cuts up to 1/4" bolt

Size	Jaw Adj.	Wt. (lb)	ITEM	PRICE
6"	0 to 2-1/4"	0.4	2917052	16.99
9"	0 to 2-7/8"	0.9	2918613	19.99

Snap Ring Pliers



4 pc Mini Snap Ring Plier Set

• Contains straight and bent internal and external pliers

• Ideal for narrow spaces

8031532 – Wt. 0.4 lb **9⁹⁹**



10-1/2" Locking Snap Ring Pliers Kit

For external ring sizes up to 3-3/4", and internal ring sizes up to 4"

8006613 – Wt. 3.0 lb **42⁹⁹**



Snap Ring Plier Kit

2921385 – Wt. 1.0 lb **14⁹⁹**

Lock Ring Pliers

• Max. opening size: 1-5/32"

• Right angled knurled tips hold rings securely

8243495 – Wt. 0.5 lb **14⁹⁹**

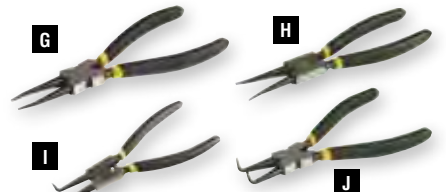

Snap Ring Pliers

Chrome vanadium steel with knurled tips
Wt. 0.3 lb

	Size	ITEM	PRICE
G	Straight Nose Internal	8007373	4.99
H	Straight Nose External	8007382	4.99
I	Bent Nose External	8007391	4.99
J	Bent Nose Internal	8007408	4.99



10 pc Snap Ring Plier Set

8158792 – Wt. 4.2 lb

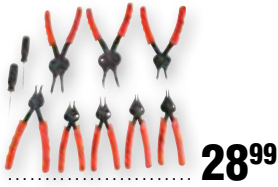

12 pc Snap Ring Plier Set

Chrome molybdenum steel pliers with heat-treated black finish
8380891 – Wt. 6.2 lb

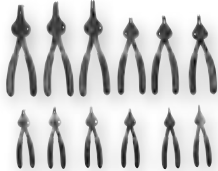

pro.point



24" Aluminum Professional Box Level

- Heavy duty aluminum frame
- Double milled surfaces for high accuracy

24" 8346959 – Wt. 1.1 lb **24⁹⁹**

48" 8346967 – Wt. 2.0 lb **34⁹⁹**

72" 8346975 – Wt. 2.9 lb **59⁹⁹**



C) Bullseye Level
8347049 – Wt. 0.1 lb **1⁴⁹**



D) Line & Surface Level
2944940 – Wt. 0.1 lb **2⁹⁹**



E) Magnetic Post Level
Magnets and rubber strap allow for hands free work
8350209 – Wt. 0.2 lb **4⁹⁹**



Digital Angle Finder

Large, easy-to-read LCD display with low battery, hold, and mitre functions
8145021 – Wt. 1.4 lb

89⁹⁹



9" Magnetic Torpedo Level

3 leveling vials
8346926 – Wt. 0.3 lb

4⁹⁹

Extra Large Snap Ring Pliers

- 1/3" to 3" capacity

For use on large snap rings on drive shafts in earth-movers and construction vehicles
8355398 – Wt. 1.2 lb **39⁹⁹**



4-in-1 Snap Ring Plier Set

8007417 – Wt. 0.4 lb **5⁹⁹**



4 pc 7" Snap Ring Pliers Set

8007364 – Wt. 1.4 lb **18⁹⁹**



8" Internal / External Retaining Ring Pliers

1/4" to 2" external 3/8" to 2" internal capacity
8182255 – Wt. 0.6 lb **27⁹⁹**

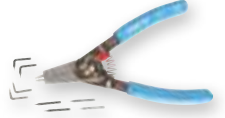

Heavy Duty Internal/External Snap Ring Pliers

Reversible action for internal and external snap rings
2920133 – Wt. 0.7 lb **39⁹⁹**



Levels

A



B

Electricians Torpedo Levels

- Displaying angles of 0°, 30°, 45° and 90°
- V-groove for pipe and conduit work
- Rare earth magnet allow for hands free use on metal surface
- Anodized aluminum alloy

A) 8263519 – 8-1/4" Wt. 0.3 lb **22⁹⁹**

B) 8263543 – 5-1/4" Wt. 0.3 lb **19⁹⁹**



10" Magnetic Torpedo Level

8344426 – Wt. 0.5 lb **19⁹⁹**



Aluminum Magnetic Levels

Magnetic edge holds to ferrous surfaces
24" 2944296 – Wt. 1.3 lb **29⁹⁹**
48" 8348054 – Wt. 2.5 lb **44⁹⁹**



18" Laser Level

8347023 – Wt. 0.9 lb **24⁹⁹**

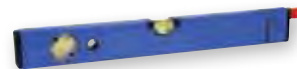

Levels

24" 8346934 – Wt. 1.0 lb **14⁹⁹**

48" 8346942 – Wt. 1.7 lb **24⁹⁹**



Magnetic Bridge Level

Cast aluminum alloy body with milled base
8344368 – Wt. 0.4 lb **14⁹⁹**



24" Digital Level

• Reads level as well as angle and plumb
• Easy read backlit LCD screen
8347015 – Wt. 1.9 lb **49⁹⁹**



Aluminum Magnetic Torpedo Level

• 3 heavy duty vials: 45°, 90° and 180°
• Aluminum X beam construction
8368599 – Wt. 0.5 lb **16⁹⁹**



Professional Torpedo Laser Level

• Anodized aluminum construction
• Magnetic bottom
8354169 – Wt. 0.5 lb **29⁹⁹**



Laser Level Kit

• Kit includes 16" laser level, swivel base, tripod and goggles
• Aluminum level body
8347031 – Wt. 8.2 lb **99⁹⁹**



3-Way Mini Pocket Level

• Compact 6" size
• Strong rare earth magnet for use on metal surfaces
8346991 – Wt. 0.3 lb **7⁹⁹**



Marking Tools



A

A) 240 ft Construction Line
Strong 18 braid nylon line
8211864 – Wt. 0.4 lb **4⁹⁹**



B

B) Polyethylene Brick Line with Reel
Made from orange polyethylene
8323347 – Wt. 0.2 lb **4⁹⁹**



Brick Layer's Line with Line Blocks
Ideal for laying out brick courses
8323339 – Wt. 0.2 lb **4⁹⁹**



Mechanical Carpenter's Pencil
8364796 – Wt. 0.1 lb **2⁹⁹**

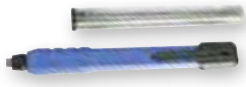

Chalk Line Refill
8324097 – Red
8324105 – Blue
Wt. 0.6 lb **2⁴⁹ / ea**
8324121 – Waterproof
Wt. 0.6 lb **2⁹⁹**



Empire
8 oz Brass Plumb Bob
8344483 – Wt. 0.6 lb **9⁹⁹**



48" drywall T-Square
8344475 – Wt. 1.6 lb **18⁹⁹**



JOHNSON
E) 100 ft (30 M) Chalk Line
8264582 – Wt. 0.4 lb **3⁹⁹**



F) 100 ft (30 M) Chalk Line
8045023 – Wt. 0.6 lb **7⁹⁹**

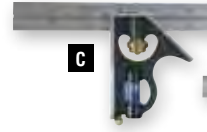

Empire
Combination Squares
C) 6" Pocket
8344434 – Wt. 0.3 lb **12⁹⁹**



D) 12" Heavy Duty Professional
8344442 – Wt. 0.8 lb **14⁹⁹**



12" Poly handle
8347999 – Wt. 0.5 lb **7⁹⁹**



pro.point
6" Combination Square
8348013 – Wt. 0.3 lb **9⁹⁹**



8" Tri-Square
SAE and metric measurements on blade
8356453 – Wt. 0.2 lb **4⁹⁹**

Rulers

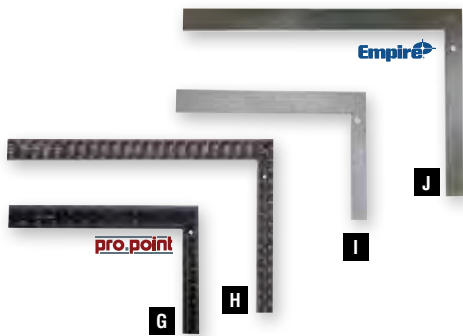

Squares
G) 8" x 12" Steel Square
8345423 – Wt. 0.4 lb **4⁹⁹**

H) 16" x 24" Steel Framing Square
8345407 – Wt. 1.8 lb **8⁹⁹**

I) 8" x 12" Steel Carpenter Square
8344459 – Wt. 0.6 lb **5⁹⁹**

J) 16" x 24" Tradesman Square
2944346 – Wt. 1.7 lb **9⁹⁹**

8" Sliding T-Bevel
8345399 – Wt. 0.2 lb **4⁹⁹**

6" Metal Pocket Ruler
2940526 – Wt. 0.1 lb **1⁴⁹**

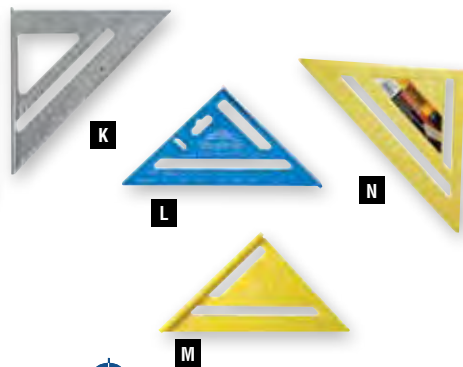

Empire
K) 7" Aluminum Rafter Square
7-1/4" x 7-1/4" x 10-1/4"
8244048 – Wt. 0.3 lb **3⁹⁹**

7" Aluminum Oxide Rafter Square
7-1/4" x 7-1/4" x 10-1/4"
8246456 – Wt. 0.4 lb **8⁹⁹**

L) Hi-Vis 7" Professional Rafter's Square
8347098 – Wt. 0.6 lb **9⁹⁹**

M) 7" Polysquare™ Rafter Square
8344467 – Wt. 0.3 lb **4⁹⁹**

N) 12" Polysquare™ Rafter Square
Extra large size makes marking and cutting wider boards easy
2940061 – Wt. 0.7 lb **12⁹⁹**



Empire
Magnetic Polycast® Protractor
Magnetic base and back
2940064 – Wt. 0.4 lb **14⁹⁹**



Protractor / Angle Finder
Measures and transfers inside and outside angles
8344376 – Wt. 0.1 lb **3⁹⁹**



pro.point
Meter Stick
• Easy read white markings on black finish
• 40" / 100 cm SAE and Metric measurements
8356446 – Wt. 0.5 lb **7⁹⁹**

Got a question about one of our products?



Post a customer review at princessauto.com! We'll answer the question for your benefit and for other guests.

pro.point

Tape Measures

SAE / Metric

- Stainless steel case with rubber grip
- Nylon coated blade



Length	Blade Width	Wt. (lb)	ITEM	PRICE
12 ft	5/8"	0.4	8351231	6.99
16 ft	3/4"	0.5	8351249	8.99
25 ft	1"	0.9	8351256	11.99
33 ft	1"	1.1	8351264	14.99



SAE / Fractional

- Nylon coated blade
- Fractional measurements printed on blade



Length	Blade Width	Wt. (lb)	ITEM	PRICE
16 ft	3/4"	0.5	8351348	6.99
25 ft	1"	0.8	8351355	9.99
38 ft	1"	1.1	8351389	12.99



Tape Measures

Nylon coated blade



Length	Blade Width	Wt. (lb)	ITEM	PRICE
12 ft	5/8"	0.3	8351553	4.99
16 ft	3/4"	0.5	8351579	6.99
25 ft	1"	0.8	8351587	9.99
33 ft	1"	1.2	8351629	12.99

KOMELON
USA Division



SAE Tape Measures

- Nylon coated blade for maximum durability

C) Self-Locking

16 ft x 1" **12⁹⁹**

25 ft x 1" **14⁹⁹**

D) Classic Chrome Self Lock™

Classic chrome plating with impact resistant rubberized case
25 ft x 1" **16⁹⁹**

8113946 - Wt. 1.0 lb

pro.point

Tape Measures

- 3/8" wide nylon coated blade
- 3:1 ratio gear winder for faster return speed

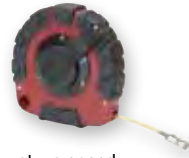

Length	Blade Width	Wt. (lb)	ITEM	PRICE
50 ft	3/8"	0.7	8351645	15.99
100 ft	3/8"	1.1	8351660	19.99

pro.point

SAE/Metric Open Reel Tape Measures

- A) • 1/2" wide fiberglass tape
- 3:1 ratio gear winder for faster return speed

Length	Blade Width	Wt. (lb)	ITEM	PRICE
100 ft	1/2"	2.9	8351678	21.99
330 ft	1/2"	4.7	8351686	34.99

B)

- Rubber grip handle
- Reinforced touch point
- Reinforced blade

Length	Blade Width	Wt. (lb)	ITEM	PRICE
100 ft	1/2"	1.4	8351405	11.99
330 ft	1/2"	3.3	8351413	24.99

Measuring Tools

pro.point

6" Professional Measuring Wheels

Folds down for easy storage

8329492 - SAE

8329500 - Metric

Wt. 3.5 lb.



69⁹⁹ /ea

pro.point

12" Professional Measuring Wheels

- Foldable design for easy storage
- 5 digit display measures up to 10,000 metres in 10 cm increments

• High traction tire mounted on high impact ABS wheel

• Easy grip pistol type handle with reset and brake trigger

• Kick stand

8351223 - SAE

8351215 - Metric

Wt. 6.1 lb.

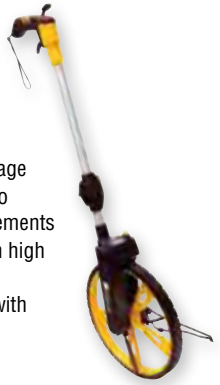

89⁹⁹ /ea



12-1/2" Digital Measuring Wheel

• Top mounted control panel for easier reading

• Backlit display for use in low light conditions

• Auto power off after 3 minutes

• Conversion units: foot/metre/yard, square yard/square metre/acres, cubic foot/cubic metre/cubic yard

8241150 - Wt. 5.2 lb **99⁹⁹**



4" Mini Measuring Wheel

Handle extends from 20" to 44-1/2"

8351439 - SAE

8351488 - Metric

Wt. 1.6 lb.



34⁹⁹ /ea

Precision Measuring Tools



Calipers

- Resolution: 0.1 mm/0.01"
- Accuracy: ± 0.02 mm/0.01"

A) 4"
Range: 0-100 mm/4"
8321069 – Wt. 0.2 lb **14⁹⁹**

B) 6"
Range: 0-150 mm/6"
8321077 – Wt. 0.2 lb **19⁹⁹**

C) 6" Metal Caliper
• Range: 0 to 6" (0 to 15 cm)
• Thumb roller adjust with top lock screw
2940003 – Wt. 0.2 lb **4⁹⁹**

D) 6" Stainless Steel Dial Caliper

• Range: 0 to 6"
• Resolution: 0.001"
2940252 – Wt. 0.7 lb **29⁹⁹**

Micrometers

• Complete with locking lever and ratchet
• Graduated to 0.0001"

E) 0" to 1" Outside Micrometer
2940393 – Wt. 0.6 lb **19⁹⁹**

F) 1" to 2" Outside Micrometer
8009567 – Wt. 1.1 lb **21⁹⁹**

6 pc Telescoping Gauge Set

Determine size of holes, slots and recesses
2940716 – Wt. 0.9 lb **24⁹⁹**



Gauges

G) 2-1/4" Dia. Deflection Gauge

• Use with magnetic base
• 0.1" travel per revolution, 1" total travel
• 0.001" graduations
2970986 – Wt. 0.3 lb **18⁹⁹**

H) Digital Thickness Gauge

• Range: 0-12.7 mm/0.5"
• Resolution: 0.01 mm/0.0005"
• Accuracy: ± 0.03 mm/0.001"
8321036 – Wt. 0.2 lb **14⁹⁹**



Micrometer Stand

Holds micrometers up to 4"
8372138 – Wt. 0.1 lb **17⁹⁹**



6" Solar Digital Caliper

• Range: 0 to 6" (150 mm)
• Resolution: 0.01" / 0.01 mm
• Accuracy: ± 0.01 " / 0.2 mm
8372054 – Wt. 0.1 lb **24⁹⁹**



Audible Moisture Detector

Detects from 15% to 100% dampness which may not be visible in masonry, plaster and wood
8003687 – Wt. 0.3 lb **12⁹⁹**



3-In-1 Detector

• Detects studs, AC live wires and metals
• LED display and audible signal indicate stud edge and centre
8101354 – Wt. 0.6 lb **24⁹⁹**



6" Contour Gauge

• Black steel body with SAE and metric graduation
• 3-1/4" long stainless steel pins
8059982 – Wt. 0.5 lb **9⁹⁹**



Metal Digital Calipers

• Durable metal housing
• ON / OFF switch
• Metric, SAE and fractional display
• Zero setting switch
• Accuracy: ± 0.03 mm
• Resolution: 0.01 mm/0.0005"

6" Fractional
8372062 – Wt. 0.1 lb **39⁹⁹**

8" Fractional
8372070 – Wt. 0.1 lb **54⁹⁹**

12" Fractional
8372088 – Wt. 0.1 lb **89⁹⁹**



Sheet Metal Gauge

• US standard 0 to 36
• Measures uncoated sheet metal, steel and plate iron
8003604 – Wt. 0.1 lb **13⁹⁹**



6 pc Precision Measuring Set

4" brass vernier caliper, 6" inside caliper, 6" divider, 6" outside caliper, 6" depth gauge and 6" pocket ruler
8162075 – Wt. 0.9 lb **19⁹⁹**



3 pc Divider and Caliper Set

Inside and outside calipers, plus divider

Size	Wt. (lb)	ITEM	PRICE
6"	0.5	8369126	9.99
8"	0.8	2940260	14.99
12"	1.2	8369134	19.99

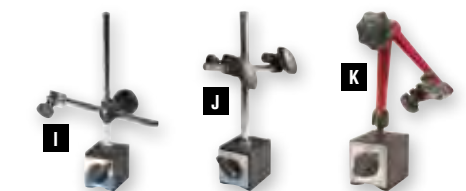
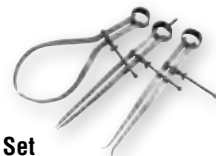

Magnetic Bases

Can be mounted in any position: will fasten on angles, upside down and on round bar

	Magnetic Attraction	Wt. (lb)	ITEM	PRICE
I	90 lb (40 kg)	0.9	8048779	34.99
J	130 lb (60 kg)	3.3	2944460	26.99
K	175 lb (80 kg)	0.1	8372120	49.99

NEW pro.point

Digital Indicator

• Functions: Manual power ON / OFF, ZERO setting at any position, mm/in conversion at any position
• Resolution: 0.01 mm/0.001"
• Accuracy: ± 0.03 mm
8372112 – Wt. 0.5 lb **69⁹⁹**



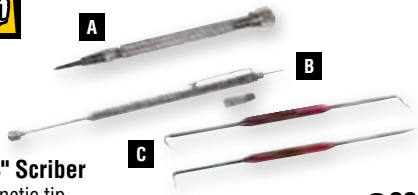

A) 4" Scriber
Magnetic tip
8161978 – Wt. 0.1 lb **3⁹⁹**

B) 2-In-1 Telescoping Pick-Up/Scriber
Extends from 6" to 26"
8163974 – Wt. 0.1 lb **3⁹⁹**

C) 2 pc O-Ring & Scribe Set
Steel tips
8105876 – Wt. 0.1 lb **4⁹⁹**



Hobbyist Tools
Assorted sizes and styles of tweezers
8035477 – 4 pc
Wt. 0.2 lb **3⁹⁹**

8035468 – 5 pc
Wt. 0.2 lb **4⁹⁹**

7 pc Art Knife Set
Includes handle and 6 assorted blades
8025237 – Wt. 0.1 lb **2⁹⁹**

5 pc Art Knife Replacement Blades
For item number 8025237
8025246 – Wt. 0.1 lb **1⁴⁹**

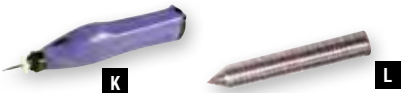

K) Multi-Purpose Engraver with Diamond Tip
• Free speed: 11,000 to 12,000 RPM
• Requires 2 AAA batteries (not included)
8021053 – Wt. 0.1 lb **14⁹⁹**

L) Replacement Tips for Powerfist Electric Engraving Tool
2 pc replacement carbide tips
8364770 – Wt. 0.1 lb **6⁹⁹**

Leather Punch with Eyelet Pliers
Punch holes: 2.5, 3, 3.5, 4, 4.5 and 5 mm
8308231 – Wt. 1.0 lb **7⁹⁹**



12 pc Sculpting Tool Set
8" long double ended tools
8111338 – Wt. 0.6 lb **12⁹⁹**

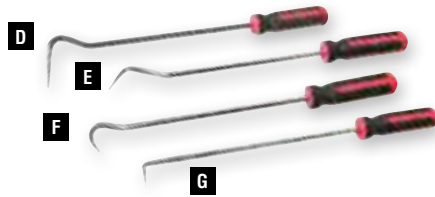

15" Hook Tools
5/16" shank
D) 8262362 – Angular Hook Tool
E) 8262289 – Offset Hook Tool
F) 8262339 – J Hook Tool
G) 8262313 – Glass Run Channel Cleaner
Wt. 0.4 lb **4⁹⁹ /ea**



4 pc Pick and Hook Set
Includes: straight pick, 90° hook, curved hook and offset hook
8168577 – Wt. 0.5 lb **6⁹⁹**



Dust Remover
Rubber bulb with brass nozzle
8162042 – Wt. 0.2 lb **2⁹⁹**



9" All Purpose Awl
Black plastic handle, chrome vanadium steel tip
2910159 – Wt. 0.2 lb **3⁹⁹**



Screen Installation Tool
8222341 – Wt. 0.3 lb **6⁹⁹**



4-In-1 Eyeglass Maintenance Tool
8103988 – Wt. 0.1 lb **1⁹⁹**



Third Hands
M) Third Hand with 2x Magnifying Glass
2-1/2" magnifying glass
2970341 – Wt. 0.8 lb **4⁹⁹**

N) Heavy Duty Third Hand with 3x Magnifying Glass
Steel clips and holders for hands
free operation
8068793 – Wt. 1.7 lb **11⁹⁹**

Hobby Tools

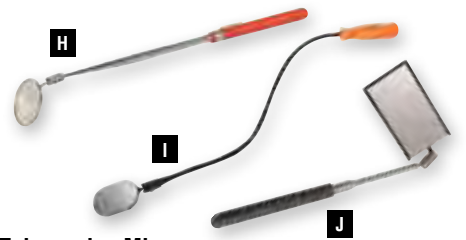

Telescoping Mirrors
H) 2" Telescoping Mirror
Extends 6" to 33"
2970237 – Wt. 0.2 lb **4⁹⁹**

I) Inspection Mirror with Flex Shaft
21" handle, 2" x 3" mirror
2970229 – Wt. 0.4 lb **7⁹⁹**

J) Telescopic Inspection Mirror
• 3 section telescoping handle extends from 14-1/2" to 32"
• 2" x 3-1/2" mirror
8159501 – Wt. 0.3 lb **9⁹⁹**



4 pc Stainless Steel Pick & Hook Set
8119802 – Wt. 0.3 lb **6⁹⁹**



Jeweller's Precision drill
2 double way collet jaws and 3 drill bits
8320038 – Wt. 0.1 lb **9⁹⁹**



Dental Pick Set
4 pc
• Dual ended, stainless steel construction
• 6" long
2924744 – Wt. 0.2 lb **5⁹⁹**

6 pc
Assorted stainless steel picks
8077844 – Wt. 0.2 lb **6⁹⁹**

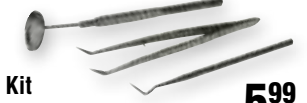

3 pc Dental Tool Kit
2970945 – Wt. 0.2 lb **5⁹⁹**

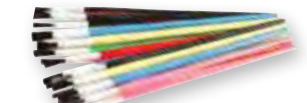

20 pc Artist Brush Assortment
2970032 – Wt. 0.1 lb **2⁹⁹**



Mini Steel Pick Axe
Fibreglass handle
8218091 – Wt. 1.4 lb **11⁹⁹**



A) Leather Punch

- Creates punch diameters of 2, 2.5, 3, 3.5, 4 and 4.5 mm
 - Revolving spindle for easy size selection
- 8123697 – Wt. 0.7 lb **5⁹⁹**

B) Leather Punch with Eyelet Fastener

- 2.5, 3, 3.5, 4 mm, and 4.5 mm punches
 - 25 each of chrome, brass, copper, and black coloured eyelets
- 2970003 – Wt. 0.7 lb **7⁹⁹**

100 pc Replacement Eyelets

2970261 – Wt. 0.1 lb **2⁹⁹**

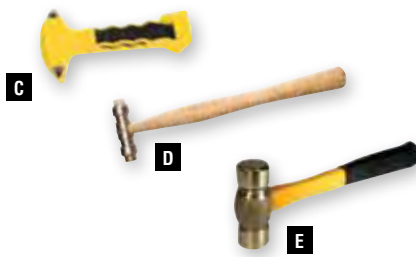

C) Emergency Automotive Hammer

Use to slice open a seatbelt or shatter a window
8184343 – Wt. 0.4 lb **3⁹⁹**

D) Nylon/Brass Hobby Hammer

Brass on one end, nylon on the other end
8223901 – Wt. 0.2 lb **9⁹⁹**

E) 16 oz Brass Hammer

- Non-sparking
- Fibreglass handle

2920959 – Wt. 1.3 lb **21⁹⁹**

Professional jobs require professional tools.

pro.point
hard.working.tools.

EXCLUSIVELY AT: **PRINCESS AUTO**

Magnetic Floor Sweepers

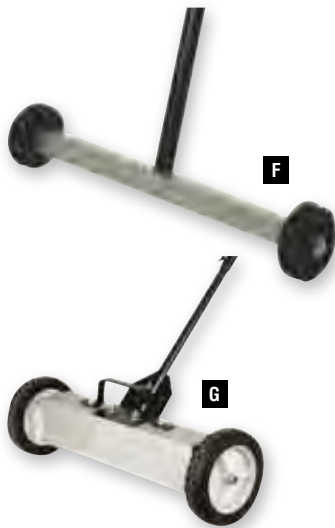

Magnetic Floor Sweepers

May be used to clear walkways, factory aisles, loading docks and parking lots

F) Mini Magnetic Floor Sweeper

- Lightweight 14-1/2" magnet
 - 41" handle and small 3" dia. wheels allow use under work benches and vehicles
- 8000698 – Wt. 3.8 lb **34⁹⁹**

G) 18" Magnetic Floor Sweeper

- 30 lb capacity
 - Adjustable sweeping height: 3/4" to 1-1/2"
 - Release handle for easy removal of debris
 - Adjustable handle extends from 25" to 40"
- 8171746 – Wt. 14.7 lb **54⁹⁹**



H) 24" Floor Sweeper Magnet with Release

- 27" span with 24" magnet
 - Very powerful heavy duty magnet
- 8210262 – Wt. 36.5 lb **129⁹⁹**

MASTER MAGNETICS, INC.
THE MAGNET SOURCE

I) 24" Wide Magnetic Floor Sweeper

48" handle
8040498 – Wt. 27.6 lb **169⁹⁹**

J) 48" Magnetic Hanging Sweeper

- Attached release handle
 - Hanging chains included
 - Pulling force: 120 lb
 - Attach to truck or forklift to pick up nails from warehouse floors or parking lot
- 8238305 – Wt. 21.7 lb **179⁹⁹**

Mirrors & Magnifiers



Magnifiers

K) 4x Jeweller's Magnifying Eye Glass

Ideal for jewellers, stamp collectors, hobbyists, and science projects
2970139 – Wt. 0.1 lb **1⁹⁹**

L) 5 pc Magnifying Eye Loupe Set

Includes: 2x, 3x, 5x, 7x and 10x
8259707 – Wt. 0.1 lb **6⁹⁹**

M) Lighted Magnifying Glass

- 5X magnifier
- Requires 2 "AA" batteries

8001976 – Wt. 0.8 lb **8⁹⁹**

N) Magnifying Glass with Flexible Shaft

3.5X magnifier
8001985 – Wt. 1.6 lb **11⁹⁹**

O) Magnifying Glass with LED Work Light

- Flexible head 3X magnifying glass
 - 14 LED light
 - Requires 2 x AAA batteries
- 8319675 – Wt. 2.1 lb **27⁹⁹**

P) Low-Heat Magnifying Lamp

- Large 5" glass lens with 1.7/2.25X magnifier
 - 22W daylight simulation tubes for colour matching
 - Fully adjustable arm with 40" extension
 - Mounts with table bracket
- 8217697 – Wt. 9.1 lb **69⁹⁹**

LED Magnifying Glass

- 3X magnifying glass with magnetic base
 - 14 LED light
 - Requires 2 x AAA batteries
- 8319642 – Wt. 0.9 lb **24⁹⁹**

Visor with Adjustable Magnifying Lens

- Magnifier with an additional internal and external flip down lens for closer viewing
 - Visor flips up out of the way
- 5040105 – Wt. 0.4 lb **9⁹⁹**



100 lb Capacity Holding & Retrieving Magnet

- Attach rope, chain or rod to eyebolt
- Ideal for holding and positioning metal objects

8183931 – Wt. 0.8 lb **9⁹⁹**
 8183949 – Wt. 4.0 lb **29⁹⁹**



Handle Magnets

Lift Cap.	Wt.(lb)	ITEM	PRICE
Up to 50 lb	0.4	8158982	7.99
Up to 100 lb	0.7	8158990	9.99
Up to 150 lb	2.0	8159006	14.99

Screwdriver

Magnetizer / Demagnetizer
 Pass the screwdriver through the centre hole to magnetize, slide through channel to demagnetize.

8124786 – Wt. 0.2 lb **3⁹⁹**



2 pc Magnetic Clips
 8164303 – Wt. 0.2 lb **3⁹⁹**



Universal Latch Magnet

- Powerful latch magnet set in durable red plastic casing with four elongated holes allows multi-directional and adjustable mounting
- 1/8" thick steel strike plate with countersunk holes to accommodate screws
- Pulls up to 50 lbs

8079238 – Wt. 0.5 lb **8⁹⁹**



Magnetic Parts Trays

I) Round
 4" **2⁹⁹**
 8244972 – Wt. 0.4 lb **2⁹⁹**
 6" **3⁹⁹**
 8244964 – Wt. 0.6 lb **3⁹⁹**

J) Rectangular
 9-1/2" x 5-1/2" **7⁹⁹**
 8244980 – Wt. 1.5 lb **7⁹⁹**
 14" x 6" **9⁹⁹**
 8245029 – Wt. 2.4 lb **9⁹⁹**

K) 2-1/2" x 3-3/4" Rectangular
 • Keep small metal parts within reach
 • Rubberized base won't scratch surfaces
 8245078 – Wt. 0.2 lb **2⁴⁹**

Magnets



Magnets

A) Magnetic Hooks 2"
 Holds up to 3 lbs
 8105868 – Wt. 0.9 lb **4⁹⁹**
3-3/8"
 Holds up to 10 lbs
 8244915 – Wt. 1.0 lb **3⁹⁹**

B) Holding Magnet with Knob Handle
 Holds up to 25 lbs.
 8079246 – Wt. 0.4 lb **5⁹⁹**

C) Flexible Magnetic Tape Roll
 1/2" x 30" Adhesive backed
 8159014 – Wt. 0.2 lb **2⁴⁹**

D) 2 pc Ceramic Magnetic Blocks
 3/8" x 7/8" x 1 7/8"
 8159063 – Wt. 0.3 lb **2⁴⁹**

E) Magnetic Base with Keyring
 1" dia. extremely strong neodymium magnet with keyring attachment Holds up to 35 lb
 8183899 – Wt. 0.1 lb **5⁹⁹**

F) Magnetic Hook Set
 Ideal for holding keys, tools and more
2 pc 1-1/2"
 Holds up to 8 lb
 8272411 – Wt. 0.2 lb **3⁹⁹**
2 pc 2"
 Holds up to 15 lbs
 8272437 – Wt. 0.4 lb **4⁹⁹**

G) 3 pc Neodymium Disc Magnets
 • Extreme strength magnets
 • .709" dia. x .118" thick
 8183907 – Wt. 0.1 lb **7⁹⁹**

H) 10 pc Neodymium Disc Magnets
 • .315" dia. x .118" thick
 • Resistant to demagnetization
 8183915 – Wt. 0.1 lb **4⁹⁹**

6 pc Ceramic Magnetic Discs

Dia.	Height	Wt.(lb)	ITEM	PRICE
1"	5/32"	0.2	8159022	2.49
3/4"	3/16"	0.1	8159030	2.49

Pick-Up Tools



Pick-Up Tools

L) Magnetic with 17" Flex Shaft
 5 lb cap.
 2970228 – Wt. 0.4 lb **8⁹⁹**

M) Releasing Pick-Up Magnet
 8" x 3-1/2" dia. magnet
 8048928 – Wt. 0.6 lb **8⁹⁹**

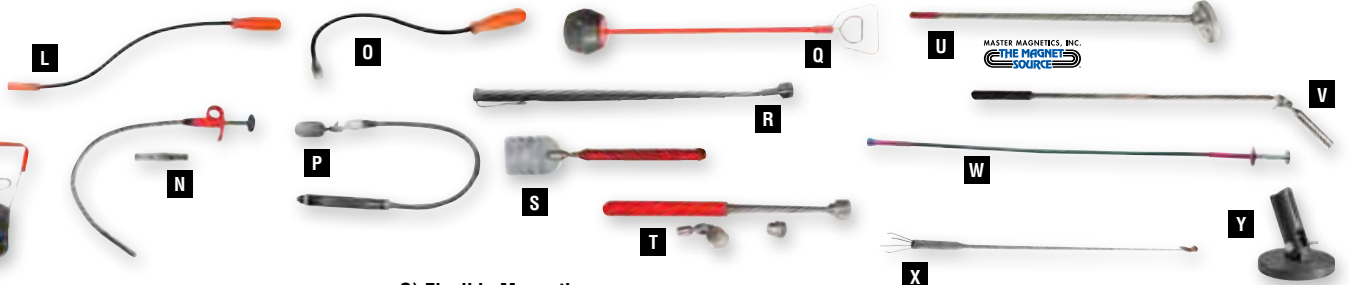

N) LED Magnetic with 18" Flex Shaft
 4 claw pick up with 3 lb magnet
 8121576 – Wt. 0.5 lb **14⁹⁹**

O) Flexible Magnetic
 8053811 – Wt. 0.4 lb **9⁹⁹**

P) Magnetic Pick-Up Tool with Light and Mirror
 • 5 lb pick-up tool with light and mirror
 • Requires 2 "AA" batteries (included)
 8049553 – Wt. 0.6 lb **12⁹⁹**

Q) Releasing Pick-Up Magnet with 27" Handle
 3-1/2" dia. magnet, max. cap.:
 25 lb (11.3 kg)
 8048936 – Wt. 1.3 lb **14⁹⁹**

R) Telescoping Pickup Magnet
 • Adjusts from 6" to 24"
 • Flexible head, pocket clip
 • 5 lb max. pull
 2970154 – Wt. 0.1 lb **4⁹⁹**

S) Magnetic with Mirror
 Telescopic shaft extends from
 5-1/2" to 20" long
 8104663 – Wt. 0.2 lb **6⁹⁹**

T) Telescopic with Magnetic Adapters
5 lb flex, 5 lb straight and 3 lb straight
2970263 – Wt. 0.3 lb **9⁹⁹**

U) Magnetic
• 50 lb capacity
• 35" handle will reach under vehicles, work benches
8050601 – Wt. 1.2 lb **12⁹⁹**

V) Telescoping Magnetic
• Handle extends from 15" to 25"
• Strong rare earth magnetic tip
8046013 – Wt. 0.4 lb **14⁹⁹**

W) 27" 2-in-1 Claw Magnet
• 4 jaw claw
• 10 oz capacity magnet
8262487 – Wt. 0.3 lb **7⁹⁹**

X) 36" with Spring Loaded Fingers
2970033 – Wt. 0.2 lb **2⁴⁹**

Y) Pick-Up Magnet
• Attaches to a standard threaded broom handle to be used as a pick-up tool
• 65 lb capacity
8144669 – Wt. 0.8 lb **6⁹⁹**



3 pc Flexible Pick-Up Tool Set
24" magnetic flexible bit holder, 27-1/4" 2-in-1 flexible pick-up tool and 24" flexible 1/4" dr socket adapter
8306805 – Wt. 1.9 lb **29⁹⁹**

Stamp Sets

9 pc
• Carbon steel
• Includes numbers 0 - 8



Size	Wt. (lb)	ITEM	PRICE
1/8"	0.4	8272353	3.99
1/4"	0.7	8272387	6.99
5/16"	1.2	8355737	12.99
3/8"	1.6	8355703	17.99

27 pc
• Carbon steel
• Letters A to Z, including "&"



Size	Wt. (lb)	ITEM	PRICE
1/8"	1.1	8272395	11.99
1/4"	1.9	8272403	19.99
5/16"	3.7	8355778	29.99
3/8"	4.8	8355802	39.99

pro.point

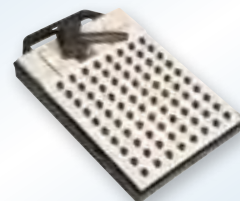

82 pc Interchangeable Stamping Set

• Hand held holder with slide block ensures evenly distributed marking of up to 5 characters at a time
• A-Z (x 2), 1-9 (x 2), 0 (x 3), and 1 each of ., /, &, and -
• High resistant steel stamps 3/16" size (5 mm)
8338972 – Wt. 2.6 lb **79⁹⁹**

NEW



Flex Shaft LED Pick-Up Tools

9-3/4" Reach
Includes dual claw/magnetic pickup end
8381816 – Wt. 0.4 lb **19⁹⁹**

20-1/2" Reach
3 lb capacity pick-up magnet
8381824 – Wt. 0.5 lb **24⁹⁹**

Thread Repair

SAE Threaded Insert Installation Kit

• Installs threaded insert into sheet metal similar to the way pop rivets are inserted
• Includes insertion tool and 40 inserts (10 of each size: #6-32, #8-32, #10-24, and 1/4"-20 (NC) machine thread)



Pieces	Size	Wt. (lb)	ITEM	PRICE
40	10 of each size: #6-32, #8-32, #10-24, and 1/4"-20 (NC) machine thread	1.9	2925204	34.99
80	20 each: #6-32, #8-32, #10-24, 1/4"-20 (NC)	0.2	2925501	17.99
100	1/4"-20 (NC)	0.3	2921872	21.99

3/8" dr Tap Holder

Use with a 3/8" dr ratchet for driving taps
8356370 – Wt. 0.2 lb **6⁹⁹**



2 pc Nut Splitter Set

• Remove damaged nuts without bolt thread damage
• Suitable for up to grade 5 (8.8 mm) nuts
• 3/16" to 3/4" and 9/16" to 1-1/16" cap.
2919587 – Wt. 1.0 lb **17⁹⁹**



Stud Remover

• 1/4" to 3/4" dia. studs
• 1/2" dr
2925113 – Wt. 1.3 lb **14⁹⁹**



Thread Gauge

• 26 SAE pitch measurements from 4 to 42 threads per inch
• 26 metric pitch measurements from 0.25 to 6 mm
2940117 – Wt. 0.2 lb **8⁹⁹**



A

A) T-Tap Wrench
Holds #4 to 1/4" taps
3408465 – Wt. 0.2 lb **6⁴⁹**

Holds 1/4" to 1/2" taps
8141079 – Wt. 0.4 lb **10⁹⁹**



B

pro.point

B) Ratcheting Tap Wrench
24 tooth construction
1/8" to 3/8" diameter
8243206 – Wt. 0.5 lb **19⁹⁹**

1/4" to 1/2" diameter
8243230 – Wt. 1.4 lb **24⁹⁹**

12 pc Tap & Die Sets

• High strength tungsten alloy construction
• Adjustable tap wrench
• Die handle
SAE
1/4"-20 to 1/2"-13 NC
8039954



Metric
M6 x 1.0 to M12 x 1.75
8039963
Wt. 1.2 lb **19⁹⁹** /set

Universal Thread Gauge Set
8006309 – Wt. 0.1 lb **5⁹⁹**

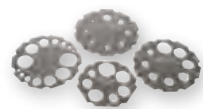

You think THIS catalogue has a lot of information?

You should check out princessauto.com for our newest products, additional product info and customer reviews.



Super Out Set

- 5 extractor sizes extract 1/4" to 1/2" and larger bolts and screws
• Super strong extractors made of special hardened, shock resistant tool steel
• Works on both left and right hand threads

2915171 - Wt. 0.2 lb 22.99



5 pc Spiral Flute Screw Extractor Set

- Designed to remove broken studs, bolts, socket screws and fittings
• For harder metals, choose a spiral screw extractor
• EX-1 through EX-5

8366312 - Wt. 0.3 lb 19.99



10 pc 1/2" dr Twist Socket Nut Extractors

- Loosens damaged nuts when a socket or wrench just won't work
• Sizes: (8 mm) 5/16" to (19 mm) 3/4"

8381931 - Wt. 1.7 lb 69.99



48 pc Thread Repair Coil Inserts

Stainless steel coil inserts SAE

- 4 pc 1/2"-13 x 1.5D
• 6 pc 7/16" - 14 x 1.5D
• 10 pc 3/8"-16 x 1.5D 12 pc 5/16"-18 x 1.5D
• 16 pc 1/4"-20 x 1.5D

8391690 - Wt. 0.3 lb 24.99

Metric

- 16 pc M5-0.8 x 1.5D
• 12 pc M6-1.0 x 1.5D
• 10 pc M8-1.25 x 1.5D 6 pc M10-1.5 x 1.5D
• 4 pc M12-1.75 x 1.5D

8391708 - Wt. 0.3 lb 24.99



45 pc Tungsten Tap & Die Sets

- Heat treated tungsten alloy steel construction
• Rust resistant satin finish
• 1 die holder with adapter to hold smaller dies
• Adjustable tap wrench and T-handle tap wrench

SAE 1 tap and die for 1/4"-20 NC to 1" - 14 NF 3410274 - Wt. 14.4 lb

Metric

1 tap and die for M6 x .75 to M24 x 3.0 8005712 - Wt. 14.7 lb 119.99/set



SAE External Thread Restorers

8261984 - 9 to 32 TPI 8261976 - 11 to 24 TPI Wt. 0.4 lb 11.99/set



5 pc Straight Screw Extractor Set

- For use on 3/16" to 5/8" fasteners
• Chrome vanadium steel construction with hardened tips for extended tool life

8309544 - Wt. 0.4 lb 18.99



39 pc Tungsten Alloy Tap & Die Sets

- 1" hex dies for easier threading
• High strength tungsten alloy construction
• Rockwell hardness of HRC 60
• Adjustable tap wrench, die handle, screwdriver, screwpitch gauge, and storage case

SAE #4-40 to 1/2"-20, 1/8" NPT-27 8039981

Metric

M3 x 0.5 to M12 x 1.75, 1/8" NPT-27 8039972 Wt. 3.3 lb 44.99/set



Tap Wrench

Will hold 3/16" to 1/2" taps 8300063 - Wt. 0.6 lb 5.99

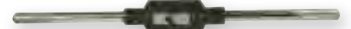

Screw Extractors

- Quick and easy way to remove broken screws, pipes, bolts and studs
• Heavy duty chrome moly construction
• No. 1 to No. 5 extractors

8366346 - Wt. 0.3 lb 12.99



10 pc 1/2" dr Twist Socket Nut Extractors

- Loosens damaged nuts when a socket or wrench just won't work
• Sizes: (8 mm) 5/16" to (19 mm) 3/4"

8381931 - Wt. 1.7 lb 69.99



15 pc Screw Extractor Set

- Easily removes damaged or broken screws
• 12 mm hex sizes: 3, 4, 5, 5.5, 6, 8, 10, 1/8", 3/16", 1/4", 3/8"
• 16 mm hex sizes: 11, 12, 14 mm, 1/2"

8381923 - Wt. 1.2 lb 39.99



130 pc Metric Thread Repair Coil Insert Kit

- Bring damaged threads back to the original thread size, and better than new using stainless steel inserts
• Kit includes 110 assorted stainless steel screw coils with matching HSS drill bits, HSS taps, tang punches and coil insert tools
• Stainless steel coils included: 25 pc each of M5-0.8x1.5D, M6-1.0x1.5D, M8-1.25x1.5D, M10-1.5x1.5D, and 10 pc of M12-1.75x1.5D

8341927 - Wt. 5.3 lb 129.99



Go Through Nut Extractor Set

- Loosens damaged nuts when a socket or wrench just won't work
• Sizes: (8 mm) 5/16" to (19 mm) 3/4"
• Not for use with impact wrench

8381915 - Wt. 1.1 lb 59.99



130 pc SAE Thread Repair Coil Insert Kit

- Bring damaged threads back to the original thread size, and better than new using stainless steel inserts
• Kit includes 110 assorted stainless steel screw coils with matching HSS drill bits, HSS taps, tang punches and coil insert tools
• Stainless steel coils included: 25 pc each of 1/4-20, 5/16-18, 3/8-16, 7/16-14, 1/2-13
• High speed steel drill bits: 6.7, 8.3, 9.9, 11.6, and 13 mm

8375198 - Wt. 5.3 lb 149.99





THE PERFECT FINISH

Arrow Fastener Company LLC is the leader in manual, electric and brad nail fastening tools for the professional building trades and do-it-yourself markets.

IRWIN HANSON



Performance Threading System Drive Tool Set

- No more set-screw needed, simply twist to insert and remove die
- Drive with die stock, 3/8" ratchet or t-handle
- Die adapter accommodates standard 1" hex dies

8324022 – Wt. 2.3 lb **89⁹⁹**

Self Aligning Sets

Self-Aligning taps start and thread straight every time

Tap Sets

Chip breaking technology cuts chips easier
SAE – No. 4 to 1/2" with NC & NF thread pitches
8324030

Metric – 3 mm to 12 mm with coarse and fine thread pitches
8324048 – Wt. 1.6 lb **89⁹⁹**/set

Die Sets

Additional strength - more steel at critical points
SAE – No. 4 to 1/2" with NC & NF thread pitches
8324055

Metric – 3 mm to 12 mm with coarse and fine thread pitches
8324063 – Wt. 2.4 lb **89⁹⁹**

Staplers & Fasteners

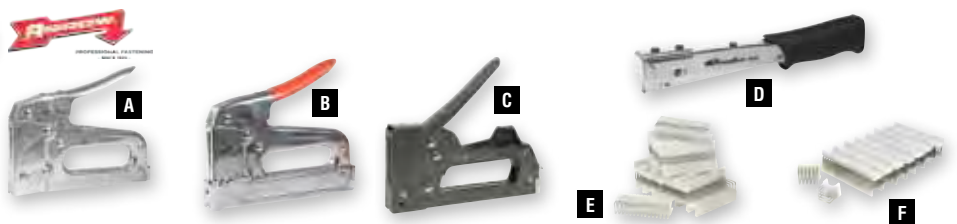

A) T59 Insulated Staple Wire Tacker

- For fastening TV cable, computer cable, computer CAT 5 cable, RG6 and RG59, alarm wire and low voltage wire up to 5/16" in diameter
- Uses UL listed insulated fasteners

8340200 – Wt. 2.1 lb **49⁹⁹**

B) T72 Insulated Fastener Wire Tacker

- For non-metallic sheathed cable 12/2, 14/2, and other wire up to ~1/2" (12 mm) wide
- Easy squeeze mechanism
- All steel construction with chrome finish

8340234 – Wt. 2.4 lb **59⁹⁹**

C) T-55C Multi-Purpose Staple Gun

- Uses all sizes of T-50 series staples

8294472 – Wt. 1.6 lb **22⁹⁹**

D) 5100 Handyman Hammer Tacker

- Lightweight design with rubber grip
- Uses Arrow T-50 style 1/4" to 5/16" or equivalent 3/8" staples

8294456 – Wt. 1.1 lb **28⁹⁹**

E) 300 pc T59 Insulated Fasteners

- Leg length: 5/16" (8 mm) x 5/16" (8 mm)
- Crown width: 5/16" (8 mm)

8340226 – Wt. 0.3 lb **7⁹⁹**

F) 300 pc T72 Insulated Staples

- Insulator height: 11/32" (8 mm)
- Insulator width: 19/32" (15 mm)

8340242 – Wt. 0.5 lb **9⁹⁹**



ARROW RHT300 Twister™ Rivet Tool

Unique riveter head twists 360°
2920392 – Wt. 1.6 lb **34⁹⁹**

1/8" ARROW® Aluminum Back-Up Plates

30 pc
3860018 – 1/8" dia.
3860019 – 3/16" dia.
Wt. 0.1 lb **1⁹⁹**/set

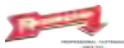

Arrow T50 Staples

- For use in all arrow T-50 type staple guns and many other brand staple guns
- Pack of 1,250 staples

Size	Wt. (lb)	ITEM	PRICE
1/4" (6 mm)	0.4	8232647	2.99
5/16" (8 mm)	0.4	8232670	3.79
3/8" (10 mm)	0.4	8232696	3.79
1/2" (12 mm)	0.6	8232712	3.79
9/16" (14 mm)	0.6	8232720	3.99

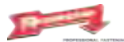

Aluminum Rivets

	Dia.	Thick	Qty	Wt. (lb)	ITEM	PRICE
Aluminum	1/8"	1/8"	25	0.1	3860015	1.49
	1/8"	1/4"	20	0.1	3860016	1.49
	1/8"	1/2"	15	0.1	3860017	1.49
	3/16"	1/8"	18	0.1	3860032	1.99
	3/16"	1/4"	15	0.1	3860030	1.99
	3/16"	1/2"	12	0.1	3860031	1.99



pro.point



A) Heavy Duty Hammer Tacker

- Shoots standard Arrow T50® staples (1/4" to 9/16")
 - Comfort grip handle
 - All steel construction
 - Jam proof mechanisms
 - Precision locked rear loading
 - Retractable striking edge
- 8354185** – Wt. 2.1 lb. **24⁹⁹**

B) 2-Way Staple Gun & Tacker

- Die-cast aluminum rugged construction
 - Patented drive technology
 - Comfortable ergonomic handle for easy lever action
 - Front grip for two handed operation
 - Shoots 6 sizes of T-50® staples (1/4" to 9/16")
 - Shoots 18 gauge 5/8" brad nails
- 8354193** – Wt. 1.6 lb. **24⁹⁹**

C) 4-Way Staple Gun & Tacker

- All steel construction
 - Adjustable power
 - Easy squeeze design
 - Contractor grade Staple head pivots for easy jam removal
 - Shoots T50® (1/4" - 9/16") staples, 10-14 mm nails, 12 mm U-staples and 14 mm pins
 - Ideal for roofing, screening, upholstery, light wiring and insulation
- 8354201** – Wt. 1.5 lb. **14⁹⁹**



Heavy Duty Staple Remover

- Easily removes heavy-duty staples
- Comfort shaped handle for repetitive use
- Large foot print minimizes risk of surface damage

8354219 – Wt. 0.3 lb. **4⁹⁹**



D) Hog Ring Pliers

- Designed specifically for gripping, moulding, and installing hog rings
- Cushion grip handle

8246670 – 45° Jaw Hog Ring Pliers
Wt. 0.6 lb. **9⁹⁹**

8246662 – Straight Hog Ring Pliers
Wt. 0.6 lb. **9⁹⁹**

E) 500 pc Hog Ring Clips
8173122 – Wt. 0.5 lb. **3⁹⁹**



Aluminum Rivets

	Dia.	Thick	Qty	Wt. (lb)	ITEM	PRICE
Alum.	1/8"	1/8"	100	0.1	3860021	5.49
	1/8"	1/4"	100	0.1	3860022	5.99
	1/8"	1/2"	100	0.1	3860023	7.99
Steel	1/8"	1/8"	100	0.3	3860029	5.49
	1/8"	1/4"	100	0.3	3860024	5.99
Alum.	1/8"	1/2"	100	0.4	3860025	7.99
	3/16"	1/8"	50	0.1	3860026	4.99
	3/16"	1/4"	50	0.2	3860027	5.49
	3/16"	1/2"	50	0.2	3860028	6.49



Aluminum Rivets

Wt. 0.3 lb

8161754 – 3/16" x 1/8" **3⁹⁹**

8056178 – 3/16" x 1/2" **3⁹⁹**

8056210 – 3/16" x 1/4" **3⁹⁹**

8056194 – 1/8" x 1/4" **3⁹⁹**

Steel Rivets **3⁹⁹**

8161739 – 1/8" x 1/4" **3⁹⁹**

500 pc Rivet Assortment **9⁹⁹**

8103616 – Wt. 1.3 lb. **9⁹⁹**



Rivets / Riveters



F) Hand Riveting Tool

4 nose pieces (3/32", 1/8", 5/32", and 3/16")
8285595 – Wt. 1.1 lb. **9⁹⁹**

G) 360° Swivel Head Riveting Tool

- Spring loaded handle for easy rivet loading and ejection
- Extended nose for hard-to-get places
- 4 nose pieces (3/32", 1/8", 5/32", and 3/16")

8285603 – Wt. 1.5 lb. **14⁹⁹**



I) 18" Long Handled Riveting Tool

- 4 nose pieces (1/8", 5/32", 3/16", and 1/4")
- Ideal for use with larger rivets
- Long handles provide added leverage

8048882 – Wt. 3.5 lb. **34⁹⁹**

H) 3-in-1 Riveting Tool

- Sets blind, nut, and hollow wall anchor rivets
- Nosepieces for 3/32", 1/8", 5/32", and 3/16" rivets

8150716 – Wt. 2.1 lb. **29⁹⁹**



pro.point

J) 21" Long-Handle Riveting Tool

- Complete with 5 nosepieces (1/8", 5/32", 3/16", 7/32" and 1/4")
- Easily sets large rivets including 1/4" all steel and split rivets
- Extra long handles for single stroke setting of rivets used on door handles, window regulators and other body shop applications

8309239 – Wt. 3.7 lb. **49⁹⁹**

Tool Holders



80 Socket Organizer Tray

Clips hold twenty 1/4", thirty 3/8", and thirty 1/2" sockets

8002252 – Wt. 2.0 lb **19⁹⁹**

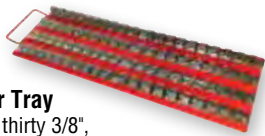

Nylon Composite Socket Rails

Includes adhesive size labels

	Drive	Description	Wt. (lb)	ITEM	PRICE
8" Long	1/4"	Holds up to eight 1/4" dr sockets	0.1	8341620	4.99
	3/8"	Holds up to eight 3/8" dr sockets	0.1	8341653	4.99
	1/2"	Holds up to eight 1/2" dr sockets	0.2	8341687	4.99
17" Long	1/4"	Holds up to fourteen 1/2" dr sockets	0.3	8341737	7.99
	3/8"	Holds up to seventeen 3/8" dr sockets	0.2	8341729	7.99
	1/2"	Holds up to twenty 1/4" dr sockets	0.2	8341711	7.99

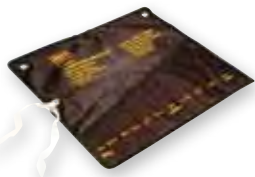

11 Pocket Tetron Tool Roll

13-1/2" x 15" tetron

8000959 – Wt. 0.1 lb **2⁹⁹**

22 Pocket Tetron Tool Roll

13-1/2" x 28" tetron

8000968 – Wt. 0.3 lb **3⁹⁹**



12 Pocket Tool Roll

Leather construction

8314320 – Wt. 1.0 lb **19⁹⁹**

pro.point

124 Socket Drawer Organizer

- Labeled tray for easy organization of 1/4" 3/8" and 1/2" SAE and Metric sockets
- Fits in to a standard 22" x 16" tool chest drawer

8309643 – Wt. 5.5 lb **44⁹⁹**

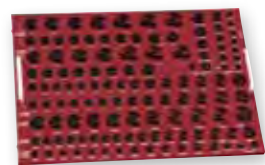

A



B



C

A) Metal 13 Wrench Holder

2919116 – Wt. 0.4 lb **3⁹⁹**

B) Plastic Magnetic 12 Wrench Holder

8035510 – Wt. 0.3 lb **7⁹⁹**

C) Metal 12 Wrench Holder

2926665 – Wt. 0.6 lb **6⁹⁹**



Low Profile Metric Wrench Holders

- Fits 2" deep tool drawers
- Tough ABS plastic

8016808 – SAE: 1/4" to 15/16" Wt. 0.3 lb

8016817 – Metric: 6 to 18 mm Wt. 0.2 lb **12⁹⁹ /ea**

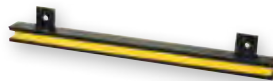

24" Magnetic Tool Holder

- Organizes, holds, and displays tools and other metal items
- Two 1/4" dia. mounting holes 16" apart

8150120 – Wt. 3.8 lb **16⁹⁹**



Hand Tool Organizer

- Polypropylene plastic construction
- 3 mounting holes located at centre and 16" from centre
- Mounts on wall, workbench or pegboard
- Includes 3 mounting screws

8248759 – Wt. 1.0 lb **4⁹⁹**



32 Pocket Socket / Tool Roll Pouch

- Unique socket holder with hook and loop closure
- Heavy-duty elastic strap keeps tools in place
- Adjustable quick-release buckle fastens pouch when not in use

8351199 – Wt. 1.0 lb **14⁹⁹**

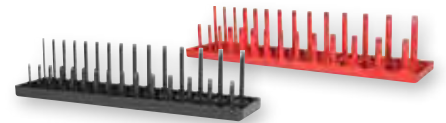

In store only, not available on-line

Socket Holders

1/4" dr

8272791 – SAE 13 shallow and 13 deep holders 1/8" to 5/8"

8272817 – Metric 14 shallow and 14 deep holders 4 to 15 mm Wt. 0.1 lb **9⁹⁹ /ea**

3/8" dr

8272825 – SAE: 12 shallow and 12 deep holders 1/4" to 1"

8272833 – Metric: 15 shallow and 15 deep holders 6 to 20 mm Wt. 0.3 lb **11⁹⁹ /ea**

1/2" dr

8272841 – SAE: 14 shallow and 14 deep holders 3/8" to 1-1/4"

8272858 – Metric: 17 shallow and 17 deep holders 10 to 27 mm Wt. 0.6 lb **13⁹⁹ /ea**



3 pc Socket Holder Set

- Holds 1/4", 3/8", and 1/2" drive sockets
- Each strip holds 16 sockets (48 total)
- Mounts on wall or in tool box
- 16-1/2" long with three 7/32" mounting holes

2919611 – Wt. 0.5 lb **5⁹⁹**

pro.point

Aluminum Socket Rails

Anodized Aluminum

1/4" dr

Holds twenty 1/4" dr sockets

8341778 – SAE: Red

8341760 – Metric: Blue Wt. 0.3 lb **14⁹⁹ /ea**

3/8" dr

Holds seventeen 3/8" dr sockets

8341794 – SAE: Red

8341786 – Metric: Blue Wt. 0.3 lb **14⁹⁹ /ea**

1/2" dr

Holds fourteen 1/2" dr sockets

8341810 – SAE: Red

8341802 – Metric: Blue Wt. 0.4 lb **14⁹⁹ /ea**

6 pc Aluminum Locking Socket Rails

- Colour coded anodized aluminum finish
- 2 pc 1/4" dr, 2 pc 3/8" dr, 2 pc 1/2" dr
- 10 socket clips per rail

8365652 – Wt. 3.3 lb **59⁹⁹**

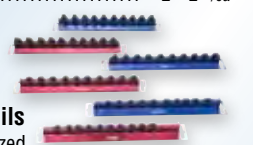



A) 12" Nylon Tool Bag
12" x 8" x 7" deep
8044341 – Wt. 1.5 lb **12⁹⁹**

B) 15" Nylon Tool Bag
8 padded side pockets and shoulder carry strap
8044350 – Wt. 3.0 lb **16⁹⁹**

C) 22 Pocket Heavy Duty Nylon Tool Bag
• Carrying handle and shoulder strap have metal clasps
• Rubber grips on bottom for stability
• With metal clip tape measure holder
• Rivet reinforced
8088619 – Wt. 2.4 lb **27⁹⁹**

D) 11-1/2" Nylon Tool Bag
• 14 small outside pockets
• 1 large closing outside pocket
• 16 small inside pockets
• Padded shoulder carrying strap
8128266 – Wt. 2.5 lb **44⁹⁹**

E) 18" Tool Bag with Moulded Bottom
• Water proof bottom
• 8 inner pockets
• 10 outer pockets
• 8 outer tool loops
8259624 – Wt. 2.6 lb **29⁹⁹**

F) 24" Tool Bag
• Waterproof moulded bottom
• Exterior large and small pockets
8286940 – Wt. 3.2 lb **39⁹⁹**



G) 26 Pocket Bucket Tool Organizer
Fits standard 5 gal. bucket
8074148 – Wt. 0.7 lb **9⁹⁹**

H) Canvas Tool Bucket
Sturdy bottom
8223919 – Wt. 1.8 lb **19⁹⁹**



I) Nylon Tool Belt Drill Holster
Use with belt 8287088
8290967 – Wt. 0.3 lb **3⁹⁹**

J) Carpenter's Nail and Tool Belt
• Heavy duty nylon material
• Drill holster with 3 small bit pockets
8287013 – Wt. 1.0 lb **14⁹⁹**

K) 17 Pocket Nylon Tool Pouch
Use with belt 8287088
8287062 – Wt. 2.5 lb **19⁹⁹**

Storage Boxes

Durable polypropylene construction with thermoplastic wrapped corners
2 pc Small Plastic Storage Boxes
• 7-3/4" long x 4-1/4" wide x 1-1/4" deep
• 12 compartments for convenient parts storage
8329641 – Wt. 0.6 lb **4⁹⁹**

2 pc Large Plastic Storage Boxes
• 9" x 6-1/2" x 2" approx. size
• Bottom layer with 3 small and 1 large compartment, top removable tray with 4 adjustable compartments
8329682 – Wt. 1.5 lb **8⁹⁹**

225 pc Tool Chest
• Assorted 1/4", 3/8" and 1/2" dr SAE/Metric sockets
• 1/4", 3/8" and 1/2" dr gold plated 48 tooth ratchets
• 6" spinner handle and assorted extensions
• Assorted screwdriver, hex and TORX® bits, drive adapters, combination wrenches and nut drivers
8003800 – Wt. 49.3 lb **259⁹⁹**

Tool Storage



L) Horizontal Cell Phone Holder
• Designed for cell phone, BlackBerry®-style mobile device, or larger iPod®, or iPhone®
• Includes ear-bud pocket and sleeve for business or credit cards
• Belt clip swivels to accommodate wearing on left or right side
8351017 – Wt. 0.2 lb **9⁹⁹**

M) Ziptop Utility Pouch
Heavy duty 600D polyester construction
7 Pocket
8351025 – Wt. 0.5 lb **14⁹⁹**

11 Pocket
8351033 – Wt. 0.8 lb **19⁹⁹**

N) Cordless Drill Holster
8351108 – Wt. 0.4 lb **14⁹⁹**



Plastic Tool Boxes

- Removable inner tray
- Sturdy, lightweight design

	Size	Wt. (lb)	ITEM	PRICE
O	12-1/2"	1.2	8000815	8.99
	16"	1.9	8000806	15.99
P	19"	3.4	8000799	19.99



Q) 2 pc Stainless Steel Roller Tool Box
• Pull up handle with detachable tool boxes
• Box dimensions: 24.9" x 15" x 25.1"
• Big tool box: 24.7" x 15" x 17"
• Small tool box: 23.1" x 11.1" x 8.9"
8170615 – Wt. 26.3 lb **99⁹⁹**

R) Stainless Steel Roller Tool Box
• 1st compartment: 21.3" x 11.2" x 8.7"
• 2nd compartment: 21.3" x 10.6" x 10"
• 3rd compartment: 21.3" x 14.6" x 14.6"
• Wheel size: 5.9"
• Extendable aluminum handle
8217689 – Wt. 34.3 lb **114⁹⁹**

Tool Belts & Accessories



A) 7 Pocket Leather Tool Belt

- 2 steel hammer loops
 - Adjustable nylon belt
- 8078024 – Wt. 1.6 lb **19⁹⁹**

B) 7 Pocket Pink Leather Tool Belt

- 2 steel hammer loops
 - Adjustable nylon belt
- 8236606 – Wt. 1.6 lb **19⁹⁹**

C) 11 Pocket Leather Tool Belt

- Adjustable web belt with quick release buckle
- 8314304 – Wt. 1.7 lb **24⁹⁹**

D) 13 Pocket Leather Tool Belt

- Heavy duty leather belt with roller buckle
- 8314312 – Wt. 3.2 lb **59⁹⁹**

E) Leather Tool Pouch

- 2 side pockets for pencils and screwdrivers
 - 2 steel hammer loops
 - Use with belt 8075723
- 8071995 – Wt. 1.1 lb **16⁹⁹**

F) 4 Pocket Leather Tool Pouch

- Use with belt 8075723
 - Metal hammer loop and tape measure clip
- 8286981 – Wt. 1.5 lb **19⁹⁹**

G) Leather Belt

- Fits waist sizes 33" to 44"
 - Belt width: 1-5/8"
- 8075723 – Wt. 0.4 lb **8⁹⁹**

H) Nylon Tool Belt

- Adjustable sizing
- 8287088 – Wt. 0.9 lb **9⁹⁹**

Tool Organization

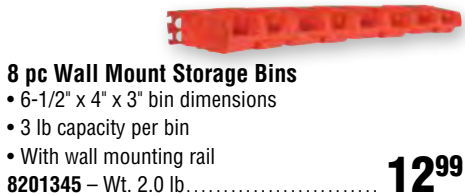

8 pc Wall Mount Storage Bins

- 6-1/2" x 4" x 3" bin dimensions
 - 3 lb capacity per bin
 - With wall mounting rail
- 8201345 – Wt. 2.0 lb **12⁹⁹**

4 pc Tool Hangers

- Perfect for hanging tools to free up space in the shop or garage
 - 6 pc wood screws included for installation
- 8319998 – Wt. 1.0 lb **2⁹⁹**

Double-Sided Parts Organizer

- 18 adjustable compartments on each side
 - O'all dim.: 16.6" x 11.9" x 3.8"
- 8196552 – Wt. 2.7 lb **9⁹⁹**

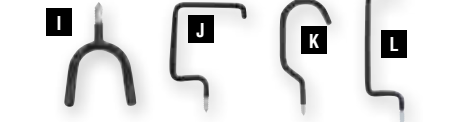

Tool Storage & Organization

- #### I) Heavy Duty Tool Hook
- 8321267 – Wt. 0.4 lb **2⁴⁹**

- #### J) Heavy Duty Tool Hook
- 8321291 – Wt. 0.6 lb **3⁴⁹**

- #### K) Heavy Duty Bicycle/Tool Hook
- 8321275 – Wt. 0.5 lb **2⁹⁹**

- #### L) Heavy Duty Ladder Hook
- Vinyl coated
8321283 – Wt. 0.5 lb **2⁹⁹**

- ### 30 pc Assorted Small Pegboard Hook Set
- 15 curved & 15 angled peg hooks
8287955 – Wt. 0.5 lb **4⁹⁹**

- ### 36 pc Assorted Pegboard Hook Set
- Fits 1/4" and 1/8" hole pegboard
8245037 – Wt. 1.2 lb **6⁴⁹**

- ### 50 pc Assorted Pegboard Hook Set
- Five 2" straight hooks, four 4" straight hooks, six 3/4" curved hooks, eleven 1" curved hooks, six 1-1/4" curved hooks, two 1-1/2" curved hooks, five 1" angled hooks, six 1-1/2" angled hooks
 - Two tool holders, 2" double hook, 4" double hook and 6-slot tool holder
- 8245045 – Wt. 1.5 lb **8⁹⁹**



Duraboard Pegboard Storage System

- 2 Duraboards, 54 pc mounting hardware kit, 4 bins, 24 assorted hooks
 - Simple to install, remove and reposition
 - Poly pegboard is washable
 - Hooks lock into place and can store items vertically or horizontally
- 8232506 – Wt. 8.1 lb **39⁹⁹**

2 pc 18" x 22" Duraboard Pegboard Sheets

- Polypropylene pegboard, 1/4" thick
 - Superior holding strength over traditional pegboard
 - Durable, weather resistant, washable and suitable for corrosive environments
 - Will not crack or break under normal use
 - Accommodates Duraboard locking pegboard hooks and standard pegboard hooks
- 8323594 – Wt. 3.8 lb **19⁹⁹**

4 pc Hanging Pegboard Bin Kit

- Can hang on both 1/8" and 1/4" peg board
 - 5" x 2-1/2" x 4" bin dimensions
- 8232530 – Wt. 1.5 lb **9⁹⁹**

15 pc Pegboard Mounting and Spacer Kit

- Bright zinc plated steel plates, plastic anchors and screws
 - Provides enough clearance from wall for pegboard hooks
- 8323586 – Wt. 0.6 lb **6⁹⁹**

26 pc Assorted Pegboard Hooks and Accessories

- 1-1/2" double closed end loop, spring clip/can holder, 2 extended spring clips, standard spring clip, double ring tool holder, three 1" single rods, 5-3/4" double rod, 6" single rod, 2 plastic bins, multi-prong tool holder / wrench holder, two 2-3/4" double U shape hooks
- 8323555 – Wt. 3.5 lb **19⁹⁹**

Pegboard Tool Storage

Fits 1/8" and 1/4" hole pegboard

Single Pegboard Hooks

8287906 – 4 pc 2" (Shown) **1 49**
Wt. 0.1 lb

8287914 – 3 pc 4" **1 79**
Wt. 0.1 lb

8287930 – 3 pc 4" **2 29**
Fits 1/4" hole pegboard
Wt. 0.3 lb

8287948 – 3pc 6" Hooks **2 49**
Fits 1/4" hole pegboard
Wt. 0.3 lb

Double Pegboard Hooks

8287922 – 2 pc 2" **1 49**
Wt. 0.1 lb



Power Tool Holder Pegboard Hook

• Fits 1/4" hole pegboard
• 15 lb weight limit
8287971 – Wt. 0.2 lb **1 99**

Screwdriver Holder Pegboard Hook

8287963 – Wt. 0.3 lb **2 49**

30 pc Storage Hook Set

• Convenient storage solution for the shop or garage
• Assorted styles and sizes of hammer or screw in hooks
8355471 – Wt. 2.7 lb **14 99**

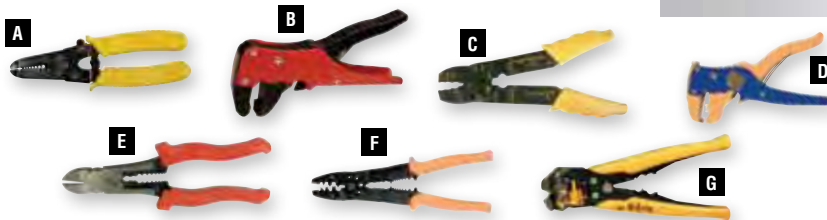

Wire Strippers & Crimpers

A) 7-In-1 Wire Stripper

• Wire stripper, wire cutter, steel wire cutter, pliers, wire loop, and crimping tool
• SAE and Metric markings
8025308 – Wt. 0.4 lb **2 99**

B) Self-Adjusting Wire Stripper

2990205 – Wt. 0.3 lb **2 99**

C) 4-Way Crimping Tool

Strips, cuts and crimps connections and terminals
8002932 – Wt. 0.5 lb **2 99**

D) Self Adjusting Wire Cutter/Stripper

• Suitable for flat wire, multi core wire, cat-5/6, coaxial cable and much more
• Cuts/strips wires from 1.5 mm to 6 mm
8259848 – Wt. 0.5 lb **6 99**

Voltage/ Continuity Tester

• ABS housing with slotted screwdriver tip, bright LED indicator and pocket clip
• Checks voltage from 12V to 300V
• Includes batteries
8243560 – Wt. 0.1 lb **5 99**

AC Voltage Tester

• Testing range: 12V to 600V AC
• Locates breaks along live, insulated wires and power cords
• Lighted tip and audible
• Includes batteries
8159964 – Wt. 0.1 lb **14 99**

AC Voltage Checker

• Tests 50 to 1,000V AC
• Helps to locate broken wires
• Not for shielded wire
8124422 – Wt. 0.1 lb **7 99**

E) Wiring Pliers

• 5 functions: wire cutter, wire stripper, multi crimper, small nut wrench and opener
• 1,000V insulated grip
2920146 – Wt. 0.8 lb **14 99**

F) Wire Stripper & Crimper

Crimps open barrel, non-insulated and insulated terminals
8002261 – Wt. 0.4 lb **17 99**

G) Automatic Adjustable Heavy Duty Wire Stripper, Cutter & Crimper

• Automatically adjusts to strip solid or stranded 24-10GA copper or aluminum wire
• Crimps 22 to 10GA insulated terminals, 22-4GA non-insulated terminals and 7 to 8 mm ignition terminals
2990264 – Wt. 0.8 lb **24 99**



Quick Change Ratcheting Wire Terminal Crimper

• Jaw quickly rotates to handle multiple sizes of terminals
• Crimps both insulated (22-18, 16-14, 12-10) and non-insulated terminals (22-18, 16-14, 12-10, 8)
• Colour-coded wire sizes on jaw
• Comfort cushion grip
8355315 – Wt. 1.3 lb **34 99**

Wire Strippers & Cutters

8 to 16 ga
8375750 – Wt. 0.6 lb **14 99**

20 to 32 ga
8375768 – Wt. 0.6 lb **14 99**

Electrical



Wire Rope & Spring Cutter

• Will cut up to 3/16" dia. wire rope and 1/16" dia. spring wire
• Spring loaded handles with vinyl grip and safety lock
• Cuts clean, eliminates frayed ends
• Non-slip PVC grip
8380677 – Wt. 0.6 lb **8 99**

Combination Ratcheting Screwdriver & Wire Stripper

• Strips wire sizes 0.6, 0.8, 1.0, 1.3, 1.6, 2.0 and 2.6
• 6 pc chrome vanadium 1" screw bits : slotted 3/16", 1/4", 9/32", Phillips #1, #2, #3
8348500 – Wt. 0.4 lb **9 99**

Multipurpose Wire Tracer

Can be used to trace wiring, telephone wiring, co-axial wiring, automobile wiring and other non-energized wiring
8347684 – Wt. 0.6 lb **29 99**

72" Multimeter Test Leads

• For use with all Powerfist and pro.point multimeters
• Extra long for added reach
• Double the length of standard test leads
8347668 – Wt. 0.1 lb **5 99**

Fish Tape

For threading electrical wire, telephone wire, cable, etc., in limited access areas
50 ft Fish Tape with Illuminated End
LED light makes it easier for user to locate end of tape
8067944 – Wt. 2.0 lb **17 99**
100 ft Fish Tape
8206682 – Wt. 3.4 lb **19 99**



Analog Multimeters

All models include batteries

	H) 8344681	I) 8344699	J) 8347676	K) 8344665	L) 8344707	M) 8344715	N) 8344749
DC V	10V/50V/250V/500V	2.5/10/25/100/ 250/500/1000V	200m/2000m/ 20/200/600V	400m/4/40/ 400/600V	600V	200m/2/20/ 200/600V	200m/2/20/ 200/600V
AC V	50V/250V/500V	0/25/100/250/ 500/750V	200/600V	4/40/400/600V	600V	2/20/200/600V	2/20/200/600V
DC A	25m/250mA	1mA/2.5mA/10mA/ 25mA/100mA/250mA/ 1000mA/5A/10A	2000µ/20m/ 200m/10A	400µ/4000µ/ 40m/400m/10A	n/a	200µ/2000µ/20m/ 200m/2/10A (200/1000A with clamp)	20m/200mA
AC A	n/a	2.5mA/10mA/25mA/ 100mA/250mA/ 1000mA/5A/10A	n/a	400µ/4000µ/ 40m/400m/10A	20/200/400A	200µ/2000µ/20m/ 200m/2/10A (200/1000A with clamp)	20m/200mA
Resistance	0/5Ω/500kΩ	Ω x 1 (20Ω)/Ω x 10 (20Ω)/ Ω x 100 (2kΩ)/Ω x 1k (20kΩ)	200/2000/20k/ 200k/2000kΩ	400/4k/40k/ 400k/4M/40MΩ	2k/200kΩ	200/2k/20k/ 200k/2M/20MΩ	200/2k/20k/ 200k/2M/20MΩ
Cont'	n/a	n/a	<30Ω	<50Ω	<30Ω	<30Ω	n/a
Wt. (lb)	0.2	0.7	0.2	1.2	0.3	1.1	0.4
PRICE	9.99	29.99	19.99	79.99	19.99	79.99	34.99

pro.point

5 pc Insulated Electrician's Tools

O) Open End Wrench Sets

- 1000V insulated
- Storage pouch
- Chrome vanadium steel

SAE: 1/4", 5/16", 3/8", 1/2", 9/16"
8356313

Metric: 7, 8, 10, 12, 14 mm
8356271 – Wt. 1.1 lb

P) Box End Wrench Sets

SAE: 1/4", 5/16", 3/8", 1/2", 9/16"
8356305 – Wt. 2.4 lb

Metric: 7, 8, 10, 12, 14 mm
8356289 – Wt. 1.8 lb

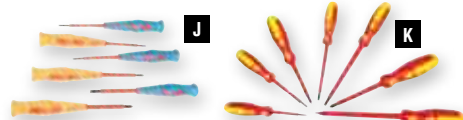

Q) 6 pc Insulated Precision Screwdriver Set

- Soft, non-slip handles with rotating caps
- Slotted 2.0, 2.5, 3.0 and Phillips #00, #0, #1

8311532 – Wt. 0.6 lb 16⁹⁹

R) 7 pc Insulated Screwdriver Set

- Magnetic drive tips
- Insulated blades for applications up to 1000V AC and 1500V DC
- 4 slotted and 3 Phillips
- Thermoplastic handles

8341208 – Wt. 1.8 lb 19⁹⁹

8 pc 3/8" dr Insulated T-Handle and Screwdriver Sets

- 1000V insulated tools
- 2 pc screwdrivers (#2 Phillips, 1.0 mm slotted)
- Storage pouch

SAE

8356081 – 5 pc sockets (1/4", 5/16", 3/8", 1/2", 9/16")

Metric

8356073 – 5 pc sockets (7, 8, 10, 12, 14 mm)
Wt. 2.6 lb 49⁹⁹/set

Electrician's Tools

- 1000V insulated
- 3/8" dr reversible ratchet
- 4" extension
- Storage pouch
- Chrome vanadium steel

SAE

8356321 – 5 pc sockets (1/4", 5/16", 3/8", 1/2", 9/16")

Metric

8356297 – 5 pc sockets (7, 8, 10, 12, 14 mm)
Wt. 2.2 lb 59⁹⁹/set

7 pc Quick Change Ratcheting Wire Terminal Crimper Kit

- 6 interchangeable heads to handle multiple sizes and styles of terminals
- Will crimp insulated terminals, non-insulated terminals, open barrel terminals (small and large), cord end terminals (small and large)
- Comfort cushion grip

8355331 – Wt. 2.7 lb 79⁹⁹

NEW pro.point

10 pc Electrician's Tool Set

- 12-600V AC/DC voltage tester with LED display
- Stainless steel blade cable knife
- 6 pc Screwdrivers (3 Phillips - #0 x 75 mm, #1 x 100 mm, #2 x 100 mm and 3 slotted - 1/8" x 85 mm, 3/16" x 100 mm, 7/32" x 125 mm)
- 6" diagonal plier and 7" linemen's plier

8343832 – Wt. 3.3 lb 59⁹⁹

CHANNEL LOCK

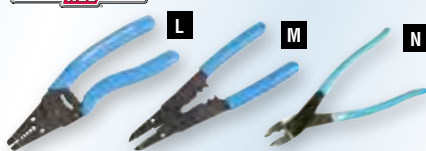

S) CHANNELLOCK® Ergonomic Wire Stripper/Crimper/Cutter

8240772 – Wt. 0.3 lb 24⁹⁹

T) CHANNELLOCK® Wire Stripper / Crimper/Cutter

8240780 – Wt. 0.4 lb 24⁹⁹

U) 9-1/2" CHANNELLOCK® Crimping / Cutting Tool

Crimps and cut both insulated and non-insulated solderless connections and terminals
2922748 – Wt. 0.9 lb 28⁹⁹



A) 9" Caulking Gun
 • Pistol grip with thermoplastic cushion
 • With tip needle and cutter
8182180 – Wt. 1.1 lb **4⁹⁹**

B) Pistol Grip Caulking Gun
 Metal body and handle
2940095 – Wt. 1.3 lb **6⁹⁹**

pro.point

Aluminum Hawk Pipe Wrenches

- Self adjusting powerful triple point grip for increased torque
- Single handed ratcheting operation
- Thumb trigger release
- Lightweight aluminum handle



Length	Jaw Capacity	Wt. (lb)	ITEM	PRICE
10"	1/4" to 1"	0.8	8343436	24.99
12"	1/2" to 1-1/4"	1.4	8343444	34.99
14"	1/2" to 1-1/2"	2.2	8343469	39.99
18"	1" to 2"	4.1	8343477	59.99



Inside / Outside Deburring Tool
 1/2" to 2-1/2" capacity
8347452 – Wt. 1.0 lb **24⁹⁹**



10" Soft Jaw Tongue & Groove Pliers
 • Ideal for use on brass and chrome plated fittings
 • Prevents scratching, scraping and marring
 • 1-1/2" jaw capacity
 • Spring loaded jaws
8354144 – Wt. 0.9 lb **14⁹⁹**



3-Way Water Line Crimper
 Interchangeable heads accommodate 3/8", 1/2" and 3/4" tube crimps
8344228 – Wt. 6.0 lb **149⁹⁹**



Combustible Gas Detector
 Detect leaks in automobile exhaust and fuel systems and liquid or gas heating systems
8385932 – Wt. 2.2 lb **199⁹⁹**



Plumbing Tools

Pipe Wrenches Cast Iron



Length	Max. Opening	Wt. (lb)	ITEM	PRICE
6"	3/4"	0.5	8211153	5.99
8"	1-1/4"	0.9	8154023	6.99
10"	1-3/4"	1.5	2926426	9.99
12"	2"	2.2	2922011	11.99
14"	2-3/4"	3.1	2924579	14.99
18"	3"	4.8	2924603	22.99
24"	3-1/4"	7.2	2921914	29.99
36"	4-1/2"	14.2	2921922	49.99

Aluminum

Length	Max. Opening	Wt. (lb)	ITEM	PRICE
14"	3"	2.4	8053768	24.99
18"	3-1/2"	3.8	8050896	36.99
24"	4"	6.0	8053786	49.99
36"	4-1/2"	10.6	8053795	99.99

18" Heavy Duty Offset Pipe Wrench

Off set wrench for unique pipe fitting situations
8003748 – Wt. 5.8 lb **29⁹⁹**



Telescopic Basin Wrench

• Remove and tighten faucet nuts easily
 • Telescopes from 11" to 18" for easy storage and versatility
8275729 – Wt. 1.7 lb **11⁹⁹**



PEX Water Line Crimper
 Crimps 1/2" and 3/4" water lines
8344236 – Wt. 4.2 lb **99⁹⁹**



Heavy Duty Toilet Plunger
8358962 – Wt. 0.8 lb **6⁹⁹**



C) 4 pc Ratcheting Pipe Threader
 Die sizes: 1/2", 3/4" & 1" NPT
8246514 – Wt. 9.2 lb **39⁹⁹**

D) Ratcheting Pipe Threader
 • Ratchet handle with 5 dies
 • Thread sizes: 3/8", 1/2", 3/4", 1", and 1-1/4" NPT
 • Ratchet handle in 2 parts for maximum leverage and easy storage
2910162 – Wt. 17.2 lb **149⁹⁹**

E) Portable Electric Pipe Threader Kit
 • Threads pipe from 1/2" to 2"
 • 120V, 15A
 • No-load speed: 28 RPM 6 cast iron dies: 1/2", 3/4", 1", 1-1/4", 1-1/2", 2"
8223497 – Wt. 43.1 lb **399⁹⁹**

6 pc Tubing Tool Kit
 • Cuts 1/8" to 1-1/8" tubing
 • Built-in deburring tool
 • Benders for 3/16", 1/4", and 3/8" tubing
 • 45° flaring tool fits 3/16" - 5/8" tubing
2920890 – Wt. 3.3 lb **39⁹⁹**



25 ft Plumber's Snake
 • Removes clogs in plumbing that a plunger is unable to
 • Plastic housing
8126187 – Wt. 2.4 lb **13⁹⁹**



Tub Drain Remover
 • Die cast aluminum
8160046 – Wt. 0.6 lb **9⁹⁹**



3 pc Internal Pipe Wrench
 • For 3/8", 1/2" and 3/4" pipe
 • Zinc plated finish resists rusting
8243438 – Wt. 1.0 lb **10⁹⁹**

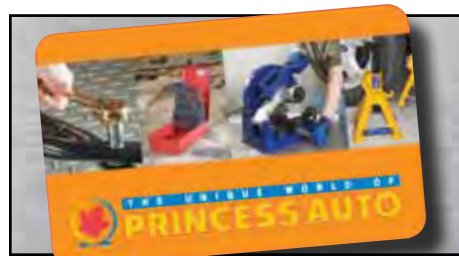

Looking for the perfect gift?
GIFT CARDS
 are available at any Princess Auto location

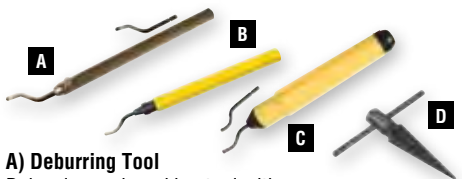

- A) Deburring Tool**
Deburring and marking tool with replacement blade
2970911 – Wt. 0.2 lb **5⁹⁹**
- B) Swivel Deburring Tool**
Aluminum handle with quick change blade
8267932 – Wt. 0.1 lb **7⁹⁹**
- C) Deburring Tool with Replacement Blade**
• Plastic handle and high speed steel blade
• 2 blades
8267940 – Wt. 0.1 lb **7⁹⁹**
- 10 pk Deburring Tool Replacement Blades**
8267957 – Wt. 0.1 lb **19⁹⁹**
- D) Tapered Reamer**
• Heavy duty chrome-moly construction
• Capacity: 5/32" to 7/8"
2910254 – Wt. 0.4 lb **21⁹⁹**



- Pipe Cutters**
- E) PVC Pipe Cutter**
For cutting PVC pipe and water hose up to 1-1/4" dia. Aluminum housing and handle with ratchet action cutting force
8020063 – Wt. 0.8 lb **9⁹⁹**
- F) Heavy Duty PVC Pipe Cutter**
• 1-3/8" dia. (max.)
• Aluminum body
8175283 – Wt. 1.0 lb **22⁹⁹**
- G) Professional Pipe Cutter**
• K5 blade in a lightweight aluminum body
• 2-1/2" maximum cutting diameter
8311508 – Wt. 1.7 lb **39⁹⁹**



pro.point

- Professional Smart Spring Tubing Cutter**
• For 1/8" to 1-1/8" tubing
• Titanium finished HSS SKH9 blade
• Smart Spring absorbing pressure mechanism enables longer blade life, stabilizes the blade position and adjusts automatically to enable cutting of tubes that aren't perfectly round
8343675 – Wt. 0.6 lb. **29⁹⁹**
- Replacement Tubing Cutter Wheel**
8343709 – Wt. 0.1 lb. **6⁹⁹**



No sale is final until you're satisfied!
We guarantee to make it right. We will repair, replace or refund any product to your satisfaction.



- Tile Tools**
- H) Tile Pliers/Hand Cutter**
• Use to score and cut tile up to 1/2"
• Tungsten carbide cutting wheel
8158461 – Wt. 0.6 lb **4⁹⁹**
- I) Professional Tile Compound Nippers**
Twice the power of conventional nippers
8158446 – Wt. 1.0 lb **19⁹⁹**



- Manual Tile Cutters**
• Cutting capacity : 14" rip, 9" diagonal, 1/2" thick
• Tungsten carbide cutting wheel
• Plastic fence and cutting guide
8363053 – Wt. 5.4 lb. **24⁹⁹**
- Plastic fence and cutting guide**
8367849 – Wt. 8.1 lb. **34⁹⁹**



Tile Tools

- Silicone Scraper and Trowel**
• Use 2 handles and 5 interchangeable tips to create superior caulking beads
• Smooth, clean and trim beads
8275760 – Wt. 0.2 lb **9⁹⁹**



- 7" Blade Floor Scraper**
• Heavy duty construction
• 44" handle
8158677 – Wt. 6.6 lb **27⁹⁹**
- Replacement Blade**
8194086 – Wt. 0.2 lb **3⁹⁹**



- 20" Tile Cutter Replacement Cutting Wheel**
8368656 – Wt. 0.5 lb. **3⁹⁹**
- 14" Tile Cutter Replacement Cutting Wheel**
Replacement 1/2" cutting wheel for 14" tile cutter 8363053
8192023 – Wt. 0.1 lb **3⁹⁹**



- Slide Hammer Action Floor Scraper**
Pull back the handle and push back for hammer action, no actual hammer needed
8380297 – Wt. 2.6 lb. **24⁹⁹**



- Grout Spreader**
8161168 – Wt. 0.2 lb **4⁹⁹**



Square Notch Trowels

- 4" x 9"
- Cold rolled steel blade with high impact plastic handle 1/4" x 1/4" x 1/4"
- J) Square Notch Trowel**
8158537 – 1/4" x 1/4" x 1/4"
8158545 – 1/4" x 3/8" x 1/4"
Wt. 0.5 lb. **2⁹⁹** /ea
- K) 3/16" x 5/32" V-Notch Trowel**
For spreading ceramic tile adhesive
8158560 – Wt. 0.5 lb. **1⁹⁹**
- L) 4 pc Wooden Handled Trowel Set**
11" x 4-1/2" finishing trowel,
14" x 4" finishing trowel, 6" groover and
6" edging trowel
8196529 – Wt. 2.9 lb **14⁹⁹**

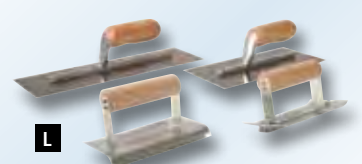
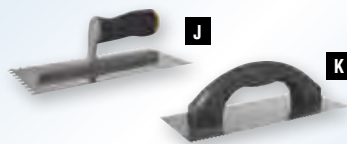

- Durable thermoplastic rubber handle for a comfortable grip
- M) Pointing Trowel**
5-1/2" blade
8158628 – Wt. 0.4 lb. **2⁹⁹**
- N) Margin Trowel**
5" x 2" blade
8158610 – Wt. 0.4 lb. **2⁹⁹**

Heavy Duty Tile Grout Saw
Long lasting diamond cutting blades
8158487 – Wt. 0.4 lb **4⁹⁹**



Grout Bag
• Silicone lined
• Reinforced tip
8158693 – Wt. 0.2 lb **3⁹⁹**



6" Coping Saw with Blades
• 6" deep frame
• 6-1/2" throat depth
• Two 16 TPI, one 20 TPI, one 24 TPI,
and one 28 TPI blade
8264277 – Wt. 0.6 lb **6⁹⁹**



Backerboard Scoring Knife
• Reversible blade creates additional cutting tip
• Durable carbide tips for long life
8158495 – Wt. 0.3 lb **5⁹⁹**



Laminate Floor Installation Tool Kit
• Includes steel puller bar, tapping block
and 50 plastic spacers
8341471 – Wt. 1.6 lb **16⁹⁹**



Deluxe Grout Mixer
• Eggbeater style
• 44" handle
8161150 – Wt. 1.5 lb **6⁹⁹**



Drywall Tools



MADE IN THE U.S.A.

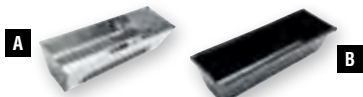

A) 12" Stainless Steel Mud Pan with "No Slip" Grip
• Smooth contoured bottom fits naturally in the hand
• Heliarc weld prevents leaking
• Top edge sheared to clean knife
8312225 – Wt. 1.2 lb **16⁹⁹**

B) 12" Plastic Bladed Mud Pan
• Two steel blades on edge of pan to clean your blade
• Comfortable 2-3/4" bottom with textured sides to prevent slippage
8312233 – Wt. 0.7 lb **4⁹⁹**

Drywall Lifter
• Lifts and holds drywall sheet in place while nailing or using screw gun
• Welded steel construction with durable powder coat finish
• Fits in pocket or tool belt
8312191 – Wt. 0.9 lb **12⁹⁹**



Thermoplastic Cool Grip Hand Sander
• 9" x 3-1/4"
• Comfortable, soft handle surface reduces stress on hand and arms
• Grooved handle surface reduces hand moisture and improves your grip
• Padded sanding surface distributes hand pressure, making sanding more uniform
8312159 – Wt. 0.5 lb **11⁹⁹**



Blue Steel Cool Grip II Taping Knives
• Straight flexible blue spring steel blade held in aluminum rib
• Soft overlay molded to polypropylene handle is riveted directly to the blade
• Handle surface reduces hand moisture to improve your grip with soft grip fins on the side for better feel and comfort
• Newly designed smaller handle for better ergonomics and less hand fatigue

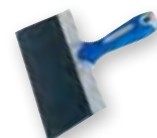

Size	Wt (lb)	ITEM	PRICE
8"	0.4	8312167	7.99
10"	0.5	8312175	8.99
12"	0.5	8312183	9.99

Panel Carrier
• Safe and easy way to handle drywall sheets & wood panels
• 176 lb load capacity
8303521 – Wt. 0.9 lb **6⁹⁹**



Cool Grip II Inside 90° Corner Trowel
• Stainless steel
• Handle surface reduces hand moisture to improve your grip
8312209 – Wt. 0.5 lb **11⁹⁹**

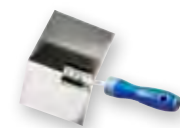

Painting Tools



Painting Tools
C) 4" Mini Paint Roller Cage Frame
8363707 – Wt. 0.3 lb **2⁴⁹**

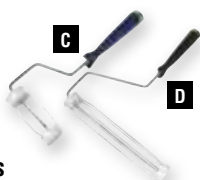

D) 9-1/2" Paint Roller Cage Frame
• 5-wire for better roller refill grip
• Polypropylene threaded handle with metal ferrule
8363699 – Wt. 0.5 lb **3⁹⁹**



Enviro-Roller® Paint Rollers
• Shed resistant fabric cover made from 100% recycled fibres
• Core made from 100% recycled plastic
E) 2 pc Mini 4"
8363640 – Wt. 0.1 lb **2⁹⁹**

F) 3 pc 9-1/2"
8363616 – Wt. 0.5 lb **8⁹⁹**

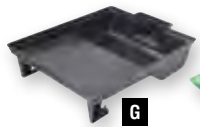

G) 9-1/2" Plastic Paint Roller Tray
• Solvent resistant polypropylene tray
• Features brush holder and ladder lock legs
8363673 – Wt. 0.6 lb **3⁴⁹**

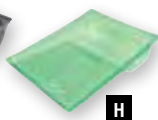

H) 9-1/2" Disposable Paint Roller Tray Liner
Fits snugly inside paint roller tray 8363673
8363681 – Wt. 0.1 lb **99¢**



Enviro-Tray™
• Durable 100% recycled plastic
• No liner required
• Solvent resistant
I) 4" Mini Paint Roller Tray
8363657 – Wt. 0.2 lb **1¹⁹**

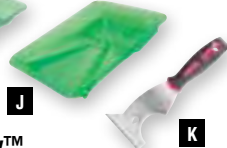

J) 9-1/2" Paint Roller Tray
8363632 – Wt. 0.3 lb **2²⁹**

K) Combination Painter's Tool
• One tool to pry, clean rollers, scrape corners, surfaces, angles and more
• Screw bits in handle for quick and easy removal of switch & outlet plates
8362980 – Wt. 0.3 lb **4⁹⁹**



L) 3 pc Foam Paint Brushes
1", 2" and 3"
8363665 – Wt. 0.1 lb **1⁴⁹**

M) 4" Stain Brush
• For use in all paints and stains
• 100% bristle
8363715 – Wt. 0.3 lb **4⁹⁹**



intertape polymer group™



- Duct Tape
- Masking Tape
- Bloc It Tape
- Sheathing Tape
- Carton Sealing Tape
- Aluminum Foil Tape
- Stretch Film



Painter's Masking Tape

A) Bloc-It™ Premium
0.94" x 60 yds
8367229 – Wt. 0.3 lb..... **6⁹⁹**

1.41" x 60 yds
8367237 – Wt. 0.5 lb..... **9⁹⁹**

B) ProMask®
0.94" x 60 yd
8367245 – Wt. 0.3 lb..... **2⁹⁹**



C) JobSite® White Duct Tape
• 1.88" x 20 yds
• General 9 mm grade
8367252 – White
8367278 – Black
Wt. 0.5 lb..... **6⁹⁹**_{/ea}

D) Duct Tape
1.88" x 60 yd
8367286 – Wt. 1.1 lb..... **6⁹⁹**

E) Armour Tough Duct Tape
Super tough, aggressive 17 mm
8354326 – Wt. 1.7 lb..... **9⁹⁹**



F) Carton Sealing Tape
1.88" x 54.6 yds
8367302 – Wt. 0.2 lb..... **2⁹⁹**

G) Aluminum Foil Tape
2" x 10 yds
8367310 – Wt. 0.3 lb..... **3⁹⁹**

H) CCMC Approved Red Contractor's Sheathing Tape
• 60 mm x 66 m
• For sealing of joints and seams of insulation materials
8352031 – Wt. 0.8 lb..... **9⁹⁹**



I) 2" x 150 ft Mesh Drywall Tape
• Self-adhesive
• Allows you to apply fill coat right away
8329005 – Wt. 0.4 lb..... **3⁹⁹**

J) Tape Dispenser Gun
Includes 45 mm x 30 m roll of packing tape
8182750 – Wt. 1.2 lb..... **8⁹⁹**

5" x 1000 ft Stretch Film
• Great for wrapping items in groupings
• Sticks only to itself
8354300 – Wt. 1.9 lb..... **12⁹⁹**



COMING SOON!

www.princessauto.com

Look for the official launch

Diagnostic Tools

MaxiVideo™ MV201 Digital Inspection Videoscope

- Record and playback still images and video clips
- 3-1/2" high resolution full colour LCD display (320X240)
- 8.5 mm imager head with adjustable LED light to view objects as close as 1"
- Wide camera angle to capture high resolution 640 x 480 jpeg images
- On screen horizontal / vertical reverse
- 2X digital zoom for increased viewing
- Mini USB connector for uploading images and video to computer
- 1 metre (39.4") semi-rigid, but flexible watertight shaft
- Built-in rechargeable Li-ion battery with up to 5-6 hours of continuous use
- Ergonomic and durable tool housing
- Contents: MaxiVideo™ MV201 tool, user's manual, storage case, imager head and cable, mirror, hook and magnet accessories, USB cable, video-out cable, charger



8333585 – Wt. 5.1 lb **349⁹⁹**

LCD Optic Tool Boroscope

- 3-1/2" screen
- 36" long x 3/8" dia.
- Mirror pivots 90°
- Can be used for: engines, farm equipment, electronic equipment, electrical, plumbing, automotive/mechanical, hydro, phone, HVAC contractors, and manufacturing
- Waterproof probe for plumbing and marine applications



8288979 – Wt. 3.4 lb **349⁹⁹**

MaxiVideo™ MV101 Digital Inspection Videoscope

- Allows you to examine difficult-to-reach areas normally hidden from sight
- 2.4" full colour LCD display screen
- Auto focus Viewing capacity as close as 1" with crystal clear output
- 16 mm camera head with adjustable LED light for illumination control
- View images in real time
- Wide camera angle to capture high resolution 640X480 jpeg images
- On screen horizontal / vertical reverse
- Oil and scratch resistant tempered glass lens
- 1 metre (39.4") semi-rigid, but flexible watertight shaft
- Ergonomic, durable tool housing
- Contents: MaxiVideo™ MV101 tool, user's manual, imager head and cable, hook, mirror and magnet accessories, video-out cable, 4xAA batteries



8333569 – Wt. 3.8 lb **149⁹⁹**

Automotive Computer Memory Saver

- Saves the memory of the on-board computer when the battery is disconnected
- Protects vehicle fault codes, drivability codes, keyless entry codes and digital radio settings
- Input reverse polarity protection prevents accidental damage to the unit
- Supply power to the electrical components in your car
- Charge the low/dead battery from a charged battery in another vehicle
- Easy to read LED lights indicate battery output voltage (green indicates output over 10V, red indicates output below 10V)



8360380 – Wt. 0.9 lb **29⁹⁹**

Code Readers

	MS300 (8312621)	MS309 (8217853)	MS409 (8218133)	MD801 (8329278)
Global OBDII	•	•	•	•
CAN Capable	•	•	•	•
OBDII Generic & Pending DTC's	•	•	•	•
Manufacturer Specific DTC's	•	•	•	•
On-Screen DTC Definitions	•	•	•	•
Determine MIL Status (Check Engine Light)	•	•	•	•
I/M Readiness Status	•	•	•	•
Freeze Frame Data	•	•	•	•
Clears codes and turns off MIL (Check Engine Light)	•	•	•	•
Retrieves Vehicle Information (VIN,CIN/CID and CVN)	•	•	•	•
Battery / Memory Backup	•	•	•	•
Multilingual Support (English, French, Spanish, German and Dutch)		•	•	•
Built-in DTC Lookup			•	•
Internet Updatable (via included USB cable)			•	•
Reads live PCM Datastream (Engine, A/T, ABS/Airbag)				•
Displays Live O2 Sensor Test Data				•
Data Graphing				•
Review Data				•
Global Non-Engine Coverage				A/T, ABS/ Airbag
Wt. (lb)	0.7	0.6	2.1	2.6
PRICE	79.99	99.99	149.99	399.99

OBD

As it relates to the Automotive industry, OBD is a generic term meaning On-Board Diagnostics. Most cars sold in the US and Canada from 1996 use an OBDII system. A notable exception is VW and Audi. European cars, 2001 and newer, use a system called EOBD (European On-Board Diagnostics) which is essentially the European equivalent. Regardless of which system is used, each monitors and stores information from various sensors throughout the vehicle. Examples would be a Mass Airflow sensor, Oxygen sensor, EGR position sensor, as well as others. Sensor values outside an acceptable range trigger a Diagnostic Trouble Code (DTC). Code readers as those above read and interpret the codes, and some, such as 8193203, have the ability to also read live sensor output.

Code Readers

- Works with all 1996 and newer vehicles that are OBDII compliant (including CAN) with all 1996 and newer OBDII compliant US, European and Asian vehicles
- Easy to read backlit LCD display
- Easy to use, specifically designed for the do-it-yourselfer
- All models include User Manual and CD with code definitions (MS309 does not include CD)



OBD - On-Board Diagnostics
 CAN - Controller Area Network
 MIL - Malfunction Indicator Lamp (Check Engine Light)
 I/M - Inspection/Maintenance
 PCM - Powertrain Control Module
 DTC - Diagnostic Trouble Code
 VIN - Vehicle Identification Number
 CIN - Calibration Identification Number
 (Also referred to as CID - Calibration ID)
 CVN - Calibration Verification Number
 O2 - Oxygen

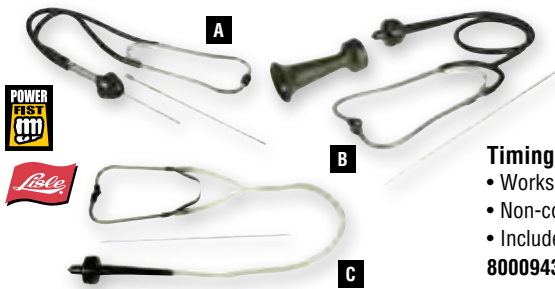

A) Mechanic's Stethoscope
Helps pinpoint the source of noises
2927770 – Wt. 0.4 lb **9⁹⁹**

B) Mechanic's Stethoscope
• Provides a fast and easy way to locate noises in engines, bearings or other moving parts
• Aluminum alloy probe/needle for finding exact location of specific noises
• Rubber trumpet for checking vacuum and pressure flow
• Useful for synchronizing multi-carburators
8006622 – Wt. 0.5 lb **14⁹⁹**

C) Mechanic's Stethoscope
Quickly pinpoints the source of mechanical noises in engines, transmissions, differentials and bearings
Unique sound chamber and super thin diaphragm greatly amplifies sounds
2918266 – Wt. 0.3 lb **24⁹⁹**

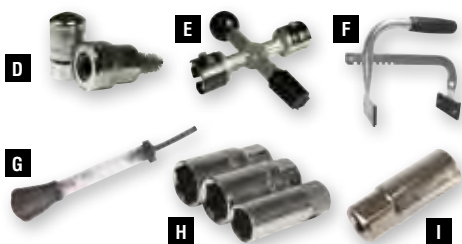

D) Battery / Terminal Brush
8007435 – Wt. 0.1 lb **2⁴⁹**

E) 4-Way Battery Post/Terminal Cleaner
2990113 – Wt. 0.3 lb **4⁹⁹**

F) Battery Carrier
• Rubber pads securely grip sides of battery
• Battery width from 5" to 7"
8261687 – Wt. 1.6 lb **14⁹⁹**

G) Battery Hydrometer
• Colour-coded float measures specific gravity
• Tests 6, 12 and 24V batteries
8064172 – Wt. 0.3 lb **3⁹⁹**

H) 3 pc Spark Plug Socket Set
5/8", 3/4" and 13/16"
8231359 – Wt. 0.8 lb **3⁹⁹**

I) 3/8" dr Spark Plug Sockets
2911147 – 5/8"
Wt. 0.2 lb **1⁹⁹**

2911139 – 13/16"
Wt. 0.3 lb **1⁹⁹**

Timing Light
• Works on all 12V gasoline engines
• Non-conductive plastic casing
• Includes advance timing feature
8000943 – Wt. 1.3 lb **69⁹⁹**



8 pc EFL Test Light Set
• Test electronic fuel injection signals on many domestic and import vehicles
• Noid lights plug into fuel injector wiring harness
• Contains: 6 noid lights as well as 2 IAC signal test lights
8014007 – Wt. 0.6 lb **19⁹⁹**



Digital Laser Tachometer
• Measuring range: 5 to 99,999 RPM
• Measures up to 26 ft away
• 5 digit LCD display
• Ergonomic ABS housing
• Operates on 4 "AA" batteries (included)
8077414 – Wt. 1.3 lb **74⁹⁹**



pro.point
Infrared Thermometer
• Measurement range: -60° to 500°C
• Distance to target ratio: 12:1
• Full range accuracy: ±1°C or 2% of reading (whichever is greater)
• Operating range: 0 to 50°C
• Powered by two AAA batteries (included)
8309650 – Wt. 0.6 lb **99⁹⁹**



POWER FIRST
Infrared Thermometer
• Measurement range: -50°C to 280°C (-58°F to 536°F)
• Distance to target ratio 8:1
• Accuracy: ±1.5°C (2.7°F)
8223570 – Wt. 0.6 lb **79⁹⁹**



Battery & Spark Plug Tools



J) Spark Plug Wrench
• For 5/8" and 3/16"
• Long reach
• Tommy bar included
8162067 – Wt. 0.5 lb **2⁹⁹**

K) In-Line Spark Plug Tester
• Transparent handle and indicating bulb
• Tests 6V and 12V
• Test plug without removing from engine
8003334 – Wt. 0.2 lb **5⁹⁹**

L) Spark Plug Boot Pliers
• Long arms remove hard to reach spark plug boots without pulling plug lead from clip
• Double insulated dipped jaws to protect against shock and ensure full coverage of all contact areas
8309247 – Wt. 0.6 lb **9⁹⁹**

M) Spark Tester
• Attach to spark plug wires to measure spark strength
• Jaws adjust to 5 positions
2990221 – Wt. 0.2 lb **9⁹⁹**



N) 14 mm Spark Plug Retreader Kit
Contains 5/8"x18 UNF tap reamer and 4 threaded inserts (3/8", 7/16", 1/2" and 3/4" long)
2990142 – Wt. 0.3 lb **11⁹⁹**

O) 4 pc Swivel Spark Plug Socket Set
• 3/8" drive
• 9/16", 5/8", 3/4", 13/16"
• Chrome vanadium steel
8159790 – Wt. 1.2 lb **19⁹⁹**

6 oz Battery Filler
• Keeps hands away from corrosive battery acid
• Made from acid resistant material
• 6" flexible spout
8064438 – Wt. 0.2 lb **3⁹⁹**



NEW
Rubber Spark Plug Remover & Installer
• Flexible shaft allows access from any angle
• Soft stepped tip firmly grips terminal and porcelain
• Helps avoid hot engine burns
8380669 – Wt. 0.3 lb **5⁹⁹**





Feeler Gauges

A) Standard / High Energy Spark Plug Gauge & Gapper

2990489 – Wt. 0.1 lb **2⁹⁹**

B) Ignition Spark Tester

Quickly checks spark at plug wire
2990056 – Wt. 0.1 lb **9⁹⁹**

C) Limited Access Spark Plug Chaser

- The narrow profile allows access to spark plug holes in confined spaces
- Use with 3/8" ratchet or extension
- M14 x 1.25
- Important : Use Anti-Seize

8149577 – Wt. 0.2 lb **9⁹⁹**

D) Spark Plug Pliers

- Two pulling positions help make removing spark plug wires safer and easier
- Specially shaped, cushioned jaws grip the boot straight on or from the side

8222754 – Wt. 0.4 lb **14⁹⁹**

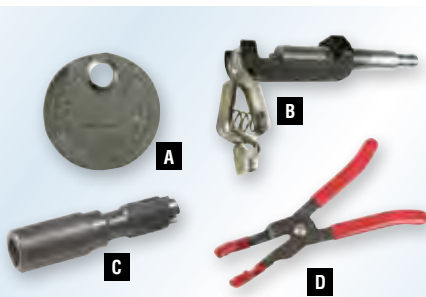

Feeler Gauges

E) Deluxe Feeler Gauge

- Precision blades (0.0015" to 0.035" thickness) ensure accurate measurement
- Blades are 1/2" wide by 3-1/2" long

2990117 – Wt. 0.3 lb **9⁹⁹**

F) Standard Feeler Gauge

30 blades 0.0015 to 0.035" plus 3" steel ruler
8006740 – Wt. 0.2 lb **7⁹⁹**

Battery Terminal Puller

Sharp jaws are able to engage either below or on the sides of the terminals
2990250 – Wt. 0.9 lb **9⁹⁹**



Testers



Compression Tools

G) Vacuum / Fuel Pressure Tester

- Measures 0 to 10 PSI (0 to 700 g/cm²) on mechanical fuel pump systems
- Vacuum range: 0 to 30 in-Hg (0 to 700 mm-Hg)

4230070 – Wt. 0.5 lb **14⁹⁹**

H) Compression Tester

2-1/4" dia. gauge reads 0 to 300 PSI
4230071 – Wt. 0.7 lb **24⁹⁹**

I) Digital Engine Compression Tester

- Gauge reads 0 - 300 PSI
- Gauge includes quick coupler for easy hose connection and a rubber boot for protection against bumps and drops
- Auto power-off after 3 minutes

8214082 – Wt. 2.4 lb **59⁹⁹**

4 pc Auto Tester Kit

Continuity tester, spark plug tester, 80 to 250V wireless voltage tester and 6 to 24V auto circuit tester
8306508 – Wt. 0.3 lb **12⁹⁹**



Heavy Duty Remote Starter Switch

- Allows technicians to bump or crank engines while under the hood
- 5 ft leads with heavy duty insulated alligator clips
- Rugged rubber housing

8311730 – Wt. 0.7 lb **36⁹⁹**



J) Cooling System Pressure Tester

- Test cooling systems and radiator pressure caps for leakage up to 30 PSI
- Fits standard 3/4" deep filler necks
- Brass cylinder tester with hand pump and 0 to 30 PSI pressure gauge

8072605 – Wt. 1.8 lb **99⁹⁹**

K) Cooling System Pressure Tester Adapters

For use with Cooling System Pressure Tester #8072605
8072613 – Acura, Chevrolet, Chrysler, Dodge, Plymouth, Ford, Lincoln, Mercury, Honda, Hyundai, Mazda, Mitsubishi, Nissan, Subaru, Suzuki and Toyota
8072621 – Acura, Chevrolet, Chrysler, Honda, Mazda, Mitsubishi, Suzuki and Toyota
Wt. 0.8 lb **19⁹⁹** /ea

Pocket Brake Fluid Tester

Integrated circuitry checks moisture content of fluid by measuring the electrical resistance and comparing it with acceptable limits
8338352 – Wt. 0.1 lb **11⁹⁹**



Brake Fluid Tester

- Quickly determines percentage of moisture in brake fluid
- Red, yellow and green indicator lights for easy readings
- AAA battery included

8380818 – Wt. 0.2 lb **19⁹⁹**

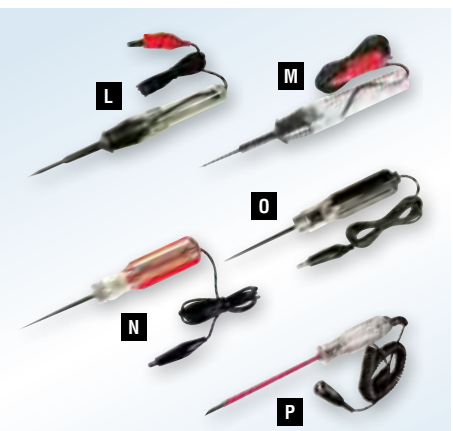

Circuit Testers

L) Circuit Tester – 48" Lead

Checks 6, 12 and 24 volt circuits
Tests for shorts in wiring, connectors, fuses and switches in automotive electrical systems
4211093 – Wt. 0.2 lb **2⁹⁹**

M) 6 & 12V Circuit Tester

8338337 – Wt. 0.2 lb **2⁹⁹**

N) Continuity Tester

- Tests 6V, 12V and 24V circuits, voltage regulators, fuses, switches, armatures, distributors and appliances
- 48" lead
- Self-powered by 1 "AA" battery (not included)

4211094 – Wt. 0.3 lb **7⁹⁹**

O) Audible Circuit Tester

- Utilizes flashing light and buzzer sound to check 6, 12, and 24V circuits
- 48" lead

4211092 – Wt. 0.2 lb **14⁹⁹**

P) Circuit Tester

- Insulated extra long probe reaches hard to access circuits
- Checks all 6 and 12V systems

8003317 – Wt. 0.6 lb **14⁹⁹**



Low Voltage Circuit Tester

- Quick check both AC and DC current up to 28 volts with power on
- Helps locate shorts or breaks in wiring
- Complete with insulated grounding clip

8338766 – Wt. 0.1 lb. **6⁹⁹**



Heavy Duty Circuit Tester / Jumper

- A 2-in-1 tester that tests circuits up to 12V and works as a jumper wire for power or ground

8221046 – Wt. 0.4 lb **29⁹⁹**



LED Alternator & Battery Tester

- Plugs into 12V DC power source for a quick and easy test
- LED indicator verifies condition of battery and alternator in 12VDC systems

8003736 – Wt. 0.1 lb **17⁹⁹**



Multi-Port Fuel Injection Pressure Tester

- Tests the fuel pressure on vehicles equipped with multi-port fuel injection
- Easy-to-read 0-150 psi scale 4" gauge
- Adapter hoses for schrader test ports with 7/16-20 threads and .308-32 threads
- Single end hose connector: 1/4", 5/16" and 3/8"
- Double end hose connector: 5/16" and 3/8"
- 6 mm fuel bolt adapter

8380040 – Wt. 5.0 lb. **99⁹⁹**



Fuse Circuit Testers

- Designed to easily connect into fuse socket

Wt. 0.4 lb **24⁹⁹**

8284481 – 0 to 20A ATM **29⁹⁹**

8284531 – 0 to 30A ATC **29⁹⁹**



Dial Type Antifreeze & Coolant Tester

8338345 – Wt. 0.3 lb. **4⁹⁹**



Voltage Tester with LCD & LED Display

- Measures AC/DC voltage from 12-600V
- Tests continuity and polarity
- CAT IV Requires 2 x 1.5V AAA batteries

8319683 – Wt. 0.5 lb **39⁹⁹**

Voltage Tester with LED Display **29⁹⁹**

8319709 – Wt. 0.5 lb **29⁹⁹**



Disconnect Tools



Sensor Sockets

A) Oxygen Sensor & Vacuum Switch Socket

- 7/8" sensor size
- Slotted for sensor wire and vacuum port clearance
- Use with a 3/8" dr ratchet or 1" wrench

2990254 – Wt. 0.5 lb **8⁹⁹**

B) Oxygen Sensor Thread Chaser

- Cleans threads in oxygen sensor holes
- Use with 3/4" hex socket or 3/8" square drive
- M18x1.5
- Also works on M18x1.5 spark plug threads
- Important: Use Anti-Seize

8149593 – Wt. 0.2 lb **8⁹⁹**



Air Conditioning / Fuel Line Disconnect Tool Set

2990323 – Wt. 0.2 lb **14⁹⁹**



9 pc Disconnect Tool Set

- Separates fuel, A/C & transmission line connectors on most domestic vehicles
- Works on 5/16", 3/8", 1/2", 5/8" and 1/2" lines
- Shielded versions add protection from fluid spray when disconnecting

8309221 – Wt. 0.3 lb **16⁹⁹**



Air Conditioning / Fuel Line Disconnect Tool Set

7 adapters - 1/4, 5/16, 3/8, 1/2, 5/8, 3/4 & 7/8" **9⁹⁹**

8356255 – Wt. 0.3 lb **9⁹⁹**



4 pc Fuel & Oil Line Disconnect Set

- 1/4", 5/16", 3/8" fuel disconnect tools and oil cooler linedisconnect tool
- Colour coded anodized aluminum construction

8309361 – Wt. 0.3 lb **24⁹⁹**



8" Pinch Off Pliers

- Shuts off flow through vacuum lines, fuel lines, coolant lines, etc.
- Cocking ratchet mechanism holds pivoting jaws tightly in place
- Heavy duty swivel jaws pivot to assure parallel pinching

8355356 – Wt. 0.6 lb. **11⁹⁹**



Camshaft Holding Tool

- Holds the cam shaft pulley to facilitate repair
- Adjustable pin centres to fit many engines
- Carbon steel with black finish & vinyl grip

8159808 – Wt. 1.7 lb **14⁹⁹**



Hose Pinchers & Pliers

4 pc Hose Pincher Set

- Quickly and easily pinch off rubber vacuum, fuel and heater hose
- Sizes: 3/8", 1/2", 1", 1-3/4"

8006296 – Wt. 1.1 lb **16⁹⁹**



10" Hose Pinch Off Plier

- Shuts off flow through vacuum lines, coolant lines, etc.
- Heavy duty swivel jaws pivot to ensure parallel pinching
- Cocking ratchet mechanism holds pivoting jaws tightly in place

8355372 – Wt. 0.8 lb. **14⁹⁹**



Hose Clamp Pliers

- Remove or install ring-type hose clamps
- Locking latch securely holds clamp in position
- Pliers feature angled jaws with rotating tips to grip clamps at any angle

2920951 – Wt. 0.5 lb **11.99**



7 pc Sensor Socket Set

- Sockets for oxygen sensors, fuel injectors, oil pressure sensors and vacuum switches

8003679 – Wt. 4.8 lb **59⁹⁹**



CV Boot Clamp Pliers

- For use on any vehicle with ear type clamps
- 1/2" dr holes in plier arms for added torque when used with breaker bar or ratchet

8160335 – Wt. 1.2 lb **21⁹⁹**

CV Boot Bander & Cutter Set

- 1 pc CV boot banding tool with cutter
- 2 pc stainless steel banding: 11" L x 1/4" W and 19" L x 1/4" W

8001187 – Wt. 0.7 lb **14⁹⁹**

2 pc CV Joint Banding Clamp

8001188 – Wt. 0.1 lb **2⁴⁹**

Radiator & A/C Condenser Fin Comb

- Cleans and straightens bent fins
- Six sided head for 8, 9, 10, 12, 14 and 15 fin per inch applications

8003324 – Wt. 0.3 lb **7⁹⁹**

pro.point

9 pc Disc Brake Caliper Driver Set

- 5 pc 3/8" dr hex bits (1/4", 3/8", 7, 8 and 10 mm)
- 3 pc 3/8" dr TORX® bits (T40, T45, T50)
- 1 pc 1/2" dr TORX® bit (T60)
- Chrome vanadium steel sockets with nickel chrome-moly bits

8310088 – Wt. 1.1 lb **19⁹⁹**

Brake Caliper Tool Set

- Use when installing new brake pads on both 2 and 4 wheel disc brake vehicles
- Rotates and compresses caliper pistons
- Includes forcing screw, plate and 5 sizes of piston adapters

8311722 – Wt. 3.9 lb **49⁹⁹**

18 pc Master Brake Caliper Tool Set

Tools and adapters designed to install new brake pads on most import and domestic vehicles with 4-wheel disc brakes

8354060 – Wt. 5.5 lb **59⁹⁹**

8 pc Brake Tool Set

Spring compressor, brake spring installer, spring removal tool, brake retaining spring tool, brake spring pliers, two brake adjustment spoons and mini brake adjustment tool

8309387 – Wt. 4.3 lb **39⁹⁹**

Specialty Wrenches

POWER FIST

Serpentine Belt Tool

- Use to release tension on spring loaded idler pulleys for removal and installation of serpentine belts
- Extension bar for hard to reach areas
- 3/8" dr chrome vanadium sockets: 13, 15, 16, and 18 mm

8051658 – Wt. 2.3 lb **22⁹⁹**

2 pc Strap Wrench Set

- Loosen, tighten, or hold any shape or material without scratching
- Perfect for oil filters
- Range: 0 to 4", 0 to 6-3/8"

8050805 – Wt. 0.7 lb **9⁹⁹**

pro.point

Ratcheting Serpentine Belt Wench Set

- Services approximately 90% of all vehicles equipped with spring loaded serpentine belt tensioners
- Specially designed to fit into tight areas
- Chrome vanadium steel socket
- 21 teeth gear

8355083 – Wt. 3.7 lb **49⁹⁹**

3 pc Universal Ratcheting Serpentine Belt Wrench Set

8306995 – Wt. 3.6 lb **54⁹⁹**

Brake Tools

POWER FIST

A) Brake Adjusting Tool

- Adjusts "star" wheel on drum brakes
- Zinc plated forged steel

8248478 – Wt. 0.3 lb **4⁹⁹**

B) Disc Brake Spreader

Compresses disc brake caliper piston for easy pad installation on most automotive applications

2990006 – Wt. 0.6 lb **5⁹⁹**

C) Disc Brake Piston Tool

- Offers 5 drive pin configurations to fit most domestic and some import vehicles
- Rotates and depresses caliper pistons when changing brake pads
- Use with 3/8" drive tools

2990062 – Wt. 0.2 lb **7⁹⁹**

8 pc Brake Gauge Set

Steel gauges with enamel coating

Red: 2 mm (0.0787"), 3 mm (0.1181"),
 Yellow: 4 mm (0.1575"), 5 mm (0.1969"),
 6 mm (0.2362"),
 Green: 8 mm (0.3150"), 10 mm (0.3937"),
 12 mm (0.4724")

8103624 – Wt. 0.6 lb **17⁹⁹**

D) 3/8" dr 8 pc Disc Brake Caliper Set

- Heavy duty S-2 steel construction
- 4 hex: 1/4", 5/16", 3/8" and 8 mm; 4 TORX®: T40, T45, T50, T60

8007024 – Wt. 1.0 lb **16⁹⁹**

E) Disc Brake Piston Spreader

- Chrome vanadium steel construction
- Fits within brake caliper to push back brake pistons for brake pad installation

8031408 – Wt. 1.9 lb **27⁹⁹**

F) Brake Spring Plier

Zinc plated forged steel

8248460 – Wt. 0.8 lb **7⁹⁹**

G) Brake Shoe Hold Down Spring Tool

- Removes and installs brake shoe hold-down springs
- Fits 5/8" to 3/4" O.D. springs

8248452 – Wt. 0.4 lb **8⁹⁹**

NEW

Air Tubing Clamp Locking Plier

8380834 – Wt. 2.4 lb **39⁹⁹**

Bearing Tools & Pullers

pro.point

37 pc Deluxe Puller Set

- Can also be used on flywheels on electric and 2-cycle motors
 - Centre yoke composed of Chrome-moly steel for added strength and durability
- 8309379 - Wt. 6.8 lb **74⁹⁹**



pro.point

Slide Hammer Puller Kit

- 22" long with 5 lb sliding weight
 - Jaws can be set up for 2 or 3 jaw internal or external pulling
 - Carbon steel construction with cast iron slide hammer
- 8309262 - Wt. 16.9 lb **109⁹⁹**

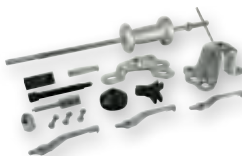

Steering Wheel Puller

- Universal puller for most makes and models
 - Screw pad protects end of steering shaft
 - Heavy duty for long wear
- 2990199 - Wt. 1.4 lb **24⁹⁹**



Harmonic Balancer Installer

- 12 pc adapters: 7/16" - 20, 1/2" - 20, 9/16" - 18, 5/8" - 18, 3/4" - 16, M10 x 1.5, M12 x 1.5, M12 x 1.75, M14 x 2.0, M16 x 1.5, M16 x 2.0
- 8223554 - Wt. 3.1 lb **49⁹⁹**



Steering Wheel Lock Plate Remover

- Fits domestic lock plates including tilt and telescoping columns
- 2990128 - Wt. 1.1 lb **9⁹⁹**



19 pc Harmonic Balancer Puller Kit

- Bolts for GM 3.3 and 3.8 V6 Engines
 - 3 pc 3/8" - 24 x 2"
 - 3 pc 5/16" - 18 x 2"
 - 3 pc M8 x 1.25 x 80 mm
 - 3 pc 3/8" - 16" x 4"
- 8261653 - Wt. 3.6 lb **19⁹⁹**



Mini Bearing Separator & Puller Kit

- Bearing separator capacity: 3/8" to 1-3/16"
 - Bearing puller capacity: 2" max. dia.
 - Chrome-moly components for added strength and durability
- 8310062 - Wt. 1.5 lb **49⁹⁹**



Harmonic Balancer Puller

- Reduces damage to both the pulley and the shaft
- 2918050 - Wt. 3.4 lb **34⁹⁹**



Puller Set

- For a wide range of pulling jobs including bearing, alternators, generators, power steering and crankshaft pulleys, timing gears and harmonic balancers
 - Includes necessary components to assemble 2 sizes of twin leg puller
 - Spread: 2-3/8" to 3-3/8" and 3-1/2" to 5-1/2"
- 8236440 - Wt. 9.4 lb **119⁹⁹**



46 pc Bolt Puller Kit

- Carbon steel construction with grade 5 bolts
 - Set includes: small and large centering adapters, flat shaft adapter, assorted silver studs, assorted black studs and assorted washers (spacers)
- 2923480 - Wt. 4.4 lb **29⁹⁹**



pro.point

Bearing Separator / Puller Set

- 1-1/4" to 2" dia. capacity
 - Chrome-moly steel construction for added strength and durability
- 8309619 - Wt. 3.4 lb **39⁹⁹**



Bearing Pullers

- A) 3-Jaw Bearing Puller**
- Compact size fits where other pullers cannot
 - Hook jaw on bearing inner hole to lift from its seat
 - Cap.: 1/2" to 2" I.D.
- 8105256 - Wt. 1.9 lb **24⁹⁹**
- B) Twin Leg Gear Puller**
- Includes: cone tip, flat tip and lubricating oil
 - Capacity - outer: 2-3/4" to 6-3/4" (70 to 170 mm), inner: 2" to 5-3/4" (50 to 145 mm)
- 2990200 - Wt. 3.9 lb **29⁹⁹**
- C) Long Reach Bearing Puller**
- 3-position 12" long jaws adjust to 6", 8" and 10" lengths
 - 3-7/8" screw extension
 - 3/8" to 2" wide bearing capacity
 - Chrome-moly steel construction
- 8311557 - Wt. 2.7 lb **49⁹⁹**



Power Steering/Alternator Pulley Pullers

- D) Pulley Pullers**
- Removes pressed on 1 or 2 groove alternator or power steering pulleys
 - Designed to allow jaws to be moved into 2 positions for most sizes of pulleys
- 2920143 - Wt. 2.2 lb **24⁹⁹**
- E) Pulley Puller**
- Removes grooved hub pulleys on Chrysler, Ford, GM and VW vehicles
 - Also works on GM belt driven vacuum pumps on both gas and diesel powered vehicles
 - Fits pulleys with hub dia. of: 1-1/8", 1-1/4", 1-5/16 and 1-3/8"
- 2990259 - Wt. 0.6 lb **24⁹⁹**
- F) Pulley Remover & Installer Set**
- Remove and install pressed-on alternator and power steering pump pulleys
- 2990177 - Wt. 1.7 lb **29⁹⁹**



Blind Hole Bearing Puller Set

- Includes: 2.2 lb hammer
- Works with bearing I.D. of 8 to 32 mm (5/16" to 1-1/4")
- Adapter sizes (fits bearing I.D.): 8 mm: 5/16" to 13/32" (8-10 mm), 10 mm: 13/32" to 15/32" (10-12 mm), 12 mm: 15/32" to 9/16" (12-14 mm)

8104036 – Wt. 8.2 lb **149⁹⁹**

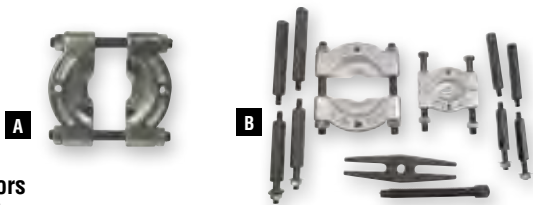

Bearing Separators

A) Bearing Separator

Cap.: 1/2" to 3"

2990103 – Wt. 3.2 lb **29⁹⁹**

B) Bearing Separator/Puller Set

- 2" and 3" splitters
- 4 sets of hex puller legs and a bar-type puller yoke with a 9/16" torquing bolt
- Bearing splitters, puller yoke, and centre bolt are chrome-moly steel for extra strength

8160483 – Wt. 10.9 lb **99⁹⁹**

Pitman Puller Arm

- Fits most cars and light trucks
- Opening size: 1-5/16"
- Pull travel: 2-1/2"

8105223 – Wt. 1.8 lb **14⁹⁹**



pro.point

Bushing Insert/Removal Tool Kit

- Remove and insert bushings in cars, trucks, buses, tractors, farm, construction and off-road equipment
- 3 drivers and nuts for driving

8363814 – Wt. 4.0 lb **49⁹⁹**



Universal Bearing Packer

- Simply place the bearing between the plastic cones, tighten, and apply grease through the fitting on the end of the threaded shaft
- Forces out old grease and evenly injects fresh grease
- 4-1/2" cone diameter

2928042 – Wt. 0.3 lb **14⁹⁹**



Seal Puller

2990539 – Wt. 0.8 lb **5⁹⁹**



pro.point

7 pc Bearing Driver Set

- Knurled aluminum handle with 6 driver discs
- 1.555", 1.752", 1.968", 2.322", 2.559"
- Durable reinforced nylon driver discs will not damage bearing surfaces

8311573 – Wt. 2.2 lb **34⁹⁹**



Bearing & Seal Pullers

pro.point

2 pc Seal Puller Set

Ideal for use on seals where shaft cannot easily be removed

8309395 – Wt. 1.4 lb **19⁹⁹**



Pneumatic Bearing Race and Seal Driver Set

Includes hammer handle and pneumatic handle for air hammer
11 driver sizes : 1-9/16", 1-3/4", 1-15/16", 2-5/16", 2-15/32", 2-1/2", 2-13/16", 3", 3-3/16", 3-13/16" and 4-5/8"

8311565 – Wt. 6.9 lb **84⁹⁹**

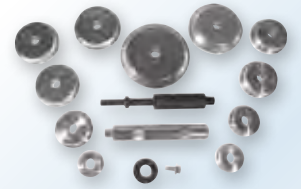

Seal Driver Set

Contains: 16 plastic adapters for up to 3-3/8" dia. seals.

2920260 – Wt. 1.7 lb **19⁹⁹**



Bearing Race & Seal Driver

- 6 drivers and handle
- Makes it easier to insert bearing race
- Sizes: 1.565", 1.750", 1.965", 2.325", 2.470", 2.555"

2918514 – Wt. 1.6 lb **59⁹⁹**



20 pc Crank Seal Remover & Installer Kit

Tools and adapters to replace seals without having to dismantle the crankcase

8354110 – Wt. 3.9 lb **89⁹⁹**



Armature Bearing Puller

- Fits many types of bearings including popular 6202 and 6203
- Cap.: 1/2" to 2-1/8"

8105272 – Wt. 1.6 lb **21⁹⁹**



pro.point

3 pc Axle Bearing Puller Set

- Quickly removes semi-floating rear axle bearings Fits standard slide hammers
- 3 pullers fit bearing I.D.s of 1" to 1-7/8", 1-5/16" to 2-3/8" and 1-3/8" to 2-7/8"

8309569 – Wt. 2.8 lb **49⁹⁹**



Screw Type Pilot Bearing Puller

- Removes fly-wheel pilot bearings up to 7-1/2" long
- Carbon steel body with chrome-moly jaws

8355844 – Wt. 3.4 lb **39⁹⁹**



Valve & Piston Tools

pro.point

NEW

Universal Locking Timing Belt Tool

- Works on Twin Cam, Single Cam and diesel engines
- Adjustable arms lock into camshaft gears from 0 to 60 mm apart

8351298 – Wt. 1.7 lb. **49⁹⁹**



NEW

Universal Twin-Cam Locking Tool

- Ideal for adjusting the pin to lock the cam in position
- Easily adjusts with multi pin positions and an interchangeable frame to cover a wide range of applications
- Aluminum/steel construction

8354052 – Wt. 1.7 lb. **49⁹⁹**



Hose Clamp Plier Set

- Angled jaws with rotating tips to grip clamp at any angle
- Locking latch securely holds clamp in position
- Includes: interchangeable jaw tips for use with various types of flat band and ring type hose clamps

8311805 – Wt. 1.9 lb. **29⁹⁹**



Red



B



A



D

A) Piston Ring Installer

Tapered jaws to remove and install most passenger car and light truck rings from 3/64" to 1/4"

2918274 – Wt. 0.2 lb. **9⁹⁹**

B) Ring Compressors

Lisle spring clutch assures a proper fit on the piston, a positive locking action and eliminates ratchet problems

2-1/8" to 5" Ring Compressor
2915205 – Wt. 0.7 lb. **17⁹⁹**

3-1/8" to 7" Ring Compressor
2915213 – Wt. 0.8 lb. **21⁹⁹**

C) Small Engine Valve Spring Compressor

- Small and large jaw attachments for springs 3/4" to 1-1/16"

- Heavy duty frame and screw for rigidity
- For Briggs and Stratton, Clinton, Harley-Davidson

2918456 – Wt. 0.9 lb. **29⁹⁹**

D) Stone-Type Glaze Breaker

- Full 2" to 7" range
- Complete with 3" long 220 grit stones
- Adjustable stop collar permits quick selection of two range settings, from 2" to 4" and from 4" to 7"
- Stone arms are easily compressed to eliminate cylinder scratches

2914588 – Wt. 1.2 lb. **34⁹⁹**

Replacement 220 Grit Stones
2991057 – Wt. 0.2 lb. **9⁹⁹**

POWER FIRST

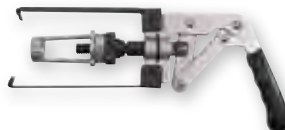

Universal Overhead Valve Spring Compressor

Suitable for a wide range of OHV, OHC, and CVH engines

8261604 – Wt. 1.9 lb. **29⁹⁹**

NEW

POWER FIRST



3 pc Rubber Cone Adapter Set

Size applications: 17 to 31 mm, 24 to 39 mm and 34 to 50 mm

8380842 – Wt. 0.7 lb. **19⁹⁹**

Overhead Valve Spring Compressor

Offset jaws grip valve spring in parallel compression

8355885 – Wt. 0.7 lb. **11⁹⁹**



4" Engine Cylinder Hone

- Capacity: 2" to 7"
- 3 pc stones: 4" long, 220 grit silicon carbide
- Zinc plated flexible steel shaft with 1/4" end

8243537 – Wt. 1.4 lb. **25⁹⁹**



3 pc Replacement Stones
For engine cylinder hone #8243537

8243552 – Wt. 0.2 lb. **8⁹⁹**

NEW

Piston Ring Service Tool Set

Includes 3 piston ring compressors (3", 3-1/2" and 4"), piston ring groove cleaning tool and piston ring installation tool

8380826 – Wt. 5.6 lb. **99⁹⁹**



NEW

Flexible Handle Oxygen Sensor Wrench

- Chrome-moly steel socket
- Flex handle allows use in tight spaces where a standard oxygen sensor socket can't reach

8348591 – Wt. 0.9 lb. **14⁹⁹**



Valve Spring Compressor

- 2 adapters fits valve spring retainers up to 1-1/16"
- Jaw adjustment: 1-3/8" to 5-5/8"; throat depth: 5-7/8"

8003725 – Wt. 4.5 lb. **49⁹⁹**



5/16" Battery Side Terminal Wrench

For use on 5/16" side terminal battery bolts found on GM vehicles

8243586 – Wt. 0.2 lb. **5⁹⁹**



Earless CV Boot Clamp Plier

Special tips work on the earless type CV boot clamps

8261661 – Wt. 0.7 lb. **19⁹⁹**





10-In-1 Trim Tool

Serrated edge for panel seam clean up, plastic door clip remover, windshield moulding clip release tool, headlight spring tool, and beveled edge for removing moulding
2990039 – Wt. 0.3 lb **8⁹⁹**



Door Spring Tool

Quickly and easily remove or install door hinge springs on GM cars and light trucks
8006597 – Wt. 0.6 lb **7⁹⁹**

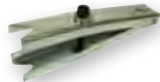

3 pc Body Clip Removal Plier Set

- 7" straight push pin plier,
- 7" angle push pin plier and
- 9" positive lift action clip remover plier
- Chrome-moly construction for added strength, vinyl grip for comfort

8248494 – Wt. 1.5 lb **29⁹⁹**

Work Stand Clamp Locking Plier

- Welded ring on the clamp fits over the padded arm of your work stand
- Carbon steel construction with black finish

8380859 – Wt. 0.6 lb **24⁹⁹**



PRINCESS AUTO

Welcome to our Unique World!



Home of an outstanding shopping experience, every time!

Windshield Wiper Arm Remover

Suitable for straight or taper spline spigots with a maximum diameter of 5/8" (16 mm)
8002225 – Wt. 0.3 lb **11⁹⁹**



Window & Door Handle Clip Remover

Works on GM, Ford, and other models using common "C" type clips
2990060 – Wt. 0.4 lb **7⁹⁹**



Trim Tools

2990316 – Wt. 0.5 lb **8⁹⁹**

pro.point



A) 5 pc Trim Remover Set

- Assortment of pry / pull tools for removal of interior and exterior automotive trim, fasteners and moldings
- Reinforced nylon construction reduces risk of damage to trim and surrounding area

8309411 – Wt. 0.8 lb **14⁹⁹**

B) 6 pc Trim Remover Set

8243966 – Wt. 0.6 lb **19⁹⁹**

Door Jammer Tool

Fits any size latch
8356263 – Wt. 1.0 lb **19⁹⁹**



Trim Tools

Wt. 0.4 lb
C) Door Trim Remover
2990063 **4⁹⁹**

D) Door Upholstery Remover
2991016 **12⁹⁹**



Tightwire Windshield Remover

Includes 6 ft roll of cut-out wire
2990045 – Wt. 0.6 lb **14⁹⁹**



Windshield Cut Out Wire

- Triangle stainless steel
- 0.66 sq/mm
- 165 ft/50 metres
- For use with: 2990045 (above)

8266462 – Wt. 0.3 lb **19⁹⁹**

Trim Tools

pro.point

Plastic Riveter w/ Rivets

- Compact size for ease of use in tight spaces
- Self adjusting jaws
- Contains rivet gun and 10 each of 6.6 mm x 17.2 mm, 6.3 mm x 25.2 mm, 5 mm x 15.8 mm plastic rivets

8311862 – Wt. 1.0 lb **24⁹⁹**

20 pc Plastic Rivets

- 6.3 mm x 25.2 mm
- For use with pro.point plastic riveter 8311862

8325177 – Wt. 0.1 lb **4⁹⁹**

3 pc Automotive Upholstery Remover Set

- Window and door handle clip tool, "V" double step blade door panel tool and "U" blade door panel tool
- Stainless steel blades with thermoplastic rubber grip handles

8311797 – Wt. 0.9 lb **14⁹⁹**

3 pc Seam Splitter Set

- For separating spot welded panels for auto body repair work
- Straight, 30° offset and 90° angle sizes
- Chrome vanadium steel Go-through shafts with comfort grips

8374100 – Wt. 2.4 lb **29⁹⁹**

Windshield Tools

Windshield Removal Tool

Steel pull cable makes cutting out windshields fast and easy
2990067 – Wt. 0.6 lb **13⁹⁹**



Replacement Blade

2990215 – Wt. 0.1 lb **1⁹⁹**

Hundreds of Applications



Bondo® Auto Body & Fibreglass Repair Products

From sanding to paint protection and everything in between, there are Bondo® brand products for your frame, body and fibreglass repair needs.

Bondo® brand products: trusted products for professional applications.



Endless possibilities. Professional Results **3M**

3M and Bondo are trademarks of 3M. Used under license in Canada. © 2010, 3M. All Rights Reserved. BA-10-14607 1005-01419

Autobody Filler



Professional Gold Premium Body Filler

- Tack-free sanding
 - Superior adhesion to steel, wood, fibreglass and aluminum
 - Creamy formula mixes easier and spreads smoothly
 - 850g filler / 21g hardener
- 8318073** – Wt. 2.3 lb **14⁹⁹**



3 pc Plastic Spreaders

- Use with body fillers, fibreglass resin and putty
 - 2-3/4" x 4", 3" x 5-1/4", 3-1/2" x 6-1/4"
 - Reusable: just bend and hardened material will pop off of spreader
- 8318032** – Wt. 0.2 lb **2⁹⁹**



Body Filler File Holder

- Includes: 10" flat blade
- 8231540** – Wt. 0.5 lb **12⁹⁹**



A) Fibreglass Resin

- 1 Litre**
8204992 – Wt. 2.7 lb **16⁹⁹**
- 3.78 Litre**
8205007 – Wt. 10.7 lb **49⁹⁹**

1 Litre Fibreglass Filler

- B) Long Strand**
8205064 – Wt. 2.6 lb **14⁹⁹**
- C) Short Strand**
8204984 – Wt. 3.2 lb **16⁹⁹**

Fibreglass Filler

- 8 sq. ft**
- F) 8205049** – Fibreglass Mat
Wt. 0.5 lb **7⁹⁹**
- G) 8205056** – Fibreglass Cloth
Wt. 0.3 lb **9⁹⁹**



D) Glazing & Spot Putty

- 127.5 g
8205072 – Wt. 0.4 lb **3⁹⁹**

E) Body Filler

- With cream hardener
- 1/2 Litre**
8204935 – Wt. 1.3 lb **7⁹⁹**
- 1 Litre**
8204968 – Wt. 2.3 lb **8⁹⁹**
- 3.78 Litre**
8204976 – Wt. 8.6 lb **27⁹⁹**

Liquid Hardener

- 11 ml tube
8318115 – Wt. 0.1 lb **2⁴⁹**

Red Cream Hardener

- 21g tube
 - Use with all Bondo body fillers, Bondo glass, Bondo hair & Bondo fibreglass resin jelly
- 8318099** – Wt. 0.1 lb **2⁹⁹**





Bondo Resin Repair Kit

236 ml liquid hardener, fibreglass mat, spreader, mixing stick and instructions
8205015 – Wt. 0.9 lb.....



12⁹⁹



3M® Headlight Lens Renewal System

Kit is designed for one-time use and will improve two headlights (large or extremely hazed headlights may require more than one kit)
8395477 – Wt. 0.5 lb.....



29⁹⁹



Bondo Resin Repair Kit

500 ml liquid hardener, fibreglass mat, spreader, mixing stick and instructions
8205031 – Wt. 3.4 lb.....

22⁹⁹

pro.point

4 pc Body Filler Applicators

- Stainless steel blades in a polypropylene frame with ergonomic rubber cushion grips
- 2", 3", 4" and 6"

8310070 – Wt. 0.5 lb.....

11⁹⁹



Aerosol Trigger

Turns a spray can into a spray gun
8318057 – Wt. 0.1 lb.....



4⁹⁹

You think THIS catalogue has a lot of information?

You should check out princessauto.com for our newest products, additional product info and customer reviews.

Auto Dollies



A



C



B



D



Autobody Dollies and Hammers

		Wt. (lb)	ITEM	PRICE
A	Combination Auto Dolly	1.9	2990078	7.99
B	Universal Auto Dolly	1.7	2990080	7.99
C	Fibreglass Handled Autobody Pick Hammer	1.1	8002584	5.99
D	Bumping Hammer	1.1	8002586	5.99

7 pc Autobody Kit

- Fibreglass handles
- Bumping, pick and reverse curve hammers
- Double ended, utility, heel and curved dollies

2990149 – Wt. 11.6 lb.....

39⁹⁹



9 pc Dent Puller Kit

5 lb slide hammer, metal pulling screw, pierce punch, 2 steel nose cones, 2 puller hooks, L-puller and plate edge puller

2990090 – Wt. 8.4 lb.....

39⁹⁹



pro.point

Autobody Shaping Tool Repair Kit

- 11 interchangeable heads lock in place with double locking ball detent
- Cross curve tip, two ball pein tips, curve blade tip, T-shape flat blade tip, L-shape flat blade tip, small curve tip, angle groove tip, round face tip, square face tip and angle face tip

8344343 – Wt. 4.6 lb.....

39⁹⁹



Pneumatic Dent Puller

- 90 PSI operating pressure
- 1/4" air inlet with M-style quick connect end
- 3 pc suction pads (2-3/8", 4-3/4", and 6" dia.)

8319634 – Wt. 8.8 lb.....

99⁹⁹



Suction Cups

E) 2 pc Suction Cup

- Capacity: 20 lb
- Closing handle activates suction

8136608 – Wt. 0.4 lb.....

5⁹⁹

F) 2-Head 4-1/2" Suction Cups

- Capacity: 160 lb
- Heads pivot slightly for better fit on concave surfaces

8136624 – Wt. 1.7 lb.....

12⁹⁹



G) 4-1/2" Suction Cup Dent Puller

- Capacity: 90 lb
- Closing handle activates suction

8136616 – Wt. 0.7 lb.....

4⁹⁹

H) 3-Head 4-1/2" Suction Cup Dent Puller

- Capacity: 220 lb
- Levers lock in place to hold suction

8136632 – Wt. 2.2 lb.....

15⁹⁹

Dent Repair

Autobody Sanding

TASK



5 Pack Sandpaper
9" x 11" sheets

	Grit	Wt.(lb)	ITEM	PRICE
A) Aluminum Oxide	80	0.5	8362030	4.99
	120	0.4	8362048	4.99
	220	0.3	8362055	4.99
	Assorted	0.4	8362063	4.99
B) Wet / Dry	220	0.2	8362030	4.99
	320	0.2	8362105	4.99
	400	0.2	8362121	4.99
	600	0.5	8362147	4.99
	Assorted	0.2	8362154	4.99

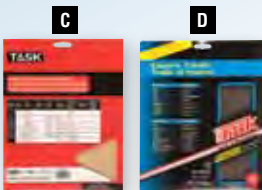

C) 5 Pack Assorted Grit Garn-Alum™ Sandpaper

- 9" x 11" sheets
 - 1 medium, 2 very fine and 2 super fine
- 8362170 – Wt. 0.3 lb..... **3⁹⁹**

D) 5 Pack Assorted Grit Emery Cloth Sandpaper

- 9" x 11" sheets
 - 1 coarse, 1 medium, 1 fine
 - Metal finishing
- 8362162 – Wt. 0.3 lb..... **5⁴⁹**



E) Sanding Blocks

2-5/8" x 4-3/4"
1/4 sheet
8161671 – Wt. 0.7 lb **2⁹⁹**

2-5/8" x 9"
1/3 sheet
8161689 – Wt. 1.7 lb **3⁹⁹**

F) ABS Sanding Block

3-1/4" x 6-1/4"
1/3 sheet
8161697 – Wt. 0.3 lb **3⁹⁹**

4" x 8-1/4"
1/2 sheet
8161705 – Wt. 0.5 lb **5⁹⁹**

G) 2-3/4" x 16" Non-Flexible Sander

- Wooden handle
 - Quick change spring clamps
- 2970170 – Wt. 1.1 lb **14⁹⁹**

PRE-CUT sandpaper for 2970170 can be found in Air Tools



6" Mouse Style Sanding Block

- 5 sanding hook and loop discs
 - 2 each: 80, 120 and 180 grit
- 8293334 – Wt. 0.5 lb **7⁹⁹**

3 pc Sanding Sponges

- 40, 80 and 320 grit
- 8133050 – Wt. 0.2 lb **3⁹⁹**

H) Sanding Sponges

Grit	Wt. (lb)	ITEM	PRICE
80	0.1	8133100	1.79
320	0.1	8133118	1.79
80/320	0.1	8121196	1.79

I) Sanding Rolls

Grit	Wt. (lb)	ITEM	PRICE
60	0.5	8211435	4.99
80	0.5	8211443	4.99
120	0.4	8211450	4.99
180	0.3	8211468	4.99
240	0.2	8211476	4.99
320	0.2	8211484	4.99

J) 5 pk 6" Hook & Loop Sanding Discs

Grit	Wt. (lb)	ITEM	PRICE
80	0.2	8293482	1.99
120	0.1	8293474	2.49
180	0.1	8293441	2.49

15 pc Assorted Sandpaper

- Sand metal, wood, painted surfaces and plastic
 - Three 40 grit, five 80 grit, five 120 grit, two 150 grit
- 2920955 – Wt. 0.8 lb **2⁴⁹**



Princess Auto Foundation



Together we are making a difference

for our future customers. By providing bursaries to Canadian Colleges throughout Canada we demonstrate our support for the trades. Work with the hands-give from the heart.

For more information visit us at: www.theprincessautofoundation.com

PAF PARTNERS

Charitable # 833179369 RR00041

pro.point
hard working tools.



EXCLUSIVELY AT: **PRINCESS AUTO**

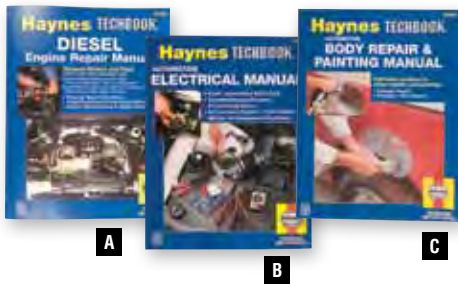

Haynes Techbook Manuals

A) GM & Ford Diesel Engine Repair Manual

This comprehensive manual covers maintenance, repair and overhaul on GM 350 and 379 cu. in (5.7 and 6.2 L), and Ford 420, 445 cu. in. (6.9, 7.3 and 7.3 L Power Stroke) engines. **24⁹⁹**

B) Automotive Electrical Manual

Covers basic electrical fundamentals, troubleshooting, and repair for both domestic and foreign vehicles. Includes engine starting and charging systems, lights, gauges, and accessories. **24⁹⁹**

C) Automotive Body Repair & Painting Manual

A complete photographic guide showing car care and detailing, rust prevention as well as body repair and painting - from minor dents to major structural damage. **24⁹⁹**

4490020 - Wt. 0.9 lb



D) OBD-II & Electronic Engine Management Systems Manual

Covers ALL 1996 and later cars and light trucks, including trouble code lists. **24⁹⁹**

8153538 - Wt. 0.9 lb

E) Small Engine Repair Manual 5 HP or Less

Covers maintenance, troubleshooting and repair procedures for popular small engines used on mowers, garden tillers, generators, pumps and similar equipment. **24⁹⁹**

4490587 - Wt. 1.0 lb

5-1/2 to 20 Horsepower

Provides coverage for larger single and twin-cylinder engines typically used in lawn tractors, generators, rototillers, snow blowers, log splitters and industrial equipment. **24⁹⁹**

4490063 - Wt. 1.4 lb

F) Welding Manual

- Covers gas (oxy-acetylene), arc, MIG, and TIG welding, soldering, and flame cutting
- Techniques are discussed as they relate to automotive and workshop repairs. Information on selecting equipment is also included. **24⁹⁹**

4490001 - Wt. 0.6 lb



G) Autoref

An automotive reference for anyone who owns or operates a vehicle. **12⁴⁹**

8058091 - Wt. 0.5 lb

H) Handyman In-Your-Pocket

The ultimate reference for contractors, builders, do-it-yourselfers, hardware specialists, craftsmen and tradesmen. **12⁴⁹**

8058109 - Wt. 0.4 lb

I) Pocket Reference

4th edition Information for do-it-yourselfers, engineers, craftsmen, students, teachers, managers, maintenance & industrial personnel and travelers. **12⁴⁹**

8358517 - Wt. 0.4 lb



Build Your Own Utility Trailer

Complete detailed instructions from are accompanied by full-colour photographs, illustrations and specification charts. **19⁹⁹**

8250649 - Wt. 0.5 lb



Automotive Repair Manuals

Every manual based on a complete teardown and rebuild!

Wt. 1.2 lb **24⁹⁹** /ea

	Manual Description	ITEM
CHEVROLET	Chevrolet & GMC Pickups '67 thru '87 Repair Manual	4490090
	Chevrolet & GMC Pick-Ups '88 thru '98 Repair Manual	4490027
	Chevrolet Silverado & GMC Sierra Pick-Ups '99 thru '06 Repair Manual	8007396
	Chevrolet S-10 & GMC Sonoma Pickups '94 thru '04 Repair Manual	8005698
DODGE	Dodge Pick-Up's '94 thru '01 Repair Manual	4490060
	Dodge Pick-ups '02 thru '08 Repair Manual	8153405
FORD	Ford Pick-Ups & Bronco '80 thru '96 Repair Manual	4490028
	Ford Pick-ups '97 thru '03 & Expedition '97 thru '09 Repair Manual	8153504
	Ford Ranger Pick-ups '93 thru '10 Repair Manual	8153520
	Ford Super Duty Pick-Up & Excursion '99 thru '10 Repair Manual	8187635

WORK with us!

We are always looking for team-oriented people with a passion for delivering Royal Service.

Visit www.princessauto.com/careers to apply for any of our positions across Canada

Part-Time • Full-Time • Benefits • Opportunities • Fun

Looking for the perfect gift?

GIFT CARDS

are available at any Princess Auto location

DRIVELINE



Hydraulics 242 - 267

- Breathers & Strainers 261
- Control Valves & Accessories 257 - 259
- Cylinders & Accessories 243 - 245
- Flow Controls 260
- Hose & Fittings 248 - 253
- Hydraulic Oil & Filtration 263 - 264
- Log Splitter Components 267
- Motors 247
- Pneumatic Equipment 265 - 267
- Porta Power Systems & Accessories 246 - 247
- Power Packs 254, 255 - 256
- Pumps 254
- Reservoirs 261
- Snow Plow Components 242 - 243
- Testing Equipment 262

Driveline Components 268 - 276

- Cables / Linkage 277
- Centrifugal Clutches 274 - 275
- Engines 268, 270
- Flex Couplers, Shafting & Collars 276

- Pulleys & Belts 270 - 272
- Small Engine Accessories 269
- Sprockets, Bearings & Chain 273 - 274

Motors and Controls 277 - 279

- Electric Motors 277
- Linear Actuators 278
- Switches 278
- Wireless Remotes 279

Hydraulics

Snow Plow Components

Snow Plow Cylinders

- Used for lifting and angling the snow plow blade
- Port: 1/4" NPT



Type	Bore	Stroke	Retracted Length*	Rod Diam.	Pinhole Diam.	Wt. (lb)	ITEM	PRICE
Meyer	1-1/2"	6"	12-3/8"	1-1/8"	5/8"	9.3	8332199	89.99
	1-1/2"	10"	16-3/16"	1-1/2"	5/8"	12.9	8332256	74.99
Fisher	1-1/2"	12"	18.0"	1-1/2"	5/8"	14.2	8332108	74.99
	1-1/2"	10"	17-1/4"	1-1/2"	1"	13.2	8332249	74.99
Western	1-1/2"	12"	19-1/4"	1-1/2"	1"	14.8	8332223	79.99
	1-1/2"	6"	12-15/16"	1-1/2"	3/4"	10.5	8332215	79.99
	1-1/2"	8"	15-1/4"	1-1/2"	3/4"	12.3	8332173	69.99
	1-1/2"	10"	16-3/4"	1-1/2"	1"	13.2	8332231	74.99
	1-1/2"	10"	17-1/4"	1-1/2"	3/4"	13.6	8332132	74.99

* Pinhole center to pinhole center



Snow Plow Emergency Repair Kits

- Contains the most frequently used on-the-job repair parts
- Packaged in a sturdy polyethylene box
- Eyebolt with nuts, trip spring, and hydraulic quick coupler



Meyer

Pair of hinge pins with clips, 4 shoe washers, 45" hose with swivel, 90° elbow, motor solenoid and 4 blade guide tips
8333270 – Wt. 11.4 lb

Western

Hitch pin, hairpin cotters, chainbolt and washer, locknut, 6 shoe washers, linch pin, 36" hose, 1/4" hex nipple, 1/4" 90° elbow street elbow, motor solenoid and relay solenoid
8333262 – Wt. 11.3 lb

99⁹⁹ /ea



Snow Plow Blade Guide Kit

Kit consists of two fibreglass blade guides with bolt-on base

- 26" Yellow**
8199630 – Wt. 1.2 lb. **24⁹⁹**
- 27" Red (shown)**
8199671 – Wt. 1.2 lb. **19⁹⁹**
- 28" Orange**
8199580 – Wt. 0.8 lb. **24⁹⁹**
- 36" Orange**
8332082 – Wt. 1.0 lb. **27⁹⁹**

Snow Plow Trip Springs

Meyers
8201428 – Wt. 5.8 lb

Western
8201410 – Wt. 6.2 lb. **19⁹⁹** /ea



Replacement Snow Plow Shoe Assemblies

- A) Meyer**
8199549 – Wt. 8.9 lb. **31⁹⁹**
- B) Western**
8201444 – Wt. 9.3 lb. **24⁹⁹**



Replacement Snow Plow Hydraulic Hose

38" 8332272 - Wt. 0.4 lb. **8⁹⁹**

45" 8332264 - Wt. 0.5 lb. **15⁹⁹**



Snow Plow Motor Solenoids

Replacement motor solenoid for snow plow power packs

Meyer and Diamond 8332298 - Wt. 0.8 lb. **9⁹⁹**

Western 8333254 - Wt. 0.8 lb. **11⁹⁹**



Skid Plates Ariens / John Deere

- Replaces Ariens 24599 and Ariens blowers from '60s til present
- Also fits John Deere / Bloens / MTD / Simplicity
- Ariens models 924080 and 924082 with 24" auger

8194581 - Wt. 1.1 lb. **9⁹⁹**



Skid Plates Mtd

- Old style slide shoe
- Used on most large two stage throwers prior to 1998
- Small frame two stage throwers prior to 1992

8194599 - Wt. 1.7 lb. **11⁹⁹**



- 3,000 PSI max. continuous pressure
- Features cross tube mounting ends

NOTE: Retracted length is measured centre of pinhole to centre of pinhole

5,301 lb Push @ 3,000 PSI

Stroke	Retracted Length	Rod dia.	Wt. (lb)	ITEM	PRICE
4"	12"	1"	7.0	1200239	114.99
6"	14"	1"	7.1	1200240	119.99
8"	16"	1"	8.1	1200241	124.99
10"	18"	1"	9.1	1200242	129.99
16"	24"	1"	12.2	1200246	134.99
20"	28"	1"	15.0	8008746	139.99
24"	32"	1"	16.1	8008773	144.99

- 1-1/2" bore
- #6 ORB ports
- 3/4" dia. pinholes
- Base pineye width: 2"
- Rod pineye width: 2"

9,424 lb push @ 3,000 PSI

Stroke	Retracted Length	Rod dia.	Wt. (lb)	ITEM	PRICE
4"	12"	1-1/4"	9.8	8008808	129.99
6"	14"	1-1/4"	10.0	8008844	134.99
8"	16"	1-1/4"	12.7	1204304	139.99
10"	18"	1-1/4"	14.2	1200131	144.99
12"	20"	1-1/4"	15.6	1204312	149.99
14"	22"	1-1/4"	17.1	1204320	154.99
16"	24"	1-1/4"	18.5	1204437	159.99
18"	26"	1-1/4"	20.0	1204338	164.99
20"	28"	1-1/4"	21.4	1204346	169.99
24"	32"	1-1/4"	24.4	1204353	174.99
30"	38"	1-1/4"	28.7	1204361	179.99
32"	40"	1-1/4"	30.0	1200220	184.99
36"	44"	1-1/4"	32.8	1200221	189.99
40"	48"	1-1/4"	35.8	1200222	194.99
48"	56"	1-1/4"	38.0	1204452	199.99

- 2" bore
- #6 ORB ports
- 1" dia. pinholes
- Base pineye width: 2-3/4"
- Rod pineye width: 2-1/4"

shurLife 3,000 Threaded Head Utility Cylinders

14,726 lb push @ 3,000 PSI

Stroke	Retracted Length	Rod dia.	Wt. (lb)	ITEM	PRICE
6"	14"	1-1/4"	13.9	8008853	139.99
8"	16"	1-1/4"	15.6	1204379	149.99
10"	18"	1-1/4"	17.2	1200223	154.99
12"	20"	1-1/4"	18.7	1200132	159.99
14"	22"	1-1/4"	20.4	1200224	164.99
16"	24"	1-1/4"	21.8	1200133	169.99
18"	26"	1-1/4"	23.0	1200225	174.99
20"	28"	1-1/4"	25.0	1204387	179.99
24"	32"	1-1/4"	28.4	1204395	184.99
30"	38"	1-1/2"	38.1	1200196	199.99
36"	44"	1-1/2"	43.8	1200227	209.99
48"	56"	1-1/2"	55.3	1200230	259.99

- 2-1/2" bore
- #6 ORB ports
- 1" dia. pinholes
- Base pineye width: 3-1/4"
- Rod pineye width: 2-1/4"

21,205 lb push @ 3,000 PSI

Stroke	Retracted Length	Rod dia.	Wt. (lb)	ITEM	PRICE
8"	16"	1-1/4"	18.8	1204403	159.99
10"	18"	1-1/4"	20.6	1204429	164.99
12"	20"	1-1/4"	22.4	1200134	169.99
14"	22"	1-1/4"	24.1	1200210	174.99
16"	24"	1-1/4"	25.9	1204510	179.99
18"	26"	1-1/4"	27.8	1204536	184.99
20"	28"	1-1/2"	32.9	1200135	189.99
24"	32"	1-1/2"	36.9	1204593	209.99
30"	38"	1-1/2"	43.3	1200136	214.99
32"	40"	1-1/2"	48.4	1204734	229.99
36"	44"	1-3/4"	46.4	1204742	239.99
40"	48"	1-3/4"	61.4	1204759	244.99
48"	56"	1-3/4"	77.0	1200212	289.99

- 3" bore
- #8 ORB ports
- 1" dia. pinholes
- Base pineye width: 3-3/4"
- Rod pineye width: 2-1/4"

To calculate the pump flow required to fully extend a cylinder in a set time.

Step 1	
Cylinder Volume (Gallons)	= $\frac{\text{Area of the Piston (sq.in)} \times \text{Cylinder Stroke (in)}}{231}$

Step 2	
Pump Flow (GPM)	= $\frac{\text{Cylinder Volume (Gallons)} \times 60}{\text{Cylinder Extend Time (Sec.)}}$

To calculate the maximum force a cylinder can produce while extending.

Step 1	
Radius of Piston (in)	= $\frac{\text{I.D. of Cylinder (in)}}{2}$

Step 2	
Area of Piston (sq.in)	= $3.14 \times \text{Piston Radius}^2 \text{ (in)}$

Step 3	
Cylinder Force (lb)	= $\text{Pressure (PSI)} \times \text{Area of Piston (sq.in)}$



28,863 lb push @ 3,000 PSI

	Stroke	Retracted Length	Rod dia.	Wt. (lb)	ITEM	PRICE
	16"	24"	1-3/4"	36.1	1200205	209.99
• 3-1/2" bore	18"	26"	1-3/4"	38.7	1200206	214.99
• #8 ORB ports	20"	28"	1-3/4"	41.4	1200207	224.99
• 1" dia. pinholes	24"	32"	1-3/4"	46.5	1200213	234.99
• Base pineye width: 4-1/4"	36"	44"	2"	66.0	1200208	279.99
• Rod pineye width: 2-1/4"	48"	56"	2"	88.3	1200209	339.99

37,699 lb push @ 3,000 PSI

	Stroke	Retracted Length	Rod dia.	Wt. (lb)	ITEM	PRICE
	8"	17"	1-1/2"	32.0	1200137	239.99
	14"	23"	1-3/4"	47.3	1200139	249.99
• 4" bore	18"	27"	1-3/4"	53.8	1204619	269.99
• #8 ORB ports	20"	29"	1-3/4"	54.0	1200233	279.99
• 1-1/4" dia. pinholes	24"	33"	1-3/4"	60.0	1204635	289.99
• Base pineye width: 4-3/4"	30"	39"	2"	80.0	1200140	329.99
• Rod pineye width: 2-3/4"	32"	42"	2"	84.0	1200234	359.99
	36"	45"	2-1/4"	99.0	1200235	389.99
	48"	57"	2-1/4"	120.0	1200142	439.99

58,904 lb push @ 3,000 PSI

	Stroke	Retracted Length	Rod dia.	Wt. (lb)	ITEM	PRICE
	24"	33"	2"	85.2	1200238	379.99
• 5" bore						
• #8 ORB ports						
• 1-1/4" dia. pinholes						
• Base pineye width: 5-3/4"	48"	57"	2-1/2"	159.0	1204700	599.99
• Rod pineye width: 2-3/4"						

shurLift® 2,500 Cylinders



MADE IN CANADA



Snap Ring Implement Cylinders

- 2,500 PSI max. continuous pressure
- Features clevis mounting ends
- 1" bore 1/8" NPT ports
- 1/2" dia. pinholes

Stroke	Retracted Length	Rod dia.	Wt. (lb)	ITEM	PRICE
4"	14-1/4"	5/8"	3.2	1200071	114.99
6"	16-1/4"	5/8"	3.8	1200072	119.99



MADE IN CANADA



Snap Ring Utility Cylinders

- 2,500 PSI max. continuous pressure
- Features cross tube mounting ends
- 1" bore 1/8" NPT ports
- 1/2" dia. pinholes
- Base pineye width: 1-1/2"
- Rod pineye width: 1-1/2"

Stroke	Retracted Length	Rod dia.	Wt. (lb)	ITEM	PRICE
4"	12"	5/8"	2.9	1200066	109.99
8"	16"	5/8"	4.0	1200068	114.99

shurLift® 3,000 Threaded Head Implement Cylinders



MADE IN CANADA



- 3,000 PSI max. continuous pressure
- Features clevis mounting ends

#6 ORB ports

	Stroke	Retracted Length	Rod dia.	Wt. (lb)	ITEM	PRICE
	6"	16-1/4"	1"	6.7	1200256	139.99
• 1-1/2" bore	8"	18-1/4"	1"	7.7	1200257	149.99
• 1" dia. pinholes	12"	22-1/4"	1"	9.8	1200259	159.99
• 2" bore						
• 1" dia. pinholes	12"	22-1/4"	1-1/4"	17.9	1200265	169.99
	8"	20-1/4"	1-1/4"	18.0	1200271	169.99
• 2-1/2" bore						
• 1" dia. pinholes	16"	26-1/4"	1-1/4"	24.5	1200275	209.99
	20"	30-1/4"	1-1/4"	27.4	1200277	229.99

#8 ORB ports

	Stroke	Retracted Length	Rod dia.	Wt. (lb)	ITEM	PRICE
	8"	20-1/4"	1-1/4"	21.8	1200280	179.99
	10"	20-1/4"	1-1/4"	22.9	1200281	189.99
	12"	22-1/4"	1-1/4"	24.8	1200282	199.99
• 3" bore						
• 1" dia. pinholes	16"	26-1/4"	1-1/4"	28.3	1200284	219.99
	18"	28-1/4"	1-1/4"	30.1	1200285	224.99
	20"	30-1/4"	1-1/2"	34.8	1200287	229.99
	24"	34-1/4"	1-1/2"	39.1	1200288	239.99
• 4" bore						
• 1" dia. pinholes	16"	26-1/4"	1-3/4"	50.7	1200303	284.99



WORK WITH US!



We are always looking for team-oriented people with a passion for delivering Royal Service.

Visit www.princessauto.com/careers to apply for any of our positions across Canada

Part-Time • Full-Time • Benefits • Opportunities • Fun



Tie Rod Hydraulic Cylinders

- 2,500 PSI max. continuous pressure
- Features clevis mounting ends



	Stroke	Retracted Length	Rod dia.	Wt. (lb)	ITEM	PRICE
• 2" bore • 3/8" NPT ports • 1" dia. pinholes	6"	18-1/4"	1-1/8"	16.3	8004980	59.99
	8"	20-1/4"	1-1/8"	18.4	1210003	64.99
	10"	21-1/4"	1-1/8"	19.2	8174864	69.99
	12"	22-1/4"	1-1/8"	20.9	8004380	74.99
	18"	28-1/4"	1-1/8"	25.5	8194987	89.99
	24"	34-1/4"	1-1/8"	39.8	8004981	99.99
• 2-1/2" bore • 3/8" NPT ports • 1" dia. pinholes	6"	18-1/4"	1-1/8"	18.4	8004983	69.99
	8"	20-1/4"	1-1/8"	20.2	1210005	74.99
	10"	21-1/4"	1-1/8"	21.7	8174872	84.99
	12"	22-1/4"	1-1/8"	23.4	8004382	89.99
	18"	28-1/4"	1-1/8"	28.8	8194995	99.99
	24"	34-1/4"	1-1/8"	33.4	8004383	114.99

	Stroke	Retracted Length	Rod dia.	Wt. (lb)	ITEM	PRICE
• 3" bore • 1/2" NPT ports • 1" dia. pinholes	8"	20-1/4"	1-1/4"	26.2	1210006	79.99
	10"	21-1/4"	1-1/4"	27.9	8174880	84.99
	12"	22-1/4"	1-1/4"	29.8	8004984	89.99
	18"	28-1/4"	1-1/4"	36.2	8195018	114.99
• 3-1/2" bore • 1/2" NPT ports • 1" dia. pinholes	8"	20-1/4"	1-1/4"	32.3	1210002	89.99
	10"	21-1/4"	1-1/4"	33.5	8174898	94.99
	12"	22-1/4"	1-1/4"	38.3	8195026	109.99
	18"	28-1/4"	1-1/4"	43.8	8195034	129.99
• 4" bore • 1/2" NPT ports • 1" dia. pinholes	8"	20-1/4"	1-1/4"	39.7	1210007	109.99
	12"	22-1/4"	1-1/4"	46.9	8195059	129.99
	18"	28-1/4"	1-1/4"	57.1	8195067	149.99
	24"	34-1/4"	1-1/2"	61.0	1210009	174.99

Category 1 Hydraulic Top Links

- Replaces the manually adjustable top link on three point hitches
 - Double piloted check valve locks cylinder in place, preventing drift
 - Bore: 2"
 - 3/4" pinholes
 - 3/8" NPT ports
- Stroke: 8.26"**
8317901 – Wt. 16.1 lb
- Stroke: 11.02"**
8317919 – Wt. 18.0 lb



2199
/ea



shurlift



Hydraulic Press Cylinder

- Use to build up to a 50 ton shop press
 - 6" bore, 10" stroke
 - 2" shaft
 - Base pineye width: 6-5/8", pinhole dia.: 1-1/4"
 - 3,600 PSI max. continuous pressure
- 1200083** – Wt. 80.3 lb

4399



Segmented Stroke Limiters

- Aluminum construction
 - Fits 1-1/8", 1-1/4", 1-3/8" and 1-1/2" dia. shafts
 - Segment thickness: 3/4", 1", 1-1/4" and 1-1/2"
- 8196263** – Wt. 1.9 lb

1699



Adjustable Stroke Limiter

- Adjustable from 2-1/8" to 5-3/16"
 - Fits 1-1/4" shaft
- 8163784** – Wt. 2.5 lb

2499

Cylinder Breather

- Applications include gear boxes, oil tanks and hydraulic cylinders
 - 7/8" hex head
 - Just a drop of oil on the screen after installation will keep dust and dirt from entering your system
- Wt. 0.1 lb
1291665 – 3/8" NPT
1291699 – 1/2" NPT
1290343 – #6 ORB
1290344 – #8 ORB

799
/ea

Male Tang Cylinder End

Use two to make a base end clevis



Dimensions	Wt. (lb)	ITEM	PRICE
1" I.D. x 3/8" thick	0.4	8001473	8.49
1" I.D. x 1/2" thick	0.7	8001474	8.99
1" I.D. x 3/4" thick	1.0	8001475	9.99
1" I.D. x 1" thick	1.4	8001476	11.99

Cylinder Thread On Clevis Ends

- 1" dia. pinhole, 1-1/8" between clevis ends
- Fits 1-1/8" Shaft**
8150047 – Wt. 3.5 lb
- Fits 1-1/4" Shaft**
8150773 – Wt. 3.2 lb
- Fits 1-1/2" Shaft**
 1" dia. pinhole, 1-1/4" between clevis ends
8150781 – Wt. 3.6 lb

1499

1999

2499



Cross Tube Cylinder Ends

Drilled for 5/16" drive-in grease nipple



Dimensions	Wt. (lb)	ITEM	PRICE
1/2" I.D. x 1-1/2" L	0.1	8183295	4.99
3/4" I.D. x 2" L	0.4	8183303	5.49
1" I.D. x 2-1/4" L	0.6	8001456	5.99
1" I.D. x 2-3/4" L	0.7	8001457	6.49
1" I.D. x 3-1/4" L	0.9	8001458	6.99
1" I.D. x 3-3/4" L	1.0	8001460	7.49
1" I.D. x 4-1/4" L	1.2	8001461	7.99
1-1/4" I.D. x 2-3/4" L*	1.5	8001469	9.99
1-1/4" I.D. x 4-3/4" L*	2.5	8001471	11.99
1-1/4" I.D. x 5-3/4" L*	3.1	8001472	13.99

* Heavy wall

Cylinder Weld On Clevis End

- 1/2" dia. pinhole, 1-1/8" between clevis ends
8183287 – Wt. 0.3 lb

899



Portable Power Systems



Hydraulic Body & Frame Repair Kits

- Hydraulic pump with swivel hose couplers and 6 ft hydraulic hose.
- Hydraulic ram features stainless steel cylinder with extra hard finish.
- "V" head, concave head, rubber head and flat head.
- Ram toe, body toe, male adapter, hydraulic duckbill spreader

4 Ton

Ram closed height: 12-1/4", extended height 17" Five 1" O.D. extension tubes (3", 5", 10", 18", and 21") with five lock pins and three snap-in connectors
1270020 – Wt. 43.2 lb **159⁹⁹**

Angle Clamp

- For use with pull back rams or frame machines
 - 1-3/4" wide x 1" deep jaw with angle cut tooth design
 - Right angle eyelet for added versatility
 - Drop forged wedge for extra durability
 - Capacity: 5 ton (in-line) 3 ton (right angle)
- 1250068** – Wt. 4.8 lb **59⁹⁹**



Hydraulic Pumps

	Oil Cap.	Max. Pressure	Overall Length	Wt. (lb)	ITEM	PRICE
4 TON	20 cu."	7,250 PSI	14-3/4"	11.6	1220987	79.99
10 TON	30 cu."	8,000 PSI	19"	11.6	1220995	79.99



10 Ton

Ram closed height 13-3/4", extended height 19-3/4" Four 1-1/2" O.D. extension tubes (4-1/2", 10", 15", and 21") with four lock pins and three snap-in connectors
1270021 – Wt. 71.7 lb **249⁹⁹**

1/2 Ton Duckbill Spreader

- Use with hydraulic lift kits or pumps
 - Max. opening: 3-1/4"
- 1270022** – Wt. 4.1 lb **29⁹⁹**



10 Ton

Hydraulic Lift Kit

- Large base feet on pump
 - Ram cylinders are made from special seamless steel tubing with smoother, harder finish
 - Spring return and safety overload valve
 - 6" stroke, closed height 13-3/4", extended height 19-3/4"
- 1270248** – Wt. 27.5 lb **199⁹⁹**

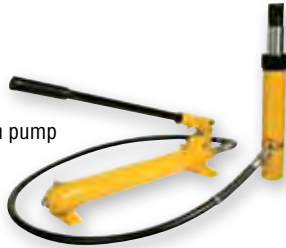

10 Ton Ram Seal Kit

1250003 – Wt. 0.1 lb **3⁹⁹**

Air / Hydraulic Pump

- Required air pressure: 90 to 175 PSI
 - Oil capacity: 140 cu. in.
 - Rated pressure: 10,000 PSI
 - Output port threads: 3/8" - 18 NPT
 - Input port threads: 1/4" - 18 NPT
- 8144958** – Wt. 21.2 lb **359⁹⁹**



6 ft High Pressure Hose

- To be used with pumps and rams
 - Fits both 4 and 10 ton models
 - Comes with male quick coupler
 - Max. pressure: 10,000 PSI
- 1294073** – Wt. 3.0 lb **29⁹⁹**



Quick Couplers

- Swivel Female 1/4" Male NPT Threads on to ram
1250008 – Wt. 0.1 lb
- 1/4" Female NPT Threads on to hose
1250009 – Wt. 0.2 lb **5⁹⁹/ea**



Cylinder Pins

Includes cotter and presto pin



Dia.	Useable length	O'all length	Wt. (lb)	ITEM	PRICE
1/2"	2-3/4"	3-1/2"	0.2	3800449	0.99
3/4"	3-1/4"	4"	0.5	3800450	1.79
1"	2-3/4"	3-1/2"	0.8	3800487	2.49
1"	3-3/4"	4-1/2"	1.0	3800451	2.79
1"	4-1/4"	5"	1.1	3800452	2.99
1"	4-3/4"	5-1/2"	1.2	3800453	3.29
1"	5-1/4"	6"	1.3	3800454	3.49
1"	5-3/4"	6-1/2"	1.4	3800456	3.79
1-1/4"	4-1/4"	5"	1.8	3800443	4.49
1-1/4"	6-1/4"	7"	2.4	3800445	5.49
1-1/4"	7-1/4"	8"	2.8	3800446	5.99

Tie Rod Cylinder Pins

- 1" dia. x 3-1/4" long
 - These pins are for our tie rod cylinders on page 245
- 8166639** – Wt. 1.5 lb **4⁹⁹/ea**



Hydraulic Cylinder Replacement Seal Kits

- Contain all the seals within each cylinder
 - Fits all shaft sizes
- 2,500 Kit**

Bore	Wt. (lb)	ITEM	PRICE
1-1/2"	0.1	1251123	11.99
2"	0.1	1251131	13.99
2-1/2"	0.1	1250058	18.99
3"	0.2	1250060	23.99
3-1/2"	0.2	1250061	24.99
4"	0.3	1250062	27.99

3,000 Kit

Bore	Wt. (lb)	ITEM	PRICE
1-1/2"	0.1	8018423	13.99
2"	0.1	8018441	16.99
2-1/2"	0.1	8018450	20.99
3"	0.2	8018478	30.99
3-1/2"	0.1	1250105	32.99
4"	0.2	1255058	33.99
5"	0.3	1255066	39.99



No sale is final until you're satisfied! We guarantee to make it right. We will repair, replace or refund any product to your satisfaction.



Hydraulic Rams

	Cap.	Closed Length	Extended Length	Stroke	Wt. (lb)	ITEM	PRICE
A	2 ton	5-1/2"	9-3/8"	3-7/8"	1.9	1200040	34.99
B	4 ton	1-3/4"	2-3/8"	5/8"	1.8	1200037	36.99
C	10 ton	5-1/4"	7-1/2"	2-1/4"	5.3	8184335	59.99
	10 ton	1.77"	2.20"	.43"	4.0	8382517	69.99
D	20 ton	2.36"	3.03"	.67"	8.6	8382525	99.99
	30 ton	2.56"	3.23"	0.7"	12.8	8382533	149.99

Hydraulic Hand Pump

- Oil cap.: .25 Gallons
- Max. pressure: 9,137 PSI
- Overall Length: 27-1/2"
- Complete with 5 ft. hose and coupler

8383481 – Wt. 19.8 lb **149.99**



Pull Back Rams

These rams are designed to be used with our hydraulic lift kit, pumps, or our hydraulic body and frame kit

	Cap.	Closed Length	Extended Length	Stroke	Wt. (lb)	ITEM	PRICE
	5 ton	20-1/2"	25-1/2"	5"	12.0	1200043	99.99
	10 ton	22-1/2"	27-1/2"	5"	18.2	8176349	149.99



shurLift

Hoist Safety Prop Kit

- Safely supports the empty raised truck box allowing access to the underbody frame and hoist assembly (Never rely only on the hoist)
- Safety props are 24.5" long and can be cut to fit most applications
- Kit includes two props that must be installed on each side of the box
- The box must always be empty when using the safety props

8317398 – Wt. 38.2 lb **199.99**



Hydraulic Hoists

- Low profile design allows for easier installation by eliminating the need to cut the dump body cross member
 - Powder coating for superior rust protection
- 6.4 Ton Hydraulic Truck Hoist Assembly**
- Installs on 8 ft to 10 ft truck bodies
 - Capacity range of 2.8 to 6.4 tons depending on frame and mounting conditions
 - Complete with a 3-1/2" bore cylinder

8298309 – Wt. 320.0 lb **899.99**

11.7 Ton Hydraulic Truck Hoist Assembly

- Installs on 8 ft to 14 ft truck bodies
- Capacity range of 3.53 to 11.76 tons depending on frame and mounting conditions
- Complete with a 4" bore cylinder

8295388 – Wt. 358.0 lb **1099.99**



Hydraulic Orbit Motors

EATON | Char-Lynn

The CHAR-LYNN 2000 Series disc valve motor is truly a high torque, low speed hydraulic motor.

- Instantly reversible
- 1-1/4" shaft, #10 ORB ports



Model No.	Displacement (Cu. In./Rev.)	Max. Cont. Pressure (PSI)	Max. Speed (RPM)	Max. Torque (In-Lb)	Wt. (lb)	ITEM	PRICE
104-4093	6.2	3,000	742	2,630	23.2	8239964	389.99
104-4094	14.9	3,000	308	5,850	25.9	8239972	399.99
104-3895	18.7	3,000	246	6,750	27.2	8179673	449.99
104-4095	24.0	2,250	191	6,840	30.0	8239980	459.99

CHAR-LYNN MOTORS offer high efficiency leak free performance.

- Instantly reversible
- 1" shafts, 1/2" NPT ports



	Model No.	Displacement (Cu. In./Rev.)	Max. Cont. Pressure (PSI)	Max. Speed (RPM)	Max. Torque (In-Lb)	Wt. (lb)	ITEM	PRICE
4-Bolt	101-3466	2.8	1,800	969	650	11.0	8179558	219.99
	101-3467	4.5	1,800	760	1,044	11.4	8179566	224.99
	101-3468	5.9	1,800	585	1,368	11.6	8179574	229.99
	101-3469	9.7	1,650	353	2,059	12.3	8179582	239.99
	101-3470	11.3	1,600	304	2,343	12.6	8179590	249.99
	101-3471	14.1	1,450	243	2,669	13.1	8179608	259.99
2-Bolt	101-3472	17.9	1,350	192	3,110	13.8	8179616	269.99
	101-3473	22.6	1,250	152	3,604	14.5	8179624	289.99
	101-3480	2.8	1,800	969	650	11.8	8179632	219.99
	101-3481	4.5	1,800	760	1,044	11.7	8179640	224.99
	101-3482	5.9	1,800	585	1,368	12.4	8179657	229.99
	101-3483	9.7	1,650	353	2,059	13.1	8179665	239.99

Gerotor Motor

- Bi-rotational
- Shaft dia.: 9/16"
- Ports: #10 ORB



Model No.	Displacement (Cu. In./Rev.)	Max. Cont. Pressure (PSI)	Max. Torque (In-Lb)	Shaft Side Load (lb)	Wt. (lb)	ITEM	PRICE
MGG20025	.58	2,000	184	70*	2.8	1220383	214.99

* Maximum permissible shaft side load @ 2,500 RPM and 1,000 PSI

ROTARY ACTUATORS

Calculating Motor Torque

$$\text{Motor Torque (In. Lb)} = \frac{\text{Pressure (PSI)} \times \text{Displacement (Cu. In./Rev.)}}{2\pi (6.28)}$$

Calculating Motor Horsepower

$$\text{Horsepower} = \frac{\text{Motor Torque (In-Lb)} \times \text{Speed (RPM)}}{63024}$$

Calculating Motor Speed

$$\text{Motor Speed (RPM)} = \frac{\text{Inlet Flow (GPM)} \times 231}{\text{Displacement (Cu. In./Rev.)}}$$

Hydraulic Hose Centre



Suction Hose

- Resistant to vacuum induced collapse which can result in pump cavitation
- Hose cover made of abrasion and weather resistant neoprene rubber
- Reinforced with 4 spirals of high-tensile yarn
- Temperature range: -40°C to 95°C (-45°F to 203°F)
- Not to be used for suctioning applications over 6 ft
- Max. continuous pressure: 250 PSI

Hose I.D.	Hose O.D.	Max. Flow (GPM)	Wt. (lb)	ITEM	PRICE /ft
3/4"	1.16"	7	0.2	8017996	3.49
1"	1.44"	12	0.5	8018030	4.99

Suction Hose

- The hose cover is a neoprene rubber with a black wrapped finish that is abrasion and weather resistant
- Reinforced with a heavy wire helix embedded between layers of synthetic textile cords
- Temperature range: -40°C to 110°C (-40°F to 230°F)
- Max. continuous pressure: 150 PSI

Hose I.D.	Hose O.D.	Max. Flow (GPM)	Wt. (lb)	ITEM	PRICE /ft
1-1/4"	1.5"	22	0.6	8150823	7.99
1-1/2"	1.97"	27	3.8	8017987	8.99

Thread Tape

- Seals all threaded valve and pipe joints
- Withstands pressures up to 10,000 PSI

Tape Size	Wt. (lb)	ITEM	PRICE
1/2" x 16 ft	0.1	1250086	0.29
1/2" x 40 ft	0.1	1250620	0.49
3/4" x 32 ft	0.1	1250087	0.49
1" x 65 ft	0.1	1250088	0.99

10 pk Thread Tape

1/2" x 40 ft
1253285 – Wt. 0.2 lb **2⁹⁹**



2-Wire Hydraulic Hose by the Foot

- Two braids of high tensile steel wire are covered with an oil- and abrasion-resistant synthetic rubber
- Temperature range: From -40°C to 100°C (-40°F to 212°F)
- Meets or exceeds the performance requirements of AS 3791 100R2AT, DIN 20022 - 2SN, EN 853 Type 2SN, ISO 1436 Type 2AT, SAE 100R2AT

Hose Size	Max. Cont. Pressure (PSI)	Min Bend Radius	Wt. (lb)	ITEM	PRICE /ft
1/4"	6,000	4.0"	0.3	8352551	1.69
3/8"	5,100	5.0"	0.4	8352569	1.89
1/2"	5,000	7.0"	0.4	8352577	2.09
3/4"	3,100	9.5"	0.6	8352585	3.59
1"	2,540	12.0"	0.9	8352593	4.59



Hydraulic Hose Safe-Sleeve

- This polypropylene sleeve can be used for protecting and bundling hose, cable and wire
- It is highly abrasion resistant and offers protection against pinhole leaks while providing good leak containment
- The smooth surface makes it very easy to slide over long lengths of hose

Inside Dia.	Wt. (lb)	ITEM	PRICE /ft
1.13"	0.1	8308538	0.79
1.33"	0.1	8308561	0.99
1.58"	0.1	8308579	1.29
2.06"	0.1	8308595	1.49

Spiral Hose Wrap

- Wraps around hydraulic and pneumatic hoses, cables, ropes and wires to provide protection and prevent premature failures
- Protects against cuts, abrasion, crushing, ultraviolet light and other hazards
- Made from high density UV resistant polyethylene
- Temperature range from -50°C (-58°F) to 80°C (176°F)

Inside Dia.	Hose Range	Length (ft)	Wt. (lb)	ITEM	PRICE
.375"	1/4" - 1/2"	25	0.8	8307936	29.99
.5"	1/2" - 11/16"	25	1.3	8307993	32.99
.65"	11/16" - 7/8"	25	2.4	8308033	33.99
.8"	7/8" - 1-1/8"	25	2.9	8308041	34.99
1.1"	1-1/8" - 1-3/8"	20	3.0	8308058	34.99
1.4"	1-3/8" - 1-5/8"	12	2.7	8308066	34.99
1.7"	1-5/8" - 2-3/16"	10	3.6	8308074	34.99



PRINCESS AUTO IS PROUD TO OFFER



FREE HOSE CUTTING, CRIMPING & CLEANING *

* For all hydraulic hose and fittings purchased from Princess Auto.

25 pk Low Density Polyethylene Hose Plugs and Caps

Use to cap or plug hydraulic hose ends or components to prevent contaminant ingress

Size	Wt. (lb)	ITEM	PRICE
1/4"	0.1	8077877	3.49
3/8"	0.1	8077927	3.99
1/2"	0.1	8077976	4.59
3/4"	0.1	8078008	6.19

Plugs

Size	Wt. (lb)	ITEM	PRICE
1/4"	0.1	8077828	3.19
3/8"	0.1	8077901	3.59
1/2"	0.1	8077950	4.09
3/4"	0.1	8077984	5.29
1"	0.1	8078016	6.69

RECOMMENDED HOSE SIZES (I.D.)

Pump Flow (GPM)	Pressure Line (Velocity 15 - 25 ft/sec.)	Return Line (Velocity 10 - 12 ft/sec.)	Suction Line (Velocity 2 - 5 ft/sec.)
5	3/8"	1/2"	3/4" to 1"
10	1/2" to 5/8"	3/4"	1" to 1-1/4"
15	5/8" to 3/4"	1"	1-1/2" to 2"
20	3/4" to 1"	1" to 1-1/4"	2"



QUALITY HOSE & FITTINGS



HOSE

With a commitment to quality and product development, RYCO designs and manufactures an extensive range of hydraulic hose that performs at higher working pressures.



COUPLINGS

RYCO's manufactures the widest range of thread and connection types available on the market. RYCO Hose couplings are designed to match with RYCO Hose series.



KNOW HOW

RYCO offers a broad range of modular training solutions to meet the needs of the hydraulic industry. With safety a priority RYCO training equips you with the knowledge and confidence you need.

www.ryco.com.au

Bite-To-Wire Hose Menders



Hose I.D.	Wt. (lb)	ITEM	PRICE
3/8"	0.2	8077133	12.99
1/2"	0.4	8077141	14.99

Pressure Washer Bite-To-Wire Fittings
Swivel female, 22 mm
Wt. 0.2 lb



Hose I.D.	ITEM	PRICE
1/4"	8190746	19.99
3/8"	8190753	21.99

JIC 37° Bite-To-Wire Fittings



Hose I.D.	End Size	M) Rigid Male			N) Swivel Female		
		Wt. (lb)	ITEM	PRICE	Wt. (lb)	ITEM	PRICE
1/4"	1/4"	0.3	1290285	4.99	0.1	1290294	5.99
1/4"	5/16"	-	-	-	0.2	1290296	5.99
1/4"	3/8"	0.1	1290362	5.99	0.2	1290297	5.99
3/8"	3/8"	0.2	1290288	5.99	0.2	1290298	5.99
3/8"	1/2"	0.2	1290289	5.99	0.2	1290299	5.99
1/2"	1/2"	0.2	1290290	6.99	0.2	1290300	7.99
1/2"	5/8"	0.3	1290291	7.99	0.3	1290301	8.99
1/2"	3/4"	0.4	1290371	11.99	0.4	1290369	12.99
3/4"	3/4"	0.4	1290292	9.99	0.5	1290302	11.99
3/4"	1"	0.5	8109761	13.99	0.6	1290304	15.99
1"	1"	0.6	1290293	15.99	0.7	1290305	15.99

Hose Ends

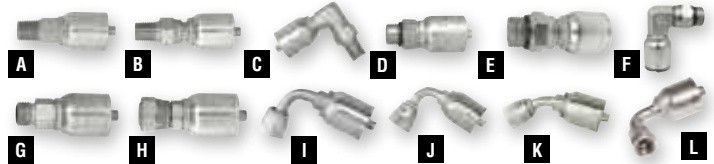

NPT Male Bite-to-Wire Fittings

Hose I.D.	End Size	A) Rigid Male			B) Swivel Male			C) 90° Swivel Male		
		Wt. (lb)	ITEM	PRICE	Wt. (lb)	ITEM	PRICE	Wt. (lb)	ITEM	PRICE
1/4"	1/8"	0.1	1290240	4.99	-	-	-	-	-	-
1/4"	1/4"	0.1	1290241	4.99	0.2	1290255	7.99	0.2	8077109	12.99
1/4"	3/8"	0.1	1290242	4.99	0.2	1290256	7.99	-	-	-
1/4"	1/2"	0.2	1290243	9.99	-	-	-	-	-	-
3/8"	1/4"	0.2	1290244	4.99	-	-	-	-	-	-
3/8"	3/8"	0.2	1290245	4.99	0.2	1290257	8.99	0.3	8077117	13.99
3/8"	1/2"	0.2	8357360	4.99	0.3	1290258	8.99	-	-	-
1/2"	3/8"	0.2	1290248	5.99	0.3	8050502	10.99	-	-	-
1/2"	1/2"	0.3	1290249	4.99	0.3	1290259	10.99	0.5	8077125	14.99
3/4"	3/4"	0.4	1290251	9.99	0.5	1290260	13.99	-	-	-
1"	1"	0.8	1290252	13.99	1.0	1290262	24.99	-	-	-

O-Ring Boss Male Bite-To-Wire Fittings

Hose I.D.	End Size	D) Rigid			E) Swivel			F) 90° Swivel		
		Wt. (lb)	ITEM	PRICE	Wt. (lb)	ITEM	PRICE	Wt. (lb)	ITEM	PRICE
1/4"	#6	0.1	1290270	5.99	-	-	-	-	-	-
3/8"	#6	0.2	1290272	6.99	-	-	-	-	-	-
3/8"	#8	0.2	1290273	6.99	0.3	1290282	10.99	0.4	1290367	17.99
1/2"	#8	0.3	1290274	7.99	0.4	1290283	11.99	0.5	1290358	18.99
1/2"	#10	0.3	1290275	8.99	0.4	1290284	12.99	0.5	1290359	19.99
3/4"	#12	0.4	1290361	13.99	-	-	-	-	-	-

O-Ring Face Seal Bite-To-Wire Fittings

Hose I.D.	End Size	G) Rigid Male			H) Swivel Female			I) 90° Swivel Female		
		Wt. (lb)	ITEM	PRICE	Wt. (lb)	ITEM	PRICE	Wt. (lb)	ITEM	PRICE
1/4"	#4	-	-	-	0.1	8046642	7.99	-	-	-
3/8"	#6	0.2	8046624	8.99	0.2	8046651	8.99	0.2	8106445	18.99
1/2"	#8	0.2	8046633	9.99	0.3	8046660	9.99	0.4	8106452	19.99
3/4"	#12	-	-	-	0.5	8046679	14.99	-	-	-

JIC 37° Female Elbows Bite-To-Wire Fittings

Hose I.D.	End Size	J) 90° Swivel			K) 45° Swivel			L) 90° Long Swivel		
		Wt. (lb)	ITEM	PRICE	Wt. (lb)	ITEM	PRICE	Wt. (lb)	ITEM	PRICE
1/4"	1/4"	0.1	1290307	11.99	-	-	-	-	-	-
1/4"	3/8"	0.2	1290308	11.99	-	-	-	-	-	-
3/8"	3/8"	0.2	1290309	12.99	0.2	1290318	10.99	0.2	1290325	16.99
3/8"	1/2"	0.3	1290310	13.99	-	-	-	-	-	-
1/2"	1/2"	0.3	1290312	13.99	0.3	1290320	12.99	0.4	1290326	18.99
1/2"	5/8"	0.5	1290313	16.99	0.4	1290321	17.99	-	-	-
3/4"	3/4"	0.7	1290314	23.99	0.6	1290322	23.99	0.8	1290327	24.99
1"	1"	1.1	1290315	34.99	-	-	-	-	-	-

NPT Fittings



NPT Female Bite-to-Wire Fittings



Hose I.D.	End Size	A) Rigid Female			B) Swivel Female		
		Wt. (lb)	ITEM	PRICE	Wt. (lb)	ITEM	PRICE
1/4"	1/4"	0.1	1290266	5.99	0.1	1290263	6.99
3/8"	3/8"	0.2	1290267	5.99	0.2	1290264	7.99
1/2"	1/2"	0.3	1290268	7.99	0.3	1290265	9.99
3/4"	3/4"	0.5	8006624	10.99	0.5	8006627	13.99
1"	1"	-	-	-	0.7	8187569	22.99

No Crimp Hose Fittings

- Designed for in-field installation
- Max. continuous pressure: 6,000 PSI

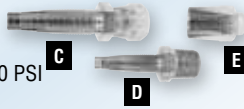

Hose I.D.	End Size	C) Swivel Female JIC			D) Fixed Male NPT		
		Wt. (lb)	ITEM	PRICE	Wt. (lb)	ITEM	PRICE
1/4"	1/4"	0.2	1294891	3.99	0.2	1291442	3.99
3/8"	3/8"	0.3	1294909	4.99	0.3	1291509	4.99
1/2"	1/2"	0.4	1294917	5.99	0.4	1291517	5.99

Ferrules

Hose I.D.	End Size	E) For 1-Wire Hose			E) For 2-Wire Hose		
		Wt. (lb)	ITEM	PRICE	Wt. (lb)	ITEM	PRICE
1/4"		0.5	8357022	4.99	0.4	8358723	4.99
3/8"		0.4	8358681	5.99	0.2	8358715	5.99
1/2"		0.2	8358566	7.99	0.5	8358368	7.99

NPT Basic Swivel Fittings



Thread Size	F) Coupler			G) Coupler			H) 90° Elbow			I) Caps		
	Wt. (lb)	ITEM	PRICE	Wt. (lb)	ITEM	PRICE	Wt. (lb)	ITEM	PRICE	Wt. (lb)	ITEM	PRICE
1/8"	0.1	1291871	1.99	-	-	-	0.1	1290062	3.49	-	-	-
1/4"	0.1	1291889	2.49	0.1	1292036	2.99	0.1	1292101	3.99	0.1	8238701	1.79
3/8"	0.1	1291913	2.99	0.2	1292044	3.49	0.3	8058120	5.99	0.1	8238719	2.09
1/2"	0.2	1291947	3.99	0.2	1292077	5.49	0.3	1292150	5.99	0.1	8238727	2.49
3/4"	0.3	1291962	5.99	0.4	8058530	5.99	0.5	1292184	9.99	0.2	8238735	3.99
1"	0.5	1291970	8.99	-	-	-	0.8	1292192	15.99	-	-	-

Thread Size	J) 90° Elbow			K) 45° Elbow			L) Tee		
	Wt. (lb)	ITEM	PRICE	Wt. (lb)	ITEM	PRICE	Wt. (lb)	ITEM	PRICE
1/4"	-	-	-	0.1	1292218	4.99	0.2	8059156	7.99
3/8"	-	-	-	0.1	1292226	5.99	0.3	1293166	8.99
1/2"	0.4	8058772	6.99	0.3	1292242	6.99	0.4	1293174	9.99



NPT Basic Fittings

Thread Size	M) Coupler			N) Plug			O) Counter Sunk Plug			P) 90° ELBOW		
	Wt. (lb)	ITEM	PRICE	Wt. (lb)	ITEM	PRICE	Wt. (lb)	ITEM	PRICE	Wt. (lb)	ITEM	PRICE
1/8"	0.1	8092447	1.49	-	-	-	-	-	-	0.1	8092462	2.49
1/4"	0.1	8058219	2.99	0.1	8059058	1.49	-	-	-	0.1	8059110	3.99
3/8"	0.1	8058237	2.99	0.1	8059067	1.69	0.1	8133407	1.99	0.2	8059129	4.99
1/2"	0.2	8058308	3.99	0.1	1291624	1.99	0.1	8133464	1.99	0.3	1291806	5.99
3/4"	0.3	1292770	5.99	0.2	1291632	2.99	0.1	8133506	2.99	0.5	1291822	8.99

Thread Size	Q) Branch Tee			R) Street Tee			S) Tee			T) 90° Elbow			U) 90° Elbow			V) Nipple		
	Wt. (lb)	ITEM	PRICE	Wt. (lb)	ITEM	PRICE	Wt. (lb)	ITEM	PRICE	Wt. (lb)	ITEM	PRICE	Wt. (lb)	ITEM	PRICE	Wt. (lb)	ITEM	PRICE
1/8" NPT	-	-	-	0.1	8092512	2.99	-	-	-	0.1	8092496	2.49	-	-	-	0.1	8092439	1.29
1/4" NPT	0.4	8058727	5.99	0.4	8058754	4.99	0.3	8058692	4.99	0.1	1292788	3.99	0.2	8058549	3.99	0.1	8058102	1.99
3/8" NPT	0.4	8058736	7.49	0.2	1293018	5.99	0.3	8058709	6.99	0.2	1292796	4.99	0.2	8058567	4.99	0.1	1291715	1.99
1/2" NPT	0.4	8058745	11.99	0.5	1293026	8.99	0.3	8058718	9.99	0.3	1292804	6.99	0.3	8058647	6.99	0.2	8058111	2.99
3/4" NPT	0.7	1290066	15.99	0.6	8058763	14.99	0.8	8058488	14.99	0.5	1292812	11.99	0.4	8058656	9.99	0.2	8059101	3.49
1" NPT	-	-	-	-	-	-	-	-	-	-	-	-	-	-	-	0.4	8092546	4.49

NPT Size Adapters



Thread Size	W) Nipple			X) Coupler			Y) Reducer (M x F)			Z) 90° Elbow			1) 90° Elbow (M x F)		
	Wt. (lb)	ITEM	PRICE	Wt. (lb)	ITEM	PRICE	Wt. (lb)	ITEM	PRICE	Wt. (lb)	ITEM	PRICE	Wt. (lb)	ITEM	PRICE
1/8" x 1/4"	-	-	-	-	-	-	0.1	1291830	2.99	-	-	-	0.1	8098196	3.99
1/4" x 1/8"	0.1	8059076	1.99	0.1	8058665	3.99	0.1	8092454	2.99	-	-	-	-	-	-
3/8" x 1/4"	0.1	8059085	1.99	0.1	8058683	3.99	0.1	1291863	3.99	0.2	1291772	4.99	-	-	-
1/2" x 3/8"	0.2	1291723	2.49	0.3	1292747	5.99	0.2	1292002	4.99	0.3	1291798	5.99	-	-	-
3/4" x 1/2"	0.3	8059094	3.99	0.4	1292762	6.99	0.4	1292028	6.99	0.5	1291814	8.99	-	-	-
1" x 3/4"	-	-	-	-	-	-	0.8	8057979	9.99	-	-	-	-	-	-

NPT Male x Female Bushings



Thread Size	Wt. (lb)	ITEM	PRICE
3/8" x 1/4"	0.1	1294727	1.49
3/8" x 1/8"	0.1	8058843	1.79
1/2" x 1/4"	0.1	1294735	1.99
1/2" x 3/8"	0.1	1294743	1.99
3/4" x 3/8"	0.2	1294750	2.99
3/4" x 1/2"	0.1	8058317	3.99
1" x 1/2"	0.3	8058852	4.49
1" x 3/4"	0.2	1294776	4.99
1-1/4" x 3/4"	0.7	8106221	5.99
1-1/4" x 1"	0.4	8092538	5.99
1-1/2" x 3/4"	1.0	8109753	10.99
1-1/2" x 1-1/4"	0.6	8092520	11.99

NPT Swivel Size Adapters



Male x Female Thread Size	Coupler			
	Wt. (lb)	ITEM	PRICE	
1/8" x 1/4"	0.1	1294099	2.99	
3/8" x 1/4"	0.2	8058503	2.99	
3/8" x 1/2"	0.2	8058521	3.99	
1/2" x 3/8"	0.2	1291939	4.99	
1/2" x 3/4"	0.3	1291954	5.99	
3/4" x 1/2"	0.3	1294107	6.99	

Male x Female Thread Size	90° Elbow			
	Wt. (lb)	ITEM	PRICE	
1/4" x 3/8"	0.2	1292119	5.49	
3/8" x 1/4"	0.2	1290065	4.99	
1/2" x 3/4"	0.5	1292168	9.99	
3/4" x 1/2"	0.5	1292176	9.99	

Magnetic Plugs



- Square head design
- Used to protect hydraulic systems by magnetically collecting ferrous particles

Size (NPT)	Wt. (lb)	ITEM	PRICE
1/2"	0.1	1293679	3.99
3/4"	0.2	1293687	3.99



1/4 NPTM x 1/4 NPTM 90° Swivel Coupler
8252637 - Wt. 0.1 lb..... **6⁹⁹**



O-Ring Boss Basic Fittings



Thread Size	A) Plug			B) Coupler		
	Wt. (lb)	ITEM	PRICE	Wt. (lb)	ITEM	PRICE
#4	0.2	8059165	1.79	-	-	-
#5	0.1	8059174	1.99	-	-	-
#6	0.1	1291491	1.99	-	-	-
#8	0.1	8058095	2.49	0.2	8145187	4.99
#10	0.2	8059049	2.99	-	-	-

O-Ring Boss Size Adapters

Male x female



Thread Size	Wt. (lb)	ITEM	PRICE
#6 x #8	0.2	8017861	7.99
#8 x #10	0.2	8017870	7.99
#10 x #8	0.2	8058870	7.99
#12 x #10	0.3	8058898	8.99
#16 x #12	0.5	8058905	9.99

JIC 37° Basic Fittings



Thread Size	C) Plug			D) Cap			E) Coupler			F) 90° Elbow			G) Bulkhead			H) Tee		
	Wt. (lb)	ITEM	PRICE	Wt. (lb)	ITEM	PRICE	Wt. (lb)	ITEM	PRICE	Wt. (lb)	ITEM	PRICE	Wt. (lb)	ITEM	PRICE	Wt. (lb)	ITEM	PRICE
1/4"	-	-	-	0.1	1293844	1.39	0.1	8098204	1.59	-	-	-	-	-	-	-	-	-
5/16"	0.1	8059192	1.99	0.1	1293851	1.49	0.1	1293927	1.79	-	-	-	-	-	-	-	-	-
3/8"	-	-	-	0.1	1293869	1.59	0.1	1293935	1.89	0.1	8217424	4.99	0.1	8088411	3.99	0.1	8088510	3.99
1/2"	-	-	-	0.1	1293877	1.69	-	-	-	0.2	8217432	5.99	0.3	8088569	4.99	0.3	8088528	4.99
5/8"	0.1	8059209	2.49	0.1	1293885	2.29	0.2	1293968	2.99	-	-	-	0.4	8088585	5.99	-	-	-
3/4"	0.2	1293778	2.99	0.2	1293893	2.59	0.3	1293976	3.99	-	-	-	-	-	-	-	-	-
1"	0.3	1293836	4.49	0.3	1293901	4.59	-	-	-	-	-	-	-	-	-	-	-	-

JIC 37° Basic Swivel Fittings



Thread Size	I) 90° Elbow			J) Tee (2 M x F)			K) Coupler		
	Wt. (lb)	ITEM	PRICE	Wt. (lb)	ITEM	PRICE	Wt. (lb)	ITEM	PRICE
1/4"	0.1	8217473	4.99	-	-	-	-	-	-
5/16"	0.1	8217481	4.69	-	-	-	-	-	-
3/8"	0.1	8217499	5.49	0.1	8217630	3.99	0.1	8217549	3.49
1/2"	0.2	8217507	5.69	0.3	8217655	4.99	0.2	8217598	4.49
5/8"	0.3	8217515	7.49	-	-	-	0.2	8217606	5.49
3/4"	0.6	8217523	9.49	-	-	-	-	-	-

JIC 37° Size Adapters



Thread Size	L) Coupler (M x F)			M) Nipple		
	Wt. (lb)	ITEM	PRICE	Wt. (lb)	ITEM	PRICE
3/8" x 1/2"	0.1	8120032	3.99	0.1	8088452	2.99
1/2" x 5/8"	0.2	8120206	4.49	0.2	8088494	3.69
5/8" x 3/4"	0.2	8120214	6.49	-	-	-
1/2" x 3/8"	0.1	8120263	2.79	-	-	-
5/8" x 1/2"	0.1	8120289	2.99	-	-	-
3/4" x 5/8"	0.2	8120297	4.49	-	-	-

Threaded Type Adaptor Fittings

JIC 37° x O-Ring Boss Adapters



Thread Size (JIC x ORB)	A) Coupler			B) 90° Elbow			C) Long Elbow		
	Wt. (lb)	ITEM	PRICE	Wt. (lb)	ITEM	PRICE	Wt. (lb)	ITEM	PRICE
1/4" x #4	0.1	1294792	1.99	-	-	-	-	-	-
1/4" x #6	0.1	8163362	1.79	0.1	8163388	3.99	-	-	-
3/8" x #4	0.1	8163354	1.79	0.1	8163370	3.99	-	-	-
3/8" x #6	0.1	1294800	1.99	-	-	-	0.3	8000727	8.99
3/8" x #8	0.1	8006363	1.79	0.3	8088353	4.89	-	-	-
3/8" x #10	0.2	8006366	2.99	-	-	-	-	-	-
1/2" x #6	0.1	8006362	1.99	0.2	8006378	4.99	-	-	-
1/2" x #8	0.1	1294818	1.99	-	-	-	0.4	8000704	11.99
1/2" x #10	0.2	8045340	2.99	0.4	8006370	6.79	-	-	-
1/2" x #12	0.3	8006367	3.99	-	-	-	-	-	-
5/8" x #8	0.2	8088445	4.99	-	-	-	-	-	-
5/8" x #10	0.2	1294826	4.79	0.4	1294875	8.79	-	-	-
5/8" x #12	0.3	8006368	4.99	-	-	-	-	-	-
3/4" x #12	0.2	1294834	4.99	-	-	-	-	-	-

O-Ring Boss x NPT Swivel Adapters Male x Female



Thread Size (ORB x NPT)	D) Coupler			E) 45° Elbow			F) 90° Elbow		
	Wt. (lb)	ITEM	PRICE	Wt. (lb)	ITEM	PRICE	Wt. (lb)	ITEM	PRICE
#4 x 1/4"	0.1	1292291	2.99	-	-	-	-	-	-
#5 x 1/4"	0.1	8059218	3.99	-	-	-	-	-	-
#6 x 1/4"	0.1	1292309	3.79	-	-	-	0.1	8032791	6.99
#6 x 3/8"	0.1	1292317	3.99	-	-	-	0.2	8058139	6.99
#6 x 1/2"	0.1	8001420	4.99	-	-	-	0.1	8001418	8.99
#8 x 1/4"	0.1	8058996	4.99	-	-	-	-	-	-
#8 x 3/8"	-	-	-	-	-	-	0.3	1292424	8.99
#8 x 1/2"	0.2	1292333	4.99	0.3	8192064	5.99	-	-	-
#10 x 3/8"	-	-	-	-	-	-	0.4	8059147	9.99
#10 x 1/2"	0.1	1290006	4.99	0.3	8192072	6.99	0.4	1292457	9.99
#10 x 3/4"	0.2	1292358	6.99	-	-	-	-	-	-
#12 x 1/2"	0.3	8220188	7.99	-	-	-	0.6	8220196	10.99
#12 x 3/4"	0.3	1294412	7.69	-	-	-	0.7	8000705	11.99
#16 x 1"	0.5	1295310	9.99	-	-	-	1.0	8059003	14.99

O-Ring Boss x JIC 37° Swivel Adapters



Thread Size (ORB x JIC)	Male x Female		
	Wt. (lb)	ITEM	PRICE
#6 x 3/8"	0.1	1290017	4.99
#8 x 1/2"	0.2	1290019	5.79
#10 x 5/8"	0.3	1290020	5.99

JIC 37° x Metric Adapters



Thread Size (JIC x Metric)	Wt. (lb)	ITEM	PRICE
3/8" x 14 mm	0.1	8120628	4.99
3/8" x 16 mm	0.1	8120636	5.99
1/2" x 18 mm	0.1	8120651	5.99
1/2" x 22 mm	0.1	8120677	6.99

O-Ring Boss x NPT Adapters



Thread Size (ORB x NPT)	G) Male x Male			H) Male x Female		
	Wt. (lb)	ITEM	PRICE	Wt. (lb)	ITEM	PRICE
#6 x 1/4"	0.1	1293299	3.79	0.8	8017692	6.99
#6 x 3/8"	1.0	8058781	3.69	0.1	8017745	6.99
#6 x 1/2"	-	-	-	0.1	8017754	6.99
#8 x 3/8"	-	-	-	0.2	8017763	7.99
#8 x 1/2"	0.1	1293323	3.99	0.2	8017772	7.99
#10 x 1/2"	-	-	-	0.8	8017781	7.99
#12 x 3/4"	0.3	1293513	6.99	0.4	8017807	9.99

JIC 37° x NPT Adapters



Thread Size (JIC x NPT)	I) 90° Elbow			J) Coupler		
	Wt. (lb)	ITEM	PRICE	Wt. (lb)	ITEM	PRICE
1/4" x 1/4"	-	-	-	0.1	1293422	1.79
5/16" x 1/4"	-	-	-	0.1	1293430	1.99
3/8" x 1/4"	0.8	8032345	3.99	0.1	8088544	2.49
3/8" x 3/8"	-	-	-	0.1	1293448	2.39
3/8" x 1/2"	0.3	8058834	4.99	0.1	1294024	2.79
1/2" x 3/8"	0.2	8163404	4.99	0.1	8163396	2.79
1/2" x 1/2"	-	-	-	0.1	1293455	2.99
5/8" x 1/2"	0.3	1295039	5.99	0.2	8058807	3.69
3/4" x 3/4"	0.5	1295054	7.99	-	-	-
1" x 1"	-	-	-	0.3	8058816	5.99

NPT x JIC 37° Swivel Adapters



Thread Size (NPT x JIC)	Male x Female		
	Wt. (lb)	ITEM	PRICE
1/4" x 1/4"	0.1	8058335	3.99
1/4" x 3/8"	0.1	8058344	4.99
3/8" x 3/8"	0.1	8058380	4.99
3/8" x 1/2"	0.2	8058399	5.99
1/2" x 1/2"	0.2	8058406	6.99
1/2" x 5/8"	0.3	8058442	7.99
1/2" x 3/4"	0.3	1290031	8.99
3/4" x 3/4"	0.4	8058460	9.99

Cylinder Port Converters



Thread Size (ORB x NPT)	Wt. (lb)	ITEM	PRICE
#6 x 1/4"	0.1	8059021	2.99
#6 x 3/8"	0.1	1290347	2.99
#8 x 3/8"	0.1	1290348	3.79
#8 x 1/2"	0.2	1290349	3.99
#10 x 1/2"	0.3	1290350	4.99
#10 x 3/4"	0.1	8059030	5.99
#12 x 1/2"	0.4	1290353	6.99



Pioneer Quick Couplers

- Connects and disconnects quickly creating a positive seal
- Max. pressure: 3,000 PSI

Size	Max. Flow	Wt. (lb)	ITEM	PRICE
1/4"	3 GPM	0.4	8003325	19.99
3/8"	6 GPM	0.7	8003332	21.99
1/2"	12 GPM	0.8	8003336	23.99



Pioneer 1-Hand Quick Coupler

- Push to connect, pull to separate (under pressure conditions)
- 1/2" NPT male and female
- Max. pressure: 3,000 PSI, max. flow: 12 GPM

8003337 - Wt. 0.9 lb **39⁹⁹**



5 pk Replacement Seals for 1/2" Coupler Bodies

Nitrile composition
8003339 - Wt. 0.1 lb **7⁹⁹**



Replacement O-Rings

10 per package
O-Ring Boss

Size	Wt. (lb)	ITEM	PRICE
#6	0.1	8078990	3.99
#8	0.1	8079014	4.99
#10	0.1	8079048	4.99
#12	0.1	8079063	5.99

O-Ring Face Seal

Size	Wt. (lb)	ITEM	PRICE
#4	0.1	8079105	6.49

125 pc Replacement O-Ring Kit for ORB Fittings
8080913 - Wt. 0.4 lb **14⁹⁹**

MEMBER OF THE
FLUID POWER
SOCIETY



Quick Couplers



Hydraulic Quick Couplers

- Poppet style for less leakage
- Carbon steel construction with zinc plating

	Size	Max Pressure (PSI)	GPM @ 15 PSI (ΔP)	Wt. (lb)	ITEM	PRICE
A	1/4" Tip	4,350	1.6	0.2	8350787	5.99
	3/8" Tip	4,350	6.3	0.2	8350811	5.99
	1/2" tip	3,625	10	0.3	8350845	6.49
	3/4" Tip	3,625	20	0.5	8350886	12.99
B	1/4" Body	4,350	1.6	0.3	8350795	9.99
	3/8" Body	4350	6.3	0.6	8350829	12.99
	1/2" Body	3,625	10	0.6	8350852	13.99
	3/4" Body	3,625	20	1.6	8350878	25.99



Connect Under Pressure Quick Couplers

- Will connect by hand with residual pressure up to 4350 PSI locked in the hydraulic circuit
- Connects without releasing any fluid into the environment

• Applications include mobile equipment & attachment tools where the sun or temperature change causes high pressure to develop due to thermal expansion of the trapped fluid

Wt. 1.0 lb
C) 8351637 - 1/2" NPT Tip **36⁹⁹**
D) 8351322 - 1/2" NPT Body **49⁹⁹**

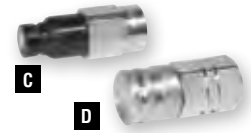

John Deere Male Tip

• Fits John Deere sleeve type female bodies
• #8 ORB female threading
8058133 - Wt. 0.2 lb **13⁹⁹**



Pioneer Female x John Deere Male Adapter

Adapts 1/2" Pioneer male to 1/2" John Deere female
8003528 - Wt. 0.5 lb **22⁹⁹**



Double Breakaway Clamp

• For 1/2" or 3/4" quick couplings
• Prevents hose breakage by automatically uncoupling lines when implement is disconnected accidentally
1293224 - Wt. 0.8 lb **16⁹⁹**



DUST CAPS & PLUGS

Installing dust caps and plugs on your quick couplers will prevent dirt ingress into your hydraulic system and prevent possible damage to your hydraulic components.



G - FOR COUPLER TIP

Quick Coupler Dust Caps And Plugs

- Prevents dust, water and other contaminants from entering the quick coupling
- Made of a durable PVC / Rubber composition



	Style	Size	Wt. (lb)	ITEM	PRICE
G	Standard	1/4"	0.1	8350944	1.99
	Standard	3/8"	0.1	8350951	1.99
	Standard	1/2"	0.1	8350969	1.99
H	Standard	1/4"	0.1	8350902	1.99
	Standard	3/8"	0.1	8350910	1.99
	Standard	1/2"	0.1	8350928	1.99



Flat Face Quick Coupler Dust Cap and Plug

• Prevents dust, water and other contaminants from entering the quick coupling
• Made of a durable PVC / Rubber composition
Wt. 0.1 lb
I) 8350977 - 1/2" Tip Cap **1⁹⁹**
J) 8350936 - 1/2" Body Plug **1⁹⁹** /ea

Hydraulic Pumps

Haldex

A) Haldex 2-Stage Pumps

Ideal for log splitters, presses, & trash compactors

- Shaft: 1/2" dia. x 1-1/2" long
- Mount: 4-bolt
- Ports: 1" tube inlet, 1/2" NPTF outlet
- Rotation: clockwise
- Max. continuous pressure: 3,000 PSI
- Adjustable unloader range: 400 to 900 PSI, set @ 650 PSI
- 500 to 4,000 RPM range

B) Haldex Pumps / Motors

- These compact pumps/motors are built with cast iron bodies and hardened steel gears
- Suitable for use in agriculture, construction, and material handling
- Bi-rotational, 1/2" shaft, 1-1/2" long, 4-bolt flange with 1-3/4" pilot flange
- #4 ORB case drain port must be returned to tank when used as a motor if the return line pressure exceeds 50 PSI
- Can be belt driven with a max. sideload of 150 lb

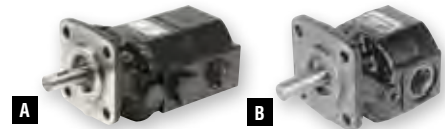

Gear Displacement		Flow		HP Required	Wt. (lb)	ITEM	PRICE
Low Pressure	High Pressure	Low	High				
0.517 cu. in.	0.194 cu. in.	10.6 GPM	2.9 GPM	5 HP	8.4	1221118	189.99
0.776 cu. in.	0.258 cu. in.	16.0 GPM	4.0 GPM	8 HP	9.4	1221555	199.99
0.930 cu. in.	0.465 cu. in.	22.0 GPM	6.1 GPM	16 HP	19.0	1222173*	499.99

*Mount: 2-bolt SAE • Shaft: 5/8" dia. • Ports: 1" NPTF tube inlet, 3/4" NPTF outlet • Adjustable unloader range: 400 to 700 PSI

Displ. (Cu. In./Rev.)	Pressure (PSI)		Flow (GPM)		Port Size (ORB)	Wt. (lb)	ITEM	PRICE
	Cont.	Intermittent	@ 1,800 RPM	@ 3,600 RPM				
0.129	3,000	4,000	1	2	8	4.6	1220030	179.99
0.258	2,300	4,000	2	4	8	4.6	1220031	179.99
0.388	1,600	2,500	3	6	10	5.5	1220032	179.99
0.517	1,200	2,000	4	8	10	5.5	1220033	179.99



PTO Pumps

- Ideal for use with front end loaders on tractors without integral hydraulics, landscape equipment and backhoes. Slips onto tractor P.T.O. shaft, no gearbox required.
- Self-adjusting wear plates on both sides of the gears offset wear and expansion
- #16 ORB inlet and #12 ORB outlet ports
- 1-3/8" dia., 6-tooth internal splined drive shaft



Displ. (Cu. In./Rev.)	Max Pres. (PSI)	Flow @ 540 RPM @ 2,000 PSI	Wt. (lb)	ITEM	PRICE
5.7	2,250	11.4 GPM	35.9	8005268	629.99
9.9	2,250	21 GPM	41.6	8005213	659.99

Replacement Breather Cap

1252923
Wt. 0.1 lb..... **799**



Williams

Birotational High Pressure Piston Pump

- This self-contained power unit is suited to a wide range of applications including hoists, presses and dump trucks
- Built-in pressure relief
- High contamination tolerance
- Double acting control valve with 3/8" NPT ports
- 1" shaft (with 1/2" woodruff key)
- Pressures up to 5,000 PSI*



Model No.	Displ. Cu./In./Rev.	Min. Max. RPMs	GPM @ Max RPM	Relief Valve Setting (PSI)	Reservoir (gal.)	Wt. (lb)	ITEM	PRICE
F98-4-21*	2.6	300-1,300	13.2	3,000	5.25	77.5	1220045	999.99

Got a question

about one of our products?

Post a customer review at princessauto.com! We'll answer the question for your benefit and for other guests.

CALCULATING PUMP FLOW

Step 1

$$\text{Gallons per Minute (GPM)} = \frac{\text{Pump Displacement (Cu. In. / Rev.)} \times \text{RPM}}{231}$$

Step 2

$$\text{HP to Drive Pump} = \frac{\text{Flow (GPM)} \times \text{Pressure (PSI)}}{1714} \times .90$$

PEAK VS NET HORSEPOWER RATINGS

Princess Auto advertises our engines in peak or gross horsepower which is different than actual net HP ratings.

The net horsepower is defined as the measured output of the engine at the crankshaft end which would also be defined as the true horsepower of the engine.

The peak or gross horsepower would be the horsepower the engine would produce working at peak efficiency in relatively idealistic atmospheric conditions.

In all cases the net horsepower should be less than the peak / gross horsepower.

AC Power Packs



2 HP Electric Power Pack

- With reservoir and valve
- Ideal for presses and compactors



Voltage (VAC)	Max. Cont. Pressure (PSI)	Max. Cont. Flow (GPM)	Ports	Reservoir (gal.)	Wt. (lb)	ITEM	PRICE
115/230	2,200	1.75	3/8" NPT	1.75	97.4	1270099	899.99

Electric C-Face Motor Brackets

	Frame Size	Pump Mount Type	Wt. (lb)	ITEM	PRICE
A	56C, 56HC	2-Bolt SAE Type A	2.4	8009335	34.99
B	184TC	2-Bolt SAE Type A	4.9	8009353	44.99
C	56C, 56HC	4 Bolt / SAE AA	2.6	8352973	54.99

Gas Engine Bracket

	Horse Power	Pump Mount Type	Wt. (lb)	ITEM	PRICE
D	5	2-Bolt SAE Type A	1.9	8009308	34.99
E	5	2-Bolt SAE Type AA	1.9	8173700	59.99
F	8 to 20	2-Bolt SAE Type A	3.8	8001759	49.99
G	8 to 20	4-Bolt + SAE Type AA	3.8	2400003	49.99

Pump Brackets

	Mount Style	Pump Mount Type	Wt. (lb)	ITEM	PRICE
H	Pump Plate	2-Bolt SAE Type B	7.7	8076028	34.99
I	Foot Bracket	4-Bolt	0.8	8039712	24.99
J	Foot Bracket	2-Bolt SAE Type A	1.7	8009317	24.99



Pump Accessories

Steel Hose Barbs

Steel construction to prevent oil contamination and provide superior fitting strength

	Hose I.D.	Fitting Size	Wt. (lb)	ITEM	PRICE
K	3/4"	3/4" NPT	0.3	8023952	4.99
	1"	1" NPT	0.5	8023961	14.99
	1-1/4"	1-1/4" NPT	1.2	8023989	19.99
	1-1/2"	1-1/2" NPT	1.1	8023998	29.99
L	1/2"	#8 ORB	0.1	8220626	4.99
	3/4"	#10 ORB	0.2	8220634	9.99
M	3/4"	#12 ORB	0.3	8220642	11.99
	1"	#12 ORB	0.5	8283236	9.99
	1-1/4"	#16 ORB	0.9	8283244	19.99



Power Unit Accessories



12V DC Motor Start Solenoid

Replacement motor start solenoid for power packs

8371221 – Wt. 1.6 lb. **24⁹⁹**



12V DC Motor Start Solenoid

Replacement motor start solenoid for the 12V DC power packs

1270088 – Wt. 0.8 lb. **59⁹⁹**



Hydraulic Power Pack Mounting Plate

- Premade mounting holes for easy component mounting
- Mount any of our gas or electric power packs and hydraulic reservoirs up to 15 gallon
- Constructed from 10 gauge steel and painted gloss black

8110728 – Wt. 34.0 lb. **69⁹⁹**



12V DC Power Packs



2 HP Auto Hoist Power Pack

- Push button to start motor and raise load, release button to hold load
- Lever operated valve controls lowering speed
- 115/230 VAC intermittent duty motor
- 2.5 gallon reservoir
- Vertical mount



Flow Rating @ 2,500 PSI	Relief Setting (PSI)	Relief Range (PSI)	Ports	Wt. (lb)	ITEM	PRICE
1.3 GPM	2,500	1,500-3,000	#4 ORB	30.1	8371064	449.99



Belt Driven Hydraulic Power Pack

- Can be belt driven by gas engines, electric motors, PTOs etc.
- Integrated 12V DC 3-position, 4-way directional control valve for double acting applications prevents cylinder bounce
- Clockwise rotation
- Displacement: .256 Cu. In./Rev.,
- Max. speed: 4,000 RPM



Flow Rating @ 3,600 RPM	Relief Setting (PSI)	Relief Range (PSI)	Reservoir Size (Gal.)	Ports	Wt. (lb)	ITEM	PRICE
3.4 GPM	2,600	1,500-3,000	.75	#6 ORB	15.8	8367690	349.99



12V DC Pump / Motor Power Pack

- For applications requiring auxiliary hydraulic power such as truck hoists, mobile cranes and boom equipment
- External valving and reservoir required



Flow Rating @ 2,500 PSI	Relief Setting (PSI)	Relief Range (PSI)	Ports	Wt. (lb)	ITEM	PRICE
.75 GPM	2,600	1,500-3,000	#6 ORB	22.8	8367708	249.99

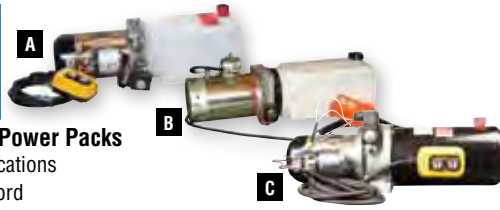

12V DC Single and Double-Acting Power Packs

- Use for single and double-acting applications
- Includes remote switch with 10 ft of cord

		Flow Rating @ 2,500 PSI	Relief Setting (PSI)	Relief Range (PSI)	Reservoir Size (Gal.)	Ports	Wt. (lb)	Item	Price
A	Single	.75 GPM	2,600	1,500-3,000	.75	#6 ORB	27.4	8371023	379.99
B	Double	.9 GPM	2500	500-3,000	.75	#6 ORB	27.8	8178998	399.99
C	Double*	.75 GPM	2,600	1,500-3,000	.75	#6 ORB	31.0	8371031	459.99

*3-position 4-way valving elements cylinder bounce

12V DC Convertible Power Packs

- Can be mounted on its own or in the steel weatherproof power pack box
- Add up to three manifold blocks to meet your valving requirements
- Includes remote switch with 10 ft of cord



		Flow Rating @ 2,500 PSI	Relief Setting (PSI)	Relief Range (PSI)	Reservoir Size (Gal.)	Wt. (lb)	Item	Price
D		.5 GPM	2,600	1,500-2,750	1.5	22.5	8371049	269.99
E		.75 GPM	2,600	1,500 - 2,750	1.5	30.3	8371056	359.99

12V DC Bi-directional Power Pack

- Compact double acting power pack
- Draws less current so it will work with smaller battery systems
- Bi-directional motor design eliminates the need for a directional control valve



	Flow Rating @ 2,500 PSI	Relief Setting (PSI)	Relief Range (PSI)	Reservoir Size (Gal.)	Ports	Wt. (lb)	Item	Price
	.5 GPM	2,600	1,500-2,750	.75	#6 ORB	17.8	8366882	349.99

*Use with reversing contractor 8364937

12V DC 100 Amp Reversing Contactor

- Easily reverse the polarity of your 12V DC circuit
- Can be used with birotational power pack 8366882
- Maximum on time: 15 minutes

8364937 - Wt. 1.2 lb **44⁹⁹**



Gas Powered Hydraulic Power Packs



13 HP Honda GX Single Stage Hydraulic Power Pack

- Portable hydraulic power pack for a wide variety of applications
- Max. cont. pressure: 2,500 PSI
- Max. cont. flow: 7 GPM

8056889 - Wt. 95.2 lb **1449⁹⁹**



6.5 HP Powerfist 2-Stage Hydraulic Power Pack

- Ideal for log splitters, presses and trash compactors
- These power packs can be used anywhere
- They have a gas engine coupled directly to a 2-stage high / low hydraulic pump



Max. PSI	GPM @ 3,600 RPM		Ports Inlet/Outlet	Wt. (lb)	ITEM	PRICE
	Low Pressure	High Pressure				
3,000	10.6	2.3	1" tube / 1/2" NPT	49.4	8114829	499.99



Steel Power Pack Box With Key Switch

- Protects the power pack from moisture, dirt, salt and other contamination
- Lid can be easily removed for quick access to the power pack
- Grommets holes for the addition of remote controls

8371312 - Wt. 0.5 lb **149⁹⁹**



Hand Controls with Micro Switches

Hand Control For Single Acting Power Pack

- Use to control single acting power pack 8371023
- Pre-wired with a 10 ft cord

8371239 - Wt. 1.4 lb **44⁹⁹**

Hand Control For Double Acting Power Pack

- Use to control double acting power pack 8371031
- Pre-wired with a 10 ft cord

8371262 - Wt. 1.7 lb **54⁹⁹**



Power Pack Spacer Block

- Mount under the manifold blocks to provide additional clearance from the reservoir and other power pack components

8371072 - Wt. 0.5 lb **14⁹⁹**



Hydraulic Power Pack Manifold Blocks

- Parallel circuit
- Comes complete with bolt and plug set

F) Single Station DO3 Manifold Block

- Mounts to the power pack to allow the use of a single DO3 directional control valve

8371155 - Wt. 1.6 lb **29⁹⁹**

G) Two Station DO3 Manifold Block Assembly

- Mounts to the power pack to allow the addition of two DO3 directional control valves

8371171 - Wt. 3.0 lb **59⁹⁹**

H) Three Station DO3 Manifold Block Assembly

- Mounts to the power pack to allow the addition of three DO3 directional control valves

8371205 - Wt. 4.3 lb **79⁹⁹**



No sale is final until you're satisfied!
We guarantee to make it right. We will repair, replace or refund any product to your satisfaction.

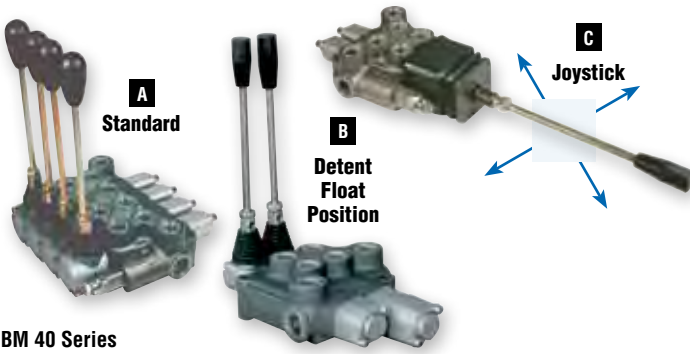

Monoblock Directional Control Valves

DO NPT FITTINGS WORK IN HIGH PRESSURE APPLICATIONS?

While NPT fittings will work in high pressure applications they are not the best choice. These fittings are prone to loosening and/or cracking when there is temperature cycling in the system and because the threads are tapered. Repeated assembly and dis-assembly can cause threads to distort, leading to leakage. Fittings that work better for high pressure sealing are ORB, JIC, or ORFS.

EUROPEAN DESIGN by

Features:

- Standard 3-position, 4-way/spring return to neutral unless otherwise stated
- Open centre
- Max. return line pressure: 1,100 PSI
- Relief valve pre-set @ 2,100 PSI, adjustable from 1,500 PSI to 3,750 PSI
- Control handles can be mounted in vertical or horizontal position
- Max. continuous pressure: 3,600 PSI

BM 40 Series

	Max. continuous flow	9 GPM
	Peak flow	12 GPM
	Top inlet/outlet and work ports	#8 ORB
	Side inlet/outlet ports	#10 ORB
	Wt. (lb)	ITEM PRICE
A	Single spool	5.6 1249721 129.99
	Two spool	8.3 1249739 199.99
	Three spool	11.4 1249747 269.99
	Four spool	14.3 1249754 339.99
B	Two spool (float-push/standard)	9.1 8267676 239.99
C	Two spool with joystick	8.4 8006338 274.99

	Max. continuous flow	4.5 GPM
	Peak flow	6.6 GPM
	Top inlet/outlet and work ports	#6 ORB
	Side inlet/outlet ports	#8 ORB
	Wt. (lb)	ITEM PRICE

A	Single spool	3.7 1249531 109.99
	Two spool	5.5 1249549 179.99
	Three spool	7.4 1249556 249.99

BM 70 Series

	Max. continuous flow	17 GPM
	Peak flow	24 GPM
	Top inlet/outlet and work ports	#10 ORB
	Side inlet/outlet ports	#12 ORB
	Wt. (lb)	ITEM PRICE
A	Single spool	10.4 1249796 189.99
	Two spool	15.3 1249804 274.99
	Three spool	20.9 1249812 359.99
	Five spool	30.7 1249838 499.99

	Max. continuous flow	9 GPM
	Peak flow	12 GPM
	Side inlet/outlet ports	#8 ORB
	Wt. (lb)	ITEM PRICE
A	Single spool	4.5 1249598 114.99

EUROPEAN DESIGN by

D) Motor Spools

BM20 Valves	1259019 16.99
BM30/40 Valves	1259084 26.99
BM70 Valves	1259142 34.99

G) Closed Centre Plugs

BM20 Valves	1250107 14.99
BM30/40 Valves	1259068 14.99
BM70 Valves	1259134 16.99

E) Single Acting Spools

BM20 Valves	1259027 19.99
BM30/40 Valves	1259092 24.99
BM70 Valves	1259159 32.99

H) Power Beyond Adapters

BM20 Valves	1259001 15.99
BM30/40 Valves	1259050 17.99
BM70 Valves	1259126 24.99

F) Relief Valve Plugs

BM20 Valves	1250032 16.99
BM30/40 Valves	1259076 17.99
BM70 Valves	1250033 25.99

I) Detent Kits

BM20 Valves	1259035 18.99
BM30/40 Valves	1259100 19.99
BM70 Valves	1259167 26.99

Hydraulic Control Valve Accessories

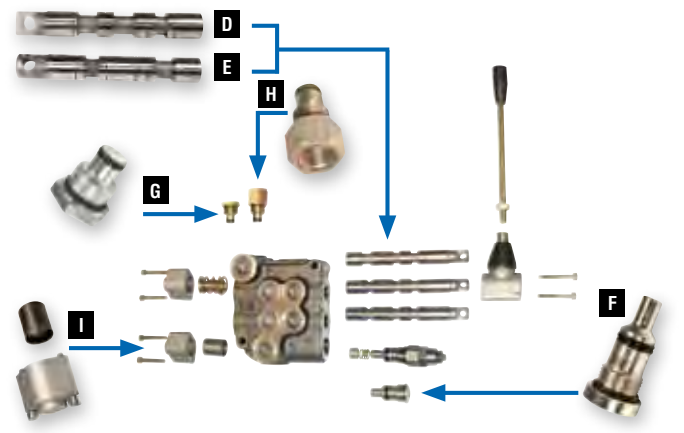

Hydraulic Monoblock Directional Control Valves

RD 5000 Series

- Max. continuous pressure: 3,000 PSI
- Relief preset at 2,000 PSI and adjustable from 1,500 to 3,000 PSI
- Max. return line pressure: 500 PSI
- Ports (NPT): 3/4" inlet/outlet, 1/2" work ports
- Open centre
- In the detented 4th position (float) the work ports are connected to tank, allowing the cylinder to float or the motor to freewheel
- Can be converted to closed centre or power beyond (with optional conversion plugs)

A) Single Spool

- 3-position, 4-way
- Max. continuous flow: 30 GPM

8107328 – Wt. 14.7 lb **179⁹⁹**

B) 2-Spool

- 3-position, 4-way
- Max. continuous flow: 25 GPM

8107344 – Wt. 23.6 lb **259⁹⁹**

C) 3-Spool

- 3-position, 4-way
- Max. continuous flow: 25 GPM

8107351 – Wt. 35.5 lb **349⁹⁹**

D) 2-Spool with Float Spool

- 1st spool 4-position, 4-way, 2nd spool 3-position, 4-way
- Max. continuous flow: 30 GPM

8107336 – Wt. 24.7 lb **289⁹⁹**

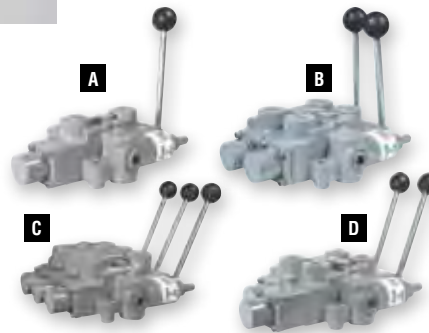

Rotary Actuated Directional Control Valve

- Handle rotates 90° each side of centre
 - No spring centering so handle will remain in whatever position it is placed
 - Excellent flow metering characteristics which makes it ideal for motor or cylinder applications where accurate speed control is required*
 - Max. continuous pressure: 2,500 PSI
 - Max. continuous flow: 20 GPM
 - Inlet/outlet ports: 3/4" NPT
 - Work ports: 1/2" NPT
- *Should be used with a load holding device in lifting applications
- 8126088 – Wt. 8.0 lb **174⁹⁹**

Hydraulic Valve Cable Control Systems

EUROPEAN DESIGN by

Single Axis Remote Control

- Can be mounted individually or stacked for multiple functions
- Weatherproof control can be mounted on interior or exterior of vehicle

8269680 – Wt. 1.8 lb **51⁹⁹**



Joystick Remote Valve Control

- Shift 2 hydraulic spools with 1 control
- Weatherproof control can be mounted on interior or exterior of vehicle

8269698 – Wt. 3.6 lb **134⁹⁹**

Remote Kit for BM40/70

Mounts to the front of the valve, allowing remote cable control actuation

8269706 – Wt. 0.3 lb **16⁹⁹**



Remote Control Cables

Length	Wt. (lb)	ITEM	PRICE
39"	1.0	8269631	29.99
59"	1.1	8269649	31.99
79"	1.3	8269656	36.99
118"	1.9	8269664	39.99
157"	2.0	8269672	46.99

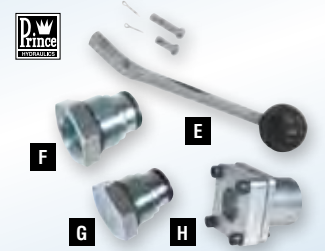

Replacement Parts & Accessories for Rd 5000 Series Valves

E) Handle Kit
8107419 – Wt. 0.4 lb **13⁹⁹**

F) Power Beyond Adapter
8107385
Wt. 0.3 lb **19⁹⁹**

G) Closed Centre Plug
8107393 – Wt. 0.6 lb **19⁹⁹**

H) 3-Position Detent Kit
8107369
Wt. 0.8 lb **54⁹⁹**

Solenoid Controlled D03 & D05 Control Valves



I) 12V DC D03 Activation

Wt. 4.7 lb
8046831 – Tandem Centre
8046807 – Closed Centre **139⁹⁹** /ea



J) 110V AC D03 Activation

Tandem centre with DIN connectors
8168544 – Wt. 5.1 lb **199⁹⁹**

K) 12V DC D05 Activation

Tandem centre
8093072 – Wt. 12.9 lb **179⁹⁹**

L) D05 Modular Relief Valve

- Mounts between the solenoid valve and subplate assembly
- Protects against over-pressuring of the valve and the actuators it controls
- Adjustable pressure range: 1,000 to 3,000 PSI
- Max. continuous flow: 18.5 GPM*

*Rated relief to tank flow
8093148 – Wt. 7.6 lb **99⁹⁹**

D03 SPECIFICATIONS:

- Max. continuous pressure: 5,000 PSI
- Max. continuous flow: 16 GPM
- **Must be used with subplate or manifold**

D05 SPECIFICATIONS:

- Max. continuous pressure: 4,500 PSI
- Max. continuous flow: 28 GPM
- **Must be used with subplate or manifold**

D03 & D05 Solenoid Valve Subplates & Manifolds

Mounts D03 and D05 solenoid valves to provide inlet / outlet / workport porting

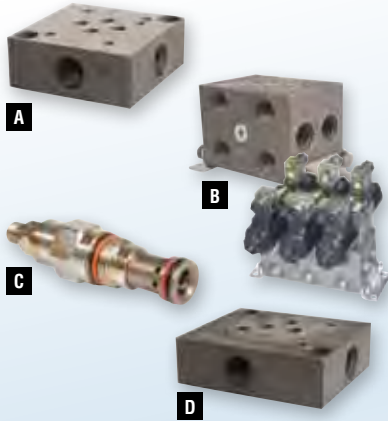

D03

A) Single D03 Valve Subplate

- #6 ORB ports
- Side porting

8163453 – Wt. 1.5 lb **27⁹⁹**

B) Multiple D03 Valve Manifold

- Series circuit
- #10 ORB inlet/outlet ports, #8 ORB work ports
- #6 ORB gauge port

2 Station
8163503 – Wt. 9.7 lb **89⁹⁹**

3 Station
8163529 – Wt. 14.3 lb **119⁹⁹**

C) D03 Manifold Relief Cartridge

Adjustable from 100 to 3,000 PSI

8163701 – Wt. 0.3 lb **99⁹⁹**

D05

D) Single D05 Valve Subplate

- #8 ORB ports
- Side porting

8163495 – Wt. 4.1 lb **44⁹⁹**

WARNING:

Failure, Improper Selection or Improper Use of Any Hydraulic Products and/or Systems or Related Items Can Cause Death, Personal Injury and/or Property Damage.

Princess Auto provides product and/or system options for further investigation by users having technical expertise. It is important that you analyze all aspects of your application and review the information concerning the product or system.

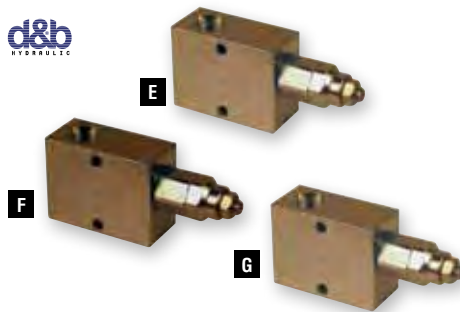

Adjustable Relief Valves

- Relief valves are used to control the maximum pressure in the portion of the hydraulic system where they are installed
- Protects components from over-pressuring
- Use to set maximum operating pressure by setting relief pressure approx. 300 PSI over system pressure
- Preset @ 2,000 PSI and is adjustable from 150 to 3,500 PSI

E) CP20 Adjustable Relief Valve

- 3 port, ball style
- Max continuous flow: 5 GPM
- Ports: #6 ORB

1240037 – Wt. 1.2 lb **59⁹⁹**

F) CP40 Adjustable Relief Valve

- 3 port, ball style
- Max continuous flow: 10 GPM
- Ports: #8 ORB

1240038 – Wt. 1.5 lb **64⁹⁹**

G) CP80 Adjustable Relief Valve

- 3 port, ball style
- Max continuous flow: 20 GPM
- Ports: #10 ORB

1240039 – Wt. 3.1 lb **69⁹⁹**

D03 & D05 SOLENOID VALVES

Multiple station manifolds for D03 and D05 solenoid valves are available in either a series or parallel circuit configuration. The series circuit allows only one valve to be actuated at a time while the parallel circuit allows multiple valves to be actuated at the same time (keeping in mind that oil will always take the path of least resistance).

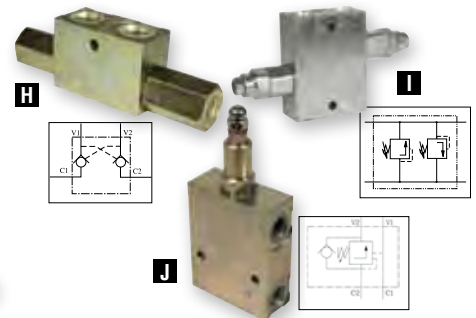

H) 2-Way Pilot Operated Check Valve

- Require pressure from 1 work port to open the return line of the other work port
- Holds the load in position, preventing creeping
- Best used with motor spool to prevent the checks from not seating
- Max. continuous pressure: 4,350 PSI
- Max. continuous flow: 8.75 GPM
- Ports: #8 ORB

1240047 – Wt. 1.5 lb **44⁹⁹**

I) Poppet Style Cross Over Relief Valve

- Eliminates shock, surge, and overload on hydraulic cylinders and motors.
- Relief cartridges are preset @ 2,000 PSI and are adjustable from 150 to 3,500 PSI
- Max. continuous pressure: 4,350 PSI
- Max. continuous flow: 10 GPM
- Ports: #8 ORB

1240044 – Wt. 2.6 lb **99⁹⁹**

J) 1-Way Counterbalance Valve

- Controls maximum return flow to equal pump output
- Prevents load induced acceleration and pump cavitation
- Used in many load lowering applications to control the rate of descent ie. truck boxes, tilt bed trailers or cranes
- Max. continuous pressure: 3,600 PSI
- Relief pressure set @ 3,200 PSI, adjustable from 1,450 PSI to 3,625 PSI
- Max. continuous flow: 8 GPM
- Ports: #8 ORB

1240065 – Wt. 2.9 lb **79⁹⁹**



Princess Auto
Foundation



Together we are making a difference

for our future customers. By providing bursaries to Canadian Colleges throughout Canada we demonstrate our support for the trades. Work with the hands-give from the heart.

For more information visit us at: www.theprincessautofoundation.com

PAF PARTNERS



MONDETTA



Charitable # 833179369 RR00041

Flow Controls

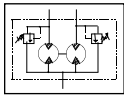

Adjustable Line Throttle Valves

- These simple and versatile little valves are an inexpensive way to restrict the flow of oil to various components in a hydraulic system.
- They are adjustable from 0 GPM to their maximum rated capacity in one direction and capable of full flow in the other direction.

Use to:

- Control cylinder stroke speed
- Prevent pump cavitation by controlling cylinders or motors with inertia loads
- Meter the flow to a hydraulic motor to control speed

Max. (GPM)	Ports (ORB)	Wt. (lb)	ITEM	PRICE
3.5	4	1.0	8322869	32.99
15	6	1.1	8322968	34.99
19	8	2.3	8323099	39.99
48	12	2.4	8323180	44.99

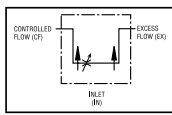

A

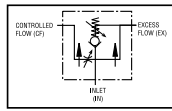

B



Pressure Compensated Adjustable Flow Controls

- Flow can be completely shut off or wide open
- Output flow is smooth and constant regardless of pressure changes on the controlled flow line
- Both outlets are pressure compensated
- Max. continuous pressure: 3,000 PSI
- Relief valve: Preset at 1,500 PSI adjustable from 750-3,000 PSI

	Max. Cont. Flow	Ports (ORB)	Wt. (lb)	ITEM	PRICE
A	16 GPM	10	8.5	8252777	89.99
	30 GPM	12	8.2	8252785	89.99
B	16 GPM	10	8.5	8252751	99.99
	30 GPM	12	8.4	8252769	99.99

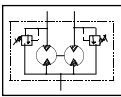

D



Haldex

C



Rotary Gear Style Proportional Flow Divider / Combiner

- Built-in differential relief valves to synchronize cylinders and protect against excessive differential pressure
- Efficient design resulting in very little pressure drop or heat generation
- Max. continuous pressure: 3,000 PSI

C) 2 Load

- Designed to raise and lower 2 unequal loads at the same speed
- Max. continuous flow: 9 to 18 GPM
- Ports: #10 ORB

8098212 - Wt. 10.0 lb **269⁹⁹**

D) 4 Load

- Designed to raise and lower 4 loads equally at the same speed
- Max. continuous pressure: 3,000 PSI
- Max. continuous flow: 4.4 to 9.0 GPM
- Ports: #8 ORB

8209009 - Wt. 10.0 lb **599⁹⁹**

CAN I CONVERT MY HYDRAULIC CONTROL VALVE TO SINGLE ACTING BY SIMPLY PLUGGING ONE OF THE WORK PORTS?

While this will work, it will also result in a lot of heat build-up within the hydraulic system because oil will go over the relief valve in one of the spool positions. The best solution is to either replace the valve or change to a single acting spool provided the design of the valve will allow it.

E



F



E) Manual for Hydraulic / Electrical Systems

Let's Get Into Hydraulics

Valuable information on the science of hydraulics as applied to common farm equipment

Farm Equipment Electrical Systems

A clear review of semiconductors; transistors; charging, starting and ignition circuits; lights and more

Hydraulic System Diagnosis

The interaction of the hydraulic components used in farm equipment

8007114 - Wt. 0.5 lb **16⁹⁹**

F) Hydraulics Fundamentals of Service Manual

- Provides the fundamentals of theory and service of hydraulic components and systems
- Colour illustrations

8092058 - Wt. 1.4 lb **84⁹⁹**

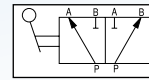

2-Position, 3-Way Selector Valves

- Use to direct the incoming flow to either outlet
- Possible applications include individually controlling 2 unidirectional motors or 2 single acting cylinders with 1 control valve

Max. Cont. Pressure (PSI)	Max. Cont. Flow (GPM)	Ports (ORB)	Wt. (lb)	ITEM	PRICE
3,625	9.5	8	1.9	8006793	56.99
3,625	15	10	3.0	8006800	59.99
3,625	25	12	4.5	8006819	69.99

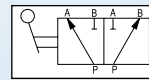

2-Position, 3-Way Selector Valve

- Possible applications include individually controlling 2 unidirectional motors or 2 single acting cylinders with 1 control valve
- Max. continuous pressure: 2,500 PSI
- Max. continuous flow: 20 GPM
- Ports: #8 ORB

8107211 - Wt. 4.0 lb **109⁹⁹**

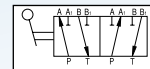

2-Position, 6-Way Selector Valve

- Directs 2 incoming flows between 2 sets of outlet ports
- Possible applications include individually controlling 2 double acting cylinders or hydraulic motors with one 4-way 3-position control valve
- Max. continuous pressure: 5,000 PSI
- Max. continuous flow: 20 GPM
- Ports: #8 ORB

8173932 - Wt. 5.2 lb **99⁹⁹**

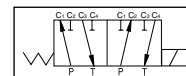

12V DC 2-Position, 6-Way Selector Valve

- Directs 2 incoming flows between 2 sets of outlet ports
- Possible applications include operating 2 double acting cylinders or bi-directional motors with one 4-way, 3-position control valve
- Max. continuous pressure: 4,350 PSI
- Max. continuous flow: 16 GPM
- #8 ORB ports
- DIN style electrical connector

8051799 - Wt. 5.6 lb **229⁹⁹**

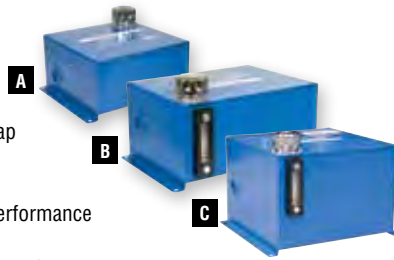

Oil Reservoirs

- 1/4 turn chrome breather / filler cap with 150 micron strainer basket
- 12-gauge steel construction
- Cleaned and tested for leak free performance

A) 3 Gallon

1-1/4" NPT inlet and 3/4" NPT outlet ports
8317216 – Wt. 18.3 lb **139⁹⁹**

B) 5 Gallon

- Temperature / level gauge
- 1-1/4" NPT inlet and 3/4" NPT outlet ports
- O'all dim.: 8.3" H x 12" L x 16.2" W

8318347 – Wt. 26.2 lb **169⁹⁹**

C) 10 Gallon

- Temperature / level gauge
- 1-1/4" NPT inlet and 1-1/4" NPT outlet ports
- Cleaned and tested for leak free performance

8318354 – Wt. 38.3 lb **199⁹⁹**

Custom Built Storage Tank With Baffle

Features:

- Can be built to any dimensions to fit most applications
- Over 50 possible port positions and 8 different port sizes
- Heavy 12-gauge steel construction
- Interior baffle plate
- Optional features include an oil temperature/level gauge and filler/strainer breather cap assembly
- Painted black and treated internally with a rust preventative oil

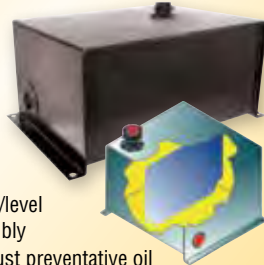

Ready in 15 working days (a maximum order of 5 pieces).
 Special quotes can be provided for orders of 10 pieces or more! *Delivery time is extra.

For more information contact your local store, or our
 National Call Centre at 1-800-665-8685 or Gary Laws at 1-204-654-5209



D) Suction Line Strainer 15 GPM Rating

- 8" length with 90 sq. in. screen area
- 1-1/2" NPT tank mounting
- 1" NPT line connection
- Equipped with a bypass relief valve

1250095 – Wt. 0.8 lb **29⁹⁹**

E) Suction Line Strainer 10 GPM Rating

- 8.2" length with 70 sq. in. screen area
- 1-1/4" NPT tank mounting
- 3/4" NPT line connection
- Equipped with a bypass relief valve

1251602 – Wt. 0.7 lb **32⁹⁹**

E) Suction Line Strainer 25 GPM Rating

- 9" length with 125 sq. in. screen area
- 2" NPT tank mounting
- 1-1/4" NPT line connection
- Equipped with a bypass relief valve

1251610 – Wt. 1.2 lb **34⁹⁹**

Reservoirs



Economy Reservoirs

Overall dim.: 8.7" H x 16.5" L x 12" W



Cap. (gal.)	Ports (NPT) In x Out	Overall Dim. H x L x W	Wt. (lb)	ITEM	PRICE
5	1-1/4" x 3/4"	8.7" x 16.5" x 12"	25.7	1250106	89.99
10	1-1/4" x 1-1/4"	11.5" x 16.5" x 16.5"	38.2	8001466	129.99



Reservoirs with In-Tank Filter and Baffle

- 11 gal steel construction
- Cleaned and tested for leak-free performance
- Interior baffle between suction and discharge sides of tank
- 1/4 turn chrome breather / filler cap with 150 micron strainer basket
- Temperature / level gauge
- 4 ports: two 2" NPT suction ports, one 3/8" NPT port for pumps with case drain, one 3/4" NPT bottom drain port,
- Intank return line filter with 1-1/2 NPT/Code 61 inlet capable of 50 GPM and a maximum inlet pressure of 100 PSI*



*Without filter element. Use elements 8283392, 8283384 or 8283376 on page 264

Cap. (gal.)	Overall Dim. H x L x W	Wt. (lb)	ITEM	PRICE
15	19.3" x 18.5" x 16"	73.3	8298184	399.99
25	26.5" x 16.0" x 20.7"	99.6	8298200	469.99

Breathers & Strainers

40 Micron Breather 10 CFM airflow capacity



Size (NPT)	Wt. (lb)	ITEM	PRICE
3/8"	0.2	1250090	8.99
1/2"	0.3	1250092	12.99
3/4"	0.6	1250093	15.99
1"	0.7	1250094	21.99

Weld-On Breather Cap with Strainer Basket

- 40 micron breather cap threads on to weld-on sleeve
 - Removable strainer basket
- 8163792** – Wt. 1.0 lb **29⁹⁹**



Breather Cap with 150 Micron Strainer Basket

- 40 micron chrome breather cap is attached with a chain and can be taken off by twisting a 1/4" turn
- Mount on reservoirs and storage tanks

1250101 – Wt. 0.7 lb **17⁹⁹**

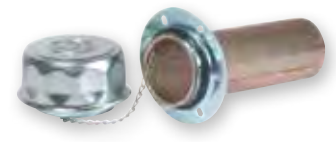

Breather Cap with 37 Micron Strainer Basket

- Chrome breather cap is attached with a chain and removed by twisting a 1/4" turn
- Complete with mounting screws and gaskets

8092983 – Wt. 0.8 lb **19⁹⁹**

Reservoir Accessories

T-Bolt Hose Clamps

- Stainless steel band and bridge, plated steel bolt, trunnion and nut
- Provides dynamic sealing to suction hoses preventing air and other contaminants from entering the system

Range (I.D.)	Wt. (lb)	ITEM	PRICE
1.14"-1.22"	0.1	8023925	3.99
1.31"-1.56"	0.1	8016951	3.99
1.56"-1.81"	0.1	8016997	3.99
1.81"-2.06"	0.1	8017004	4.49
2.06"-2.31"	0.1	8017013	4.49
2.31"-2.63"	0.1	8186918	4.49
2.56"-2.87"	0.2	8017040	4.49
2.69"-3.00"	0.2	8186926	4.99
2.91"-3.13"	0.2	8106254	4.99
3.06"-3.38"	0.2	8106288	4.99
3.31"-3.62"	0.2	8106312	5.49
3.63"-3.94"	0.2	8186934	5.49
3.81"-4.13"	0.2	8251159	5.49



Stamped Steel Port Flange

- These port flanges make quick and easy work of adding a threaded port to a reservoir
- Just cut pilot hole in tank and weld on threaded port flange

Size (NPT)	Wt. (lb)	ITEM	PRICE
1/2"	0.1	1290230	2.49
3/4"	0.2	1290231	2.99
1"	0.1	1290232	3.29
1-1/4"	0.2	1290233	3.49
1-1/2"	0.3	1290234	3.99
2"	0.3	1290235	3.99

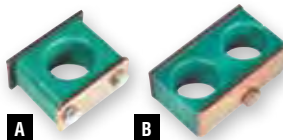

Hose Mounting Clamps

- Use to secure and organize hydraulic hose
- Mount by either welding or drilling a hole

A) Single Clamp

Hose I.D.	Hose O.D.	Wt. (lb)	ITEM	PRICE
1/4"	0.62"	0.2	8076101	4.49
3/8"	0.78"	0.3	8076135	4.49
1/2"	0.91"	0.3	8076143	4.49
3/4"	1.19"	0.3	8076150	4.99
1"	1.53"	0.4	8076168	5.99

B) Twin Clamp

Hose I.D.	Hose O.D.	Wt. (lb)	ITEM	PRICE
1/4"	0.62"	0.3	8076176	5.49
3/8"	0.78"	0.4	8076184	5.99
1/2"	0.91"	0.4	8076200	6.49
3/4"	1.19"	0.5	8076226	6.99

Line Check Valves

- Permits oil flow in one direction only
- Poppet style for less leakage than standard ball type
- Max. continuous pressure: 5,000 PSI
- Used to isolate a circuit, provide component protection. ie. (cooler bypass)



Size (NPT)	Max. Cont. Flow (GPM)	Cracking Pressure (PSI)	Wt. (lb)	ITEM	PRICE
3/8"	10	75	0.7	8261455	13.99
1/2"	14	75	1.2	8261463	15.99
3/4"	25	75	1.8	8261471	23.99

C) 2-Way High Pressure Ball Valve

- Body and ball are all steel construction
- Max. cont. pressure: 7,250 PSI

Ports (NPT)	Wt.(lb)	ITEM	PRICE
1/4" NPT	0.9	8317927	24.99
3/8" NPT	1.2	8317935	27.99
1/2" NPT	1.7	8317943	29.99
3/4" NPT	3.3	8317950	39.99



D) High Pressure 3-Way Ball Valve

- Body and ball are all steel construction
- Max. continuous pressure: 5,075 PSI

Ports (NPT)	Wt (lb)	ITEM	PRICE
#8 ORB	1.8	8046724	79.99

High Pressure Needle Valve

- All steel construction
- Use in-line to limit flow within a hydraulic circuit
- Max. continuous pressure: 5,000 PSI
- #6 ORB ports



8051815 – Wt. 0.7 lb **29⁹⁹**

Testing Equipment

1/4" NPT Pressure Test Point

- Install in hydraulic systems to obtain random pressure checks during servicing and troubleshooting
- Pressure gauge hose assemblies can be connected and disconnected at full system pressure without fluid loss or dirt ingress
- Max. continuous pressure: 6,000 PSI



1/4" NPT Gauge To Hose Adapter

- Connects between the test point hose assembly and the pressure gauge
- Max. continuous pressure: 6,000 PSI



48" Test Point Hose Assembly

- Connects between the test point and gauge/adapter assembly
- Max. continuous pressure: 6,000 PSI
- Length: 48"



Gauges

Glycerine Filled Pressure Gauges

- Glycerine provides longer life and reduces erratic needle movement
- Thread: 1/4" NPT
- Face dia.: 2-1/2"
- Scale shows PSI and Kg/cm
- -20°C (-4°F) to 60°C (140°F) temperature rating



Mount Type	Pressure Range	Wt. (lb)	ITEM	PRICE	
E	Vertical	0 to 2,000 PSI	0.5	8000833	13.99
	Vertical	0 to 3,500 PSI	0.5	8000842	13.99
	Vertical	0 to 5,000 PSI	0.5	8000851	14.99
	Vertical	0 to 7,000 PSI	0.5	8000860	15.99
F	Horizontal	0 to 3,500 PSI	0.6	8000888	17.99

Oil Temperature / Level Gauge

Temp. Range	Bolt Centres	Mounting Bolt (Size)	Wt. (lb)	ITEM	PRICE
20°C to 70°C	5.0"	M12	0.7	8093023	9.99



0-100 PSI Filter Pressure Gauge

- Use with filter heads to show when the filter element needs replacement (return line only)
- For accurate filter element monitoring, mount the return line filter as close to the reservoir as possible
- Green and red gauge colouring makes it easy to see when the filter element needs replacing
- 1/8" NPT threading



8292922 – Wt. 0.3 lb **9⁹⁹**

Hydraulic Oil



Shell Lubricants

Anti-Wear 32 Hydraulic Oil

- Recommended for high pressure mobile and industrial hydraulic systems
- Anti-wear hydraulic oil provides protection against wear and oxidation while providing thermal stability to the oil
- Not suitable for hydrostatic tractor systems



Shell Lubricants

All Season Hydraulic Oil

- This premium grade all-season hydraulic oil is designed for use in hydraulic systems subjected to wide variations in temperature
- Features outstanding anti-wear protection, high shear and oxidation stability and superior anti-foam and water tolerance
- Not suitable for hydrostatic tractor systems



PAL HYDRAULICS
Your Hydraulic Solutions Provider

All Season Hydraulic Oil

- All season hydraulic oils are formulated for Canadian climates and provide superior performance over a wide range of temperatures
- Ideally suited for mobile and all season equipment
- Not suitable for hydrostatic tractor systems



ISO Rating	Min Start-Up Temp.	Qty. (litre)	Wt. (lb)	ITEM	PRICE
32	-10°C	18.9	41.8	8336927	64.99
46	-10°C	18.9	41.8	8336935	64.99
68	-10°C	18.9	41.8	8336950	64.99

ISO Rating	Min Start-Up Temp.	Qty. (litre)	Wt. (lb)	ITEM	PRICE
32	-32°C	18.9	41.8	8337107	79.99
46	-27°C	18.9	41.8	8337115	79.99
68	-21°C	18.9	41.8	8337123	79.99

ISO Rating	Min Start-Up Temp.	Qty. (litre)	Wt. (lb)	ITEM	PRICE
32	-31°C	18.9	38.6	8339764	54.99
46	-25°C	18.9	38.6	8339780	54.99
68	-20°C	18.9	38.6	8339814	54.99



Powerfast Anti-Wear 32 Hydraulic Oil

- A good quality hydraulic oil at a competitive price
- Recommended for mobile and industrial systems with pressures up to 3,000 PSI
- Anti-wear hydraulic oil provides protection against wear and oxidation while providing thermal stability to the oil
- Not suitable for hydrostatic tractor systems
- Minimum start-up temperature: -10°C
- 18.9 litres



Shell Lubricants

Donax TGH Hydraulic Oil

- Provides excellent lubrication in a wide variety of farm, construction, and forestry equipment
- Used where a common reservoir supplies oil to the transmission, hydraulic system, differential, and final drives
- Minimum start-up temperature: -22°C
- 20 litres



Shell Lubricants

Donax TGH Artic Hydraulic Oil

- Provides excellent lubrication in a wide variety of farm, construction, and forestry equipment
- Used where a common reservoir supplies oil to the transmission, hydraulic system, differential, and final drive
- Low temperature performance to -37°C
- 4 litres



8339749 – Wt. 38.6 lb **44⁹⁹**

8337164 – Wt. 41.8 lb **79⁹⁹**

8337198 – Wt. 41.8 lb **99⁹⁹**



Snow Plow Hydraulic Fluid

- Blue, non-foaming, antiwear formula helps protect high pressure systems
- Antifreeze additive protects to extreme temperatures (-50°F/-45°C)
- It is important to change your hydraulic fluid annually
- Replaces Meyer 15134, Western 49311, Fisher 28531, Sno-Way 96005029
- 0.95 litres / 1 quart



8201436 – Wt. 1.9 lb **9⁹⁹**



PAL HYDRAULICS
Your Hydraulic Solutions Provider

Hydraulic Oil Viscosity Improver

- Lower the pour point temperature of hydraulic and gear oils for improved cold weather performance without changing the oil's high temperature properties
- Recommended for hydraulics, transmissions, and differentials
- The recommended mix ratio is up to 15% of original fill



1 litre
8339822 – Wt. 2.0 lb **9⁹⁹**

4 litre
8339830 – Wt. 8.2 lb **39⁹⁹**

Fluid Conditioning

PAL HYDRAULICS
Your Hydraulic Solutions Provider



MADE IN CANADA

Oil Filter / Transfer Cart

- Filtering your oil will promote longer component life, less downtime and longer intervals between oil replacement
- Motor: 1/2 HP, 115V AC
- Transfer / filtration rate: 7.8 GPM @ 50 PSI
- Intake and return hoses: 7 ft long, with 3 ft PVC tube extensions
- The two dual filter heads each have a bypass pressure of 25 PSI and a gauge showing when the filter element need replacement
- Filter elements are not included with the cart so please select either the 6.7" or 10.7" length elements from page 264



8306920 – Wt. 150.0 lb **1199⁹⁹**
Filter elements are not included with the cart



In-Line Filter Head

150 Max. pressure (PSI)

	Inlet/Outlet Ports	By-Pass	Pump Recommendation	Element Size	Wt. (lb)	ITEM	PRICE
A	3/8"	None	1-4	3.4"	0.2	8076085	11.99
B	1/2" NPT	25	5	5.35" & 7.87"	0.6	8076069	13.99
C	3/4" NPT	25	10	5.35" & 7.87"	0.6	8006258	13.99
D	1" NPT	25	16	5.35" & 7.87"	0.9	8076077	13.99
E	1-1/4" NPT	25	25	6.7" & 10.7"	1.7	8006267	22.99

Fluid Filters



Filter Elements

Length	Beta Ratio	Micron Rating	Material	Average Cleanliness	Cleanliness Factor Expectation [†]	Wt. (lb)	ITEM	PRICE
3.4"	2	10	Cellulose	23/20/14	1	0.7	8155327	11.99
5.35"	2	10	Cellulose	23/20/14	1	1.1	8038651	13.99
5.35"	1,000	10	Synteq	19/17/13	16x	1.3	8241218	27.99
5.35"	N/A	N/A	Water Absorbing*	N/A	N/A	1.6	8038688	17.99
7.87"	2	10	Cellulose	23/20/14	1	1.7	8199051	17.99
7.87"	1,000	10	Synteq	19/17/13	16x	1.7	8038642	36.99
6.7"	2	10	Cellulose	23/20/14	1	2.4	8038704	26.99
6.7"	1,000	10	Synteq	19/17/13	16x	2.7	8040728	49.99
10.7"	2	10	Cellulose	23/20/14	1	3.2	8155335	39.99
10.7"	200	10	Synteq	16x	0	3.6	8283368	74.99
10.7"	N/A	N/A	Water Absorbing*	N/A	N/A	3.4	8155343	45.99
9"	10	12	Cellulose	23/20/14	1	1.3	8283376	21.99
9"	1,000	10	Synteq	19/17/13	16x	1.5	8283384	39.99
9"	75	5	Synteq	17/14/11	64x	1.5	8283392	45.99

* Water absorbing elements should be replaced with filtration elements once the water in the oil has been removed.
[†] The Cleanliness Factor is the expected increase in performance as a multiplier over base line cellulose filtration.

Welcome to our Unique World!

Home of an outstanding shopping experience, every time!



Return Line Heat Exchanger

- Heat removal: 7,540 BTU/Hr.
- Max. continuous pressure: 170 PSI
- Max. continuous flow: 26.4 GPM
- Features 26 internal brass cooling tubes

8113615 – Wt. 26.9 lb **209⁹⁹**

Pneumatic Cylinders

Aluminum Double Acting Cylinders

Features an aluminum cylinder body and chromed steel shaft

- Max. continuous pressure: 130 PSI
- Bore: 0.8" (20 mm), ports: 1/8" NPT
- Rod dia.: 0.3" (8 mm)
- Rod end threading: M8 x 1.25
- Shaft end of cylinder tube threading: M22 x 1.5



Stroke	Retracted Length	Wt. (lb)	ITEM	PRICE
1" (25 mm)	6.2" (156 mm)	0.5	8188161	14.99
2" (50 mm)	7.2" (181 mm)	0.6	8188179	15.99
3.9" (100 mm)	9.2" (231 mm)	0.6	8188187	18.99
5.9" (150 mm)	11.1" (281 mm)	0.8	8188195	19.99
9.9" (250 mm)	15.1" (381 mm)	1.0	8188211	23.99
11.8" (300 mm)	17.0" (431 mm)	1.1	8188229	24.99

Aluminum Single Acting Spring Return Cylinder

- Max. continuous pressure: 100 PSI
- Bore size: 1.3" (32 mm), stroke: 1" (25 mm)
- Port size: 1/8" NPT
- Shaft dia.: 0.5" (12 mm)
- Rod end threading: M10 x 1.25



8041394 – Wt. 0.8 lb **49⁹⁹**



Aluminum Single Acting Spring Return Cylinders

- Max. continuous pressure: 130 PSI
- Bore: 1" (25 mm), ports: 1/8" NPT
- Rod dia.: 0.4" (10 mm)
- Rod end threading: M10 x 1.25
- Shaft end of cylinder tube threading: M22 x 1.5
- Base end threading: M22 x 1.5

Stroke	Retracted Length	Wt. (lb)	ITEM	PRICE
1" (25 mm)	6.3" (160 mm)	0.7	8246928	21.99
2.0" (50 mm)	7.3" (185 mm)	0.7	8246936	23.99
3.9" (100 mm)	9.3" (235 mm)	1.0	8246944	25.99

Stainless Steel Pneumatic Cylinder

Features a stainless steel body and chromed steel shaft

- Max. continuous pressure: 130 PSI
- Bore: 1" (25 mm), ports: 1/8" NPT
- Rod dia.: 0.4" (10 mm)
- Rod end threading: M10 x 1.25
- Shaft end of cylinder tube threading: M22 x 1.5
- Base end threading: M22 x 1.5



Stroke	Retracted Length	Wt. (lb)	ITEM	PRICE
2.0" (50 mm)	7.3" (185 mm)	0.7	8246886	26.99
3.9" (100 mm)	9.3" (235 mm)	0.8	8246894	29.99

Aluminum Tie Rod Cylinders

Bore: 1.6" (40 mm)

- Max. continuous pressure: 130 PSI
- Rod dia.: 0.6" (16 mm)
- Rod end threading: M12 x 1.25
- Ports: 1/4" NPT



Stroke	Retracted Length	Wt. (lb)	ITEM	PRICE
1" (25 mm)	6.6" (167 mm)	1.5	8188237	28.99
2" (50 mm)	7.6" (192 mm)	1.7	8188245	29.99
3.9" (100 mm)	9.6" (242 mm)	1.9	8188252	32.99
5.9" (150 mm)	11.6" (292 mm)	2.4	8188260	34.99
7.9" (200 mm)	13.5" (342 mm)	2.8	8188278	35.99
11.8" (300 mm)	17.5" (442 mm)	3.6	8188286	39.99
19.7" (500 mm)	25.3" (642 mm)	5.0	8188294	49.99

Bore: 2.5" (63 mm)

- Max. continuous pressure: 130 PSI
- Rod dia.: 0.8" (20 mm)
- Rod end threading: M16 x 1.5
- Ports: 3/8" NPT



Stroke	Retracted Length	Wt. (lb)	ITEM	PRICE
3.9" (100 mm)	10.0" (253 mm)	3.6	8188302	49.99
5.9" (150 mm)	12.0" (303 mm)	4.3	8188310	56.99
7.9" (200 mm)	14.0" (353 mm)	5.1	8188328	59.99
11.9" (300 mm)	17.9" (453 mm)	6.0	8188336	74.99

Bore: 3.2" (80 mm)

- Max. continuous pressure: 130 PSI
- Rod dia.: 1" (25 mm)
- Rod end threading: M20 x 1.5
- Ports: 3/8" NPT



Stroke	Retracted Length	Wt. (lb)	ITEM	PRICE
3.9" (100 mm)	11.2" (282 mm)	6.6	8188351	69.99
5.9" (150 mm)	13.1" (332 mm)	7.3	8188369	74.99
7.9" (200 mm)	15.1" (382 mm)	8.4	8188377	79.99
11.8" (300 mm)	19.0" (482 mm)	10.2	8188385	96.99
15.7" (400 mm)	23.0" (582 mm)	12.1	8188393	109.99
19.7" (500 mm)	26.9" (682 mm)	14.1	8188401	124.99



12V DC Solenoid Activated Control Valve

- Max. continuous pressure: 115 PSI
- Max. continuous flow: 45 CFM
- Manual release valves

A) 3-way, 2-position

1/4" NPT ports
8226607 – Wt. 0.5 lb. **24⁹⁹**

B) 5-way, 2-position

1/4" NPT pressure, 1/8" NPT exhaust ports
8226615 – Wt. 0.7 lb. **34⁹⁹**

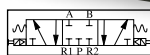

12V DC Solenoid Activated Pneumatic Control Valve

- Use to electrically control pneumatic cylinders or motors
- 5-way, 3-position
- Max. continuous pressure: 115 PSI
- Max. continuous flow: 52 CFM
- 1/4" NPT pressure, 1/8" NPT exhaust ports
- Manual release valves

8192262 – Wt. 0.9 lb. **49⁹⁹**

Pneumatic Control Valves

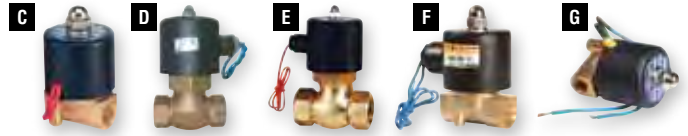

Solenoid Valves

- Forged brass body and NBR diaphragm
- Normally closed
- 2-way, 2-position

Also suitable for water and oil

	Volts	Max. Cont. Flow (CFM)	Ports	Max. Cont. Pressure (PSI)	Current Draw (Amps)	Wt. (lb)	ITEM	PRICE
C	12 V DC	18.5	1/4" NPT	100	1.3	0.6	8192270	26.99
D	110 V AC	22	1/2" NPT	215	.35	3.8	8081903	69.99
E	12 V DC	22	1/2" NPT	215	1.7	3.5	8192296	79.99
F	12 V DC	11	3/8" NPT	100	1.3	1.9	8192304	39.99
G	110 V AC	7	1/4" NPT	100	.12	0.7	8041444	37.99

5-Way, 2-Position Lever Control Valve



- Max. continuous pressure: 115 PSI
- Max. continuous flow: 56 CFM
- Ports: 1/4" NPT pressure, 1/8" NPT exhaust
- Control 1 double or 2 single acting pneumatic cylinders

8190373 – Wt. 0.4 lb **19⁹⁹**

5-Way, 3-Position Lever Control Valves

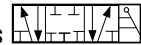

- Max. continuous pressure: 115 PSI
- Max. continuous flow: 56 CFM
- All ports blocked in central neutral position

H) Ports: 3/8" NPT Pressure, 1/4" NPT Exhaust
8190456 – Wt. 0.8 lb **29⁹⁹**

I) Ports: 1/4" NPT Pressure, 1/8" NPT Exhaust
8190415 – Wt. 0.6 lb **26⁹⁹**

Foot Pedal Control Valve



- 5-way, 2-position
- Max. continuous pressure: 115 PSI
- Max. continuous flow: 52 CFM
- 1/4" NPT ports
- Use to control pneumatic cylinders or motors

8192429 – Wt. 2.2 lb **39⁹⁹**

Rotary Pneumatic Control Valve

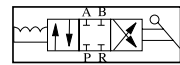

- 4-Way, 3-Position
- Max. continuous pressure: 115 PSI
- Max. continuous flow: 35 CFM
- Ports: 1/4" NPT
- For 1 double acting or 2 single acting cylinders

8190480 – Wt. 0.7 lb **19⁹⁹**

Pneumatic Push Button Valve



- 5-way, 2-position
- Max. continuous pressure: 115 PSI
- Max. continuous flow: 47 CFM
- Momentary actuation
- Three 1/4" NPT pressure ports and two 1/8" NPT exhaust ports

8190472 – Wt. 0.5 lb **19⁹⁹**

Pneumatic Accessories

Pneumatic Cylinder Rod Ends

Used on pneumatic cylinders to change the rod end configuration

A) Tang Ends

Threading	Tang Thickness	Pinhole Dia.	Wt. (lb)	ITEM	PRICE
8 mm x 1.25	0.3" (8 mm)	0.3" (8 mm)	0.1	8004013	4.99
10 mm x 1.25	0.4" (10 mm)	0.4" (10 mm)	0.1	8190217	4.99
12 mm x 1.25	0.5" (12 mm)	0.5" (12 mm)	0.3	8190233	4.99
16 mm x 1.5	0.6" (16 mm)	0.6" (16 mm)	0.7	8190241	6.99
20 mm x 1.5	1.0" (24 mm)	0.8" (20 mm)	1.3	8190308	9.99

B) Clevis Ends

Threading	Clevis Inside Width	Pinhole Dia.	Wt. (lb)	ITEM	PRICE
8 mm x 1.25	0.3" (8 mm)	0.3" (8 mm)	0.1	8041287	5.99
10 mm x 1.25	0.4" (10 mm)	0.4" (10 mm)	0.1	8190175	5.99
12 mm x 1.25	0.5" (12 mm)	0.5" (12 mm)	0.3	8190183	6.99
16 mm x 1.5	0.6" (16 mm)	0.6" (16 mm)	0.8	8190191	8.99
20 mm x 1.5	0.8" (20 mm)	0.8" (20 mm)	1.5	8190209	11.99

C) Swivel Eyes

Threading	Eye Thickness	Pinhole Dia.	Wt. (lb)	ITEM	PRICE
8 mm x 1.25	0.5" (12 mm)	0.3" (8 mm)	0.1	8004014	5.99
10 mm x 1.25	0.5" (14 mm)	0.4" (10 mm)	0.2	8190324	7.99
12 mm x 1.25	0.6" (16 mm)	0.5" (12 mm)	0.2	8190332	11.99
16 mm x 1.5	0.8" (21 mm)	0.6" (16 mm)	0.5	8190340	14.99
20 mm x 1.5	0.8" (20 mm)	0.8" (20 mm)	0.9	8190357	19.99

Cylinder Base Ends

Used on tie rod pneumatic cylinders to change the base end configuration

D) Foot Mount Ends

Cylinder Bore Size (in.)	Bore Cylinder Size (mm)	Pinhole Dia.	Wt. (lb)	ITEM	PRICE
1.6"	40 mm	-	0.3	8188419	1.99
2.5"	63 mm	-	0.6	8188427	4.99
3.2"	80 mm	-	0.9	8188435	5.49

E) Male Tang Ends

Cylinder Bore Size (in.)	Bore Cylinder Size (mm)	Pinhole Dia.	Wt. (lb)	ITEM	PRICE
1.6"	40 mm	0.6 (14 mm)	0.6	8189763	4.99
2.5"	63 mm	0.6 (16 mm)	1.1	8189797	6.99
3.2"	80 mm	0.8 (20 mm)	2.8	8189813	9.99

F) Clevis Ends

Cylinder Bore Size (in.)	Bore Cylinder Size (mm)	Pinhole Dia.	Wt. (lb)	ITEM	PRICE
1.6"	40 mm	0.5" (12 mm)	0.6	8189821	6.99
2.5"	63 mm	0.6" (16 mm)	1.1	8189839	7.99
3.2"	80 mm	0.8" (20 mm)	2.3	8189847	11.99



Pneumatic Roller Lever Control Valve

- 3-way, 2-position
- Max. continuous pressure: 115 PSI
- Max. continuous flow: 47 CFM
- Ports: 1/4" NPT
- Directs an incoming airflow between two outlet ports

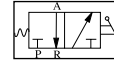

1/4" O.D. x 100 ft Polyethylene Pneumatic Hose

- Connects components in a pneumatic system
- Max. continuous pressure: 125 PSI
- Temperature range: -40°C to 71°C (-40°F to 160°F)



Colour	Wt. (lb)	ITEM	PRICE
Blue	1.1	8134868	11.99
Red	1.1	8134876	11.99
Yellow	1.1	8134884	11.99
Green	1.1	8134900	11.99
Clear	1.0	8112682	11.99

D.O.T. Approved Nylon Pneumatic Hose

- 1/4" O.D.
- Max. continuous pressure: 300 PSI
- Temperature range: -40°C to 93°C (-40°F to 200°F)
- Use in air brake and air suspension systems anywhere on your truck or trailer



8133811 - Wt. 0.1 lb **49¢/ft**

Silencers

- Controls noise caused by airflow through valves
- Max. continuous pressure: 130 PSI
- Noise elimination effect: 18 dB



G) 1/8" NPT Brass

8236770 - Wt. 0.1 lb **1.99**

H) 1/4" NPT Plastic

8236788 - Wt. 0.1 lb **1.99**

Pneumatic Speed Controllers

- Features controlled flow in one direction and full flow in the opposite direction
- Max. continuous pressure: 130 PSI
- Ports: 1/4" NPT



8.5 CFM Air Flow

8004050 - Wt. 0.3 lb **7.99**

17.0 CFM Air Flow

8192411 - Wt. 0.5 lb **9.99**

28.0 CFM Air Flow

8004051 - Wt. 0.3 lb **11.99**



22 mm Replacement Nut

Replacement nut for aluminum double acting cylinders

8192460 - Wt. 0.1 lb **2.99**



1.3" (32 mm) Bore Seal Kit
8192676 - Wt. 0.1 lb **2.99**

1.6" (40 mm) Bore Seal Kit
8192684 - Wt. 0.1 lb **3.99**

Driveline Components

PUT NEW LIFE IN YOUR OLD EQUIPMENT.



RE-POWERING with a new Briggs & Stratton engine is affordable, reliable and better for the environment.



Engines



6.5 HP Vertical Shaft Lawnmower Engine

- Large rewind starter reduces pulling effort for easy starts
- 1.5 litre fuel tank
- Mechanical compression release for smooth, quick starting
- Composite camshaft and aluminized Lo-Tone™ muffler for low noise operation
- Shaft size: 7/8"

8367815 – Wt. 28.2 lb **209⁹⁹**



Honda GX Gas Engines

- Honda 4-cycle overhead valve gas engines
- High fuel economy
- Tough durability
- Cast iron cylinder sleeves
- Easy maintenance, compact, simple to mount
- Steady high power
- Low noise and vibration



Model	Net HP @ 3,600 RPM	Fuel Tank Capacity	Shaft Size	Overall dim. (l x w x h)	Wt. (lb)	ITEM	PRICE
GX 160 K1 QH	4.8	0.79 gal.	3/4"	12.48" x 14.48" x 13.40"	37.0	4770426	479.99
GX 270 QH	8.5	1.32 gal.	1"	15.20" x 17.20" x 16.40"	61.0	4770459	799.99
GX 390 KI QA*	11.7	1.71 gal.	1"	15.94" x 17.72" x 17.44"	78.0	4770558	1099.99

*with oil guard



Verticle OHV Gas Engines

- Ideal for riding mowers and tractors
- Electric start
- Muffler included



	Charging System	Shaft Size	Wt. (lb)	SKU	Price
13 HP	3A	1"	78.0	8270506	599.99
17.5 HP	9A	1"	80.0	8270514	799.99



All Power Diesel Engine

- 10 HP @ 3,600 RPM
- Electric and recoil start
- 1" keyed shaft
- 1.5 gallon (5.5 litre) fuel tank
- Air cooled
- For commercial, agricultural, and industrial use

8299687 – Wt. 110.0 lb **549⁹⁹**



2 pc Shear Bolts



Description	Wt. (lb)	SKU	Price
Ariens #57540-7	0.1	8145336	3.99
MTD#710-0890	0.1	8145831	3.99
MTD#710-0380	0.1	8145849	3.99
MTD#710-0891	0.1	8145856	3.99



- Dual ball bearing crankshaft support offers maximum stability under demanding loads.
- The chain driven overhead cam (OHC) technology ensures more power, less noise and easy starting.
- Heavy duty piston rings and cast iron cylinder liner resist wear and ensure a long engine life.
- Electronic low oil shut-off system



Subaru EX Gas Engines

- Use to power rammers, welders and trowels to generators, pressure washers, log splitters to fun carts - and everything in between
- An automatic decompression system reduces the pulling force required by 30 to 40 percent

	Shaft Size	Electric Start	Wt. (lb)	ITEM	PRICE
A	6 HP EX 3/4"	No	33.8	8367864	349.99
	9 HP EX 1"	No	33.8	8367872	499.99
B	14 HP EX 1"	No	72.8	8367880	799.99
	14 HP EX 1"	Yes	94.9	8367898	899.99

Subaru EH Gas Engines

- V-Twin cylinder design delivers high power and performance in a small package and are ideal for a variety of industrial and construction equipment
- Features a full pressure lubrication system with replaceable filter
- The large capacity air cleaner with dual elements enhances reliability

	Shaft Size	Electric Start	Wt. (lb)	ITEM	PRICE
C	20 HP EH 1"	Yes	105.5	8367906	1499.99
D	28 HP EH 1-1/8"	Yes	153.0	8367914	1999.99

*Gas engine start switch is not included



Horizontal Shaft Gas Engines

OHV	Fuel Tank Capacity	Sound Rating	Shaft Size	Wt. (lb)	ITEM	PRICE
7 HP	3.6 litre	68 dB	3/4"	30.0	8368383	249.99
9 HP	3.6 litre	70 dB	3/4"	61.6	8368433	349.99
13 HP	6 litre	72 dB	1"	70.0	8368441	499.99

Winter Horizontal Shaft Gas Engine

- These winter gas engines feature a weather resistant cover and fuel prime and choke system for easy starting
- 110 V AC Electric and recoil start
- 11 amps @110 V AC



OHV	Fuel Tank Capacity	Sound Rating	Shaft Size	Wt. (lb)	ITEM	PRICE
9 HP	6 litre	70 dB	3/4"	68.2	8368466	469.99
15 HP	6 litre	72 dB	1"	83.6	8368474	549.99

Drive Pulleys



Single Groove V-Belt Pulleys

- For "4L" or "A" belts
- Cast zinc construction with set screws
- Suitable for fractional HP applications



Bore	2" O.D.	2-1/2" O.D.	3" O.D.	3-1/2" O.D.	4" O.D.	4-1/2" O.D.	5" O.D.	6" O.D.
1/2"	8178709	8178741	8178832	8178865	8178907	8179020	8179079	8179178
5/8"	8178725	8178758	8178840	8178881	8178915	8179038	8179111	8179186
3/4"	8178733	8178766	8178857	8178899	8179012	8179053	8179145	8179194
Wt. (lb)	0.3	0.4	0.4	0.5	0.6	0.7	0.7	1.0
PRICE	7.99	9.99	10.99	12.99	12.99	14.99	15.99	16.99



Gas Engine Start Switches

Use with the 20 HP and 28 HP Subaru gas engines

E) Gas Engine Start Switch
8379315 – Wt. 1.1 lb... **69⁹⁹**

F) With Tachometer and Hour Meter
8379109 – Wt. 2.0 lb **159⁹⁹**

PEAK VS NET HORSEPOWER RATINGS

Princess Auto advertises our engines in peak or gross horsepower which is different than actual net HP ratings.

The net horsepower is defined as the measured output of the engine at the crankshaft end which would also be defined as the true horsepower of the engine.

The peak or gross horsepower would be the horsepower the engine would produce working at peak efficiency in relatively idealistic atmospheric conditions.

In all cases the net horsepower should be less than the peak / gross horsepower.



V-Twin Muffler Kit

Muffler kit for the Subaru 20 and 28 HP gas engines

8369779 – Wt. 12.7 lb **119⁹⁹**

Weld-On Pulleys

- Fits W-series hubs
- Hubs sold separately
- Split steel pulleys



O.D.	Wt. (lb)	ITEM	PRICE
3-1/2"	0.3	8033722	8.99
4"	0.5	8033730	9.99
4-1/2"	0.6	8033748	10.49
5"	0.8	8033755	11.99
5-1/2"	1.0	8033771	13.99
6"	1.2	8033789	14.99
6-1/2"	1.4	8033797	15.99
7"	1.6	8033805	16.99
8"	2.1	8033813	19.99
9"	2.9	8033821	23.99
10"	3.4	8033839	25.99
12"	4.0	8033862	31.99
14"	4.8	8033888	44.99
16"	5.8	8033896	49.99

Idle Pulley

- 4" dia.
- 1" wide flat groove
- 5/8" bore with bearings
- Ideal for use as a V-belt tightener

3845500 – Wt. 0.8 lb **29⁹⁹**





UNCOMPROMISING.

There's no room for compromises. Not on the jobsite or on the home front. You demand rugged, reliable power and that's exactly what Subaru delivers. Engines. Generators. All with unrivaled OHC technology and unbeatable 3-year warranty. We leave no room for compromises and neither will you.

***Uncompromising as you.
Insist on Subaru.***

Learn more by visiting subarupower.com
or calling 847.540.7300.





Single Groove Cast Iron Sheaves

With combination groove that will fit "4L" or "A" belts and "5L" or "B" belts

	Model No.	Bore Dia.	Wt. (lb)	ITEM	PRICE
A) SOLID	BK30H	3.15"	1.3	8045635	9.49
	BK32H	3.35"	1.4	8045668	9.99
	BK34H	3.55"	1.7	8045676	10.49
	BK36H	3.75"	1.9	8047243	11.99
	BK40H	3.95"	1.6	8039679	13.99
	BK45H	4.25"	2.1	8045684	12.49
	BK50H	4.75"	2.2	8039695	14.99
	BK55H	5.25"	2.6	8046096	13.99
	BK60H	5.75"	3.1	8046104	15.49
	BK65H	6.25"	3.9	8046112	17.99
B) SPOKED	BK70H	6.75"	3.3	8046120	18.99
	BK80H	7.75"	3.9	8046146	21.99
	BK90H	8.75"	4.1	8046153	24.99
	BK100H	9.75"	6.0	8039711	30.99
	BK120H	11.75"	6.5	8046179	35.99



Double Groove Cast Iron Sheaves

- For use on applications of 5 HP and over
- Extra groove prevents slippage
- Fits "4L" or "A" belts and "5L" or "B" belts

	Model No.	Bore Dia.	Wt. (lb)	ITEM	PRICE
C) SOLID	2BK32H	3.35"	2.2	8046187	16.99
	2BK34H	3.55"	2.2	8039646	19.99
	2BK36H	3.75"	2.7	8046195	18.99
	2BK40H	3.95"	2.9	8046203	19.99
	2BK45H	4.25"	3.5	8046211	20.99
	2BK50H	4.75"	4.2	8046229	21.99
D) SPOKED	2BK55H	5.25"	4.3	8046237	23.99
	2BK70H	6.75"	6.2	8046286	29.99
	2BK80H	7.75"	7.4	8046294	36.99
	2BK90H	8.75"	8.4	8039638	45.99
	2BK120H	11.75"	12.7	8046302	56.99

Bushings

Use with 17 mm bore sprockets

I.D. x O.D.	Wt. (lb)	ITEM	PRICE
3/8" x 17 mm	0.1	8070666	1.99
1/2" x 17 mm	0.1	8070674	1.99
5/8" x 17 mm	0.1	8070682	1.99

Finished Bore Sheaves

- Complete single groove cast iron sheaves; hollow head statically balanced
- 5/8", 3/4", 7/8" bore has set screw and keyway;
- 1/2" bore has set screws only



Model No.	Outside Dia.	Wt. (lb)	1/2" Bore		5/8" Bore		3/4" Bore		7/8" Bore	
			ITEM	PRICE	ITEM	PRICE	ITEM	PRICE	ITEM	PRICE
BK24	2.4"	0.8	8046310	6.49	8046336	6.49	8046344	6.49	-	-
BK25	2.5"	0.8	8046351	6.79	8046377	6.79	8046393	6.79	-	-
BK26	2.6"	0.9	8046419	6.99	8046427	6.99	8046435	6.99	-	-
BK27	2.7"	0.9	-	-	8046443	7.49	8046450	7.49	8046468	7.49
BK28	2.95"	1.1	-	-	8046484	7.99	8046500	7.99	8046518	7.99
BK30	3.15"	1.3	-	-	8046534	8.49	8046542	8.49	8046559	8.49
BK32	3.35"	1.4	-	-	8046567	9.49	8046575	9.49	8046583	9.49



Drive Belts

V-Belts

- Tempered polyester cords for high tensile strength and low elongation
- Anti-static, heat and oil resistant
- Meet or exceed ISO, JIS, BS, SAE, KS, and RMA standards
- V-BELT SIZES measured as follows: A SECTION – 1/2" top width; B SECTION – 21/32" top width
- To determine size, measure the outside circumference of the belt and subtract 2" if "A" BELT and 3" if "B" BELT



Size	F.H.P. Series *	Wt. (lb)	ITEM	PRICE
A22	4L-240	0.2	8064982	3.29
A26	4L-280	0.2	8064990	3.29
A28	4L-300	0.2	8065005	3.29
A29	4L-310	0.2	8065013	3.29
A30	4L-320	0.2	8065021	3.49
A31	4L-330	0.2	8065039	3.49
A32	4L-340	0.2	8065047	3.49
A38	4L-400	0.2	8065104	3.99
A39	4L-410	0.2	8065112	4.49
A40	4L-420	0.3	8065120	4.49
A41	4L-430	0.3	8065138	4.79
A43	4L-450	0.3	8065146	4.79
A46	4L-480	0.3	8065153	4.79
A50	4L-520	0.3	8065161	4.99
A56	4L-580	0.4	8065179	5.49
A58	4L-600	0.3	8065187	5.79

Size	F.H.P. Series *	Wt. (lb)	ITEM	PRICE
B29	5L-320	0.3	8065195	4.99
B40	5L-430	0.5	8065203	6.49
B42	5L-450	0.5	8065211	6.69
B46	5L-490	0.5	8065229	6.89
B48	5L-510	0.5	8065237	6.99
B51	5L-540	0.6	8065245	7.49
B55	5L-580	0.6	8065252	7.99
B58	5L-610	0.7	8065260	8.39
B62	5L-650	0.7	8065278	8.69
B66	5L-690	0.7	8065286	9.49
B70	5L-730	0.8	8065294	9.99
B71	5L-740	0.8	8065302	10.49
B80	5L-830	0.9	8065328	11.49
B81	5L-840	0.9	8065336	11.99
B85	5L-880	0.9	8065344	12.49
B90	5L-930	1.0	8065351	13.99
B95	5L-980	1.1	8065369	14.99

* Common fractional horsepower (F.H.P.) series cross-reference



Split Tapered Bushings

- Select the bushing with the appropriate diameter bore and a sheave with the desired outside diameter
- The bushing and sheave form a completed pulley assembly that clamps tightly to shaft
- Compatible with Browning "H" Series
- Double split barrel provides positive clamping to the shaft

Model No.	Bore Dia.	Wt. (lb)	ITEM	PRICE
HX1/2	1/2"	0.8	8069494	6.99
HX7/8	7/8"	0.7	8069528	6.99
HX1	1"	0.6	8069536	6.99
HX1-1/4	1-1/4"	0.5	8069551	6.99
HX1-3/8	1-3/8"	0.4	8069569	6.99
HX1-1/2	1-1/2"	0.3	8069577	6.99

Weld On Sprockets

- Sprockets and sprocket hubs sold separately
- For 3/8", 1/2", 5/8", 3/4" pitch roller chain



Teeth	3/8" Pitch/#35 Chain				1/2" Pitch/#40 Chain			
	Hub	Wt. (lb)	ITEM	PRICE	Hub	Wt. (lb)	ITEM	PRICE
12	-	-	-	-	V	0.1	3848827	2.99
13	-	-	-	-	V	0.2	3844537	3.49
14	-	-	-	-	V	0.2	3844545	3.49
15	-	-	-	-	V	0.2	3844552	3.49
16	V	0.1	3844008	2.99	W	0.2	3844560	3.99
17	-	-	-	-	W	0.3	3844578	3.99
18	V	0.1	3840070	3.29	W	0.3	3844586	3.99
19	-	-	-	-	W	0.4	3844594	4.39
20	V	0.1	3844016	3.99	X	0.3	3844602	4.69
22	W	0.3	3840072	3.99	-	-	-	-
24	W	0.2	3844024	4.49	X	0.6	3844636	6.29
26	W	0.3	3840073	4.99	X	0.7	3844644	6.99
28	W	0.3	3844032	5.49	X	0.9	3844651	8.49
30	W	0.4	3840074	5.49	X	1.0	3844669	9.49
32	-	-	-	-	X	1.3	3844677	9.99
32	W	0.5	3844040	6.99	X	1.8	3844685	11.99
40	W	0.7	3840076	8.49	X	2.1	3844693	13.99
45	W	0.9	3840077	10.49	X	2.6	3844701	17.49
48	W	1.1	3844057	9.29	X	3.1	3844719	19.79
54	-	-	-	-	X	3.9	3844081	21.99
60	W	1.7	3844065	15.49	X	4.9	3844099	26.99
72	W	2.5	3844073	17.99	-	-	-	-

Idler Sprockets

- All 17 mm. bore sprockets can easily be changed to 5/8", 1/2" or 3/8" bore by using a pair of bushings listed
- Hardened tooth, zinc plated finish



# Of Teeth	Chain Size	Bore	Wt. (lb)	ITEM	PRICE
17	40	17 mm	0.5	8069932	7.49
15	50	17 mm	0.6	8069940	7.89
17	50	17 mm	0.9	8069957	8.99
13	60	17 mm	0.8	8069965	9.49
15	60	17 mm	1.1	8069973	10.99
12	80	3/4"	1.5	8069981	13.99

Drive Plates

- Designed to be welded to "W" series weld-on hubs
- Select the hub with the desired bore
- Weld it to the drive plate with the required bolt pattern to build a drive hub

Wt. 2.1 lb

2080307 - 4-Bolt Drive Plate

2080315 - 5-Bolt Drive Plate **14⁹⁹**/ea

W-Series Splined Hub

- 7/8" x 13-spline
- Pilot hole dia.: 1-5/8"

3840469 - Wt. 0.7 lb **16⁹⁹**



Drive Sprockets



Teeth	5/8" Pitch/#50 Chain				3/4" Pitch/#60 Chain			
	Hub	Wt. (lb)	ITEM	PRICE	Hub	Wt. (lb)	ITEM	PRICE
9	-	-	-	-	V	0.3	3844917	5.49
10	V	0.2	3844727	4.49	-	-	-	-
11	-	-	-	-	V	0.4	3844933	5.99
12	W	0.2	3844743	4.99	V	0.5	3844941	6.49
13	W	0.3	3844750	5.49	-	-	-	-
14	W	0.3	3844768	5.99	W	0.8	3844966	6.99
15	W	0.4	3844776	5.99	X	0.8	3844974	7.49
16	W	0.5	3844784	5.99	X	0.9	3844982	7.99
17	X	0.5	3844792	6.29	-	-	-	-
18	X	0.6	3844800	6.49	X	1.3	3845005	8.49
20	-	-	-	-	X	1.8	3840090	10.99
22	X	1.1	3840078	8.99	-	-	-	-
24	X	1.3	3844859	8.99	X	2.7	3840091	13.99
26	X	1.6	3844867	9.99	-	-	-	-
28	X	1.9	3844875	10.99	X	3.9	3840098	17.49
30	-	-	-	-	X	4.5	3845088	18.49
32	X	1.0	3840079	16.49	-	-	-	-
32	X	3.3	3844909	16.99	-	-	-	-
42	X	4.6	3840084	23.49	-	-	-	-
48	X	6.2	3840088	26.99	-	-	-	-
54	-	-	-	-	X	16.1	3840115	54.99

Weld-On Hubs

- Machined to eliminate special jiggling
- Simply clamp hub to sprocket or pulley and weld
- Round bore with keyway and set screw



Bore	V-Series Hubs Pilot hole dia: 1-1/8"				W-Series Hubs Pilot hole dia: 1-1/8"			X-Series Hubs Pilot hole dia: 2"		
	Wt. (lb)	ITEM	PRICE	Wt. (lb)	ITEM	PRICE	Wt. (lb)	ITEM	PRICE	
1/2"	0.4	3845096	4.49	0.9	3845138	5.49	-	-	-	
5/8"	0.3	3845104	4.49	0.8	3845153	5.49	1.6	3845294	5.99	
3/4"	0.3	3845112	4.49	0.8	3845179	5.49	1.6	3845310	5.99	
7/8"	0.3	3845120	4.49	0.7	3845195	5.49	1.5	3845336	5.99	
1"	-	-	-	0.6	3845211	5.49	1.4	3845351	5.99	
1-1/8"	-	-	-	0.6	3845237	5.49	1.3	3845377	5.99	
1-3/16"	-	-	-	0.5	3845252	5.49	1.3	3845385	5.99	
1-1/4"	-	-	-	-	-	-	1.2	3845393	5.99	
1-3/8"	-	-	-	-	-	-	1.0	3845419	5.99	
1-7/16"	-	-	-	-	-	-	1.1	3845427	5.99	
1-1/2"	-	-	-	-	-	-	1.0	3845435	5.99	

Clutches

Disc & Caliper Brake Assembly

Use on snowmobiles, go-carts, mini bikes & garden tractors

A) Caliper Mounting Bracket

For brake assembly

4760002 - Wt. 0.5 lb **14⁹⁹**

B) Disc Caliper

• 16 mounting positions

• Replaceable 1.8 sq. in. automotive brake puck (7470005)

• Use with 4760179 - 6-3/8" dia. disc with 1" bore keyed hub

4760161 - Wt. 1.4 lb **69⁹⁹**

C) Brake Disc

• Use on snowmobiles, go-carts, mini bikes & garden tractors

• For use with 4760161 - Disc caliper brake assembly

4760179 - Wt. 1.9 lb **29⁹⁹**

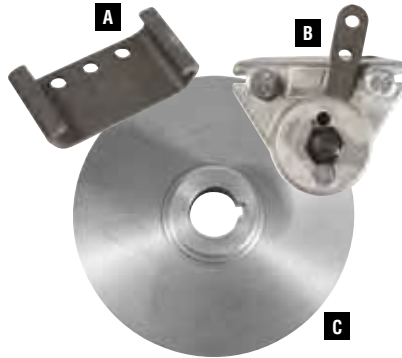

Bearing Assemblies

Size	G) Bearings with Eccentric Locking Collar			H) Pillow Block with Bearing			I) Flange Mount with Bearing			J) 2 pc Pressed Steel with Bearing		
	Wt. (lb)	ITEM	PRICE	Wt. (lb)	ITEM	PRICE	Wt. (lb)	ITEM	PRICE	Wt. (lb)	ITEM	PRICE
1/2"	0.3	3870070	7.49	1.3	3870003	11.99	1.0	3870071	11.99	0.6	3870326	10.99
5/8"	0.3	3870912	7.49	1.3	3870011	11.99	1.0	3870072	11.99	0.6	3870334	10.99
3/4"	0.4	3870920	7.49	1.5	3870029	11.99	1.3	3870185	11.99	0.7	3870342	10.99
7/8"	0.5	3870938	7.49	1.7	3870037	11.99	1.7	3870041	11.99	0.9	3870359	10.99
1"	0.4	3870953	7.49	1.7	3870052	11.99	1.6	3870219	11.99	0.8	3870375	10.99



Bearing Components

Create your own bearing assembly by inserting the bearing size you need into the housing of your choice.

Size	K) Bearings with Eccentric Locking Collar			L) Pillow Block			M) Flange Mount			N) 2 pc Pressed Steel		
	Wt. (lb)	ITEM	PRICE	Wt. (lb)	ITEM	PRICE	Wt. (lb)	ITEM	PRICE	Wt. (lb)	ITEM	PRICE
1-1/8"	0.7	3870961	8.49	2.1	3870054	7.99	1.6	3870059	8.99	0.6	3870068	5.99
1-3/16"	0.7	3870979	8.99	2.1	3870054	7.99	1.6	3870059	8.99	0.6	3870068	5.99
1-1/4"	1.2	3870987	10.49	2.4	3870055	8.99	2.2	3870061	8.49	0.7	3870069	5.99
1-3/8"	1.1	3870050	10.99	2.4	3870055	8.99	2.2	3870061	8.49	0.7	3870069	5.99
1-7/16"	1.0	3870051	10.99	2.4	3870055	8.99	2.2	3870061	8.49	0.7	3870069	5.99
1-1/2"	1.5	3871027	13.99	2.9	3870056	9.99	2.5	3870062	9.99	-	-	-
1-3/4"	1.5	3871043	15.99	3.2	3870057	9.99	3.2	3870064	10.99	-	-	-
1-15/16"	1.7	3870049	18.99	4.2	3870058	11.49	-	-	-	-	-	-



Single Strand Roller Chain

• Built to ANSI standards

• Solid rollers, precision hardened

• Pre-stretched, pre-loaded, pre-lubricated

• Roller chain rolls include one connecting link

D) Roller Chain (10 ft Roll)

ASA No.	Pitch	Wt. (lb)	ITEM	PRICE
35	3/8"	2.4	3842101	15.99
40	1/2"	4.4	3842317	15.99
41	1/2"	2.8	3850476	17.99
50	5/8"	7.2	3842325	23.99
60	3/4"	10.2	3842333	31.99
60 H*	3/4"	12.0	3842135	34.99
80	1"	17.5	3842341	54.99

* With extra heavy side plates

E) 2 pk Connecting Link

ASA No.	Pitch	Wt. (lb)	ITEM	PRICE
35	3/8"	0.1	3840178	1.99
40	1/2"	0.1	3840179	1.99
41	1/2"	0.1	3840180	1.99
50	5/8"	0.1	3840181	1.99
60	3/4"	0.1	3840182	2.49
60 H*	3/4"	0.1	3840183	2.99
80	1"	0.3	3840184	3.79

F) 2 pk Offset Link

ASA No.	Pitch	Wt. (lb)	ITEM	PRICE
35	3/8"	0.1	3840171	2.79
40	1/2"	0.1	3840172	2.79
41	1/2"	0.1	3840173	2.79
50	5/8"	0.1	3840174	2.79
60	3/4"	0.1	3840175	3.49
60 H*	3/4"	0.2	3840176	3.99
80	1"	0.3	3840177	5.49

Roller Chain Breaker

For quick, easy work of roller chain disconnections

#25 to #60 chain

8039311 - Wt. 0.8 lb **29⁹⁹**

#60 to #100 chain

8039320 - Wt. 1.5 lb **49⁹⁹**

Chain Puller

• Aids in the installation of connecting links

• Used to pull and hold the ends of roller chain

• Suitable for sizes: ANSI 40 & 50 series

8105827 - Wt. 0.8 lb **14⁹⁹**



3/4" Single Pulley Centrifugal Clutch

- Excellent for industrial, utility, or go-cart applications up to 13 HP
- 1,800 RPM engagement
- Fits both A or B section V-belts



Bore	Pulley O.D.	Keyway	Wt. (lb)	ITEM	PRICE
3/4"	3"	3/16"	3.8	8300733	99.99
1"	3"	1/4"	3.6	8300709	99.99



Centrifugal Chain Clutches

- Bi-directional operation
- Up to 13 HP
- Sintered metal shoes for the ultimate in proper weight, wear ability, and heat dissipating qualities



Bore	# Of Teeth	Chain Pitch	Outside Dia.	Wt. (lb)	ITEM	PRICE
5/8"	10	#40/41	4"	2.7	8300667	59.99
3/4"	12	#35	4"	2.6	8300659	59.99
3/4"	10	#40/41	4"	2.6	8300600	59.99
1"	14	#40/41	4"	3.1	8300675	109.99

Turntable Bearings

- All metal construction
- Turn on ball bearings
- Mounts to metal, wood or plastics



	Size	Load Cap.	Wt. (lb)	ITEM	PRICE
E	3" square	200 lb	0.2	8148462	4.99
	4" square	300 lb	0.3	8148470	5.49
	6" square	500 lb	0.5	8148488	5.99
F	9" round	750 lb	0.9	8148496	8.99
	12" round	1,000 lb	1.6	8148504	11.99

Bushings



Sintered Bronze Bushings

Oil impregnated, self lubricating, bronze bushings



Bore	O.D.	Wt. (lb)	ITEM	PRICE	Bore	O.D.	Wt. (lb)	ITEM	PRICE
1/4"	3/8"	0.1	3872009	4.49	5/8"	7/8"	0.2	3872090	8.49
1/4"	1/2"	0.1	3872017	4.99	5/8"	1"	0.3	3872108	9.99
3/8"	1/2"	0.1	3872025	3.99	3/4"	7/8"	0.1	3872116	5.49
3/8"	5/8"	0.1	3872033	6.49	3/4"	1"	0.2	3872124	7.99
3/8"	3/4"	0.1	3872041	7.49	7/8"	1"	0.1	3872132	5.49
1/2"	5/8"	0.1	3872058	4.49	7/8"	1-1/8"	0.2	3872140	8.49
1/2"	3/4"	0.1	3872066	6.49	1"	1-1/4"	0.1	3872157	6.49
1/2"	7/8"	0.2	3872074	8.49	1"	1-3/8"	0.2	3872165	7.99
5/8"	3/4"	0.1	3872082	5.49	1"	1-1/2"	0.4	3872173	9.99



A) Steady Bearings

- For drive shafts and similar applications
- Medium duty self-aligning bronze bearing

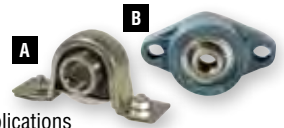

Wt. 0.7 lb

8180978 - 3/4"

8180986 - 7/8"

8180994 - 1"

10⁹⁹_{/ea}

B) 2-Bolt Flange Bearing Assemblies

Wt. 0.8 lb

3870169 - 1/2"

3870177 - 5/8"

10⁹⁹_{/set}



Replacement Ball Bearing

- Light and medium series bearing are sealed on both sides
- Bearing numbers represent the common standard numbering for all ball bearings



Bearing No.	O'all Dim. (mm) ID. X O.D. X W	Wt. (lb)	ITEM	PRICE
6200-2RS	10 x 30 x 9	0.1	3850609	1.99
6201-2RS	12 x 32 x 10	0.1	3850617	2.49
6202-2RS	15 x 35 x 11	0.1	3850625	2.49
6202-16-2RS	16 x 35 x 11	0.1	3850633	3.49
6202-5/8-2RS	5/8" x 35 x 11	0.1	3850641	3.99
6203-2RS	17 x 40 x 12	0.2	3850658	3.99
6203-5/8-2RS	5/8" x 40 x 12	0.2	3850666	3.99
6203-3/4-2RS	3/4" x 40 x 12	0.1	3850674	3.99
6204-2RS	20 x 47 x 14	0.2	3850682	3.99
6205-2RS	25 x 52 x 15	0.3	3850690	3.99
6205-1-2RS	1" x 52 x 15	0.3	3850708	5.99
6304-2RS	20 x 52 x 15	0.3	3850823	5.99
6206-2RS	30 x 62 x 16	0.5	3850716	7.99



Speed Reducers

- Cast iron housing
- Output shaft: 2-3/8" long
- Input shaft: 5/8" dia., output shaft: 1" dia



C) Standard

Ratio	Max. Output (in-lb)	Max. Input HP	Wt. (lb)	ITEM	PRICE
15:1	1,100	2-1/2	30.0	3840043	149.99
30:1	1,100	1-3/4	29.7	3840046	149.99
40:1	1,100	1-1/4	29.7	3840047	149.99
60:1	1,100	15/16	29.5	3840051	159.99
100:1	1,200	1/2	37.6	3840127	249.99

D) With Flange Mount

Ratio	Max. Output (in-lb)	Max. Input HP	Wt. (lb)	ITEM	PRICE
60:1	1,000	1/2 - 1	31.0	8008416	239.99

Driveline Components

Flex Couplers

- No lubrication needed
- Easily assembled or disassembled
- Spiders are easily inspected at any time
- No wear on metal jaws
- Comes with set screws
- Make sure when ordering that body pieces and rubber spider are from the same series
- Complete Coupling Consists of 3 pieces: BODY - SPIDER - BODY (sold separately)



Series	L-050	L-095	L-099
Capacity @ 1,200 RPM	0.49 HP	3.60 HP	6.00 HP
Capacity @ 1,800 RPM	0.74 HP	5.40 HP	9.00 HP
Capacity @ 3,600 RPM	1.47 HP	10.8 HP	17.99 HP
Outside diameter	1-5/64"	2-1/8"	2-9/16"
Overall length (complete)	1-3/4"	2-1/2"	2-7/8"
Approximate weight	0.1 lb	0.6 lb	1.2 lb

Bore Size	Keyway	ITEM	ITEM	ITEM
1/4"	-	3852019	-	-
5/16"	-	3852035	-	-
3/8"	-	3852027	-	-
1/2"	1/8"	3852191	3840550	3840675
9/16"	1/8"	-	3840568	-
5/8"	3/16"	3852043	3840576	3840691
3/4"	3/16"	-	3840592	3840717
7/8"	3/16"	-	3840618	3840733
1"	1/4"	-	3840634	3840758
1-1/8"	1/4"	-	-	3840766
Price for 1 Body		4.79	11.99	13.99
Spider only		3852050	3840659	3840774
		2.99	6.99	9.99

Universal Joints

- Standard type U-joints
- Designed for use on power take-offs, hydraulic hoists, farm implements and other similar applications
- Forged steel yokes and crosses, accurately machined and heat treated on all wearing surfaces
- Max. recommended torque continuous duty: 1,000 RPM, 400 in.-lb (approx. 6.3 HP)
- Max. recommended angle of operation: 15° continuous, 45° slow speed
- 3/8"-16 set screws



Size & Slip Size	Wt. (lb)	ITEM	PRICE
3/4" R x 3/4" R	2.5	8087157	29.99
1" R x 1" R	2.3	8087165	29.99
3/4" R x 3/4" Sq.	2.6	8087181	29.99
7/8" R x 3/4" Sq.	2.4	8087199	29.99
1" R x 3/4" Sq.	2.3	8087215	29.99
1" R x 7/8" Sq.	2.3	8087223	29.99

Keyed Shafting

- Material: C 1018 round bar
- 65,000 lb tensile strength
- Driveline quality round bar
- Keyway cut down the entire length of shaft



Shaft Size	Key Size	Wt. (lb)	ITEM	PRICE
1/2" x 3 ft	1/8"	1.9	8079717	22.99
5/8" x 3 ft	3/16"	2.9	8079725	24.49
3/4" x 3 ft	3/16"	4.3	8079733	32.99
7/8" x 3 ft	1/4"	5.3	8079741	34.99
1" x 3 ft	1/4"	7.7	8079758	48.99
1" x 6 ft	1/4"	15.8	8079766	84.99

Keystock

Size	Wt. (lb)	ITEM	PRICE
1/8" x 12"	0.1	8137010	1.99
3/16" x 12"	0.1	8075269	2.29
1/4" x 12"	0.2	8075277	2.49
5/16" x 12"	0.3	8075285	2.99
3/8" x 12"	0.5	8075293	3.99

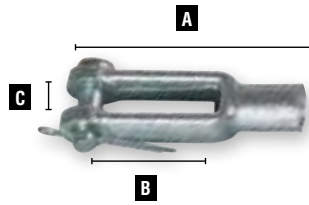

Adjustable Clevises with Pin

1/4"-28 NF Thread Size

A: 2", B: 1-1/4", C: 9/32"

3880036 - Wt. 0.1 lb **4.49**

5/16"-24 NF Thread Size

A: 2-1/4", B: 1-7/16", C: 11/32"

3880044 - Wt. 0.1 lb **4.69**

3/8"-24 NF Thread Size

A: 2-1/2", B: 1-5/8", C: 7/16"

3880051 - Wt. 0.2 lb **4.79**

1/2"-20 NF Thread Size

A: 3", B: 1-7/8", C: 9/16"

3880069 - Wt. 0.4 lb **5.99**

Looking for the perfect gift?
GIFT CARDS
 are available at any Princess Auto location

Shaft Collars

- Collars are made of zinc plated weldable mild steel
- Comes with set screw



Bore	Wt. (lb)	ITEM	PRICE
3/16"	0.1	3871266	1.99
1/4"	0.1	3871274	1.99
5/16"	0.1	3871282	1.99
3/8"	0.1	3871290	1.79
7/16"	0.1	3871308	1.79
1/2"	0.1	3871316	1.99
9/16"	0.1	3871324	1.99
5/8"	0.1	3871332	2.99
3/4"	0.1	3871340	2.49
7/8"	0.2	3871357	2.49
1"	0.2	3871365	2.49
1-1/8"	0.2	3871373	2.99
1-1/4"	0.4	3871399	3.49
1-3/8"	0.4	3871407	4.49
1-1/2"	0.5	3871423	4.99

Rod Ends

Wt. 0.2 lb



Thread Size	ITEM	PRICE	ITEM	PRICE
1/4"-28 NF	3870009	2.99	3870020	8.99
5/16"-24 NF	3870010	3.29	3870021	9.99
3/8"-24 NF	3870012	4.49	3870022	11.99
1/2"-20 NF	3870013	8.49	3870023	21.99

Rod Ends

Wt. 0.1 lb



Thread Size	ITEM	PRICE	ITEM	PRICE
1/4"-28 NF	8289191	11.99	8289258	8.99
5/16"-24 NF	8289209	12.99	8289266	9.99
3/8"-24 NF	8289217	14.99	8289274	11.99
1/2"-20 NF	8289225	24.99	8289282	22.99
5/8"-18 NF	8289233	29.99	8289290	27.99
3/4"-16 NF	8289241	34.99	8289308	32.99

Control Cable End

Fits up to 5/16" lever thickness with 1/4" hole dia.

8183386 - Wt. 0.1 lb **3.99**



Pivot Pin

Fits up to 3/16" lever thickness with a 1/4" hole dia.

3890502 - Wt. 0.1 lb **4.19**



Cables / Linkage

Remote Control Cables

- 1/2" - 20 mounting threads
- .091" cable end

10 ft long
3890492 - Wt. 1.9 lb **26⁹⁹**

15 ft long
3890493 - Wt. 3.0 lb **32⁹⁹**



Bulk Head Mount Control Cables

- 5/8" - 18 mounting threads
- 1/4"-28 male cable end

Length	Wt.(lb)	ITEM	PRICE
48"	1.5	8183436	36.99
60"	2.0	8183444	37.99
72"	2.1	8183451	38.99
84"	2.3	8183469	39.99

2" Knob

1/4" 28-thread for use on remote control cables, etc.
8183378 - Wt. 0.1 lb **2⁹⁹**

2" Knob

3/8" 24-thread for use on remote control cables, etc.
3891348 - Wt. 0.1 lb **3⁹⁹**



Motors and Controls

Electric Motors

**Motors may not be exactly as shown*



Farm Duty Electric Motors

- Designed for applications requiring high starting torque and moderate starting current
- Reversible shaft rotation, ball bearing design and start capacitors provide versatility for indoor and outdoor use
- Totally enclosed, fan cooled
- 1,800 RPM
- Manual thermal overload protection

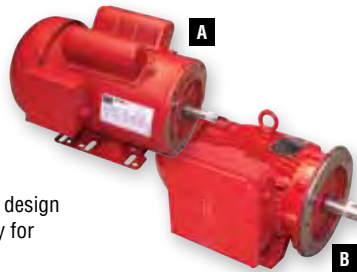

	HP	Volts	Full Load Amps	Shaft Size	Frame Size	Wt. (lb)	ITEM	PRICE
	1/2	115/230	7.4/3.7	5/8"	56C	28.1	8370363	259.99
A	1	115/230	14.0/7.0	5/8"	56HC	37.4	8370389	309.99
	1-1/2	115/230	17.4/8.7	5/8"	56HC	48.9	8370397	379.99
	2	115/230	21.0/10.5	5/8"	56HC	52.6	8370405	479.99
	3	230	14.5	1-1/4"	184TC	97.2	8370413	699.99
	5	230	21.0	1-1/4"	184TC	120.7	8370421	799.99
B	7-1/2	230	32.0	1-3/8"	215TC	170.7	8374035	999.99
	10	230	40.0	1-3/8"	215TC	192.8	8374043	1199.99



Furnace Fan Motors

- 1,725 RPM single speed
- Sleeve bearings, ball bearing
- Reversible, continuous duty, thermally protected, open drip-proof
- Mounts on resilient base or with 1" through bolts
- Features gasket terminal cover, shaft slinger and zinc plated corrosive resistant hardware for use in poultry house / barn applications

NOTE: These motors must be used in a fan application to ensure the motor is sufficiently cooled



HP	Volts	Full Load Amps	Shaft Size	Frame Size	Wt. (lb)	ITEM	PRICE
1/4	115	5.0	1/2"	48Y	13.0	0753699	99.99
1/3	115	6.1	1/2"	48Y	14.7	0752741	109.99
1/2	115	7.2	1/2"	48Y	18.1	0755868	129.99



General Purpose

C-Face Electric Motors

- Ball bearing construction
- Open drip proof design
- Reversible shaft rotation
- Automatic thermal overload protection
- 1.15 service factor
- 3,450 RPM to 3,600 RPM

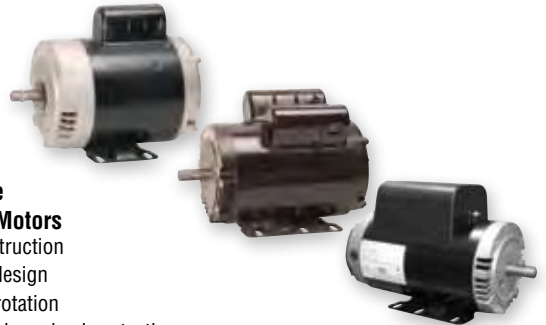

HP	Volts	Full Load Amps	Shaft Size	Frame Size	Wt. (lb)	ITEM	PRICE
1/2	115/208-230	12.8/6.4-6.4	5/8"	56C	20.1	8370439	169.99
1	115/208-230	12.8/6.4-6.4	5/8"	56C	26.1	8370447	189.99
1-1/2	115/230	12.8/6.4-6.4	5/8"	56C	28.6	8370454	229.99
2	115/208-230	17.2/9.2-8.6	5/8"	56HC	34.8	8370462	329.99
5	208-230	13.5-12.5	5/8"	56HC	35.8	8370470	369.99
5	208-230	22.0	3/4"	56HCZ	46.5	8370488	399.99

* No manual reset overload protection

PEAK VS NET HORSEPOWER RATINGS

Princess Auto advertises our engines in peak or gross horsepower which is different than actual net HP ratings.

The net horsepower is defined as the measured output of the engine at the crankshaft end which would also be defined as the true horsepower of the engine.

The peak or gross horsepower would be the horsepower the engine would produce working at peak efficiency in relatively idealistic atmospheric conditions.

In all cases the net horsepower should be less than the peak / gross horsepower.

You think
THIS catalogue
has a lot of
information?

You should check out
princessauto.com
for our newest products, additional
product info and customer reviews.

Linear Actuators

A gear-driven motor extends shaft for opening and closing gates & doors or positioning solar panels



12V DC Linear Actuators

- Built in potentiometer which can be used with the LA-Controller to enable them to extend and retract with up to 3 programmable user presets
- Speed at max. load: 0.50 in/sec
- Recommended fuse: 10A

Stroke	Load Capacity	Static Load	Wt. (lb)	ITEM	PRICE
2"	110 lb	500 lb	2.5	8272486	144.99
4"	110 lb	500 lb	2.7	8272502	144.99
6"	110 lb	500 lb	2.9	8272510	144.99
8"	110 lb	500 lb	3.1	8272536	149.99
12"	110 lb	500 lb	3.5	8272551	149.99



12V DC Linear Actuators

- Load capacity: 500 lb
- Static load: 1,000 lb
- Speed at max. load: 0.51 in/sec
- Recommended fuse: 20A

4" Stroke
8373052 – Wt. 9.5 lb **299⁹⁹**

6" Stroke
8337206 – Wt. 10.1 lb **299⁹⁹**

8" Stroke
8373060 – Wt. 10.9 lb **299⁹⁹**

12" Stroke
8373094 – Wt. 12.1 lb **299⁹⁹**

18" Stroke
8373102 – Wt. 10.5 lb **429⁹⁹**

24" Stroke
8373169 – Wt. 17.5 lb **449⁹⁹**



12V DC Linear Actuators

- Load capacity: 1,000 lb
- Static load: 3,000 lb
- Speed at max. load: 0.55 in/sec
- Recommended fuse: 20A

5.3" Stroke 1,000 lb
8373128 – Wt. 11.1 lb **399⁹⁹**

7.3" Stroke 1,000 lb
8373144 – Wt. 11.7 lb **399⁹⁹**

11.3" Stroke 1,000 lb
8373151 – Wt. 12.8 lb **399⁹⁹**

Looking for the perfect gift?

GIFT CARDS

are available at any Princess Auto location



E) Linear Actuator Controller

- 3 user programmable presets accessed via the push-button display
- Complete with display, central control unit, wiring harness and mounting hardware

8272676 – Wt. 0.6 lb **79⁹⁹**

F) Linear Actuator Controller Extension Harness

10 ft long
8272684 – Wt. 0.3 lb **19⁹⁹**

G) Linear Actuator Mounting Bracket

- 2 needed per linear actuator
 - Billet machined from solid aluminum to provide the greatest strength possible
- 8272650 – Wt. 0.2 lb **15⁹⁹**

Switches



Switches

Rated 6A @ 125V, 3A @ 300V

	Style	Head Type	Type of Contact	Wt. (lb)	ITEM	PRICE
A	Momentary Push	Standard	N.O.	0.1	0700318	3.49
	Momentary Push	Standard	N.O. or N.C.	0.1	0700320	4.49
B	Emergency Stop	Push Lock	N.O. or N.C.	0.1	0700322	7.49
	2-Position Select	Knob	N.O.	0.1	0700323	4.49
C	3-Position Select	Knob	N.O.	0.1	0700324	5.49
	Direct Type	Green Illuminated	N.O or N.C.	0.1	0700327	6.49

1 Hole Switch Mounting Box

- 2-piece plastic box
- 7/8" mounting hole



Holes	Size	Wt. (lb)	ITEM	PRICE
1	3" x 3" x 2-1/4"	0.2	0700332	5.49
2	3" x 4-1/2" x 2-1/2"	0.3	0700333	6.49

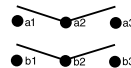

Toggle Switches

- DPDT (double pole, double throw)
- Rated at: 20A @ 12V DC, 15A @ 125V AC, 10A @ 250V AC
- Metal toggle lever, stand and screw terminals with M3 screws
- Can be used for power pack and solenoid valve activation

Wt. 0.1 lb

8161721 – On / off / on

8161713 – On / off / on (momentary) **3⁹⁹/ea**



H) 12V Push/Pull Switch
8224909 – Wt. 0.1 lb **149**

I) Rocker Switch
• SPST
• 16A @ 125V AC, 10A @ 250V AC
0700285 – Wt. 0.1 lb **159**

J) Toggle Switch
• SPST
• 16/10A @ 125/250V AC
0700284 – Wt. 0.1 lb **399**

Motor Reversing Switch

- Rated up to 1 HP, 110/220V, single phase
 - For starting, stopping and reversing electric motors on tools, hoists and conveyors
 - 15A
 - Steel housing with enamel
- 8000790 – Wt. 0.5 lb **22⁹⁹**



Motor Reversing Switch

- Rated up to 1 HP, 110/220V, single phase
 - For starting, stopping and reversing electric motors on tools, hoists and conveyors
 - Pure copper forged contacts
 - Heavy copper drum segments
 - Lever can be set to momentary or to lock
- 8078693 – Wt. 1.3 lb **54⁹⁹**



SWITCHES

An electrical switch is any device used to interrupt the flow of electrons in a circuit.

The simplest type of switch is one where two electrical conductors are brought in contact with each other by the motion of an actuating mechanism. The final output of any switch will be a pair of wire-connection terminals that will either be connected together by the switch's internal contact mechanism ("closed"), or not connected together ("open").

TECH TIP

Always have a certified electrician install any electrical components.

Electric Motor Accessories

12V DC Two Function Wireless Remote

- Use to wirelessly turn on or off 2 different 12V DC circuits
- Possible applications include 12V DC double-acting power packs, single acting power packs, solenoid valves etc.
- Designed to provide highly dependable, functional, virtually maintenance free service over the lifespan of the unit
- This system has an ON / OFF and two outputs that are controlled by the remote

8311078 – Wt. 1.0 lb **259⁹⁹**



E) DIN Connector

Replacement for 12V DC D03 and D05 solenoid valves

8045791 – Wt. 0.1 lb **6⁹⁹**

Replacement for 110 VAC D03 solenoid valve (8168544)

8168551 – Wt. 0.1 lb **6⁹⁹**



12V DC Relay

- A low amperage signal will connect a high amperage circuit and can be used in many applications including power packs, power supplies and car stereos

• Max. current rating: 150A
8262800 – Wt. 0.5 lb **24⁹⁹**

2 Switch Remote Control Handle

- Two normally open, (SPST) single pole, single throw momentary switches
- Pre-wired with 19" leads
- Micro switch specifications: 16 A (resistive) @ 250V AC
- Internal handle threading: M10

8269144 – Wt. 0.6 lb **59⁹⁹**

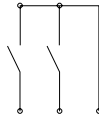

Pilot Lamps

- 110V AC
- Rounded top, flat base
- Mounting hole: 22 mm (7/8")
- Neon bulb
- CSA approved

Wt. 0.1 lb

0700404 – Amber

8219677 – Red Pilot Lamp

0700405 – Green Pilot Lamp **3⁹⁹** /ea



6 Digit Mechanical Counter

- Steel housing construction
- 0 to 999,999

0700395 – Wt. 0.2 lb **7⁹⁹**



Princess Auto Foundation



Together we are making a difference

for our future customers. By providing bursaries to Canadian Colleges throughout Canada we demonstrate our support for the trades.

Work with the hands-give from the heart.

For more information visit us at

www.theprincessautofoundation.com

PAF PARTNERS



MONDETTA



Charitable # 833179369 RR00041

pro.point

hard.working.tools.



EXCLUSIVELY AT: PRINCESS AUTO





SURPLUS



Discover it for yourself! >>>>>

***We're constantly finding unique products, so
come and discover new items every week!***

Computer Accessories

Holiday Photo Cards

20 sheets, 5" x 7"
8359333 – Wt. 0.6 lb **19⁹⁹**



4-in-1 Retractable Cable Kit

• 4 ft cable with USB / mini USB / modem/network ends
• Made by GE
8283111 – Wt. 0.2 lb **8⁹⁹**



Mouse

• 2 button
• PS/2 connectivity
8206062 – Wt. 0.4 lb **3⁹⁹**



Computer Microphone

8369654 – Wt. 0.2 lb **1⁹⁹**



Assorted Computer Games

8324857 – Wt. 0.1 lb **1⁹⁹**



CD Photo Album

Package includes 10 CD-RW, CD album, photo album/labelling software, label applicator and 10 disc labels and inserts
8233777 – Wt. 2.3 lb **12⁹⁹**



USB Sync Charger

• Designed for Palm Tungsten W, C, T, T2, T3, Zire 71, m130, m500 and i705 series
• Features a USB cable and a 12V charger
• Made by Belkin
8290595 – Wt. 0.3 lb **8⁹⁹**



USB Quick Connect

A) Mini
• Connect all wires with this USB A/5-pin B connector
• Made by Philips
8274722 – Wt. 0.1 lb **6⁹⁹**

B) 4-in-1
10 ft 2.0 cable, A male, B male, mini A male, mini B male connectors and a bag
8290207 – Wt. 0.4 lb **9⁹⁹**



Screen Protectors

3 pk of 1-5/8" x 1-5/8" screen protectors with cleaning cloth
8252728 – Wt. 0.1 lb **2⁹⁹**



Lock

Keep your data secured with this USB thumbdrive lock
8162737 – Wt. 0.2 lb **1⁹⁹**



Audio / Video Cables

HDMI Cables

High Speed HDMI with Ethernet

Length (ft)	Version	Wt. (lb)	ITEM	PRICE
3	1.4c	0.2	8315293	6.99
3.3	1.4c	0.1	8302358	9.99
6.5*	1.4c	0.3	8310179	9.99
6.6	1.4c	0.3	8281297	12.99
10	1.4c	0.4	8315301	12.99
9.8	1.4c	0.3	8281339	14.99
13.1	1.4c	0.4	8281347	19.99

*90° angle on one end



1,600W Wiring Kit
8000314 – Wt. 4.9 lb **59⁹⁹**

8 ft THX Audio Cable

Made by Monster Cable
8260176 – Wt. 0.5 lb **6⁹⁹**



Audio Cable

Interlink 101 XLN

Length (ft)	Made by	Wt. (lb)	ITEM	PRICE
3.3	Monster Cable	0.2	8159782	4.99
9.9	Monster Cable	0.3	8159816	4.99



Audio Cables

Length (ft)	Made by	Wt. (lb)	ITEM	PRICE
6	Piranha	0.6	8331449	4.99
6	Tsunami	0.4	8199416	4.99
6	Piranha	0.9	8331456	6.99
10	RCA	0.4	8258634	6.99
12	Piranha	1.4	8331431	9.99



High Speed HDMI

Length (ft)	Version	Wt. (lb)	ITEM	PRICE
15.5	1.3c	0.7	8315327	19.99
16.4	1.3c	0.5	8281362	24.99
32.8	1.3c	1.3	8281388	49.99
49.2	1.3c	2.6	8296642	99.99
82	1.3b	3.3	8302341	189.99



2-Way Splitter

• 1 in 2 out video splitter
• Made by Philips
8252363 – Wt. 0.1 lb **1⁹⁹**



RG6 "F" Extension Adapter

• 2 pk
• Made by GE
8304107 – Wt. 0.1 lb **1⁹⁹**



Coaxial Cable Transformer

• Converts antenna wires from input to output
• Made by Philips
8315020 – Wt. 0.1 lb **99¢**



S-Video Cables

Length (ft)	Made by	Wt. (lb)	ITEM	PRICE
6	Philips	0.3	8310914	6.99
6	Piranha	0.5	8330862	12.99
12	Acoustic Research	1.0	8322497	8.99
12	RCA	0.7	8273971	9.99



Coaxial Crimp-on Ends

RG 59, 4 pk
8328544 – Wt. 0.1 lb **1⁹⁹**

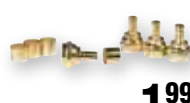

4 ft Video Cable

Made by Monster Cable
8260168 – Wt. 0.3 lb **2⁹⁹**



6 ft Video and Audio Cables

8328551 – Wt. 0.5 lb **9⁹⁹**



Composite Cables

Length (ft)	Made by	Wt. (lb)	ITEM	PRICE
6	Piranha	1.1	8331423	8.99
12	Piranha	1.9	8331415	12.99



HDTV Compatible Indoor/Outdoor Diplexer

• Allows you to combine your satellite, cable or antenna signal into one
• Made by Philips
8266959 – Wt. 0.5 lb **8⁹⁹**



Ultra Thin Coaxial Cables

C) 12 ft
• Ideal to hide under carpets or baseboards
• Made by Philips
8156648 – Wt. 0.1 lb **2⁹⁹**

D) 6.6 ft
8349060 – Wt. 0.3 lb **4⁹⁹**



6 ft Camcorder Cable

With S-video cable
8324576 – Wt. 0.8 lb **8⁹⁹**



6 ft Mini Camcorder HDMI Cable

8382707 – Wt. 0.3 lb **12⁹⁹**





Cord Organizer Kit

- 134 pc cord organization solution made by Gardner Bender
- 75 cable ties, 14 ft of spiral wrap, 20 wire labels, 14 adhesive clips, 12 staple mounts, 10 velcro straps and 5 ft of flex tubing

8258535 – Wt. 1.0 lb **9⁹⁹**

S-Video Extension Cables

Length (ft)	Wt. (lb)	ITEM	PRICE
12	0.7	8332850	8.99
50	2.2	8332827	14.99



4 ft THX Component Video Cable

Made by Monster cable
8294605 – Wt. 1.1 lb **9⁹⁹**



6 ft Component Video and Audio Cables

24K gold connectors
8322364 – Wt. 2.0 lb **14⁹⁹**



Component Video Cables

Length (ft)	Made by	Wt. (lb)	ITEM	PRICE
6	Piranha	1.1	8330938	9.99
6*	–	1.4	8322372	14.99
8	–	0.8	8313512	9.99



*24K gold connectors



TV Top Shelf

- Adjustable to fit most TVs and monitors
- Ideal for VCRs, DVD players and speakers
- 15-3/4" x 15-7/8"

8302739 – Wt. 2.7 lb **6⁹⁹**

Audio Accessories



A) iPod Speakers

Compatible with all MP3 players and first/second generation iPod Nano
Wt. 0.3 lb

8226771 – White **1⁹⁹**
8226797 – Black **1⁹⁹** /ea



B) Portable Speaker Dock

Designed for iPods and MP3s
8273112 – Wt. 0.3 lb **4⁹⁹**



C) Folding Speaker

- Amplified travel speakers made by Craig
- Ideal for laptops, portable DVD/CD players, MP3s and iPods
- Requires 4 AA batteries (not included)

8251472 – Wt. 0.6 lb **6⁹⁹**



D) Beach Radio and MP3 Speaker

Compatible with all iPods and MP3 players
8323313 – Wt. 1.5 lb **9⁹⁹**



E) Rocket Sound Speakers

- Compatible with iPods and MP3 players
- Made by GoStereo

Dual Cone Speakers

25W
F) 4 X 10" **14⁹⁹**
8384679 – Wt. 1.3 lb
G) 5 X 7" **4⁹⁹** /ea
8384687 – Wt. 1.1 lb



H) 5" 2-Way Speakers

- 5-1/4" round coaxial 2-way speaker
- Great replacement or upgrade speaker
- Heavy duty magnet.

8001331 – Wt. 2.8 lb **18⁹⁹**

Lighted Baseball Bopper Headband

8331860 – Wt. 0.3 lb **2⁹⁹**



Hands Free Tape Holster

Attaches to your belt for an easier application
8249369 – Wt. 0.5 lb **4⁹⁹**



iPod Nano Skins

2 pk of silicone skins
8311474 – Wt. 0.1 lb **2⁹⁹**



Case

- Hard shelled sound case with a built-in speaker for your iPod / MP3
- Powered by 9V battery (not included)

8204125 – Wt. 0.8 lb **14⁹⁹**



iPod Docking Kit

- iPod windshield mount docking kit with adjustable neck
- Can be use for cell phones and other devices

8219727 – Wt. 0.6 lb **9⁹⁹**



Car Cassette Adapter

Play your portable devices through your car stereo
8322562 – Wt. 0.2 lb **6⁹⁹**



Cassette Adapter Kit

8369431 – Wt. 0.6 lb **12⁹⁹**



10 pk Jewel DVD Cases

8349599 – Wt. 1.4 lb **4⁹⁹**



6-in-1 Universal Remote

8328478 – Wt. 0.4 lb **14⁹⁹**



Subwoofer Cable

- XLN 100 8 ft 12 ga car audio subwoofer cable
- Made by Monster Cable

8183048 – Wt. 0.7 lb **2⁹⁹**



Microphone

- Wired microphone with a protective case
- Made by Trans Continental Studios

8277972 – Wt. 1.0 lb **8⁹⁹**



iPod Remote

- Wireless iPod remote control and receiver
- Controls play, pause, forward / backwards and volume
- Made by Maxell

8270282 – Wt. 0.2 lb **6⁹⁹**



iPod / MP3 Docking Kit

Designed to attach to the louvers of any vehicle's vents, for a clean installation
8252686 – Wt. 0.3 lb **4⁹⁹**



Fm Radio

- Listen to your favourite tunes while on your PC / laptop with iConcept mobile USB FM radio

8137283 – Wt. 0.3 lb **4⁹⁹**



Monster Car Audio Cables

RCA female to 2 male
8328486 – Wt. 0.2 lb **6⁹⁹**



Cell Phone Arm Band

- Ideal for exercise activities
- Can be used with MP3 and iPods
- Motorola

8322299 – Wt. 0.2 lb **12⁹⁹**



GPS Dash Mount

Great for other devices such as cell phones, MP3 players, etc.

8348948 – Wt. 1.7 lb **29⁹⁹**



Universal MP3 Armband Case

- Includes armband, neck strap and belt loop
- 4" x 2" x 3/4"

8316671 – Wt. 0.2 lb **6⁹⁹**



Dash Mount Holder

- Bead filled holder for your electronic devices
- Contours to any dash and features an anti-skid bottom

8332074 – Wt. 2.2 lb **19⁹⁹**



Silicone Super Grip Stick-it Pad

- Helps prevent items from sliding in vehicles
- No adhesive, not magnetic, easy to remove
- 3-3/4" x 6"

8331712 – Wt. 0.1 lb **4⁹⁹**



25 CD / DVD Pages

- Holds up to 200 CD / DVDs
- Designed to be inserted into a binder
- Made by Case Logic

8303646 – Wt. 0.9 lb **9⁹⁹**



A) Headphones

- Universal lightweight earbud headphones
- Ideal for any portable audio system
- Assorted colours

8241119 – Wt. 0.1 lb **4⁹⁹**

B) Neck Band Headphones

8334591 – Wt. 0.2 lb **6⁹⁹**

Power Adapters



Power Adapters

C) 12V DC
8305658 – Wt. 0.2 lb **3⁹⁹**

D) 12 / 24V
• 4.5/6V, 1,000mA
• Designed for negative grounded vehicles
• Made by Maxell
8296154 – Wt. 0.3 lb **8⁹⁹**

E) 3-Way 12V
• Power three 12V devices using one 12V outlet
• Made by Navigon
8331886 – Wt. 0.4 lb **9⁹⁹**

F) 16.5V AC Power Adapter
8316028 – Wt. 1.2 lb **9⁹⁹**

Hands-Free Kit

- Universal wireless hands-free kit
- Allows you to use your cell phone through your FM car stereo system
- Fits all cell phones

8253213 – Wt. 0.8 lb **6⁹⁹**



Universal DC Adapter

- 6 adapter end and 7 voltage settings

8350688 – Wt. 0.4 lb **9⁹⁹**



EZ Plug Wall Adapter

- Lever easily ejects plug
- Made by Power Sentry

8331829 – Wt. 0.1 lb **3⁹⁹**



3 Outlet Shock-Less Safety Adapter

- Barriers block objects and fingers from entering power adapter
- Made by Power Sentry

8331670 – Wt. 0.2 lb **6⁹⁹**



Mobile Charger

- Charge your portable gaming system anywhere

8334641 – Wt. 0.4 lb **14⁹⁹**

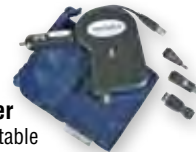

12V / 120V Charging Kit

- Designed for Samsung Z5
- Adapters for 12V cigarette plug or 120V outlet

8290587 – Wt. 0.4 lb **9⁹⁹**



Retractable Charger

- Home and car charger all-in-one
- For PSP, DS Lite, DS, GB Micro and GBA SP

8323354 – Wt. 0.5 lb **14⁹⁹**



Dual Power Port

- Increase your vehicle's power port from 1 to 2 sockets

8323321 – Wt. 0.2 lb **9⁹⁹**



Adapter with Clips

- 120V input, 12V output

8006908 – Wt. 1.3 lb **12⁹⁹**



12V DC Adapter Kit

- 12V DC is converted to 1.5, 3, 4.5, 6, or 9V DC

8334765 – Wt. 0.3 lb **4⁹⁹**



Storage

750J Surge Protector

- Single outlet surge protector with RJ11 protection
- 6 ft RJ11 phone cord
- Made by Philips

8291866 – Wt. 0.4 lb **4⁹⁹**



300J Surge Protector

- 3 outlets
- Made by Power Sentry

8331761 – Wt. 0.2 lb **9⁹⁹**



Ammo Box

- Heavy duty steel army surplus ammo box
- O'all dim.: 11-3/4" x 6-1/4" x 7-1/4"

8023569 – Wt. 6.2 lb **12⁹⁹**

50 Calibre Ammo Box

- All metal construction

3480009 – Wt. 5.3 lb **19⁹⁹**



Media Vault

- Keep your software secure with this media vault

8162745 – Wt. 0.6 lb **4⁹⁹**



Metal Case

- Holds up to 280 CDs or DVDs

8333544 – Wt. 6.5 lb **39⁹⁹**



Camera Accessories



Tripod
8365157 - Wt. 21.0 lb **59⁹⁹**



Camcorder Starter Kit
• 42" aluminum tripod with carrying case and weather-resistant camcorder case
• Made by Targus
8293516 - Wt. 2.2 lb **29⁹⁹**

Digital Camera

- Takes up to 200 pictures
 - 16 MB memory
 - Web cam capabilities
- 8322265 - Wt. 0.4 lb **9⁹⁹**

Camera Patch Cable

- Mini camera to RCA audio video
 - 5 ft long
- 8280703 - Wt. 0.1 lb **2⁹⁹**

Hard Shelled Camera Case

- 5-1/2" x 3-1/2" x 1-3/4"
 - Made by Vivitar
- 8322232 - Wt. 0.2 lb **8⁹⁹**

Camera Strap

- Adjustable 2" x 46" neoprene camera strap
- 8249617 - Wt. 0.2 lb **1⁹⁹**

USB Retractable Adapter Kit

- 8370025 - Wt. 0.2 lb **8⁹⁹**



Camera Starter Kits

- A) 3 pc**
• 5" x 3" x 2" carrying case with shoulder strap, 4-1/2" mini tripod, and a cleaning kit
• Made by Digital Concepts
8290256 - Wt. 0.6 lb **12⁹⁹**
- B) 7 pc**
• Features a camera case, mini tripod, screen protectors, 2 AA batteries, battery charger, and a cleaning kit
• Digital Concepts
8322380 - Wt. 0.7 lb **14⁹⁹**
- C) 9 pc**
• 5" x 3-1/2" x 2" case, 6" tripod, 25-in-1 memory card reader, 4 AA 2,700 mAh rechargeable batteries and charger, memory card wallet, cleaning kit, screen protectors and a neck strap
• Made by Targus
8290132 - Wt. 1.9 lb **19⁹⁹**

3 pk of Scent Storage Bags

- Designed to lock out foreign scents while hunting
 - Resealable and reusable
 - Mossy Oak
- 15" x 18"**
8306581 - Wt. 0.4 lb **6⁹⁹**
- 22" x 24"**
8306573 - Wt. 0.6 lb **8⁹⁹**

Holster

- Multi-purpose holster with belt clip or loop
 - 5-1/2" x 3" x 1"
 - Ideal for cell phones, GPS units, radios, etc.
 - Mossy oak
 - Made by Allen
- 8280182 - Wt. 0.2 lb **8⁹⁹**

Bag

- 10" x 8-1/2" heavy duty plastic bag with hanger and metal snaps
- 8187023 - Wt. 0.1 lb **49^c**

Wallet

- Microfibre boarding wallet made by Buxton
- 8236887 - Wt. 0.1 lb **6⁹⁹**

Switches & Electrical

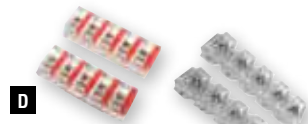

Push-in Connectors
• 22-12 ga
• 24A/600V/1000V
D) Pack of 10
2 conductors
8245805 - Wt. 0.1 lb **1⁹⁹**

E) Pack of 5
8 conductors
8245763 - Wt. 0.7 lb **1⁹⁹**

Terminal Kit
• Large assortment
• Made by Gardner Bender
8293060 - Wt. 0.1 lb **1⁹⁹**

Wire Splicer
For 18 to 10 ga wire copper or aluminum
8246183 - Wt. 0.1 lb **2⁹⁹**



F) AC Power Cord
• 6 ft long
• Replacement cord for electronic devices
8303661 - Wt. 0.2 lb **2⁹⁹**

G) 90° Business Machine Power Cord
8316002 - Wt. 0.4 lb **4⁹⁹**

H) Business Machine Power Cord
8315996 - Wt. 0.4 lb **4⁹⁹**

I) 4 ft Dryer Cord
• 30A
• 10/4 SRDT
8314627 - Wt. 1.7 lb **9⁹⁹**

J) 4 ft 50A Range Cord
8301038 - Wt. 2.6 lb **19⁹⁹**



5 pk 36" Test Leads
5 pk test leads, 36" long
8049417 - Wt. 0.7 lb **17⁹⁹**

100 to 250V AC Voltage Tester
Made by Gardner Bender
8291577 - Wt. 0.1 lb **3⁹⁹**

Assorted Electrical Hardware
8147050 - Wt. 0.1 lb **99^c**

8" Splice Kit
14-8A ga
8254237 - Wt. 0.2 lb **4⁹⁹**

3/8" Heat Shrink
2:1 shrink ratio, pk. of 3
8254211 - Wt. 0.1 lb **99^c**

LED Cell Flash

- Helps to enhance the lighting while taking a picture with your cell phone
- 8369696 - Wt. 0.1 lb **1⁹⁹**

Phone Cord

- 1 ft modular line cord
 - Made by RCA
- 8298267 - Wt. 0.1 lb **99^c**

Switch

- SPDT rocker 125V switch
- 8127862 - Wt. 0.1 lb **2⁹⁹**

Magnetic Flat Bracket

- Includes a 60" 4-wire cable
 - Made by Hoppy
- 8278525 - Wt. 0.4 lb **3⁹⁹**

12V DC Flasher

- Max. 6 lamps
 - Made by CEC
- 8253239 - Wt. 0.1 lb **3⁹⁹**



A) Door Bell
Battery operated
8282162 - Wt. 0.3 lb **2⁹⁹**

B) Door Bell Button
• Wired
• Assorted
8322109 - Wt. 0.1 lb **2⁹⁹**

C) Lighted Push Button
Wired, lighted push button for door bells
8291585 - Wt. 0.1 lb **2⁹⁹**

1 HP 115V Treadmill Motor
• 1,725 RPM
• 1/2" shaft
8300881 - Wt. 13.3 lb **39⁹⁹**

Treadmill Motor Base
8301202 - Wt. 1.3 lb **4⁹⁹**



Wireless Door Alarm
• When magnetic contacts are broken, a loud sound occurs
• 4 digit code is used to arm and disarm alarm
• Equipped with delay entry and door opening chime
• Made by Guard Security
8291643 - Wt. 0.3 lb **12⁹⁹**



D) Electric Motor
• 1/4" threaded shaft
• 1,550 RPM
8318339 - Wt. 2.7 lb **19⁹⁹**

E) 12V DC Motor
8366916 - Wt. 3.8 lb **19⁹⁹**

F) 12V Window Crank Motor
8W)366478 - Wt. 1.9 lb **19⁹⁹**

ENKAY Electrical Tester with Test Leads
• For outlets, switches, fuses, spark plugs, condensers
• Checks current, DC polarity, frequency, poly-phase line
• Measures 110, 220, 360, 480V
0720322 - Wt. 0.1 lb **1⁹⁹**



Electrical Box Plugs
• Originally for plugging holes in electrical boxes
• Many other uses
8194342 - Wt. 0.1 lb **79^c**



1/2" Junction Box
8225427
Wt. 0.3 lb **2⁹⁹**

Electric Motors

G) Toy Motor
1.5V - 12V DC
8343451 - Wt. 0.2 lb **4⁹⁹**

H) 12V DC Johnson Motor
1/8" shaft
8296162 - Wt. 0.4 lb **8⁹⁹**

I) Gear Motor with Drive Wheel
12V DC
8291700 - Wt. 0.9 lb **14⁹⁹**

J) 12V Gear Motor
8365298 - Wt. 0.9 lb **19⁹⁹**

K) Gear Motor
12V DC
8378705 - Wt. 1.7 lb **19⁹⁹**

Fan Motors
Large assortment of 12V DC fan motors
8295552 - Wt. 3.2 lb **29⁹⁹**



Batteries

L) 4 pk of Alkaline AAA Batteries
• Best before Jan 2013
• Made in Canada
• Powerplay brand
8322976 - Wt. 0.1 lb **1⁹⁹**

M) Batteries
4 pk of alkaline AA Rayovac batteries
8275026 - Wt. 0.2 lb **2⁹⁹**

N) Batteries
4 pack "D" Energizer Max batteries
8234205 - Wt. 1.4 lb **6⁹⁹**



2 Hour Battery Charger
• 4 AA batteries, 12V car adapter and 100-240V wall adapter
• Made by Digital Concepts
8331654 - Wt. 0.7 lb **24⁹⁹**



Travel Charger
• Chargers either 2 AA or 2 AAA batteries
• Made by Digital Concepts
8331787 - Wt. 0.2 lb **9⁹⁹**



Lithium Battery Charger
For charging camcorder and digital camera batteries
8349011 - Wt. 1.2 lb **12⁹⁹**

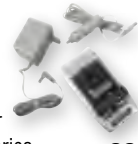

Automotive Litter Chute
8347841 - Wt. 0.4 lb **4⁹⁹**



Radiator Cap
• 16 lb, vented
• Safety lever
8320731 - Wt. 0.2 lb **4⁹⁹**



Assorted 3D Air Fresheners
Assortment of 3D air fresheners
8292120 - Wt. 0.1 lb **99^c**



Sirius FM Extension Cable Kit
8305849 - Wt. 0.1 lb **4⁹⁹**



Battery Terminal
• 24K gold plated battery terminal
• Super high quality build
• Made by Tsunami™
8150237 - Wt. 0.6 lb **4⁹⁹**



5 pk AGU Fuses
• 60A
• Made by Tsunami
8310567 - Wt. 0.1 lb **2⁹⁹**



NEW Metal Gas Tank
4.5 Gallon
8389199 - Wt. 7.8 lb **39⁹⁹**



Carpet Mats
Assorted 4 pk of carpeted floor mats with built-in tite-grip technology
8245672 - Wt. 5.6 lb **19⁹⁹**



84" x 24" RV / Truck Bug Screen
• Helps to protect the front end of your vehicle from bug debris
• Mesh screen with 6 draw strings and 2 "S" hooks
• Made by Victor
8310005 - Wt. 0.4 lb **8⁹⁹**



Trailer Plug
6-way round to 4-way flat
8240947 - Wt. 0.1 lb **3⁹⁹**





License Plate Light
8354599 – Wt. 0.2 lb **3⁹⁹**

License Plate Fastener
Includes 2 screws,
2 bolts and a hex key
8296915 – Wt. 0.1 lb **1⁹⁹**

Gas Tank Strap
60" galvanized
replacement strap
8279861 – Wt. 0.7 lb **4⁹⁹**

**Universal 4" x 6"
Automotive Mirror**
8303380 – Wt. 0.5 lb **9⁹⁹**

3" x 6" Snowmobile Mirror
8303372 – Wt. 1.1 lb **9⁹⁹**

Shock
9-1/2" gas shock
8192536 – Wt. 0.9 lb **7⁹⁹**

Gas Shock
18-1/2" long pin to pin
8345944 – Wt. 0.4 lb **12⁹⁹**

**Assorted
Automotive Wire**
Assorted gauges and lengths
8276149 – Wt. 0.4 lb **2⁹⁹**

**ATV Tire
Repair Kit**
• Includes CO2 inflator, 3 CO2
cartridges, 5 plugs, hole tool, plug
tool, patches, glue and a carrying case
• Allen Company
8318826 – Wt. 1.0 lb **3⁹⁹**

**Tire Pressure
Gauge**
10 to 50 PSI
8335515 – Wt. 0.1 lb **2⁹⁹**

**Chrome Ball
Mount**
• 3-1/4" drop
• 2" rise
• 6,000 lb max. load
• 600 lb max. tongue weight
8338691 – Wt. 6.0 lb **29⁹⁹**

Emergency Air Hose
29 ft emergency tire
to tire air hose
8319097 – Wt. 0.9 lb **12⁹⁹**

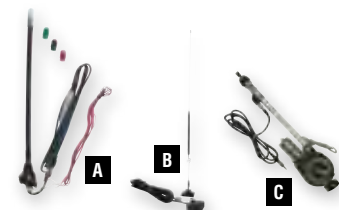

**A) Light Up Automotive
Antenna**
8337966 – Wt. 0.6 lb **4⁹⁹**

B) Antenna
Universal thru-glass mount
23" cellular style CB antenna
made by Rally
8170631 – Wt. 0.8 lb **14⁹⁹**

C) 12V DC Antenna Motor
8312472 – Wt. 2.6 lb **19⁹⁹**

10" x 6" Trailer Rim
• 4 bolt
• White
8223646 – Wt. 8.3 lb **19⁹⁹**

1/2" Hitch Pin
• Made by Bully truck accessories
• Tip rotates for easy use
8037061 – Wt. 0.4 lb **3⁹⁹**

Axle Stud
4" x 1/2" axle stud with threads
and a hole for a cotter pin
8111122 – Wt. 0.2 lb **1⁹⁹**

6 ft Cable and Lock
• Vinyl coated cable
• Heavy duty lock
8327033 – Wt. 1.1 lb **8⁹⁹**

Motorcycle Club
• Adjustable tempered
steel motorcycle club
• Extends from 8-1/2" to 11-1/2"
• Fits most motorcycles,
scooters and mopeds
8245680 – Wt. 3.7 lb **19⁹⁹**

Reading Light
Features 2 LED light,
flexible neck and a clip
8320053 – Wt. 0.1 lb **4⁹⁹**



D) Light
12V green 2" beehive light
8242083 – Wt. 0.1 lb **1⁴⁹**

E) 2 pk 9004 Halogen Bulbs
Philips
8337693 – Wt. 0.2 lb **12⁹⁹**

F) LED Driving Lights
• 2 driving lamps, wiring harness,
switch and mounting hardware
• Made by Optronics
8305427 – Wt. 0.4 lb **19⁹⁹**

G) Glo-Fx Driving Lights
• Features cool after glow
when lights are off
• Includes all wiring, switch and
mounting hardware
• Easy to install
• 12V DC
8006386 – Wt. 1.6 lb **19⁹⁹**

Mounting Brackets
• Brackets and hardware
for 2 driving/fog lamps
• Made by Rally
8298192 – Wt. 0.2 lb **1⁹⁹**

2 pk Exhaust Pipes
• Chrome finish with an
adhesive backing for easy mounting
• Burnt tip look
8128894 – Wt. 0.3 lb **2⁹⁹**

Window Locks
K) 8240293 – 2 pk slide locks
L) 8204828 – White
Wt. 0.1 lb **1⁹⁹** /ea

13" Fluorescent Light
• Features a thin design, extra outlet
and bulb
• Made by GE
8271900 – Wt. 1.7 lb **19⁹⁹**

Locks & Lights

Chain Bolt
• 6" chain bolt with
a 24" pull chain
• Zinc
8291635 – Wt. 0.8 lb **4⁹⁹**

**Door Lock
Installation Kit**
Adjustable jig fits:
1-1/4" to 1-3/4" door widths
and 2-3/8" to 2-3/4" backsets
Carbon steel
8360976 – Wt. 0.7 lb **19⁹⁹**
Bi-metal
8360919 – Wt. 0.9 lb **29⁹⁹**

Luxie Light
• Battery powered glow stick
• Assorted colours
8313595 – Wt. 0.1 lb **3⁹⁹**

Locks
H) Quarter turn lock
8145690 – Wt. 0.1 lb **49[¢]**

I) Cam Lock with Keys
3/8" bore
8193534 – Wt. 0.1 lb **1⁹⁹**

J) Cabinet Lock
8247892 – Wt. 0.1 lb **1⁹⁹**

Light
5-1/2" push light
with sound control
8282840 – Wt. 0.2 lb **1⁹⁹**

Combo Light / Fan

- Compact battery operated fan/flashlight
- Requires 4 AAA batteries (not included)

8253031 – Wt. 0.2 lb. **1.49**



Lamp Dimmer

- 120V manual lamp dimmer
- Simply screw into lamp

8296436 – Wt. 0.1 lb. **4.99**



Keychain

Super cyber LED flash light with keychain
8298341 – Wt. 0.1 lb. **1.99**



LED Headlamp

8369605 – Wt. 0.2 lb. **6.99**



Flashlight

- 2 LED self adhesive flashlight
- Can be easily attached to cell phones and more

8205601 – Wt. 0.1 lb. **1.99**



Wheels & Casters

4.10/3.50-4 Wheel Assembly

- 400 lb max. load
- 4 ply

8368185 – Wt. 2.9 lb. **8.99**



3" Swivel Caster with Brake

8343485 – Wt. 1.1 lb. **8.99**



6" x 2" Wheel

1/2" bore
8354292 – Wt. 0.9 lb. **4.99**



6" x 2" Caster

Rigid plate mount caster with suspension spring
8302622 – Wt. 9.4 lb. **24.99**



Plastic Wheels

7" dia., 5/16" bore
8325979 – Wt. 0.4 lb. **1.99**



8" dia., 5/16" bore
8326753 – Wt. 0.5 lb. **1.99**

Tools & Accessories

Camo Hunting Pants

- 100% cotton
- Assorted sizes to choose from

8305559 – Wt. 1.1 lb. **19.99**



Dus-T Shirt

- Built-in dust mask rolls away when not in use
- Assorted colours and sizes, short sleeve

8349870 – Wt. 0.6 lb. **7.99**



Sun Shades

8352304 – Wt. 0.2 lb. **2.99**



A) Assorted Sunglasses

Large assortment of sunglasses
8287872 – Wt. 0.2 lb. **1.99**

B) Safety Glasses

8350134 – Wt. 0.1 lb. **3.99**

C) Safety Glasses

8349045 – Wt. 0.1 lb. **3.99**



D) Camo Gloves

8362899 – Wt. 0.2 lb. **2.99**

E) Neoprene / Latex Chemical Resistant Gloves

8301681 – Wt. 0.3 lb. **3.99**

F) Gloves

• Rubber chemical gloves with liner

• Assorted sizes
8282832 – Wt. 0.8 lb. **3.99**

G) Industrial Gloves

8250193 – Wt. 0.5 lb. **4.99**

7" Awl

8348245 – Wt. 0.2 lb. **1.99**



Buffing Wheel

Sisal, 6" dia.
8212771 – Wt. 0.3 lb. **3.99**



12" Bow Saw Blade

For pruning and rough cutting of wet or green wood
8333098 – Wt. 0.1 lb. **2.99**



6" Ruler

Stainless steel metric / SAE ruler
8169930 – Wt. 0.1 lb. **2.49**

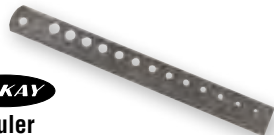

Ruler

39" foldable plastic ruler
8253049 – Wt. 0.1 lb. **99¢**

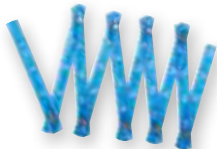

30" Threaded Handle

Standard threads fit paint rollers, window squeegees, etc.
8201022 – Wt. 0.5 lb. **2.99**



Baseball Hat

Assorted colours
8357352 – Wt. 0.2 lb. **1.99**



Magnetic Screwdrivers

H) #0 Phillips
8348401 – Wt. 0.1 lb. **2.69**

I) 1/4" Slotted
8349466 – Wt. 0.2 lb. **2.99**

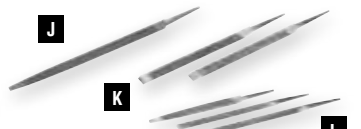

J) Assorted Large Files

8345977 – Wt. 0.1 lb. **6.99**

K) Assorted 2 pk 6" Files

8349680 – Wt. 0.3 lb. **6.99**

L) 3 pk of Small Files

8345985 – Wt. 0.2 lb. **8.99**

SURPLUS

Duct Tape

- Large rolls of assorted 3" duct tape
- For sealing air ducts, patching jobs or wherever strong tape is required

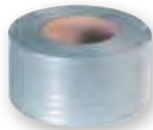

5330082 – Wt. 1.0 lb **14⁹⁹**

Plastic Tray

16" x 10" x 3/4"
8358137 – Wt. 1.0 lb..... **4⁹⁹**

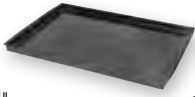

Rubber Waffle Mat

19-1/2" wide x 36" long
8365819 – Wt. 6.4 lb..... **19⁹⁹**

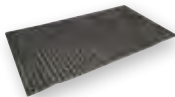

Hot Pad

- Silicone heat resistant pad
- Protects counter tops from hot pot or pans



8306565 – Wt. 0.2 lb **1⁹⁹**

Wood Stove Brick

14-1/4" x 9" x 3/4"
8344889 – Wt. 5.9 lb..... **4⁹⁹**



Grill Thermometer

Clip on design
8342404 – Wt. 0.1 lb..... **99¢**



Assorted 3D Metasaurs Puzzles

8341968 – Wt. 1.2 lb..... **6⁹⁹**



1.75 oz Foam Glove Conditioner

8313280 – Wt. 0.2 lb **1⁹⁹**



Air Regulator

3/8" NPT
8308819 – Wt. 0.4 lb **6⁹⁹**



Tree Ring Soaker Hose

- Slow releasing soaker for 1" to 3" trunk diameters
- Made by Nelson

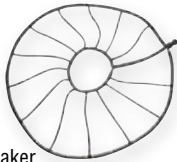

8282857 – Wt. 2.2 lb..... **9⁹⁹**

Anchor Set

Holds down swing set
8346983 – Wt. 3.7 lb..... **4⁹⁹**

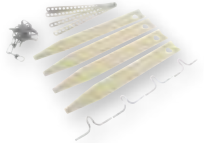

Marker Panel

- Army surplus quality signalling canvas
- Orange on one side, pink on the other
- O'all dim.: 24" x 70"



8247629 – Wt. 0.8 lb **3⁹⁹**

Thermostats

- A) Baseboard Thermostat
8366379 – Wt. 0.7 lb..... **9⁹⁹**
- B) Heating and Cooling Thermostat
8366387 – Wt. 0.5 lb..... **9⁹⁹**



Compass

Pin on style
8196644 – Wt. 0.1 lb **1⁹⁹**



Minnow Net

8341257 – Wt. 0.1 lb..... **99¢**



Water Bottle Holder

- 1.5 litre
- Insulated



3 in 1 Detailing Tool

Includes detailing brush, vent cleaner and a crevice tip
8395840 – Wt. 0.1 lb..... **1⁹⁹**



6 ft Washer Hose Kit

Includes two 6 ft hoses, 4 washers and reminder tag
8364176 – Wt. 2.0 lb..... **9⁹⁹**



Chainsaw Chains

- 16"
8274979 – Wt. 0.4 lb **14⁹⁹**
- 18"
8274961 – Wt. 0.4 lb **16⁹⁹**

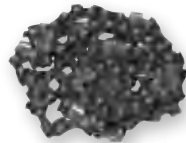

Chainsaw Bars

- 16"
8274987 – Wt. 1.1 lb **19⁹⁹**
- 18"
8126112 – Wt. 1.4 lb..... **22⁹⁹**



Assorted 7" NASCAR Figurines

8327975 – Wt. 0.5 lb **8⁹⁹**



Luggage Locator

Locate luggage with the push of a button up to 60 ft away
8322273 – Wt. 0.3 lb **9⁹⁹**



Switch Plate with Digital Messaging

Flip switch and your message plays back
8299588 – Wt. 0.5 lb **6⁹⁹**

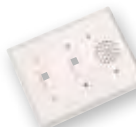

Horse Wall Clock with Bonus Watch

8395899 – Wt. 1.6 lb..... **14⁹⁹**



NEW

Weed Eater Engine

Briggs & Stratton 4 Stroke
8389207 – Wt. 10.6 lb **49⁹⁹**



NEW

Ladder Maxx Basket

8386666 – Wt. 4.7 lb..... **9⁹⁹**

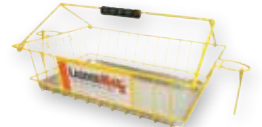

Techno Trap Starter Kit

- Squirter, remote, receiver and mounting system
- For people who love to play practical jokes



8353104 – Wt. 0.7 lb..... **12⁹⁹**

Assorted Techno Trap Accessories

- Works with starter kit
- Choose from bug drop, water balloon drop or sound F/X



Tempered Glass

- 1,400°F rating
- 9" x 12-1/2"
8317307 – Wt. 1.9 lb
- 8-3/4" x 15"
8317224 – Wt. 2.3 lb **4⁹⁹ /ea**



Can Crusher & Bottle Opener

- Built-in bottle opener
- For use with recycling programs or for just saving space in the trash
- Heavy duty design



Smart Nozzle Scrub Brush

Features 180° rotating design and a detachable spray nozzle
8326506 – Wt. 1.3 lb **12⁹⁹**



Door Closer Kit

- 2 cylinders, mounting hardware, door knob
 - Air cushioned
- 8324923 - Wt. 3.6 lb **19⁹⁹**

EZ Exit Push Bar

- For use on either 32" or 36" doors
- 8324162 - Wt. 0.6 lb **6⁹⁹**

Magnetic Cabinet Door Catches

- 8260069 - Wt. 0.1 lb **99¢**

Weather Seal

- Designed for A/C units
 - 2-1/4" x 2-1/4" x 42"
- 8237539 - Wt. 0.1 lb **6⁹⁹**

Window Channel Insulators

- Simply snap strips into window channels to hold vinyl sheet without using tacks
 - Reusable and paintable
 - 7 pieces, 26" long
- 8243727 - Wt. 0.3 lb **2⁹⁹**

Assorted Robe Hooks

- 8357311 - Wt. 0.4 lb **6⁹⁹**

2" Cardboard Stencils

- Letters, numbers and symbols
- 8354698 - Wt. 0.1 lb **2⁹⁹**

6 ft Thera-Band Rubber Tubing

- Great for strengthening muscles
- 8258667 - Wt. 0.2 lb **4⁹⁹**

2 pk 3/4" Dual Pulleys

- 8366957 - Wt. 0.2 lb **1⁹⁹**

Quick Link

- 5/16" triangle shaped quick link
- 8247512 - Wt. 0.2 lb **99¢**

Bumper

- Wall mounted door bumper
 - Helps save walls from doorknob dents
- 8220246 - Wt. 0.2 lb **99¢**

Projection Door Stop

- Chrome finish
 - Made by Shepherd
- 8284911 - Wt. 0.2 lb **1⁹⁹**

Door Stop

- Door mounted, foldable door stop
- 8218612 - Wt. 0.5 lb **2⁹⁹**

Storm Door Insulation Kit

- 36" x 84" sheet of vinyl sheeting with tacks
 - Ideal for insulating windows and doors
- 8243743 - Wt. 0.3 lb **2⁹⁹**

4 Pack Anti Skid Caster Cups

- Solid hardwood
- 8315772 - Wt. 0.2 lb **2⁹⁹**

19" Metal Rod

- 8255515 - Wt. 0.5 lb **1⁹⁹**

5/16" x 21" Aluminum Bar

- 8295628 - Wt. 0.2 lb **2⁹⁹**

Hinge

- Heavy duty steel hinge
- 8188732 - Wt. 1.4 lb **2⁹⁹**

Strap

- 1" x 36" nylon strap with buckle
- 8278053 - Wt. 0.1 lb **1⁹⁹**

Strap Hook

- Flat snap hook
- 8143125 - Wt. 0.3 lb **3⁹⁹**

D) 5" Spring D Handle

- 8347056 - Wt. 0.5 lb **3⁹⁹**

E) 5" Hinged Handle

- Ideal for tool boxes, chests, etc
- 8307258 - Wt. 0.5 lb **3⁹⁹**

Hardware

Rivets

- 1/8" dia
 - 100 pcs
- 8301996 - Wt. 0.3 lb **3⁹⁹**

Galvanized Tie Wire

- 50 ft roll
- 8334245 - Wt. 0.1 lb **1⁴⁹**

4 Pack Furniture Glides

- 1-1/4"
- 8234577 - Wt. 0.1 lb **49¢**

Self Leveling Table Glides

- 1" dia, 17 pc kit
- 8228314 - Wt. 0.3 lb **2⁹⁹**

4 Pack Wobble Stoppers

- Wedge style helps to even out uneven legs on furniture
- 8234551 - Wt. 0.1 lb **49¢**

2" Letters

- 8354664 - Wt. 0.1 lb **3⁹⁹**

12 Pack Outlet Covers

- Helps prevent children from putting their fingers into outlets
- 8234536 - Wt. 0.1 lb **49¢**

Assorted Snap Hooks

- 8270886 - Wt. 0.1 lb **1⁹⁹**

Heat Element

- 120V, 140W
- 8292021 - Wt. 0.1 lb **3⁹⁹**

Grip

- 2-1/2" x 2" foam barbell grip
- 8126336 - Wt. 0.1 lb **99¢**

Foam

- 4" x 2-1/2" piece of foam
- 8147167 - Wt. 0.1 lb **49¢**

Packaged Hardware

- Assorted
- 8148314 - Wt. 0.1 lb **99¢**

Staples

- 40 pk of 1/8" fibre insulated staples
- 8245813 - Wt. 0.1 lb **1⁹⁹**

Staples

- #2 wire staples
 - Pack of 5
- 8246175 - Wt. 0.1 lb **1⁹⁹**

20 Pack Nail-In Cable Clips

- Secure your cable to the floor or wall for a safe, clean look
 - Philips
- 8315038 - Wt. 0.1 lb **99¢**

A) Rope Clamps

- Rope clamps, 2 pk
- 8003179 - Wt. 0.1 lb **49¢**

B) Rope Clamp Set

- 1/4" to 3/8" thimble and rope clamp set
- 8004042 - Wt. 0.1 lb **79¢**

C) Cable Clamps

- Assorted sizes of insulated cable clamps
- 8177610 - Wt. 0.1 lb **1⁹⁹**

F) Animal Keychain

- Assorted metal animal keychains such as deer, bears & fish
- 8088130 - Wt. 0.1 lb **99¢**

G) Keychain

- Split ring keychain with a metal belt hook
- 8043978 - Wt. 0.1 lb **1⁹⁹**

H) Keychain Flashlight

- Super bright LED
- 8331175 - Wt. 0.1 lb **3⁹⁹**

Chainsaw Parts 288
 Chainsaw Sharpeners 158
 Chainsaws 197
 Chain Slings 105
 Chalk Line 206
 Channel Aluminum 130
 Channel Steel 130
 Chargers 111, 112, 283, 285
 Check Valves 16, 17, 135, 259, 262
 Chemicals 21, 125, 128
 Chipper / Shredders 51
 Chipping Hammers 173
 Chisel Changers 143
 Chisels 143, 144, 195, 196
 Chocks 59, 70, 107
 Chop Saws 151
 Chucks 164
 Circle Cutting Guides 171
 Circuit Breakers 86
 Circuit Panels 86
 Circuit Testers 81, 228, 229
 Circular Saws 160
 Clamps 15, 51, 112, 136, 201, 202, 246, 262
 Claw Hammers 193
 Clay Picks 193
 Cleaning Brushes 222
 Cleaning Chemicals 126
 Clearance Lights 81, 82
 Cleats 9
 Clevis Ends 245
 Clevises 45, 266, 276
 Clevis Pins 45
 Clip Removals 237
 Clips 47
 Clocks 288
 Cloths 129
 Club Hammers 193
 Clutches 274, 275
 Clutch Spring Compressors 232
 Clutch Tools 232
 Coaxial Cables 281
 Code Readers 226
 Coil Spring Compressors 233
 Cold Chisels 195, 196
 Cold Weld 127
 Collars 276
 Collets 161
 Combination Squares 206
 Combination Wrenches 190, 191
 Compasses 288
 Compression Fittings 135
 Compression Testers 228
 Compressors 131, 132
 Air 131, 132
 Oil 132
 Pumps 132
 Computer Accessories 281
 Connectors 16, 45, 76, 78, 135, 279, 284
 Construction Heaters 6
 Construction Line 206
 Contact Tips 168
 Continuity Testers 219, 228
 Contour Gauges 208
 Control Cables 258, 277
 Control Valves 257, 258, 265, 266
 Convection Heaters 6
 Coolant 128, 164
 Coolant Testers 229
 Coping Saws 224
 Cord Connectors 112
 Cordless Drills 153
 Cord Adapters 169
 Cord Locks 112
 Cord Reels 113, 115
 Cords 49, 57, 112, 113
 Corn Brooms 38
 Corner Dollies 109
 Corner Trowels 224
 Cotter Pins 45
 Cotton Gloves 12
 Counter Balance Valves 259
 Counter Brushes 38
 Counters 279
 Countersink Bits 156
 Couplers 18, 22, 74, 134, 135, 136, 249, 250, 251, 253, 267, 276
 Coupler Plugs 17
 Couplings 16
 Coveralls 9
 Covers 49, 58, 59, 95, 114
 Cowbells 34
 Cranes 90, 104, 107
 Creepers 107, 108
 Crimpers 36, 221
 Crisscross Gloves 12
 Cross Over Relief Valves 259
 Crosspein Hammers 193
 Cross Slide Vises 117
 Cross Wrenches 69
 Crow Bars 194
 Crushed Glass 139
 Cup Brushes 157
 Cut-Off Saws 143, 151
 Cut Out Wire 237
 Cutting
 Blades 150, 151, 160
 Guides 160
 Kits 154, 161, 171, 178
 Oil 164
 Pliers 202, 203
 Tips 172
 Tools 198
 Wheels 150, 151, 163, 223
 CV Boot Banders 231
 CV Boot Clamp Pliers 231, 236
 Cylinder
 Accessories 245
 Breathers 245
 Hones 232, 236
 Pins 246
 Cylinders 242, 243, 244, 245, 264, 265, 267

D

Dead Blow Hammers 193
 Deadman Valves 138, 139
 Deburring Tools 221, 223
 Deck Hooks 58
 Deflection Gauges 208
 Degreaser 20, 128
 Dehumidifiers 7
 De-Icers 7
 Dental Picks 209, 287
 Dent Pullers 239
 Dent Repair 239
 Deodorizers 128
 Desiccant Dryers 134
 Detent Kits 257, 258
 Detergent 20
 Diagnostic Tools 226
 Diagonal Cutting Pliers 202, 203
 Diamond Blades 160
 Diamond Files 197
 Diamond Hones 197
 Die Grinders 143, 161
 Dies 212, 213, 214
 Diesel Cans 27
 Diesel Engines 268
 Diesel Oil 125
 Diesel Pumps 24
 Diesel Heaters 6
 Dippers 41
 Directional Control
 Valves 257, 258
 Dirt Bike Carriers 90
 Disc Brake Calipers 231
 Disc Brake Tools 231
 Disc Grinders 142, 151
 Disconnect Tools 229

E

Ear Plugs 121
 Electrical 219
 Electrical Cords 112, 113, 114
 Electrical Tape 114, 126
 Electrical Testers 114, 285
 Electric Brakes 65
 Electric Drills 153

Electric Fence Insulators 35
 Electric Fencing 34, 35, 36
 Electric Heaters 6
 Electrician's Tools 220
 Electric Motor Accessories 279
 Electric Motors 277, 285
 Electric Pressure Washers 20
 Electric Shears 152
 Electrode Holders 173
 Electrodes 169, 170
 Elements 3
 Emergency Hammers 210
 Emergency Kits 123
 Emergency Pumps 12
 Emergency Shovels 8
 Emergency Switches 278
 Emergency Warning Triangles 87
 Emery Cloth 240
 Enamel 126
 End Nippers 202
 Engine Brackets 255
 Engine Covers 148
 Engine Dollies 105
 Engine Levels 104
 Engine Mufflers 269, 270
 Engines 268, 270, 288
 Engine Stands 104
 Engine Support Bars 104
 English Wheels 117
 Engravers 209
 Epoxy 127
 E-Torx Bits 188
 E-Tracking 97
 Exhaust Fans 31
 Exhaust Pipe Clamps 51
 Exhaust Pipes 286
 Exhaust Tools 232
 Extension Bars 145, 146, 156, 182, 183
 Extension Cords 49, 57, 112, 113, 169
 Eyebolts 44
 Eye Hooks 45
 Eyellets 39, 210

F

Face Shields 120
 Fan Blades 30
 Fan Motors 285
 Fans 6, 30, 31
 Farm Jacks 103, 104
 Fasteners 214
 Faucets 18
 Feed Dishes 41
 Feeler Gauges 228
 Felt Bobs 162
 Fence Cables 35
 Fence Energizers 34
 Fence Stretchers/Spaces 36
 Fence Testers 36
 Fence Tools 202
 Fence Wire 35
 Fencing Accessories 36
 Fencing Tools 203
 Fenders 65
 Fiberglass Filler 238, 239
 Fiberglass Resin 238, 239
 Fifth Wheel Hitches 73
 File Brushes 198
 File Holders 238
 Files 197, 198, 287
 Film 225
 Filter Elements 264
 Filter Heads 263
 Filters 3, 19, 26, 133, 134, 269
 Filter Tools 230
 Filter Wrenches 230
 Fingertip Ratchets 179, 180
 Fireplace Tongs 57

Fish Tape 219
 Fittings 16, 17, 18, 23, 29, 134, 249, 250, 252, 267
 Flag Connectors 79
 Flagging Tape 121
 Flange Bearings 64, 275
 Flange Mounts 83, 274
 Flare-Nut Wrenches 191
 Flare Tools 222
 Flashback Arrestors 171
 Flashlights 32, 287, 289
 Flat Bars 53, 130
 Flat-Free Wheels 67
 Flat Switches 14
 Fleece Gloves 11
 Fleece Liners 10
 Flex Couplers 276
 Flex-Head Ratchets 179
 Flint Lighters 173
 Flints 173
 Flip Sockets 145, 146
 Float Bowls 34
 Flood Lights 31, 85
 Flooring Cleats 147
 Flooring Knives 198
 Flooring Staples 147
 Floor Jacks 102, 103
 Floor Mats 285
 Floor Scrapers 223
 Floor Squeegees 38
 Floor Sweepers 210
 Flow Controls 260
 Flow Meters 169
 Fluid Conditioning 263
 Fluid Evacuators 124
 Fluid Extractors 124
 Fluid Filters 264
 Fluid Pumps 24
 Flux Paste 177
 Fog Lights 85
 Food Processing 60
 Forced Air Heaters 5
 Forks 37
 Framing Nailers 147
 Framing Nails 147
 Framing Squares 206
 Freezer Jackets 9
 French Fry Cutters 60
 Frying Pans 57
 Fuel 178
 Fuel Conditioners 128
 Fuel Containers 27
 Fuel Filters 26
 Fuel Hose 27
 Fuel Level Gauges 89
 Fuel Line 89
 Fuel Line Disconnectors 229
 Fuel Meters 26
 Fuel Nozzles 27
 Fuel Pressure Testers 228, 229
 Fuel Pumps 24, 25
 Fuel Stabilizer 128
 Fuel Tank Repair Kits 129
 Funnels 41, 124
 Furnace Fan Motors 277
 Furniture Movers 109
 Fuse Holders 86
 Fuse Panels 86
 Fuse Pullers 86
 Fuses 86, 285
 Fuse Testers 86, 229

G

Gambrel Hoists 60
 Game Hoists 60
 Gantry Cranes 107
 Garage Jacks 102, 103
 Garbage Bags 19, 285
 Garbage Cans 38
 Garden Bags 19

Store Locations

For store location maps and hours of operation, or to order online, please visit: www.princessauto.com

British Columbia

Coquitlam

15 King Edward St., V3K 4S8
Toll Free: 1-866-725-0023
Tel.: (604) 777-0735

*Construction detours throughout 2011
See www.princessauto.com for details

Kamloops

Unit 1C-2121 East Trans Canada Hwy, V2C 4A6
Toll Free: 1-877-725-1034
Tel.: (250) 372-1942

Kelowna

1920 Spall Rd., V1Y 4R1
Toll Free: 1-866-725-1008
Tel.: (250) 860-6191

Langley

19878 Langley Bypass
(in Langley Square), V3A 4Y1
Toll Free: 1-866-725-0019
Tel.: (604) 534-9554

Prince George

3330 Massey Drive,
Massey Centre, V2N 4C1
Toll Free: 1-866-725-4124
Tel.: (250) 563-3113

COMING SOON!

Victoria

1037 Langford Parkway, V9B 0A5

Alberta

Calgary North

2850 Hopewell Pl. NE, T1Y 7J7
Toll Free: 1-888-725-1004
Tel.: (403) 250-1133

Calgary South

4143 114 Ave. SE, T2Z 0H3
Toll Free: 1-888-725-0031
Tel.: (403) 723-9904

Edmonton West

11150 163 St. NW, T5M 3R5
Toll Free: 1-866-725-1005
Tel.: (780) 483-0244

CAN'T MAKE IT IN?

Call our National Call Centre in Winnipeg Toll Free: 1-800-665-8685. Fax completed orders Toll Free: 1-800-265-4212

- Items above 30 kg / 66 lb subject to additional charge. Extra charges may apply for freight shipments. Air stage customers please call for a special quote. Due to changing market conditions beyond our control, prices are subject to change without notice.
- All prices are in Canadian Funds.
- The National Call Centre in Winnipeg does not accept cheques, money orders, or COD as a method of payment.
- US orders call toll free: 1-800-665-8685.
- Not all products are available at all locations.

Qty	Item # (7 digits)	Page #	Description	Weight	Price (ea.)	TOTAL
SUB TOTAL						
SHIPPING						
HANDLING						6 00
SUB TOTAL						
PST						
GST						
HST						
GRAND TOTAL						

METHOD OF PAYMENT**

VISA M/C AMEX

--	--	--	--	--	--	--	--	--	--	--	--	--	--	--	--	--	--	--	--	--

Expiration: MM / YY			

Name as it appears on card

65¢ per pound*

PST, if applicable: SK 5%, MB 7%
Add 5% GST for: AB, SK, MB, QC, PE, NT, NU, YT

Add HST for: BC 12%, ON 13%, NL 13%, NS 15%, NB 13%

PLEASE PRINT CLEARLY

Company Name (if applicable)

Email Address

Surname

First Initial

Street Address

R.R. or Box #

Telephone Number

City/Town

Province

Postal Code

ERICKSON

MANUFACTURING LTD.

www.ericksonmfg.com

**Tie it.
Tow it.
Load it.**

Proud Canadian Supplier





2011

Over the years, our look has progressed with the times and with our growth in the Canadian marketplace.

This new logo marks a change in appearance and represents a continued commitment to meet the high expectations of today's guests.

As always, experience our Royal Service and wide assortment of equipment, tools and more.

www.princessauto.com



1933 2011

